

BYTE

the small systems
journal



THERE IS NO QUESTION

Our computer is a bore—

There is simply no point in trying to hide it, everyone is going to find out sooner or later anyway. The Southwest Technical Products 6800 computer is a big bore. Discussions with customers and dealers have confirmed our worse suspicions.

At first people thought that perhaps owners of our system were just a bit shy because they were outnumbered at local computer club meetings. But then as the number of owners rose it became clear that this was not the problem. And it wasn't that they were unsociable or anything like that; they were simply just bored because they had nothing to talk about.

Here they were, just sitting there while all the other members with other brands of computers exchanged data on circuit board errors, secret schemes of adding extra bypass capacitors to make the thing reliable, tricks to keep the clock phases from overlapping, corrections to manual errors and other fun subjects. Can you imagine the frustration this caused? All our customers could do was to sit and be bored. They had nothing to talk about.

Our 6800 has an internal monitor ROM that automatically puts the bootstrap loader in memory and refers control to the terminal, when you power up. This feature deprives you of the chance to tell sad stories of how many

times you had to go back and flip the console switches before you got the loader program in right. Since you can do machine language programs directly from your video terminal or teletype in hexadecimal form, you will not have a chance to exchange horror stories with your friends about how you forgot the last zero when you entered 10100110 from the console on your 374th Byte and messed up the program that had just taken you two hours to put into memory. It just isn't fair.

Since we use full buffering on all data, address and control lines on all boards in our system and since we use low power 2102 static memories in our system, there are no noise sensitivity problems that can lead to hours of fun trying to figure out why a program "bombed". Dynamic memories that some others use can drop bits, fail to refresh random cells, cause programs to do crazy things by going into a refresh cycle at the wrong moment and all kinds of interesting things. Our poor customers will never have a chance to have these interesting experiences.

Even our documentation and software is no help. Not only do we have the most complete and thorough set of instructions available for any system, we are supplying software either free, or at crazy low prices. Our big documentation notebook for instance

is just full of information on the system. There are complete sections on software with sample programs and information on programming. We have no assembly instructions in that big yellow notebook. They are packed with the kits themselves. The notebook is completely devoted to instruction on using your computer system. You are therefore not going to be spending day after jolly day trying to find out how to put a program into your machine; researching all available outside literature in an attempt to discover just how you write software for the beast. Sorry about that folks, we didn't mean to spoil all your fun.

So please, have a heart, when you see those poor lonely souls that have purchased our systems say "hello". All they have to keep them interested in computers is writing and running programs. Our editor, assembler, 4K and 8K BASIC programs work so well that even this is quick and easy. So be kind to those poor bored SwTPC-6800 owners, it's not their fault that they have nothing to talk about.

SWTP 6800
Computer System

with serial interface and 2,048 words of memory. \$395.00



- I don't like puzzles anyway and have no free time to be bored so send information on your 6800 computer system and peripherals.
- Thanks for warning me. Send names of manufacturers of "interesting" computers.

NAME _____

ADDRESS _____

CITY _____ STATE _____ ZIP _____

Southwest Technical Products Corp., Box 32040, San Antonio, Texas 78284

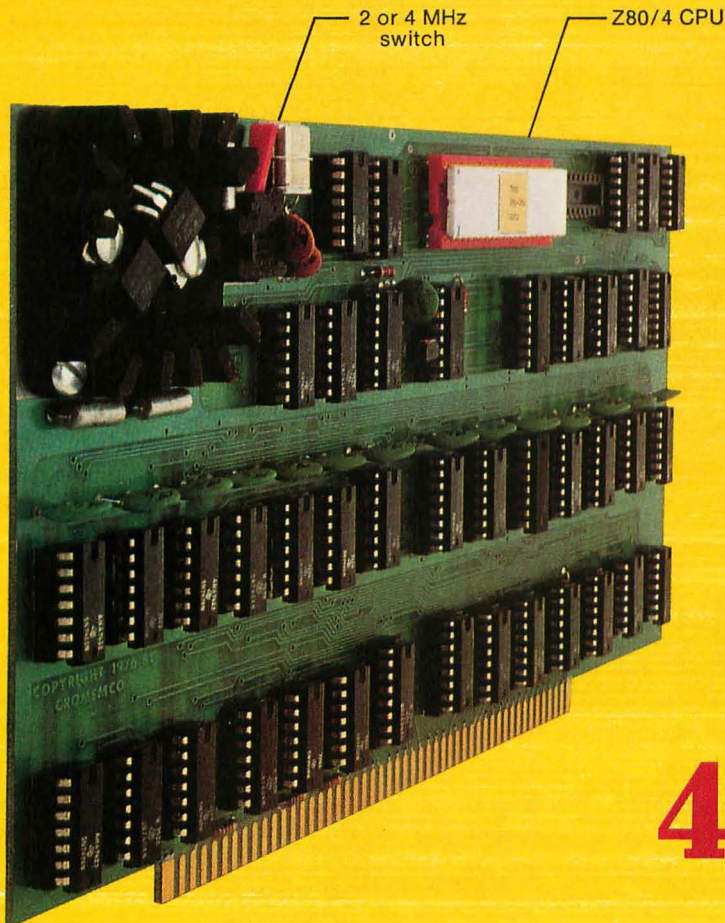

The only CPU card to give you 4 MHz speed

2 - 5X MORE THROUGHPUT

Here is by far the most powerful CPU card now available.

It's Cromemco's new ZPU™ card. It uses the slick new Z-80 chip — in fact, it uses the even faster Z80/4 high speed version of the Z-80 — and it's the *only* card that does. The Z80/4 is **certified** by its manufacturer for 4 MHz operation.

The Z80/4 has all the advantages of the 8080 and 6800 — and enormously more.

And Cromemco's new ZPU **does** enormously more.

4 MHz CLOCK RATE

First, the ZPU lets you choose either a 2 or 4 MHz crystal-controlled clock rate. Right away that means you can have twice the throughput. Cuts program running time in half. Then the instruction set of the Z80/4 reduces software even more.

The 2 or 4 MHz clock rate is switch-selectable as shown in the above photo.

POWER-ON MEMORY JUMPS

Cromemco's ZPU also has some neat design innovations of its own.

For example, you'll like the simplified operation you get because upon power turn-on the ZPU will jump to any desired 4K boundary in memory. No switch flipping to go through to begin your program.

SELECTABLE WAIT STATES

Cromemco engineers have also arranged that your present systems will always be useful with the new ZPU. To do this, the ZPU has been designed to have jumper-wire-selectable wait states on the card.

These simplify interfacing with your present memory or I/O even at 4 MHz operation.

80 ADDITIONAL INSTRUCTIONS

You've probably heard that the Z-80 with its 80 new additional instructions is by far the most powerful chip around. It's true.

That means with the ZPU you will be able to devise much more powerful (as well as faster) software than before.

ALTAIR/IMSAI COMPATIBLE WITHOUT MODIFICATION

Yes, the new ZPU is plug-com-

patible with the Altair 8800 and IMSAI 8080. Just remove the existing CPU, plug in the ZPU card, and you're up and running.

Further, the Cromemco ZPU is the only card guaranteed to work with all present and future Cromemco peripherals. (Cromemco manufactures the popular BYTESAVER™ memory, the TV DAZZLER™, the D+7A™ analog interface board, a joystick console, and others.

INCLUDES FREE SOFTWARE

The ZPU comes with our powerful Z-80 monitor, complete documentation, source code, and paper tape object code. The monitor is also available in PROM (\$75) for use in our BYTESAVER memory board.

STORE/MAIL

The new ZPU is available as a kit or assembled. Look into it now because you can see demand will be strong. Present delivery is 30 days.
ZPU kit (Model ZPU-K) \$295
ZPU assembled
(Model ZPU-W) \$395

California users add 6% sales tax.



Cromemco

Specialists in computer peripherals

2432 Charleston Rd., Mountain View, CA 94043 • (415) 964-7400

About the Cover

As a way to highlight the history of electronic digital signalling, we dug up a picture of one of Joseph Henry's original telegraphy keys, circa the early 1800s. Robert Tinney then placed the key in the frame and wall setting you see on the cover, using a photo supplied by Brian McCarthy.

In the Queue is on page 7 this month.

Once you sit down and **Build This Mathematical Function Unit** as described in part one of R Scott Guthrie's two part article, the world of high level mathematical functions is opened to your microcomputer. In part two this month, the software needed to interface with the calculator is described, as well as several test loops used to adjust timing parameters with an oscilloscope. As a final illustration of the calculator's use, the author provides a program called CALCULA which enables a Teletype (or other ASCII) port to drive the calculator and print results, simulating the ordinary hand calculator level of operation.

In This BYTE

The problem of decoding arbitrary hand generated Morse code is not a trivial one. It requires some care and thought in the design of adaptive algorithms. As one contribution to this issue's sub theme of computerized Morse code, Lt William A Hickey, USN, provides some background information and suggestions on the subject.

W J Hosking, W7JSW, is an amateur radio operator in search of applications hardware and software. Read about **A Ham's Application Dreams** and find out how to implement one aspect of his dream with the Morse code input and output conversion technology described in detail in the balance of this issue

A theme of this October issue is the application of microcomputers to the decoding of Morse code. One approach to the problem is detailed in Robert Grappel and Jack Hemenway's article on **MORSER** . . . a program to read Morse code, implemented with a Motorola 6800 computer.

Lawrence Krakauer describes a technique to store Morse characters as a packed table of bit patterns for machine generated outputs — or for machine decoded inputs.

If Only Sam Morse Could See Us Now. He'd have a fistful of problems trying to copy radio transmissions at 1000 wpm generated by programs such as Wayne Sewell's CWBUFFER subroutine. But, using one of Wayne's set of sundry drivers for CWBUFFER, Mr Morse could potentially learn to copy — or at least have his computer copy — in a code practice mode.

One application of the Morse code problem solvers is documented in Bruce Filgate's article on **Morse Code Station Data Handler**. This is an application program which handles direct sending of Morse outputs, from character text, adaptive interpretation of Morse inputs, storing of fixed messages (eg: ' CQ CQ CQ DE W1AW ') in a message buffer for later transmission or repetitive transmission, etc. Bruce has put it all together in the form of a comprehensive 1536 byte program for an 8008.

National Semiconductor announced the PACE computer some time ago, but until recently it has been somewhat hard to obtain. Now that this 16 bit minicomputer is beginning to enter its volume production stage, we **Keep PACE With the Times** by offering Robert Baker's Microprocessor Update on this processor. If you missed the convenience of your familiar 16 bit minicomputer when you started reading about and "dry run programming" for personal computing, then the PACE processor might be a logical choice for a homebrew or kit system.

The advent of the personal system portends a fundamental change in the ways computers are used. In **Homebrewery vs the Software Priesthood**, David Fylstra and Mike Wilber make some comments about the impact of widespread use and knowledge of computers.

Looking for ideas for meetings of your local computer group? Dr Charles F Douds has a few suggestions to make in his background article on the subject this month.

KIT-A-MONTH

The Altair™ kit-a-month plan allows you to own an Altair mainframe without taxing your pocketbook. Mits has made it easy for you to purchase an 8800a, 8800b or 680b computer in monthly installments where you receive components with each payment. There are no financial charges because we have made each monthly shipment a kit in itself. This will give you time to read up on computers and/or gain knowledge from friends.

We have set up an Altair kit-a-month payment desk to service your needs. When writing or calling the factory for information about your shipment or account, just refer to the "kit-a-month payment desk."

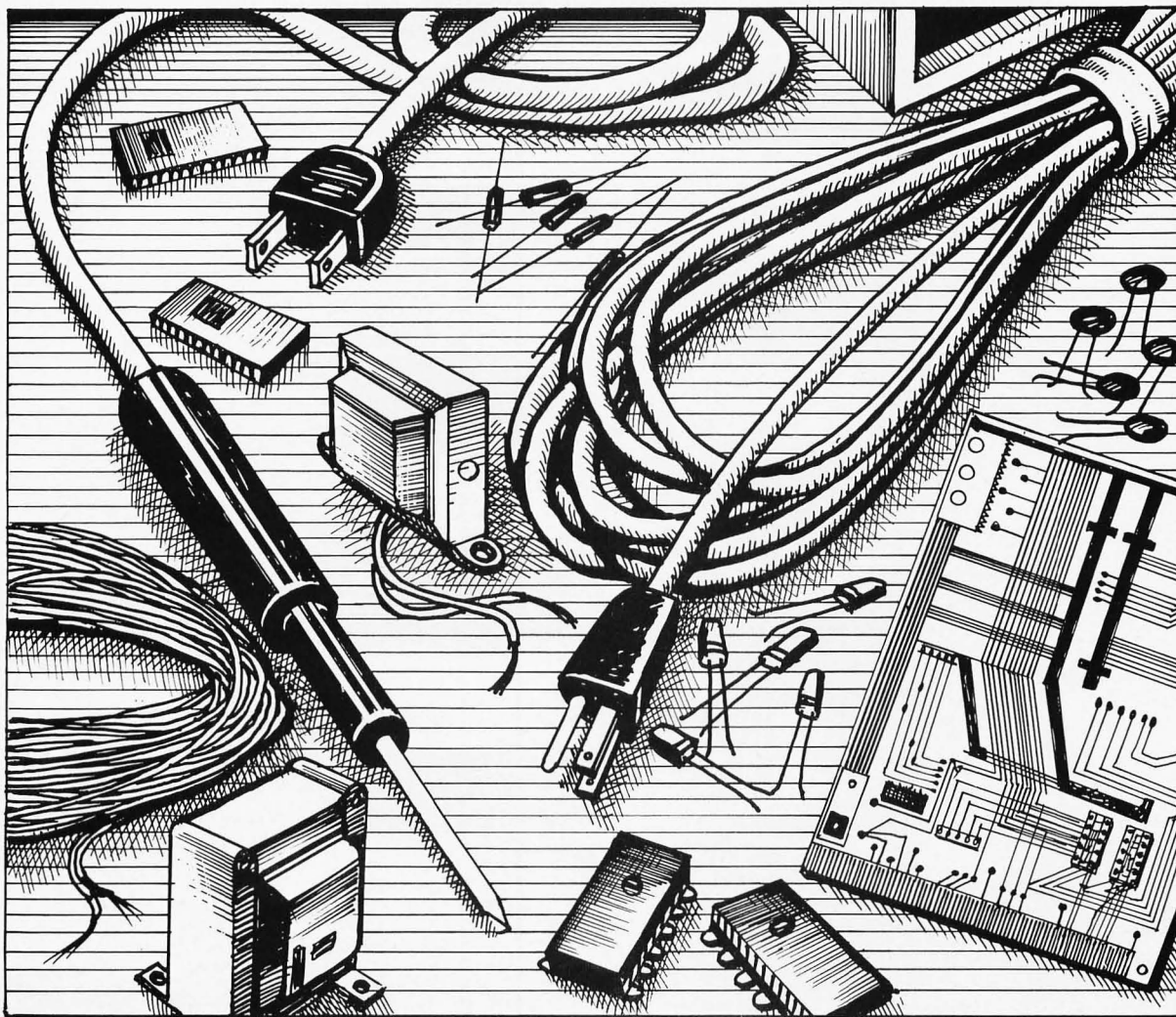

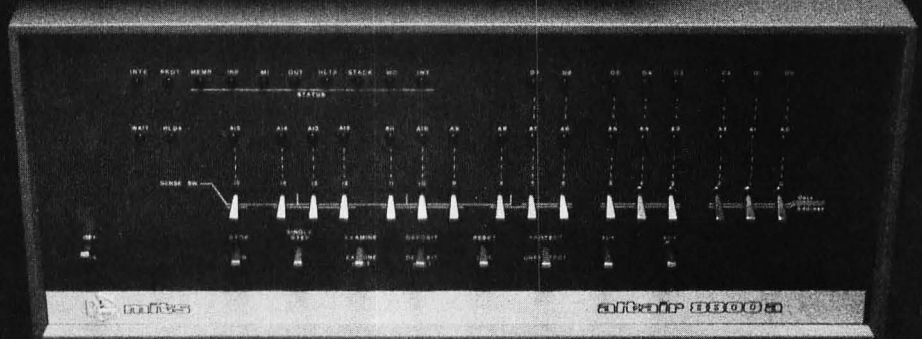
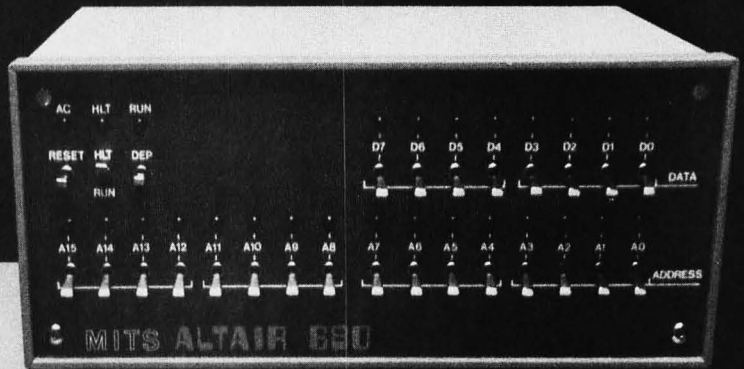

OWN YOUR 680b IN FIVE EASY PAYMENTS

| | |
|-----------|---|
| 1st month | 680b Manuals, Main and Display PC Boards, and membership in users group |
| 2nd month | 680b Case and Power Supply |
| 3rd month | Parts for 680b Display Board |
| 4th month | Parts for 680b Main Board less Integrated Circuits |
| 5th month | 680b Chips |

\$93.20 plus \$2.00 per month make your payments \$95.20 per month and you have your complete kit in five easy payments. This plan gives you the full 680b with memory and I/O. The BAUDOT Option is still \$42.00 extra and may be purchased with Time Payment #4 or #5. Remittance of \$95.20 will start you on your way to owning your own computer.

Alaska, Hawaii, APO and FPO customers include \$3.00 per month for Air Parcel Post charges instead of \$2.00 for regular Parcel Post shipment. This would make your payment \$96.20 per month.

Canadian customers include \$3.00 per each month for postage and handling fees.

NOTE: This plan does not apply to foreign sales other than Canada.

NEW ALTAIR 8800B

Available on Time Payment Plan

\$105.00 payment per month plus \$2.00 postage and handling for each kit makes an easy \$107.00 per month to own the newest of the Altair processors.

Send in your first \$107.00 money order and start receiving your 8800B Kit by August 1, 1976.

| | |
|----------------|------------------------------|
| 8800B Month #1 | Manuals |
| #2 | EC-18 |
| #3 | Power Supply Board & Parts |
| #4 | Transformer |
| #5 | Display Board & Parts |
| #6 | Case |
| #7 | Main Chips |
| #8 | CPU Board & Parts Less 8080A |

Alaska, Hawaii, APO and FPO customers please include \$4.00 for shipping charges (making \$109 per month payments) for Air Parcel Post shipment. Otherwise, shipment will come Parcel Post, not insured.

Canadian customers must accept month #6 Emery Airfreight Collect. All other months must include \$4.00 postage and handling making monthly payments of \$109.00.

\$79.00 / Month

ALTAIR 8800A TIME PAYMENT PLAN

| | |
|-----------------------|--|
| 8800A Time Payment #1 | 8800A Manuals and Users Group Membership |
| #2 | EC-18, PC Board and Hardware |
| #3 | 8800A Power Supply Kit |
| #4 | 8800A Case |
| #5 | CPU PC Board and Bag of Parts less the main chip |
| #6 | Main Processor Chip |
| #7 | Display Control Board and Parts |

The price of the Altair 8800A mainframe is \$539.00. Seven easy payments plus \$2.00 per month for postage and handling charges make this plan equal \$79.00 per month. Upon receipt of your first \$79.00 payment you are on your way to owning your own 8080A basic computer system. A list of available compatible peripherals is enclosed to let you plan your system as you learn about your microprocessor. By 8800A Time Payment #7 you're ready to go.

Alaska, Hawaii, APO and FPO customers please include \$4.00 for shipping charges (making \$81 per month payments) for Air Parcel Post shipment. Otherwise, shipment will come Parcel Post, not insured.

Canadian customers must accept month #4 Emery Airfreight Collect. All other months must include \$4.00 postage and handling making monthly payments of \$81.00.

KIT-A-MONTH

ORDERING INSTRUCTIONS

In order to smoothly and efficiently expedite your orders, we ask that you note the following helpful hints:

1. Send all payments other than BankAmericard or Master Charge in the form of a cashier's check or money order. Personal checks are acceptable, but clearance time will delay your order by 2-3 weeks.

2. The kit-a-month plan has been set up to proceed in order and we cannot deviate from that order. You can help us by noting with your payment what month you are on.

3. When calling or sending in orders, refer to your customer name on the original order and also your Mits order number.

4. If you change your address, keep your name as it is on the original order to keep records straight.

5. Please note special instructions for Alaska, Hawaii, APO, FPO and Canadian customers. If these are not followed, it could result in delays in processing your order.

6. The Kit-a-Month desk has been set up to help expedite your orders because of the overwhelming response we've had with previous time payment plans. Please feel free to use this service whenever you have questions. When writing letters to Mits, simply note "Kit-a-Month desk" on the outside of the envelope.

NOTE: Once you start the Kit-a-Month plan you are guaranteed the existing price at the time of your first order. You will not be affected by price increases.

Enclosed is my payment of _____ for the first shipment of my Altair kit-a-month.

Master Charge # _____ or BankAmericard # _____

Altair 680b

Altair 8800a

Altair 8800b

NAME _____

ADDRESS _____

CITY _____ STATE & ZIP _____



mits/2450 Alamo SE/Albuquerque, NM 87106 505-243-7821

Prices, specifications, and delivery subject to change.



mits/2450 Alamo SE/Albuquerque, NM 87106 505-243-7821

OCTOBER 1976

staff

In the Queue

Foreground

- 30 ADD THIS 6800 MORSE TO YOUR AMATEUR RADIO STATION
Applications – Grappel-Hemenway
- 42 IF ONLY SAM MORSE COULD SEE US NOW
Applications – Sewell
- 52 A MORSE CODE STATION DATA HANDLER
Applications – Filgate
- 74 BUILD THIS MATHEMATICAL FUNCTION UNIT—Part 2
Software – Guthrie

Background

- 12 THE COMPUTER . . . VERSUS . . . HAND SENT MORSE CODE
Applications – Hickey
- 26 A HAM'S APPLICATION DREAMS
Speculation – Hosking
- 36 EFFICIENT STORAGE OF MORSE CHARACTER CODES
Applications – Krakauer
- 82 KEEP PACE WITH THE TIMES
Hardware – Baker
- 90 HOMEBREWERY VS THE SOFTWARE PRIESTHOOD
Philosophy – Fylstra-Wilber
- 118 MEETING ACTIVITIES FOR COMPUTER CLUBS
Organizations – Douds

Nucleus

- 2 In This BYTE
- 9 The Concertina System
- 16 Letters
- 41 Software Bug of the Month 5
- 81 Some Historical Notes
- 86, 110, 126 What's New?
- 95 BYTE's Bits
- 96 Classified Ads
- 99 Programming Quickies
- 100 Book Reviews
- 106 Kil O'Byte
- 107 Travelogue
- 116 Excerpts from Future History
- 130 Clubs, Newsletters
- 144 BOMB
- 144 Reader Service

BYTE magazine is published monthly by BYTE Publications Inc, 70 Main St, Peterborough New Hampshire 03458. Subscription rates are \$12 for one year, \$22 for two years, \$30 for three years in North America. Elsewhere: \$15 one year, \$25 two years, \$33 three years. Second class postage paid at Peterborough NH 03458 and at additional mailing offices. Phone 603-924-7217. Entire contents copyright 1976 BYTE Publications Inc, Peterborough NH 03458. Address editorial correspondence to Editor, BYTE, 70 Main St, Peterborough NH 03458.

PUBLISHERS

Virginia Peschke
Manfred Peschke

EDITOR

Carl T Helmers, Jr

GENERAL MANAGER

Manfred Peschke

PRODUCTION MANAGER

Judith Havey

CIRCULATION

Deborah R Luhrs

DEALER CIRCULATION

Deena Zealy

PUBLISHERS ASSISTANTS

Cheryl Hurd

Julie Nelson

Carol Nyland

Kim Place

ADVERTISING

Elizabeth Alpaugh

Virginia Peschke

TYPOGRAPHY

Custom Marketing Resources, Inc

Goodway Graphics

Mary Lavoie

Taimi Woodward

PHOTOGRAPHY

Ed Crabtree

Custom Marketing Resources, Inc

ART

Matthew Arnold

Mary Jane Frohlich

Lynn Malo

Bill Morello

PRINTING

The George Banta Company

Custom Marketing Resources, Inc

ASSOCIATES

Bob Baker

Dan Fylstra

Harold A Mauch

Chris Ryland

PRODUCTS COORDINATOR

Floyd W Rehling

TECHNICIAN

Melvin G Weir

CONSTRUCTION

Walter Pence

If you thought a rugged, professional yet affordable computer didn't exist,

think IMSAI 8080.

Sure there are other commercial, high-quality computers that can perform like the 8080. But their prices are 5 times as high. There is a rugged, reliable, industrial computer, with high commercial-type performance. The IMSAI 8080. Fully assembled, it's \$931. Unassembled, it's \$599. And ours is available now.

In our case, you can tell a computer by its cabinet. The IMSAI 8080 is made for commercial users. And it looks it. Inside and out! The cabinet is attractive, heavy-gauge aluminum. The heavy-duty lucite front panel has an extra 8 program controlled LED's. It plugs directly into the Mother Board without a wire harness. And rugged commercial grade paddle switches that are backed up by reliable debouncing circuits. But higher aesthetics on the outside is only the beginning. The guts of the IMSAI 8080 is where its true beauty lies.

The 8080 is optionally expandable to a substantial system with 22 card slots in a single printed circuit board. And the durable card cage is made of commercial-grade anodized aluminum.

The IMSAI 8080 power

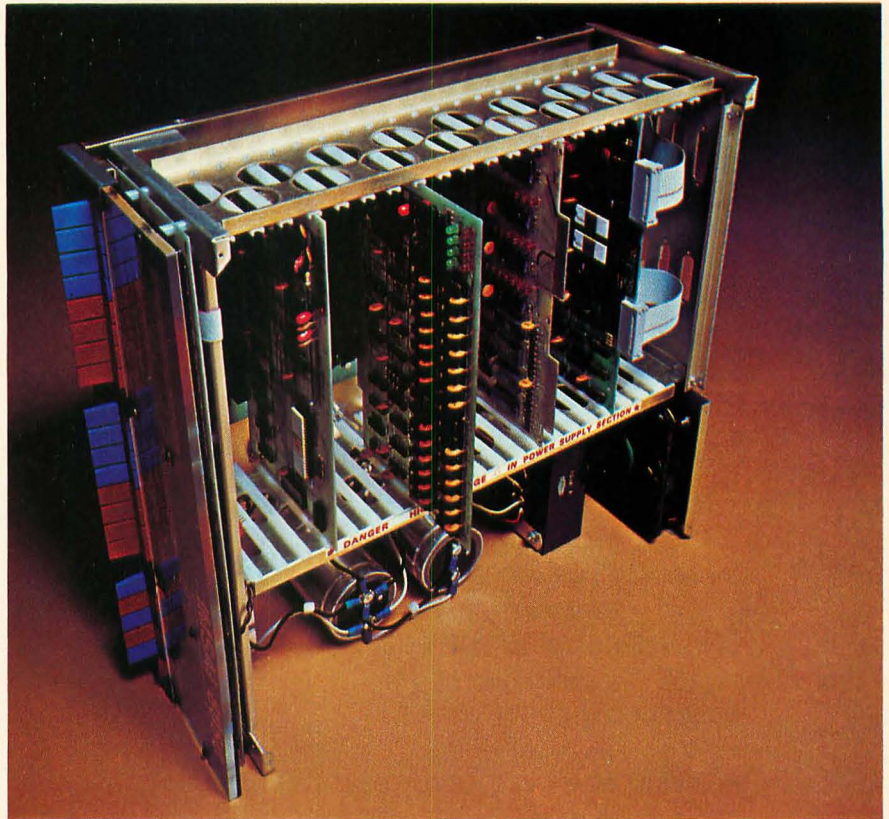

supply produces a true 28 amp current, enough to power a full system.

You can expand to a powerful system with 64K of memory, plus a floppy disk controller, with its own on-board 8080—and a DOS. A floppy disk drive, an audio tape cassette input device, a printer, plus a video terminal and a teleprinter. These peripherals will function with an 8-level priority interrupt system. IMSAI BASIC software is available in 4K, that you can get in PROM. And a new \$139 4K RAM board with software

memory protect. For the ultimate in flexibility, you can design the system for low-cost multiprocessor, shared memory capability.

Find out more about the computer you thought didn't exist. Get a complete illustrated brochure describing the IMSAI 8080, options, peripherals, software, prices and specifications. Send one dollar to cover handling.

Call us for the name of the IMSAI dealer nearest you.

Dealer inquiries invited.



IMSAI

IMS Associates, Inc. Dept. B-10
14860 Wicks Boulevard
San Leandro, CA 94577
(415) 483-2093

The Concertina System

Editorial by
Carl Helmers

The often asked question of the personal systems cynic is "What on earth do people *do* with home computers?" In many ways this question is analogous to what might have been asked by automotive skeptics in the early part of this century: "What on earth do you expect people to *do* with automobiles?" Fifty to 60 years of history have answered the latter question in numerous concrete demonstrations, and one can only expect the coming decades of computer evolution to answer the former question in numerous ways.

Of course the simplest reply to the first question is "Compute!" and is as empty of content as the analogous reply for automobiles, "Drive!". Computing without a purpose is like driving without a destination, an intrinsically enjoyable pastime on occasion but hardly touching upon the set of possibilities inherent in digital computation and control. The key to a broadened perspective on the computer and its place in human activities is the concept of the application. An application for the computer is like a destination for an automotive trip. If I set in my mind the goal of driving down to Boston for an evening in Symphony Hall with Arthur Fiedler, the Boston Pops and company, my automobile has now acquired an "application." Similarly, if I decide to customize my computer system as a vehicle for editing and playing music, a very ordinary and garden variety Motorola 6800 plus memory and peripherals has acquired an "application" whenever I choose to use it for that purpose. (Like an automobile that can be driven anywhere without reason, the true general purpose computer need not be exclusively dedicated to one applications goal.)

The concept of music played using computers is an excellent focal point to demonstrate practical uses for personal computers. Here is a specific application of the computer technology for very human purposes, a concrete argument to throw at

the skeptic and cynic. The choice of a musical application goal, like the decision to drive to a concert with an automobile, makes the technology come alive with human values.

The traditional concertina is a simple pneumatic acoustical instrument similar to an accordion. The pneumatic concertina is hardly a widely known or used instrument. In a hand held package with control buttons, it gives the player an ability to create a fairly rich timbre similar to a reed organ or a harmonica. Like all instruments, it requires an element of virtuosity to play at all well, but within its limitations it makes an interesting vehicle for musical expression.

The relative obscurity of the original concertina instrument, the harmonically rich nature of its timbre, noting its use by a single (good) artist in creating a polyphonic output, and most of all, falling in love with the smooth sound and etymological roots of its name leads me to propose the name "concertina system" for a musical instrument based on a personal computing system integrated with musical software and peripherals. The concept of the digitally controlled musical instrument is not new, but the technology which makes it possible at a reasonable price is as new as the whole LSI computer technology. For about the same price that you or I would pay for a virtuoso quality home electronic organ, it is possible to add a music playing peripheral to a computer system which will allow the owner to accomplish musical performance feats unheard of on an organ or traditional instruments. As of this writing, I know of two companies which are in the process of preparing products which can simply convert an existing computer system into a polyphonic synthesizer with the potential (with software) of becoming a truly playable concertina system. One company is located in Arizona and is said to be designing an Altair compatible plug-in card with several polyphonic channels of digitally controlled music output. Another company, ALF Products, 2130 Bell Ct, Lakewood CO 80215, is in the preproduction prototype stages of preparation to market a modular computer controlled synthesizer which inter-

faces to any existing computer by using the two programmable ports of a single PIA chip. (Most existing computers have provisions for a "PIA card" with one or more such "parallel interface adapters" together with appropriate plugs.) The ALF design has 8 fully programmable music channels with an option to add 8 less versatile "background" channels to achieve the potential for a truly orchestral sound.

There are undoubtedly additional individuals and companies working on similar systems and products which can simply and inexpensively (relative to costs two to three years ago) add a minimal concertina system capability to the typical home computer system. Readers will find more information on this subject as the products become better defined and reach the marketplace; we also expect to publish articles on the technology of computer controlled musical instruments (experimenters and potential authors: take note).

If you have a computer, you have 75 to 90% of such a "concertina system" already available. All the control and data management power needed to implement a relatively simple and quite functional polyphonic music interpreter is present in a microprocessor system using chips such as the 8080, Z-80, 6800 or 6502 with several K of applications program memory (I use 12 K myself for interpreter and text area, but it would certainly be possible to program a usable system with as little as 4 K memory.) The system also requires a video output

Word Gets Around . . .

The personal computing field is getting some attention as the amount of activity creates some micro ripples in the big pond of things people do. An article in the July 12 issue of *Business Week* featured Paul Terrell's Byte Shop computer store in Mountain View CA. Paul's shop is one of the largest retail outlets among the more than 250 stores coast to coast which regularly stock BYTE.

Also, Ivan Berger, electronics and photography editor of *Popular Mechanics* magazine, reports in phone conversation that he has scheduled a short feature article on home computers, their present and future prospects, in the September *Popular Mechanics*.

There have of course been several local and national newspaper stories lately. As products improve and the market expands, we should see more and more examples of public awareness of computers documented in the press and other media, a welcome trend indeed. ■

display, ASCII text keyboard and a pair of audio cassette drives with motor control via relays and a data rate of at least 300 baud. Obtaining better mass storage peripherals such as floppy disks, 3M cartridge drives or high speed electronically controlled Philips cassette decks is of course highly desirable.

This use of the computer system, while requiring a dedicated peripheral, is completely consistent with the concept of the general purpose personal system, for when the system is not being used for music, programs with other purposes can be employed. Many typical uses require such a peripheral specific to the application; many other applications such as record keeping, calculation, text processing, mathematical and simulation games, and so on merely require the general purpose computing system composed of processor, programmable memory, text keyboard, video display and mass storage on magnetic media. The "concertina system" concept is but one of innumerable answers to the critic's question of "What do you really do with a home computer?" ■

Size and Finesse

Perhaps you've noted a moderate expansion in the size of your monthly mouthful of BYTE, along with the addition of some colorful spices to make each BYTE more flavorful.

Switching metaphors, a magazine such as BYTE is in many respects like a very large and complicated program design. The first concern was and is to fill a high quality technical magazine with good useful information and fun, once a month. This is the algorithm we have used very successfully and continue to use.

But, like the large program, although the basic algorithm design is not subject to major changes there are always new features, incremental improvements and parameters to adjust. Striving for the "best possible BYTE" is an ingrained part of our philosophy, where "best" is defined as serving the needs of our customers in this specialized field.

In the area of improving the product, recent increases in the size of each BYTE reflects a synergistic combination of subscriber and advertiser support. The added spice of color printing on interior pages is directly a result of support from advertisers, who make such support possible because of our readership. We're still experimenting with this new possibility of highlighting and enhancing technical articles but the presentation should continue to improve. ■

And now minis too! All from a catalog, at discount prices.

Digital's Direct Sales Catalog — the first catalog to offer computer products by mail with off-the-shelf delivery — was such a success, we've come out with an expanded second edition that includes the PDP-8A, the newest member of the world's most popular mini-computer family.

We've also added the LA180 line printer and expanded the sections on microcomputers,

logic modules, terminals, cabinets, connectors, accessories, and supplies from the first edition.

Of course, you still get our 5% catalog discount, plus another 4% for cash with your order. You also get a 10-day free trial period, plus our standard 90-warranty. (Since we're selling by mail, you do have to install the equipment yourself.)

If you were among the thou-

sands who ordered our original catalog, you'll get the new one automatically by mail.

If you weren't, why not sign up now?

For your free copy, call 800-225-9480 (Mass. 617-481-7400 ext. 6608). Or write: Components Group, Digital Equipment Corp., MR2-2/M59, One Iron Way, Marlborough, MA 01752. (Catalog sales to U.S. only.)



The Computer... Versus... Hand Sent Morse Code

Lt William A Hickey USN
c/o US NSGA Edzell
FPO New York NY 09518

So you've been reading all about these marvelous new microcomputers, and thinking about how nice it would be to have one that would translate Morse code for you. Well, it certainly sounds reasonable; it really depends upon what you expect from your computer. If you are expecting error free code translation under even the best signal conditions, you are in for a rude awakening.

First of all, a computer (by today's standards anyway) cannot beat or even meet the standards set by a good human operator receiving code. You say you'll concede that point? Why should it be so difficult to design a translator that would work most of the time? That's the purpose of this article! I am not trying to discourage all the code copying enthusiasts out there; I am trying to prepare you for some of the not so obvious problems you might expect.

For the purpose of this article, I will have to assume that you have somehow managed to translate the audio (code signal plus noise plus garbage) into a digital format of 1's and 0's. There are many ways to do this, but probably the most simple is shown in figure 1. This is a straightforward tone decoder using a 567 integrated circuit. (Remember that when a tone is present and decoded, the output is a zero.)

Now that you have this nice (hopefully free of noise) digital signal, what do you do with it? The answer to this one is simple . . . Anything you want to do! In all seriousness, I will now branch into a discussion of hand sent Morse code characteristics. Assuming that you all know that a dot is assigned a relative time duration of (1.0), it follows that you also know that the dash is ideally (3.0), the letter space is (3.0) and the word space is (7.0). (If you are a ham, you do know that, don't you?) At this point I can safely say that the problem of translating machine sent Morse code is relatively trivial. I use the word trivial because it is really just one machine talking to another machine; the intervals are all fixed and are constant, making translation merely a matter

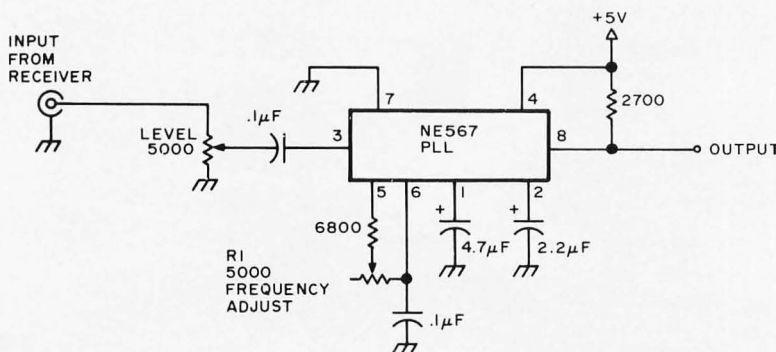

TIMING

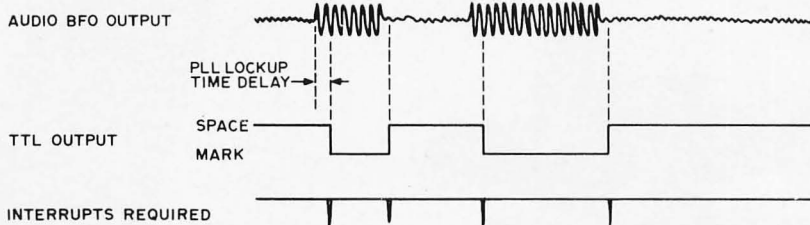

Figure 1: A suggested circuit to decode the audio output of an amateur radio receiver. The receiver produces an audio tone burst corresponding to the keyed continuous wave (CW) signal being received. This tone has a frequency which depends on the tuning of the receiver. The 567 PLL circuit is a tone decoder, which can have its center frequency adjusted by R1. The receiver output frequency and the NE 567 frequency should be the same for the desired signals. Noise and garbage (such as other stations nearby) will complicate the actual receiver output waveform.

of a table lookup assuming both machines use the same Morse code data rate.

At this point, it will be convenient to illustrate the hand sent Morse translation problem. Figure 2 is a histogram of a very short message sent with a hand key.

CQ CQ CQ DE OPERATOR NUMBER ONE

The largest single distribution in the shorter mark group has been assigned the relative time value of (1.0). Keeping in mind the very small size of this sample, you can see that there is a wide variation in mark lengths. (This variation will increase proportionately with an increase in sample size.) Space lengths are not as clearly defined, and it is very difficult to decide where the decision should be made between letter spaces and word spaces. This won't be a serious problem though, since an extra space or the lack of a space between words rarely damages the message context. The decision problem will become acute when the space interval within characters begins to spread toward the lower boundary of the space interval between characters. This will be one of the primary sources for decoding errors.

This article will not and should not specifically address such problems as: (1) gradual frequency drift from either the transmitter or receiver, (2) rapid transmitter frequency drift ("chirp"), (3) atmospheric fading, (4) noise from natural or human made sources, or (5) the presence of many other Morse and non-Morse (SSB, RTTY, etc) signals in the same receiver passband. The reason for this is simple: These factors are just too complex to be within the correction capability of simple algorithms. Remember that these problems are common to machine sent and hand sent Morse code signals.

Translating hand sent code really begins to get sticky when the sending operator gets sloppy. (He or she might send a "special" signal like -.....- [73, a signoff greeting] which tends to give receiving operators problems too!) Let's face it, there are a lot of really bad "fists" out there. Of course, there are some pretty good ones too, but frequently the contact you want falls into the bad group!

The reason automatic decoders are usually unsuccessful at decoding hand sent Morse code is: they are unable to adapt to the time

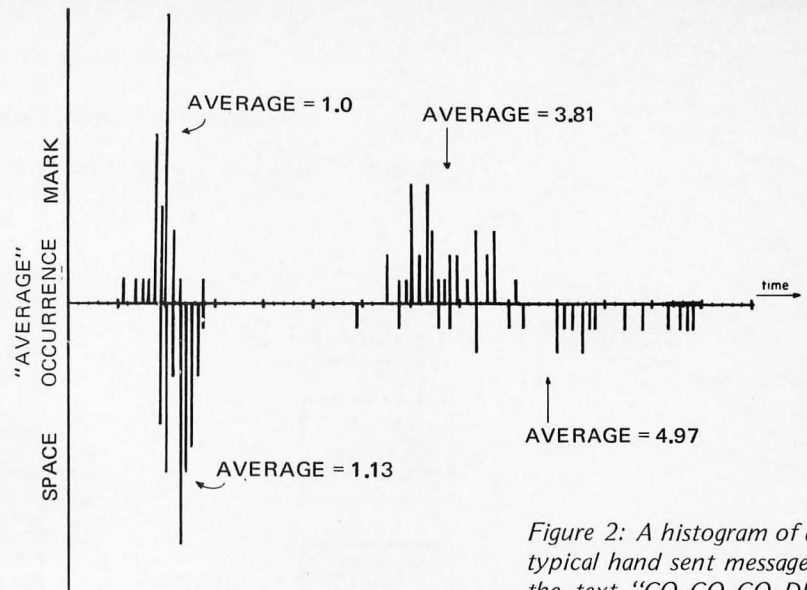
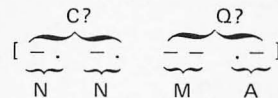

Figure 2: A histogram of a typical hand sent message, the text "CQ CQ CQ DE OPERATOR NUMBER ONE". The terms "mark" and "space" refer to the low and high TTL levels out of the detector of figure 1, respectively.

varying properties of the statistical Morse signal. (This means the signals change characteristics from time to time . . . usually just as the machine was ready to adapt to the previous change.) These statistical changes are reflected only partly in the mark and space timing characteristics of different operators or those of the same operator over an extended time.

One of the advantages a human has is the ability to make contextual analysis on what is sent. For example, an operator might hear



and understand the signal ["CQ"]; the machine would translate NNMA (just as it was sent). Examples of this phenomenon are endless and are available on the airwaves daily.

There are three primary approaches to a solution of the hand sent Morse translation problem:

1. *Macro*: You can accumulate statistical information on a particular operator and use this data to make decoding decisions.
2. *Micro*: You can make your decisions on a mark to mark basis.
3. *Averaging*: You can compromise these two methods and come up with a hybrid algorithm.

Approach (1) requires a long sample time to develop the statistical information, and during this time the decoded output would probably be unacceptable. Even after the statistics become valid, the decoder would operate only on operators with similar

Data Definitions: 8 bit registers or programmable memory

| | | | |
|--------|--|-----------|--|
| X | Duration of the previous input state. | OUTCH | Output ASCII character temporary buffer. |
| AVGDOT | Running average of the previous "n" dot times. | MORSREG | Morse code pattern input shift register. |
| | | PREVSTATE | Previous mark or space input state. |
| | | STATE | Current mark or space input state |

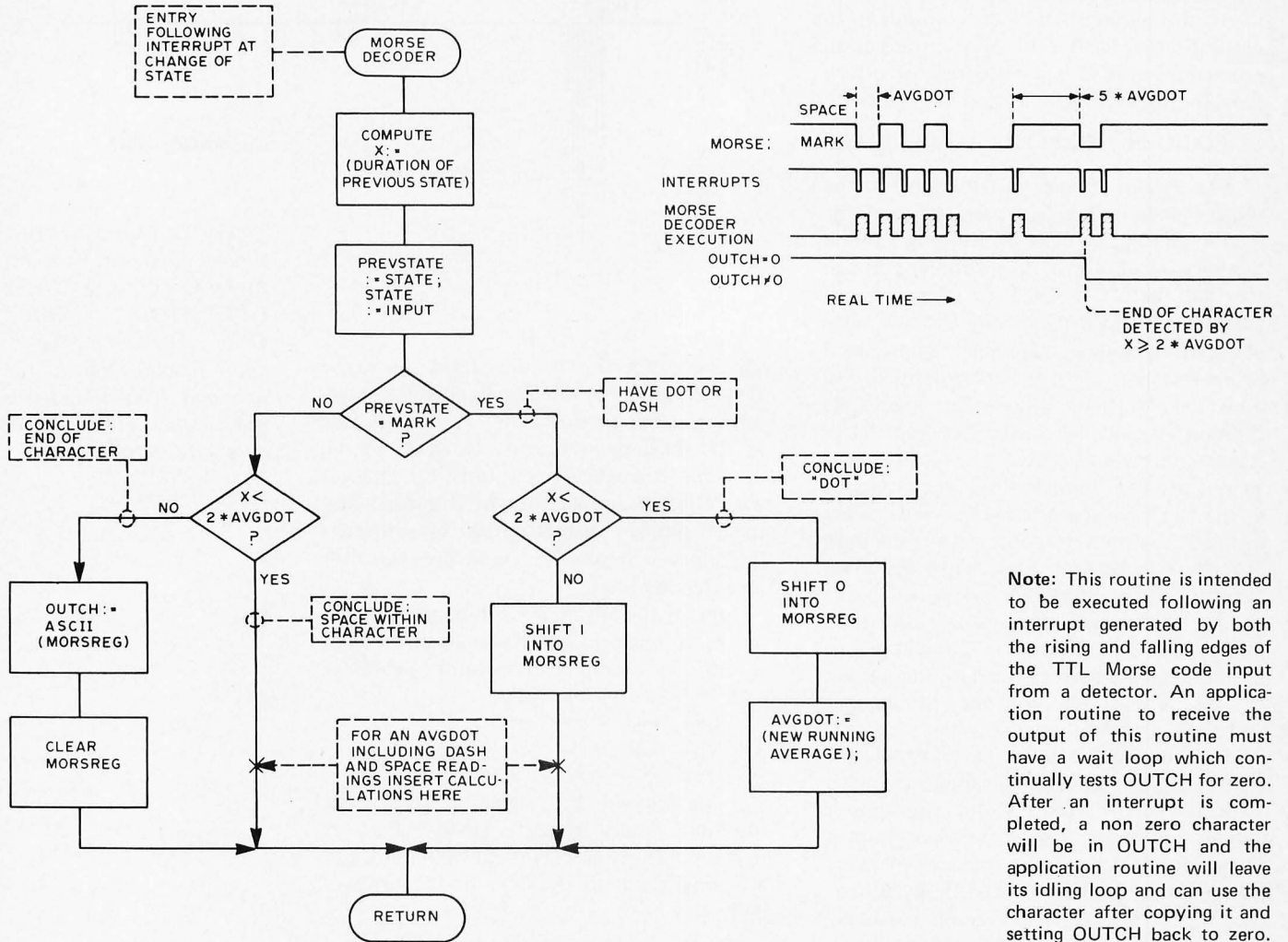

Note: This routine is intended to be executed following an interrupt generated by both the rising and falling edges of the TTL Morse code input from a detector. An application routine to receive the output of this routine must have a wait loop which continually tests OUTCH for zero. After an interrupt is completed, a non zero character will be in OUTCH and the application routine will leave its idling loop and can use the character after copying it and setting OUTCH back to zero.

Figure 3: The flow diagram of a relatively unsophisticated Morse decoder program. The adaptive features of this program are contained in the calculation of a new running average of the dot length whenever a dot is detected. The speed of the algorithm's response to a change in the keying rate of the Morse input is a function of the number of dots maintained in the running average. A more complex algorithm could take into account the nominal dash spacing of three dots as part of the average, as well as the spacing between signal elements within characters.

idiosyncracies. This is a nice idea, and it works well for individual operators; but it is not very workable for a broad collection of operator characteristics. Approach (2) is the easiest method — sometimes called the "ideal dot" method — but it is very susceptible to noise pulses and rapid code speed changes. (It tends to generate an excessive number of errors and is not really that good for decoded output.) For now, approach (3) seems to offer the best chance of working.

Many individuals and commercial manufacturers have tried variations on approach (3); but they all boil down to: Sample from four to eight characters, average the lengths of the dots, and use that average to make decoding decisions. After the initial average is set, you can update the average each time a dot is detected; or you can average both dot and dash lengths and settle on a median

Continued on page 106

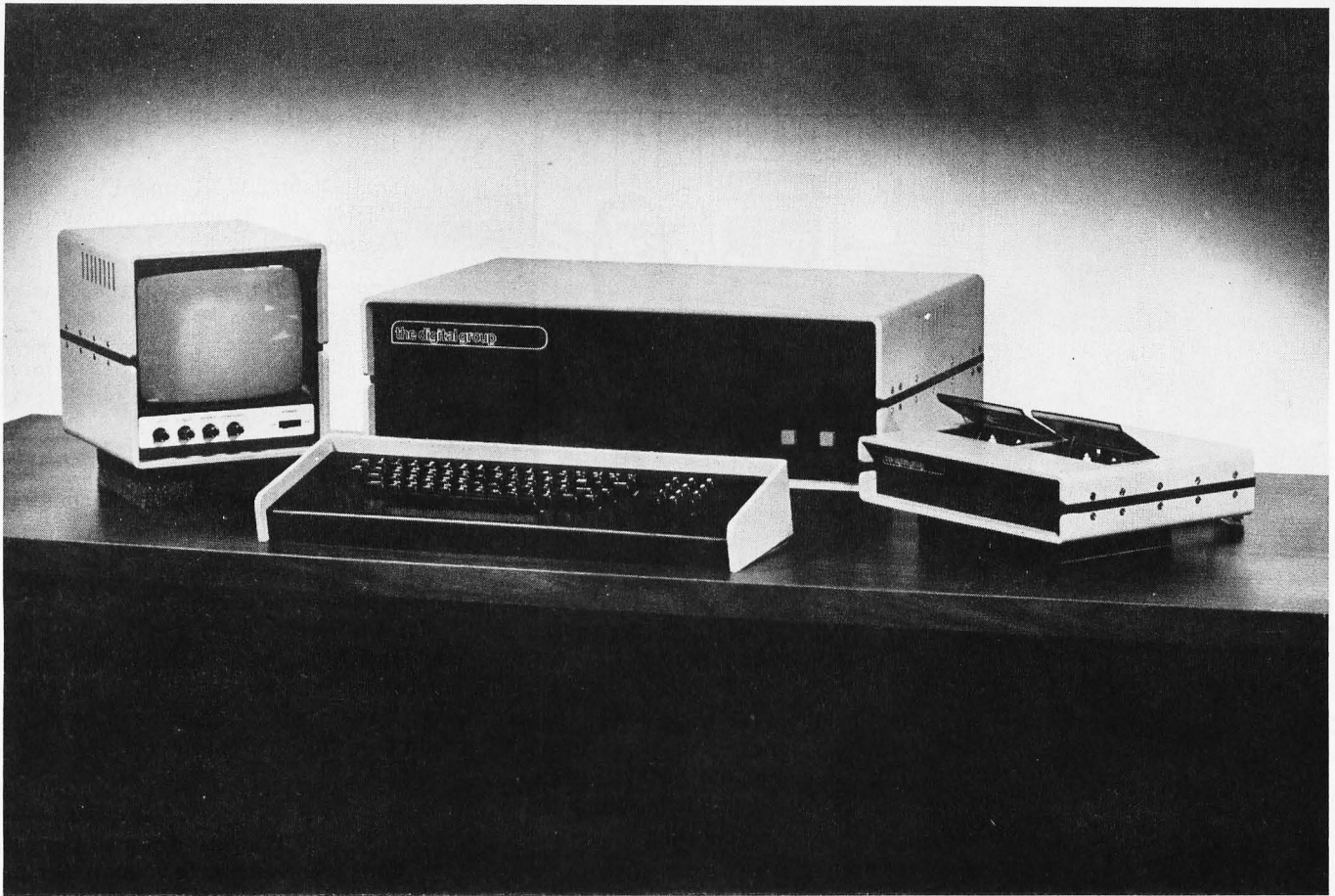

The Digital Group covers up. (Beautifully.)

For many months the Digital Group has been hard at work on the heart of our microcomputer system, insisting on quality where it counts in every product we've designed. Now, we have turned our attention to the outside and covered up . . . with a complete line of custom cabinetry that will enhance your Digital Group system for all the world to see. The result is beautiful.

Sleek and sophisticated, but rugged enough to take all the hard knocks you hand out, Digital Group cabinets are made to be used and not just admired. Extra-heavy-duty eighth-inch aluminum is utilized throughout with a special tough-texture commercial-grade paint in Computer Beige. All front panels are anodized aluminum in dark brown. Even the front panel switches are lighted.

The Digital Group offers a beautiful cover-up for each part of your system — from the CPU to the video monitor. What's more, every new Digital Group product will get covered, too, so each piece will maintain that unmistakable Digital Group image.

We're sure you've already fallen madly in love with our cover-ups, but just wait until you take a peek inside. That's where the real beauty lies.

Our video-based systems, including 8080, 6800 and the super new Z-80, are state-of-the-art, high quality and totally integrated designs. Digital Group systems are complete and fully featured and are specifically designed to be easy to use. Merely power on, load cassette and go! (And with our new cover-ups, you go in style.)

Best of all, Digital Group systems are available now. And affordable. Prices for a complete Z-80 based CPU start as low as \$645, including the cover-up.

So write or call us for all the beautiful details. And then head for cover!

the digital group_{inc.}

The Digital Group
P.O. Box 6528
Denver, Colorado 80206
(303) 777-7133

Letters

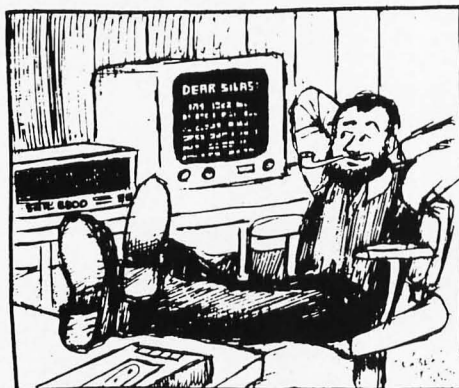

MORSE CONVERSION BACKGROUND INFORMATION

A letter from W A Hickey regarding Morse translators appeared on pages 92-93 of your July issue. For the further edification of your readers, perhaps including Mr Hickey, I provide the following additional references on this topic:

Althoff, W A, *An Automatic Radiotelegraph Translator and Transcriber for Manually Sent Morse*, NTIS AD-772 745, Dec 1973.

Ball, Edison L, *Processing of the Manual Morse Signal Using Optimal Linear Filtering, Smoothing, and Decoding*, NTIS AD-A019 493, Sept 1975.

Bedzyk, W L, *Machine Translation of Morse Code Using a Microprocessor*, NTIS AD-785 130, June 1974.

Guenther, J A, *Machine Recognition of Hand-Sent Morse Code Using the PDP-12 Computer*, NTIS AD-786-492, Dec 1973.

McElwain, D K and M B Evens, "The Degarbler - A Program for Correcting Machine Read Morse Code," *Information and Control*, March 1959.

McNaney, J T, and Richard R Tice, *System for Converting Telegraphic Code into Characters*, US Patent 2,840,637, June 1958.

Powers, B L, and F R Scalf, *The Design of a Morse-to-Teletype Signal Converter Using Integrated Micrologic Circuitry*, NTIS AD-840 255, June 1968.

Shenk, E R, and J C Phelps, *Automatic Code Signal Discriminating Device*, US Patent 2,534,388, Dec 1950.

Smith-Vaniz, W R, and E T Barret, "Morse to Teleprinter Converter," *Electronics*, July 1 1957.

Tevis, R, *Printing Telegraph Receiver*, US Patent 1,805,114, May 1931.

Thomas L A, *Morse Code Printing System*, US Patent 2,534,387, Dec 1950.

Winter, A C, *Code-Controlled Apparatus*, US Patent 2,384,513 Sept 1945.

I doubt that this list is complete; I have not been interested enough to do a really thorough literature search.

On a different topic: May I suggest that you provide the magazine name, the volume number, and the date, at the bottom of each page. Despite your predominantly hobbyist readership, this small professionalism would be useful.

E Douglas Jensen
Principal Research Engineer
Computer Systems Technology Section
Research Department
Honeywell Aerospace & Defense Group
Minneapolis MN 55413

The current issue of BYTE adds a bit to the applications literature. Thanks for sending along an excellent list of further sources.

MORE ON MAKING PC BOARDS

I would like to add a few things to James Hogenson's article on making printed circuit boards [*July 1976 BYTE, page 58*].

Readers who wish to make their own PC boards will find that the spray resists are messy and often difficult to use. We have found that a dry film resist made by Dynachem Corporation, Santa Fe Springs CA 90670, works very well and is easy to use. The material is called Laminar and comes in various thicknesses. The one mil thickness is the best for general use. One of the nice things about it is that it is developed in a water solution of sodium carbonate (Arm and Hammer washing soda) made to a concentration of 2 to 3%. It is moderately sensitive to light and may be used in room lighting without difficulty. It is easily applied by heating the PC board and rolling it on with heating. A hard rubber roller works the best. These are available from art supply

How you can cook up hot programs on your own "8080"

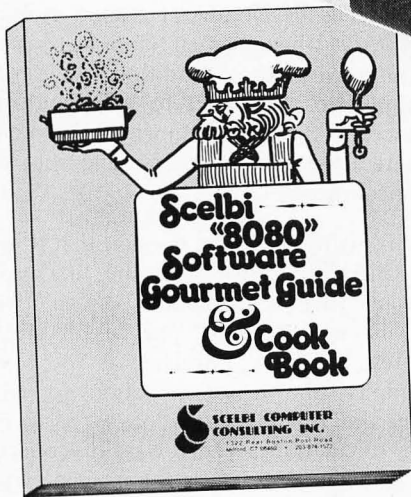
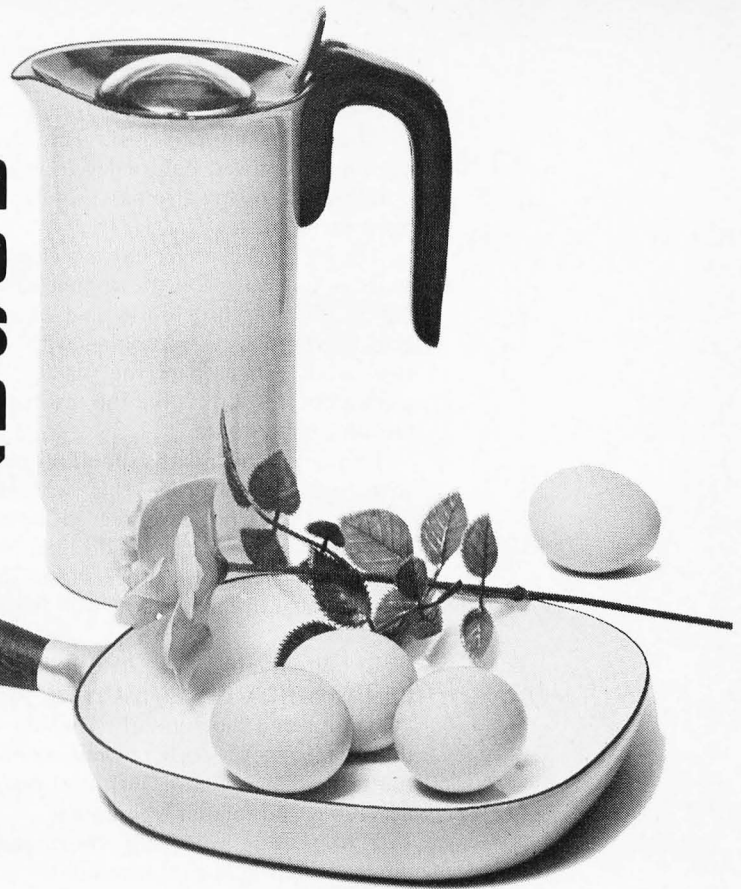

Scelbi offers you a gourmet's delight of all new second generation software for your own "8080". Now you can cook up delectable programs to satisfy your own appetite for "8080" mouthwatering applications. Best of all, Scelbi's "8080" Software Gourmet Guide & Cook Book can be yours for only \$9.95 ppd.

OVER 200 PAGES... only \$9.95!

You'll eat up everything that's in this action-packed, information-crammed book. Gobble up practical "how to" facts. The description of the "8080" instruction set. How to manipulate the "8080" stack. Flow charts and source listings. General purpose routines for multiple precision operation. Programming time delays for real time applications. Random number generators. And many other basic programming function comestibles.

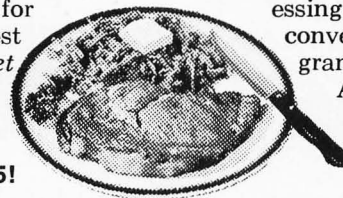

FLOATING POINT ARITHMETIC ROUTINES

The Scelbi "Cook Book" even includes a completely assembled floating point arithmetic program... plus input/output processing for your basic I/O programming through interrupt processing. There are code and numeric conversion routines. Real time programming. Search and sort routines. And too many more finger-lickin' goodies to mention here.

If you're into the "8080", you must own this complete, compact book. It has everything the good computer chef needs. And, you can't beat the price! Only \$9.95 ppd. Order your copy of Scelbi's "8080" Software Gourmet Guide & Cook Book today. Read it over. Then start cookin' on all four burners! Bon appetite!

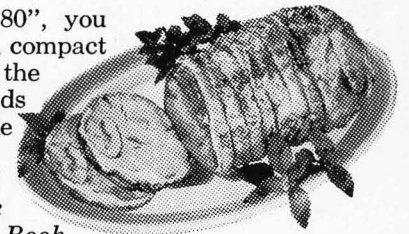

Master Charge, Postal and Bank Money Orders preferred. Personal checks delay shipping up to 4 weeks. Pricing, specifications, availability subject to change without notice. Prices for U.S. and Canadian delivery at book mailing rate. Add \$2.50 for each publication if Priority Air Service (U.S.) desired. Foreign orders add \$6.00 for each publication.



SCELBI COMPUTER CONSULTING INC.

1322 Rear Boston Post Rd., Milford, CT 06460
Telephone: 203/874-1573

stores. The Laminar also has protective plastic coatings on both sides. The soft, flexible coating is removed before laminating to the clean copper clad. The inflexible coating is removed before developing. The E I du Pont Company also has a similar type of resist material.

The PC boards must be very clean before resist is put down on the copper surface. A dip in dilute hydrochloric acid or muriatic acid followed by a scrubbing with Ajax or steel wool will prepare the surface. Hogen-son's photo 9 looks like the result of resist put on a dirty board.

Printed circuit boards shouldn't be drilled with regular steel drills. They will wear out quickly and will leave ragged holes. Try carbide drills made for PC drilling. Most PC material houses should stock these. The type with an eighth inch shaft will fit in most tools.

Bishop Graphics Inc, 20450 Plummer St, Chatsworth CA 91311, has a wide variety of PC layout and tape-up aids. I would suggest that readers get a copy of their catalog since the last 32 pages are a technical manual on PC layout and related techniques.

I hope this will help your readers to improve their PC board technique.

Jonathan A Titus
Tychon Inc
POB 242
Blacksburg VA 24060

ON BLANKS, CHARACTERS AND WOMEN IN COMPUTING

I am glad to see BYTE is developing as a stable but flexible medium for the computer hobbyist. There are, however, three points which should be addressed early in your history:

1. Invent a "blank character." Variable spacing for uniform column width is fine for reading, but poor for showing significant blanks. Programmers have long used special symbols to represent spaces or blanks, much as zeros act as placeholders for Arabic numerals. Examples are the lower-case b with overstruck slash or dash, and a square-cornered U. If no special character is available, perhaps just a lower-case b would do (eg: "LIMb+1" to show a blank as necessary) [*Only necessary in the limited context of character text string examples . . . CH*]
2. Publish your character set. Testing the character set is often one of the first acts performed with a new medium (such as a keyboard, video display, or

printer). It appears that you do not have, for example, Greek letters, although you have quite a variety of fonts and styles. (This suggests using a different typeface to spell out symbols that may be single characters in the original, such as THETA or UP-ARROW). Many of us are no longer limited to 47 computer symbols, but use 128 character ASCII. [*Our text character set is published by IBM, in its literature on Selectric Composer balls; for computer graphics we generally assume 7 bit ASCII unless noted.*]

3. While it is awkward in English to avoid masculine pronouns (he, him, etc), I do think we should try to avoid the masculine assumption about readers (eg: having a wife). This is a new field, which is developing at a time in our history when women (and men) are outgrowing their traditional roles. I think we can expect to see a gradual increase in the number of women interested in computers, and should encourage the trend.

In this light, it may be relevant that if we credit Charles Babbage with the first programmable digital computer design, we should likewise consider one of his chief advocates, the Lady Lovelace, as the first programmer. She wrote instructions for setting up the Analytical Engine to perform certain calculations. (This was, of course, working in the abstract, as the machine was never completed.)

Zhahai Stewart
POB 1637
Boulder CO 80302

As to the last point, we're all for it. But it is a fact that most BYTE readers are male. Where is the other 50% of the human race in computing? As a rule, we try to keep things relatively free of stereotypes in the hopes that the other 50% will start finding out about the wonderful attractions of computers and computing. . . . CH

IDENTITY CRISIS

This is just a short note to say that I am enjoying BYTE and to offer a suggestion in the form of a question:

"What do we call ourselves?"

Radio amateurs call themselves hams and I am sure other people have other names for them. However, in BYTE to date, I find that writers are grasping for words to use to describe the computer hobby. Perhaps you

If we credit Charles Babbage with the first programmable digital computer design, we should likewise consider Lady Lovelace as the first programmer.

Microcomputers are highly complicated devices. When you buy one you want to make sure the manufacturer has a solid reputation for reliability and support. You want to make sure he'll be in your corner a year or two down the road.

The Altair™8800 from MITS was the first general-purpose microcomputer. Today, there are more Altair computers up and running than all the other general-purpose microcomputers combined. Today, Altairs are successfully used for literally hundreds of personal, business, scientific, and industrial applications.

Because we are so popular, many people have tried to copy us. The pages of microcomputer magazines are full of advertisements for Altair compatible devices and Altair imitation computers.

Because we are **NUMBER ONE**, we offer a much broader range of products and services than any of our competitors. One manufacturer might be able to copy one of our computers. Another might be able to produce a working memory card. But no one can copy the overall Altair concept.

The Altair concept is a system concept aimed at practical, cost effective applications. That's why we offer three mainframes including the Altair 680b, Altair 8800a, and Altair 8800b; ten peripherals including a multi-disk system; and over 20 plug compatible modules including our new, low power 16K static memory board. That's why we are the only microcomputer manufacturer to go to the extra expense of providing our customers with quality, higher language software.

When you buy an Altair, you're not just buying a piece of equipment. You're buying years of reliable, low-cost computing. You're buying the support of the **NUMBER ONE** manufacturer in the micro-computer field.



mits

2450 Alamo SE/Albuquerque, NM 87106/505-243-7821

could run a contest of sorts to promote a name for those active in the small computer hobby.

Looking through some past BYTEs I find words such as *microists, kluge, hacker, amateur computer, digital, analytical engine, cyber(nuts)* that may be altered, adapted or crossed to coin some new word to describe a computer hobbyist. Then we can say:

"Hi, I am a ??????????????????????"

Do you suppose this will help people understand what we are up to?

Bryan Patterson
Box 1726
Port Elgin
Ontario CANADA NOH2CO

Well, if we wanted to sound self aggrandizing, we could of course suggest "Byters" as a term. Actually, in spite of the negative connotations in computer science circles, I [CH] tend to prefer the traditional term "hacker." At the start of amateur radio, "ham" as used previously also had somewhat negative connotations. (I make an etymological assumption here that the term as used in radio circles evolved from the tendency to "ham it up" on the air as in the usage of "ham actor.") I like hacker as a term for the serious amateur computer nut (who is also typically professionally involved as well) because it has implications of digging into the subject matter and really learning it at multiple levels of detail. The "compleat modern hacker" is the renaissance man (oops . . . person) of computing.

WHO SAYS THEY AREN'T?

With respect to BYTE covers, you blew it. The phrase "Computers – the world's greatest toys" told it like it was and still is. Truly, the only difference between men and boys is the price of their toys.

A co-worker commented, "If computers are the world's greatest toys, then are programmers the world's biggest kids?" How can I argue with logic like that?

Julius T Marinaro
725 Cricklewood Dr
State College PA 16801

VIDEO TAPE AND COMPUTERS?

I was very pleased to find out about the existence of your journal. I have had an interest in small system uses for several years. At present I am working with video tape systems within a school district in Flint

Michigan. I am interested in finding various small computing systems to use in video tape editing and special effects for CRT displays.

Enclosed is my check for a three year subscription to BYTE. I am looking forward to my subscription. Also I would like to ask for your assistance in answering two questions. I would like to find out if I could obtain back issues of BYTE since it was first published, and I would also like to find out if you can give me any information on the use of small computing systems with video tape systems. Any information that you can give in these areas would be greatly appreciated. Thank you for your time and trouble.

William D Wolverton
10320 Henderson Rd
Otisville MI 48463

September, October and November 1975 BYTE back issues are sold out at present, as is May 1976. Remaining back issues are now being serviced at a price of \$1.50 per copy, plus 25¢ for postage and handling. Send in your requests, but send no money with your request. If we have what you're looking for, we'll bill you for what we ship.

As to the use of computers with video tape applications, it sounds like an excellent use. However, we have no articles in house on the subject . . . yet. Perhaps you'd like to write about your results.

HELP!

I have some surplus ICs from our local IBM factory and would like to identify them. I hope you can help me. I have three types:

2709400 JUQ $\hat{M}i$
V 721304
7324FQ

2709401
Q Korea $\hat{M}i$
721304
7432FO

2709170
JUK $\hat{M}i$
V 721186
733180

They are all ceramic chip with 14 pins gold plated in each side and in the top a gold square with the numbers and a ground line to pin one like in the MOS devices.

Jose Vincente
Caiza Postal 764
13100 Campinas
S P Brazil



Rickey's tackling the SDK-80 microcomputer kit for his next science project.

Rickey likes soccer, lizards, hot fudge sundaes, skateboards and microscopes. He can't decide if he'd rather be Franco Harris, Bobby Fischer or Jonas Salk.

When his Dad brought home the Intel SDK-80 microcomputer systems kit, Rickey helped him put it together. It took only four hours. Everything was there. The 8080 CPU, RAM, PROM, programmable, I/O, a printed circuit board with all those capacitors and resistors and the other things that go with it. The

best part was the instruction manuals. Every step was clearly explained. It was easy. The programming part looked especially interesting. So simple. Just imagine talking to a computer.

The big thrill came on Saturday when they went to his Dad's office to use a terminal. When they connected the SDK-80 to the teletypewriter they got a printout. That was exciting. Within an hour they were talking to the computer, then inventing games. They stayed all day.

Now Rickey is building a micro-

computer of his own. He may be the first kid on his block with his own computer. Thanks to a \$350 low interest loan from his Dad.

If you're interested in being the first on your block to have a microcomputer, contact your Intel distributor: Almac/Strom, Component Specialties, Components Plus, Cramer, Elmar, Hamilton/Avnet, Industrial Components, Liberty, Pioneer, Sheridan, or L. A. Varah.

Microcomputers. First from the beginning. **intel**[®]
3065 Bowers Ave., Santa Clara, California 95051.

A BIT OF CIRCULATION

Attention: Circulation
Dear Ms Luhrs:

Thank you very kindly for making available the lifetime subscription to BYTE magazine which I won at the First World Altair Convention in New Mexico. Of all the door prizes given, I firmly believe I won the best. It was generous of your firm to make it available. I would appreciate your conveying my gratitude to Mr and Mrs Peschke and Mr Helmers.

Since I already have a subscription to your fine magazine, I am presently receiving two copies. I am passing one along to non-subscribers and hopefully it will generate additional subscriptions.

I commend you on the many fine articles which have appeared in past issues. Being a novice in hardware applications, I particularly look forward to tutorial type hardware articles.

Gene Straub
5723 Shasta Cir
Littleton CO 80123

THE IEEE 488 BUS

Regarding your comments about a standard interface for microprocessors, etc, on page 96 of the April issue: I imagine you are familiar with the IEEE 488 which is being used by HP, Tektronix, Fluke and many others to interface microprocessors, calculators, disks, cassettes, DVMs, counters, etc. 488 is not as complex as the standards document would lead you to believe. It is achieving rapid acceptance because it is well suited to microprocessor manipulation. For various reasons it may not be ideal for personal computing, but it seems to be an excellent starting point. One drawback is that HP has the handshake patented. Their license fee is quite reasonable for some organizations but perhaps not for hobbyists. Other drawbacks include the question of common availability of the connector, etc. However it would be nice if there could be some degree of commonality between 488 and any hobbyist standard that might evolve.

Bob Huenemann
4209 Armand Dr
Concord CA 94128

Yes, 488 might be a good place to start. For those unfamiliar with the issue, the full name is IEEE Standard Digital Interface for Programmable Instrumentation, published by the Institute of Electrical and Electronic

Engineers, Inc, document number IEEE Std 488-1975. Quoting from the IEEE standards document, "The Hewlett-Packard Company has assured the IEEE that it is willing to grant a license under these patents on reasonable and nondiscriminatory terms and conditions to anyone wishing to obtain such a license." To obtain a copy of the 80 page standards document write IEEE Service Center, 445 Hoes Ln, Piscataway NJ 08854.

TEXT PROCESSING OUTPUT VIA CONVERTED TYPEWRITERS?

Jim Lang's letter in the August BYTE on hard copy and IBM Selectric typewriters aroused a responsive chord. I too have been interested for some time in using the ubiquitous Selectric typewriter to obtain *high quality* hard copy. It seems to me that anyone familiar with both Selectrics and Teletypes would prefer the former — half again higher speed, much higher print quality, and both upper and lower case. The clincher would seem to be that most XYLS would look more favorably on the idea of spending half a kilobuck or so on something that can also be used as a good typewriter instead of something that can't.

As some readers are probably aware, there is a commercial firm that markets a (rather expensive) applique that attaches to a standard Selectric and makes it into a terminal. (Tycom Systems Corp, 26 Just Rd, Fairfield NJ 07006.)

In this connection, I'd like to point out that the US Patent Office is a veritable gold mine of technical information that can be obtained for a very modest price. For example, the patent documentation covering the Tycom system consists of 26 pages of diagrams and 50 fine print pages of descriptive text. An appreciable fraction of this consists of a *very* detailed description of the internal workings of the Selectric typewriter — it seems to collect details from the myriad of IBM patents on the Selectric into a single place.

A copy of the printed version of this (or any) US patent can be obtained by specifying the patent number (#3,453,379 for the one mentioned above) and remitting 50 cents to "Commissioner of Patents, Washington DC 20231."

Obviously one cannot duplicate a patented item in making a product for sale. Nor, in this case, would one want to, since with new ICs and components, the circuitry involved is verging on obsolescence. Never-

Continued on page 136

altair 8800a^{T.M.}

TECHNICAL INFORMATION

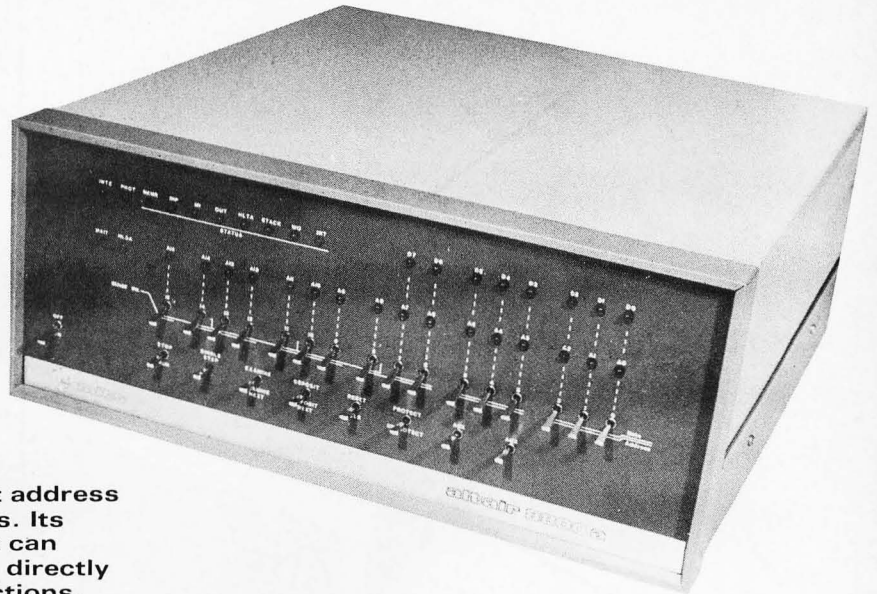

The Altair 8800a is a parallel 8-bit word/16-bit address computer with an instruction cycle time of 2 μ s. Its central processing unit is the 8080 LSI chip. It can accommodate 256 inputs and 256 outputs, all directly addressable, and has 78 basic machine instructions. It is capable of directly addressing up to 65,000 bytes of memory.

As well as the LSI chip, the CPU board contains the two-phase clock, status latch, buffers and the various lines going to the bus. (The buffers are tri-state devices.)

The CPU contains six general-purpose registers, P counter, arithmetic unit, accumulator, stack pointer, instruction decoder, and miscellaneous timing and control circuits. The arithmetic unit contains the circuitry required to perform arithmetic in both decimal and binary forms. The stack pointer defines the current address of the external stack, which resides in memory. The stack is used to service interrupts and provides virtually unlimited subroutine nesting. The instruction decoder decodes the instructions and sets up the various registers, gates, etc., in the CPU for proper functioning.

There are 36 LED status indicators on the front panel, 16 of which are used for the address bus, 8 for the system status latches, and 8 for the data bus. The four remaining LEDs are used for indicating memory-protect, interrupt-enable, system-wait and hold status. Address line inputs A0 through A15, data lines D0 through D7, and the various status lines originate on the CPU board.

The front panel control board contains the circuitry for interfacing between the control switches located on the front panel and the CPU. In addition to the interconnections to the actual processor, this board accepts memory address switches A0 through A15 (also on the front panel). The first eight of these switches (D0 to D7) are used to put data into the CPU.

The front panel logic permits the following functions: STOP—stops the processor immediately after it completes the current instruction; RUN—starts the processor at the current address; EXAMINE—causes the data stored at the location (set by the switches) to be displayed in binary by LEDs; EXAMINE NEXT—steps the P counter once and displays the word

stored at the next location; DEPOSIT—causes the information preset by the switches (A0-A7) to be stored in memory; DEPOSIT NEXT—steps the P counter and loads the memory; SINGLE STEP—steps the program one machine cycle; RESET—clears the CPU and sets up a starting address of 0; PROTECT/UNPROTECT—allows selective write protection of blocks of memory. When a block of memory is protected, it is impossible to write over that block, but its contents can be read out.

With proper adjustments, any memory speed can be used in the 8800a computer, although memory access time must be 500 nanoseconds or less if it is to be run without wait states. In addition to semiconductor RAMs, the processor will also service ROMs and PROMs.

NEW FEATURES POWER SUPPLY

The power supply provides three voltages to the 8800a bus: +8V pre-regulated at 8 amps; +15V at 500mA; -15V at 500mA.

FAN

A fan has been mounted on the back panel of the 8800a to provide cooler operating temperatures.

18 SLOT MOTHERBOARD

The four-slot expander cards in the Altair 8800 have been replaced with a single-piece 18-slot motherboard. The 18-slot motherboard contains the 100 solder lands that comprise the 100 pin bus.

FRONT PANEL SWITCHES

The front panel toggle switches have 50% longer handles that are flat (instead of round) for easier use.

An assembled Altair 8800a may be ordered with six, twelve, or eighteen sets of edge connectors. The Altair 8800a kits include an edge connector with every plug-in module purchased.

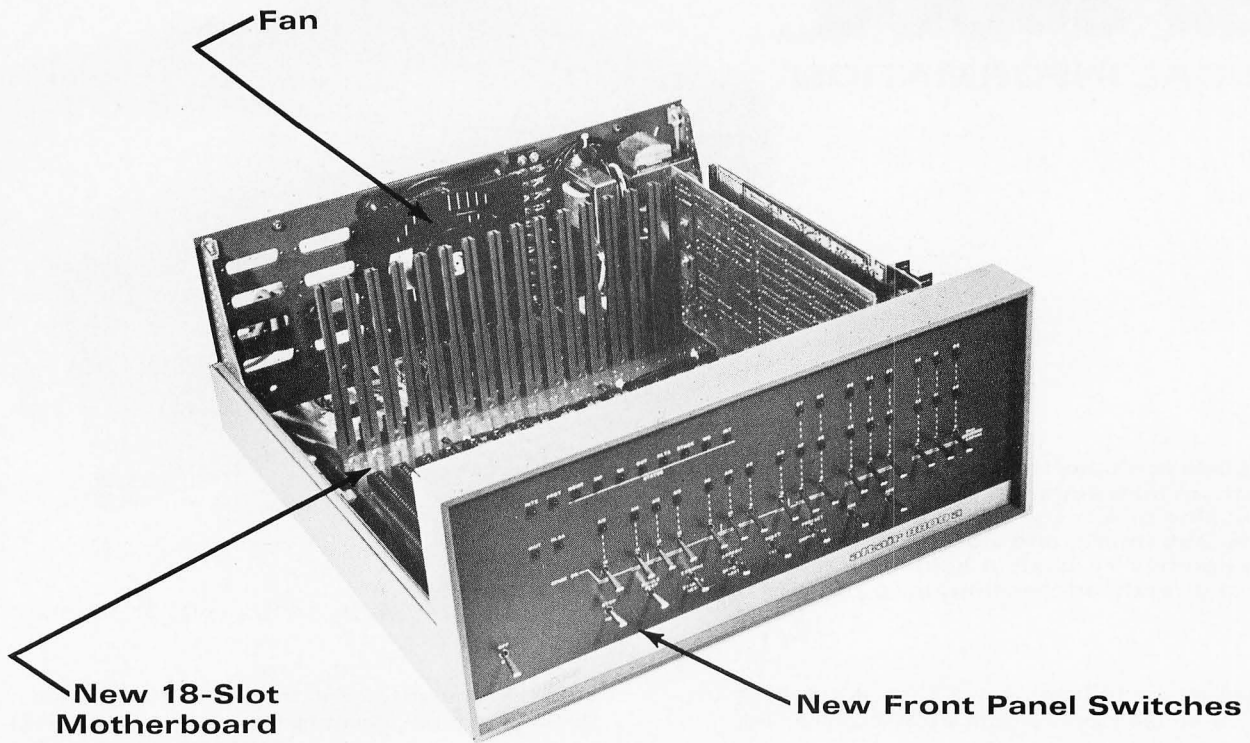

The four boards, along with the power supply, mount in an 18" deep x 17" wide x 7" high (45.7 x 43.2 x 17.7-cm) metal cabinet.

SPECIFICATIONS

| | |
|---|-----------------------|
| Number of Boards | Up to 18 |
| Microprocessor | |
| Model | 8080A |
| Technology | NMOS |
| Data Word Size, Bits | 8 |
| Instruction Word Size, Bits | 8 |
| Clock Frequency, | 2MHz |
| Add Time, Register to | |
| Register, Microsec. | |
| Per Data Word | 2 |
| Number of Instructions | 78 |
| Input/Output Control | |
| I/O Word Size, Bits | 8 |
| Number of I/O Channels | 256 |
| Direct Memory Access | Optional |
| Interrupt Capability | Std. one level |
| Vectored Interrupt (8 priority levels) | Optional |
| Software | |
| Resident Assembler | Yes |
| Cross Assembler | No |
| Simulator | No |
| Higher-level Language | BASIC |
| Monitor or Executive | Sys. mon.; text edit. |
| Software Separately Priced | Yes |



2450 Alamo S.E. Albuquerque, New Mexico 87106

**Consider
what
\$24
will buy
in
1976:**

or



**SIXTEEN
BLACK & WHITE
POSTERS OF
CHARLIE CHAN**

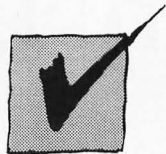
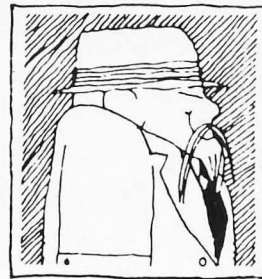

**12 COCKTAILS ON
AN AIRPLANE
FLIGHT
[PRETZELS EXTRA]**

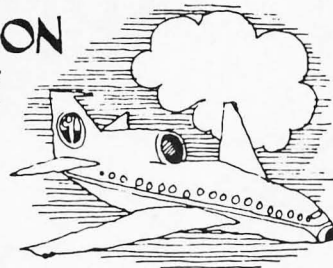

**TEN HOURS OF
PARKING IN
DOWNTOWN
WASHINGTON, D.C.**



**ONE FULL-YEAR
MEMBERSHIP IN THE
IEEE COMPUTER SOCIETY**

and with it, an automatic subscription to
COMPUTER magazine.

Special introductory offer: join now and receive FREE the one-volume collection of COMPUTER reprints, "Microprocessor Architecture and Applications."

Fill out and mail the form below. Find out why membership in the IEEE Computer Society is one of the wisest investments you'll ever make. (At 24 bucks, can you afford NOT to?)

25 YEARS OF SERVICE



IEEE COMPUTER SOCIETY

Quick—send me everything I need to know about joining the IEEE Computer Society. You can send me my free copy of "Microprocessor Architecture and Applications" when I join.

Name _____

Address _____

MAIL THIS FORM TO:

IEEE Computer Society • 5855 Naples Plaza • Long Beach, California 90803

A Ham's Application Dreams

I'm writing this article for a selfish motive. I want to build some things and the construction articles aren't here yet, particularly in state of the art.

I just finished a television typewriter (TVT) which has alphanumeric character generation and storage capacity plus capability of serial or parallel ASCII (plus control) interface. Now that it is finished, I want more than a plaything. I would like to have the following capabilities:

a) Keyboard Morse code (CW) transmit and receive encoding with CRT display.

- b) Keyboard RTTY transmit and CRT RTTY read.
- c) Alphanumeric slow scan TV transmit and receive.
- d) Computer terminal operation with a telephone coupled to a timeshared computer system.

Description

My envisioned system is shown in figure 1. Let's tackle that drawing block by block, considering the TVT and CRT to already exist and applying the constraint of a minimum hardware (low cost) implementation.

W J Hosking W7JSW
8626 E Clarendon
Scottsdale AZ 85251

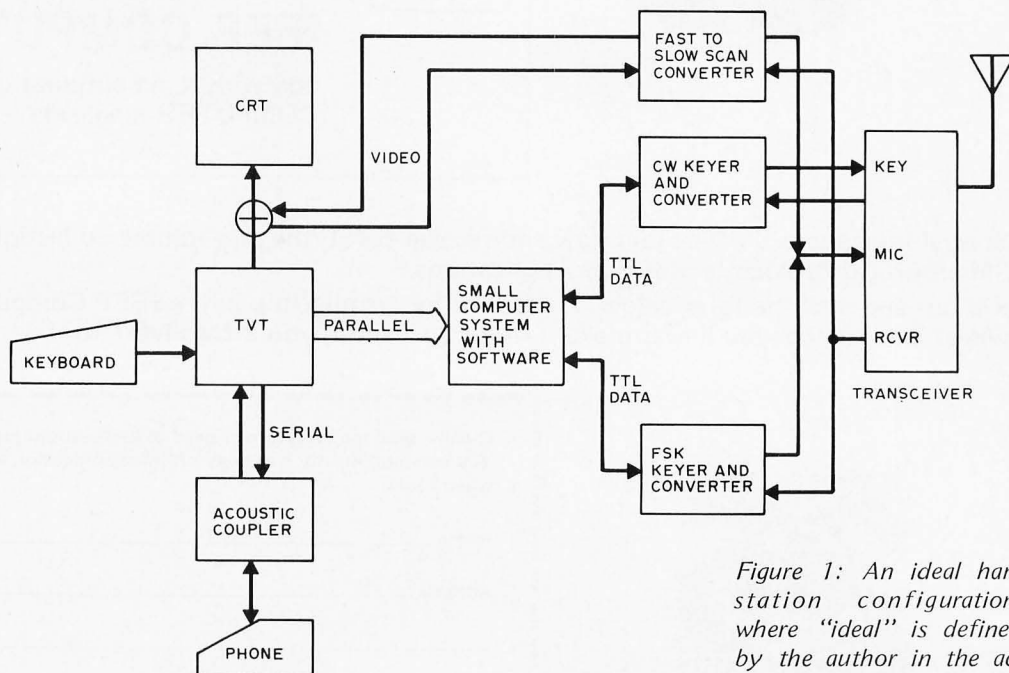

Figure 1: An ideal ham station configuration, where "ideal" is defined by the author in the accompanying text.

**Introductory offer
to new members of the
COMPUTER PROFESSIONALS'
BOOK CLUB**

**any one
of these great
professional books
for only \$1.00
values up
to \$29.95**

**Special \$1.00 bonus book comes to you
with your first club selection**



766/649
**HOW A
COMPUTER
SYSTEM WORKS**
by J. A. Brown
& R. S.
Workman
Pub. price, \$8.95
Club price, \$7.60



767/98X
**THE
PROGRAMMER'S
INTRODUCTION
TO SNOBOL**
by D. Maurer
Pub. price, \$13.50
Club price, \$11.40

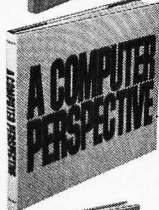

767/246
**A COMPUTER
PERSPECTIVE**
by C. Eames
& R. Eames
Pub. price, \$15.00
Club price, \$12.75

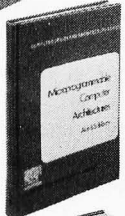

768/03X
**MICROPRO-
GRAMMABLE
COMPUTER
ARCHITECTURES**
by A. B.
Salisbury
Pub. price, \$13.50
Club price, \$11.40



768/307
**CONTENT
ADDRESSABLE
PARALLEL
PROCESSORS**
by C. C. Foster
Pub. price, \$11.95
Club price, \$9.95

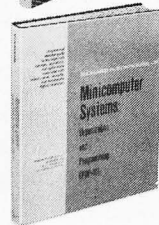

768/641
**MINICOMPUTER
SYSTEMS:
Organization &
Programming**
by R. H.
Eckhouse
Pub. price, \$15.95
Club price, \$12.50

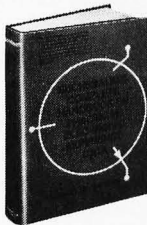

770/271
**BUCHSBAUM'S
COMPLETE
HANDBOOK OF
PRACTICAL
ELECTRONIC
REFERENCE
DATA**
by W. H.
Buchsbaum
Pub. price \$17.95
Club price, \$13.50



767/815
**GAMES &
PROGRAMS:
Mathematics
for Modeling**
by R. R.
Singleton
& W. Tyndall
Pub. price, \$13.00
Club price, \$10.75



767/203
**DATA
PROCESSING
MANAGEMENT**
by D. H.
Brandon,
A. D. Palley, &
A. M. O'Reilly
Pub. price, \$29.95
Club price, \$21.50



767/661
**INTERACTIVE
COMPUTER
GRAPHICS**
by B. S. Walker,
G. R. Grund, &
E. A. Drawneck
Pub. price, \$14.50
Club price, \$12.30



766/479
**THE U.S.
COMPUTER
INDUSTRY:
A Study of
Market Power**
by G. W. Brock
Pub. price, \$15.00
Club price, \$12.50

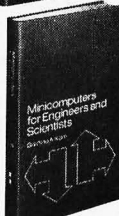

353/387
**MINICOMPUTERS
FOR ENGINEERS
AND SCIENTISTS**
by G. A. Korn
Pub. price, \$23.45
Club price, \$15.50

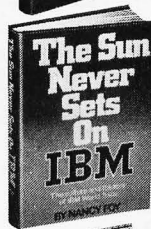

767/084
**THE SUN
NEVER
SETS ON
IBM**
by N. Foy
Pub. price, \$7.95
Club price, \$6.75



766/053
**SYSTEMS
SIMULATION:
Methods and
Applications**
by A. M. Colella,
M. J. O'Sullivan,
& D. J. Carlino
Pub. Price, \$16.00
Club price, \$12.95

save time and money
by joining McGraw-Hill's new
**COMPUTER PROFESSIONALS'
BOOK CLUB**



THIS new professional club is designed to meet your day-to-day on-the-job needs by providing practical books in your field on a regular basis at below publisher prices. If you're missing out on important technical literature—if today's high cost of reading curbs the growth of your library—here's the solution to your problem.

The Computer Professionals' Book Club was organized for you, to provide an economical reading program that cannot fail to be of value. Administered by the McGraw-Hill Book Company, all books are chosen by qualified editors and consultants. Their understanding of the standards and values of the literature in your field guarantees the appropriateness of the selections.

How the Club operates: Every month you receive free of charge *The Computer Professionals' Book Club Bulletin*. This announces and describes the Club's featured book of the month as well as alternate selections available at special members' prices. If you want to examine the Club's feature of the month, you do nothing. If you prefer one of the alternate selections—or if you want no book at all—you notify the Club by returning the card enclosed with each *Bulletin*.

As a Club Member, you agree only to the purchase of four books (including your first selection) over a two-year period. Considering the many books published annually, there will surely be at least four you would want to own anyway. By joining the club, you save both money and the trouble of searching for the best books.

MAIL THIS COUPON TODAY

COMPUTER PROFESSIONALS/Book Club
P.O. Box 582 Princeton Road, Hightstown, New Jersey 08520

Please enroll me as a member of the Computer Professionals' Book Club and send me the two books indicated below. I am to receive the bonus book for just \$1, and my first selection at the special Club price. Actual postage, plus 25% handling charge will be added (sales tax, also, if applicable). These books are to be shipped on approval, and I may return them both without cost or further obligation. If I decide to keep the books, I agree to purchase as few as four additional books (including this first selection) during the next two years at special Club prices (guaranteed 15% discount often more). This order subject to acceptance by McGraw-Hill. Orders from outside the continental U.S. must be prepaid. All prices subject to change without notice. Offer good for new members only.

Write Code # of \$1.00
bonus book
selection here

Write Code # of
first
selection here

NAME _____

ADDRESS _____

CITY _____

STATE _____ ZIP _____

P39161

Morse (CW) Transmit and Receive

Looking back through previously existing magazines on electronics and amateur radio, I have found several articles on Morse keyboards, most using bulky diode matrices. The literature on Morse code readers is much harder to find, and as this is written I found nothing approaching state of the art.

It would seem that, with the rapidly dropping prices of microprocessors and their associated memories and peripherals, the way to go on this project would be a computer using minimum hardware implemented with an LSI microprocessor. I have presented a very basic approach to such a system in figure 2. All that would be required from the hardware standpoint would be the microprocessor, a read only memory for permanent program storage, a programmable random access memory for

working storage, and a peripheral interface adapter (PIA) for input and output. Some other items such as power supplies and clocks are also required. I would hope that the microprocessor interface unit cost could be kept under \$100.

Now for the required design work. This black box I am planning would have to accept a seven bit ASCII code (serial or parallel) plus a data present strobe. The box would convert the input character to serial Morse code and output the code over some suitable keying circuit to the station transmitter. Since we are talking about a small computer, the Morse code speed desired could be ordered by an appropriate input code sequence from the keyboard. The box then has to send a character or flag back to the TVT to say it is ready for a new character.

The reverse or receive mode is the Morse to ASCII conversion. However, here a special conversion device will be needed to change the audio out of the receiver to some kind of signal that the computer can recognize and convert. The software which drives the converter must also recognize intercharacter versus interword spacing and provide space characters to the TVT where required in the received text.

The end result would be Morse code sent by the keyboard through your transmitter and the Morse code heard by your receiver being displayed on the TVT CRT. This is a job for both hardware and software designers. [See the articles elsewhere in this *BYTE* for technical details . . . CH]

Radioteletype (RTTY) Transmit and Receive

The same basic microprocessor described above could be used to provide the radioteletype function instead of or, with more

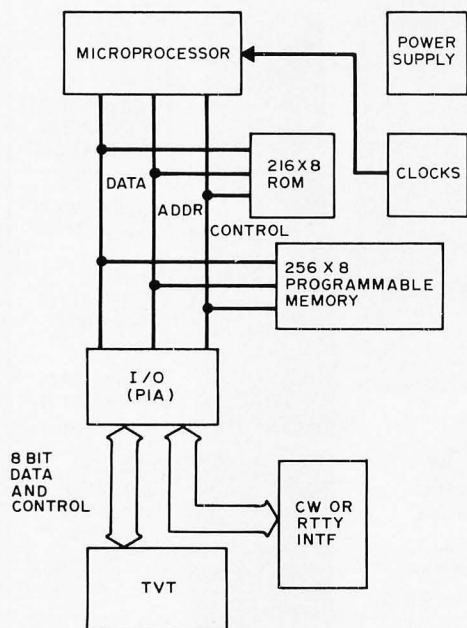

Figure 2: For a dedicated "black box" ham radio data processor, the use of a microprocessor system with as much as 2 K by 8 bits of program ROM with perhaps 256 bytes of programmable memory for data buffering. [Exact amounts of ROM will depend upon the complexity and features of the software loaded; 2 K should be reasonable for Morse and radioteletype support . . . CH]

Editor's Note

Here is a short article on a theme of "wouldn't it be nice to have X" where X is defined as some automation applications for the amateur radio station. It is timely, in the context of this month's Morse code theme, in that one of the author's application goals is detailed in several different technical articles in this issue. There's still plenty of room for further explorations of computer application to amateur radio technology of course . . . CH

ROM, in addition to the Morse code function.

Here, the transmit conversion would be from parallel ASCII (or serial) to serial Baudot at a transmission speed programmed into the computer. The system could easily include niceties such as automatic line feed, etc. The Baudot output would be serial signals sent to an FSK transmit terminal unit. When the FCC finally gets around to approving ASCII on the air, a simple ROM change would reconfigure the hardware to reflect this improvement.

On the receive side, a standard RTTY terminal unit would be used to convert the received FSK signal to a serial binary signal for the microprocessor. This keying signal would be routed to the processor which would convert it to either serial or parallel ASCII, whichever your TVT or terminal interface requires.

This system would work just as a regular teleprinter does, except that the received copy would be on a CRT instead of hard copy on a printer. For those desiring hard copy, a printer can easily be interfaced to the computer system. The development here is mostly software since really good terminal unit and keyer designs are readily available.

Slow Scan TV

This is another area eagerly awaiting new developments. The TVT already has fast scan composite video as an output and the CRT involved accepts composite video. The problems and areas for new development are mostly in the area of conversion from fast scan to slow scan and reverse. It is highly likely that the microprocessor box we have already discussed can do at least part of this job for us. I think this one is really ripe for new breakthroughs.

Computer Terminal Operation

This is probably the easiest task. There are those out there who, had they the terminal, could make use of one or another timeshared computer system. This use requires coupling in one way or another to a telephone line. The easiest way to do this without angering Ma Bell is with an acoustic coupler.

Conclusion

As I said earlier, this was an idea article and now I'm going to sit back and eagerly await the neat ideas generated by all you experts out there. There's room for much development in both hardware and software. If you have designed something to do one of these jobs, then publish it for the rest of us. ■

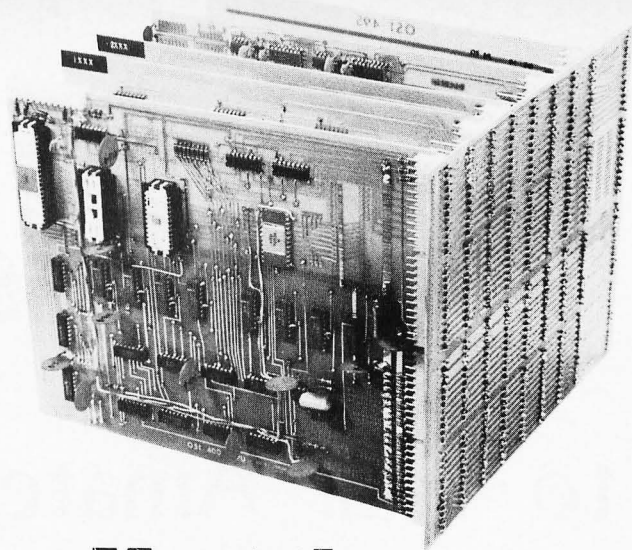

Meet the new OSI 400 Computer System.

Now more performance and more flexibility actually cost you less.

Ask yourself how much system you need. Or how little. Whatever the answer, even if you want to change it later, you get more system for less money with the OSI 400.

Start with the OSI Superboard. Add your choice (!) of a 6502, 6512 or 6800 microprocessor; eight 2102s for 1024 bytes of RAM; and an external front panel. Power it up and you have a working CPU. Or populate the board with a processor, system clock, 512 bytes of PROM, 1024 of RAM, an ACIA with RS-232 or 20 ma loop interface, a PIA with 16 I/O lines and full buffering to as many as 250 system boards for system expansion.

Even fully populated, Superboard costs less than \$140 with a 6502, less than \$160 with a 6800.

But take a look at what you can have for \$29. Our special offer includes a plated-through-hole G-10 epoxy Superboard, bare, plus a 50-page theory of operation and construction manual including complete chip documentation in an attractive OSI binder.

And Superboard is just the beginning of the OSI 400 system. You can expand its memory; interface to many I/Os

including plotters, cassettes, FSK, ASCII, Baudot and more; go video, including graphics; even add floppy disk. And bare boards are just \$29 each, complete with in-depth manuals.

But first things first.



400 me now! SPECIAL — \$29 postpaid with this coupon only.

Name _____
Address _____ City _____
State _____ Phone _____



Enclose check or money order or supply Bank Card information below.

Card No. (include all digits) _____ Good thru _____
Interbank No. (Master Charge) _____ Sign your name _____



Ohio Scientific Instruments
11679 Hayden Street
Hiram, Ohio 44234 Dept. B

Ohio residents, please add tax.

Add This 6800 MORSER to Your Amateur Radio Station

A great many amateur radio operators find Morse code operation a nuisance. It isn't easy to develop proficiency in copying code, and it often seems that those stations one wants to work are just those whose operators send code too fast to readily copy. There must be hundreds of Morse coding aids developed over the years, ranging from mechanical keys and paper tape transmitters to fancy code memories and typewriter like automatic transmitters. Nearly every advance in electronic componentry has spawned a new series of Morse code aids. Nearly all have been designed to help the operator send more effectively; the problem of reception has been more difficult to solve. Some complex circuits have been devised which can copy code, provided that it follows strict timing requirements. Truly general code followers, circuits which can

copy code with performance approaching that of a skilled human operator, are rare. They are very complex, using dozens of integrated circuits, large diode matrices, etc. The recent advent of inexpensive yet powerful microcomputers can make the dream of a relatively simple yet very general code follower possible. Why a computer? First of all, it allows one to develop and improve an algorithm by simply changing program, instead of rebuilding complicated circuitry. Second, since the computer is not restricted to running only the Morse programs, one can use the computing power for any number of other uses, limited only by the operator's creativity. This article describes a code following computer program as implemented on a Motorola 6800 microcomputer. It can copy any code speed from 3 to 60 words per minute, and can adjust to the irregularities

Robert D Grappel
148 Wood St
Lexington MA 02173

Jack Hemenway
151 Tremont St
Boston MA 02111

Development of MORSER

The program for MORSER shown in this article was produced by a relocating assembler designed and written by Jack Hemenway and described somewhat humorously in the August BYTE article "Jack and the Machine Talk" [page 52] by authors Grappel and Hemenway. The relocatability feature allows one to put assembled code anywhere in memory without reassembly, a feature which is most useful for building large programs. One drawback of this is that relocatable addresses (denoted "R" in the listing) are always two bytes, so the programmer cannot generally make use of Motorola's direct addressing mode, which requires addresses to be in the base page, the first 256 bytes of memory address space. Since MORSER was programmed so that both data and program code are relocatable, it is not the most compact form in which the algorithm could be expressed on a 6800. If one rewrote the program to keep all the variables in the first page of memory and used direct addressing wherever possible, about 75 bytes of storage could be saved.



Photo 1: Author Robert Grappel, shown at the console of Jack Hemenway's computer system with a hand held switch used to test Morse code inputs to MORSER during the development of the program.

of hand sent code. A minimal amount of external hardware is needed, and the program only takes about 600 bytes of memory. The algorithm can be converted to run on almost any 8 bit microprocessor. Since you are still reading this, you are hooked. Let's begin to dissect the program.

MORSER consists of five segments: initialization, decoding, delay timer, sampler, and terminal driver. In the program listing, lines 001-068 are initialization, lines 069-200 are decoding, 200-213 form the delay timer, 214-250 form the audio sampler, and lines 251-277 drive the output terminal. Each segment will be described in turn.

The major function of initialization is to define the variables in the program and to give them appropriate initial values. The operating system of Jack Hemenway's machine performs some of the initialization automatically at loading time, such as clearing the peripheral registers and setting the stack pointer. If the program is to be run on a system without these features, then statements to perform these functions must be added to initialization. The values of DTIME and MAXCNT must be set, based on the computer running the program. DTIME adjusts the program timing to the processor cycle time, and MAXCNT adjusts the terminal driver to the data rate of the terminal in use for output. These values are not very critical, and the program comments list typical values for these constants. As assembled, MORSER assumes a 6820 PIA at addresses 8040-8043 (hexadecimal). The peripheral interface can be relocated to suit the particular hardware configuration in use.

Only one input bit is needed; the rest of the PIA may be used for other functions. The listing also shows that an external subroutine, OUTCRT, is being used to drive a CRT terminal for output. This program is part of Jack Hemenway's system. The user of MORSER must provide a suitable routine for his or her own system. For example, the OUTEEE routine in Motorola's MIKBUG will work. The idea is that some way must be found to take a character from the A accumulator and place it appropriately on the output device. An automatic carriage return and line feed is required, as MORSER does not count the characters in a line.

Initialization also sets up the decoding table DECTAB. The ordering of this table is the heart of MORSER. The ASCII representation of a character is placed in DECTAB at an offset generated as follows: Generate a byte with a binary 1 for every dot and 0 otherwise; generate another byte with a binary 1 for every dash and 0 otherwise. For example, the letter A (Morse • -) generates 00000010 and 00000001 respectively. Multiply the dash byte by two with a left shift and add the bytes. The result is the character offset. Using this algorithm, it is seen that A is at an offset of 4. All other Morse characters are generated in the same manner, and the rest of the table is filled with blanks. It is the function of the remainder of MORSER to convert the incoming audio signal into offsets into DECTAB, and to transfer the character representations found there to the output device.

MORSER decides which inputs are dots, dashes or word spaces by sampling the audio

Listing 1: The MORSER program, as assembled for the 6800 at location 0000 hexadecimal using Jack Hemenway's assembler. The program is written in a relocatable fashion, so no data references are made to page 0 of the 6800 address space. In Jack's assembler, the column immediately following the hexadecimal code output sometimes has the letter "R" in it. This indicates a reference to a relocatable symbol.

input at intervals. The delay timer section controls the period of the sampling. This tiny section of code (only six instructions) actually consumes more than 75% of the running time of MORSER. In fact, the time spent in all other parts of MORSER is considered negligible in the design. A rough "rule of thumb" states that one word per minute of Morse code is equivalent to one dot length per second. All other code elements have lengths nominally equal to integer multiples of the dot length. MORSER is designed to sample each dot length time unit four times. Since the range of code speeds is 3 to 60 words per minute, this implies that the sampling period should

range from 100 to 4 ms. The delay timer is adjusted by DTIME to count time in millisecond intervals. The variable TIMER determines how many milliseconds will be spent in the delay loops. This time is roughly the sampling period, since the longest path through the rest of the program is at most 0.3 ms. TIMER is adjusted in the decoding section to suit the speed of the code being processed. The formula 250/TIMER gives the approximate input code speed in words per minute, after the program has been running for several characters and has adjusted itself to the code.

The sampling section repeatedly tests the status of the audio input signal against its

```

0001 0000 7F 00B5 R BFGIN JMP INIT      FCLIN INITIALIZATION
0002
0003 0003 72F0      *
0004 0003 8040      OUICR1 EGU $72F0 SYSTEM CRT HANDLER
0005 0003 8040      FIA1 EGU $8040 PERIPHERAL LOCATIONS
0006 0003 8040      DDR1 EGU $8040
0007 0003 8041      CKR1 FGU $8041
0008 0003 8042      FIA2 FGU $8042
0009 0003 8043      DDR2 EGU $8042
0010 0003 8043      CKR2 FGU $8043
0011
0012 * AUDIO INFLUT ON SIDE 1, P11 0
0013 0003 0020      PUFF1 RME 32 DFCODED OUTFUT BUFFFF
0014
0015 *
0016 COUNT FCE 0 OUIFUT TIMER
0017 DFLAC FCF $FF "DATA-READY" FLAC
0018 DTIME FCF 66 DELAY LOOP TIMER
0019 * ADJUST DTIME FOR PROCESSOR CYCLP TIME
0020 * DTIME=165 FOR 1-0 USEC PROCESSOR
0021 * DTIME= 88 FOR 2-0 USEC PROCESSOR
0022 * DTIME= 66 FOR 2-5 USEC PROCESSOR
0023 LDATA FCF $FF LAST DATA
0024 LMARK FCF $FF LAST MARK TYPE
0025 LMLEN FCF 12 LAST MARK LENGTH
0026 LTRSF FCF 9 LFTTRF-SPACE LENGTH
0027 MAXCNT FCF 20 TERMINAL CONSTANT
0028 * MAXCNT=40 FOR 110 FAUD OUTFUT TERMINAL
0029 * MAXCNT=20 FOR 300 FAUD OUTFUT TERMINAL
0030 * MAXCNT= 8 FOR FASTFR TERMINAL
0031 MLFN FCF 0 MARK LENGTH
0032 OLDSTA FCF 0 OLD MARK/SPACE STATUS
0033 OUTFCV FCF 0 EUFFFR POINTFR
0034 SPLFN FCF 12 SPACE LENGTH
0035 STLDUI FCF 0 DOT RECLISTFR
0036 STLDAS FCF 0 DASH RECLISTFR
0037 ICNTR FCF 1 TIME COUNTER
0038 TMRFC FCF 20 CLOCK ADJUST VALUE
0039 WDSF FCF 24 WORD-SPACE LENGTH
0040 WDSXCV FCF 0 EUFFFR POINTFR
0041
0042 *
0043 * DFCODING TABLE GENERATED AS FOLLOWS:
0044 * TAKE MARKS CODE FOR CHARACTER...
0045 * GENERATE 6-BIT VALUE, 1=DUI, 0=DASH
0046 * LENFRATE 6-FIT VALUE, 1=DASH, 0=DOT
0047 * SHIFT SECOND VALUE LEFT ONE PLACE
0048 * ADD VALUES...THE RESULT IS THE OFFSET
0049 * OF THAT CHARACTER IN DECIAP
0050 * FLANKS OCCUR WHERE THERE IS NO VALID
0051 * CHARACTER
0052 * HFF: JORGENSEN, HAM RADIO, MAY 72
0053
0054 *
0055 DECIAP FCC ' '
0056 FCC 'ETIANMSURWDKCOHV'
0057 FCC 'F L J F I X C Y Z G '
0058 FCC ' 3 2 16 '
0059 FCC '/ 7 8 9 '
0060 FCC ' '
0061 FCC ' '
0062 FCC ' '
0063 FCC ' '
0064 FCC ' '
0065 FCC ' '
0066 FCC ' '
0067 FCC ' '
0068 FCC ' '
0069 FCC ' '
0070 FCC ' '
0071 FCC ' '
0072 FCC ' '
0073 FCC ' '
0074 FCC ' '
0075 FCC ' '
0076 FCC ' '
0077 FCC ' '
0078 FCC ' '
0079 FCC ' '
0080 FCC ' '
0081 FCC ' '
0082
0083 *
0084 * CONFIGURE PERIPHERAL INTERFACE
0085
0086 INIT LDA A #504
0087 STA A CKR1
0088
0089 *
0090 * END OF INITIALIZATION SECTION
0091
0092 * DFCODING ALGORITHM HAS FIVE RULES:
0093 * 1. IF NEW MARK IS AT LEAST TWICE
0094 * THE LAST ONE, THEN IT IS A DASH
0095 * 2. IF NEW MARK IS LESS THAN HALF
0096 * THE LAST ONE, THEN IT IS A DOT
0097 * 3. IF MARK IS MORE THAN HALF, BUT
0098 * LESS THAN TWICE, IT IS SAME AS
0099 * THE LAST MARK
0100 * 4. IF A SPACE IS MORE THAN 3/4 OF
0101 * LAST DASH LENGTH, IT IS LFTTRF SPACE
0102 * 5. IF A SPACE IS MORE THAN TWICE THE
0103 * LAST DASH LENGTH, IT IS WORD SPACE
0082
0083 *
0084 * HFF: PETL1, CSI, JAN 1971
0085
0086 0084 00FA 7D 0024 R STAK1 I51 DFLAC NEW DATA READY?
0087 0085 00FD 2A 03 FPL J12
0088 0086 00FF 7F 01C5 R JMP WAIT WAIT FOR DATA
0089 0087 00C2 7D 0026 F J10 I51 LDATA LAST DATA MARK OR SPACE?
0090 0088 00C5 2A 03 FPL J11
0091 0089 00C7 7E 0166 R JMP SFACF
0092 0090 00CA E6 0028 F J11 LDA A LMLEN MLFN .CF. 2*LMLEN?
0093 0091 00CD 48 ASL A
0094 0092 00CE E1 002E R CMP A MLEN
0095 0093 00D1 2F 50 FLE DASH
0096 0094 00D3 E6 0028 R LDA A LMLEN MLFN .LT. LMLEN/?
0097 0095 00D6 47 ASR A
0098 0096 00D7 E1 002E R CMP A MLEN
0099 0097 00DA 2A 05 PPL DOT
0100 0098 00DC 7D 0027 R I51 LMARK LAST DATA MARK OR SPACE?
0101 0099 00DF 2E 42 EMI DASH
0102
0103 *
0104 0101 00F1 86 01 DOT LDA A #1
0105 0102 00F3 E7 002F R STA A LMARK PUT DOT INTO RECLISTFR
0106 0103 00F6 E6 002F R LDA A STLDUI
0107 0104 00F9 F6 0030 R LDA B STLDAS
0108 0105 00FC 48 ASL A
0109 0106 00ED 25 6F ECS LENFRK 100 MANY BITS FOR REGISTER
0110 0107 00EF 58 ASL B
0111 0108 00F0 25 6C ECS LENFRK
0112 0109 00F2 4C INC A
0113 0110 00F3 E7 002F R STA A STLDOT
0114 0111 00F6 F7 0030 R STA B STLDAS
0115 0112 00F9 F6 002F R LDA B MLFN RECFNFRATE CLOCK RATE
0116 0113 00FC 00 03 SUE E #3 BASED ON DOT LENGTH
0117 0114 00FE 2C 0D RGE NFAST IF LESS THAN 3, CLOCK SLOW
0118 0115 0100 7A 0032 R DEC TIMER IF MORE THAN 3, CLOCK FAST
0119 0116 0103 2F 0F RCT FUT IF BETWEEN 3 AND 5, 0.K.
0120 0117 0105 7F 0032 R CLR TIMER
0121 0118 0108 7C 0032 R INC TIMER
0122 0119 010F 20 07 ERA PUT
0123 0120 010D C1 02 NFAST CMP B #2
0124 0121 010F 2F 03 FLF FUT
0125 0122 0111 7C 0032 R INC TIMER
0126 0123 0114 F6 0032 R LDA F FUT LIMIT TIMER TO 1-120
0127 0124 0117 C1 78 CMF F #120
0128 0125 0119 2D 02 PFI RFLDAD
0129 0126 011E C6 78 LDA E #120
0130 0127 011D F7 0032 R RFLDAD STA E TIMER
0131 0128 0120 7F 0150 R JMP STORF
0132
0133 *
0134 0130 0123 E6 002E R DASH LDA A MLEN SFT LTRSF=3/4*MLEN
0135 0131 0126 47 ASR A
0136 0132 0127 16 TAF
0137 0133 0128 57 ASH F
0138 0134 0129 1E ABA
0139 0135 012A F7 0029 R STA A LTRSF
0140 0136 012D 86 FF LDA A #FFF PUT DASH INTO REGISTER
0141 0137 012F F7 0027 R STA A LMARK
0142 0138 0132 B6 002F R LDA A STLDOT
0143 0139 0135 F6 0030 R LDA E STLDAS
0144 0140 0138 48 ASL A
0145 0141 0139 25 23 ECS LENFRK 100 MANY BITS FOR REGISTER
0146 0142 0138 58 ASL E
0147 0143 013C 25 20 ECS LENFRK
0148 0144 013F 5C INC B
0149 0145 013F 5C INC B
0150 0146 013F E7 002F R STA A STLDOT
0151 0147 0142 F7 0030 R STA B STLDAS
0152 0148 0145 F6 0030 R LDA A MLEN SFT WDSF=2*MLEN
0153 0149 0148 48 ASL A
0154 0150 0149 2A 02 RFL J12
0155 0151 014B 86 7F LDA A #127
0156 0152 014D E7 0033 R STA A WDSF
0157
0158 *
0159 0153 0150 F6 002E R STORF STA A MLEN
0160 0154 0153 F7 0028 R STA B LMLEN
0161 0155 0156 86 FF RFSF1 LDA A #FFF RESET "DATA-READY" FLAG
0162 0156 0158 E7 002A R STA A DFLAC
0163 0157 0156 7F 01C5 R JMP WAIT
0164
0165 *
0166 0159 015E 7F 002F R LENFRK CLR STLDOT ELIMINATE END DATA
0167 0160 0161 7F 0030 R CLR STLDAS
0168 0161 0164 20 F0 BRA RESET GIVE UP ON CHARACTER
0169
0170 *

```

```

0163 0166 F6 002E R SPACE LDA A SPLFN IS SPLFN .CF. LTRSP?
0164 0169 E1 0029 R CMP A LTRSP
0165 016C 2D FB ELI RFSFT
0166 016E F6 0030 R LDA E SILDAS DECODE LETTER FROM RECS.
0167 0171 C4 3F AND E #53F RESTRICT TO 6 BITS
0168 0173 E6 002F R LDA A SILDOT
0169 0176 84 3F AND A #53F
0170 0178 56 ASL E
0171 0179 1E AFA
0172 017A 84 7F AND A #57F RESTRICT TO 7 BITS
0173 017C CF 0035 R LDX #DFC1AF
0174 017F E7 0183 R STA A INDEX1+1
0175 0182 E6 00 R INDEX1 LDA R 0,X RETRIEVE ASCII CODE
0176 0184 E6 0034 R LDA A WDSXCV BUFFER FULL?
0177 0187 81 26 CMP A #32
0178 0189 2C CE EGE RESET IF SO, PUNT...
0179 018B EF 002D R ADD A OUTXCV GENERATE BUFFER POINTER
0180 018F 84 1F AND A #51F RESTRICT RANGE
0181 0190 7C 0034 R INC WDSXCV
0182 0193 CE 0003 R LDX #HUFF1
0183 0196 E7 019A R STA A INDEX2+1
0184 0199 E7 00 INDEX2 STA E 0,X PUT CHAR. INTO BUFFER
0185 019F 7F 002F R CLR SILDOT CLEAR REGISTERS
0186 019E 7F 0030 R CLR SILDAS
0187 01A1 E6 002E R LDA A SPLFN IS SPLFN .CF. WDSF?
0188 01A4 E1 0033 R CMP A WDSF
0189 01A7 2D AD ELI RESET NOT A WORD SPACE
0190 01A9 F6 0034 R LDA A WDSXCV INSERT BLANK FOR WORD SPACE
0191 01AC 81 20 CMP A #32 IS BUFFER FULL?
0192 01AE 2C A6 EGE RFSFT IF SO, PUNT...
0193 01B0 BE 002D R ADD A OUTXCV GENERATE BUFFER POINTER
0194 01B3 84 1F AND A #51F RESTRICT RANGE
0195 01B5 7C 0034 R INC WDSXCV
0196 01B8 C6 20 LDA E #520 ASCII BLANK CHARACTER
0197 01BA CF 0003 R LDX #HUFF1
0198 01BD F7 01C1 R STA A INDEX3+1
0199 01C0 E7 00 INDEX3 STA E 0,X PUT BLANK INTO BUFFER
0200 01C2 7F 0156 R JMP RFSFT
0201 *****
0202 *
0203 * END OF MAIN PROGRAM
0204 * BEGIN DELAY TIMER
0205 * GENERATE "TIMER" MSFCS. OF DELAY
0206 *
0207 *****
0208 01C5 E6 0032 R WAIT LDA A TIMER
0209 01C8 F6 0025 R DLOOP1 LDA E DTIME
0210 01CF 5A DLOOP2 DEC E
0211 01CC 26 FD BNE DLOOP2
0212 01CE 4A DEC A
0213 01CF 26 F7 BNE DLOOP1
0214 *****
0215 *
0216 * END OF DELAY TIMER
0217 * TEST AUDIO INPUT HERE
0218 * HANDLE OUTPUT TO TERMINAL
0219 *
0220 *****
0221 01D1 E6 8040 LDA A FIA1 CE1 AUDIO INPUT
0222 01D4 84 01 AND A #561 E11 ZERO OF FIA
0223 01D6 E1 002C R CMP A OLDSTA E11=0 IS MARK
0224 01D9 26 10 BNF DIFFER
0225 01DE 7C 0031 R INC TCNTR
0226 01DF 7D 0031 R TST TCNTR OVERFLOW OF TCNTR?
0227 01E1 2C 05 EGE OKAY
0228 01E3 C6 78 LDA E #120 FIX OVERFLOW
0229 01E5 F7 0031 R STA E TCNTR
0230 01E8 7E 021C R OKAY JMP TRANS
0231 *
0232 01FB C6 01 DIFFER LDA E #1 SET "DATA-READY" FLAG
0233 01ED F7 0024 R STA E DFLAC
0234 01F0 F6 0031 R LDA E TCNTR
0235 01F3 7D 002C R TST OLDSTA STORE IFM LENGTH
0236 01F6 26 06 BNF ZERO A MARK OR SPACE?
0237 01F8 F7 002B R STA E MLFN SPACE
0238 01FB 7E 0201 R JMP NMARK
0239 01FE F7 002F R ZERO STA E SPLFN
0240 0201 7D 002C R NMARK TST OLDSTA
0241 0204 26 06 BNE NEWSF
0242 0206 C6 01 LDA E #1 SET LDATA TO OLDSTA
0243 0208 F7 0026 R STA E LDATA -1=SPACE, 1=MARK
0244 020E 7E 0213 R JMP SKIP4
0245 020F C6 FF NEWSF LDA E #5FF
0246 0210 F7 0026 R STA E LDATA
0247 0213 E7 002C R SKIP4 STA A OLDSTA RESET OLDSTA
0248 0216 7F 0031 R CLR TCNTR RESET TIME COUNTER
0249 0219 7C 0031 R INC TCNTR
0250 *
0251 021C E6 0023 R TRANS LDA A COUNT CHECK FOR TERMINAL READY
0252 021F F6 0032 R LDA E TIMER
0253 0222 C1 3C CMP E #60 TRY TO SPEED TERMINAL
0254 0224 2D 01 ELI S1
0255 0226 48 ASL A
0256 0227 E1 002A R S1 CMP A MAXCNT
0257 022A 2C 06 EGE OUTCHK TERMINAL READY
0258 022C 7C 0023 R INC COUNT
0259 022F 7F 00FA R JMP START RETURN TO BEGINNING
0260 *
0261 0232 7F 0023 R OUTCHK CLR COUNT
0262 0235 E6 0034 R LDA A WDSXCV ANY DATA IN BUFFER?
0263 0238 26 03 BNF WDOUT
0264 023A 7F 00FA R JMP START IF NOT, RETURN
0265 023D F6 002D R WDOUT LDA E OUTXCV GENERATE BUFFER POINTER
0266 0240 CF 0003 R LDX #HUFF1
0267 0243 F7 0247 R STA E INDEX4+1
0268 0246 A6 00 INDEX4 LDA A 0,X OUTPUT CHAR. IN ACCUM A
0269 * USE SYSTEM SUBROUTINE TO OUTPUT CHARACTER
0270 JSR OUTCRT
0271 024E 7A 0034 R DEC WDSXCV
0272 024F F6 002D R LDA E OUTXCV
0273 0251 5C INC E
0274 0252 C4 1F AND E #51F RESTRICT RANGE
0275 0254 F7 002D R STA E OUTXCV
0276 0257 7F 00FA R JMP START BACK TO THE BEGINNING
0277 END

```

previously sampled value. If no change is found, the time counter is incremented to indicate the increased length of the signal. If a change is found, then a series of processes are done. The data ready flag is set to tell the decoder that a pulse is complete, the time counter is stored into the mark length or space length variable, the data type (mark or space) is recorded, and the time counter is reset to one. A few notes are in order about sampling. First, the sampler assumes that an input level zero (ground) indicates the presence of an audio tone (mark), and that a one level input (high voltage) indicates no tone (space). This setup coincides with the audio processing hardware described later; but if one wishes to have a one input signify mark instead, only two simple program changes are necessary. Changing the BNE (branch on not equal to zero) instructions on lines 236 and 241 to BEQ (branch on equal to zero) instructions will accomplish the inversion. This illustrates the ease of modifying the system when it is based on a program instead of hardware. One other note: One must protect against overflows of the time counter. This occurs when long marks or long spaces cause the counter value to exceed the maximum value representable as a positive byte. MORSER checks for such occurrences, and resets the time counter to a large positive value whenever an overflow is detected.

We come now to the decoding section. The section is a software version of algorithms abstracted from several hardware designs. It can be described by a set of five decoding rules. The length (time counter value) of the last mark received is used to determine the type of the present mark. The length of the last dash received is used to determine the type of space being received.

- RULE 1. If the new mark length is at least twice the length of the last mark received, then the new mark is a dash.
- RULE 2. If the new mark length is less than one half of the length of the last mark received, then the new mark is a dot.
- RULE 3. If the new mark length is more than one half but less than twice the length of the last mark received, then the new mark is the same type as the old mark was.
- RULE 4. If the new space length is more than 3/4 of the last dash length received, then the new space is a letter space.
- RULE 5. If the new space length is

longer than twice the last dash length received, then the new space is a word space.

Any other space is an element space. These rules determine the processing path of each data item returned by the sampling section. The dots and dashes are stored in memory (STLDDOT and STLDAS) until a letter space is detected. Then the memory contents are converted to an offset in DECTAB, following the process previously described. The character code found in DECTAB is then transferred to the output buffer. The buffer is arranged as a 32 character first in, first out store which allows the decoding to get ahead of the output device for short periods. The detection of a word space causes the latest letter to be decoded and an extra blank character is inserted into the output buffer to provide a space between output words.

The decoding section also adjusts the TIMER value each time a dot is detected. Dots are nominally four samples long. If a dot is declared shorter than three samples, the sampling period is reduced. If a dot is declared longer than five samples, the sampling period is increased. This mechanism helps MORSER to follow changes in code speed during a message or even within characters. The flexibility of the decoding rules will allow code far from the proper timing to be decoded correctly during the adjustment process. Most decoding errors will result either in no character at all being output, or a blank being

substituted for the garbled character. MORSER can handle code with wild speed variations and weightings from 10% to 90%, but it can be fooled by sufficiently erratic code. So too, however, can most human operators.

MORSER uses a programming "trick" in conjunction with indexed addressing to facilitate the decoding and output process. This occurs on lines 174, 183, 198, and 267. The problem is to retrieve or store data at a particular location within a table or buffer. The starting address of the area is known, and the desired offset is calculated each time. MORSER uses the technique of modifying itself during execution. Since the program is stored in programmable memory, it can be changed just as the variables can be changed. In Motorola systems, the second byte of an instruction using indexed addressing stores an offset to be added to the index register contents to generate the final effective address for the instruction. MORSER loads the index register with the beginning of the desired table and then writes the calculated offset into the second byte of the indexed instruction. The processor adds the two, making the desired address. This works well, as long as the program is stored in programmable memory, and one is careful where one writes. If this type of trickery is to be avoided (for example, if the program is to be put into read only memory), the process of adding the offset to the base address must be done explicitly. The following code will perform the function, where X contains the starting address of the table, and accumulator A contains the offset:

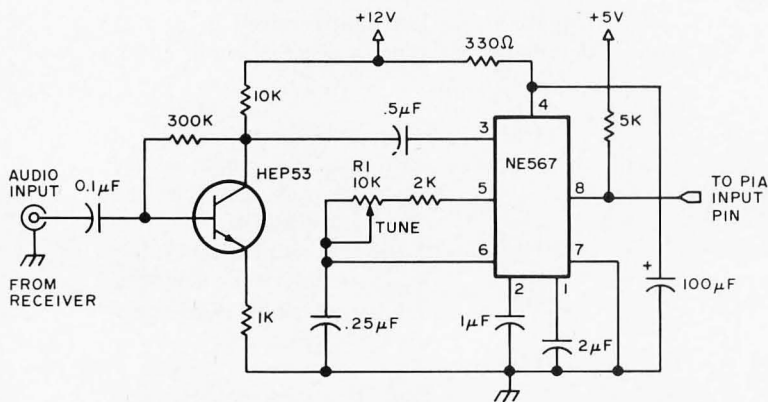

Figure 1: A suggested audio input processing circuit designed to be used with an amateur radio receiver. The tuning adjustment sets the frequency of the signal which is to be interpreted as a dot or dash by the program. The receiver tuning and BFO should be adjusted so that the desired station will have its dots and dashes at the frequency set by R1.

| | | | | |
|--------|-----|---|----------|--|
| INDSAV | RMB | 2 | | Programmable memory area for computation |
| INDEX | STX | | INDSAV | Starting address |
| | PSH | B | | Save contents of B accumulator |
| | CLR | B | | |
| | ADD | A | INDSAV+1 | Add low order part of address with offset in A |
| | ADC | B | INDSAV | Add high order part of address with carry |
| | STA | A | INDSAV+1 | |
| | STA | B | INDSAV | |
| | LDX | | INDSAV | Put effective address into index register |
| | PUL | B | | Restore contents of B accumulator |

The output terminal driver makes use of the delay timer to prevent the program from exceeding the speed capabilities of the output device. A count is kept of the number of delay periods since the last character was sent to the terminal. The value of MAXCNT is set such that MAXCNT delay periods at a 60 words per minute Morse code speed are roughly equal to the recovery period of the terminal in use. If the code speed is less than 30 words per minute, then one half of MAXCNT is used to let the terminal run nearer its full speed. This counting ensures

that the terminal will not receive characters faster than it is capable of handling them. The output buffer helps absorb speed variations. In cases of extreme speed variations with a very slow output terminal, a few characters may be lost. This would require input speeds of over 80 words per minute to be maintained for many characters if one used a 110 baud terminal. It is not likely that the audio processing hardware could switch at this rate, so the characters would be unreliable anyway. All slower speeds could be handled without trouble. The system subroutine used to drive the terminal is called in this section on line 270. It should not use interrupts or any timing loops, since these will upset the timing in MORSER. Since MORSER already does output timing, they are not needed anyway.

That is all there is to the MORSER program. The most critical part of the whole system is the audio input hardware. This circuit needs rapid response (since switching time for 60 words per minute code is about 13 ms), audio selectivity, immunity to noise, and immunity to varying signal levels. No optimum circuit is known by the authors. The circuit shown is a suggestion which shows promise. It uses a 567 phase locked loop tone decoder, tuned to a center frequency of about 1 kHz. The bandwidth is set at approximately 10% of the center frequency, or about 100 Hz. This circuit should switch fast enough for most code speeds, and the phase lock design gives noise immunity, for the circuit will require 10 or more cycles at the correct frequency before it will switch. An input level of about 200 mV seems to give the best immunity from interfering signals and noise. The output rests at +5 V, dropping to near ground when a proper frequency tone is detected. This voltage level is read by the sampler program through the peripheral interface. This signal must be very clean, since variations will probably be decoded as extra dots and dashes. Lots of 'E's and 'T's will indicate a problem in the audio processing.

MORSER works surprisingly well, and it will be able to decode almost anything that its operator can feed it. It does not know English or radio terminology, so it cannot guess what the characters should be. It simply decodes what it "hears," and may not correct some errors that a human would recognize. It does decode the input faithfully, and that can be quite a help. Of course if you use MORSER to listen to a station using automatic code generation technology (on a clear channel) you should get perfect copy once the speed adaptation is complete. ■

IMSAI announces a unique 4K RAM board for just \$139.

Nobody has a 4K RAM board that gives you so much for your money. It's fully compatible with the Altair 8800.

Through the front panel or under software control, you can write protect or unprotect any 1K group of RAM's. Also under software control you can check the status of any 4K RAM board in 1K blocks to determine whether it's protected or not. The board has LED's that clearly show you the memory protect status of each 1K block and which block is active. And there's a circuit provided that will let you prevent the loss of data in the memory if there's a power failure. This low power board has a guaranteed 450 ns cycle time—no wait cycle required. There's nothing like the IMSAI 4K RAM board around.

Dealer inquiries invited.

IMS

IMS Associates, Inc.

IMS Associates, Inc. Dept. B-10
1922 Republic Ave.
San Leandro, CA 94577
(415) 483-2093

Order Your IMSAI 4K RAM Board For
Only \$139. Use BankAmericard,
Master Charge, personal check or
money order.

- Send _____ 4K RAM boards today
- Charge to my credit card
- BAC No. _____
- MC No. _____

Signature _____

Name _____

Address _____

City/State/Zip _____

Efficient Storage of Morse Character Codes

Lawrence Krakauer
15 Orchard Ln
Wayland MA 01778

Since many of BYTE's readers are radio amateurs, a number of whom have expressed an interest in combining computing with their radio hobby, BYTE seems an appropriate place for this short note on a technique for storing Morse character codes in a minimal amount of memory space. It may not be immediately obvious that all of the possible Morse characters, up to six elements per character, can be stored using a maximum of only seven active bits per character stored.

A typical program using such a stored representation would be a programmed automatic keyer. As the user typed at a keyboard, the computer would receive the characters typed in some code (typically ASCII code). The computer would then use this code to index into a table of Morse character codes, retrieving a coded representation of the Morse character to be transmitted. With a suitable interface, the computer could then directly key the radio transmitter. A good program of this type would buffer the user's typing, allowing the

operator to be some large number of characters ahead of the code actually being transmitted.

Another similar program would be a Morse code teaching machine, which could use a programmed pseudorandom number generator to create arbitrary "code groups." Such artificial text is customarily used for Morse code training, so that the student does not recognize words and thus anticipate the next letter to come. The computer in this case would key a practice oscillator, and the student would attempt to accurately receive what it sends. If the student types what he receives directly on the computer keyboard, the computer could notify him immediately of any errors. In addition, the computer could adjust its transmission speed for a fixed error rate, always sending at the upper limit of the student's reception speed, which would hopefully produce rapid learning.

A Morse character is a string of from one to six Morse elements, where each element is a dot or a dash. Since there are only two types of elements, Morse characters seem to

Table 1: Morse Code Patterns and ASCII Equivalents for Selected Graphics.

| Graphic Char | ASCII Code | | Morse Pattern | | | Graphic Char | ASCII Code | | Morse Pattern | | |
|--------------|------------|-------|---------------|-------|----------|--------------|------------|-------|---------------|-------|----------|
| | Hex | Octal | Hex | Octal | Binary | | Hex | Octal | Hex | Octal | Binary |
| A | 41 | 101 | 60 | 140 | 01100000 | W | 57 | 127 | 70 | 160 | 01110000 |
| B | 42 | 102 | 88 | 210 | 10001000 | X | 58 | 130 | 98 | 230 | 10011000 |
| C | 43 | 103 | A8 | 250 | 10101000 | Y | 59 | 131 | B8 | 270 | 10111000 |
| D | 44 | 104 | 90 | 220 | 10010000 | Z | 5A | 132 | C8 | 310 | 11001000 |
| E | 45 | 105 | 40 | 100 | 01000000 | 0 | 30 | 060 | FC | 374 | 11111100 |
| F | 46 | 106 | 28 | 050 | 00101000 | 1 | 31 | 061 | 7C | 174 | 01111100 |
| G | 47 | 107 | D0 | 320 | 11010000 | 2 | 32 | 062 | 3C | 074 | 00111100 |
| H | 48 | 110 | 08 | 010 | 00001000 | 3 | 33 | 063 | 1C | 034 | 00011100 |
| I | 49 | 111 | 20 | 040 | 00100000 | 4 | 34 | 064 | 0C | 014 | 00001100 |
| J | 4A | 112 | 78 | 170 | 01111000 | 5 | 35 | 065 | 04 | 004 | 00000100 |
| K | 4B | 113 | B0 | 260 | 10110000 | 6 | 36 | 066 | 84 | 204 | 10000100 |
| L | 4C | 114 | 48 | 110 | 01001000 | 7 | 37 | 067 | C4 | 304 | 11000100 |
| M | 4D | 115 | E0 | 340 | 11100000 | 8 | 38 | 070 | E4 | 344 | 11100100 |
| N | 4E | 116 | A0 | 240 | 10100000 | 9 | 39 | 071 | F4 | 364 | 11110100 |
| O | 4F | 117 | F0 | 360 | 11110000 | . | 2E | 056 | 56 | 126 | 01010110 |
| P | 50 | 120 | 68 | 150 | 01101000 | , | 2C | 054 | CE | 316 | 11001110 |
| Q | 51 | 121 | D8 | 330 | 11011000 | ? | 3F | 077 | 32 | 062 | 00110010 |
| R | 52 | 122 | 50 | 120 | 01010000 | = | 3D | 075 | 8C | 214 | 10001100 |
| S | 53 | 123 | 10 | 020 | 00010000 | : | 3A | 072 | E2 | 342 | 11100010 |
| T | 54 | 124 | C0 | 300 | 11000000 | ; | 3B | 073 | AA | 252 | 10101010 |
| U | 55 | 125 | 30 | 060 | 00110000 | / | 2F | 057 | 94 | 224 | 10010100 |
| V | 56 | 126 | 18 | 030 | 00011000 | - | 2D | 055 | 86 | 206 | 10000110 |

Note: The representation of Morse characters described in this article is also used by Bruce Filgate in his extensive Morse code applications program described on page 52 of this issue. The information in this table (with some minor changes) is found at addresses 20/225 to 20/366 of listing 1 in Bruce's article.

This table assumes that for machine generated Morse, data is shifted out through the most significant bit with 0 shifted into the low order. This process continues until the binary pattern 10000000 remains in the working memory location. For input, data is shifted in through the LSB. At end of character, a 1 is appended, and the code is left justified.

EXAMPLE

Sending an L

Morse Encoded in binary: 01001000

| Iteration | Data After ASHL A | CY | Morse Out |
|-----------|----------------------|----|--------------|
| 0 | 10010000 | 0 | dot |
| 1 | 00100000 | 1 | dash |
| 2 | 01000000 | 0 | dot |
| 3 | 10000000 | 0 | dot |
| 4 | 00000000 | 1 | end char. |

Figure 1: Flow chart of the SENDCHR routine and the SENDEL routine, used to generate Morse code outputs. The key element of the method is use of an arithmetic left shift operation to interpret the code which is presented to the routine. The codes are determined by a table lookup prior to calling SENDCHR, using an internal table equivalent to table 1. An example of the operation of the routine on a letter L is illustrated.

be a natural for a binary representation, simply letting 0 represent a dot, and 1 represent a dash. The catch is that all of the characters are not the same length, so that the number of elements in the character must also be included in its representation. However, the simple approach of directly including a number giving the length requires too many bits. Since there are up to six elements in a Morse character, we would need six bits for the character elements, plus three bits to represent the length, for a total of nine bits. Since most small computer systems are presently oriented around eight bit bytes, it would be convenient if all the Morse characters could be represented by eight, or fewer, bits each.

Let's try counting. There are two Morse characters of length 1 element (· and —), four characters of length 2 (·· ·— ·— and —·), and so on. So extending this sequence, the total number of possible characters of length six or less is:

$$N = 2 + 4 + 8 + 16 + 32 + 64 = 126$$

Since N is less than $2^7 = 128$, we ought to be able to represent all the Morse characters in seven bits. Perhaps it should be mentioned here that this includes all combinations of up to six elements, including those which do not actually represent legal Morse characters. Since we want a representation which will make it easy to transmit the character, we need a simple form that encodes all arbitrary combinations.

And, indeed, such a simple form exists.

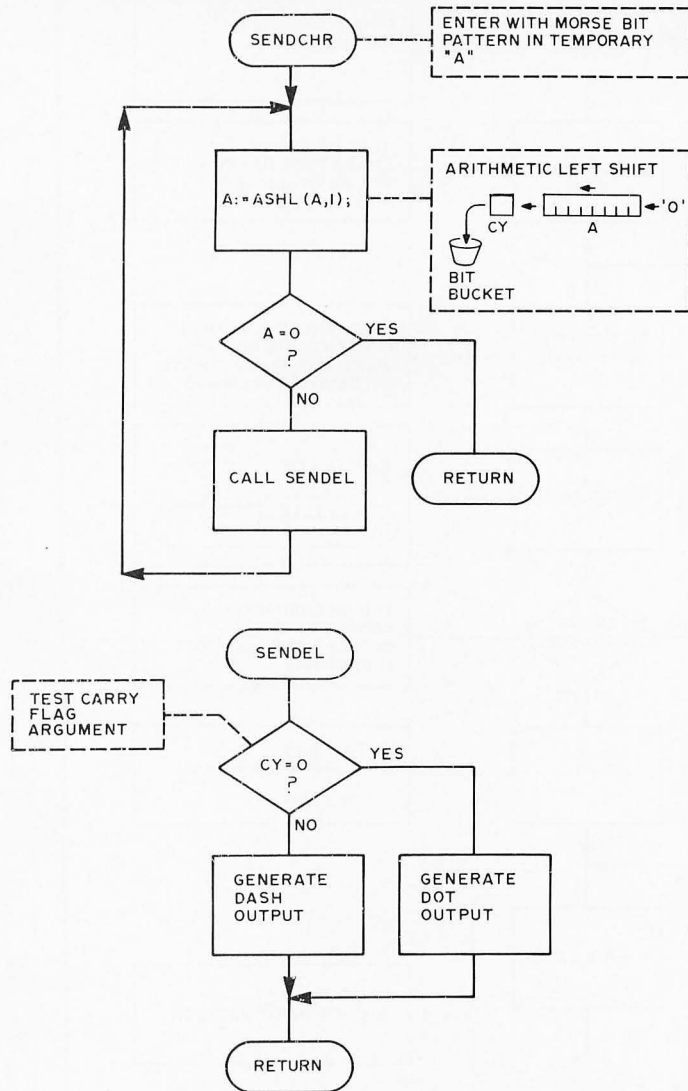

Listing 1: The SENDCHR routine defined as symbolic assembly language for the 6800 and 8080 architecture; (a) shows the 6800 code, and (b) shows the 8080 code. These routines assume that a subroutine called SENDEL (see figure 1) is available which sends either a dot or a dash based on the state of the carry (CY) flag. Since temporary data is maintained in A, SENDEL must not alter the contents of A.

(a) 6800 Code:

| Label | Op | Operand | Commentary |
|----------|------|----------|------------------------------|
| SCHRLOOP | JSR | SENDEL | Send dot or dash; |
| SENDCHR | ASLA | | Entry point and shift left; |
| | BNE | SCHRLOOP | If more data then reiterate; |
| | RTS | | Else return; |

(b) 8080 Code:

| Label | Op | Operand | Commentary |
|---------|------|---------|------------------------------|
| SENDCHR | ADD | A | Shift left by adding A to A; |
| | RZ | | If no data then return; |
| | CALL | SENDEL | Send dot or dash; |
| | JMP | SENDCHR | Reiterate |

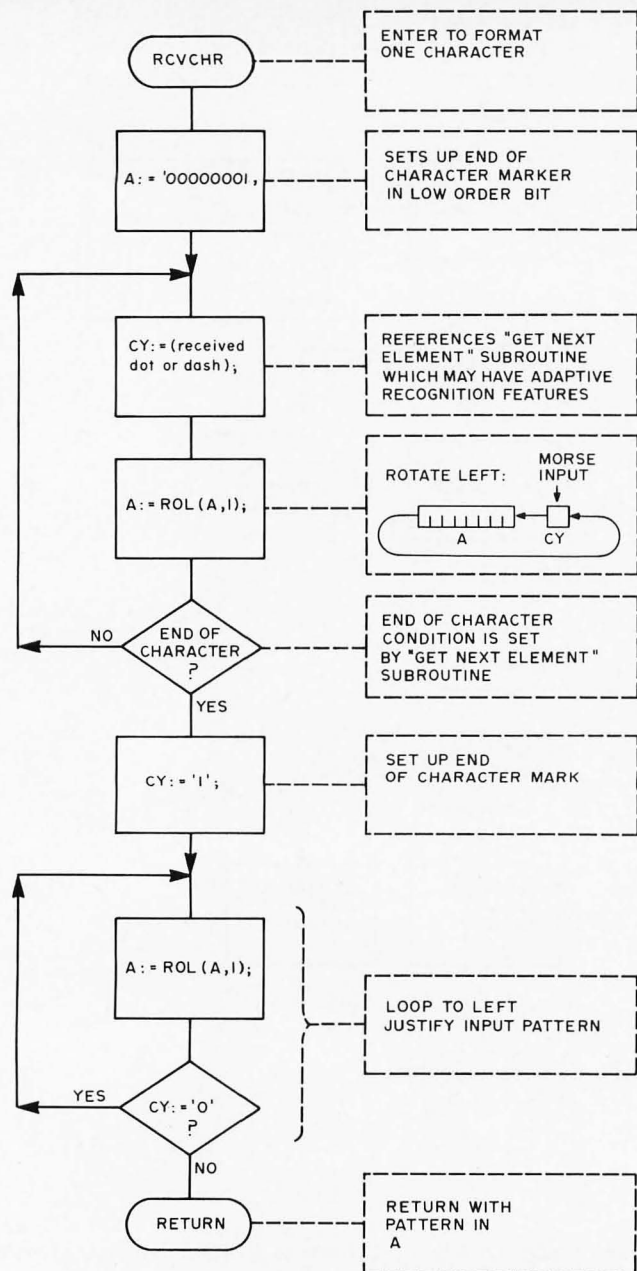

Figure 2: Flow chart of the RCVCHR routine which is used to format incoming dots (binary 0) and dashes (binary 1) into an 8 bit code. Reference is made to a routine loosely described as "get next element" which is used to receive a Morse code element. This "get next element" input routine will have adaptive speed interpretation features required if the program is to be used with hand sent Morse code. After the end of character indication is returned by the input routine, the RCVCHR routine must left justify the code so that it is in the same form as found in the code generation table (see table 1). Control returns with the input code contained in register A.

The Morse character is represented from left to right, one bit per element, using 0 for dot and 1 for dash. At the end of the character, after the last element, a 1 is placed as a stop bit. The remaining bits, if any, are filled out with zeros. Some examples are:

| Character | Morse Code | Binary Representation |
|-----------|------------|-----------------------|
| E | . | 0100000 |
| T | - | 1100000 |
| A | .- | 0110000 |
| L | .-.-. | 0100100 |
| , | -. -.- | 1100111 |
| = | -. -.- - | 1000110 |

Table 1 is a complete list of alphabetic characters, numerals and selected special characters shown as hexadecimal and octal ASCII along with the equivalent hexadecimal, octal and binary code for the Morse pattern. Given the representation, transmission of the character is easy. Working from left to right, simply transmit each bit as a Morse element, until all that remains is a single 1 followed by all zeros, at which point the character has been completed. This operation is easily done using the "rotate" or "shift" instructions of the typical microcomputer. A flow chart for this procedure is given in figure 1. It is so simple that it reduces to only a four line subroutine in a typical microprocessor. Listing 1a gives a suggested program for the Motorola 6800 and listing 1b gives a program for the Intel 8080 (or 8008). These programs use an eight bit representation, which can express a code of up to seven elements, although no seven element characters are actually used in the Morse code.

Note that there are two binary representations which represent the null character; that is, they result in the subroutine returning without transmitting anything at all. These are the codes 00000000 and 10000000. If desired, they could be specially decoded. For example, one of them could be used to represent the special Morse character, which is used as a delete character. It would have to be transmitted as a special case, since it contains eight elements. If the all zero code were to be used for this purpose, it could be tested for by a branch-on-zero instruction at the subroutine entry point.

The representation proposed here is also easy to build up while receiving Morse code. A receive subroutine flow chart is given in figure 2.

The possibilities inherent in the combination of small computers and amateur radio are enormous. The challenging task of machine reception of hand sent code is now receiving much more attention due to the low cost of microprocessors. The possibilities of computer station control, amateur radio data communications networks, and microprocessor control of repeaters have barely begun to be explored. The large number of radio amateurs who are now beginning to experiment with small computers should produce some rather interesting results in the near future. ■

altair 8800bTM

TECHNICAL INFORMATION

The ALTAIR 8800b computer is a general purpose byte-oriented machine (8-bit word). It uses a common 100-pin bus structure that allows for expansion of either standard or custom plug-in modules. It supports up to 64K of directly addressable memory and can address 256 separate input and output devices. The ALTAIR 8800b computer has 78 basic machine language instructions and is comprised of a power supply board, an interface board, a central processing unit (CPU) board, and a display/control board.

Power Supply Board

The Power Supply Board provides two output voltages to the ALTAIR 8800b computer bus, a positive and negative 18 volts. It includes a bridge rectifier circuit and associated filter circuit, a 10-pin terminal block connector, and the regulating transistors for the positive and negative 18 volt supplies.

Interface Board

The Interface Board buffers all signals between the display/control board and the ALTAIR 8800b bus. It also contains eight parallel data lines which transfer data to the CPU from the Display/Control board.

CPU Board

The CPU board controls and processes all instruction data within the ALTAIR 8800b computer. It contains the model 8080A microprocessor circuit, the master timing circuit, eight input and eight output data lines to the ALTAIR bus, and control circuits.

Display/Control Board

The Display/Control Board conditions all ALTAIR 8800b front panel switches and receives information to be displayed on the front panel. It contains a programmable read only memory (PROM), switch and display control circuits, and control circuits to condition the CPU.

NEW DESIGN FEATURES

Several new design features have been incorporated into the electronic and mechanical areas of the ALTAIR 8800b computer. Some of the new design features include additional front panel capabilities, redesigned power supply, and various electronic and mechanical design advancements.

New Front Panel Switches

Five new front panel switch positions have been added to the ALTAIR 8800b computer to expand the front panel capability.

1. SLOW position: Permits execution of a program at a rate of approximately 2 machine cycles per second or slower. The normal machine speed is approximately 500,000 machine cycles per second. The ALTAIR 8800b operates in the slow mode as long as the SLOW switch is depressed on the front panel.
2. DISPLAY ACCUMULATOR position: Displays the contents of the CPU accumulator register on the ALTAIR 8800b front panel.
3. LOAD ACCUMULATOR position: Loads the information present on the lower eight front panel address switches into the CPU accumulator register.
4. INPUT ACCUMULATOR position: Inputs the information present at an Input/Output device into the CPU accumulator register. The Input/Output device is selected on the upper eight front panel address switches.
5. OUTPUT ACCUMULATOR position: Outputs the contents of the CPU accumulator register to a selected input/output device. The input/output device is selected on the upper eight front panel address switches.



New Power Supply

The new power supply in the ALTAIR 8800b contains an 8 volt, 18 ampere tapped secondary supply which permits the addition of up to 16 printed circuit cards, and pre-regulated positive and negative 18 volt, 2 ampere supplies. A multiple tapped primary transformer provides for 110/220 volt operation and a 50/60 Hz operation.

Electronic Design Advancements

The electronic design advancements on the ALTAIR 8800b are in the CPU and front panel circuit boards.

1. CPU. The new CPU circuit board uses the Intel 8224 clock generator integrated circuit (IC). The 8224 IC provides a specified clock frequency to the ALTAIR 8800b using an external crystal and dividing the crystal frequency down to 2MHz. Therefore, both the clock pulse widths and phasing (as well as frequency) are crystal controlled.
2. Front Panel. All front panel data lines are connected to an interface which buffers them from the rest of the ALTAIR 8800b. The front panel circuits also use a programmable read only memory (PROM) which contains programs for the following eight functions:
EXAMINE
EXAMINE NEXT
ACCUMULATOR DISPLAY
ACCUMULATOR LOAD
DEPOSIT
DEPOSIT NEXT
INPUT ACCUMULATOR
OUTPUT ACCUMULATOR

The front panel circuits also have a wiring option which allows the CPU to perform a complete instruction cycle or a single machine cycle during the single step or slow operation.

Mechanical Design Advancements

The mechanical design advancements on the ALTAIR 8800b are incorporated for ease of assembly and maintenance.

1. The wiring harness connection which exists on the front panel of the ALTAIR 8800 is replaced with ribbon cables. These ribbon cables connect the front panel circuits to the interface circuits.
2. The four slot expander cards in the ALTAIR 8800 have been replaced by a single piece 18-slot motherboard. The 18-slot motherboard contains 100 solder lands which comprise the 100 pin bus.
3. A new multi-color and redesigned dress panel is used in the ALTAIR 8800b. The front surface of the dress panel has a protective sheet of mylar to insure that the graphics are not rubbed or scratched off.

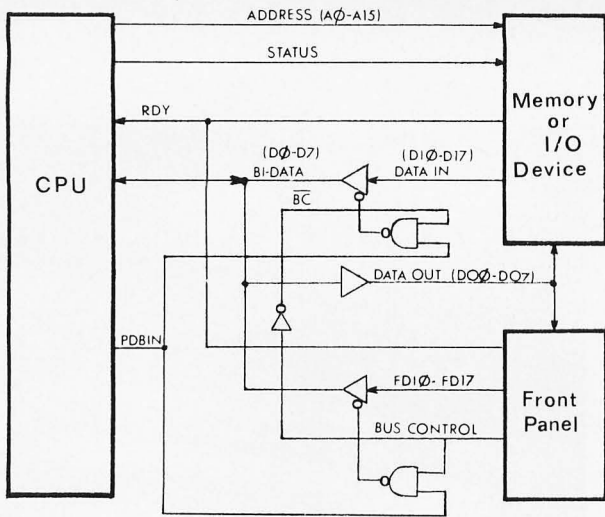

8800b BLOCK DIAGRAM

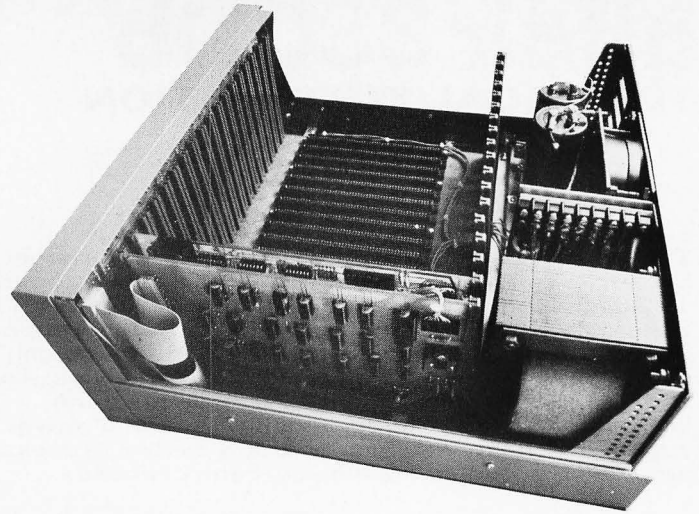

COMPATABILITY

8800b BLOCK DIAGRAM DESCRIPTION

The 8800b computer contains four main circuits: a Central Processing Unit (CPU), a Memory, an Input/Output (I/O), and a Front Panel. The CPU controls the interpretation and execution of software instructions, and the Memory stores the software information to be used by the CPU. The I/O provides a communication link between the CPU and external device. The Front Panel allows the operator to manually perform various operations with the 8800b. The 8800b block diagram description explains: A) the communication between the CPU and the memory or I/O circuits; and B) the communication between the CPU and the front panel.

CPU to Memory or I/O Operation

The Memory or I/O operation requires several main signals which allow for transfer of data to and from the CPU. The ADDRESS (A0-A15) signal consists of sixteen individual lines from the CPU to the Memory or I/O device. This signal represents a particular memory address location or external device number which is needed to establish communications with the Memory or I/O Device. Once the ADDRESS (A0-A15) data is presented to the Memory or I/O device, the CPU generates various STATUS signals. The STATUS signals either enable decoding of a memory address, or they condition the I/O device card to send or receive data from the CPU.

Data from the Memory or I/O device is presented on the DATA IN (D10-D17) lines and applied to eight non-inverting bus drivers. The drivers are enabled by a PDBIN signal from the CPU and a BC (bus control) signal. The BC signal is LOW when the Front Panel is not in operation. The eight non-inverting bus drivers, when enabled, present the input data to BI-DATA (D0-D7) lines which apply the data from the Memory or I/O device to the CPU.

Data to the Memory or I/O device is presented on the DATA OUT (D00-D07) lines from the BI-DATA (D0-D7) lines from the CPU. The RDY (ready) line either forces the CPU to a wait state while data is being transferred or allows the CPU to process data.

Front Panel Operation

The Front Panel Operation is very similar to the Memory or I/O operation. The Front Panel gains control of the CPU by producing a HIGH BC signal. The BC signal disables the DATA IN (D10-D17) lines from a Memory or I/O device and enables the FDI0-FD17 lines. The FDI0-FD17 lines contain Front Panel data which is transferred to the CPU upon the occurrence of the PDBIN signal. All data from the CPU to the Front Panel is applied to the DATA OUT (D00-D07) lines and displayed on the Front Panel.

Compatibility

All of the current 8800 software is compatible with the 8800b, and all the current plug-in circuit boards are compatible, with the exception of the 8800a CPU Board.

Memory Cards

1. 4K Dynamic RAM Memory Board
2. 4K Static RAM Memory Board
3. 16K Static RAM Memory Board
4. PROM Memory Board

Interface Cards

1. Serial Interface Board
2. Parallel Interface Board
3. Audio-cassette Interface Board
4. Disc Controller Board

| ALTAIR 8800b Specifications | |
|---|-----------------------|
| Number of Boards | Up to 18 |
| Microprocessor | |
| Model | 8080A |
| Technology | NMOS |
| Data Word Size, Bits | 8 |
| Instruction Word Size, Bits | 8 |
| Clock Frequency | 2M Hz |
| Add Time, Register to Register, Microsec. Per Data Word | 2 |
| Number of Instructions | 78 |
| Input/Output Control | |
| I/O Word Size, Bits | 8 |
| Number of I/O Channels | 256 |
| Direct Memory Access | Optional |
| Interrupt Capability | Std. |
| Vectored Interrupt (8 priority levels) | Optional |
| Software | |
| Resident Assembler | Yes |
| Higher-level Language | BASIC |
| Monitor or Executive | Sys. Mon.; text edit. |
| Complete Software Library Separately Priced | Yes |



2450 Alamo S.E. / Albuquerque, New Mexico 87106

Software Bug of the Month 5

Private Preston's Folly

Private Prescott Preston, Proud yet Prudent Programmer, is running his first sort routine, and it's a mess. See if you can straighten him out.

Private Preston has an array called PR, containing 50 elements. He reads in some data in unsorted fashion. The idea of the sort routine is to test whether two adjacent elements are in order. If they're out of order, they are interchanged.

A flag K is kept to tell whether any changes have been made in the current pass through the array PR (from beginning to end). If *no* changes have been made, we are done, because the table is now sorted (remember we've gone through the entire array). Whenever a change is made, however, the flag K is set. If the flag ever gets set, we have to make another pass through the array, and we keep on doing this until the array is sorted.

The program Private Preston wrote looked like this:

- Step 1: Set K equal to zero.
- Step 2: Set I equal to 1.
- Step 3: If PR(I) is less than or equal to PR(I+1), then go to Step 7.
- Step 4: Set K equal to one.
- Step 5: Set PR(I) equal to PR(I+1).
- Step 6: Set PR(I+1) equal to PR(I).
- Step 7: Set I equal to I + 1.
- Step 8: If I is unequal to 50, go to Step 3.
- Step 9: If K is equal to zero, go to Step 1.

I won't even bother telling you what language that routine was written in. The first few times, of course, it had compilation errors. Now it compiles, but it still doesn't work. Why not? ■

Solution in Next Month's BYTE

SOLUTION TO BUG OF THE MONTH 4

Did you try $N = 1$? Good for you. One of the surest ways a program like this can fail is in the low order cases. Unfortunately (for you), $N = 1$ works just fine. We discover that 1 is not a multiple of 2, and then we quit. So 1 is a prime number.

Now did you try $N = 2$?

You did? I think you saw this one somewhere before.

In fact, for $N = 2$ — and only for $N = 2$ — this program has a bug. It says that 2 is not prime, because 2 is a multiple of 2, when in fact it is prime.

How should the bug be fixed? One simple way, of course, is to test N for being less than 4; if it is, then it is prime. But this adds unnecessary inefficiency in what we shall presume are the bulk of our cases, namely $N \geq 4$. The real trouble is that we are using a "FORTRAN loop" — that must be executed at least once — rather than an "ALGOL loop" that might be done zero times. Thus, when $N = 2$, the first value of I, namely 2, is already larger than the maximum value, namely the square root of 2, and so no cases should be tested. We can make this into an ALGOL loop by putting a statement number — say 3 — on the last IF statement, and then writing GO TO 3 just before statement number 1.

There is one further acceptable answer. Suppose that we called PRIME(L, L). This does make sense; we are testing L to see if it is prime, and then, after we test, setting L equal to either zero or one. Unfortunately, the first thing that PRIME does is to set $K = 1$, which sets L equal to 1 (if parameters are called by reference). In other words, the program is now testing whether 1 is prime, not whether L is prime. This can be fixed by moving the statement $K = 1$ (which is otherwise perfectly good) down to the end of the program, just before the second RETURN statement. ■

W Douglas Maurer
University Library Room 634
George Washington University
Washington DC 20052

Only \$59.95
Assembled
Tested

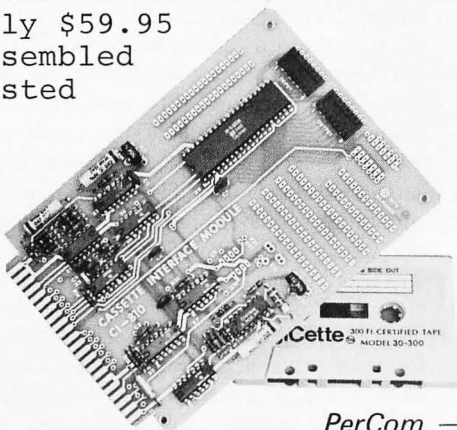

FINALLY - A CASSETTE INTERFACE THAT WORKS! The **PerCom** CI-810

- Easily connected to any computer
- An 8-bit parallel interface
- 'Kansas City' Standard
- Load a 1k byte program in 40 seconds
- Little or no software required
- Easily upgraded to 218 byte/sec
- Operate 2 tape units simultaneously
- 18 page Instruction Manual

PerCom Data Co.

4021 Windsor, Garland, Texas 75042

(214) 276-1968

PerCom — 'peripherals for personal computing'



If Only Sam Morse Could See Us Now

Wayne Sewell WB5NYC
9277 LBJ #253
Dallas TX 75243

When dealing with personal computers, it is necessary for a person to be familiar with his machine from both the hardware and software point of view. It has been my observation that hardware people often tend to stay in hardware and software people in software, each faction learning just enough about the other side to get along. I am guilty of this myself — I never do in hardware what could feasibly be done in software. Hopefully, this situation will change as my knowledge of microcomputing increases, but for the time being I am assuming that the computer runs because of the little elves pushing electrons around in the processor and putting most of my effort into programming.

This article is for people with a similar bent. There are several electronic Morse code keyers on the market, but rather than spend precious cash, why not use that little digital demon of a small computer that you paid all of that money for. You've probably been

trying to find a valid use for it anyway. Think of the glory as you transmit a message in Morse code several hundred characters long at a speed of 1000 wpm. (While there is a legal speed limit for radio Teletype, to my knowledge Morse Code bandwidth is not explicitly mentioned in FCC regulations.) Then comes a real challenge: Find someone whose computer can receive at that speed. Finally, the ultimate goal: Read the response sent back to you at the same speed. [See articles by Robert Grappel and Jack Hemenway, by Bruce Filgate, and by Lawrence Krakauer in this issue.]

This article describes a software Morse code generator. The program listed is for a 6800 system (specifically the one sold by Southwest Technical Products); but a complete description of the generator is included to facilitate conversion to other systems.

Data Format

The data format used in my Morse code generator makes it possible to pack any of the "dot" and "dash" combinations associated with a Morse code character into a single byte. The rightmost 5 or 6 bits (throughout this article, "rightmost" and "least significant" are synonymous) contain the pattern of dots and dashes, and the upper 2 or 3 bits contain a count which informs the program how many of the data bits are actually associated with the character. The remaining bits are set to zero arbitrarily. Out of all of the characters in international Morse code, there are only two which will not work in this system: space and the error code. It is not surprising that the space is a maverick in any data representation, since it is not really data at all, but a lack of data. It is simply a lengthening of the normal interval between characters to form an interval between words, and must be handled as a special case. Similarly, the error code is not really a character either.

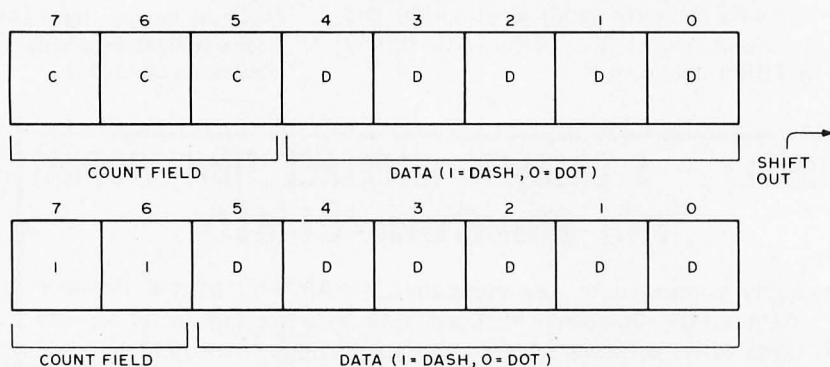

Figure 1: Data Formats. The number of ways to represent data within a computer can sometimes be equated to the number of programmers there are in the world. Here is another way to represent Morse codes internally, which differs from several other articles in this issue. The format is supported by table 3 which lists the equivalent hexadecimal codes for each Morse code graphic.

When an error is made during a Morse transmission, due to a spasmodic twitch of the operator's hand or similar cause, the errant operator sends a string of 8 dots, meaning: "Oh I'm sorry I made an error please disregard the last character I sent please will you huh." Both the space and the error code, since they don't fall in the normal scheme of things, are treated as special cases: Immediately upon detection, the program intercepts them, modifies them to a compatible format, and inserts them back into the main logic flow.

For all characters five elements long or less, the format is absurdly simple, as shown in figure 1a. The high order 3 bits contain a binary number from 1 to 5 corresponding to the number of dots and/or dashes in the character. The rightmost 5 bits contain the data elements themselves, where 0 is a dot and 1 is a dash. They are stored from right to left so that when the byte is shifted to the right, they are transmitted serially in the proper sequence. As an example, the Morse code character Q is transmitted as "- - . -". The element count is four, so a binary 100 string is stored in the leftmost 3 bits of the byte. Using the coding scheme above, the equivalent Morse bit pattern for Q (the binary string 1011) is stored in the rightmost 4 bits. In this case, bit 4 is not needed so it is a "don't-care" bit which is set to zero arbitrarily. Therefore, the code for Q stored in the table is the binary string 10001011 or hexadecimal 8B.

If all Morse code characters contained five elements or less, the coding system would be much simpler. However, many of the special characters, uncooperative cusses that they are, contain six elements. At first glance, this doesn't seem to be an obstacle, since the 3 bit count field can contain a

binary number up to 7, inclusive. However, there are only 5 bits left over within the byte, which means that although the count can keep track of more than five elements, there is no place to store them. The one fact that keeps the entire system from collapsing into a pile of random logic is that there are no characters with seven elements. There are several special codes with six elements, but I have been unable to come up with one containing seven. Since the difference between a count of six, the binary string 110, and a count of seven (111) is one bit; and since there will never be a count of seven, then bit 5 becomes a "don't-care" and can be used as a data bit if bits 6 and 7 are both 1. We simply consider any count greater than five (leftmost 2 bits on) to be equal to six, shift our wild card bit right with the others, and the problem is solved, as seen in figure 1b. When the count is extracted in this case, bit 5 is forced to a zero, making the count equal to six.

When Morse transmission actually starts, the data bits are shifted right one at a time. If the rightmost bit is a zero, the weight factor for a dot is loaded; if the rightmost bit is equal to 1, the dash weight factor is loaded, normally exactly three times that of a dot. The key is turned on, and the timing subroutine, controlled by the value stored in ELESPEED, generates the proper delay for that element. The key is then turned off and the timing subroutine is reentered, this time to generate the space between elements, normally equal to a single dot time. This loop is repeated for every element in the character, shifting right each time. The space between elements is added to the last element in the character, also.

If a string of characters is being transmitted, rather than a single character, the

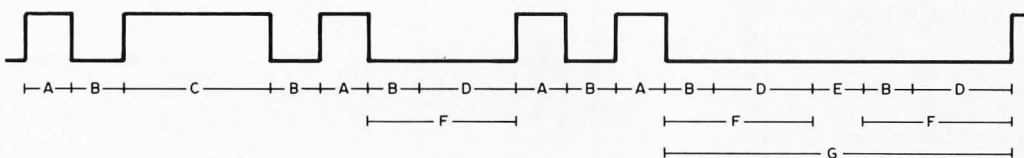

| Time Interval | Explanation |
|---------------|---|
| A : | Dot, key on; basic timing element; duration is number of milliseconds contained in ELESPEED. |
| B : | Space between elements, key off; duration is one dot; also controlled by ELESPEED; generated automatically after every dot or dash. |
| C : | Dash, key on; duration is three times dot in normal weighting. |
| D : | Character space synchronizer, key off; generated automatically after every character; added to B to form total space (F) between characters; duration is twice the dot interval for normal spacing but can be increased for greater character separation; controlled by CHRSPEED. |
| E : | Space character (ASCII hexadecimal 20), key off; duration is one dot; added to character space (F) before and after to form total space (G) between words. |
| F : | Space between characters, key off; duration is B + D; if ELESPEED and CHRSPEED are synchronized this is equal to three dots; if not, duration is longer. |
| G : | Space between words, key off; duration = twice F plus one dot; if ELESPEED and CHRSPEED are synchronized, this is equal to seven dots; if not, duration is longer. |

Figure 2: Time Relationships. The Morse characters R1 sent in succession, followed by a space. The intervals identified by capital letters are explained in the notes below.

Listing 1: CWBUFFER
 Subroutine. This listing
 gives the complete absolute
 hexadecimal assembled
 code and symbolic repre-
 sentation for the
 CWBUFFER routine. Data
 in this listing was prepared
 using the author's SPUCA
 assembler program.

| LOC | CODE | STMT | SOURCE STATEMENT | |
|------|----------|------|------------------|--------------------------------------|
| 0040 | | 67 | CHRSPEED RMB 2 | # OF MILLISECDS BETWEEN CHARACTERS |
| 0042 | | 68 | ELESPEED RMB 2 | LENGTH OF ELEMENT (DIT) DURATION |
| | | 69 | * | IN MILLISECDS |
| 0044 | | 70 | INITMASK RMB 1 | OSCILLATOR CONTROL BYTE |
| 0045 | | 71 | HOLDBYTE RMB 1 | |
| 0046 | | 72 | MASK RMB 1 | |
| 0047 | | 73 | COUNT RMB 1 | |
| 0048 | | 74 | CWPTR RMB 2 | POINTS TO 1ST BYTE IN STRING |
| 0100 | | 75 | ORG H'100 | |
| 0100 | | 76 | CWBUFFER EQU * | |
| 0100 | A6 00 | 77 | LDAA I,0 | GET CHAR |
| 0102 | 81 03 | 78 | CMPA #3 | IS THIS THE STOP BYTE? |
| 0104 | 26 01 | 79 | BNE CONTINUE | BR IF NO |
| 0106 | 39 | 80 | RTS | RETURN |
| 0107 | | 81 | CONTINUE EQU * | |
| 0107 | 08 | 82 | INX | INCR PTR |
| 0108 | DF 48 | 83 | STX CWPTR | STORE POINTER |
| 010A | 8D 08 | 84 | BSR TRANSMIT | CONVERT THE CHAR TO CW AND TRANSMIT |
| 010C | DE 40 | 85 | LDX CHRSPEED | LOAD DELAY CONSTANT FOR CHAR SPACING |
| 010E | 8D 46 | 86 | BSR MILDELAY | DELAY PROPER # OF MILLISECDS |
| 0110 | DE 48 | 87 | LDX CWPTR | GET ADDR OF CHAR STRING |
| 0112 | 20 EC | 88 | BRA CWBUFFER | GET NEXT CHAR |
| 0114 | | 89 | TRANSMIT EQU * | |
| 0114 | 8D 5C | 90 | BSR CHARTOCW | CONVERT CHAR TO CW TRANSMIT CODE |
| 0116 | 4D | 91 | TST A | A = 0 ? |
| 0117 | 26 06 | 92 | BNE NOTSPACE | BR IF NO (VALID NON-BLANK CW CHAR) |
| 0119 | C6 01 | 93 | LDAB #1 | SET NUMBER OF ELEMENTS AT 1, AND |
| 011B | D7 47 | 94 | STAB COUNT | MAKE THE WEIGHT SAME AS A DIT |
| 011D | 20 25 | 95 | BRA SPACENT | BYPASS KEY-ON INSTRUCTION |
| 011F | | 96 | NOTSPACE EQU * | |
| 011F | 16 | 97 | TAB | SAVE A IN B |
| 0120 | | 98 | RPT 4 | |
| 0120 | 59 | 99 | ROL B | ROTATE BIT COUNT |
| 0121 | 59 | 100 | ROL B | ROTATE BIT COUNT |
| 0122 | 59 | 101 | ROL B | ROTATE BIT COUNT |
| 0123 | 59 | 102 | ROL B | ROTATE BIT COUNT |
| 0124 | C4 07 | 103 | ANDB #7 | SET COUNT AT < OR = 7 |
| 0126 | 81 FF | 104 | CMPA #'FF | IS THIS SPECIAL ERROR CODE ? |
| 0128 | 26 04 | 105 | BNE NOTERR | BR IF NOT |
| 012A | 4F | 106 | CLR A | SET DATA TO ALL DITS |
| 012B | 5C | 107 | INC B | INCR COUNT FROM 7 TO 8 |
| 012C | 20 06 | 108 | BRA COUNTOK | STORE COUNT |
| 012E | | 109 | NOTERR EQU * | |
| 012E | C1 06 | 110 | CMPB #6 | BIT COUNT = 6 ? |
| 0130 | 2D 02 | 111 | BLT COUNTOK | BR IF NO |
| 0132 | C4 06 | 112 | ANDB #6 | SET COUNT AT 6 |
| 0134 | | 113 | COUNTOK EQU * | |
| 0134 | D7 47 | 114 | STAB COUNT | STORE BIT COUNT |
| 0136 | | 115 | BITLOOP EQU * | |
| 0136 | D6 44 | 116 | LDAB INITMASK | INITIALIZE THE |
| 0138 | D7 46 | 117 | STAB MASK | OSCILLATOR MASK |
| 013A | C6 01 | 118 | LDAB #1 | LOAD WEIGHT FACTOR FOR DIT |
| 013C | 46 | 119 | ROR A | ROTATE DATA BIT INTO CARRY |
| 013D | 24 02 | 120 | BCC SEND | BR IF CARRY CLEAR (DIT) |
| 013F | C6 03 | 121 | LDAB #3 | LOAD WEIGHT FACTOR FOR DAH |
| 0141 | | 122 | SEND EQU * | |
| 0141 | 73 00 45 | 123 | COM HOLDBYTE | TURN ON KEY |
| 0144 | | 124 | SPACENT EQU * | |
| 0144 | 8D 22 | 125 | BSR ELDELAY | GENERATE DELAY FOR ELEMENT LENGTH |
| 0146 | 7F 00 46 | 126 | CLR MASK | CLEAR OSCILLATOR MASK |
| 0149 | 7F 00 45 | 127 | CLR HOLDBYTE | TURN OFF KEY |
| 014C | C6 01 | 128 | LDAB #1 | LOAD WEIGHT FACTOR FOR BREAK |
| | | 129 | * | BETWEEN ELEMENTS |
| 014E | 8D 18 | 130 | BSR ELDELAY | GENERATE DELAY FOR ELEMENT LENGTH |
| 0150 | 7A 00 47 | 131 | DEC COUNT | LAST ELEMENT IN CHAR ? |
| 0153 | 26 E1 | 132 | BNE BITLOOP | BR IF NO |
| 0155 | 39 | 133 | RTS | RETURN |
| 0156 | | 134 | MILDELAY EQU * | |
| 0156 | D6 46 | 135 | LDAB MASK | HOLD THE KEY OUTPUT CONSTANT |
| 0158 | D8 45 | 136 | EORB HOLDBYTE | AND FLIP-FLOP THE |
| 015A | D7 45 | 137 | STAB HOLDBYTE | OSCILLATOR OUTPUT IF |
| 015C | F7 80 04 | 138 | STAB L,H'8004 | KEY IS ON |
| 015F | C6 8F | 139 | LDAB #'8F | LOAD MILLISECOND LOOP CONSTANT |
| 0161 | | 140 | LOOP2 EQU * | |
| 0161 | 5A | 141 | DEC B | COUNT DOWN |
| 0162 | 26 FD | 142 | BNE LOOP2 | BR IF NOT FINISHED |
| 0164 | 09 | 143 | DEX | DECR MILLISECOND COUNT |
| 0165 | 26 EF | 144 | BNE MILDELAY | BR IF NOT FINISHED |
| 0167 | 39 | 145 | RTS | RETURN |
| 0168 | | 146 | ELDELAY EQU * | |
| 0168 | DE 42 | 147 | LDX ELESPEED | LOAD DELAY CONST FOR ELEMENT SPACING |
| 016A | 37 | 148 | PSHB | SAVE # OF INTERVALS |
| 016B | 8D E9 | 149 | BSR MILDELAY | DELAY PROPER # OF MILLISECDS |
| 016D | 33 | 150 | PULB | RESTORE # OF INTERVALS |
| 016E | 5A | 151 | DEC B | DECR # OF INTERVALS |
| 016F | 26 F7 | 152 | BNE ELDELAY | BR IF NOT FINISHED |
| 0171 | 39 | 153 | RTS | |
| 0172 | | 154 | CHARTOCW EQU * | |
| 0172 | 84 7F | 155 | ANDA #'7F | STRIP PARITY BIT |
| 0174 | 80 20 | 156 | SUBA #32 | SUBTRACT OFFSET |
| 0176 | 2D 17 | 157 | BLT INVALAS | IF INVALID CHAR OR = 0 BRANCH OUT |
| 0178 | 81 40 | 158 | CMPA #LASTASCW | CHARACTER IN TABLE ? |
| 017A | 2C 0D | 159 | BGE NOTFNDAS | BR IF NO |
| 017C | | 160 | GETENTRY EQU * | |
| 017C | 5F | 161 | CLR B | ALLOCATE AND ZERO OUT |
| 017D | 37 | 162 | PSHB | A TEMPORARY 2-BYTE AREA ON |
| 017E | 37 | 163 | PSHB | TOP OF THE STACK |
| 017F | 30 | 164 | TSX | POINT INDEX REGISTER TO IT |
| 0180 | A7 01 | 165 | STAA I,1 | STORE TABLE OFFSET INTO SECOND BYTE |
| 0182 | EE 00 | 166 | LDX I,0 | LOAD CONSTRUCTED POINTER INTO INDEX |
| 0184 | A6 00 | 167 | LDAA I,0 | LOAD CW CODE |
| 0186 | 31 | 168 | INS | DELETE TEMPORARY HOLD AREA |
| 0187 | 31 | 169 | INS | & REALIGN STACK |
| 0188 | 39 | 170 | RTS | RETURN |
| 0189 | | 171 | NOTFNDAS EQU * | |
| 0189 | 80 20 | 172 | SUBA #32 | POINT TO LOWER CASE CHARS |
| 018B | 81 20 | 173 | CMPA #'20 | BETWEEN UPPER & LOWER CASE ? |
| 018D | 2E ED | 174 | BGT GETENTRY | BR IF NO (USE LOWER CASE AS UPPER) |
| 018F | | 175 | INVALAS EQU * | |
| 018F | 4F | 176 | CLR A | SET A TO CW NULL |
| 0190 | 39 | 177 | RTS | RETURN |

Figure 3: Output Signals from the Morse code generation program. This program will produce either or both of a tone burst "oscillating" output which can be used to drive a speaker for code practice, or a steady logic level output (during each dot or dash) used to control the keyer of a typical radio frequency transmitter.

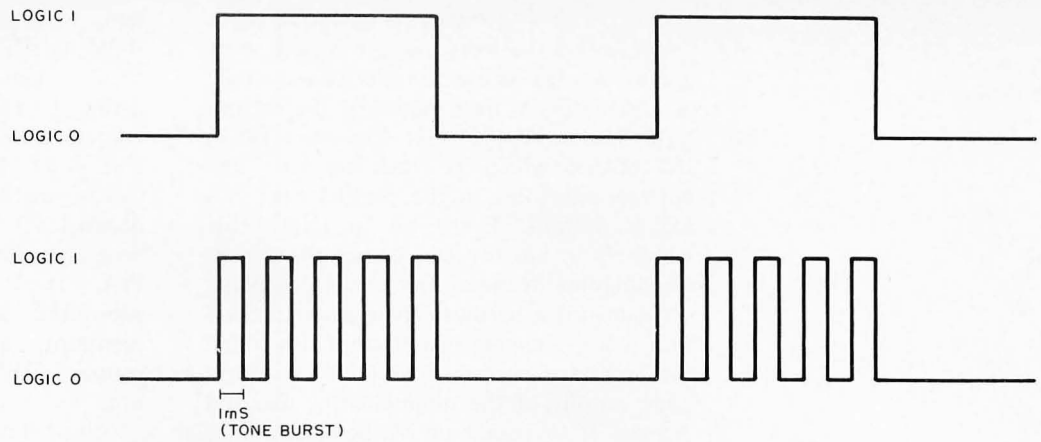

space between them is generated according to the value stored at location CHRSPEED. If element and character speeds are synchronized, the delay caused by CHRSPEED is exactly twice the space between elements, which has already been generated after the last element. Combining the two causes the total space between characters to be exactly the length of a dash, the established spacing between Morse code characters (see figure 2).

If a space (in ASCII, hexadecimal 20) is detected, it is treated as a phantom character consisting of one dot length with the key off. When added to the 3 dot interval following the previous character, and the equal interval following itself, a total interval of 7 dot times is generated, the standard spacing between words. (ASCII codes with no Morse code equivalents are also treated as spaces.)

Speed Control

There are two separate controls for Morse code spacing: element speed and character speed. The element speed is the time duration of the smallest element of the Morse pattern. The time duration of dashes, dots, and the breaks in between are based upon it. If normal weighting is used, a dot is equal to one of these intervals, a dash is equal to three of them, and the space between dots and dashes within a character is equal to a single dot interval. The 2 byte field labelled ELESPEED contains a 16 bit binary number specifying the element delay as an integer number of milliseconds. With normal weighting, the duration of a dot will be exactly the number of milliseconds contained in ELESPEED, and the duration of a dash will be exactly three times that.

If you wish the element and character speeds synchronized (20 wpm characters sent at 20 wpm intervals, etc), the binary value stored in CHRSPEED should be exactly double the binary value stored in ELE-

SPEED. In this configuration the program will generate perfectly synchronized Morse code according to the established standard (dash duration three times that of dot, duration of space between elements equal to one dot, duration of space between characters equal to that of one dash, and duration of space between words seven times that of one dot). When you change speeds, change the values of ELESPEED and CHRSPEED (once again, the value of the latter should be twice the value of the former.)

If you wish to lengthen the interval between characters without changing their internal speed, simply increase the value of CHRSPEED. For instance, if you wish to practice copying code, you can set the ELESPEED field at the value for 20 wpm and the CHRSPEED field to the 5 wpm value. This will cause 20 wpm characters to be sent at 5 wpm intervals. You can tweak either speed to any 16 bit value you want (except zero), but the value of CHRSPEED must *never* be equal to less than two times that of ELESPEED or the spacing will be demolished!

And It Comes Out Here

The Morse code generator program is designed to output the Morse signals through a parallel IO port. Two different types of output are available simultaneously: logical and oscillating. The logical output corresponds to the Morse signal as it is broadcast — the output is high during a dot or dash and low in the times between. This corresponds to the telegraph key itself and may be fed to the transmitter directly or via a relay or other driver. The oscillating output changes state once every millisecond while the logical output is high and is held low during the times the logical output is low. This output, when connected to a speaker, produces a 500 Hz tone and can be used as a sidetone or a code practice oscillator. Both types of output can be

produced simultaneously, as seen in figure 3.

Which of the lines in your parallel port are to be used at logical outputs and which are oscillators is determined by the control byte labelled INITMASK. For every bit in INITMASK which is equal to zero, the corresponding bit in the parallel port is a logical output. Every bit in INITMASK which is in an on state causes the corresponding line in the output port to oscillate.

I am not a hardware type person; therefore, I am not going to attempt describing the interface necessary to take the Morse code output of the nonoscillating line and transfer it to your ham rig, especially since every transmitter has its own keying system. In a classic copout I say, "It is up to the user to take the logical output of the PIA (0=key off, +5V=key on) and get it onto the air without blasting the PIA output driver."

Viva Southwest Tech

This Morse data generator was written for a Southwest Technical Products 6800 sys-

tem, which uses the Motorola MC6830L7 ROM (MIKBUG Revision 9). A complete cross assembly of CWBUFFER is printed in listing 1. The program was written to be configuration independent, however, and will work for any 6800 system having programmable memory at locations hexadecimal 00 to 49, at least 190 bytes of programmable memory elsewhere, and one PIA. The ASCII to Morse conversion subroutine is completely relocatable and reentrant, although the main generator routines (CWBUFFER and TRANSMIT) are not.

All of the timing loops are calibrated for the Southwest Technical Products System, which has a 1.797 MHz master oscillator crystal. If your clock runs at a different speed, you may want to tweak the loop constant so that the output of one of the oscillating lines is exactly 500 Hz (each outer loop of the MILDELAY subroutine is supposed to last exactly one millisecond). The loop constant is at hexadecimal location 0160; incrementing or decrementing it by

Listing 2: Various and Sundry Drivers. Three different driver routines occupy the remainder of the assembled code prepared by the author. These drivers are ASDRIVER, SINGLECH, and CODEPRAC. ASDRIVER is used to load a buffer, then call CWBUFFER to transmit the data as Morse signals. SINGLECH is a simple routine to read a character from the keyboard then call the TRANSMIT subroutine (bypassing CWBUFFER) to output that character as its Morse equivalent. CODEPRAC is a routine used to generate a random series of Morse data for code practice. (Note that the instruction at 01D5 should be patched to reference a random number routine specific to your own computer system.)

| LOC | CODE | SI MT | SOURCE STATEMENT |
|------|----------|-------|------------------|
| 0191 | | 178 | ASDRIVER EQU * |
| 0191 | 7F 00 45 | 179 | CLR HOLDBYTE |
| 0194 | 7F 80 04 | 180 | CLR H'8004 |
| 0197 | CE 01 F7 | 181 | LUX #BUFFER |
| 019A | | 182 | LOADLOOP EQU * |
| | | 183 | ; |
| | | 184 | ; |
| 019A | BD E1 AC | 185 | JSR H'E1AC |
| | | 186 | ; |
| | | 187 | ; |
| | | 188 | ; |
| | | 189 | ; |
| 019D | A7 00 | 190 | STAA I+0 |
| 019F | 08 | 191 | INX |
| 01A0 | 81 03 | 192 | CMPA #3 |
| 01A2 | 27 10 | 193 | BEQ NONEED3 |
| 01A4 | H1 0A | 194 | CMPA H'10A |
| 01A6 | 27 08 | 195 | BEQ SENDIT |
| 01A8 | H1 08 | 196 | CMPA H'108 |
| 01AA | 26 EE | 197 | MNE LOADLOOP |
| 01AC | 09 | 198 | BEA |
| 01AD | 09 | 199 | BEA |
| 01AE | 20 EA | 200 | BRA LOADLOOP |
| 01B0 | | 201 | SENDIT EQU * |
| 01B0 | 86 03 | 202 | LVA #3 |
| 01B2 | A7 00 | 203 | STAA I+0 |
| 01B4 | | 204 | NONEED3 EQU * |
| 01B4 | CE 01 F7 | 205 | LUX #BUFFER |
| 01B7 | BD 01 00 | 206 | JSR CWBUFFER |
| 01BA | 20 05 | 207 | BRA ASDRIVER |
| 01CA | | 215 | CODEPRAC EQU * |
| 01CA | 7F 00 45 | 216 | CLR HOLDBYTE |
| 01CD | 7F 80 04 | 217 | CLR H'8004 |
| 01D0 | CE 01 F7 | 218 | LUX #BUFFER |
| 01D3 | DF 46 | 219 | STX CWPTR |
| 01D5 | | 220 | GENLOOP EQU * |
| 01D5 | BD 00 00 | 221 | JSR 0--0 |
| | | 222 | ; |
| 01D8 | 36 | 223 | PSHA |
| 01D9 | BD 01 72 | 224 | JSR CHARTRCW |
| 01DC | 32 | 225 | PULA |
| 01DD | 27 F6 | 226 | BEQ GENLOOP |
| 01DF | DE 48 | 227 | LUX CWPTR |
| 01E1 | A7 00 | 228 | STAA I+0 |
| 01E3 | 08 | 229 | INX |
| 01E4 | DF 46 | 230 | STX CWPTR |
| 01E6 | 8C 7F FF | 231 | GPA #BUFFEND |
| 01E9 | 26 EA | 232 | BNE GENLOOP |
| 01EB | 86 03 | 233 | LVA #3 |
| 01ED | A7 00 | 234 | STAA I+0 |
| 01EF | CE 01 F7 | 235 | LUX #BUFFER |
| 01F2 | BD 01 00 | 236 | JSR CWBUFFER |
| 01F5 | 20 03 | 237 | BRA CODEPRAC |
| 01F7 | | 238 | BUFFER EQU * |
| 7FFF | | 239 | BACK EQU H'7FFF |
| 7FFF | | 240 | BUFFER EQU * |

Table 1: Speed Control Values. CWBUFFER uses a 16 bit value, taken from this table, to control the basic number of milliseconds spent in each dot interval of the generated code, and each inter character interval. For standard Morse, the values loaded from the CHRSPEED column should be double the value of the corresponding ELESPEED entry of a given code speed. By increasing the CHRSPEED values, the spacings between characters can be lengthened while preserving the timing relationships for the data rate loaded into ELESPEED. These values are calculated assuming the Southwest Technical Products 6800 system is being used. For other processors with different rates for the master oscillator, a new table would have to be calculated.

| Morse code rate (wpm) | Value Loaded into ELESPEED (hexadecimal) | Value Loaded into CHRSPEED (hexadecimal) |
|-----------------------|--|--|
| 5 | 00D6 | 01AC |
| 10 | 006B | 00D6 |
| 15 | 0047 | 008E |
| 20 | 0035 | 006A |
| 25 | 002B | 0056 |
| 30 | 0024 | 0048 |
| 35 | 001F | 003E |
| 40 | 001B | 0036 |
| 50 | 0015 | 002A |
| 60 | 0012 | 0024 |
| 70 | 000F | 001E |
| 80 | 000D | 001A |
| 90 | 000C | 0018 |
| 100 | 000B | 0016 |
| 200 | 0005 | 000A |
| 500 | 0002 | 0004 |
| 1000 | 0001 | 0002 |

one will increase or decrease the interval which should correspond to a millisecond by six machine cycles. If you aren't concerned with perfect timing, you can compensate by loading different values into ELESPEED and CHRSPEED.

The parallel port address used in the program corresponds to the serial control interface used by MIKBUG, which is really a parallel interface that only simulates a serial interface via software. Connect a small 8 ohm speaker between connections RO and GND on the serial control interface. (Your computer will probably be unable to talk to the TVT or Teletype while the speaker is attached, due to loading problems.) In the program turn on the rightmost bit in INITMASK to produce the oscillating output.

There is only one output line normally available from the PIA on the Southwest Technical Products serial control interface, although it separates into two output systems, RS-232 and 20 mA current loop. Another line on the PIA's A side is used for MIKBUG input, which leaves six lines completely unused. These lines can be used for Morse output if you bring them out via jumpers from the backside of the PIA. Of course, MIKBUG has designated them as inputs in the A side data direction register; but if you OR a hexadecimal 7E into the DDR, you will reset them as outputs and leave the normal MIKBUG lines alone. You can use any combination of those lines for Morse output.

Sundry Drivers

The Morse Code generator program is designed to be used as a subroutine. It simply takes a character or string of characters in memory and outputs the Morse code equivalents. It is completely up to the user

as to how this data is input, whether through the keyboard, read from tape, generated by a random number generator, or conjured up by evil spirits. All that is required is that the Morse code routine's controls (ELESPEED, CHRSPEED, and INITMASK) be set before the subroutine is entered, and, if the CWBUFFER entry point is used, that the index register contains the address of the first byte of the string and the stop byte, hexadecimal 03, follows immediately after the last byte of the string.

I have included three simple drivers which could be used for the 6800: one that generates one Morse character at a time from

Table 2. Special Codes and ASCII Graphics. There are several special case codes used in radio communications with Morse code. These are listed at the left with a short explanation. At the right are shown the ASCII character graphics and hexadecimal codes used by CWBUFFER to represent these special case codes.

| To send: | Keyboard Entry |
|--|---|
| \overline{SK} End of work | '#' ASCII hexadecimal 23 |
| \overline{BT} Break | '&' ASCII hexadecimal 26 |
| \overline{AR} End of Message | '\$' ASCII hexadecimal 24 |
| \overline{KN} Invitation to transmit, specified station only | '+' ASCII hexadecimal 2B |
| \overline{AS} Wait | '=' ASCII hexadecimal 3D |
| ERROR CODE (8 dots) | { '!' ASCII hexadecimal 21 or { DEL ASCII hexadecimal 7F |

the keyboard; a second that buffers characters until a delimiter character (line feed) is encountered, after which it sends out the characters it has stored in one brilliant blast of precision keying; and a third driver which fills up a buffer with random characters, then sends them out (for code practice). These drivers are shown as listing 2.

The single character driver (SINGLECH) lies dormant until a character is entered from the keyboard. When the character is received, it is passed immediately to TRANSMIT and the Morse code is sent out the PIA. The driver then goes back to sleep until a new character comes in.

The buffered driver loads incoming characters into a buffer in memory until either a line feed or ETX (Control C, hexadecimal 03) character is encountered. When either is received the starting address is loaded into the index register, a delimiter (ETX) is stored in the buffer after the last data byte; and the buffer is passed to

CWBUFFER, which outputs the CW codes in a continuous stream until the end of the buffer is reached. Control then returns to the driver, which starts loading the buffer all over again. When a backspace command (Control H, hexadecimal 08) is received, the character immediately preceding the command is deleted from the buffer.

CODEPRAC, the code practice program, fills a buffer in memory with random characters, then passes them to CWBUFFER, which sends them out the PIA into your speaker (hopefully you have set INITMASK so that the line is an oscillating output). The speed and spacing are controlled by whatever you have loaded into ELESPEED and CHRSPED.

This code practice application is where the dual speed controls really come into play. When a person is first learning code, he obviously has to start at an extremely low character rate. At this speed, the dots and dashes are extremely dragged out and sound

Table 3: ASCII to Morse Conversion Table. This table lists the relative offset, data, assembly language text, ASCII equivalent graphics and ASCII hexadecimal codes (H'xx' for code xx) for each character recognized and generated by CWBUFFER. To find the Morse encoded value of each ASCII graphic, subtract hexadecimal 20 from its ASCII hexadecimal value, add the difference to the first address location of ASCWTABL (0 in this assembly) and use the 16 bit result as the address of the desired Morse equivalent. Information in this table was prepared using the author's "SPUCA" cross assembler.

| LOC | CODE | STMT | SOURCE STATEMENT |
|------|------|------|-------------------------|
| 0000 | | 1 | ASCWTABL EQU * |
| 0000 | 00 | 2 | FCBE B'00000000' |
| 0001 | FF | 3 | FCBE B'11111111' |
| 0002 | D2 | 4 | FCBE B'11010010' |
| 0003 | E8 | 5 | FCBE B'11010000' |
| 0004 | AA | 6 | FCBE B'10101010' |
| 0005 | 00 | 7 | FCBE B'00000000' |
| 0006 | B1 | 8 | FCBE B'10110001' |
| 0007 | DE | 9 | FCBE B'11011110' |
| 0008 | ED | 10 | FCBE B'11101101' |
| 0009 | ED | 11 | FCBE B'11101101' |
| 000A | 00 | 12 | FCBE B'00000000' |
| 000B | AD | 13 | FCBE B'10101101' |
| 000C | F3 | 14 | FCBE B'11110011' |
| 000D | E1 | 15 | FCBE B'11100001' |
| 000E | EA | 16 | FCBE B'11101010' |
| 000F | A9 | 17 | FCBE B'10101001' |
| 0010 | BF | 18 | FCBE B'10111111' |
| 0011 | BE | 19 | FCBE B'10111110' |
| 0012 | BC | 20 | FCBE B'10111100' |
| 0013 | B8 | 21 | FCBE B'10111000' |
| 0014 | B0 | 22 | FCBE B'10110000' |
| 0015 | A0 | 23 | FCBE B'10100000' |
| 0016 | A1 | 24 | FCBE B'10100001' |
| 0017 | A3 | 25 | FCBE B'10100011' |
| 0018 | A7 | 26 | FCBE B'10100111' |
| 0019 | AF | 27 | FCBE B'10101111' |
| 001A | C7 | 28 | FCBE B'11000111' |
| 001B | D5 | 29 | FCBE B'11010101' |
| 001C | 00 | 30 | FCBE B'00000000' |
| 001D | A2 | 31 | FCBE B'10100010' |
| 001E | 00 | 32 | FCBE B'00000000' |
| 001F | CC | 33 | FCBE B'11001100' |
| 0020 | 00 | 34 | FCBE B'00000000' |
| 0021 | 42 | 35 | FCBE B'01000010' |
| 0022 | 81 | 36 | FCBE B'10000001' |
| 0023 | 85 | 37 | FCBE B'10000101' |
| 0024 | 61 | 38 | FCBE B'01100001' |
| 0025 | 20 | 39 | FCBE B'00100000' |
| 0026 | 84 | 40 | FCBE B'10000100' |
| 0027 | 63 | 41 | FCBE B'01100011' |
| 0028 | 80 | 42 | FCBE B'10000000' |
| 0029 | 40 | 43 | FCBE B'01000000' |
| 002A | 8E | 44 | FCBE B'10001110' |
| 002B | 65 | 45 | FCBE B'01100101' |
| 002C | 82 | 46 | FCBE B'10000010' |
| 002D | 43 | 47 | FCBE B'01000011' |
| 002E | 41 | 48 | FCBE B'01000001' |
| 002F | 67 | 49 | FCBE B'01100111' |
| 0030 | 86 | 50 | FCBE B'10000110' |
| 0031 | 8B | 51 | FCBE B'10001011' |
| 0032 | 62 | 52 | FCBE B'01100010' |
| 0033 | 60 | 53 | FCBE B'01100000' |
| 0034 | 21 | 54 | FCBE B'00100001' |
| 0035 | 64 | 55 | FCBE B'01100100' |
| 0036 | 88 | 56 | FCBE B'10001000' |
| 0037 | 66 | 57 | FCBE B'01100110' |
| 0038 | 89 | 58 | FCBE B'10001001' |
| 0039 | 8D | 59 | FCBE B'10001101' |
| 003A | 83 | 60 | FCBE B'10000011' |
| 003B | ED | 61 | FCBE B'11101101' |
| 003C | 00 | 62 | FCBE B'00000000' |
| 003D | ED | 63 | FCE B'11101101' |
| 003E | 00 | 64 | FCBE B'00000000' |
| 003F | FF | 65 | FCBE B'11111111' |
| 0040 | | 66 | LASTASCW EQU *-ASCWTABL |

| | | | | | | | | | |
|----------|------|----------|------|----------|------|----------|------|----------|------|
| ASCWTABL | 0000 | LASIASCW | 0040 | CHRSPEED | 0040 | ELESPEED | 0042 | INITMASK | 0044 |
| HOLDBYTE | 0045 | MASK | 0046 | COUNT | 0047 | CWPTR | 0048 | CWBUFFER | 0100 |
| CONTINUE | 0107 | TRANSMIT | 0114 | NOTSPACE | 011F | NOTERR | 012E | COUNTOK | 0134 |
| BITLOOP | 0136 | SEND | 0141 | SPACENT | 0144 | MILDELAY | 0156 | LOOP2 | 0161 |
| ELDELAY | 0168 | CHARTUCW | 0172 | GETENTRY | 017C | NOTFNDAS | 0189 | INVALAS | 018F |
| ASDRIVER | 0191 | LOADLOOP | 019A | SENDIT | 01B0 | NONEED3 | 01B4 | SINGLECH | 01BC |
| SINGLOOP | 01C2 | CODEPRAC | 01CA | GENLOOP | 01D5 | BUFFER | 01F7 | BUFFEND | 7FFF |

Table 4: Label Table. This table, also prepared with the author's cross assembler, gives the address (hexadecimal) for each symbol in CWBUFFER and the sundry driver programs.

completely different than they do at higher speeds. The Morse code neophyte should really learn to recognize the characters by listening to the total pattern, not by counting dots and dashes. However, speeding up the characters also speeds up the character rate if normal element to space ratios are maintained and an entire message has gone by while the beginner is still trying to recognize the first character. Therefore, the ideal situation is to retain the sound of the high speed characters and yet increase the interval between them. This is accomplished by leaving the element speed (ELESPEED) the same and increasing the duration of time between characters (CHRSPEED) to whatever length is desired.

Anyway, to get back to the code practice driver, it will continue to send characters at the CHRSPEED rate until the end of the buffer is reached, at which time it will generate another set of practice characters. Unfortunately, the random number generation routine itself is missing. The code practice driver was a last minute addition, and there was not time to develop one. (The program was tested using a kluge substitution.) However, there are several different versions floating around. The one you use should generate a one byte random number and return it in accumulator A. It should not destroy accumulator B or the index register. Load the address of the routine in the dummy jump to subroutine at hexadecimal location 01D5. The address at location 01E7 is the end of buffer address or your maximum memory location. Don't forget to leave a place for the random number generator subroutine.

The drivers in this article are very primitive, and are designed simply to get you running. If your system is a Southwest Tech one, you should be able to load all of the programs and the table into your system exactly as coded (CODEPRAC too, with the addition of a random number routine), connect a speaker between RO and ground on the control interface, load ELESPEED and CHRSPEED according to table 1, turn on the rightmost bit of INITMASK, branch to the starting address of the driver of your choice, and start typing. As you hear the speaker sing a 500 Hz aria with perfect 1 to 3 to 7 spacing, you may reflect that maybe

programmers aren't such bad guys after all. Seriously, the sidetone output is a perfect way to ensure that the program is working with each of the various drivers before you try to tie it into your rig.

Other 6800 Systems

For non Southwest Tech 6800 systems, the installation of the Morse generator program is not much more difficult. The address of the PIA used for the Morse code output and that of the input routine are the primary concerns. If your system uses MIKBUG, which has the single character input routine at hexadecimal location E1AC and the serial control interface at hexadecimal 8004, so much the better — you shouldn't have to modify a single byte. If your configuration is different, substitute your own PIA address at hexadecimal locations 015D, 0195, 01C0, and 01CE, and your ASCII input routine address at locations 01C3 and 019B.

The programs in this article were not assembled on Motorola's assembler. They were run on SPUCA (Sewell's Psychedelic Universal Cross Assembler), a homemade cross assembler which runs on the IBM 370 and generates code for the 6800 and four other microprocessors. Listings 1 and 2, and tables 3 and 4 were generated by SPUCA.

The formats are almost identical, but there are some minor differences that should be pointed out for the sake of clarity. The major difference is in instructions using the indexed mode of addressing. Motorola places the symbol for the index register (X) after the operand with a comma in between, where SPUCA looks for an I *before* the operand, again with a comma in between. In other words, a Motorola indexed instruction looks like this: LDA A OPERAND,X and one read in by SPUCA is in this format: LDAA I,OPERAND. In addition, the programmer must specify explicitly whether direct (base page, one byte address) or extended (two byte) addressing is to be used. If the extended addressing is to be used, the operand must be preceded by an L, (for Long). Example: LDAA L,OPERAND.

Most of the rest of the instructions are identical to Motorola's except that my assembler has no FCC (Form Constant Characters) directive and no separate column for the accumulator ID.■

In addition to the ADM-3 Dumb Terminal Kit we now offer you the complete ADM-SERIES



ADM-2

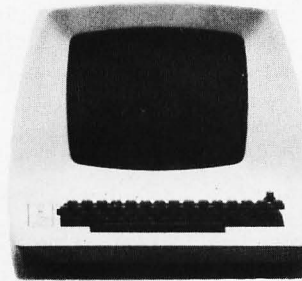

ADM-3

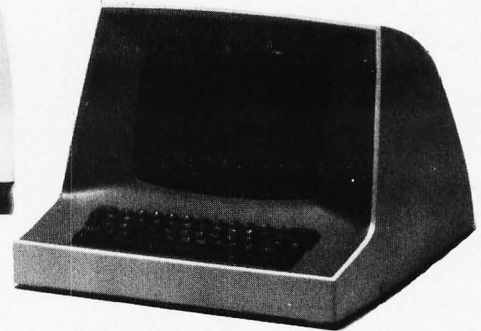

ADM-1

ADM-1 FEATURES

DISPLAY FORMAT: 960 characters arranged in 80 characters per line by 12 lines.
OPTIONAL SCREEN SIZE: 1920 characters on a 12" screen, 80 characters per line by 24 lines.

SCREEN: 12-inch Diagonal, P4 Phosphor. Etched face plate.

CHARACTER SET: 64 Alphanumeric USASCII characters.

CHARACTER FONT: 5 x 7 Dot Matrix.

CURSOR: Reverse Image (Block Cursor).

CURSOR CONTROLS: Skip, Backspace, Forespace, Down, Return, New Line, Up, Home, Read Cursor, and Cursor Addressing.

EDITING FEATURES: Clear Screen, Overstrike, and Absolute Cursor Addressing/Read.
FIELD PROTECT: Screen formatting of protected and unprotected fields displayed in dual intensity.

KEYBOARD: 60-Key TTY Standard configuration with cursor control keys, Tab, Home, and Clear keys.

INTERFACE: RS-232 point-to-point.

Data Rates — 110, 300, 600, 1200, 1800, 2400, 4800, 9600.

Parity — Even, odd, one, or zero.

EDIT OPTION: Character insert and delete, line insert and delete (when not in protected mode), clear to end of line/field/page, back tab, and message mode transmission.

OPTIONAL: Numeric 10-key pad with return and decimal.

TRANSMISSION OPTIONS: Polling-addressing, and RS-232 extension.

OPTIONAL: Serial Printer output.

SIZE: 12" high x 16" wide x 21" long.

LOGIC CARD SIZE: 19.2" x 13.3"

WEIGHT: 45 pounds.

POWER REQUIREMENTS: 115 Vac, 60Hz, 100 watts.

ADM-2 FEATURES

- Full 128 ASCII character set
- 1920 Character display
- 8 Transmission rates
- 16 Function keys for 32 commands
- 8 Status displays on the screen
- 5 Mode keys lighted
- 5 Block transmission modes
- Separate Keyboard — 118 keys
- 10-Key Numeric keyboard
- 5 Separate cursor control keys
- Dynamic control of Conversation/Block mode
- Program mode
- Single key edit operations
- Page, field, or line edit
- Security fields
- Protected fields
- Blinking fields
- Dual intensity
- Field tab
- Column tab
- Cursor addressing & cursor read
- Repeat: Repeat from the keyboard is 15 characters per second when a key is held down.
- Control Characters: Control characters are entered in memory if program mode is on or if they are preceded by ESCAPE.
- Interface: RS-232C point-to-point
 - Optional 20mA current loop
 - Optional RS-232C extension (multidrop)
 - Optional RS-232C to a printer
- Size: 12" high x 20" wide x 24" long
- Weight: 50 pounds.
- Power 115 VAC, 60 Hz, 120 watts.

ADM-3 FEATURES

- Full- or half-duplex operation at selectable data rate (75, 110, 150, 300, 600, 1200, 1800, 2400, 4800, 9600, or 19,200 baud)
- 20mA current loop and EIA standard RS-232C interfaces
- Extension RS-232C interface port for hard copy printer, magnetic tape recorder or additional data terminals
- 59-key keyboard
- Bright, high contrast characters displayed in the familiar 5 x 7 dot matrix
- Bottom line data entry with upward page scroll
- End-of-line audible tone
- Options:
 - 24-line display
 - Numeric keypad
 - "Answer Back" capability
 - Independently selectable Transmit and receive rates

Data Entry

New data enters on bottom line of screen; line feed causes upward scrolling of entire display with top-of-page overflow. Automatic new line switch selectable

Refresh Rate

60 Hz standard; 50 Hz with input power option
 Switch selectable

- Compact size: 15½" x 19" x 12½"
- Weight: 25 pounds.
- Power 115 VAC, 70 watts.

SYNCHARO

STEP UP TO DEC

THE COMPLETE MICROPROCESSOR SYSTEM

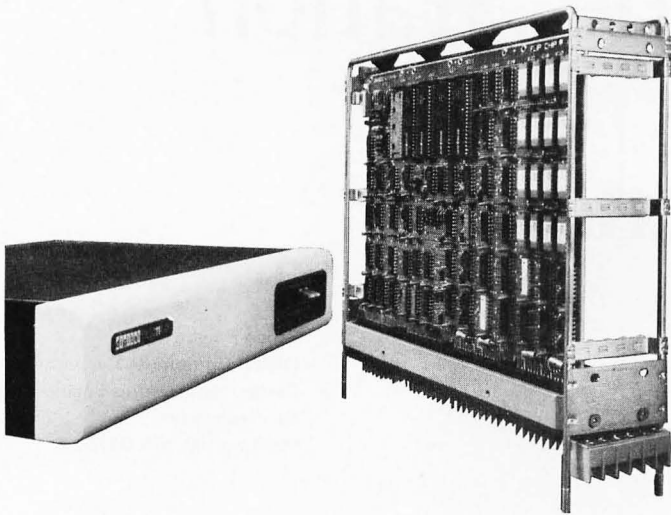

PDP 11/03-LSI-11 Central Processing Unit

LSI-11 has.

- 4 K X 16 random access memory
- 16 bits I/O port DMA port
- Power Fail/auto restart
- Real time clock input
- Automatic priority interrupt
- Vector interrupt handling

PDP 11/03

Self contained version, with power supply, front panel switches, real time clock, card cage, including CPU & 4 K RAM.

DISCOUNTS ON OTHER

IMSAI products, Lear Siegler Terminals and DEC components.

We have the Z-80 also.

**193-25 JAMAICA AVE.
HOLLIS, N. Y. 11432
(212) 468-7067 (9 AM - 5 PM)**

SOUND

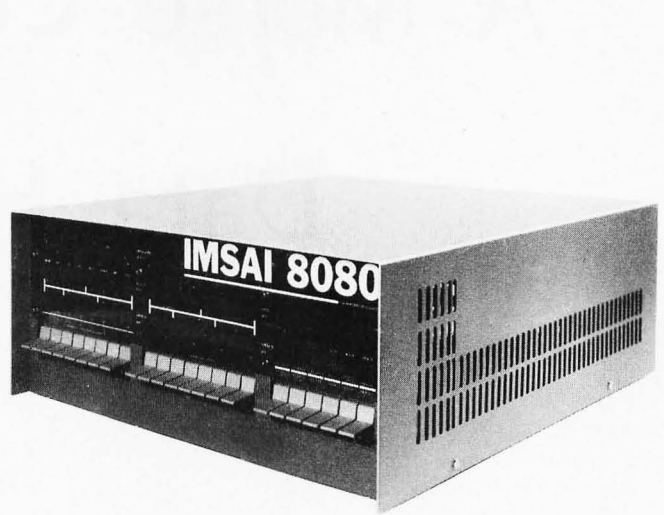

IMSAI 8080 Microcomputer

POWERFUL • EASY TO USE • LOW COST

Please rush me the following items

- | | | |
|--|-----------|-----------|
| <input type="checkbox"/> ADM-3K (Kit) | (24 X 80) | \$ 849.95 |
| <input type="checkbox"/> ADM-3 Assembled | (12 X 80) | \$ 949.95 |
| <input type="checkbox"/> ADM-3 Assembled | (24 X 80) | \$1099.95 |
| <input type="checkbox"/> ADM-2 Assembled | (24 X 80) | \$2295.00 |
| <input type="checkbox"/> ADM-1 Assembled | (24 X 80) | \$1429.00 |
| <input type="checkbox"/> IMSAI 8080 Microcomputer (Kit) | | \$ 559.95 |
| <input type="checkbox"/> LSI-11 | | \$ 840.00 |
| <input type="checkbox"/> PDP 11/03 | | |
| <input type="checkbox"/> DECWRITER LA 36 II 30 cps printer | | \$1769.95 |
| <input type="checkbox"/> Z-80 | | \$ 242.00 |
| <input type="checkbox"/> 8 K low power RAM board | | \$ 279.00 |

Enclosed is my . . .

- | | |
|---|--|
| <input type="checkbox"/> Cashiers check | \$100 dollar deposit required for COD |
| <input type="checkbox"/> Money order | |
| <input type="checkbox"/> Personal check | |
| <input type="checkbox"/> Master Charge | |

AUTHORIZED DISTRIBUTORS

Name _____

Address _____

City _____ State _____ Zip _____

New York residents add 8% sales tax

A Morse Code Station

Data Handler

Bruce Filgate
 Digital Equipment Corporation
 Components Group Engineering
 One Iron Way
 Marlborough MA 01752

For some time, there has been a need in amateur radio for a machine that could both decode and generate Morse code; in addition, the decoder had to be capable of automatically tracking varying received code speeds. Although Morse code keyboards have been around in the amateur radio field for some time, decoders have not been so readily available. Since hardwired logic can be difficult to modify, I decided to implement the coder and decoder in software. Since a low price was desirable and high performance was not required, I used Digital Equipment Corporation's MPS Starter Set. This is an Intel 8008-1 based product which DEC has been marketing to the commercial world. This article describes my implementation using MPS.

Implementation

The main program consists of a few subroutine calls to the main tasks, as shown

Listing 1: Monitor Entry and Supervisor Main Task. This listing shows the symbolic assembly language representation of the outer loop of the Morse code program. The detailed assembly is found in listing 2 along with the rest of the program.

| | | | |
|---------|-----|--------|------------------------------------|
| RESTRT, | CAL | INPEND | try code input line; |
| | CAL | KYBD | try the keyboard task; |
| | CAL | PNTR | try the printer task; |
| | LHI | CMMND† | test the mode byte; |
| | LLI | CMMND | |
| | XRA | | zero the A reg and flgs; |
| | ADM | | mode byte to A reg and flgs; |
| | JFZ | CMMNDR | enter command mode; |
| | CAL | IDLE | non command character feedthrough; |
| | CAL | OUTPUT | anything morse to output? |
| | JMP | RESTRT | and loop (?) along; |

in listing 1. As can be seen in the source code of the monitor, there are two principal routines that provide for Morse input and output; these two routines are INPEND and OUTPUT respectively. The other routines within the main modules provide house-keeping and data manipulation for these IO drivers.

It should be noted, on consulting the full program listing, listing 2, that there are two data tables: an ASCII table and a Morse data table. The only restrictions on modifying these tables are that both tables be the same size and in the same sequence. For instance, the ASCII table could be changed to reflect a non-ASCII code so that the console could be other than an ASCII terminal.

Principle of Code Manipulation

A search of published literature available at the time this program was created showed an excellent method of representing Morse code in memory, particularly in eight bit wide memory. This method, found on page 13 of the July 1975 QST magazine, was adopted here for internal representation of Morse code. Binary ones represent dashes, binary zeros represent dots and a final binary one closes the character. For instance, the Morse character B(- · · ·) would be represented by the octal number 210 (binary 10001000). Note that the binary strings are left justified with trailing zeros. It can be seen that if this representation is to be used to generate a Morse character B, the bit string should simply be shifted out to the left with each bit interpreted as a dash or a

Figure 1: Flow Chart Detail of INPEND, the Morse code input service routine. This routine, beginning at address 24/034 in listing 2, is responsible for tracking and adapting to the variations in speed of human generated Morse code inputs. This routine also detects end of character and end of word gaps between Morse inputs. The character outputs are translated and sent to the printer buffer maintained by the program.

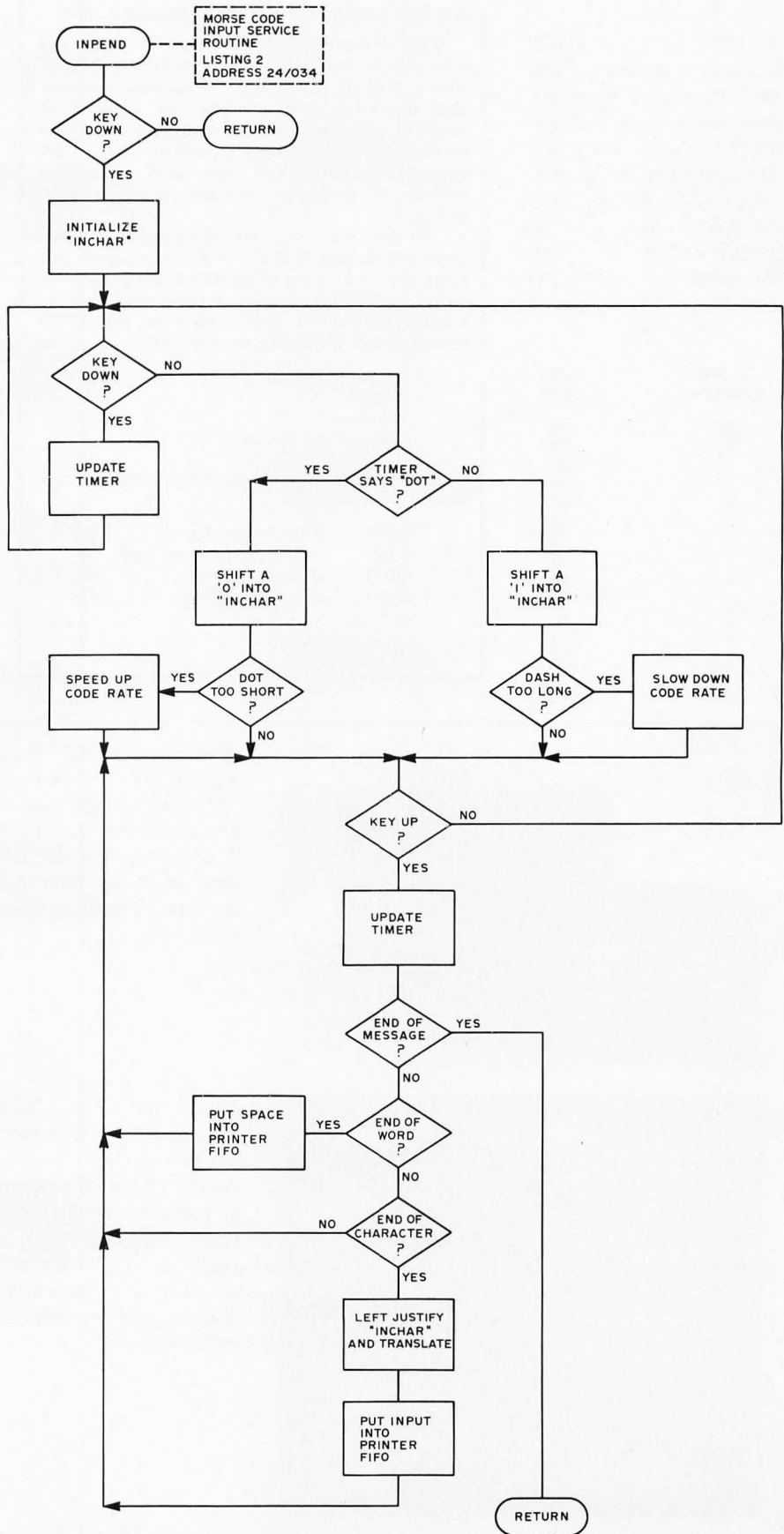

dot until a final result in the shift register is 200 octal. Thus 200 octal remaining in the processor's accumulator is used to signify the end of a character.

To transmit an ASCII keyboard character out in Morse code, all that is required is to look up the ASCII character in the ASCII table and compute its relative location within the table. Once the relative location is calculated, it is necessary to look in the Morse table in the same relative location and pull the Morse equivalent of the ASCII character out of the table. Once this code is available, it is loaded into a register and shifted out to the left as dashes and dots until the register contains octal 200. Conversely, data being received in Morse code starts a character by preloading of a register with octal 200 and then the shifting in of a bit at a time of dash and dot information in ones and zeros. When an intercharacter delay time is finally recognized, the character is considered "closed" and the data that is in the register is left justified and looked up in the Morse code table. When it is found in the Morse code table, the same relative address within the ASCII table contains the ASCII character equivalent. (See figure 1 for a flow chart of the code input service routine.)

Morse Code Speed Determination

When code is being transmitted by the program, the code output speed is selected by a keyboard control sequence. This control sequence consists of the escape (ESC) key followed by a 'W' and then a second character obtained from table 1. Once the

Table 1: The list of ASCII character graphics and their equivalent speed settings when used with the speed change command. The command sequence is: escape character, W, speed character. Thus the sequence escape, W, + sets the speed to 18 words per minute.

| Speed Character | Rate (wpm) |
|-----------------|------------|
| SP | 120 |
| ! | 89 |
| " | 63 |
| # | 48 |
| \$ | 44 |
| % | 37 |
| ' | 27 |
|) | 22 |
| + | 18 |
| / | 14 |
| 3 | 12 |
| > | 7.6 |
| ? | 7.2 |

Software Availability in Machine Readable Form

The software for this program in source and binary form has been submitted to the DECUS library. DECUS is the Digital Equipment Corporation User's Society, managed by a board of directors composed of DEC equipment users. Free membership in the society is open to users of DEC equipment. The group periodically publishes indices of currently available programs with abstracts.

The documentation for this program is listed under the number 8-801. Since it is expected that some users will want to modify this program, the source in ASCII is available on paper tape from the DECUS library. To order copies of the ASCII source tape or the binary tape, write to:

Program Librarian
DECUS
146 Main St
Maynard MA 01754

as of the time of writing, the following prices apply:

| | | |
|-------|-------------------------|------|
| 8-801 | Binary paper tape | \$2 |
| 8-801 | ASCII source paper tape | \$8 |
| 8-801 | DECUS writeup | \$1 |
| 8-801 | Assembly listing | \$10 |

output speed is selected by this method it will remain constant until a new value is selected.

Since the DEC M7341 processor card uses a variable speed clock, table 1 is calculated assuming that the clock be operated at the same speed as the clock on the author's system. If the clock for the processor on which the software is running is operated at a different rate, then table 1 must be recalculated.

If it is desired that the user's clock be set at the same speed as the clock found in the author's processor, a method of calibrating the clock is offered here: If the program is set up to transmit a sequence of dots, for instance the character "five" which is five dots sequentially, a string of "fives" will generate five dots followed by three dot times between characters, five more dots for the next "five" and so on. This, in consideration with the equation:

$$\text{Speed (wpm)} = \frac{\text{dots per minute}}{25} = 2.4 * \text{dots per second}$$

can be used to compute the effective code rate in words per minute.

The code input speed is never actually calculated but instead a rather heuristic tracking technique is used to update what

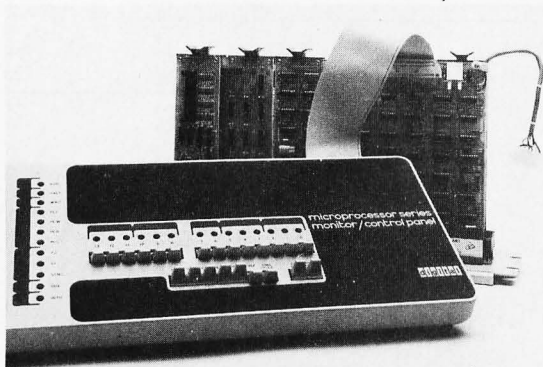

Photo 1: The Digital Equipment Corporation's MPS starter set used by the author for running the Morse code program. Further detail of the central processor board is shown in photo 2.

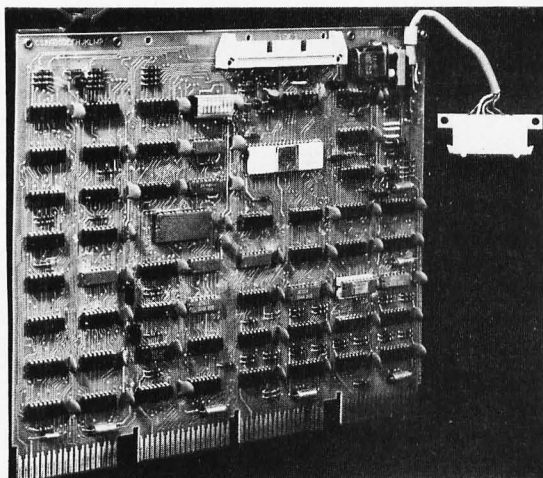

Photo 2: The Digital Equipment Corporation M7341 central processor board. The 8008 processor is socketed at the lower right. This board also includes a UART for serial interface and the random logic needed to buffer and drive an 8008.

Information about the Hardware Used

This program is designed to generate and decode Morse code. Although the program is intended to be executed on Digital Equipment Corporation's MPS M7341, it should also execute on almost any Intel 8008-1 based microprocessor with only slight modification. Photos 1 and 2 are supplied by Digital Equipment Corporation.

The following literature is available from:

Digital Equipment Corporation
Communications Services
444 Whitney St
Northboro MA 01532

General Interfacing Techniques for the M7341 Microprocessor Module
Interfacing The TU60 to the MPS M7341 Microprocessor
M7341 Processor Module Data Sheet
M7344-YA, -YB, -YC Read-Write Memory Module Data Sheet
M7345 Programmable Read Only Memory Data Sheet
M7346 External Event Detection Module Data Sheet
M7328 Evoke Decoder Module Data Sheet
M1501 Bus Input Interface Module Data Sheet
M1502 Bus Output Interface Module Data Sheet
Logic Handbook
KMP01A Microprocessor Series (MPS) Pre-wired Backplane Appl. Note
MR873 Microprocessor ROM Programmer Product Bulletin
1976 Direct Sales Catalog

the processor "judges" the current code rate to be. Therefore, the processor arbitrarily selects the initial code speed to be about 15 words per minute and, if it deems that the input code speed is other than that, a change will be made in the appropriate direction until the processor is able to synchronize against the incoming code speed. At this time, small changes in the code rate will be made to insure that the code speed remains within the tracking range. In addition to decoding the dot and dash times, the program must also be able to decode the times between characters, between symbols and even at the end of sentences. Additionally an arbitrary time is selected which is deemed to be an end of message; these times are set to be a function of a dot time. Thus, as the processor works to synchronize the code

speed, all that is required is to keep track of a counter which represents the length of a dot. If the dot time is increased, thus decreasing the code speed, all the other times will be affected in a similar direction.

Keyboard Monitor

In general, characters typed on the keyboard are immediately translated to the Morse code bit string and then transmitted

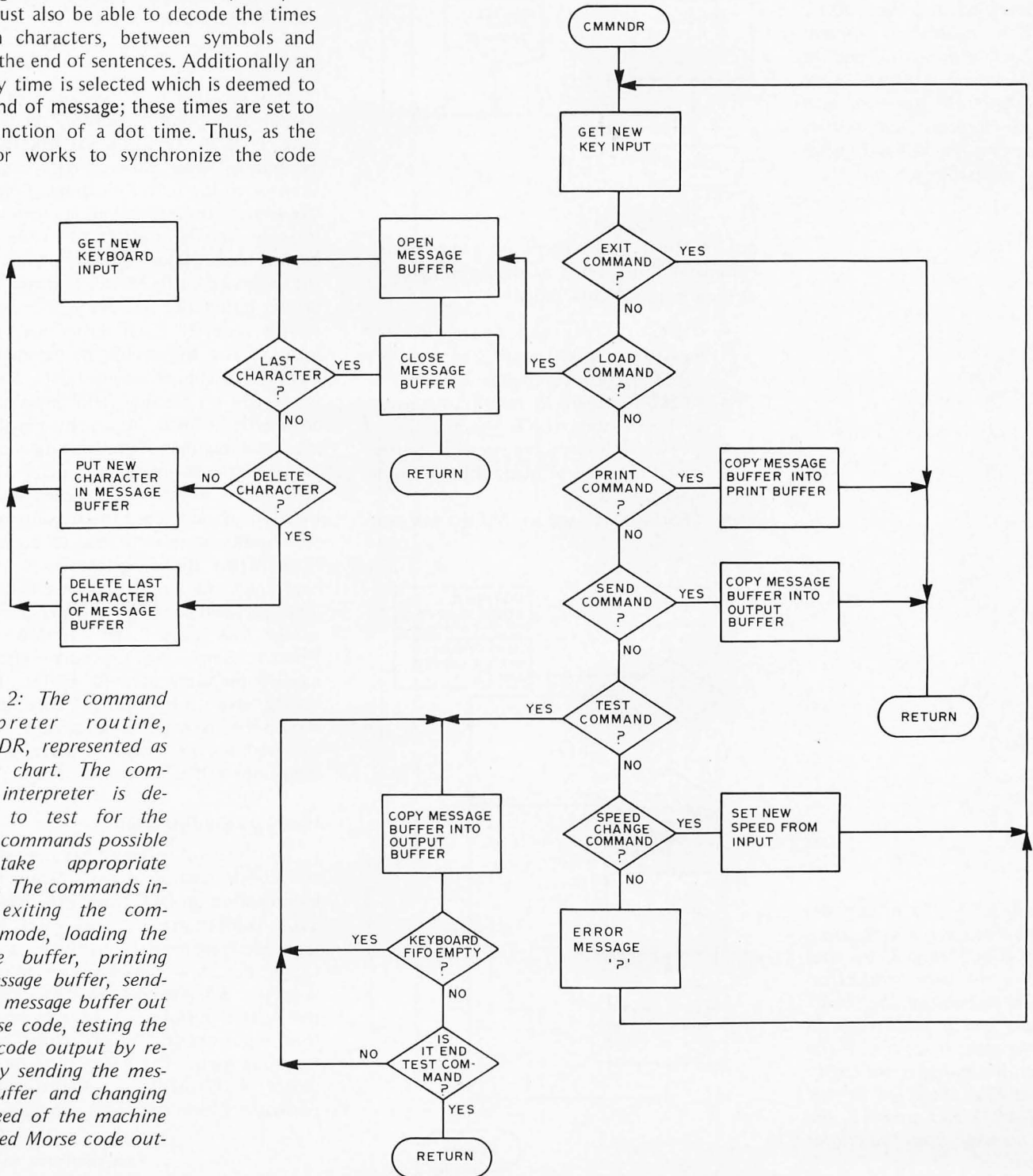
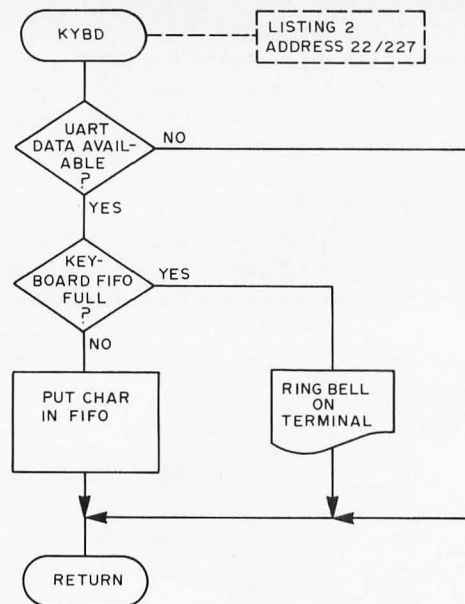

Figure 2: The command interpreter routine, CMMNDR, represented as a flow chart. The command interpreter is designed to test for the several commands possible and take appropriate actions. The commands include exiting the command mode, loading the message buffer, printing the message buffer, sending the message buffer out as Morse code, testing the Morse code output by repeatedly sending the message buffer and changing the speed of the machine generated Morse code outputs.

Figure 3: The keyboard service routine, KYBD, specified as a flow chart. This routine is simple: Look at the UART and see if data is available. If so, then stuff the data into the keyboard input buffer, or ring the bell and ignore if the buffer was full.



out in Morse code. There are some special commands interpreted as shown in figure 2 to modify this normal mode:

- <ESC> L is used to reload the message buffer until an escape (<ESC>). (LOAD command)
- <ESC> is used to return to normal keyboard mode. (EXIT command)
- <ESC> P causes the message buffer contents to be printed. (PRINT command)
- <ESC> S is used to ship the message

Figure 4: The printer service routine, PNTR, specified as a flow chart. This also is very straightforward: Look at the UART and see if it is ready to transmit. If so, then if the printer buffer is not empty send a character to the UART and remove the character from the printer buffer.

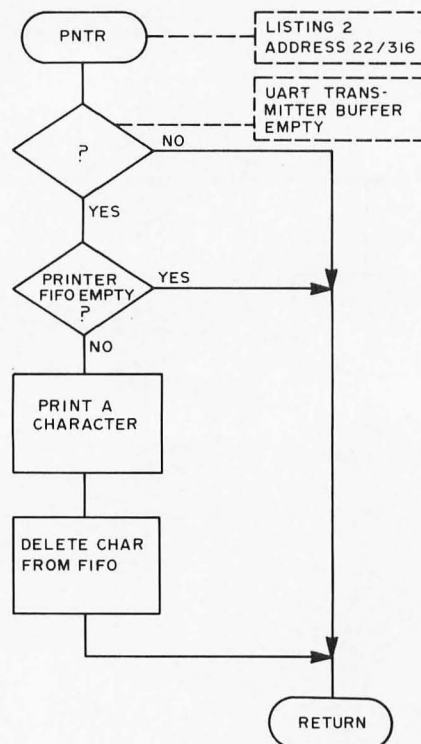

buffer out, translated in Morse code. (SEND command)

- <ESC> T is a test to do <ESC> S until an escape is typed. (TEST command)
- <ESC> W loads a new rate constant for WPM output. A character obtained from table 1 sets the rate, and should follow the W. (Speed change command)
- The delete (rub out) can be used in a buffer loading mode to remove previous characters back to the beginning of the buffer.

Software Buffer

This program uses overlaid IO to allow several operations to be done at the same time. First in, first out buffering is implemented to keep track of data transferred from or to the buffer locations. Four effective sources or destinations are involved: the message holding buffer, the code output buffer, the keyboard buffer (see figure 3 for the keyboard buffer service routine), and the printer buffer (see figure 4 for printer buffer service routine). Each buffer uses its first location as a byte count of the number of locations occupied by valid data. Since this is an eight bit machine, and single precision arithmetic is used, it is obvious that the maximum number of available data locations in a buffer can not exceed octal 377; any attempt by the user to exceed octal 377 locations or to exceed the maximum buffer size results in an error due to buffer overflow. When the program senses a buffer overflow condition, the terminal bell (or bell indicator) will be rung and the character that would have caused the overflow will be ignored. Since the user may choose to modify the sizes of these buffers, the following advice is offered: The message buffer should be as large as practically possible, followed by the keyboard buffer and then the printer buffer in priority.

Hardware Configuration

This piece of software has been designed and constructed so it can operate without modification on DEC Logic Products Starter Set 1 (KMP01 based). This starter set contains adequate memory, hardware, and interfacing to allow the software to execute properly. When executed on the starter set, the least significant bit of the input byte from input device 2 is used as the sense line for code input. The entire byte on output device 4 is used for code output (any particular bit on this output channel may be

Text continued on page 70

Listing 2: Complete Assembly of the Morse Code Program for an 8008. This listing was prepared using a cross assembler available to the author at Digital Equipment Corporation. The listing is reproduced here in its entirety, with an absolute origin picked for the hardware available to the author. The listing is well commented and includes a symbol table found at the end.

```

// THIS PROGRAM, CONSISTING OF A FROM SECTION OF          20 124 370      LMA
/SUBROUTINES & MAINLINE TASKS AND A RAM                 20 125 056      LHI BAUD~ /SET OUTPUT BAUD AT ABOUT 15 WFM
/SECTION OF BUFFERS, GENERATES AND DECODES MORSE CODE.  20 127 066      LLI BAUD
                                                         301
//THE DECODING SECTION IS DESIGNED TO BE SELF TRACKING  20 131 076      LMI 35
/AS TO CHANGING SPEEDS, DUE TO THIS SELF TRACKING     20 133 106      CAL INCLH /LIKEWISE WITH INPUT BAUD
/FEATURE, A FEW ILLEGAL CODES MAY BE DECODED AS THE   046
/PROGRAM ATTEMPTS TO LOCK ONTO THE INPUT CODE SPEED.   021

//THIS PROGRAM IS DESIGNED TO RUN ON THE INTEL 8008-1 BASED  20 136 076      LHI 35
/MPS STARTER SET AVAILABLE FROM THE DEC COMPONENTS GROUP. 035

// WRITTEN 1-29-76 BY BRUCE FILGATE OF COMPONENTS      20 140 250      STRT1, XRA
/APPLICATIONS ENGINEERING AT DIGITAL EQUIPMENT        20 141 056      LHI KYFIFO~ /RESTART FOR ^C AND CLEAR THE A REG
/CORPORATION IN MARLBOROUGH MASSACHUSETTS FOR THE    024
/LOGIC PRODUCTS MPS PRODUCT LINE                    20 143 066      LLI KYFIFO
                                                         305
                                                         20 145 370      LMA
                                                         20 146 056      LHI OTFIFO~ /CLEAR THE OUTPUT BUFFER
                                                         025
                                                         20 150 066      LLI OTFIFO
                                                         364

//WEIGHTING IS 1 DASH TO 3 DOTS.                    20 152 370      LMA
                                                         20 153 056      LHI CMMND~ /INITIALIZE THE MODE BYTE
                                                         024

//JUST A FEW WORDS ABOUT THE STACK STRUCTURE....      20 155 066      LLI CMMND
//THE STACKS USE THE FIRST LOCATION AS A COUNT OF THE  275
//NUMBER OF OTHER USED LOCATIONS IN THE STACK.        20 157 370      LMA
                                                         20 160 106      CAL INCLH /INIT THE CHAR COUNT
                                                         046
                                                         021

//THE LSB OF THE INPUT BYTE FROM I/O CHANNEL #2 IS RESERVED FOR  20 163 370      LMA
//THE SENSE LINE FOR CODE INPUT.                    20 164 056      LHI PNFIFO~ /SET FOR CRLF INITIALIZATION
                                                         025
                                                         20 166 066      LLI PNFIFO
                                                         304

//THE BYTE ON I/O CHANNEL #4 IS USED FOR CODE OUTPUT  20 170 370      LMA
//KEY SENSE FOR CODE INPUT AND OUTPUT IS GROUND FOR KEY DOWN  20 171 131      OUTPUT
//CONDITION AND LOGIC HIGH FOR THE KEY UP CONDITION.  /CLEAR THE TONE AND OTHER BITS

/*****
/
// PROGRAM SHOULD BE STARTED AT STRT
/
// PROGRAM MAY BE RESTARTED AT RESTRT
/
/*****
/
//THE TERMINAL BELL WILL BE RUNG WHENEVER A BUFFER
//OVERFLOW IS CAUSED BY THE USER. THE CHAR
//THAT WOULD HAVE CAUSED THE OVERFLOW IS TRAPPED
//AND DELETED.
/
/
//NORMALLY THE KEYBOARD DATA IS TRANSMITTED OUT TRANSLATED
//BUT ALT MODE (ESC) KEY USED FOR SPECIAL COMMANDS.
//L=RELOAD THE MESSAGE BUFFER UNTIL ESC
//ESC=RETURN TO NORMAL MODE
//P=PRINT THE MESSAGE BUFFER CONTENTS
//S=SHIP THE MESSAGE BUFFER TRANSLATED
//T=TEST BY DOING S UNTIL AN ESC IS TYPED
//W=LOAD BAUD CONSTANT FOR WFM OUTPUT
/
/ SP 120 WFM
/ / 89
/ / * 63
/ / * 48
/ / $ 44
/ / % 37
/ / ' 27
/ / ) 22
/ / + 18
/ / / 14
/ / 3 12
/ / > 7.6
/ / ? 7.2
/
/AND THE DELETE (RUBOUT) KEY IS USED TO EDIT BUFFER AS
//WELL AS REPRESENT THE ERROR CODE IN THE IMMEDIATE MODE.

/NEED A FEW MORE INSTRUCTIONS HERE...
OPDEF SENSE:105:0 /READ THE SENSE LINE
OPDEF READ:101:0 /SERIAL INPUT
OPDEF PRINT:121:0 /SERIAL OUTPUT
OPDEF STATUS:103:0 /SERIAL STATUS
OPDEF OUTPUT:131:0 /ENCODED OUTPUT
/BUFFER SIZE SET UP
MSGSZ=377 /MESSAGE HOLDING
RUFOUT=60 /CODE OUTPUT
RUFKEY=377 /KEYBOARD
RUFSPN=60 /PRINTER
/TERMINAL DEPENDENT CONSTANTS
WIDTH=110 /PRINTER WIDTH IN OCTAL
CR=15 /CAR RET CHAR (ASCII CR=15)
LF=12 /LINE FEED CHAR (ASCII LF=12)
W=127 /LOAD NEW SPEED CONSTANT (ASCII W=127)
ERCHAR=7 /CONSTANT FOR ERROR CHAR (ASCII BEL=7)
ESC=175 /ENTER COMMAND MODE (ASCII ESC=175)
L=114 /LOAD MESSAGE BUFFER (ASCII L=114)
P=120 /PRINT THE MESSAGE BUFFER (ASCII P=120)
S=123 /TRANSLATE&SEND MESSAGE (ASCII S=123)
T=124 /TEST DO S UNTIL ESC TYPED (ASCII T=124)
ESCSYM=44 /ECHO A $ FOR ESC
QUEST=77 /QUESTION MARK FOR BAD COMMAND
DELETE=177 /CHAR THAT REPRESENTS THE DELETE
DELSYM=134 /PRINTABLE CHAR FOR A DELETE
ETX=3 /CONTROL C EXIT TO STRT
C=103 /REQUIRED TO ECHO ETX, ^C
UPARRO=136 /REQUIRED TO ECHO ETX, ^C
BLANK=40 /ASCII SPACE CONSTANT

*20#120
/START UP TIME HOUSEKEEPING
LHI M5SGBF~ /CLEAR THE MESSAGE BUFFER
LLI M5SGBF

20 120 056 STRT,
026
20 122 066 LLI M5SGBF
044

```





AN
EDUCATIONAL
EXPERIENCE...

EXPOSE YOURSELF

THE FD-8 FLOPPY DISK SYSTEM is designed for use with 8 bit microcomputer systems including the ALTAIR 8800, IMSAI, and SWTP 6800. **JUST COMPARE THESE FEATURES:**

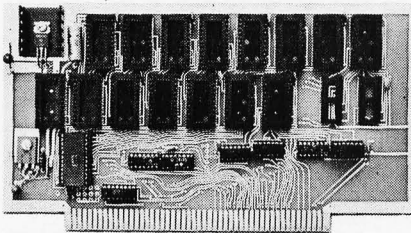
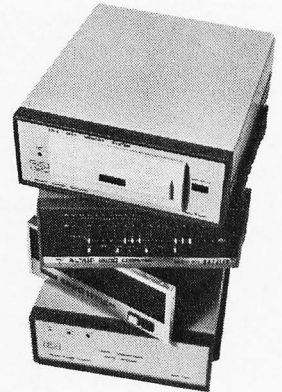
- Full sector buffering for both read and write operations.
- Both single and double density models available.
- Up to 4 drives may be daisy-chained together.
- Complete software documentation for MSI-FDOS and disk driver routines provided for 8080 and 6800 systems.
- Resident I/O software for disk operation of assembler/editor.
- Easy interface, just two 8 bit parallel I/O ports required, or one PIA chip!
- Furnished complete with cabinet, power supply, drive, controller and cables.
- **LOW COST**, only \$950.00 for this introductory offer.



THE MSI PROM/RAM BOARD WITH SYSTEM MONITOR SOFTWARE – for use in ALTAIR and IMSAI systems.

Free yourself from the drudgery of keying in bootstrap programs on front panel switches. Our monitor software contains all the common bootstrap loaders for assembler/editor software as well as basic. Just examine the proper starting address and press run! That's all there is to it! The monitor software takes over and all further selection of programs is done via your terminal. **The monitor contains many other time saving features which will allow you to program and debug with ease!**

- Examine and change memory contents using either octal or hex as desired.
- Dump and reload your programs to either paper tape or cassette using either hex or BNPF formats as desired.
- Execute user's program at any desired starting address.
- Trap functions display register contents at desired breakpoints inserted in user's program.
- List programs on your terminal.
- Look function scans a specified page of memory for a desired value or instruction displaying all memory locations where it is found.
- Relocator which moves a program from one area of memory to another, changing reference values thus allowing the program to run in its new location.
- Disassembler program which processes object code residing in memory displaying mnemonic with arguments, addresses, location values, and ASCII representation if applicable.
- Board accepts 15 1702A ROMs providing 3,840 bytes of Read-Only-Memory. 256 bytes of scratchpad RAM allow monitor software to be operated without the utilization of existing system memory.

PROM/RAM Board complete less PROMS..... \$ 95.00
Software listings only..... \$ 45.00
PROM/RAM Board complete with
1702A PROMS containing monitor software..... \$245.00



TO THE BASICS...

MSI introduces two versions of 6800 BASIC for use with our new low cost DOUBLE DENSITY floppy disk system AND... Other BASIC products which will give you everything you ever wanted in a microcomputer system...for less.

THE 6800 LEARNS THE BASICS... AT MSI, We needed a flexible programming language for our 6800 based data acquisition systems. That's why we developed MSI BASIC. Its many outstanding features will help you get the most out of your 6800 system:

- Full floating point arithmetic capability, decimal based for increased precision.
- Handles strings, subroutines, arrays, and multiple statements per line.
- User defined verbs.
- Operates from ROM or RAM and is relocatable anywhere in memory.
- Compatible with MSI-FDOS software and FD-8 floppy disk system.
- Available in 5K and 12K versions.

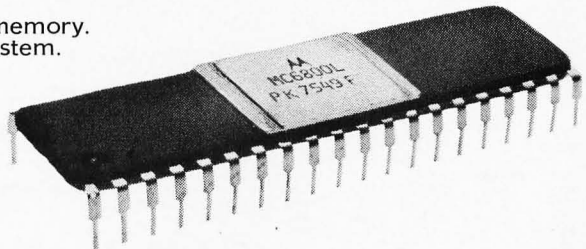

MSI Software Products:

| | |
|--------------------------------|---------|
| 5K 6800 Basic..... | \$45.00 |
| 12K 6800 Basic..... | \$65.00 |
| Both Versions..... | \$85.00 |
| Relocating loader program..... | \$15.00 |
| Disassembler program..... | \$25.00 |
| 1K Mini Assembler program..... | \$25.00 |

Additional Products for the SWTP 6800

WIRE WRAP BOARD

Accepts 40 pin, 24 pin, 16 pin and 14 pin sockets as well as discrete components. Contains 7805 on-board regulator for +5V power bus. Plugs into the SWTP 6800 mother board. Price \$25.00

PROM/RAM BOARD

Contains 3,840 bytes of 1702A ROM and 256 bytes of RAM on one board. May be used to contain MSI-FDOS software and scratchpad area. Price \$95.00

Master Charge & BankAmericard order accepted.

WHO IS MSI?

For the past 6 years MSI has been a leading manufacturer of microcomputer data handling systems for medical laboratories, so we're not new to the business. Four years ago we introduced the first floppy disk system for programmable calculators, which is still in production today. We manufacture CRT terminals, PROM programmers, and a large selection of instrumentation interfaces.

For more comprehensive product information, write MSI at the address below. Incidentally, our products are ready for immediate delivery.

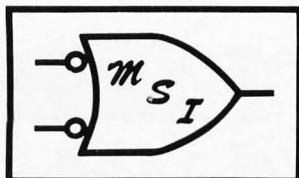
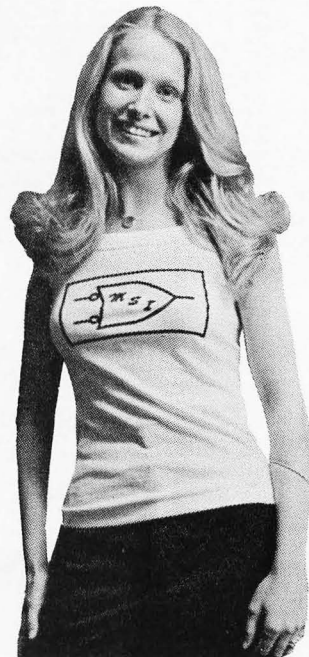

Midwest Scientific Instruments

220 WEST CEDAR, OLATHE, KANSAS 66061
PHONE 913 764-3273 • TWX 910 749 6403 (MSI OLAT)

```

20 306 140 MORTAB, DATA 140 /A
20 307 210 DATA 210 /B
20 310 250 DATA 250 /C
20 311 220 DATA 220 /D
20 312 100 DATA 100 /E
20 313 050 DATA 50 /F
20 314 320 DATA 320 /G
20 315 010 DATA 10 /H

20 316 040 DATA 40 /I
20 317 170 DATA 170 /J
20 320 260 DATA 260 /K
20 321 110 DATA 110 /L
20 322 340 DATA 340 /M
20 323 240 DATA 240 /N
20 324 360 DATA 360 /O
20 325 150 DATA 150 /P

20 326 330 DATA 330 /Q
20 327 120 DATA 120 /R
20 330 020 DATA 20 /S
20 331 300 DATA 300 /T
20 332 060 DATA 60 /U
20 333 030 DATA 30 /V
20 334 160 DATA 160 /W
20 335 230 DATA 230 /X

20 336 270 DATA 270 /Y
20 337 310 DATA 310 /Z
20 340 174 DATA 174 /1
20 341 074 DATA 74 /2
20 342 034 DATA 34 /3
20 343 014 DATA 14 /4
20 344 004 DATA 4 /5
20 345 204 DATA 204 /6

20 346 304 DATA 304 /7
20 347 344 DATA 344 /8
20 350 364 DATA 364 /9
20 351 374 DATA 374 /0

20 352 206 DATA 206 /-
20 353 126 DATA 126 /,
20 354 316 DATA 316 /?
20 355 062 DATA 62 /?
20 356 224 DATA 224 /(/SLASH)
20 357 342 DATA 342 /:
20 360 266 DATA 266 /<
20 361 264 DATA 264 /)
20 362 172 DATA 172 /'
20 363 112 DATA 112 /*
20 364 124 DATA 124 /END OF MESSAGE(CR/LF)
20 365 026 DATA 26 /END OF WORK(CR/LF)
20 366 252 MDREND, DATA 252 /;

/SUBROUTINE TO PUT DATA IN A GENERAL STACK
/STACK POINTER IN H&L, DATA IN B, BUFFER SIZE IN C
/RETURNS WITH A=0 IF NO ERROR, =ERCHAR IF ERROR
20 367 307 ENTPAK, LAM /CHAR COUNT TO A
20 370 021 DCC /COMPUTE CHARACTER LOCATIONS IN BUFFER
20 371 272 CFC /DON'T OVERFLOW THE BUFFER
20 372 150 JTZ ERROFL /FULL...

20 375 004 ADI 1 /BUMP THE COUNT
20 377 370 LMA /CHAR COUNT UPDATE TO MEM
21 000 206 ADL /LOW POINTER ADDED TO A
21 001 360 LLA /GET L VALUE UPDATED TO L REG
21 002 100 JFC OK /IF A CARRY, FIX THE H

21 005 050 OK, INH /FIX H REG
21 006 371 LMB /CHAR TO MEMORY
21 007 250 XRA /CLEAR THE A REG
21 010 007 RET /DONE
21 011 004 ERROFL, ADI 1 /SET A REG NON ZERO ERR RETURN
21 013 007 RET /SYSTEM ERROR, SYSTEM MUST FIX!!!!

/POP SUBROUTINE: ENTERED WITH POINTER IN H&L, SIZE IN B
21 014 307 POP, LAM /GET COUNTER TO A REG
21 015 024 SUI 1 /DECREMENT
21 017 370 LMA /RESTORE THE NEW COUNTER
21 020 104 JMP POPY /GET INTO POPLOP LOOP

/LOOP FOR POP
21 023 106 POPLOP, CAL INCLH /POINT AT CHAR TO POP
21 026 327 LCM /GET CHAR TO C REG
21 027 106 CAL DCRLH /POINT TO NEW LOCATION

21 032 372 LMC /PUT CHAR IN MEMORY
21 033 301 LAB /B TO A REG
21 034 024 SUI 1 /SUBTRACT 1

21 036 053 POPY, RTZ /DONE?
21 037 310 LBA /RESTORE B REG
21 040 106 CAL INCLH /RECOVER FROM THE DECREMENT POSITION

21 043 104 JMP POPLOP /NEXT PAIR POP

/SUBROUTINE TO INCREMENT THE H AND L REGS
21 046 060 INCLH, INL /BUMP THE L
21 047 013 RFZ /RETURN IF NO CARRY
21 050 050 INH /BUMP THE H ON A CARRY
21 051 007 RET /ALL DONE

/SUBROUTINE TO DECREMENT THE H AND L REGS
21 052 306 DCRLH, LAL /L TO A
21 053 024 SUI 1 /DECREMENT THE A
21 055 360 LLA /RETURN IF NO BORROW

21 056 003 RFC /NO BORROW, THEN RETURN
21 057 051 DCH /FIX THE H AFTER A BORROW
21 060 007 RET /DONE

/SUBROUTINE TO WAIT A UNIT CODE TIME, DESTROYS A,B,C
21 061 056 TICK, LHI BAUD /POINT AT CONST
21 063 024 LLI BAUD
21 065 026 LCI 50 /MULTIPLIER CONSTANT
21 067 317 WAIT2, LBM /CONST TO B
21 070 011 WAIT1, DCR /COUNT IT DOWN DELAY
21 071 110 JFZ WAIT1
21 074 021 DCC /MULTIPLY IT
21 075 110 JFZ WAIT2

21 100 106 CAL KYRD /OVERLAP WITH KEYBOARD INPUT
21 103 106 CAL PNTR /LIKEWISE WITH THE PRINTER
21 106 007 RET /DELAY OVER!!!!

/DELAY, USED FOR 8 SLICE DECODING OF INPUT CODE
21 107 056 TICKI, LHI BAUDI /POINT AT CONSTANT
21 111 024 LLI BAUDI
21 113 302 LCI 5 /8 TIMES FASTER THAN TICK
21 115 104 JMP WAIT2 /FINISH TICKI IN TICK ROUTINE
067
021

/SUBROUTINE TO GENERATE A DOT AND POST SPACE, DESTROYS A,B,C,H,L
21 120 006 DOT, LAI 377 /SET ALL BITS IN THE A REG
21 122 131 OUTPUT /TURN ON THE KEY (DOWN)
21 123 104 JMP FINDOT /FINISH THE DOT IN THE DASH ROUTINE
137
021

/SUBROUTINE GENERATES DASH ITS POST SPACE, DESTROYS A,B,C,H,L
21 126 006 DASH, LAI 377 /SET ALL BITS IN THE A REG
21 130 131 OUTPUT /KEY DOWN
21 131 106 CAL TICK /DASH
21 134 106 CAL TICK
21 137 106 FINDOT, CAL TICK /ENTERED HERE TO FINISH A DOT
061
021
21 142 250 XRA /CLEAR THE A REG
21 143 131 OUTPUT /KEY UP
21 144 106 CAL TICK
21 147 007 RET

/MONITOR TASK SUBROUTINE FOR HANDLING COMMANDS FROM THE KEYBOARD
21 150 106 CHMNR, CAL UNPAK /GET CHAR FROM KEYBOARD
164
022
21 153 150 JTZ CHMNR /IF NO CHAR, WAIT...
150
021
21 156 074 CPI ESC /WAS IT ANOTHER ESC?
175
21 160 150 JTZ CLRMD /EXIT ON ESC
153
022
21 163 074 CPI L /WAS IT A LOAD?
114
21 165 150 JTZ LDNXT /YES, GO LOAD A MESSAGE
224
021
21 170 074 CPI P /WAS IT A PRINT?
120
21 172 150 JTZ PRT /YES GO PRINT THE MESSAGE BUFFER
317
021
21 175 074 CPI S /WAS IT A SEND THE BUFFER?
123
21 177 150 JTZ SNDNX /YES, SHIP OUT THE MESSAGE
060
022
21 202 074 CPI T /WAS IT A TEST?
124
21 204 150 JTZ TEST /YES, SEND THE BUFFER UNTIL ESC IS TYPED
074
022
21 207 074 CPI W /WAS IT A NEW WPM CONSTANT?
127
21 211 150 JTZ WPM /YES, LOAD NEXT CHAR AS THE CONST
133
022
21 214 016 /IF HERE A BAD COMMAND
LBI QUEST /QUESTION MARK
21 216 106 CAL PPAK /TO THE PRINTER FIFO
304
022
21 221 104 JMP CHMNR /TRY FOR A VALID COMMAND CHAR
150
021

/ROUTINE TO LOAD THE MESSAGE BUFFER
21 224 056 LDNXT, LHI HSSGBF /POINT AT THE CURRENT CHAR POINTER
026
21 226 066 LLI HSSGBF
044

```

We've got it! Z-80 power for the Altair bus.

Here it is, TDL's ZPU™ the highest point of technology for an Altair/IMSAI system. Now, you can multiply your present capabilities without creating costly obsolescence. Take advantage of the wide range of existing hardware backup for your current system. The ZPU is compatible and dependable with many plus features you'll want to know about.

To further round out your system we also have available the fastest and lowest power static ram boards going (from 4 to 16K with expansion) and a system monitor board with a Z-80 monitor, powerful I/O and audio cassette features.

As for software, TDL's user support program is unmatched in the micro-processor industry, currently available are the Z-80 monitor, basic, and the most sophisticated MACRO-ASSEMBLER yet developed.

**Join the Z-80 revolution —
it's more than just hardware!**

ZPU Kit \$269.00
Z16K Kit \$574.00

HOW TO ORDER Just send check or money order, or use your BankAmericard or Mastercharge, and your orders will be shipped to you postpaid. COD orders must be accompanied by a 25% deposit. Your credit card order must include the serial # of the card, expiration date, and your order must be signed. New Jersey residents add 5% state sales tax. For more information, send for our free catalog.

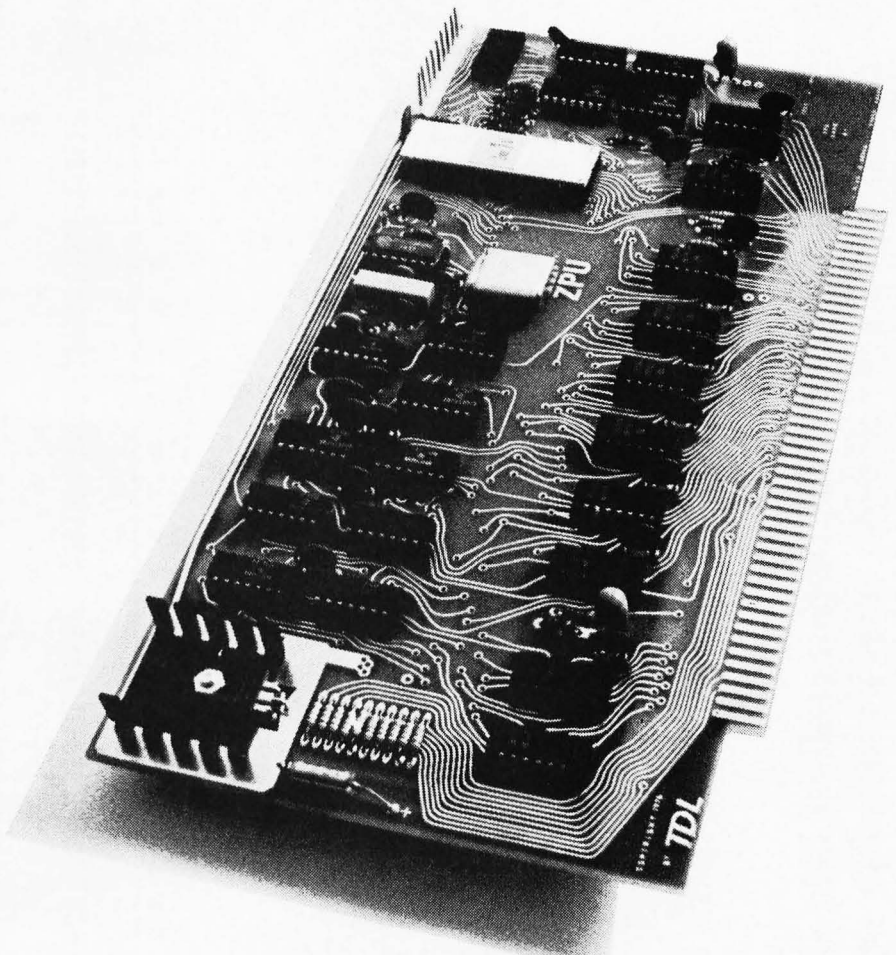

Dealer Inquiries Invited.

TDL
(609) 392-7070

TECHNICAL DESIGN LABS, INC.
342 COLUMBUS AVENUE
TRENTON, NEW JERSEY 08629

| | | | | | | | | | |
|--------|-----|---------|---------|--|-----------------------|--------|--------|--------|--|
| 21 230 | 074 | LMI | 0 | /ZERO THE COUNT | 22 016 | 106 | CAL | PPAK | /PRINT SUBMODE |
| | 000 | | | | | 304 | | | |
| 21 232 | 106 | LDNXT1, | CAL | UNPAK | /GET KEYBOARD CHAR... | 022 | | | |
| | 164 | | | | | 22 021 | 104 | JMP | PR3 |
| | 022 | | | | | 035 | | | |
| 21 235 | 150 | JTZ | LDNXT1 | /WAIT FOR DATA | 22 024 | 056 | SOH1, | LHI | DTFIFO^ /POINT AT OUTPUT BUFFER |
| | 232 | | | | | 025 | | | |
| 21 240 | 074 | CPI | ESC | /END OF THE INPUT MESSAGE? | 22 026 | 066 | | LLI | DTFIFO |
| | 175 | | | | | 344 | | | |
| 21 242 | 150 | JTZ | CLRMD | /EXIT END OF MESSAGE | 22 030 | 024 | | LCI | BUFOUT /BUFFER SIZE TO C REG |
| | 153 | | | | | 060 | | | |
| | 022 | | | | 22 032 | 106 | | CAL | ENTPAK /XFER TO THE BUFFER |
| 21 245 | 310 | LBA | | /CHAR TO B REG FOR ENTPAK | | 367 | | | |
| 21 246 | 056 | LHI | MSSGBF^ | /POINT AT THE MESSAGE BUFFER | 22 035 | 150 | PR3, | JTZ | PRT1 /LOOP IF NO ERROR |
| | 026 | | | | | 341 | | | |
| 21 250 | 066 | LLI | MSSGBF | | | 021 | | | |
| | 044 | | | | 22 040 | 106 | | CAL | PNTR /YES, OVERLAY THE I/O |
| 21 252 | 074 | CPI | DELETE | /DELETE COMMAND? | | 316 | | | |
| | 177 | | | | 22 043 | 106 | | CAL | KYBD |
| 21 254 | 110 | JFZ | LDNXT2 | /NO | | 227 | | | |
| | 021 | | | | | 022 | | | |
| 21 257 | 250 | XRA | | /YES, CLEAR THE A REG AND FLGS | 22 046 | 106 | | CAL | OTPUT |
| 21 260 | 207 | ADM | | /GET COUNT TO A AND FLGS | | 230 | | | |
| 21 261 | 150 | JTZ | LDNXT1 | /BUFFER EMPTY, A NO NO | | 025 | | | |
| | 232 | | | | 22 051 | 056 | | LHI | MSSCNT^ /RESET THE H REG FOR ERROR RECOVERY |
| | 021 | | | | | 024 | | | |
| 21 264 | 034 | SBI | 1 | /DECREMENT COUNTER | 22 053 | 066 | | LLI | MSSCNT |
| | 001 | | | | | 277 | | | |
| 21 266 | 370 | LMA | | /RETURN COUNT TO MEM | 22 055 | 104 | | JMP | PR4 /TRY THE CHAR AGAIN |
| 21 267 | 104 | JMP | LDNXT1 | /LOOP | | 372 | | | |
| | 232 | | | | | 021 | | | |
| | 021 | | | | | | | | |
| 21 272 | 026 | LDNXT2, | LCI | MSGSZ | /BUFFER SIZE SET UP | | | | |
| | 377 | | | | | | | | |
| 21 274 | 106 | CAL | ENTPAK | /CHAR TO BUFFER | | | | | |
| | 367 | | | | | | | | |
| | 020 | | | | | | | | |
| | | | | | | | | | |
| | | | | | | | | | |
| 21 277 | 112 | | | /TEST FOR BUFFER OVERFLOW | 22 060 | 056 | | | /ROUTINE TO SHIP OUT THE BUFFER IN CODE |
| | 305 | CFZ | WHOOO^ | /TELL USER BUFFER FULL | | 024 | SNDNX, | LHI | SOH^ /SET UP SEND MODE FOR |
| | 021 | | | | 22 062 | 066 | | LLI | SOH /DMPSUB ROUTINE |
| 21 302 | 104 | JMP | LDNXT1 | /LOOP UNTIL ESC | | 300 | | | |
| | 232 | | | | 22 064 | 076 | | LMI | 1 |
| | 021 | | | | | 001 | | | |
| | | | | | 22 066 | 106 | | CAL | DMPSUB /SEND THE MESSAGE BUFFER |
| | | | | | | 353 | | | |
| | | | | | | 021 | | | |
| | | | | | 22 071 | 104 | | JMP | CLRMD /EXIT |
| | | | | | | 153 | | | |
| | | | | | | 022 | | | |
| | | | | | | | | | |
| 21 305 | 103 | | | /SUBROUTINE FOR USER ERROR IDICATION | | | | | |
| 21 306 | 044 | WHOOO, | STATUS | /YES, GET PRINTER STATUS | | | | | |
| | 020 | NDI | 20 | /TBMT MASK | | | | | |
| 21 310 | 150 | JTZ | WHOOO^ | /WAIT | | | | | |
| | 305 | | | | | | | | |
| | 021 | | | | | | | | |
| 21 313 | 006 | LAI | ERCHAR | /SET ERROR INDICATION | 22 074 | 056 | | | /ROUTINE TO TEST OUTPUT, SHIP UNTIL ESC IS TYPED |
| | 007 | | | | | 024 | TEST, | LHI | SOH^ /SET UP FOR SEND MODE |
| 21 315 | 121 | PRINT | | | 22 076 | 066 | | LLI | SOH |
| 21 316 | 007 | RET | | | | 300 | | | |
| | | | | | 22 100 | 076 | | LMI | 1 |
| | | | | | | 001 | | | |
| | | | | | 22 102 | 106 | | CAL | DMPSUB /SEND THE BUFFER |
| 21 317 | 056 | | | /ROUTINE TO PRINT THE MESSAGE BUFFER | | 333 | | | |
| | 024 | PRT, | LHI | SOH^ /SET UP PRINT SUBMODE | | 021 | | | |
| 21 321 | 066 | LLI | SOH | | 22 105 | 106 | | CAL | UNPAK /CHAR FROM KEYBOARD |
| | 300 | | | | | 164 | | | |
| 21 323 | 076 | LMI | 0 | | | 022 | | | |
| 21 325 | 106 | CAL | DMPSUB | /PRINT THE MESSAGE BUFFER | 22 110 | 150 | | JTZ | TEST /NOTHING YET, DO IT AGAIN |
| | 333 | | | | | 074 | | | |
| | 021 | | | | 22 113 | 074 | | CPI | ESC /ESC? |
| 21 330 | 104 | JMP | CLRMD | /EXIT TO THE SUPERVISOR | | 175 | | | |
| | 153 | | | | 22 115 | 150 | | JTZ | CLRMD /YES, EXIT |
| | 022 | | | | | 153 | | | |
| | | | | | | 022 | | | |
| | | | | | 22 120 | 016 | TEST1, | LBI | QUEST /ILLEGAL CHAR FOR THIS |
| | | | | | | 077 | | | |
| 21 333 | 056 | DMPSUB, | LHI | MSSCNT^ /POINT AT TEMP CHAR POINTER | 22 122 | 106 | | CAL | PPAK /NOTIFY THE USER |
| | 024 | | | | | 304 | | | |
| 21 335 | 066 | LLI | MSSCNT | | 22 125 | 110 | | JFZ | TEST1 /IF OVERFLOW, TRY AGAIN |
| | 277 | | | | | 120 | | | |
| 21 337 | 076 | LHI | 0 | /CLEAR THE POINTER | | 022 | | | |
| | 000 | | | | 22 130 | 104 | | JMP | TEST /AND LOOP.... |
| 21 341 | 106 | PRT1, | CAL | PNTR /TRY TO FINISH THE PRINTING | | 074 | | | |
| | 316 | | | | | 022 | | | |
| 21 344 | 106 | CAL | KYBD | /TRY TO FINISH THE KEYBOARD INPUT | | | | | |
| | 227 | | | | | | | | |
| | 022 | | | | | | | | |
| 21 347 | 106 | CAL | OTPUT | /TRY TO FINISH THE TRANSMISSION | 22 133 | 106 | | | /CODE TO LOAD A NEW WPM CONSTANT INTO BAUD |
| | 230 | | | | | 144 | WPM, | CAL | UNPAK /GET CHAR FROM KEYBOARD |
| | 023 | | | | | 022 | | | |
| 21 352 | 056 | LHI | MSSGBF^ | /IS THERE A MESSAGE? | 22 136 | 150 | | JTZ | WPM /WAIT FOR CHAR |
| | 026 | | | | | 133 | | | |
| 21 354 | 066 | LLI | MSSGBF | /FIND CHAR CNTR AND CHECK FOR NON ZERO | | 022 | | | |
| | 044 | | | | 22 141 | 044 | | NDI | 37 /MASK FOR 5 VALID BITS |
| 21 356 | 250 | XRA | | /CLEAR THE A REG | | 037 | | | |
| 21 357 | 207 | ADM | | /ADD IN THE CHAR COUNT | 22 143 | 002 | | RLC | /MULTIPLY BY 2 |
| 21 360 | 053 | RTZ | | /NO MESSAGE, EXIT | 22 144 | 064 | | ORI | 1 /SET THE LSB |
| 21 361 | 056 | LHI | MSSCNT^ | /CHECK COUNT ON XFER CHARS | | 001 | | | |
| | 024 | | | | 22 146 | 056 | | LHI | BAUD^ /POINT AT BAUD LOCATION |
| 21 363 | 066 | LLI | MSSCNT | | | 024 | | | |
| | 277 | | | | 22 150 | 066 | | LLI | BAUD |
| 21 365 | 277 | CPM | | /BUFFER ALL XFERED? | | 301 | | | |
| 21 366 | 053 | RTZ | | /EVERYTHING XFERED, EXIT | 22 152 | 370 | | LMA | /CONSTANT TO BAUD LOCATION |
| 21 367 | 317 | LBM | | /STILL HERE, BUMP THE CHAR COUNT | | | | | |
| 21 370 | 010 | LMB | | | | | | | |
| 21 371 | 371 | | | | | | | | |
| | | | | | | | | | |
| | | | | | | | | | |
| 21 372 | 006 | PR4, | LAI | THE CHAR FROM THE MESSAGE BUFFER | 22 153 | 056 | | | /CLEAR THE FLAGS AND EXIT TO SUPERVISOR |
| | 044 | | | /MSSGBF /COMPUTE POINTERS | | 024 | CLRMD, | LHI | CHMND^ /ZERO THE MODE BYTE |
| 21 374 | 207 | ADM | | /ADD IN THE BUFFER OFFSET | 22 155 | 066 | | LLI | CHMND |
| 21 375 | 360 | LLA | | /SET UP THE L, H YET TO GO | | 275 | | | |
| 21 376 | 056 | LHI | MSSGBF^ | /H SET IF NO CARRY FROM THE L | 22 157 | 076 | | LMI | 0 |
| | 026 | | | | | 000 | | | |
| 22 000 | 100 | JFC | PR2 | /NO CARRY | 22 161 | 104 | | JMP | RESTRT /TO SUPERVISOR |
| | 004 | | | | | 172 | | | |
| | 022 | | | | | 020 | | | |
| 22 003 | 050 | | | | | | | | |
| 22 004 | 317 | PR2, | INH | /FIX FOR THE L CARRY | | | | | |
| 22 005 | 250 | | LBM | /CHAR TO THE B REG | | | | | |
| 22 006 | 056 | | XRA | /CLEAR THE A REG | | | | | |
| | 024 | | LHI | SOH^ /GET THE SUBMODE | | | | | |
| 22 010 | 066 | LLI | SOH | | | | | | |
| | 300 | | | | | | | | |
| 22 012 | 207 | ADM | | /SUBMODE IN THE A REG AND FLGS | | | | | |
| 22 013 | 110 | JFZ | SOH1 | /SEND SUBMODE | 22 164 | 106 | | UNPAK, | CAL |
| | 024 | | | | | 316 | | | PNTR /TRY TO FINISH PENDING PRINTING |
| | 022 | | | | | 022 | | | |

You'll Want to Nybble at these Byte Books

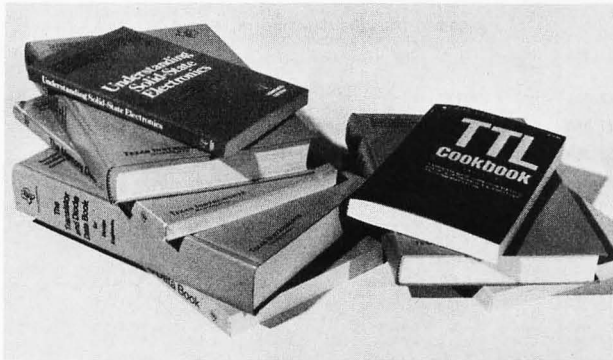

• **The TTL Cookbook** by Don Lancaster, published by Howard W Sams, Indianapolis, Indiana. Start your quest for data here with Don's tutorial explanations of what makes a TTL logic design tick. 335 pages, \$8.95.

• **The TTL Data Book for Design Engineers**, by Texas Instruments Incorporated. How does an engineer find out about the TTL circuits? He reads the manufacturer's literature. This 640 page beauty covers the detailed specs of most of the 7400 series TTL logic devices. No experimenter working with TTL has a complete library without **The TTL Data Book for Design Engineers**. Order yours today, only \$3.95.

• **The Supplement to The TTL Data Book for Design Engineers**, by Texas Instruments Incorporated. What happens when you can't find a 7400 series device listed in **The Data Book for Design Engineers**? Before you start screaming and tearing your hair out in frustration, turn to the Supplement. The Supplement has 400 pages of additional information including a comprehensive index to both TTL Data Book volumes. To be complete (and keep your hair in place and vocal cords intact) you'd best order the supplement at \$1.95 to accompany the main volume.

• **The Linear and Interface Circuits Data Book for Design Engineers**, by Texas Instruments Incorporated. When you run across one of those weird numbers like 75365 the immediate frustration problem occurs again. What kind of gate could that be? We won't tell in this ad, but you can find out by reading the specifications in **The Linear and Interface Circuits Data Book for Design Engineers**. You can interface your brain to the 72xxx (linear) and 75xxx (interface) series of functions by ordering your copy of this 688 page manual at only \$3.95.

• **The Semiconductor Memory Data Book for Design Engineers**, by Texas Instruments Incorporated. Don't forget the importance of memories to your systems. Refer to this 272 page manual to find out about the TI versions of many of the popular random access memories and read only memories. Order your personal copy today, only \$2.95.

Where does the editor of a computer magazine turn when he must verify some author's hardware design? Information on a 75450 interface gate, or a 74147 priority encoder circuit does not spring forth by magic. Checking the information supplied by authors is part of BYTE's quality control program.

When you build a project, you need this same sort of information. All you find in the advertisements for parts are mysterious numbers identifying the little beasts . . . hardly the sort of information which can be used to design a custom logic circuit. You can find out about many of the numbers by using the information found in these books. No laboratory bench is complete without an accompanying library shelf filled with references — and this set of Texas Instruments engineering manuals plus Don Lancaster's *TTL Cookbook* will provide an excellent starting point or addition to your personal library.

• **The Transistor and Diode Data Book for Design Engineers**, by Texas Instruments Incorporated. You'd expect a big fat data book and a wide line of diodes and transistors from a company which has been around from the start of semiconductors. Well, it's available in the form of this 1248 page manual from TI which describes the characteristics of over 800 types of transistors and over 500 types of silicon diodes. This book covers the TI line of low power semiconductors (1 Watt or less). You won't find every type of transistor or diode in existence here, but you'll find most of the numbers used in switching and amplifying circuits. Order your copy today, only \$4.95.

• **The Power Semiconductor Handbook for Design Engineers** by Texas Instruments Incorporated. To complement the low power transistor handbook, TI supplies this 800 page tome on high power transistors and related switching devices. Here is where you find data on the brute force monsters which are used to control many Watts electronically. Fill out your library with this book, available for only \$3.95.

• **Understanding Solid State Electronics** by Texas Instruments Incorporated. This is an excellent tutorial introduction to the subject of transistor and diode circuitry. The book was created for the reader who wants or needs to understand electronics, but can't devote years to the study. This 242 page softbound book is a must addition to the beginner's library at only \$2.95.

• **The Optoelectronics Data Book for Design Engineers** by Texas Instruments Incorporated. This 366 page book is a compendium of information on TI phototransistors, LEDs and related devices. Order yours at \$2.95.

- ___ TTL Cookbook @ \$8.95
- ___ TTL Data Book @ \$3.95
- ___ Supplement to TTL Data Book @ \$1.95
- ___ Linear and Interface Circuits @ \$3.95
- ___ Semiconductor Memory Data @ \$2.95
- ___ Transistor and Diode Data Book @ \$4.95
- ___ Power Semiconductor Handbook @ \$3.95
- ___ Understanding Solid State Electronics @ \$2.95
- ___ Optoelectronics Data Book @ \$2.95

Please add 75 cents for postage and handling.

Please allow six weeks for delivery.

Send to:

Name _____

Address _____

City _____ State _____ Zip _____

Check enclosed

Bill MC # _____ Exp. Date _____

Bill BA # _____ Exp. Date _____

Signature _____

| | | | | | | | | | | |
|--------|-----|---------------------------------------|------------------------------|--|--------|-------|---------|-----------------------------|---|--|
| 22 167 | 106 | CAL | KYBD | /KEYBOARD HAPPY? | 220 | | | | | |
| | 227 | | | | 022 | | | | | |
| | 022 | | | | 006 | LAI | LF | | | |
| 22 172 | 106 | CAL | OTPUT | /OVERLAY THE CODE OUTPUT | 012 | | | | | |
| | 230 | | | | 121 | PRINT | | | | |
| | 023 | | | | 22 343 | LHI | WIDTH | /RESET PRINT POSITION COUNT | | |
| 22 175 | 056 | LHI | KYFIFO | /POINT AT KEYBOARD STACK | 22 344 | 076 | | | | |
| | 024 | | | | 110 | RET | | | | |
| | 066 | | | | 22 346 | 007 | | | | |
| 22 177 | 305 | LLI | KYFIFO | | 22 347 | 056 | PRT2, | LHI | PNFIFO | /POINT AT CHAR COUNT |
| | 250 | | | | 025 | | | | | |
| 22 201 | 250 | XRA | | /CLEAR THE A REG | 22 351 | 066 | LLI | PNFIFO | | |
| 22 202 | 207 | ADM | | /CHAR COUNT TO A REG | 304 | | | | | |
| 22 203 | 053 | RTZ | | /IF EMPTY, RETURN A REG=0 | 22 353 | 250 | XRA | | /CLEAR THE A REG | |
| 22 204 | 106 | CAL | INCLH | /POINT AT CHAR | 22 354 | 207 | ADM | | /CHAR COUNT TO A REG AND FLGS | |
| | 046 | | | | 22 355 | 053 | RTZ | | /NOTHING TO PRINT, NEXT TASK | |
| | 021 | | | | | | | | /IF HERE THERE IS PRINTING TO BE DONE!!!!!!! | |
| 22 207 | 347 | LEM | | /GET CHAR TO E REG TEMP | | | | | /POINT AT CHAR TO PRINT AND PRINT IT | |
| 22 210 | 106 | CAL | DCRLH | /POINT AT KEYBOARD FIFO | 22 356 | 106 | CAL | INCLH | | |
| | 246 | | | | 046 | | | | | |
| | 052 | | | | 021 | | | | | |
| 22 213 | 106 | CAL | POP | /OUT OF FIFO, RETURNS A=0 | 22 361 | 347 | NXTPNT, | LEM | UPDATE THE | /CHAR TO E REG TEMP |
| | 014 | | | | | | | | PNFIFO | CHAR COUNT |
| | 021 | | | | 22 362 | 066 | LLI | PNFIFO | /POINT AT CHAR COUNT | |
| 22 216 | 204 | ADE | | /CHAR TO A REG AND FLGS | 22 364 | 304 | LHI | PNFIFO | | |
| 22 217 | 007 | RET | | /RETURN WITH A REG=CHAR | 22 364 | 056 | | | | |
| | | | | | 025 | | | | | |
| | | | | | 22 366 | 106 | CAL | POP | /RIPPLE THE FIFO | |
| | | | | | 014 | | | | | |
| 22 220 | 103 | /SUBROUTINE TO WAIT FOR THE TBMT FLAG | | | 021 | | | | | |
| 22 221 | 044 | WAITMT, STATUS | NDI | 20 | 22 371 | 056 | LHI | TWIDTH | /UPDATE PRINT POSITION | |
| | 020 | | | | 024 | | | | | |
| 22 223 | 150 | JTZ | WAITMT | /WAIT.... | 22 373 | 066 | LLI | TWIDTH | | |
| | 220 | | | | 276 | | | | | |
| | 022 | | | | 22 375 | 317 | LBM | | /COUNT TO B | |
| 22 226 | 007 | RET | | /OK, HAVE TBMT | 22 376 | 011 | DCB | | /-1 | |
| | | | | | 22 377 | 371 | LMB | | /BACK TO MEMORY | |
| | | | | | 23 000 | 304 | LAE | | /CHAR BACK TO A REG | |
| | | | | | 23 001 | 074 | CPI | LF | /IS IT A LF? | |
| | | | | | 012 | | | | | |
| | | | | | 23 003 | 150 | JTZ | INCRFL | /YES, INSERT A CRLF | |
| | | | | | 031 | | | | | |
| 22 227 | 103 | KYBD, | /KEYBOARD HANDLER SUBROUTINE | | 023 | | | | | |
| 22 230 | 044 | STATUS | NDI | 40 | 23 006 | 074 | CPI | CR | /IS IT A CR? | |
| | 040 | | | | 015 | | | | | |
| 22 232 | 053 | RTZ | | /NEXT TASK | 23 010 | 150 | JTZ | INCRFL | /YES, INSERT A CRLF | |
| | | | | /PUT KEYBOARD CHARACTER IN KYBD FIFO | 031 | | | | | |
| 22 233 | 101 | READ | | /GET CHAR FROM KEYBOARD TO A REG | 023 | | | | | |
| 22 234 | 044 | NDI | 177 | /GET RID OF ASCII PARITY BIT | 23 013 | 074 | CPI | DELETE | /IS IT A DELETE? | |
| | 177 | | | | 177 | | | | | |
| 22 236 | 074 | CPI | ETX | /CONTROL C | 23 015 | 150 | JTZ | DEL | /YES, INSERT A BACKSLASH | |
| | 003 | | | | 034 | | | | | |
| 22 240 | 110 | JFZ | NETX | /NO | 023 | | | | | |
| | 267 | | | | 23 020 | 074 | CPI | ESC | /IS IT AN ESC? | |
| | 022 | | | | 175 | | | | | |
| 22 243 | 250 | XRA | | /YES, CLEAR OUTPUT | 23 022 | 110 | JFZ | PNT1 | /NO | |
| 22 244 | 131 | OUTPUT | | | 027 | | | | | |
| 22 245 | 106 | CAL | WAITMT | /SEND OUT ^C | 23 025 | 006 | LAI | ESCSYM | /YES, SUBSTITUTE A PRINTABLE CHAR | |
| | 220 | | | | 044 | | | | | |
| 22 250 | 006 | LAI | UPARRO | | 23 027 | 121 | PNT1, | PRINT | /PRINT THE CHAR | |
| | 136 | | | | 23 030 | 007 | RET | | /DONE, PRINTED A CHAR | |
| 22 252 | 121 | PRINT | | | 23 031 | 076 | INCRFL, | LHI | 0 | /SET FOR CRLF NEXT |
| 22 253 | 106 | CAL | WAITMT | /WAIT FOR TBMT | 000 | | | | | |
| | 220 | | | | 23 033 | 007 | RET | | | |
| | 022 | | | | 23 034 | 006 | DEL, | LAI | DELSYM | /SUBSTITUTE A PRINTABLE CHARACTER |
| 22 256 | 006 | LAI | C | | 134 | | | | | |
| | 103 | | | | 23 036 | 121 | PRINT | | | |
| 22 260 | 121 | PRINT | | | 23 037 | 007 | RET | | /END TO THE PRINTER TASK | |
| 22 261 | 106 | CAL | WAITMT | /WAIT FOR TBMT | | | | | | |
| | 220 | | | | | | | | | |
| 22 264 | 022 | JMP | STR1 | /GO RESTART FROM ALMOST ZERO | | | | | | |
| | 104 | | | | | | | | | |
| | 140 | | | | | | | | | |
| | 020 | | | | | | | | | |
| 22 267 | 056 | NETX, | LHI | KYFIFO | | | | | | /THIS SUBROUTINE TRANSLATES A REG TO OUTPUT MODE |
| | 024 | | | /POINT AT KYFIFO | | | | | | /COMPUTE THE DISPLACEMENT IN ASCTAB |
| 22 271 | 066 | LLI | KYFIFO | | 23 040 | 056 | XLATER, | LHI | ASCTAB | /POINT AT ASCTAB |
| | 305 | | | | 020 | | | | | |
| 22 273 | 310 | LBA | | /CHAR TO B REG | 23 042 | 066 | LLI | ASCTAB | | |
| 22 274 | 026 | LCI | BUFSKY | /BUFFER SIZE TO C REG | 225 | | | | | |
| | 377 | | | | 23 044 | 277 | THISIT, | CPH | | /IS THIS THE CHAR? |
| 22 276 | 106 | CAL | ENTPAK | /PUT CHAR IN BUFFER | 23 045 | 150 | JTZ | CONVT | /GO CONVERT THE CHAR | |
| | 367 | | | | 074 | | | | | |
| | 020 | | | | 023 | | | | | |
| 22 301 | 112 | CFZ | WHOO | /IF OVERFLOW, TELL THE USER | 23 050 | 106 | CAL | INCLH | /TRY NEXT CHAR | |
| | 305 | | | | 046 | | | | | |
| | 021 | | | | 021 | | | | | |
| | | | | /FALL THROUGH AND RETURN IN NEXT ROUTINE | 23 053 | 310 | LBA | | /SAVE THE CHAR IN B REG TEMPORARILY | |
| | | | | | 23 054 | 006 | LAI | ASCEND | /GET HIGH LIMIT TO A FOR COMPARE | |
| | | | | | 020 | | | | | |
| | | | | | 23 056 | 275 | CPH | | /FAST END OF TABLE? | |
| | | | | | 23 057 | 140 | JTC | NTFUND | /FAST END OF TABLE AND NO MATCH | |
| | | | | | 122 | | | | | |
| | | | | | 023 | | | | | |
| | | | | | 23 062 | 006 | LAI | ASCEND | /GET LOW LIMIT TO A FOR COMPARE | |
| | | | | | 305 | | | | | |
| 22 304 | 056 | PPAK, | LHI | PNFIFO | 23 064 | 276 | CPL | | /FAST END OF TABLE? | |
| | 025 | | | /PUT CHAR IN PRINTER FIFO FROM B REG | 23 065 | 140 | JTC | NTFUND | /FAST END OF TABLE AND NO MATCH | |
| | 066 | | | /RETURNS WITH A REG =0 IF NO ERROR, =ERCHAR IF ERROR | 122 | | | | | |
| 22 306 | 304 | LLI | PNFIFO | /POINT AT PNFIFO | 023 | | | | | |
| | 060 | | | | | | | | | |
| 22 310 | 026 | LCI | BUFSKY | /BUFFER SIZE TO C REG | 23 070 | 301 | | | /IF HERE, STILL IN TABLE. TRY CONTENTS AGAIN. | |
| | 367 | | | | 23 071 | 104 | JMP | THISIT | /RETURN CHAR TO A REG | |
| 22 312 | 106 | CAL | ENTPAK | /PUT CHAR IN FIFO | 044 | | | | /LOOP FOR NEXT TABLE ENTRY CHECK | |
| | 020 | | | | 023 | | | | | |
| 22 315 | 007 | RET | | /END OF THE KEYBOARD HANDLER TASK | 23 074 | 006 | CONVT, | LAI | MORTAB | /COMPUTE REL DISPLACEMENT LOW |
| | | | | | 306 | | | | | |
| | | | | | 23 076 | 024 | SUI | ASCTAB | | |
| | | | | | 225 | | | | | |
| | | | | | 23 100 | 100 | JFC | OK1 | | |
| | | | | | 104 | | | | | |
| | | | | | 023 | | | | | |
| 22 316 | 103 | /PRINTER HANDLER SUBROUTINE TASK | | | 23 103 | 051 | OK1, | DCH | | /HANDLE THE BORROW |
| 22 317 | 044 | PNTN, | STATUS | 20 | 23 104 | 206 | ADL | | /ADD IN THE LOW POINTER | |
| | 020 | | | | 23 105 | 100 | JFC | OK2 | | |
| | 020 | | | | 111 | | | | | |
| 22 321 | 053 | RTZ | | /IF BUSY, TRY SOMETHING ELSE | 023 | | | | | |
| 22 322 | 056 | LHI | TWIDTH | /FIND PRINT POSITION | 23 110 | 050 | OK2, | INH | | /HANDLE THE CARRY |
| | 024 | | | | 23 111 | 360 | LLA | LAI | | /L IS NOW POINTING IN THE OUTPUT TABLE |
| 22 324 | 066 | LLI | TWIDTH | | 23 112 | 006 | LAI | MORTAB | | /COMPUTE RELATIVE DISPLACEMENT HIGH |
| | 276 | | | | 020 | | | | | |
| 22 326 | 250 | XRA | | /CLEAR THE A REG | 23 114 | 034 | SBI | ASCTAB | | |
| 22 327 | 207 | ADM | | /COUNT TO FLGS AND A REG | 020 | | | | | |
| 22 330 | 110 | JFZ | PRT2 | /NO LINE OVERFLOW | 23 116 | 205 | ADH | | /ADD IN THE HIGH POINTER | |
| | 347 | | | | 23 117 | 350 | LHA | | /H NOW POINTS IN THE OUTPUT TABLE | |
| | 022 | | | | 23 120 | 307 | LAM | | /REPLACEMENT CHAR TO A REG | |
| 22 333 | 006 | LAI | CR | /LINE OVERFLOW, FIX IT | 23 121 | 007 | RET | | /CODE IN A REG RETURN | |
| | 015 | | | | 23 122 | 006 | NTFUND, | LAI | 200 | /CHAR NOT FOUND LOAD OUT A 200 |
| 22 335 | 121 | PRINT | | | 200 | | | | | |
| 22 336 | 106 | CAL | WAITMT | /WAIT FOR TBMT | 23 124 | 007 | RET | | /ERROR RETURN | |

THE POLY 88 MICROCOMPUTER

A Complete Microcomputer System with Keyboard Input and Video Output

The Hardware: The heart of the POLY 88 microcomputer, the CPU circuit card, features an 8080A central processor, 512-byte RAM, space for 3K of PROM, vectored interrupt and real time clock, a dual serial port with software-selectable baud rate,

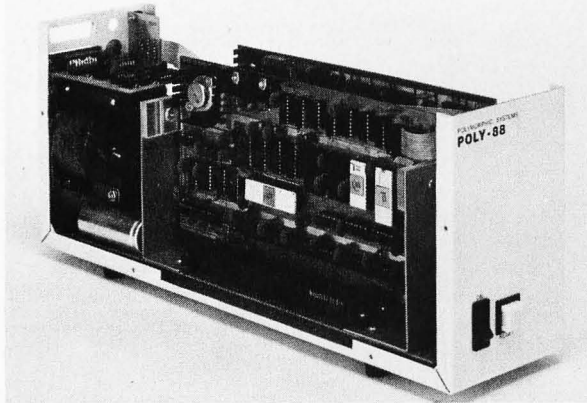

and single-step logic that allows the processor to execute one instruction at a time.

The POLY 88 also includes our video terminal interface circuit card, which is both a video display device and an input port for a keyboard. Sixteen lines of up to 64 characters may be displayed on a standard TV monitor or modified receiver. In addition to the 128 ASCII characters which are displayed in an

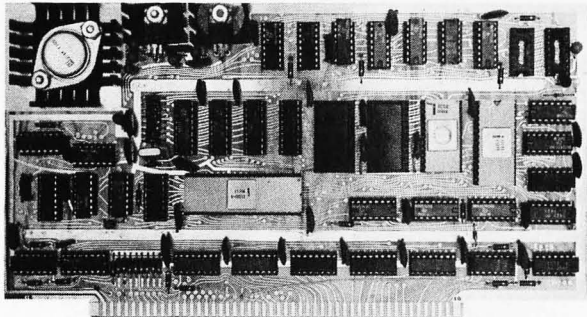

easy-to-read 7x9 font, there are 64 graphic characters available for plotting on a 48 x 128 contiguous grid.

These two circuit cards fit into a compact "Altair-compatible" chassis with room for up to five cards. A 6 amp power supply is built right on the mother board. The front panel consists of just two switches, on/off and reset; the monitor software with video screen and keyboard eliminates the need for a hardware front panel. As your system grows, you can plug chassis together for easy expansion. (The expansion connector also eliminates the need for an extender card.) Cassette, RS-232, and current loop interfaces are available which connect via ribbon cable to the CPU board and mount on the backpanel.

The Software: Supplied with the POLY 88 microcomputer is a 1024-byte monitor on ROM. The program is there when the power is turned on, so you don't need to key in a loader. The monitor is designed to use a keyboard entry and TV display, with a cassette or paper tape as the storage medium.

With the monitor you can: load data into memory in hex, display memory in hex, dump or read data from a storage device, and execute program one step at a time, displaying the contents of each of the 8080 registers as well as the values in memory at the address of each of the registers. All of these functions

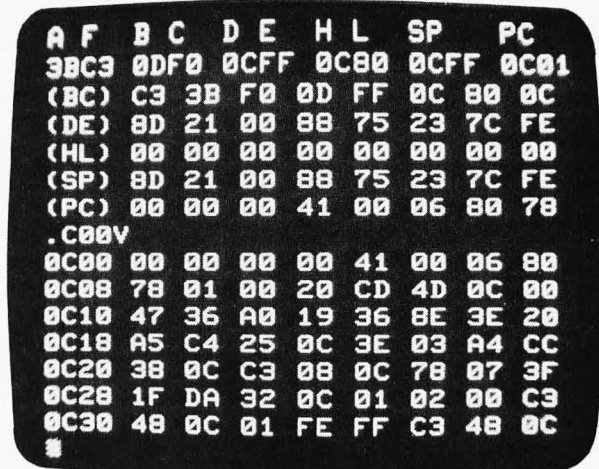

are available the instant you turn on the power.

Future software available with this system will include BASIC, an assembler, and games.

Prices: Basic kit including chassis, CPU and video cards — \$595, \$795 assembled. Cassette option — \$90 kit and \$125 assembled. 8K of RAM — \$300 in kit form or \$375 assembled. We also sell the video and other "Altair-compatible" circuit cards separately.

Dealers: This system sells itself.

All prices and specifications subject to change without notice. Prices are USA only. California residents add 6% sales tax. Prepaid orders shipped postpaid. BankAmericard and MasterCharge accepted.

737 S. Kellogg, Goleta, CA 93017 (805) 967-2351

Please send more information

Order and check enclosed

Name _____

Address _____

BankAmericard _____

Master Charge _____

PolyMorphic
Systems

| | | | | | | | | |
|--------|-----|--|-------------------------------------|-------------------------------|-----|--|--------|--|
| 23 125 | 074 | /THIS SUBROUTINE TRANSLATES A REG TO PRINT MODE | | 23 313 | 150 | JTZ | OUTEND | /DONE! |
| | 377 | XLAT, | CPI 377 | | 342 | | | |
| | | | /SET C FLG (GUARD BIT) | | 023 | | | |
| 23 127 | 022 | RAL | /ROTATE | 23 316 | 100 | JFC | DSH | /DOT OR DASH? |
| 23 130 | 100 | JFC | .-1 | | 327 | | | |
| | 127 | | /IF NO LEFT GUARD, LOOP | | 023 | | | |
| | 023 | | | 23 321 | 106 | CAL | DOT | /YES A DOT, SO KEY OUT A DOT |
| 23 133 | 074 | /IF A REG CONTAINS A 000, ERROR CHAR WAS SEEN... | | | 120 | | | |
| | 000 | CPI | 0 | | 021 | | | |
| | | | /SET FLGS | 23 324 | 104 | JMP | OTLOOP | /NEXT SYMBOL |
| 23 135 | 110 | JFZ | XLAT1 | | 332 | | | |
| | 143 | | /NOT ERROR, TRANSLATE | 23 327 | 106 | DSH, | CAL | DASH /MUST BE A DASH, SO KEY A DASH |
| | 023 | | | | 126 | | | |
| 23 140 | 006 | LAI | DELSYM | | 021 | | | |
| | 134 | | /SET UP FOR DELETE SYMBOL | 23 332 | 303 | OTLOOP, | LAD | /GET THE CHAR BACK TO THE A REG |
| 23 142 | 007 | RET | /EXIT | 23 333 | 044 | NDI | 177 | /THROW OUT THE USED BIT |
| 23 143 | 056 | XLAT1, | LHI MORTAB | | 177 | | | |
| | 020 | | /POINT AT MORTAB | 23 335 | 002 | RLC | | /ROTATE IN AN UNUSED BIT |
| 23 145 | 066 | LLI | MORTAB | 23 336 | 330 | LDA | | /SAVE THE NEW IMAGE IN D |
| | 306 | | | 23 337 | 104 | JMP | GOODCH | /LOOP FOR OTHER SYMBOLS |
| 23 147 | 277 | THIS, | CPM | | 311 | | | |
| | 150 | | JTZ | | 023 | | | |
| | 177 | | HCONVT | 23 342 | 106 | OUTEND, | CAL | TICK /INTER LETTER SPACE |
| | 023 | | /IS THIS THE CHAR? | | 061 | | | |
| 23 153 | 106 | CAL | INCLH | | 021 | | | |
| | 046 | | /TRY NEXT CHAR | 23 345 | 106 | CAL | TICK | |
| | 021 | | | | 061 | | | |
| 23 156 | 310 | LBA | /SAVE CHAR IN B REG TEMP | | 021 | | | |
| 23 157 | 006 | LAI | MOREND | | | | | |
| | 020 | | /GET HIGH LIMIT TO A FOR COMPARE | 23 350 | 066 | LLI | DTFIFO | /SET UP TO POP THE STACK |
| 23 161 | 275 | CPH | /PAST END OF TABLE? | | 364 | | | |
| 23 162 | 140 | JTC | NTFND | | 056 | LHI | DTFIFO | /POINT AT STACK |
| | 225 | | /YES, WITH NO MATCH | 23 352 | 025 | | | |
| 23 165 | 006 | LAI | MOREND | 23 354 | 106 | CAL | POP | /POP THE STACK |
| | 366 | | /GET LOW LIMIT TO A FOR COMPARE | | 014 | | | |
| 23 167 | 276 | CPL | /PAST END OF TABLE? | | 021 | | | |
| 23 170 | 140 | JTC | NTFND | 23 357 | 007 | RET | | /NEXT TASK |
| | 225 | | /YES, NO MATCH | | | | | /END OF THE OUTPUT ENCODED DRIVE TASK SUBROUTINE |
| | 023 | | | | | | | |
| 23 173 | 301 | /IF HERE, STILL IN TABLE. TRY CONTENTS AGAIN | | | | | | |
| 23 174 | 104 | LAB | /RETURN CHAR TO A REG | | | | | |
| | 147 | JMP | THIS | | | | | |
| | 023 | | /LOOP FOR NEXT TABLE ENTRY CHECK | 23 360 | 056 | /KEYBOARD DECODER FOR NON COMMAND MODE | | |
| 23 177 | 006 | HCONVT, | LAI | ASCTAB | 024 | IDLE, | LHI | KYFIFO |
| | 225 | | ASCTAB | /COMPUTE REL DISPLACEMENT LOW | 066 | | | /POINT AT CHAR COUNT |
| 23 201 | 024 | SUI | MORTAB | | 305 | LLI | KYFIFO | |
| | 306 | | | 23 362 | 066 | | | |
| 23 203 | 140 | JTC | MOK1 | | 250 | XRA | | /CLEAR THE A REG |
| | 207 | | | 23 365 | 207 | ADM | | /CHAR COUNT TO A REG |
| | 023 | | | 23 366 | 053 | RTZ | | /BUFFER EMPTY, TRY SOMETHING ELSE |
| 23 206 | 051 | DCH | /HANDLE THE BORROW | 23 367 | 106 | CAL | INCLH | /POINT AT CHAR |
| 23 207 | 206 | MOK1, | ADL | | 046 | | | |
| 23 210 | 100 | JFC | MOK2 | | 021 | | | |
| | 214 | | | 23 372 | 347 | LEH | | /SAVE CHAR IN E REG TEMP |
| | 023 | | | 23 373 | 106 | CAL | DCRLH | /POINT AT START OF BUFFER |
| 23 213 | 050 | INH | /HANDLE THE CARRY | | 052 | | | |
| 23 214 | 360 | MOK2, | LLA | | 021 | | | |
| | 006 | LAI | ASCTAB | 23 376 | 106 | CAL | POP | /POP THE CHAR OFF THE BUFFER |
| 23 215 | 006 | | ASCTAB | | 014 | | | |
| | 020 | | /COMPUTE RELATIVE DISPLACEMENT HIGH | | 021 | | | |
| 23 217 | 034 | SBI | MORTAB | 24 001 | 304 | LAE | | /CHAR TO A REG |
| | 020 | | | 24 002 | 074 | CPI | ESC | /IS IT AN ESC? |
| 23 221 | 205 | ADH | /ADD IN THE HIGH POINTER | | 175 | | | |
| 23 222 | 350 | LHA | /H NOW POINTS IN THE OUTPUT TABLE | 24 004 | 150 | JTZ | IDLE1 | /YES |
| 23 223 | 307 | LHM | /REPLACEMENT CHAR TO A REG | | 025 | | | |
| 23 224 | 007 | RET | /ASCII CODE IN A REG RETURN | | 024 | | | |
| 23 225 | 006 | NTFND, | LAI | BLANK | 056 | LHI | DTFIFO | /OUTPUT IN CODE |
| | 040 | | | | 025 | | | |
| 23 227 | 007 | RET | /ERROR RETURN | 24 011 | 066 | LLI | DTFIFO | /SET UP FOR ENTPAK |
| | | | | | 364 | | | |
| | | | | 24 013 | 310 | LBA | | /DATA IN B REG |
| | | | | 24 014 | 026 | LCI | BUFOUT | /SIZE IN C REG |
| | | | | | 060 | | | |
| | | | | 24 016 | 106 | CAL | ENTPAK | |
| | | | | | 367 | | | |
| | | | | | 020 | | | |
| 23 230 | 056 | OTPUT, | LHI | DTFIFO | 112 | CFZ | WHOOO | /BUFFER FULL, TELL USER |
| | 025 | | | | 305 | | | |
| 23 232 | 066 | LLI | DTFIFO | | 021 | | | |
| | 364 | | | 24 024 | 007 | RET | | /DONE |
| 23 234 | 250 | XRA | /CLEAR THE A REG | 24 025 | 056 | IDLE1, | LHI | CHMND |
| 23 235 | 207 | ADM | /CHAR COUNT TO A AND FLGS | | 024 | | | /SET FOR COMMAND MODE |
| 23 236 | 053 | RTZ | /NEXT TASK, IF NOTHING TO DO | 24 027 | 066 | LLI | CHMND | |
| 23 237 | 106 | CAL | INCLH | | 275 | | | |
| | 046 | | /POINT AT THE DATA | 24 031 | 076 | LHI | 1 | /MODE=1 |
| | 021 | | | | 001 | | | |
| 23 242 | 307 | LAM | /CHARACTER TO A REG | 24 033 | 007 | RET | | |
| 23 243 | 074 | CPI | DELETE | | | | | |
| | 177 | | /ERROR CHARACTER? | | | | | |
| 23 245 | 110 | JFZ | OTPUT1 | | | | | |
| | 264 | | | | | | | |
| | 023 | | /NO, GO TRANSLATE | | | | | |
| 23 250 | 036 | LDI | 7 | | | | | |
| | 007 | | /YES, DO 8 DOTS | 24 034 | 105 | INPEND, | SENSE | /SUBROUTINE TO SERVICE HORSE CODE INPUT |
| 23 252 | 106 | OTERR, | CAL | DOT | 044 | NDI | 1 | /GET CODE INPUT LINE |
| | 120 | | | | 001 | | | /WE USE THE LSB |
| | 021 | | | 24 037 | 013 | RFZ | | /NOTHING PENDING, EXIT |
| 23 255 | 031 | DCD | /-1 THE COUNT | 24 040 | 056 | LHI | INCHAR | /POINT AT HOLDING REG |
| 23 256 | 110 | JFZ | OTERR | | 024 | | | |
| | 252 | | /NOT DONE...DO IT AGAIN | 24 042 | 066 | LLI | INCHAR | |
| | 023 | | | | 304 | | | |
| 23 261 | 104 | JMP | OUTEND | | 076 | LHI | 1 | /SET UP TO SHIFT IN HORSE |
| | 342 | | /DONE, POP AND EXIT | 24 044 | 001 | | | |
| | 023 | | | 24 046 | 056 | INTIME, | LHI | TIMER |
| 23 264 | 106 | OTPUT1, | CAL | XLATER | 024 | | | /POINT AT TIMER REG |
| | 040 | | | | 066 | LLI | TIMER | |
| | 023 | | | | 303 | | | |
| 23 267 | 330 | LDA | /SAVE THE CHAR IN D REG | 24 052 | 076 | LMI | 0 | /INITIALIZE FOR TIME=0 |
| 23 270 | 074 | CPI | 200 | | 000 | | | |
| | 200 | | /IS IT A BAD CHAR (OR A SPACE)? | 24 054 | 106 | INSENS, | CAL | TICKI |
| | 110 | | | | 107 | | | /WAIT FOR PART OF A BAUD (1/8) |
| 23 272 | 311 | JFZ | GOODCH | | 021 | | | |
| | 023 | | /CHAR OK, SO DO IT UP RIGHT | 24 057 | 056 | LHI | TIMER | /UPDATE TIMER |
| | | | | | 024 | | | |
| 23 275 | 036 | LDI | 6 | | 066 | LLI | TIMER | |
| | 006 | | /SET UP FOR 7 UNITS DELAY(UNITS-1) | 24 061 | 303 | | | |
| 23 277 | 106 | SPACE, | CAL | TICK | 317 | LBH | | |
| | 061 | | | | 010 | INB | | /+1 |
| | 021 | | | | 371 | LMB | | /TIMER+1 |
| 23 302 | 031 | DCD | /DECREMENT THE UNIT COUNTER | 24 065 | 105 | SENSE | | /KEY DOWN? |
| 23 303 | 110 | JFZ | SPACE | | 044 | NDI | 1 | |
| | 277 | | /LOOP UNTIL DONE | 24 067 | 001 | | | |
| | 023 | | | 24 071 | 150 | JTZ | INSENS | /WAIT FOR KEY UP |
| 23 306 | 104 | JMP | OUTEND | | 054 | | | |
| | 342 | | | | 024 | | | |
| 23 311 | 074 | GOODCH, | CPI | 200 | 046 | | | |
| | 200 | | | | 000 | | | |
| | | | /IF A=200 THEN DONE | 24 074 | | LEI | 0 | /IF HERE, KEY IS NOW UP |
| | | | | | | | | /SET E=0 FOR DOT, FIX LATER IF DASH |

MERLIN

THE INTELLIGENT VIDEO INTERFACE

HARDWARE SPECS.

- * Altair/IMSAI Plug-in Compatible
- * 40 Character by 20 line ASCII Display Format
- * 5 by 7 font, 64 Character Generator ROM
- * Dual Resolution Graphics:
100 V by 80 H *or* 160 H
- * Mixed ASCII/Graphics Mode
- * Program Control of:
Cursor: On/Off
Control Characters: Inverted/Blanked
Carriage Returns: Displayed/Blanked
FIXED or FREE (Memory Saver) Format
Video: Black on White or Reversed
ASCII, Graphics or Mixed Mode
- * Plug-in Keyboard Port
- * DMA makes MERLIN the fastest display available
– over 48 K characters per second
- * Sockets and Decoding for *on-board* Memory:
Two 2708 1 K X 8 EPROMs, or
Two 2 K X 8 Mask ROMs, and
One 128 X 8 Scratch Pad RAM

FIRMWARE SPECS.

MERLIN's BASIC INTELLIGENCE (MBI) ROM Contains:

Monitor Functions

- Memory Fill with HEX value
- HEX Memory Dump
- ASCII Text Input
- HEX Memory Input or Modify
- Set Display Format
- Examine/Modify CPU registers
- Copy Memory Blocks
- Define Display Memory Area
- Four User Defined Functions

Editing Functions

- Winking Keyboard Cursor
- Cursor up, dwn, rt, lt, & Home
- Insert and Replace Modes
- Delete Character
- Delete to end-of-memory
- Four Slave Cursor Functions
- Auto *or* Manual Scroll
- Home/Clear
- Six User Defined Functions

- * Built-in linkage, through on-board RAM, to user defined routines creates an indefinitely expandable system.
- * The MBI ROM also includes decoding and direct linkages to our MEI (MERLIN's EXPANDED INTELLIGENCE) ROM and to our forthcoming Cassette-Modem Interface on-board ROM. The MEI ROM contains additional Monitor/Editor software, plus Graphics subroutines.
- * Besides the direct Monitor and Editor commands, the MBI ROM contains many general purpose subroutines including general purpose, selectable I/O drivers and KYB and Display drivers.

PRICING SPECS

| | |
|---|----------|
| MERLIN: kit containing PC boards, IC sockets, User Manual and all parts except memory | \$249.00 |
| MBI: MERLIN's BASIC INTELLIGENCE – 128 X 8 RAM and 2 K X 8 mask ROM containing Monitor/Editor software ... | \$ 34.95 |
| MEI: MERLIN's EXPANDED INTELLIGENCE – 2 K X 8 mask ROM with more Monitor/Editor functions and Graphics subroutines | \$ 34.95 |
| MERLIN User Manual: <i>over 100 pages</i> of detailed hardware and software documentation | \$ 8.00 |

Special Offer: All prepaid MERLIN orders received before 1 November 1976 will receive the MBI ROM FREE.

All prices subject to change without notice.
Mass. Residents please add 5% sales tax.
Dealer inquiries invited.



MiniTerm Associates

Box 268, Bedford, Mass. 01730

```

24 076 301      LAB      /TIMER TO A REG (B** OF BAUD)
24 077 074      CPI      20
24 101 100      JFC      INDASH /IF DASH, SERVICE DASH
      131
      124
      /SEE IF CLOCK MUCH TOO SLOW FOR DOT
24 104 074      CPI      6 /SHOULD BE A 10 IDEAL
      006
24 106 100      JFC      INPOK /CLOCK IS GOOD ENOUGH
      156
      024
24 111 056      LHI      BAUDI~ /NOT GOOD ENOUGH, FIX WPM CONSTANT
      024
24 113 066      LLI      BAUDI
      302
24 115 307      LAM      /WPM TO A
24 116 074      CPI      2 /WPM TOO LOW TO TRACK?
      002
24 120 140      JTC      INPOK /DON'T TRY TO FIX, ALREADY TOO FAST.
      156
      024
24 123 034      SBI      1 /-1
      001
24 125 370      LMA      /BAUDI-1
24 126 104      JMP      INPOK
      156
      024
      /****ANYTHING BEFORE THIS POINT CAN BE IN FROM****
      /****EVERYTHING AFTER THIS POINT MUST BE IN RAM****
24 275 000      CMND, DATA 0 /O=NORMAL MODE, OTHERWISE COMMAND MODE
24 276 000      TWIDTH, DATA 0 /WHEN BYTE IS ZERO, GENERATE A CR/LF
24 277 000      MSSCNT, DATA 0 /TEMP CHARACTER COUNT FOR MESSAGE DUMP
24 300 000      SOH, DATA 0 /SUBMODE FOR DMPSUB O=PRINT 1=SEND
24 301 000      BAUD, DATA 0 /WPM CONSTANT (SEE HEADING ON PROGRAM)
24 302 000      BAUDI, DATA 0 /INPUT WPM VALUE (GETS MODIFIED)
24 303 000      TIMER, DATA 0 /TIME BAUD *8 (10 OCTAL) COUNTER
24 304 000      INCHAR, DATA 0 /INPUT CHAR HOLDING REG
24 305 000      KYFIFO, HLT /INPUT BUFFER
24 304 000      PNFIFO, HLT *KYFIFO+BUFSKY /PRINTER BUFFER
24 364 000      OTFIFO, HLT *PNFIFO+BUFSFN /OUTPUT BUFFER FOR CODE
26 044 000      MSSGBF, HLT *OTFIFO+BUFOUT /MESSAGE BUFFER
24 131 056      INDASH, LHI BAUDI~ /POINT AT INPUT WPM
      024
24 133 066      LLI      BAUDI
      302
24 135 301      LAB      /GET TIMER TO A REG AGAIN
24 136 074      CPI      34 /CLOCK TOO FAST?
      140
24 140 140      JTC      OKDASH /NO.
      154
      024
24 143 307      LAM      /YES
24 144 074      CPI      376 /TIMER REALLY TOO TOO SLOW?
      376
24 146 100      JFC      OKDASH /YES, BAIL OUT!
      154
      024
24 151 004      ADI      1 /+1
      001
24 153 370      LMA      /BAUDI+1
24 154 046      OKDASH, LEI 1 /SET E=1 FOR DASH
      001
24 156 056      INPOK, LHI INCHAR~ /POINT AT CHAR HOLDING REG
      024
24 160 066      LLI      INCHAR
      304
24 162 307      LAM      /GET PARTIAL CHAR TO A REG
24 163 022      RAL      /SHIFT UP ONE BIT
24 164 044      NDI      376 /JUNK THE OLD CARRY BIT
      376
24 166 264      ORE      /BRING IN NEW SYMBOL FROM E REG
24 167 370      LMA      /NEW PARTIAL CHAR TO INCHAR
      /TIME THE INTERSPACE TO FIND WHAT TYPE IT IS.
24 170 056      LHI      TIMER~ /RESET THE TIMER
      024
24 172 066      LLI      TIMER
      303
24 174 076      LHI      0 /TIMER RESET
      000
24 176 106      UPTIME, CAL TICKI /DELAY 1/8 OF A BAUD TIME
      107
      021
24 201 105      SENSE /GET THE KEY STATUS
24 202 044      NDI      1
      001
24 204 150      JTZ      INTIME /KEY DOWN, GET NEXT SYMBOL
      046
      024
24 207 056      LHI      TIMER~ /UPDATE THE TIME
      024
24 211 066      LLI      TIMER
      303
24 213 317      LBM
24 214 010      INB /+1
24 215 371      LMB /TIMER+1
24 216 301      LAB /GET TIMER TO A FOR COMPARE
24 217 074      CPI      377 /END OF MESSAGE?
      377
24 221 110      JFZ      NOTEOM /KEEP LOOPING,
      235
      024
24 224 016      LBI      LF /END OF MESSAGE, CR-LF-CR-LF
      012
24 226 106      CAL      PPAK
      304
      022
24 231 106      CAL      PPAK
      304
      022
24 234 007      RET      /EXIT TO MAINLINE
24 235 074      NOTEOM, CPI 60 /END OF WORD?
      060
24 237 110      JFZ      ENDLET /NO.
      247
      024
24 242 006      LAI      1 /YES, OUTPUT A SPACE
      001
24 244 104      JMP      MPAK /DO IT OUT RIGHT.
      263
      024
24 247 074      ENDLET, CPI 24 /END OF LETTER?
      024
24 251 110      JFZ      UPTIME /NO, KEEP TIMING THE UP TIME
      176
      024
24 254 056      LHI      INCHAR~ /POINT AT HOLDING REG
      024
24 256 066      LLI      INCHAR
      304
24 260 307      LAM      /MORSE FROM HOLDING REG TO A REG
24 261 076      LHI      1 /RESET THE HOLDING REG FOR NEXT CHAR
      001
24 263 106      MPAK, CAL XLAT /ASCII TO A EQUIV OF MORSE
      125
      023
24 266 310      LBA
24 267 106      CAL      PPAK /SET UP FOR PPAK
      304
      /PRINT THE CHARACTER
24 272 104      JMP      UPTIME /KEEP TIMING THE UP TIME
      176
      106
      024
      /O=NORMAL MODE, OTHERWISE COMMAND MODE
      /WHEN BYTE IS ZERO, GENERATE A CR/LF
      /TEMP CHARACTER COUNT FOR MESSAGE DUMP
      /SUBMODE FOR DMPSUB O=PRINT 1=SEND
      /WPM CONSTANT (SEE HEADING ON PROGRAM)
      /INPUT WPM VALUE (GETS MODIFIED)
      /TIME BAUD *8 (10 OCTAL) COUNTER
      /INPUT CHAR HOLDING REG
      /INPUT BUFFER
      *KYFIFO+BUFSKY
      /PRINTER BUFFER
      *PNFIFO+BUFSFN
      /OUTPUT BUFFER FOR CODE
      *OTFIFO+BUFOUT
      /MESSAGE BUFFER
      ASCEND 20 305
      ASCTAB 20 225
      BAUD 24 301
      BAUDI 24 302
      BLANK 00 040
      BUFDUT 00 060
      BUFSKY 00 377
      BUFSFN 00 060
      C 00 103
      CLRMD 22 153
      CMHND 24 275
      CMHNDR 21 150
      CONVY 23 074
      CR 00 015
      DASH 21 126
      DCRLH 21 052
      DEL 23 034
      DELETE 00 177
      DELSYM 00 134
      DMPSUB 21 333
      DOT 21 120
      DSH 23 327
      ENDLET 24 247
      ENTPAK 20 367
      ERCHAR 00 007
      ERROFL 21 011
      ESC 00 175
      ESCSYM 00 044
      ETX 00 003
      FINDOT 21 137
      GOODCH 23 311
      IDLE 23 360
      IDLE1 24 025
      INCHAR 24 304
      INCLH 21 046
      INCLRF 23 031
      INDASH 24 131
      INPEND 24 034
      INPOK 24 156
      INSENS 24 054
      INTIME 24 046
      KYBD 22 227
      KYFIFO 24 305
      L 00 114
      LDNXT 21 224
      LDNXT1 21 232
      LDNXT2 21 272
      LF 00 012
      MCONVT 23 177
      MOK1 23 207
      MOK2 23 214
      MOREND 20 366
      HORTAB 20 306
      MPAK 24 263
      MSGSZ 00 377
      MSSCNT 24 277
      MSSGBF 26 044
      NETX 22 267
      NOTEOM 24 235
      NTFND 23 225
      NTFUND 23 122
      NXTPNT 22 361
      OK 21 006
      OKDASH 24 154
      OK1 23 104
      OK2 23 111
      OTERR 23 252
      OTFIFO 25 364
      OTLOOP 23 332
      OTPUT 23 230
      OTPUT1 23 264
      OUTEND 23 342
      P 00 120
      PNFIFO 25 304
      PNTR 22 316
      PNT1 23 027
      POP 21 014
      POPLOP 21 023
      POPY 21 036
      PPAK 22 304
      PRT 21 317
      PRT1 21 341
      PRT2 22 347
      PR2 22 004
      PR3 22 035
      PR4 21 372
      QUEST 00 077
      RESTRY 20 172
      S 00 123
      SNDNX 22 060
      SOH 24 300
      SOH1 22 024
      SPACE 23 277
      STRT 20 120
      STRT1 20 140
      T 00 124
      TEST 00 074
      TEST1 22 120
      THIS 23 147
      THISIT 23 044
      TICK 21 061
      TICKI 21 107
      TIMER 24 303
      TWIDTH 24 276
      UNPAK 22 164
      UPARR0 00 136
      UPTIME 24 176
      W 00 127
      WAITHT 22 220
      WAIT1 21 070
      WAIT2 21 067
      WHOOP 21 305
      WIDTH 00 110
      WPM 22 133
      XLAT 23 125
      XLATER 23 040
      XLAT1 23 143

```

Your Altair, IMSAI, or Poly 88 will love our Frugal Floppy.TM

It makes program development and loading 100 times faster!

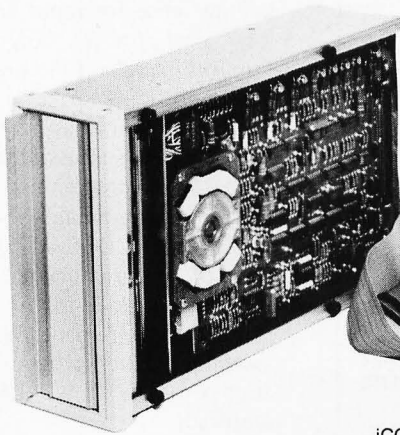
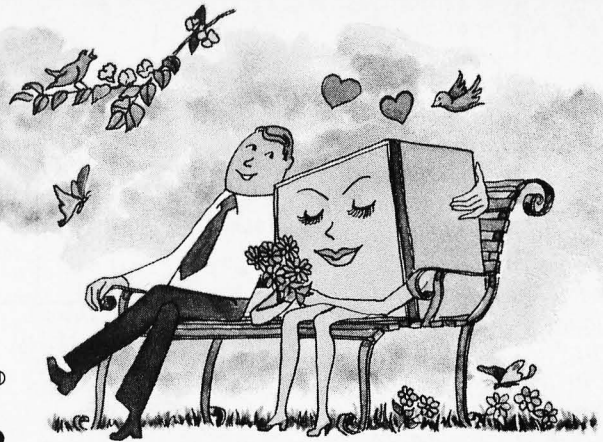

iCOM disk drive

**\$1195 plus
interface card**



iCOM's proven
CF360 controller

Cable to your Microprocessor

The affordable floppy

You've made a big investment in your computer. Here's how to make that investment really pay off. Order iCOM's low cost Frugal FloppyTM Disk Subsystem. Just \$1195 for the disk drive, field proven controller and cables. And you can order our Altair, IMSAI, and Polymorphic bus compatible plug-in interface, with on-board RAM, in kit form or fully assembled.

What it will do for you

With our Frugal FloppyTM you can load and store programs hundreds of times faster than with paper tape, cassette, or teletype. Example—8K of memory can be loaded in just 7 seconds! Plus, you can store up to 256 programs on a single disk. That's why we say our Frugal Floppy will turn on your computer. And fast!

Here's what you get

The Frugal Floppy includes:

- Disk drive with daisy chain capability

- Proven IBM compatible controller
- Interface cable to your computer
- Controller-to-disk drive cable
- All required connectors

If you need a power supply and software, we've got that too.

FDOS-II software

iCOM's famous FDOS-II software is now available for the Altair/IMSAI compatible bus. There's nothing anywhere to compare with our disk based Intel compatible macro assembler and string oriented text editor.

With super features, such as named variable length files, auto file create,

open and close, multiple file merge and delete. Use our software either in your development system or integrate it into your applications package. In either case, it's easy to do. And low cost too.

Fast delivery

See your iCOM dealer today to find out how our \$1195 Floppy can turn on your micro—and fast. If you have any questions, or would like the name of your local dealer, phone us at 213-348-1391. You'll find that when it comes to MicroperipheralsTM, iCOM has the answers. We should. We've delivered thousands of systems to date.

MICROPERIPHERALSTM
iCOM

6741 Variel Avenue, Canoga Park
California 91303 • (213) 348-1391

DEALERS FOR COMPLETE
INFORMATION ON HANDLING
OUR LINE OF MICROPERIPHERALSTM
PHONE OR WRITE iCOM TODAY

Figure 5: The input circuit used by the author in developing the Morse code interpreter. This circuit works but is not optimal. The operational amplifier saturates if any AC signal is present on the input to the bridge rectifier, so the frequency selectivity of this circuit is virtually non-existent (ie: all stations heard in the pass band of your receiver will be logically "ORed" leading to garbled copy if you operate in a crowded band).

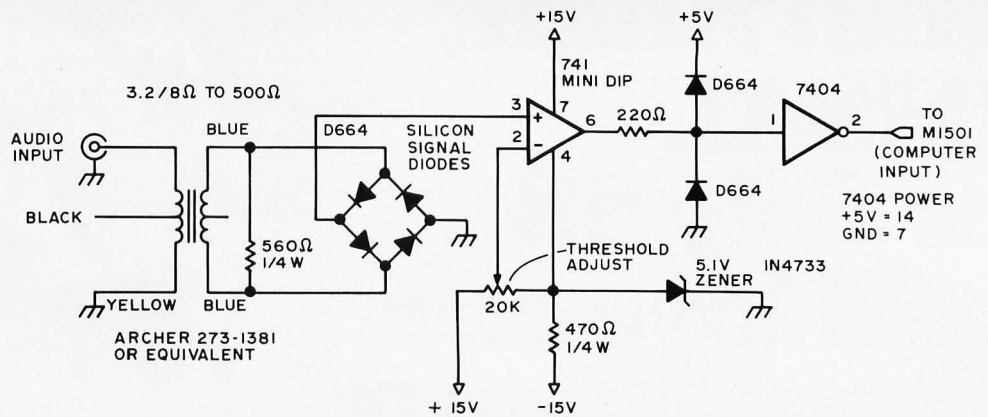

Text continued from page 56

used since they are all driven in the same sequence). In both of the above cases the keying sense for input and output is a TTL low level for a "key down" condition ("mark") and a TTL high level for a "key up" condition ("space").

This program has been tested on a starter set and has successfully operated in both PROM and programmable memory. When used in programmable memory, it should be noted that a DEC M7344YB (or an extra 1 K of programmable memory over the starter set M7344YA) is the minimum memory requirement. When the program is assembled and programmed into PROM, approximately 4 1/2 EROMs (1702A) are required.

Experience to Date

The program has been tested in generating Morse code over the speed range of 7.2 wpm to 120 wpm and appears to function properly. The program has been tested in receiving Morse code over the speed range of 7.2 wpm to 96 wpm: up to about 63 wpm the decoding function is fairly acceptable; at 89 wpm the number of erroneous characters is considered to be unacceptable by the author in this particular test. It is the author's opinion that the error rate at the higher code input speeds is probably related to the design of a particular input processing circuit that was used (see figure 5). In general, a phase locked loop, or a similar highly selective decoding scheme, would be useful, particularly to an amateur radio operator working the crowded bands of a field day type event. One such circuit is illustrated in figure 6. This would provide the amateur with a printout of communications in both directions from the station operating. In fact, with sufficient comment being transmitted to and from the stations involved, the printout from a hard copy terminal would provide a log for the field day events. ■

Some Thoughts on Improvements and Adaptations

The Morse code interpreter described here has been implemented and used by the author. As in any design, there is room for improvement and expansions of the capacity of the program. Here are some suggestions:

- Design a good input filter to pick up audio and output digital (phase locked loop?). See figure 6.
- Add multiple message buffers.
- Use multiple precision arithmetic to provide a larger message buffer.
- Modify the program for RTTY (Replace Morse table with Baudot table, add single byte flag to keep track of FIGS vs LTRS modes).
- Wire 6.3 VAC at 60 Hz into the DEC M7346 module and write a real time clock routine to keep track of time of day.

For individuals with 8080 processors, or the new Z-80, the source code for this Morse code interpreter (see listing 2) can be translated on a one to one basis into code for these newer computers. Such code will work without major changes, but will not make optimal use of the expanded instruction sets.

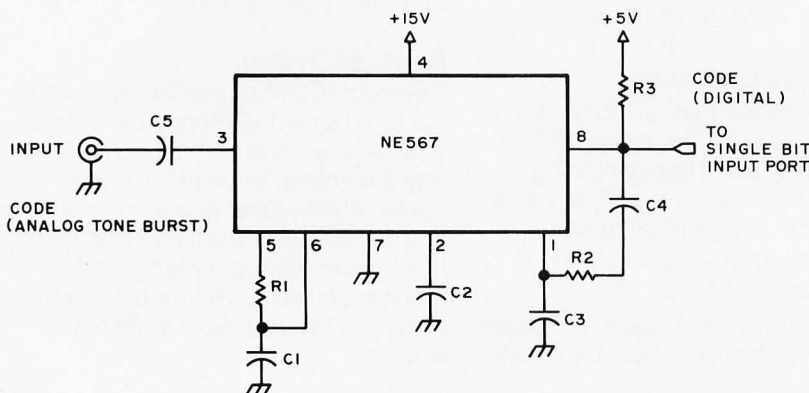

Figure 6: A suggested selective input filter for better performance. This circuit is adapted from the Signetics Catalog, page 6-97. The design equations are shown. The phase lock loop "latches up" when the signal is detected in the filter's band, typically after several tens of cycles. C3 determines the time taken for the filter to detect this condition. The time taken to unlatch after the signal disappears is determined by R2 and C4, with some effects from C3.

Introducing A Remarkable New Microcomputer: **The Astral 2000**

You're reading this ad, so you're obviously interested in getting a microcomputer. You're probably also a bit confused by the number of different microcomputer kits around today. So, think about the things you want in a microcomputer. *Ease of assembly, quality power supply, well designed cabinet and interconnect scheme, peripheral and memory options for an expanding system.*

Some Kit!

Although we have called the Astral a "kit", it actually arrives over 70% assembled. The power supply, processor board and RAM board are fully assembled, burned in and tested before shipment.

There is no complicated wiring harness. In fact, there is no front panel wiring harness at all. The front panel plugs directly into the backplane. Additional circuit boards are inserted through the rear of the chassis directly into the backplane.

Complete System

The Astral 2000 is shipped with power supply, cabinet, front panel components, mother board, processor board and one 8K RAM board. The processor is 6800-based and operates in serial and in parallel. Both RS-232 and 20mA current loop are provided by a serial I/O socket on the processor. This processor is shipped with our own 16K monitor ROM and has provisions for "cycle-stealing" DMA. The memory board contains 8K of low power, 500ns static RAM and uses less than 1.5A at 5V.

Lots Of Options

A computer isn't much fun if you can't talk to it. But you can talk to the Astral with the VID-80 video terminal board for only \$189.95 unassembled (\$245 assembled). The VID-80 has a selectable line length of 64, 72 or 80 characters per line. It displays 16 lines of upper case characters but gives you the option of installing a lower case character ROM as well.

We also have someplace for you to put your programs. Our 8K EPROM board (\$59.95) is designed for the 5204 and will allow in-system program storage even during power-down. This board is assembled with all components except the EPROMs, however sockets are provided for the memory chips.

We've solved program loading, too. The I/O tape interface unit (\$49.95) plugs into the I/O socket on the processor board and allows programs to be loaded from any inexpensive, non-digital tape deck. But if tape cassette isn't fast or big enough, a floppy disk with an Astral bus-compatible controller will be available for under \$1,000 in the last quarter of 1976.

A New And Powerful BASIC

A unique and powerful version of BASIC with features never seen before in an 8K version has been designed especially for the Astral system. Astral BASIC contains all the features of competing BASICs and then some; Astral BASIC is also *very* fast.

With the *User Selectable Floating Point* package, the user chooses the degree of precision from the four choices of 6, 9, 13 or 16 digits. Fewer digits use less memory and is faster, however higher precisions are useful for scientific and mathematic applications.

The Astral BASIC's DO statement is unique; it has never appeared in any other version of BASIC. The DO statement is a simple and flexible way to subroutine without the restrictions of formal subroutines. DOs can be nested, too and — of course — Astral BASIC has all the other standard subroutine procedures as well.

The Trace Mode is another feature rarely found in other BASICs. The Trace Mode is used in program debug to list statement line numbers as executed. This feature may be programmed to Trace On only for routines still needing check-out. Pressing the escape key halts the trace and returns control to the terminal.

The Astral BASIC string facility permits *variable length strings of unlimited length* and includes the ability to search for a substring within another larger string, a particularly useful feature for word processing applications.

Powerful program editing capabilities allow loading, listing and saving of programs. Blocks of statements may be deleted or renumbered. The RENUMBER statement may be used to increment all specified line numbers and it automatically adjusts the numbering of any GO TOs, etc.

Another feature never seen before in an 8K version is the popular PRINT USING statement. PRINT USING permits floating "\$", "+" and "-" signs as well as floating commas, so numbers such as \$1,000,000+ can be printed in the standard accounting format.

 m&r enterprises
P.O. box 61011, sunnyvale, california 94088

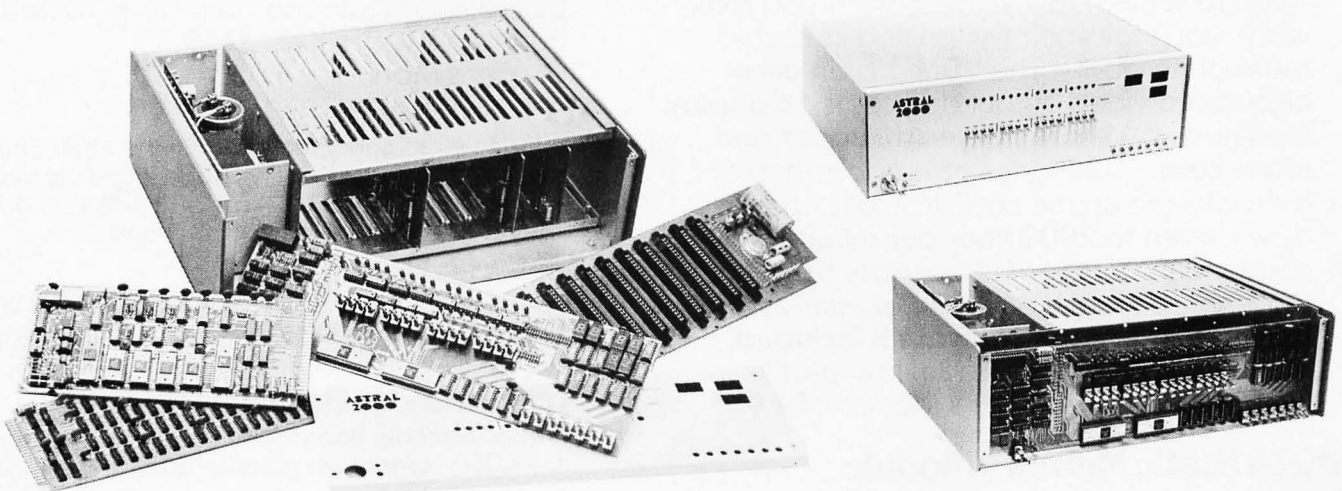

The Astral 2000 is \$995 partially assembled (\$1250 fully assembled) plus \$14 for shipping and handling (\$18 for Canadian orders). Additional 8K RAM boards are \$245 each. California residents add 6% sales tax. The Software Package includes Astral Basic on magnetic tape cassette or paper tape, the game of Startrek, complete documentation and a free one year subscription to the Astral Newsletter, all for \$35. For more details, send a self-addressed, 8½ by 11 stamped envelope to M&R Enterprises, P.O. Box 61011, Sunnyvale, Ca. 94088. Allow approximately 8 to 12 weeks for delivery.

Make a Giant of Y

3P+S Input/Output Module

Our 3P+S is a simple inexpensive answer to handling a variety of peripheral devices. It has **two 8-bit parallel I/O ports**, with full handshaking logic. Plus, it has a **serial I/O port**, with a data rate range from 35 to 9600 Baud. Simultaneously handle a paper tape reader, a keyboard, a TV terminal, a tape punch, **and** a telephone coupler! Available with premium grade low-profile IC sockets, **\$149**. Owner's Manual, **\$4.95***

ALS-8 Assembly Language Operating System

Just turn on the switch, and instantly you have the power to **write, edit, assemble, de-bug, and run your own programs**. The **ALS-8** is the most **useful** software development tool available today. Optional firmware includes **SIM-1**, an interpretive simulator, that simulates programs without running them in real time. Thus, errors encountered during testing do not endanger your entire system. The **TXT-2** firmware adds the dimension of text editing. Insert, delete, move entire lines or single characters, and much more! **ALS-8** (assembled only), **\$425**. **SIM-1**, **\$95**. **TXT-2**, **\$95**.

VDM-1 Video Display Module

If you're setting up just the system you really want, don't fall short by limiting its communicating ability. The **VDM-1** is an **ultra-high speed** video output device. Its **16 display lines** have **64 characters each, upper and lower case**. 1024 bytes of random access memory are on the card. It scrolls up or down, **even to 2000 lines per minute!** Any combination of the 1024 cursors can be displayed as black-on-white or vice versa. **Free terminal mode software is included**, along with premium grade, low-profile IC sockets. **\$199**. Owner's Manual, **\$4.95***

8KRA Static Memory Module

We now offer a low-power static memory module, with a **full 8192 bytes of memory**.

It has an exclusive KSET™ address selection DIP switch, so you can conveniently set address boundaries in increments of 1K. **Our low-power RAM's typically require one-third less power** than those commonly used by our competitors. They'll even retain memory for 4-5 hours when powered by two "D" flashlight cells. **On-board recharging circuitry and battery connectors** make it possible to protect your data against sudden power loss. Each RAM has its own IC socket, too, for easier assembly and repair. **\$295**. Owner's Manual, **\$4.95***

2KRO EPROM Module

The **2KRO Read Only Memory** will accept up to eight 1702A or 5203 EPROM's (not included), providing 2048 eight-bit words of non-volatile storage for monitor, executive, loader and other programs. Programming services available from your dealer or write us for details. **\$65**. Owner's Manual, **\$4.95***

4KRA Static Memory Module

The 4KRA (4096 bytes) was our first static memory module. It's still very popular, and uses the same **low-power static RAM's** as the 8KRA. Plus, we've added a **DIP switch**, and **every RAM now has its own premium grade, low profile IC socket**. On-board recharging circuitry (with battery backup) makes it possible to retain memory for 8-10 hours during power failure. **\$159**. Owner's Manual, **\$4.95***

MB-1 Mother Board

Our single piece **Mother Board** for the Altair 8800 gives you 16-card capacity in one single installation. Available with 12 (**MB-12**) or 16 (**MB-1**) slots. **\$70**. (Discontinued; limited to stock on hand.)

Wire Wrap Board

Do your own wire wrap prototyping with the **WWB Wire Wrap Board**. Up to 62 16-pin sockets or various combinations of 14, 16, 24 and 40-pin sockets. **\$40**.

EXB Extender Board

The **EXB Extender Board** allows accessibility in servicing any 8080-compatible module. **\$35**.

*Fully descriptive Owner's Manual available separately. Price refundable with purchase of kit.

our Minicomputer

Whether your minicomputer system is Sol, IMSAI, or Altair, its real capabilities depend on what goes inside. **Processor Technology Corp.** now offers a full line of 8080-compatible components. From fine static memories to a unique assembly language operating system. We also have a variety of useful software packages, available for little more than copying costs.

Kit Prices are shown, and they **include the Owner's Manual.** Assembled units available at slightly higher prices.

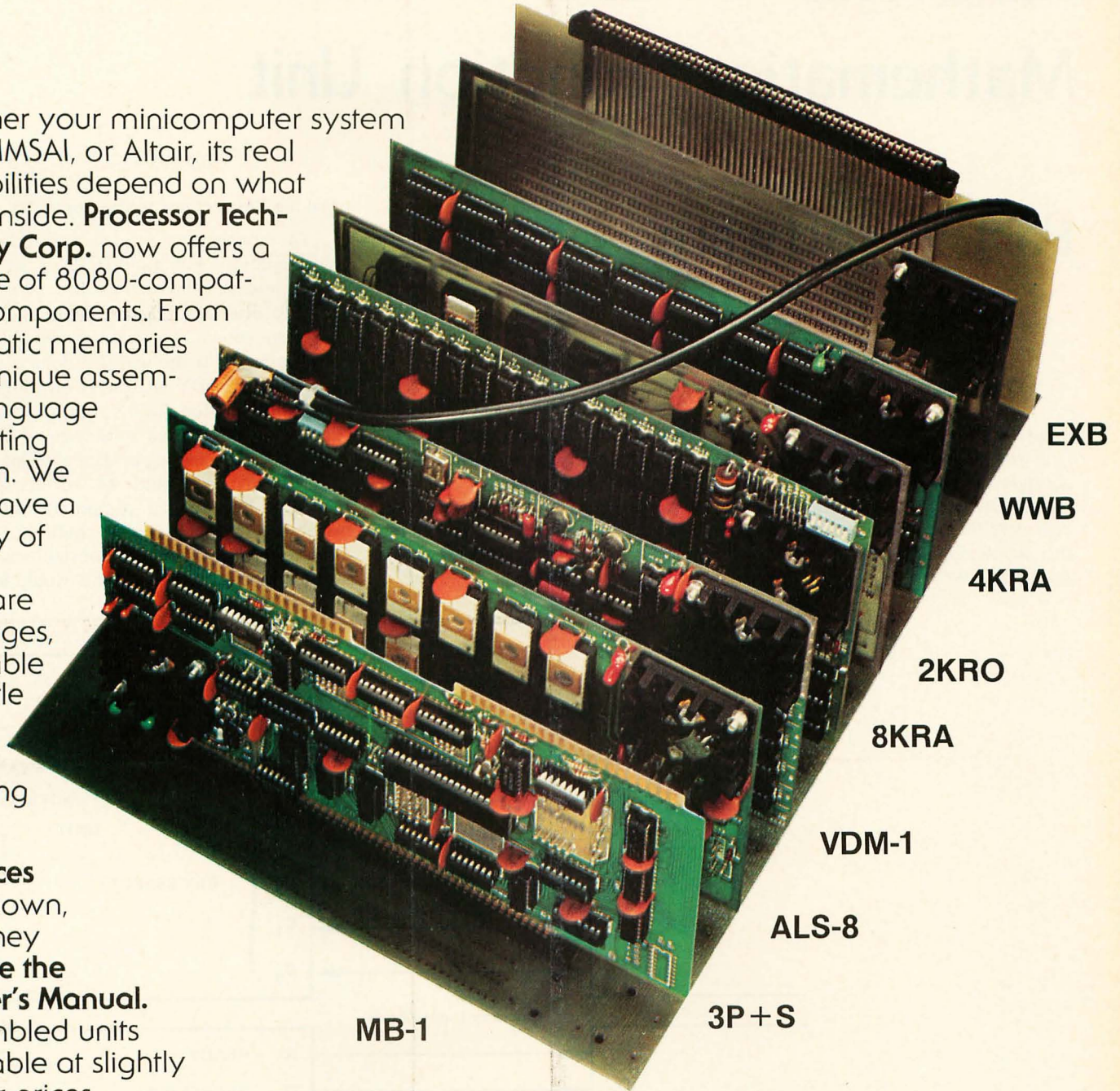

MB-1

3P+S

ALS-8

VDM-1

8KRA

2KRO

4KRA

WWB

EXB

Write Us for further details on all our 8080-compatible products, and for the dealer nearest you.



6200-G Hollis Street
Emeryville, CA 94608

Build This Mathematical Function Unit

Part 2: Software

Making Connections to the Computer

The connections needed to interface the Mathematical Function Unit to an 8 bit microprocessor are summarized in figure 1. In this interface diagram, only the signal wires are shown. A ground connection must also be made. If the wiring is done as shown here, the READY bit (bit 7) on the Mathematical Function Unit's output must be continually examined to determine completion of the calculating or data entering tasks. An alternative would be to attach the READY line to the computer's interrupt structure so the computer could be executing code other than the constant examination of the READY bit. This would lead to

Figure 1: Wiring the Mathematical Function Unit to your computer's IO structure is accomplished by connecting the data input and output lines to appropriate pins of an 8 bit input and an 8 bit output port. For those homebrewing an interface, the 16 interface lines could be provided by a single dual port integrated circuit such as the Motorola PIA design. The software of this article reflects hardware for the input and latched output sides of a single Intel 8080 port.

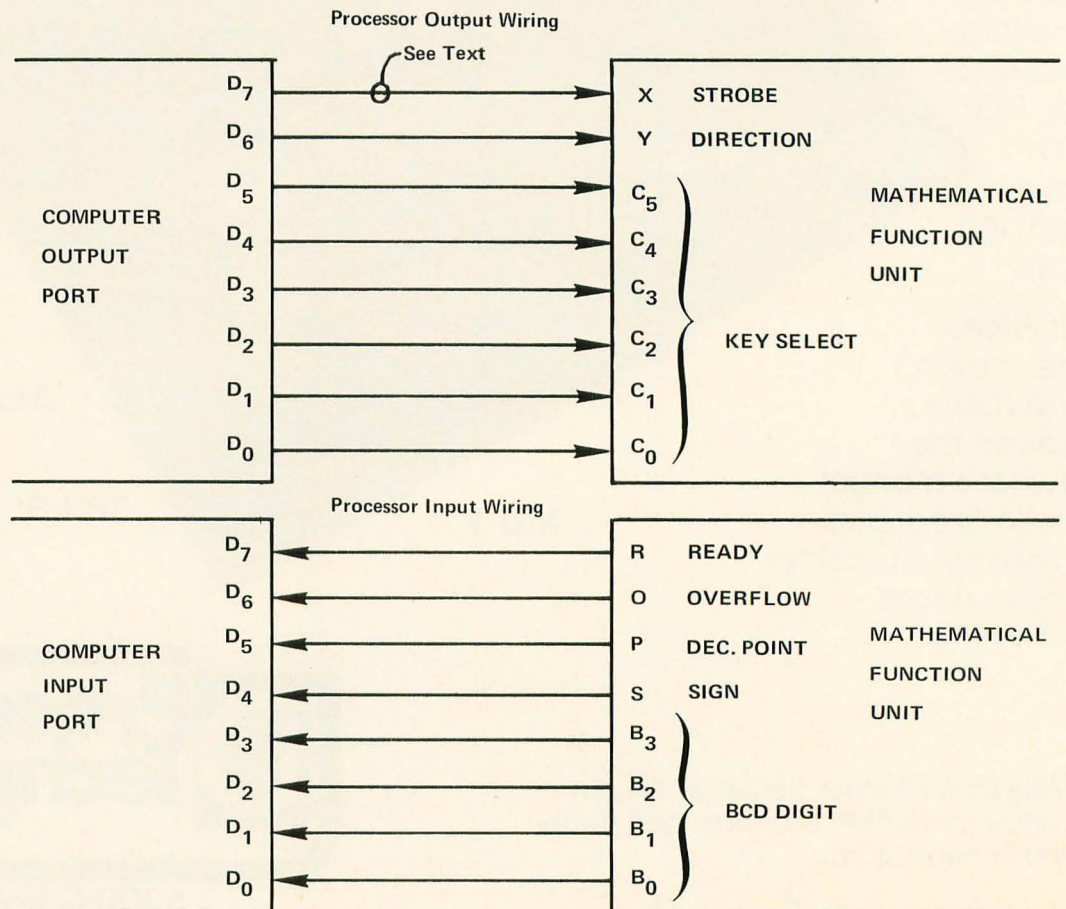

R Scott Guthrie
1374 Franchere Pl
Sunnyvale CA 94087

more efficient usage of the microcomputer and overall system, and will only create some fairly easy software changes from the examples shown in this part of the Mathematical Function Unit article. In either case, software toggling of the X (strobe) line is required to initiate operations.

The operation of the Mathematical Function Unit is governed by signals generated in the controlling computer system's software. The minimum required routines consist of an output procedure, an input procedure, and a short routine to check the status of the ready line, bit 7 of the input interface. The Intellec 8 Mod 80 made by Intel and belonging to the California Polytechnic State University Computer Science Department was used for the program development and all the controlling programs were written in Intel 8080 assembly language code as shown in the listings.

Calculator Entry Routine

The Mathematical Function Unit load procedure, called CAENTR (for CAcalculator ENTeR) passes the code for the required operation to be performed from the microcomputer's main memory to the Mathematical Function Unit. The 8080 assembly language symbolic and absolute code for this routine is shown in listing 1, hexadecimal addresses 010D to 011F.

The CAENTR routine first saves the contents of the A register with a PUSH PSW instruction. Then it checks the Mathematical Function Unit's ready line, waiting if necessary for the unit to enter the ready state. The waiting is accomplished by a reference to the subroutine RDY at address 010F. The accumulator is then cleared to zero with an XRA A instruction, and this state is sent to the calculator via the 8080's output port 3, symbolically referenced as POUT. Note that in the Intellec system used for the prototype, the hardware inverts the state of the data. Thus all references to data from or to the IO ports have a complement operation

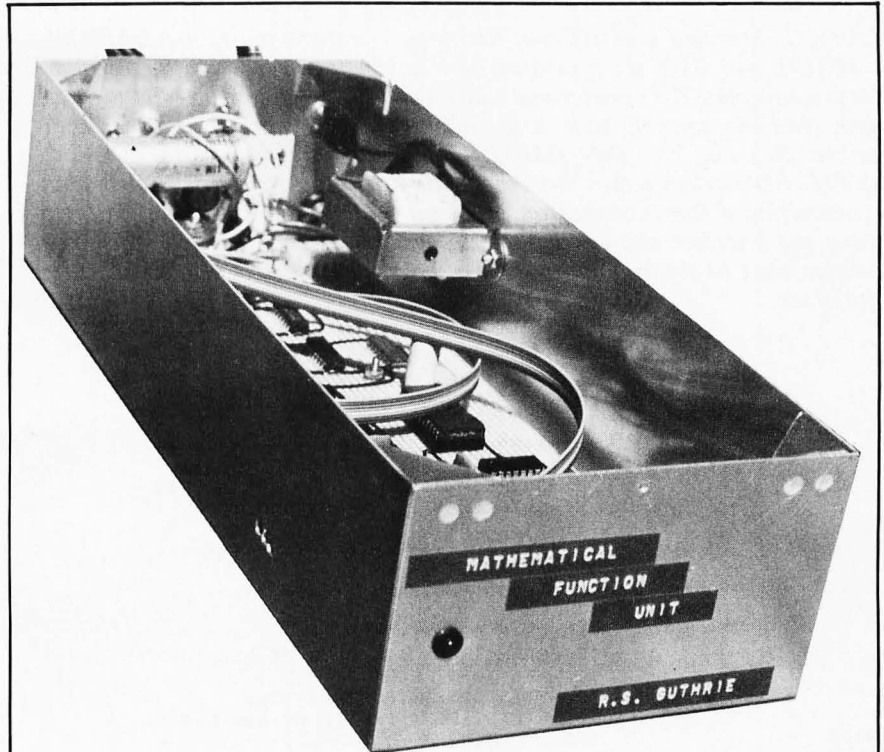

The purpose of this design project was to develop an economical and reliable method of performing simple arithmetic, trigonometric and logarithmic functions in microcomputer systems. Software routines for floating point arithmetic and transcendental functions involve extensive algorithms and complex programming on contemporary microprocessors (indeed, on any computer). A great deal of valuable memory area is often required even for some of the simpler mathematical routines. This is especially true when using the limited instruction sets of the contemporary 8 bit microprocessors. This makes the hardware approach a desirable alternative due to the powerful software available in some calculator integrated circuits on the market today.

In last month's BYTE [page 26], we provided a description of the hardware for a unique Mathematical Function Unit built around the MOS Technology MPS-7529-103 calculator chip. The parallel IO structure of this interface can be used with any system which has 8 bits of parallel output and 8 bits of parallel input capability. In this month's conclusion to the project, software required to control the interface is described, along with a test program to emulate a hand calculator by use of a computer's hard copy or television display terminal. The software is given as developed for an Intellec 8 Mod 80 system, with notes concerning hardware idiosyncracies of that computer.

Listing 1: Standard Input/Output Routines. The standard routines CAENTR, CAFTCH, and RDY are presented here in the Intellec 8 Mod 80 assembly language format. The hexadecimal address and object code is listed at the left, with symbolic assembly code at the right. CAENTR moves a command code to the calculator from DIN. CAFTCH reads the current calculator output to DOUT. RDY delays return until the calculator ready state is indicated, thus synchronizing a fast 8 bit central processor with a slow calculator. Prior to using the interface and calculator routines shown in this article, the stack pointer must be set to point to some area of programmable memory which is not in use.

```

;MATHEMATICAL FUNCTION UNIT
;STANDARD INPUT/OUTPUT ROUTINES
;
;*****
;NOTE: ALL INPUT AND OUTPUT DATA
;IS COMPLEMENTED BY HARDWARE AND IS
;RE-COMPLEMENTED BY SOFTWARE FOR
;THIS REASON.
;*****
;MFU LOAD PROGRAM (CAENTR)
;
;PROGRAM DESCRIPTION:
;PROGRAM TRANSMITS DATA AT LOC 'DIN'
;TO MFU INPUT PORT
;2 BYTES OF STACK SPACE USED
;NO REGISTERS AFFECTED BY SUBROUTINE
0000      ORG      010EH
010D      EQU      010DH
0101      DOUT     EQU      0101H
0003      PIN      EQU      03      ;PORT IN
0003      POUT     EQU      03      ;PORT OUT
010E F5      CAENTR: PUSH   PSW      ;SAVE REG. A
010F CD5201  CALL    RDY      ;TEST FOR READY
0112 AF      XRA      A          ;ZERO REG. A
0113 2F      CMA                ; ** SEE NOTE **
0114 D303    OUT      POUT     ;TOGGLE MFU
0116 3A0D01  LDA      DIN      ;GET CODE
0119 F6C0    ORI      0C0H     ;FORCE '11XXXXXX'
011B 2F      CMA                ; ** SEE NOTE **
011C D303    OUT      POUT     ;SEND CODE
011E F1      POP      PSW      ;RESTORE REG. A
011F C9      RET                ;RETURN
;
;MFU RETRIEVE PROGRAM (CAFTCH)
;
;PROGRAM DESCRIPTION:
;DIGITS 1(LSD) THROUGH 12(MSD)
;ARE LOADED INTO MEMORY STARTING
;AT LOC 'DOUT'. THE INFORMATION
;IS OF THE FORM "ROPSBBBB" WHERE:
;R=READY BIT, P=DECIMAL POINT
;O=OVERFLOW, S=SIGN, BBBB=BCD DIGIT.
;6 BYTES OF STACK USED.
;NO REGISTERS AFFECTED BY SUBROUTINE.
;
0120 F5      CAFTCH: PUSH   PSW      ;SAVE A & PSW
0121 C5      PUSH   B          ;SAVE B & C
0122 E5      PUSH   H          ;SAVE H & L
0123 060C    MVI      B,0CH     ;LOAD 12 IN REG. B
0125 210101  LXI      H,DOUT     ;LOAD ADDR. OF SAVE AREA
0128 CD5201  CALL    RDY      ;TEST FOR READY
012B F3      DI                ;DISABLE INTERRUPTS
012C AF      XRA      A          ;ZERO REG. A
012D 2F      CMA                ; ** SEE NOTE **
012E D303    OUT      POUT     ;TOGGLE MFU
0130 3ECB    MVI      A,0CBH    ;DISPLAY RESTORE KEY
0132 2F      CMA                ; ** SEE NOTE **
0133 D303    OUT      POUT     ;SEND CODE
0135 CD5201  CALL    RDY      ;TEST FOR READY
0138 AF      LOOP1: XRA      A          ;ZERO REG. A
0139 2F      CMA                ; ** SEE NOTE **
013A D303    OUT      POUT     ;TOGGLE MFU
013C 3E80    MVI      A,080H    ;SET TOGGLE BIT

```

associated with the transfer to compensate for the inversion.

The calculator command code to be sent to the Mathematical Function Unit is passed to the CAENTR routine in memory location DIN. This command code is combined with the bit pattern 11000000 using the ORI operation at address 0119. This forces both the X and Y control bits of the computer output port to be in a high state. The X line high starts the Mathematical Function Unit load sequence, and the Y line in a high state indicates that data is to be loaded into the calculator from the computer's port. The low order bits contain the bit pattern of the calculator key selection taken from table 1 on page 31 of September 1976 BYTE. Finally, the CAENTR routine restores the saved contents of the A register and returns to the calling routine.

In using the calculator interface, the procedure is quite simple: Set up a calculator control code from that table in the location DIN (hexadecimal 010D in this case) and then CALL CAENTR. One command to the calculator is transferred for each such CAENTR call.

Calculator Fetch Routine

The Mathematical Function Unit read routine, called CAFTCH (for CALculator FeTCH) is responsible for controlling the transfer of data from the unit into the computer's memory.

This routine transfers all 12 digit positions of the calculator chip's output number into 12 sequential locations of the computer's memory starting at location DOUT, shown at location 0101 hexadecimal in listing 1. CAFTCH begins by saving the processor status. Then the subroutine RDY is called to delay until the calculator is ready for data transfer.

When the Mathematical Function Unit is ready, return from RDY is followed by disabling of interrupts with the DI instruction, so that complete transfer of all 12 bytes of calculator display output can occur without interruption. The calculator's "display restore" command [see table 1, page 31, BYTE September 1976] of 0B hexadecimal is then sent, in the form of the code CB (logical sum of 0B and C0). This insures that the Mathematical Function Unit output will be valid prior to reading the data into 12 bytes of memory. After another CALL RDY wait, the program enters a loop extending from address 0138 hexadecimal to 014A. This loop transfers 12 output digits in sequence into 12 consecutive memory locations starting at the location DOUT. (The initial address was set up by the LXI H at

location 0125.) During this loop, the Y control line, bit 6 of the computer output port, is left at a logic 0 level. The X line, bit 7 of the computer output port, is toggled by the instructions at locations 0138 to 013F, setting up the next output transfer from the calculation. After waiting for the ready condition, the data is transferred into the computer at location 0144 with an IN PIN instruction, addressing the input port of the computer. The byte is then saved in memory, and the index register provided by the HL pair is incremented. A loop counter in register B is decremented, and if the loop is not completed, reiteration continues. After all 12 digits have thus been transferred, the interrupts are reenabled and the registers are restored prior to return.

The format of data recovered from the calculator in this transfer process was given in figure 2a found on page 27 of last month's BYTE. The offsets in memory for each byte of the data format were given in figure 2a.

Calculator Ready Routine

The subroutine called RDY is the final component of the basic set of interface driver software. This program is found at addresses 0152 to 015A of listing 1, and is a simple procedure to input from the computer input port (symbolically PIN, absolute value 3 in this case), and test the ready bit, bit 7 of the input pattern. If the ready state is indicated, the subroutine returns, otherwise it keeps reiterating. This routine is used by both CAENTR and CAFTCH.

If the interrupt structure is being implemented, this routine could return control to the operating system, or other programs in memory, allowing them to execute until being interrupted by the ready state of the Mathematical Function Unit.

Alignment Procedures

The three variable resistors, R5, R6, and R7 adjust the length of the following timing pulses:

| | | |
|----|-------------|---------------------|
| R5 | 300 μ s | Set Not-Ready delay |
| R6 | 50 ms | Key Pressed delay |
| R7 | 50 ms | Key Released delay |

The use of three short timing loop programs, with the aid of an oscilloscope, allow these delays to be set. The programs are found in listing 2 and assume a 2 μ s cycle time. Adjustments should be made if your 8080 processor runs at a different speed.

The 300 μ s pulse can be set by connecting the scope probe to pin 13 of IC 1a while executing the 1 ms delay routine,

Listing 1, continued:

```

013E 2F          CMA          ; *** SEE NOTE ***
013F D303       OUT          POUT      ; SEND CODE
0141 CD501      CALL         RDY      ; TEST FOR READY
0144 DB03       IN           PIN      ; GET CODE
0146 2F          CMA          ; *** SEE NOTE ***
0147 77         MOV          M,A      ; SAVE DIGIT
0148 23         INX          H      ; INCR H & L
0149 05         DCR          B      ; DECREMENT B
014A C23801     JNZ         LOOP1    ; CHECK FOR DONE
014D FB         EI          ; ENABLE INTERRUPTS
014E E1         POP          H      ; RESTORE H & L
014F C1         POP          B      ; RESTORE B & C
0150 F1         POP          PSW     ; RESTORE A & PSW
0151 C9         RET          ; RETURN
;
; READY SUBROUTINE
; THIS SUBROUTINE, WHEN CALLED
; RETURNS TO CALLING ROUTINE ONLY
; WHEN MFU IS IN THE READY STATE.
0152 DB03       IN           PIN      ; GET MFU INFO
0154 2F          CMA          ; *** SEE NOTE ***
0155 E680       ANI          080H    ; GET READY BIT
0157 CA5201     JZ           RDY      ; JUMP NOT READY
015A C9         RET          ; RETURN
0000
END

```

Listing 2: Alignment of the oneshots in this circuit is accomplished using timing loop programs which repeatedly toggle certain aspects of the interface. This listing shows three such timing loops, D1MS, D70MS and D140MS.

```

; ALIGNMENT ROUTINES
; 1., 70., AND 140 MS. DELAY ROUTINES
; FOR COMPUTER CYCLE TIME OF 2 US.
;
0000           ORG          200H    ; STARTING ADDRESS FOR 1 MS
0200 CD0B04    D1MS:  CALL         OUTPUT ; OUTPUT STARTING SEQ.
0203 067C     MVI          B,7CH    ; SET FOR 1 MS. DELAY
0205 05       TLOOP:  DCR          B
0206 C20502   JNZ         TLOOP
0209 C30002   JMP          D1MS
;
020C           ORG          300H    ; STARTING ADDRESS FOR 70 MS
0300 CD0B04    D70MS:  CALL         OUTPUT ; SET FOR 70 MS. DELAY
0303 0623     MVI          B,35H    ; SET FOR 70 MS. DELAY
0305 CD1604   CALL         DELAY
0308 C30003   JMP          D70MS
;
030B           ORG          400H    ; STARTING ADDRESS FOR 140 MS
0400 CD0B04    D140MS: CALL         OUTPUT ; SET FOR 140 MS. DELAY
0403 0644     MVI          B,68H    ; SET FOR 140 MS. DELAY
0405 CD1604   CALL         DELAY
0408 C30004   JMP          D140MS
;
; SUBROUTINES
;
040B 3E7F     OUTPUT:  MVI          A,07FH  ; SET X LINE LOW
040D 2F       CMA          ; INVERT FOR OUTPUT
040E D303     OUT          03
0410 3EFF     MVI          A,0FFH  ; SET X LINE HIGH
0412 2F       CMA          ; INVERT FOR OUTPUT
0413 D303     OUT          03
0415 C9       RET          ; RETURN
;
0416 3C       DELAY:  INR          A
0417 C21604   JNZ         DELAY ; *DELAY*
041A 05       DCR          B ; *LOOP*
041B C21604   JNZ         DELAY
041E C9       RET          ; RETURN
0000
END

```

D1MS. The scope's time base should be set at 50 μ s per division and R5 adjusted until the pulse length is six divisions long. This pulse length is not at all critical and does not require exact setting.

The key pressed delay must be approx-

Listing 3: CALCULA, a Calculator Simulator. CALCULA demonstrates the use of the Mathematical Function Unit in an application program. The purpose of CALCULA is to drive the calculator interface as a printing calculator, interpreting ASCII codes from a keyboard as the key strokes on a typical hand calculator. The output of the calculator is displayed after every return operation. The original CALCULA was run with a Teletype for input and output.

```

;MFU-CALCULATOR SIMULATOR
;TTY KEYBOARD SIMULATES
;A HAND HELD CALCULATOR.
;
;*****
;NOTE: ALL INPUT AND OUTPUT DATA
;IS COMPLEMENTED BY HARDWARE AND IS
;RE-COMPLEMENTED BY SOFTWARE FOR
;THIS REASON.
;*****
;
0000      ORG      200H      ;STARTING ADDRESS
010D      DIN      EQU      010DH
0101      DOUT     EQU      0101H
0120      CAFTCH   EQU      0120H
010E      CAENTR   EQU      010EH
;
0200 21B302  LXI      H,HEAD  ;H,L -> HEADING
0203 061C    MVI      B,28    ;HEADING COUNT
0205 4E      PHEAD:  MOV      C,M    ;MOVE CHAR TO C
0206 CDA702  CALL     CO      ;PRINT CHARACTER
0209 23      INX      H        ;INCR. MEM. PTR.
020A 05      DCR      B        ;DEC COUNT
020B C20502  JNZ     PHEAD  ;JUMP NOT DONE
020E CD9C02  LOOP:   CALL    CI      ;GET INPUT CODE
0211 E67F    ANI      7FH    ;REMOVE 8TH BIT
0213 FE0D    CPI      0DH    ;COMPARE WITH RETURN
0215 C27102  JNZ     CODEIN ;JUMP IF NOT RETURN
0218 CD2001  CALL    CAFTCH ;GET DATA FROM MFU
021B 4F      MOV      C,A     ;MOVE RETURN TO C
021C CDA702  CALL    CO      ;PRINT RETURN
021F 0E0A    MVI      C,0AH   ;MOVE LINEFEED TO C
0221 CDA702  CALL    CO      ;PRINT LINEFEED
0224 160C    MVI      D,12    ;DIGIT COUNT TO D
0226 210101  LXI      H,DOUT   ;H,L -> DOUT
0229 7E      DLOOP:  MOV      A,M     ;C(H,L) -> REG. A
022A E67F    ANI      07FH   ;FORCE '0XXXXXX'
022C 77      MOV      M,A     ;REPLACE # IN MEMORY
;CHECK FOR OVERFLOW INDICATOR
022D E6BF    ANI      0BFH   ;FORCE 'X0XXXXXX'
022F BE      CMP      M     ;SAME?
0230 CA3D02  JZ       CONT1   ;YES = JUMP, ELSE,
0233 0E2A    MVI      C,2AH   ;"*" -> REG. C
0235 CDA702  CALL    CO      ;PRINT "*"
0238 1601    MVI      D,01H   ;1 -> D (NO MORE PRINT)
023A C35F02  JMP     CONT     ;BACK TO ROUTINE
;CHECK FOR A NEGATIVE SIGN IN CODE
023D E6EF    CONT1:  ANI      0EFH   ;FORCE 'XXX0XXXX'
023F BE      CMP      M     ;SAME?
0240 CA4B02  JZ       CONT2   ;YES = JUMP, ELSE,
0243 0E2D    MVI      C,2DH   ;"-" -> REG. C
0245 CDA702  CALL    CO      ;PRINT "-"
0248 C35302  JMP     DECPT    ;GO TO DECIMAL PT. ROUTINE
;PRINT # FOUND
024B E60F    CONT2:  ANI      0FH    ;STRIP OFF D. P.
024D C630    ADI      030H   ;CONVERT TO ASCII
024F 4F      MOV      C,A     ;C(A) -> C
0250 CDA702  CALL    CO      ;PRINT NUMBER
0253 7E      DECPT:  MOV      A,M     ;C(M) -> A
0254 E6DF    ANI      0DFH   ;FORCE 'XX0XXXXX'
0256 BE      CMP      M     ;SAME?
0257 CA5F02  JZ       CONT    ;YES = JUMP, ELSE,
025A 0E2E    MVI      C,02EH  ;"." -> REG. C
025C CDA702  CALL    CO      ;PRINT "."
025F 23      CONT:   INX      H        ;INCREMENT H,L
0260 15      DCR      D        ;COUNT DOWN CHARACTERS
0261 C22902  JNZ     DLOOP   ;CONTINUE DISPLAY
0264 0E0D    MVI      C,0DH   ;RETURN -> REG. C
0266 CDA702  CALL    CO      ;PRINT RETURN
0269 0E0A    MVI      C,0AH   ;LINEFEED -> REG. C
026B CDA702  CALL    CO      ;PRINT LINEFEED
026E C30E02  JMP     LOOP    ;DONE WITH OUTPUT
0271 210003  CODEIN: LXI      H,TABLE ;H,L -> TABLE
0274 1E35    MVI      E,53D   ;53 = # OF ENTRIES IN TABLE
0276 FE20    CPI      20H    ;COMPARE WITH SPACE

```

imately 40 ms long for the MPS 7529-103 Calculator Chip and is set using the 70 ms program loop, D70MS. With the scope's input connected to pin 5 of IC 1b and the time base set for 10 ms per division, R6 should be adjusted for five divisions (50 ms). This allows an extra 10 ms from the required 40 ms minimum for assurance that the data will be received in worst case situations.

The key released delay can be set using the 140 ms delay loop, D140MS. Since the 50 ms key released delay does not start until after the 50 ms key pressed delay, the end of this pulse should be around 100 ms from the initiation of the sequence. This can be seen on pin 13 of IC 19a and set by adjusting R7. The scope's external trigger can be connected to pin 5 on IC 1b and the time base set for 10 ms per division for a closer look.

It is not imperative that all pulse delays be exact; however data transmission errors may result if the two 50 ms delays are not set for at least 40 to 45 ms.

What's It Good For?

The application of the Mathematical Function Unit is appropriate wherever calculations must be done. To illustrate a specific case, listing 3 provides a very simple calculator program which will enable an 8080 to drive the unit through the routines of listing 1. A sample of the output is shown in listing 4. The purpose of the CALCULA program is to accept inputs from the normal ASCII keyboard of your computer (here assumed to be connected to a Teletype using input port 0 for data input, input port 1 for status, and output port 0 for data output) and use these inputs to set up command sequences to the calculator. After each "=" operation, the current display output of the calculator is read and printed.

The program is set up in a fairly straightforward manner, using a table located at hexadecimal location 0300 to store the conversion between ASCII input characters and calculator control characters. The list of ASCII codes and their corresponding calculator functions is found in table 1.

To use CALCULA, simply load memory address space from 0100 to 0334 (hexadecimal) with the content of listings 1 and 3, then start the CALCULA program by jumping to location 0200. This begins execution by printing out the heading MFU CALCULATOR SIMULATOR shown at the beginning of listing 4, after which an interactive input of various calculator commands from table 2 can begin. The sample of listing 4 shows uses of many of the calculator functions. The calculator replies with an asterisk (*) if an overflow occurs, as is the

case with the attempt at 100! (100 factorial). Display output is normally printed following the input of a carriage return.

CALCULA is of course only the simplest of possible uses for this unit. For general programming, specialized routines could be written to execute sequences of calculator keystrokes when needed, using data kept in the 12 byte arithmetic format.

It should be fairly easy to implement a simple programmable calculator style interpreter to drive this interface, thus converting your personal computer into the equivalent of some fairly expensive desk top micro-computer packages being sold commercially. Ambitious readers will go even further and implement a BASIC interpreter or some other form of high level language referencing this machine both at compile time and in the run time software packages.

Some Parting Comments

The hardware problems encountered with this design were few. The major inelegancy of the design is probably the requirement for pull down resistors on the calculator chip's output lines. These resistors (R10 to R30) are required to supply the load normally supplied by digit and segment driver circuits,

Listing 4: CALCULA Program Sample Run. This Teletype listing was made using the CALCULA program to drive the Mathematical Function Unit. The command codes for operations are listed in table 1. A carriage return code (hexadecimal 0D) is used to cue the display of calculator outputs after a transfer via CAFTCH.

```
MFU CALCULATOR SIMULATOR
$$
000000000.000
123.456 + 345.678 =
000469.134000
$ ((3+7)*(2+1)/10)*4+3!=
000000018.000
$ 987.321M
000987.321000
$$ 10*14H + 26.579*15H =
0001.26579-13
$$ 45 S
00.7071068000
$ P
03.1415927000
$$ 16. I
00000.0625000
$ 69!
01.7112244098
$ 100!
*
$$ 1 E
02.7182818000
$ 10 R
03.1622777000
$$ 10 Y 2 I =
03.1622777000
$$ 8 Q
000000064.000
$$ F
```

```

0278 C28202      JNZ      AGAIN    ;JUMP IF NOT SPACE
027B 4F          MOV      C,A     ;MOVE SPACE TO REG. C
027C CDA702     CALL     CO       ;PRINT SPACE
027F C30E02     JMP      LOOP     ;BACK TO LOOP
0282 BE          AGAIN: CMP     M       ;COMPARE C(A) WITH TABLE
0283 CA8E02     JZ       FOUND   ;JUMP IF FOUND
0286 1D         DCR      E       ;DECREMENT COUNTER
0287 CA0E02     JZ       LOOP    ;IF NOT FOUND TRY AGAIN
028A 23         INX     H       ;INCR H,L
028B C38202     JMP     AGAIN    ;KEEP TRYING
028E 4F         FOUND: MOV    C,A     ;MOVE FOR PRINT
028F CDA702     CALL    CO       ;PRINT
0292 7D         MOV     A,L     ;MOVE CODE TO A
0293 320D01     STA    DIN     ;STORE CODE FOR MFU
0296 CD0E01     CALL   CAENTR  ;SEND CODE TO MFU
0299 C30E02     JMP    LOOP    ;BACK TO ROUTINE
;
; CHARACTER INPUT ROUTINE
CI:  IN      01    ;01 = TTY STATUS PORT
     ANI    01    ;01 = MASK FOR DATA AVAILABLE
     JNZ   CI     ;JUMP IF NO DATA
     IN    00    ;READ THE CHARACTER
     CMA           ;*** SEE NOTE ***
     RET           ;RETURN TO PROGRAM
;
; CHARACTER OUTPUT ROUTINE
CO:  IN      01    ;01 = TTY STATUS PORT
     ANI    04    ;04 = MASK FOR TTY BUSY
     JNZ   CO     ;LOOP UNTIL READY
     MOV   A,C    ;MOVE FOR PRINT
     CMA           ;*** SEE NOTE ***
     OUT   00    ;OUTPUT CHARACTER
     RET           ;RETURN TO PROGRAM
;
;
HEAD: DB    0DH   ;RETURN
      DB    0AH   ;LINEFEED
      DB    'MFU CALCULATOR SIMULATOR'
;
;
      DB    0DH   ;RETURN
      DB    0AH   ;LINEFEED
;
; *** END OF PROGRAM ***
;
;
      ORG   0300H
TABLE: DB    '0123456789A0'
;
      DB    '0000.+-*/Y=()'
;
      DB    ')PH*0000SCTL'
;
      DB    'GRFDWZMS0000'
;
      DB    'IQXE!'
;
      END      ;END OF TABLE
0000
000987.321000
$Z
0.00000000.000
$ 53C
-.0.9182828000
$ Z
000000000.000
$ 1000. D
000001000.000
$ F
001987.321000
$$
000000000.000

```

NOTE: A 10 by 5 1/2 inch (25.4 by 13.3 cm) printed circuit board with plated through holes is available from RSG Electronics, POB 13, Santa Margarita CA 93453. The price of this board is \$24.95 plus \$1.23 for postage and handling (California residents add 6% sales tax). For questions on obtaining the calculator chip or other parts, please write to the author.

Table 1: Keyboard Code Assignments for CALCULA. The CALCULA program interprets the ASCII keystrokes listed in the "keyboard code" column as the corresponding calculator key functions in the "function" column. The current content of the output displays is printed whenever an ASCII carriage return is input.

| Keyboard Code | Function | Keyboard Code | Function |
|---------------|-------------------|-----------------|--|
| 0 | 0 | E | e ^x |
| 1 | 1 | ! | N! Factorial |
| 2 | 2 | Y | Y ^x |
| 3 | 3 | P | Pi (3.1415927) |
| 4 | 4 | A | Arc |
| 5 | 5 | S | Sine |
| 6 | 6 | C | Cosine |
| 7 | 7 | T | Tangent |
| 8 | 8 | L | Natural Log |
| 9 | 9 | G | Log base 10 |
| . | Decimal Point | Z | Degree to Radian |
| + | Plus | | Mode Switch |
| - | Minus | M | Store in Memory |
| * | Multiply | F | Recall from Memory |
| / | Divide | D | Add to Memory |
| = | Equals | W | Swap X with Y |
| (| Left Parenthesis | \$ | Clear Entry |
|) | Right Parenthesis | \$\$ | Clear All |
| ↑ | Enter Exponent | Carriage Return | Output Current Contents of Display to Main Memory and Output |
| H | Change Sign | | |
| I | Inverse I/X | | |
| Q | X ² | | |
| R | Square Root of X | | |
| X | 10 ^x | | |

which are missing due to the use of MOS buffers in their place.

The Mathematical Function Unit has been overdesigned in several areas. The ready and timing circuitry has been designed for easy modification to accommodate some different calculator chips in place of the one used in this project. The timing pulses can be extended or shortened, or even bypassed if, for example, the key released delay is not needed. All modifications must, however, be carefully considered with the chip's specifications prior to altering the electronics.

The Mathematical Function Unit and the related software routines provide the microcomputer user with a very powerful calculation tool where little could easily be done before. The programming of this peripheral calculator has been found to be very straightforward and uncomplicated, requiring much less memory space (and design time) than would be required to perform mathematical routines with microcomputer software alone.

After considering the speed versus calculation ability tradeoffs, as well as the points mentioned above, I feel this project has been a complete success. I hope the microcomputer hobbyist as well as system designers will take advantage of this method for satisfying their mathematical function requirements in cases where high precision and low speed prove usable. ■

BIBLIOGRAPHY

1. Intel Corporation: *Intel Data Catalog*, 1975, pages 6-1 through 6-64.
2. Intel Corporation: *Intellec 8/Mod 80 Microcomputer Development System Reference Manual*, 1974.
3. Intel Corporation: *Intellec 8/Mod 80 Microcomputer System Operator's Manual* (Preliminary Edition), June 1974.
4. MOS Technology Inc: "Specifications for Single Chip 40 Key Scientific Calculator Array MPS 7529-103" Rev 1, July 21 1975.
5. National Semiconductor Corporation: *CMOS Integrated Circuits*, August 1974.
6. National Semiconductor Corporation: *Digital Integrated Circuits*, January 1974.
7. National Semiconductor Corporation: *Interface Integrated Circuits*, April 1974.
8. National Semiconductor Corporation: *Linear Integrated Circuits*, January 1974.
9. Staken, Patrick H: "Using a Calculator Chip to Extend a Microprocessor's Capabilities," *Computer Design* September 1975, pages 98, 99.
10. Texas Instruments Inc: *The TTL Databook for Design Engineers*, First Edition, 1973.

BROWN-OUT PROOF your ALTAIR 8800

With the unique **Parasitic Engineering** constant voltage power supply kit. A custom engineered power supply for your Altair. It has the performance features that no simple replacement transformer can offer:

- *BROWN-OUT PROOF: Full output with the line voltage as low as 90 volts.
- *OVER-VOLTAGE PROTECTION: Less than 2% increase for 130 volt input.
- *HIGH OUTPUT: 12 amps @ 8 volts; **2 amps total** @ ± 16 volts. Enough power for an 8800 full of boards.
- *STABLE: Output varies less than 10% for any load. Regulators don't overheat, even with just a few boards installed.
- *CURRENT LIMITED: Overloads can't damage it.
- *EASY TO INSTALL: All necessary parts included.

Now more
output

only \$75 postpaid in the USA.
calif. residents add \$4.50 sales tax.

Don't let power supply problems sabotage your Altair 8800

PARASITIC ENGINEERING

PO BOX 6314

ALBANY CA 94706

Source materials supplied by
Claude Kagan, Western Electric
Co.

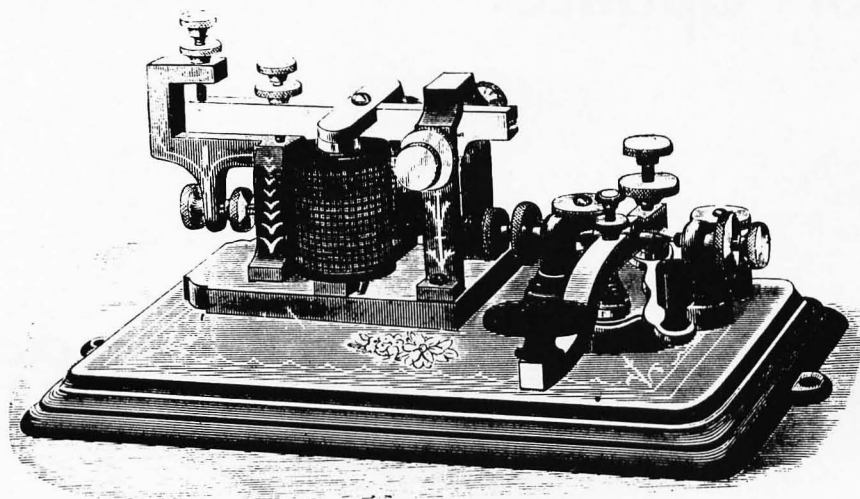

“PRIVATE LINE” INSTRUMENT.

Courtesy of Western Electric
Company from “Catalogue
No. VII” of 1884.

The following text is taken exactly from a privately circulated English language translation of an excerpt (pages 519 to 523) of a French work, Traite De Telegraphie Electrique by Abbe Moigno, published in Paris in 1852.

Telegraph Lines in America

Electric telegraphy has not spread anywhere its mysterious network with as much speed and success as in the United States of North America; nowhere has one either conceived as promptly and executed with such admirable response the happy thought of placing commerce and private enterprise in possession of this all powerful means of communication.

The first American telegraph line was established in 1844, between Washington and Baltimore, on a length of 40 miles. It transmitted with such celerity and promptness the news relating to the election of presidential candidates, that all proclaimed, with a unanimous voice, the excellence and immense importance of these messages prompt as lightning; and one saw the formation at once, on all of the territory of the Union, private companies with the strong intention of making the entire country participate in the unexpected benefit of the electric telegraph. The line from Washington to Baltimore was immediately extended to Philadelphia and New York, over a distance of 250 miles; it reached Boston in 1845, and became the great Northern line on which two lines branched: one, a thousand miles long from Philadelphia to Harrisburg, Lancaster, Pittsburgh, Ohio, Columbo, Cincinnati, Louis Ville (Kentucky), and St. Louis (Missouri); the other, 1,300 miles long, from New York to Albany,

Troy, Utica, Rochester, Buffalo, Erie, Cleveland (Ohio), Chicaga (Illinois), Milwankie (Wisconsin).

[The text goes on to describe further details and give a table totalling the telegraph mileage as of July 1849: 10,885 miles.]

What Was the Public Response to the Telegraphy Revolution?

[Continuing the excerpt] . . . Here is how the work is accomplished: the poles, twenty feet long, are cut in the forests and transported to the site by the neighboring farmers; one implants them into holes a foot and a half deep, one fastens at some distance from the top insulators or glass rings, on which the conductive wire rests. A few days suffice to see the rise, as by enchantment, of a long line of poles. The surveillance and protection of the poles and of the wire is entrusted to these same farmers, all provided with the small instruments required by such a simple task: a hammer, cutters, a vise, pliers, some screws, some rings and some nails.

The telegraph lines usually follow post roads, and their maintenance costs absolutely nothing; there is no instance that the wires, delivered to the good public sense, were broken through meanness. It is because in America all the wishes cooperate in concert for the public welfare, and that all useful invention is like a family heirloom that all wish to safeguard. Each farmer participates at the very least by his contribution of labor and materials, if not through his purse, to all the national undertakings; each thus becomes a shareholder and is interested in seeing them prosper. ■

Microprocessor Update:

Keep PACE with the Times

Robert Baker
15 Windsor Dr
Atco NJ 08004

The new National Semiconductor IPC-16A/500D microprocessor commonly called PACE for Processing And Control Element is a single chip 16 bit microprocessor packaged in a standard 40 pin dual in line package. As a 16 bit general purpose computer it is an excellent candidate for personal computing applications.

Table 1: PACE Status and Control Flags. These flags are tested to control program execution as a result of various conditions.

| Flag Register Bit | Flag Name | Description |
|-------------------|-----------|---|
| 0 | 1 | Always logic 1, not used. |
| 1 | IE1 | Flags IE1 to IE5 serve as interrupt enable flags for 5 of the 6 PACE interrupt levels. These interrupts are ignored when IE bit is low. |
| 2 | IE2 | |
| 3 | IE3 | |
| 4 | IE4 | |
| 5 | IE5 | |
| 6 | OVF | Set to the state of the 2's complement arithmetic overflow by arithmetic instructions. |
| 7 | CRY | Set to the state of the binary or decimal carry output of adder by arithmetic instructions. |
| 8 | LINK | Link flag is included in shift and rotate operations as specified by instructions. Is unaffected if not selected. |
| 9 | IEN | Master interrupt enable. This line simultaneously inhibits all five of lowest priority interrupt levels. |
| 10 | BYTE | Byte flag selects 8 bit data length when high and 16 bit when low. |
| 11 | F11 | General purpose control flags. Drive PACE output pins to directly control system functions. |
| 12 | F12 | |
| 13 | F13 | |
| 14 | F14 | |
| 15 | 1 | Always 1, addressing for interrupt 0 exit. |

The Microprocessor Overview

PACE utilizes 16 bit instruction words to operate on software selectable, 8 or 16 bit data words for a wide range of applications. There are four 16 bit general purpose working registers available to the user as well as an independent 16 bit status and control flag register that automatically and continuously preserves system status. Table 1 lists the various bits of the status and control register and gives a brief description of the function of each bit. A ten word (16 bit) last in, first out, stack automatically saves return addresses for subroutine calls and interrupt servicing. A stack full or stack empty interrupt is provided to allow software stack expansion when required. A six level, vectored priority interrupt system provides automatic interrupt identification. More than one device may be placed on any given priority level using open collector, wired OR circuitry external to the processor. An individual interrupt enable is provided in the status register for each level and a master interrupt enable is provided for all five lower priority levels as a group. There are also four direct sense inputs and four control flag outputs to implement various single bit status and control functions. Figure 1 shows a functional block diagram of the PACE microprocessor while figure 2 shows the actual pin connections of the dual in line package.

Instruction Set

The PACE microprocessor instruction set consists of a general purpose mixture of 45 instruction types in eight classes as shown in

Table 2: PACE Instruction Set Summary. This table lists the mnemonic and a short description for all of the PACE instructions. For complete functional descriptions and bit patterns consult National Semiconductor's PACE Technical Description document.

Diagrams and information, courtesy of National Semiconductor from their PACE Technical Description.

Mnemonic Operation (or meaning)

Branch Instructions

| | |
|-------------|-----------------------------|
| BOC | Branch on condition |
| JMP | Jump |
| JMP@ | Jump indirect |
| JSR | Jump to subroutine |
| JSR@ | Jump to subroutine indirect |
| RTS | Return from subroutine |
| RTI | Return from interrupt |

Skip Instructions

| | |
|-------------|-----------------------------|
| SKNE | Skip if not equal |
| SKG | Skip if greater |
| SKAZ | Skip if And is zero |
| ISZ | Increment and skip if zero |
| DSZ | Decrement and skip if zero |
| AISZ | Add immediate, skip if zero |

Memory Data Transfer Instructions

| | |
|-------------|-------------------------|
| LD | Load |
| LD@ | Load indirect |
| ST | Store |
| ST@ | Store indirect |
| LSEX | Load with sign extended |

Memory Data Operate Instructions

| | |
|-------------|----------------------|
| AND | And |
| OR | Or |
| ADD | Add |
| SUBB | Subtract with borrow |
| DECA | Decimal add |

Register Data Transfer Instructions

| | |
|--------------|-----------------------------|
| LI | Load immediate |
| RCPY | Register copy |
| RXCH | Register exchange |
| XCHRS | Exchange register and stack |
| CFR | Copy flags into register |
| CRF | Copy register into flags |
| PUSH | Push register onto stack |
| PULL | Pull stack into register |
| PUSHF | Push flags onto stack |
| PULLF | Pull stack into flags |

Register Data Operate Instructions

| | |
|-------------|------------------------------|
| RADD | Register add |
| RADC | Register add with carry |
| RAND | Register and |
| RXOR | Register exclusive or |
| CAI | Complement and add immediate |

Shift and Rotate Instructions

| | |
|------------|--------------|
| SHL | Shift left |
| SHR | Shift right |
| ROL | Rotate left |
| ROR | Rotate right |

Miscellaneous Instructions

| | |
|-------------|------------|
| HALT | Halt |
| SFLG | Set flag |
| PFLG | Pulse flag |

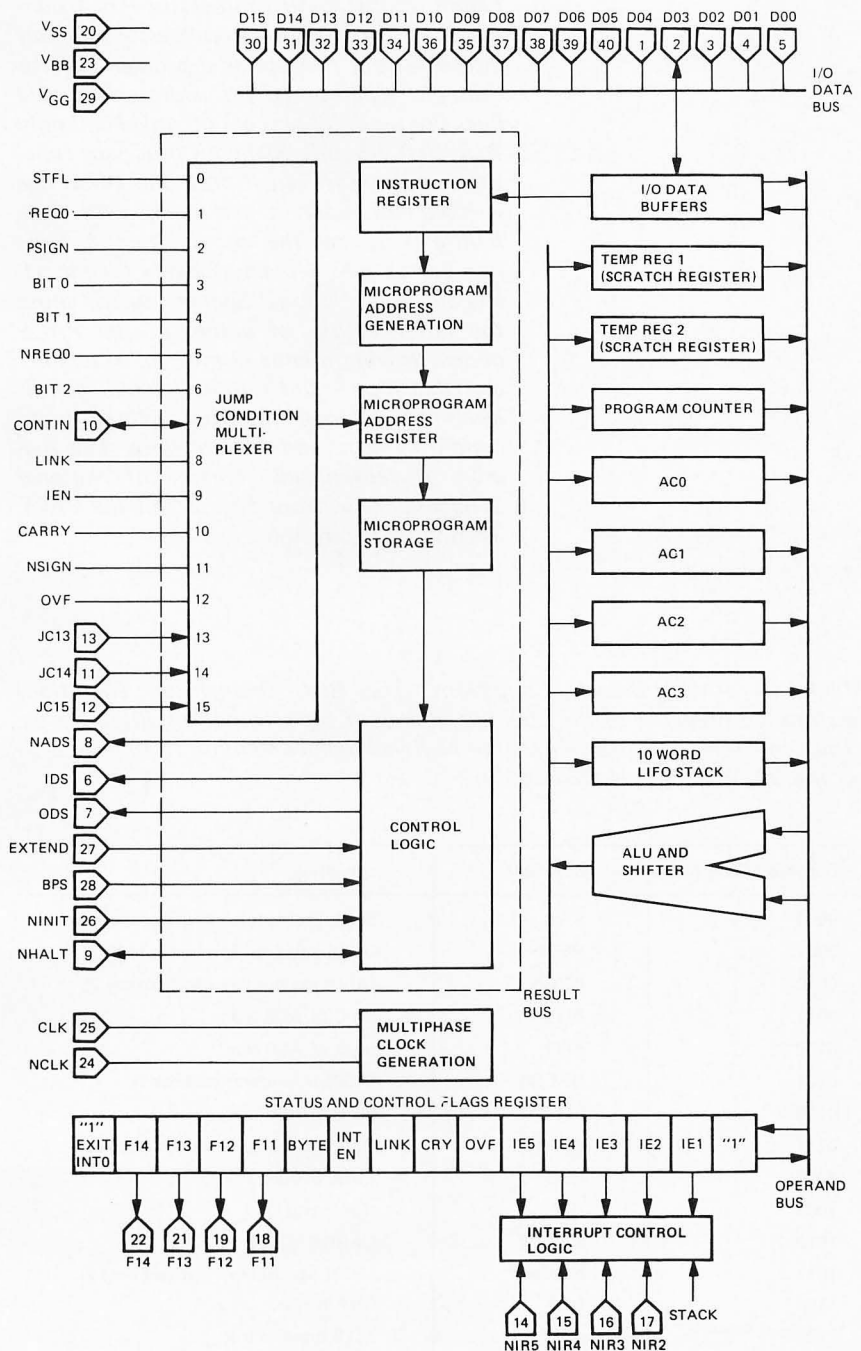
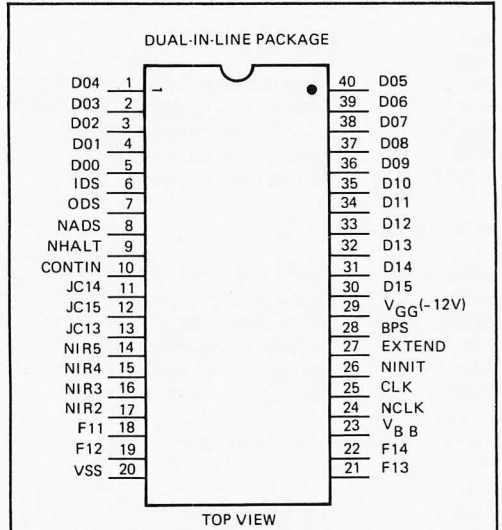

Figure 1: PACE Microprocessor Functional Block Diagram. This diagram shows the major internal sections of the processor, which are reflected in the instruction set. The numbered connections refer to the pins of the processor package, shown in figure 2. This diagram is reproduced courtesy of National Semiconductor from page 2-2 of the PACE Technical Description.

table 2. Conditional branches are implemented using the BOC instruction which allows testing any one of 16 conditions as shown in table 3. Additional testing capabilities are provided by the skip instructions which provide memory and register comparisons without altering data. Memory

reference instructions use a flexible memory addressing scheme which provides three floating memory pages and one fixed page of 256 words (16 bit) each. Figure 3 shows the various memory reference instruction formats used to obtain the four different addressing modes.

Figure 2: PACE Microprocessor Pin Assignments. Fitting a 16 bit processor's pinout into a 40 pin package is a problem: If for example separate 16 bit address and data lines are used, 32 pins are occupied and only 8 are left for miscellaneous processor functions and power. But if only one 16 bit bus is used for address and data, with time multiplexing of the usage, then a large number of pins remain available for miscellaneous uses. National Semiconductor chose the latter course of action in the PACE design, leaving a large number of externally available inputs and outputs including four levels of external interrupts, three jump condition flags, and control lines. This diagram is reproduced courtesy of National Semiconductor, from page 2-3 of the PACE Technical Description.



| PIN | DEFINITION |
|------------|---|
| CLK, NCLK | True and complemented MOS clock input. |
| D00 to D15 | IO MOS data bus lines. |
| IDS | Input data strobe, enables external devices to send data to PACE. |
| ODS | Output data strobe, enables external devices to accept data from PACE. |
| NADS | Address data strobe, clocks address from PACE into ALE. |
| EXTEND | Extended data transfer, increases time duration of data IO transfers for slow memory or peripherals without changing clock frequency. |
| NINIT | Initialize microprocessor functions. |
| CONTIN | Continue jump condition. |
| NHALT | Control panel halt. |
| BPS | Base page select, selects one of two possible base page addressing schemes. |
| J13 to J15 | Jump conditions 13 to 15, user specified branch condition inputs to jump condition multiplexer (see table 3). |
| F11 to F14 | Flags 11 to 14, status and control flag register general purpose control flag outputs. |
| NIR2-5 | Interrupt requests 2 to 5. |
| Vbb | PACE substrate voltage input, derived from Vgg and Vss by STE. |
| Vgg | -12 V supply input. |
| Vss | +5 V supply input. |

Table 3: PACE Branch Conditions. The BOC (branch on condition) instruction branches to the effective address if the selected condition is true. This table is reproduced courtesy of National Semiconductor, from page B-14 of the PACE Technical Description.

| Condition Code (cc) | Mnemonic | Condition |
|---------------------|----------|---|
| 0000 | STFL | Stack Full (contains nine or more words). |
| 0001 | REQ0 | (AC0) equal to zero (see note 1). |
| 0010 | PSIGN | (AC0) has positive sign (see note 2). |
| 0011 | BIT0 | Bit 0 of AC0 true. |
| 0100 | BIT1 | Bit 1 of AC0 true. |
| 0101 | NREQ0 | (AC0) is nonzero (see note 1). |
| 0110 | BIT2 | Bit 2 of AC0 is true. |
| 0111 | CONTIN | CONTIN (continue) Input is true. |
| 1000 | LINK | LINK is true. |
| 1001 | IEN | IEN is true. |
| 1010 | CARRY | CARRY is true. |
| 1011 | NSIGN | (AC0) has negative sign (see note 2). |
| 1100 | OVF | OVF is true. |
| 1101 | JC13 | JC13 Input is true |
| 1110 | JC14 | JC14 Input is true. |
| 1111 | JC15 | JC15 Input is true. |

- NOTES: 1. If selected data length is 8 bits, only bits 0 through 7 of AC0 are tested.
 2. Bit 7 is sign bit (instead of bit 15) if selected data length is 8 bits.

Applications

There is a complete family of support chips designed for PACE which are intended to interface directly to the microprocessor chip. The System Timing Element (STE) provides the necessary MOS clock signals and V_{bbo} supply voltage for the processor chip as well as an optional TTL clock for the user's system. Figure 4 shows how the STE is connected to the PACE microprocessor for a typical application.

The Bidirectional Transceiver Element (BTE) provides single chip, 8 bit input and output buffering between the PACE MOS input bus lines and TTL devices. Figure 5 shows how three BTEs are utilized along with an STE and PACE chip to assemble a system providing a fully multiplexed address and data bus with a minimum chip configuration. The other two support chips, the Address Latch Element (ALE) and the Interface Latch Element (ILE), may be added for more complex systems as shown in the *PACE Technical Description* available from National Semiconductor as publication number 4200078A. This book also illustrates a priority encoder, a control panel, DMA capabilities, application cards, and various applications and features of the PACE system along with the information contained in this article.

User Group

COMPUTE, a National Semiconductor sponsored user group for microprocessor programmers, users, and technical experts publishes a newsletter called *The Bit-Bucket*. They can be contacted at:

COMPUTE/470
National Semiconductor Corp
2900 Semiconductor Dr
Santa Clara CA 95051
(408) 732-5000 X7183

Personal Computing with PACE

The design of the PACE computer is that of a minicomputer. Its instruction set presents a conventional minicomputer architecture (with a stack however, which was usually unheard of in the days of the mini). Looking at the PACE architecture is reminiscent of looking at a Data General NOVA. For those with a strong background in 16 bit minicomputer programming, a 16 bit processor like the PACE would provide an excellent place to take advantage of your present bag of tricks to save time while getting oriented. While no PACE personal computing kits or finished products are presently available (circa June

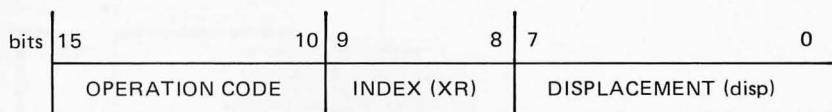

| Index Field | Addressing Mode | Effective Address (EA) |
|-------------|--------------------------|------------------------|
| 00 | Base Page | EA = disp |
| 01 | Program Counter Relative | EA = disp + (PC) |
| 10 | AC2 Relative (indexed) | EA = disp + (AC2) |
| 11 | AC3 Relative (indexed) | EA = disp + (AC3) |

Key: (PC) = Contents of program counter
(AC2) = Contents of AC2
(AC3) = Contents of AC3

Figure 3: Memory Reference Instruction Format. The PACE processor's minicomputer-like instruction set has four addressing modes which are specified by the index field of an instruction. Addressing can be through an 8 bit signed or unsigned base page address selection, an 8 bit signed offset relative to the program counter, or an 8 bit signed offset relative to registers AC2 or AC3. This diagram is reproduced courtesy of National Semiconductor, from pages 2-11 and 2-12, PACE Technical Description.

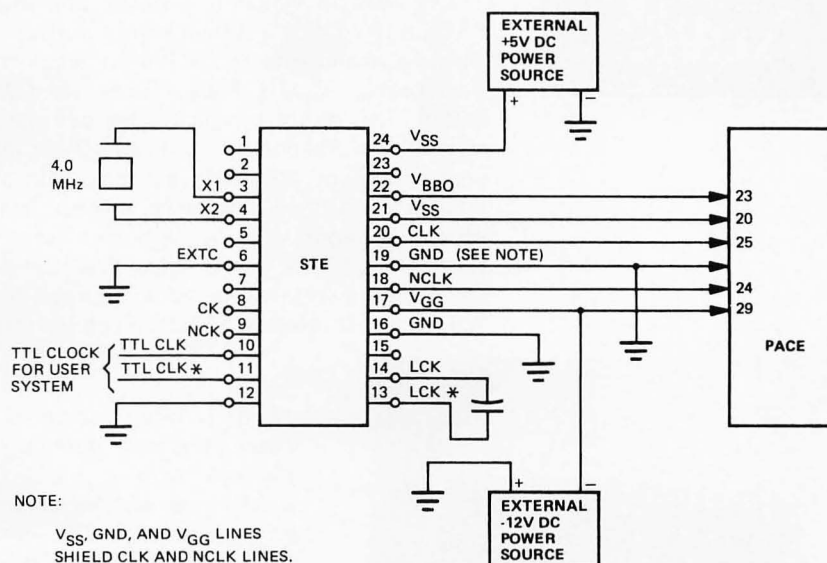

Figure 4: The PACE System Timing Element. In order to make a PACE work without undue engineering inconvenience, National Semiconductor also produces the STE chip which is an omnibus multifunction device including the master timing source, clock generator and driver, and one of the power supplies needed by the chip. The interconnections are shown in this diagram, reproduced courtesy of National Semiconductor from page 2-14 of the PACE Technical Description.

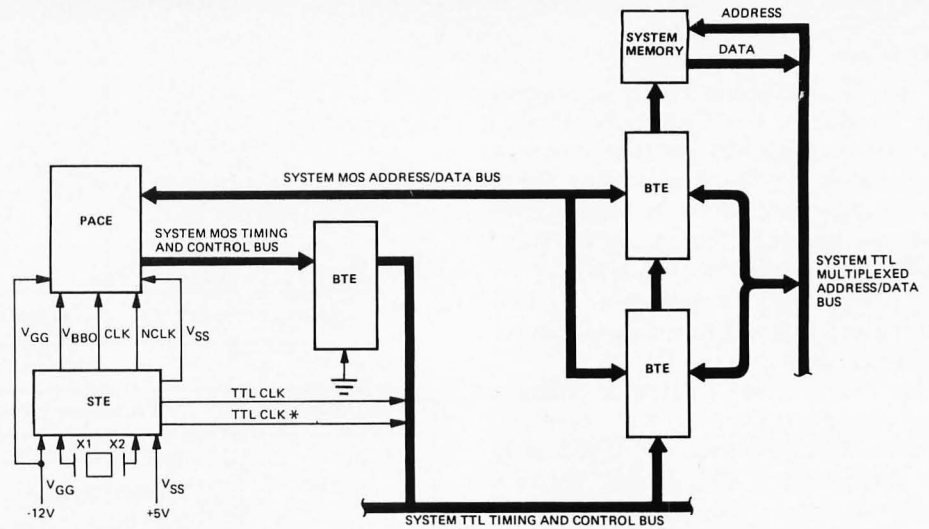

Figure 5: Minimum Chip Configuration. The minimum configuration for a multiplexed addressing and data interface to TTL logic is shown in this block diagram. The blocks labelled BTE are "bidirectional transceiver elements," members of the PACE chip set which are used to sense the MOS level outputs of the processor and drive TTL data bus structures, or in the opposite direction to convert TTL bus levels into PACE compatible input signals. This diagram is reproduced courtesy of National Semiconductor, from page 2-29 of the PACE Technical Description.

1976) for the personal computing market, evaluation kits and products like the Pacer (see below) will provide a convenient way

for readers to obtain this 16 bit byte sized microprocessor. ■

What's New?

So You Want to Keep PACE?

One way in which to evaluate and use PACE is to employ a system known as Pacer, which is manufactured by Project Support Engineering, 750 N Mary, Sunnyvale CA 94086. This product, which came our way recently for evaluation, is available either in kit, semi-kit or assembled versions, with a retail price in the \$1000 range, more or less depending upon specific options chosen. Pacer 1H is totally unassembled, Pacer 2H is completely assembled, tested and burned in, and Pacer 3H is unassembled except for the

tested and burned in logic cards. The pictures accompanying this description are of a Pacer 3H version which we recently assembled.

The basic unit as it comes (see photos 1-3) in its simplest version contains a motherboard with raw power supply, three main logic boards with on board regulators, and a control panel assembly. The three boards in the configuration shown in the photos are:

- The Pacer CPU board with the PACE processor, buffering elements, address decoding for system addresses, and clock logic. This is the board at the right in photo 3.
- Pacer control board which contains the Pacer executive ROM, executive programmable random access memory and initialization logic. This is the center board of the three boards shown in photo 3.
- Pacer memory board which contains slots for 1 K by 16 of 2112 memory chips and 512 by 16 bits of MM5204 programmable read only memory chips. (The unit comes with 256 words by 16 bits of programmable memory and no user ROMs.)



Photo 1: When assembled, Pacer is a neat desk top package with a molded plastic case and calculator style keyboard. The dot matrix alphanumeric display is here shown as it appears when the Pacer is initialized by pressing the INT button.

Also included is the Pacer control card, shown at the top of photo 2 with its ribbon cable running down to the motherboard. This control card contains the logic and switches needed to support the 8 digits of alphanumeric display and key board functions.

What Can You Do with Pacer as It Comes?

In the minimal configuration, you receive a powerful 16 bit PACE processor which basically resembles a Data General NOVA [see Robert Baker's article]. The executive features of this minimal configuration allow the user to enter and debug machine language programs for PACE, using a set of commands much more flexible and sophisticated than the toggle switches of an earlier era. These built-in checkout and debugging features include:

Commands to set, modify and examine the hexadecimal contents of:

- Program counter
- Accumulators 0, 1, 2 or 3
- Stack locations 0 through 9
- Flag register
- Any memory location selected
- Any one of several break point addresses labelled 0 to 9
- Value and mask fields used for search operations

Extended command functions include:

- Hexadecimal calculator: add, subtract display result
- Memory search for value, with optional mask
- Run, restart, initialize, single step the processor.

For initial checkout of machine language programs, this is more than adequate. The bus structure is completely documented in the manuals, and will prove quite expandable using prototyping boards which are also available from the manufacturer. The Pacer has 8 slots available on its backplane after the minimum three cards are inserted.

The Number One Expansion to Make to Pacer

One additional board came with our Pacer, one which both exhibits its expandability and will prove quite useful to anyone wishing to do software development. This is the optional PACE 2 printed circuit card. This addition to the system contains a parallel Teletype current loop interface, an RS-232 interface, and the PACE 2 read only memories.

The read only memories are the key to the usefulness of PACE 2. This board has a simple assembler (and disassembler) pro-

Photo 2: Removing four screws and tilting back the cover of the assembly shows the interior of the machine: a motherboard with raw power supply (unregulated voltages for on board regulators) and positions for eight boards in addition to the three boards of the basic Pacer kits. The control panel board and its ribbon cable are shown mounted on the cover near the top of the picture.

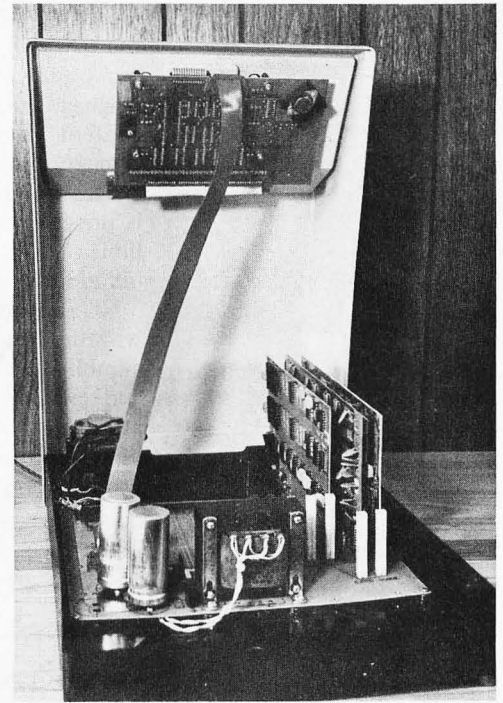

gram and powerful debugging executive, which takes over the system instead of the original read only memory executive of Pacer's minimal configuration. With the addition of PACE 2, the original front panel is essentially ignored with the exception of the restart and initialize buttons. The address space locations of the PACE 2 executive and assembler are contained in an 8 K block of memory which is completely protected by hardware in the standard boards as they arrive. (If desired, it is of course possible to defeat this feature through hardware modifications suggested by the logic diagrams supplied.) The hardware lockout involves write protection and automatic return of hexadecimal FFFF values when referencing the protected locations. In the words of the PACE 2 users guide, "As a result PACE 2 will remain operable even after a massive failure of the user's program"

The memory editing commands of PACE 2 allow the user to display and set memory contents from the terminal using ASCII, signed decimal, unsigned decimal or hexadecimal conversions. Memory listing commands allow the user to get an assembly language formatted output with symbolic references and absolute hexadecimal, sort of a built-in "disassembler" program. Debugging features include a sophisticated memory snap feature tied to break points, snap points or single step execution. This feature allows selected contents of registers, or memory to be dumped when execution

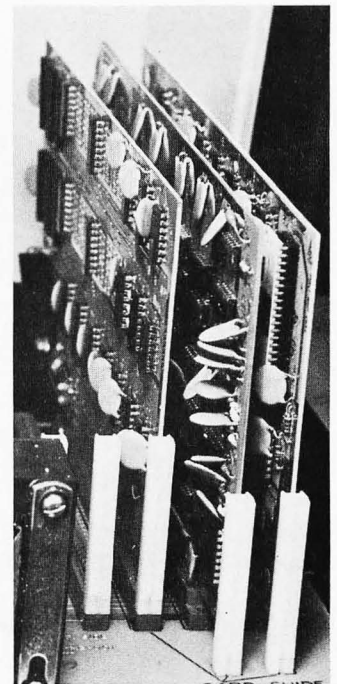

Photo 3: This detailed view shows the three boards of the basic Pacer kit product. The processor itself is the large chip on the rightmost board of the three shown. In the Pacer shown here, additional sockets and card guides which came with the kit are ready for the PACE 2 board and for prototyping boards.

reaches the desired points. As an assembler, the PACE 2 module in its "alter" command mode allows one to insert symbolic assembly language statements to define memory content word by word. The symbol table capacity built into the system when PACE 2 arrives is 26 symbols. By adding memory it is possible to extend the symbol table to a limit of 121 symbols. Each symbol has a 16 bit address value associated with it.

By putting the PACE 2 board together with the Pacer, the result will be an excellent combination of software development tools and expandable hardware which will prove attractive both to the engineer using PACE in systems work, and to an individual who wants a prepackaged 16 bit computer with good systems software support at a moderate price. For further information contact Project Support Engineering. ■

The MOSTEK MK5085N/MK5086N Integrated Tone Dialers

This product provides the electronics needed to simply implement remote access via telephone to computer using a miniature hand held terminal which can be used with any telephone. In such a system, the computer end listens to audio from one of a number of Bell approved electronic tape answering service devices commercially available, and standard touch tone signals are sent to the computer after dialing into its phone port. This MOSTEK chip, built into a tiny case using the circuit described in the MOSTEK documentation, and reproduced here, is used to drive the remote telephone through a speaker you build into the remote package. The computer end must have a

hardware or software tone decoder and a software command interpreter to carry out your remote instructions; for reliability, such software should be stored in ROM against the possibility of power failures. Eventually, commercially produced "universal signallers" using this technology should be available in calculator style packages, but until then you'll have to make your own. Contact MOSTEK at 1215 W Crosby Rd, Carrollton TX 75006. ■

SCELBAL, an 8008/8080 High Level Language

In our June 1976 issue [page 82], we had a product description article on the SCELBAL language, implemented for the 8008 and 8080 processors by Nat Wadsworth and Mark Arnold. Since that time, the language design has been published in detail in SCELBAL Computer Consulting's book of documentation, available at \$49 postpaid.

The documentation is very complete, and expresses Nat Wadsworth's excellent philosophy of giving all the information possible about the subject at a reasonable price. Quoting from the introduction:

... It was known at the start that the program could not be developed to satisfy every potential user. Nobody has a system with that much memory available! Care was taken to provide a good fundamental selection of syntax statements and functions in the language. From that point, backed by the descriptions of the program's organization, general flow charts, and highly commented listings provided in this publication, it is felt that the user will be equipped to add extended capabilities depending on memory available, or willingness to sacrifice described functions.

... The extra measure of providing the information so that the user may go further if desired is the fundamental premise behind this publication.

In the words of the sage, "right on!". This 368 page book contains an overall program logic description of the interpreter spread over the first 11 chapters, totalling some 162 pages. Of these pages, 51 alone are spent on chapter 6 which describes the statement interpretation logic of the program with flow charts, symbolic (commented) assembly language code and verbal descriptions. In the chapter 12, the detailed assembly of SCELBAL for an 8008 is given,

"Figure J" excerpted from MOSTEK's April 1976 data sheet for the Integrated Tone Dialer MK5085N/MK5086N.

DTMF TONE GENERATOR - Fixed Supply Operation
FIGURE J

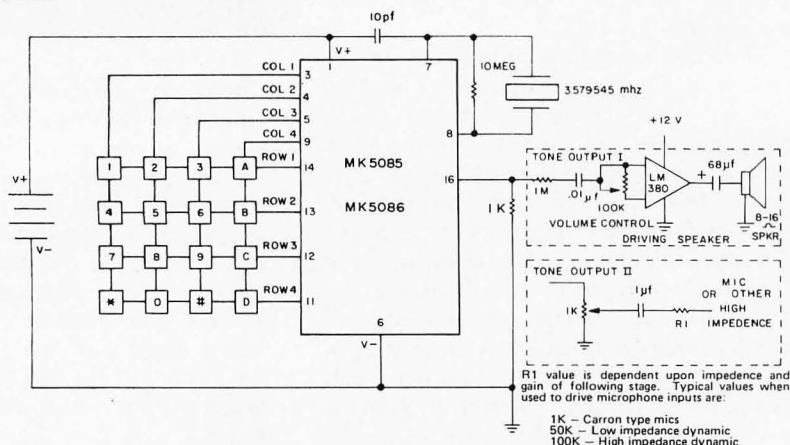

and in chapter 13 the same information is repeated for an 8080 assembly. The detailed assemblies give absolute code for the program in octal, beginning at origin 01/000 for either version. The total memory required is the same in either version since the code is written for an 8008 and simply reassembled for the 8080 version. The actual program code covered by the assembly in either case is approximately 11.5 K bytes. The listings together occupy 164 pages. Chapter 14 contains operating instructions and chapter 15 contains "Suggestions for Program Tinkerers." The book is concluded with a "SCELBAL Labels Reference List" (ie: the symbol table of the assemblies), and several notes pages for patches. The final sheet of the book is a cardboard sheet with a personal "SCELBAL Registration Card," a change of address card, and a pocket reference card. Purchasers of SCELBAL return the registration card in order to be placed upon the update list for errors and patches (several of which are already present on the notes pages).

SCELBI is to be commended for this example of complete and thorough documentation for a high level language product. It will prove a useful volume for any person interested in a high level language like BASIC which has options for customization and extension. ■



The Visible Character Buffer Memory is Here

A firm called Matrox Electronic Systems, of Montreal, Quebec, recently came out with a unique line of inexpensive video display generators in "black box" module form. One of the products which will be of immediate interest to BYTE readers is the new MTX-1632 video display memory, a unit which interfaces to a three state bidirectional processor bus as if it were 512 bytes of programmable memory, and continuously generates a 16 line by 32 character upper and lower case ASCII display in the form of a standard video signal output. The unit is priced at only \$198 in single quantities, and has a memory access time of 650 ns.

The three state bidirectional bus interface has specifications compatible with standard bus drivers such as the National Semiconductor DM8833 and similar chips, so with the addition of address decoding logic it should plug in to most systems with bidirectional buffered data buses. For readers using the Altair, IMSAI, Polymorphics, or Digital Group systems, some interfacing logic will be required to split the bidirectional bus into the "in" and "out" sections required by these systems.



The unit comes in one form, a completely assembled and tested module with a video output drive capability claimed sufficient for 25 standard television monitors to be wired in parallel. Contact Matrox at POB 56, Ahuntsic Stn, Montreal, Quebec CANADA H3L 3N5, (514) 481-6838. ■



Homebrewery vs the Software Priesthood

Mike Wilber
920 Dennis Dr
Palo Alto CA 94303

David Fylstra
PO Box 10051
Stanford CA 94305

The movement of computers into people's homes makes it important for us personal systems users to focus our efforts towards having computers do what we want them to do rather than what someone else has blessed for us.

The movement towards personalized and individualized computing is an important threat to the aura of mystery that has surrounded the computer for its entire history. Until now, computers were understood by only a select few who were revered almost as befitted the status of priesthood. The arts of designing and programming computers have long been regarded as sacred knowledge beyond the reach of the nonspecialist. Indeed, the journeymen of the trade have protected their privileged position by keeping their knowledge to themselves. These high priests and acolytes of the holy alliance of logicians (HAL) have dominated the field so far.

The movement of computers into people's homes makes it important for us personal systems users to focus our efforts toward having computers do what we want them to do rather than what someone else has blessed for us. If personal computing users freely share their hard-won information and even their programs, then this community of users can become quite adept at bending their computers to their own needs and wants.

When computers move into people's homes, it would be most unfortunate if they were merely black boxes whose internal workings remained the exclusive province of the priests. It is fine to use them as black boxes as long as they do what you want, but

the computer's owner should be able to modify its behavior to suit merely personal preferences. That is, computer literacy should be widespread. Now it is not necessary that everybody be a programmer, but the potential should be there. This understanding must be removed from the private reserve of the select few just because computers will be in the hands of the many.

Freely available software is perhaps the key to the independence of the homebrewer.

There are several indications that personal computing users are likely to be highly motivated to generate freely available software. One can be found in the amateur radio community: Hams have a long tradition of freely sharing their feats of engineering. In fact, it is quite natural to be proud of one's accomplishments, and that pride finds quite natural expression in telling all the details to anybody showing the slightest signs of interest. Already there are some signs that computer hobbyists have similar pride in their software achievements. Dr Dobb's *Journal* contains several examples of people contributing adaptations and extensions to Tiny BASIC. The mode of software development is likely to follow the example of program development among the world of paid programmers. For a while, people will contribute incremental improvements to a program (or a concept). During this first half of the cycle, the program becomes progressively more powerful and progressively messier until it is quite hard to understand or modify. Finally, somebody gives up in disgust and rewrites the program in the marvelously clear way that had been growing increasingly conspicuous by its absence. Then another cycle starts, but its starting place is far more advanced than the previous cycle had reached.

"...these are, and of right ought to be, Free and Independent..."

— John Hancock, et al

Personal computing people stand to be largely independent of the priesthood because they are strikingly sophisticated and because they freely share their ideas. A very good example of both these traits can be found in the nearly spontaneous generation of Tiny BASIC through the medium of the People's Computer Company and Dr Dobb's *Journal of Computer Calisthenics and Orthodontia*. One issue published some rough design notes for a machine independent Tiny BASIC, but that was only the beginning. The next few issues published refinements on the design and later ones included an implementation in an interpretive language and then both octal and annotated source programs realizing the interpreter and the entire system in 3 K of 8080 code. To top it off, the whole project was done by far-flung individuals in less than a year.

While Tiny BASIC is a very striking example of what amateurs can do when they work together, we cannot afford to ignore its extreme dependence on good fortune to bring it to pass. Your own copy of BYTE magazine is another example; it is the result of one man's frustration at making his own computer work and his desire to let others profit by his experience. We've been very lucky to have a few people with high ideals to point the way for us, but we would be ill advised to depend on having these fortunate circumstances continue. The time is ripe for the community of personal computing enthusiasts to start thinking seriously about supplying its own steam to back up the energies put out by a few people with strong motivations to help launch the personal computing movement. It's launched now, and we have to provide the impetus and direction to make sure it develops in a way beneficial to the community at large.

A good example of a means to distribute software which divides the effort fairly and in a way nobody seems to mind is the software exchange of the Homebrew Computer Club in the San Francisco Bay Area. At each meeting (every two weeks) there is a table covered with paper tapes of programs contributed by all and sundry. Anybody is welcome to take any tape at all, subject only to the proviso that each copy taken from one meeting be replaced by at least one

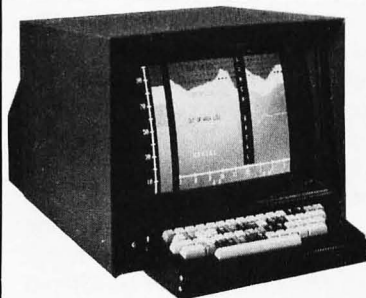
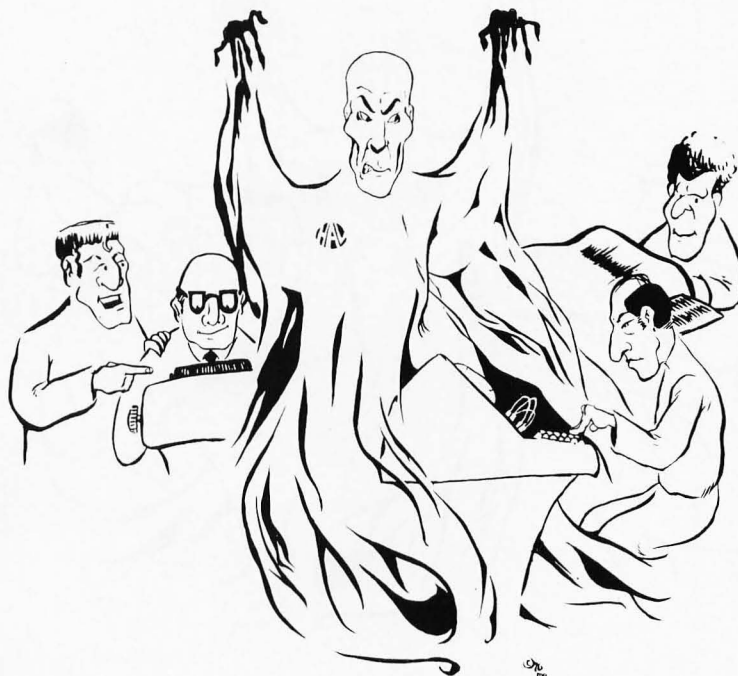

UNBELIEVABLE!!!!

The Intecolor® 8001 Kit

A Complete 8 COLOR Intelligent CRT Terminal Kit

\$1,395

"Complete" Means

- 8080 CPU • 25 Line x 80 Character/Line • 4Kx8 RAM / PROM Software
- Sockets for UV Erasable PROM • 19" Shadow Mask Color CR Tube
- RS232 I/O • Sockets for 64 Special Graphics • Selectable Baud Rates to 9600 Baud • Single Package • 8 Color Monitor • ASCII Set
- Keyboard • Bell • Manual

And you also get the Intecolor® 8001 9 Sector Convergence System for ease of set up (3-5 minutes) and stability.

Additional Options Available:

- Roll • Additional RAM to 32K • 48 Line x 80 Characters/Line • Light Pen
- Limited Graphics Mode • Background Color • Special Graphics Characters
- Games

ISC WILL MAKE A BELIEVER OUT OF YOU.

PE 276

Send me _____ (no.) Intecolor® 8001 kits at \$1,395 plus \$15.00 shipping charges each.

Enclosed is my cashier's check, money order, personal check*

\$350 deposit/kit for C.O.D. shipment for \$ _____

NAME _____

ADDRESS _____

CITY _____ STATE _____ ZIP _____



Intelligent Systems Corp. 4376 Ridge Gate Drive, Duluth, Georgia 30136
Telephone (404) 449-5961

*Allow 8 weeks clearance on personal checks.
Delivery 30-60 days ARO



Software exchange is a two way street: He or she who uses an application or system's program from a community library is assumed to be willing and able to provide programs of equivalent value for others to use.

copy at the next meeting. A few cautions, however, must be repeated every few meetings: that people label the tapes they bring back, that they take reasonable steps to ensure the accuracy of their copies and that they only contribute software with the author's consent. Homebrewers have good intentions but still need occasional reminders to keep them from getting careless.

It is most unfortunate that some people give free distribution to software against the author's wishes. In fact it's usually illegal, and anyone caught could face a heavy fine because the crime is new enough that many think prominent examples should be offered to reduce its frequency. Until that lucky day, the main people being deterred are the people who have contributed the software that has immeasurably helped the whole hobbyist movement get started. Even though we have a tremendous potential for generating our own software, we still owe a tremendous debt (of gratitude besides the money) to those who have brought us Altair BASIC and 6800 BASIC, and who may have enough faith in us to bring us APL and some truly groovy text editors. Freely exchanged software should be truly free and untainted by ripoffs or by the appearance of ripoffs.

The extreme ease of software theft could present a real barrier to free interchange of good software because many valuable people could understandably be reluctant to become very deeply involved in a forum where such ripoffs are commonplace. Theft is so much easier with software than with hard-

ware because software has two distinctive properties:

- A buyer cannot evaluate its benefit without extensive testing and use.
- The elementary operation in moving software is not to transport one copy but to generate another copy.

Another danger threatens free distribution of free software, and for some of the same reasons, a scarcity of documentation which is all too common in software. The temptation is strong: Somebody developing it understands it well and is concentrating on getting it to work at all and usually prefers not to be distracted by efforts to make it comprehensible to others. On the other hand, the task of documentation can easily take as much effort as the development itself. However, documentation is crucial to the value of a piece of software. Undocumented software is very hard to use and even harder to modify. We have no good solutions to either of these problems. The only thing to do is to repeatedly urge people to be mindful of the problems and to broaden their perspectives beyond the gains of the short term.

Telecommunications and the Community Information Exchange

Enthusiasts in this field can share software right now by banding together into clubs, but that medium limits sharing to small groups of people who live near one another. With telecommunications, people can share their programs with others living at long distances from one another. One vital ingredient to such remote communication is the ordinary telephone, which works wonders at spanning long distances between people. Telephones can have the same benefit for computers, if they are equipped with modems, which handle the translation between a computer's digital signals and the audio signals the telephone can handle. Then, one person can call another, and they can use that same call to connect their computers; one computer can run a special program to copy data from a cassette or memory to the phone line; and the other can run another special program to copy the information from the phone line onto its own cassette. Of course, the data being copied will likely be some program the two parties wish to share; and presto, you have an instance of software sharing at a long distance.

While that kind of person to person exchange is quite effective, it leaves room for improvement in several respects. It requires very close coordination between the

two parties, and it requires one phone call for each interchange of data. However, there is another possible mechanism, which can permit widely scattered users to communicate far more freely and with much looser coordination while improving on the economy of phone line usage. That would be a sort of "Community Information Exchange," a computer that would be continually prepared to automatically answer the telephone and would expect a computer to be placing the call. It would be located where a number of individuals (for example members of a local club) could reach it with a local call; it would provide bulk storage facilities, and it would accept commands in a very concise, well understood format from the computer which had called it. Then one subscriber could leave a program in the bulk storage and invite all other subscribers to that Community Information Exchange to copy it to their own systems at their leisure.

This is a very powerful means of broadcasting software among a local community, but it has implicit in it a means of broadcasting opinions and news too. It requires a means of transmitting plain English text between people just so the people will know which programs they can or might wish to communicate to their computers. Once the

individual subscribers can communicate words among themselves, they can communicate much more than news about the latest programs available and how to use them. They can also tell one another about the problems they are having with some program they recently picked up or even about problems they are having with some hardware they recently bought. The computer community can find a great deal of strength in freely sharing that kind of information, in addition to sharing their programs. Free communication of information of all types can greatly enhance the community's resistance to inferior products, and acceptance of superior products.

The Community Information Exchange is not limited to the local communication described thus far. In the dead of night, when telephone traffic is reduced and the transcontinental rates are low, a CIE in one locality can call a CIE in another locality. Then they can send programs and other data back and forth. Of course, they have to know just what should be sent where, and they could be told by their subscribers. The commands they will accept from their subscribers could direct them to copy a file to or from some remote CIE. Nor is it necessary for a CIE to directly call another to

Imagine a Community Information Exchange, complete with telecommunications access ports, mass storage and an accounting algorithm to keep track of operating expenses attributed to each user's activities.

NOTE: The term "Community Information Exchange" was inspired by Michael Rossman.

MODEL CC-7 SPECIFICATIONS:

- A. Recording Mode: Tape saturation binary. This is not an FSK or Home type recorder. **No voice capability. No Modem. (NRZ)**
- B. Two channels (1) Clock, (2) Data. OR, Two data channels providing four (4) tracks on the cassette. **Can also be used for Bi-Phase, Manchester codes etc.**
- C. Inputs: Two (2). Will accept TTY, TTL or RS 232 digital.
- D. Outputs: Two (2). Board changeable from RS 232 to TTY or TTL digital.
- E. Runs at 2400 baud or less. Synchronous or Asynchronous. **Runs at 4800 baud or less. Synchronous or Asynchronous. Runs at 3.1"/sec. Speed regulation $\pm .5\%$**
- F. Compatibility: Will interface any computer or terminal with a serial I/O. (Altair, Sphere, M6800, PDP8, LSI 11, IMSAI, etc.)
- G. Other Data: (110-220 V), (50-60 Hz); 3 Watts total; UL listed 955D; three wire line cord; on/off switch; audio, meter and light operation monitors. Remote control of motor optional. Four foot, seven conductor remoting cable provided. Uses high grade audio cassettes.
- H. Warrantee: 90 days. All units tested at 300 and 2400 baud before shipment. Test cassette with 8080 software program included. This cassette was recorded and played back during quality control.

ALSO AVAILABLE: MODEL CC-7A with variable speed motor. Uses electronic speed control at 4"/sec. or less. **Regulation $\pm .2\%$**
Runs at 4800 baud Synchronous or Asynchronous without external circuitry.
Recommended for quantity users who exchange tapes. Comes with speed adjusting tape to set exact speed.

DIGITAL DATA RECORDER \$149.95 FOR COMPUTER or TELETYPE USE Any baud rate up to 4800



Uses the industry standard tape saturation method to beat all FSK systems ten to one. No modems or FSK decoders required. Loads 8K of memory in 17 seconds. This recorder, using high grade audio cassettes, enables you to back up your computer by loading and dumping programs and data fast as you go, thus enabling you to get by with less memory. Can be software controlled.

Model CC7 . . . \$149.95
Model CC7A . . . \$169.95

NATIONAL multiplex
CORPORATION

NEW — 8080 I/O BOARD with ROM. Permanent Relief from "Bootstrap Chafing"

This is our new "turnkey" board. Turn on your Altair or Imsai and go (No Bootstrapping). Controls one terminal (CRT or TTY) and one or two cassettes with all programs in ROM. Enables you to turn on and just type in what you want done. Loads, Dumps, Examines, Modifies from the keyboard in Hex. Loads Octal. For the cassettes, it is a fully software controlled Load and Dump at the touch of a key. Even loads MITS Basic. Ends "Bootstrap Chafe" forever. Uses 512 bytes of ROM, one UART for the terminal and one USART for the Cassettes. Our orders are backing up on this one. No. 2SIO (R)

Kit form \$140. — Fully assembled and tested \$170.00

Send Two Dollars for Cassette Operating and Maintenance Manual with Schematics and Software control data for 8080 and 6800. Includes Manual on I/O board above. Postpaid.

Master Charge & BankAmericard accepted.
On orders for Recorders and Kits please add \$2.00 for Shipping & Handling. (N.J. Residents add 5% Sales Tax)

3474 Rand Avenue, Box 288
South Plainfield, New Jersey 07080
(201) 561-3600



have access to its file storage. Instead, commands and data could be relayed from one CIE to another until they finally reach their destination. Then, many isolated CIEs would behave like a vast network capable of transmitting software across the country overnight.

We are describing a communication network which can be very effective and which is highly decentralized. In fact, this decentralization is crucial to its effectiveness in promoting free communication between individual computer people. For example, computer manufacturers now organize their customers into user groups in order to provide a forum for communication of ideas and programs among their users. Most communication is channeled through publications controlled by the manufacturer, however; and this all too often results in the encouragement of software and viewpoints which are consistent with those of the manufacturer. On the other hand, it is not necessary to use a centralized forum to encourage people who need it: most of that interaction is on a person to person basis in almost any group.

All well and good, you might say, but just how does the personal computing user compare with the journeyman programmer? Well, the computer amateurs live in a world in which wholesale copying of programs is nearly inevitable. Actually, that represents a

healthy trend in two ways: the person using the copy benefits by its availability; and the program's originator benefits by having helped spread a good example of the programmer's art. Of course, such freely exchanged software may well be worthless at best. That does seem a minor penalty, though, for all the advantages that stand to be gained by ready availability. That is one example of the difference between the two kinds of programmers. That is, a functioning program is required of the professional, while it is merely desired by the amateur user who figures he or she will have to patch and customize anyway. Someone paid to write a program has to make it do what the client wants; a personal computing user has only personal preferences to satisfy. Somebody paying for a program has a right to expect that it will be reasonably efficient in order to conserve the money spent on computer time, while your patience is a much stronger constraint for you than the cost of your computer's time. Somebody paying for a program is quite likely to need the documentation oriented toward people unskilled in the technicalities, while fellow enthusiasts won't need to have all the details explained to them. Finally, deadlines are quite firm in the commercial world but of considerably less importance among amateurs [*except for those who fill magazines once a month! . . . CH*].

While the priests who market the old time software religion can help the personal systems user, such users should be mindful of the benefits to be gained from a healthy measure of independence. If you can get your hands on the symbolic form of freely exchanged software, you can revise it to suit your own needs. That's considerably easier than trying to convince somebody else who supplies a high priced package to make your favorite changes, especially since the other person may differ from you in values, priorities and notions of demand. For the traditionalist software source, a request from a single person could easily seem to represent too narrow an interest to motivate a change or patch. If program source listings are distributed freely and nearly every user has the requisite skills to make patches, then the person wanting something changed will probably be the person making the change. Of course, the end result is nearly the best of all possible worlds: Your home computer will do what you want it to do, and it will do it in the way you want it done. It will not do what somebody else decided it was reasonable for you to want it to do and in a way that it was convenient for somebody else to have it done. ■

BYTE'S BITS

Dear Carl & Jean,
 Aug 6, 1978
HAPPY 12th BIRTHDAY!
 I know you all must have a great deal of satisfaction and sense of accomplishment having completed your first year of publication. This is just a note to let you all know that a lot of other people out there in "reading-land" appreciate your efforts.
 Keep up the good work, and don't be hoping there will be many more Happy Birthdays to come.
 Best Wishes
 Bill Waldob

THAT'S "HAPPY BIRTHDAY" IN NORSE CODE!

Bill Waldob
 28 TURTLE DRIVE
 ASTON MASS 01920

P.S. I received my initial subscription as an earlier letter.

What's Coming Up in BYTE

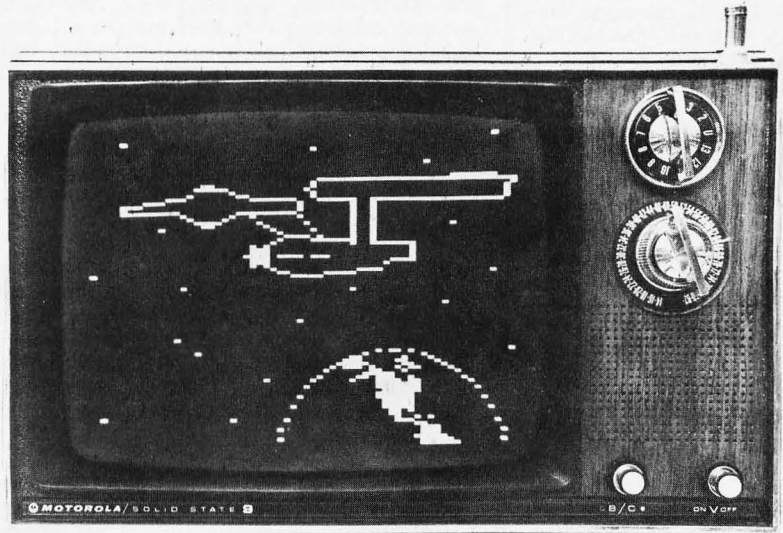

In the November BYTE, you'll find an article by John Deres of Southwest Technical Products Corporation, describing in detail the circuit and operation of the new GT-61 graphics display generator product which Southwest manufactures. Included in John's article is a 6800 program which is used to transfer stored images from the processor's memory to the display generator's memory through a parallel data port. One example given in John's article is the data needed to produce this display on the screen. Also scheduled for November are an article on APL by Mark Arnold, and an article on how to homebrew a 256 by 256 point array display interface written by Thomas R. Buschbach. ■

Networking, Anyone?

Walter Banks of the Computer Communications Network Group, University of Waterloo, Waterloo, Ontario, CANADA N2L 3G1, is interested in talking to radio amateurs and computer people interested in organizing and promoting computer telecommunications networks for amateur experimental use. The definition of a communications software discipline modelled after existing commercial and academic digital networks would be one goal of such activity. Such network activity could be supported "for free" on the radio bands using the OSCAR synchronous satellite when it gets launched, or using the dial-up capabilities of the phone network at the usual Bell rates for long distance calls. Walter can be reached by phone at (519) 885-1211, extension 2847. ■

4K x8 Static Memories

- MB-1 Mk-8 board, 1 usec 2102 or eq.
 PC Board. . \$22 Kit \$100
- MB-2 Altair 8800 or IMSAI compatible switched address and wait cycles.
 PC Board. . \$25 Kit (1 usec) . . \$112
 Kit (91L02A or 21L02-1) \$132
- MB-4 Improved MB-2 designed for 8K "piggy-back" without cutting traces.
 PC Board. \$ 30
 Kit 4K 0.5 usec \$137
 Kit 8K 0.5 usec \$209
- MB-3 1702A's EROMs, Altair 8800 & Imsai 8080 compatible switched address & wait cycles. 2K may be expanded to 4K.
 Kit less Proms . \$ 65
 2K kit . . \$145 4K kit \$225

I/O Boards

- I/O-1 8 bit parallel input & output ports, common address decoding jumper selected, Altair 8800 plug compatible.
 Kit \$42 PC Board only . . \$25
 - I/O-2 I/O for 8800, 2 ports committed, pads of 3 more, other pads for EROMs UART, etc.
 Kit . . . \$47.50 PC Board only . . \$25
 - Misc.
 Altair compatible mother board
 15 sockets 11"x11 1/2" \$40
 Altair extender board. \$ 8
 100 pin WW sockets .125" centers \$ 6
- | 2102's | 1usec | 0.65usec | 0.5usec |
|--------|---------|----------|---------|
| ea. | \$ 1.95 | \$ 2.25 | \$ 2.50 |
| 32 | \$59.00 | \$68.00 | \$76.00 |

- 1702A* \$10.00 8223 \$3.00
- 2101 \$ 4.50 MM5320 \$5.95
- 2111-1 \$ 4.50 8212 \$5.00
- 2111-1 \$ 4.50 8131 \$2.80
- 91L02A \$ 2.55 MM5262 \$2.00
- 32 ea. \$ 2.40 1103 \$1.25
- Programming send Hex List \$5.00
- AY5-1013 Uart \$8.00

All kits by Solid State Music
 Please send for complete list of products and ICs.

MIKOS

419 Portofino Dr.
 San Carlos, Calif. 94070

Check or money order only. Calif. residents 6% tax. All orders postpaid in US. All devices tested prior to sale. Money back 30 day Guarantee. \$10 min. order. Prices subject to change without notice.

Classified Ads for Individuals and Clubs

Readers who have equipment, software or other items to buy, sell or swap should send in a clearly typed notice to that effect. To be considered for publication, an advertisement should be clearly non-commercial, typed double spaced on plain white paper, and include complete name and address information. These notices are free of charge and will be printed one time only on a space available basis. Insertions should be limited to 100 words or less. Notices can be accepted from individuals or bona fide computer users clubs only. We can engage in no correspondence on these and your confirmation of placement is appearance in an issue of BYTE. ■

HELP! I need schematic & information on 3501A Asciscope S/N 14 by LEAR-SIEGLER. Will give almost anything to borrow, reproduce, or even glimpse. Emile Alline, 1119 Penn, Slidell LA 70458.

FOR SALE: KSR-33s, I have a limited number of KSR-33s on stands. We have checked them out on an Altair 8800 and they work like champs. \$495 each while they last. Boyd Martin, 5130 Melvin Av, Tarzana CA 91356 eves and weekends, (213) 345-0903.

FOR SALE: Digital tape cassette transports, MFE model 250, outdated but new. Andruss Peskin Corp, POB 268, Natick MA 01760, (617) 653-3919.

FOR SALE: Disk controller, asking \$800 or best offer, worth better than \$2,600. IBM 2841 disk controller model 1 dual channel, controls up to 8 drives, power supplies, 4 K RAM, all cables and manuals available, maintenance available from IBM. Call Pete Arnett at (305) 671-5631 after 5 PM EST or write 7739 Liverpool, Orlando FL 32807.

FOR SALE: TVT-II (SWTP CT-1024), complete with SWTP power supply, manual cursor control board, parallel interface board, all cables and documentation. Includes wiring changes to make 64 characters per line. All ICs in sockets. Guaranteed working cond, \$175. Also have MITS expander card (no sockets or card guides) \$15. W W Crider, 4011 Oak Hill Dr, College Park GA 30337, (404) 767-6402.

SWAP: Have first 8 issues of BYTE. Want ham radio or electronics magazines. FREE: Schematic & service data for almost any radio receiver or TV set. Make and model number a must; approx age, # of tubes, description helpful. Legal size SASE appreciated. Donald Erickson, 6059-K Essex St, Riverside CA 92504, (714) 687-5910.

FOR SALE: FLEXOWRITER Model SFD. Excellent condition. Has 8 level reader and punch, \$300 or trade for TVT-I or TVT-II. Call or write; William Dawson, 316 21st St, Apt 4, VA Beach VA 23451, (804) 422-5921.

WANTED TO BUY: Video terminal (such as Sanders model 720 but any type would do) at a very reasonable cost. If desired, I would swap for my Busicom digital desktop calculator with 14 digit readout and memory. This is a very early digital calculator but is in good operating condition. Either way, tell me what you have. Rich Nicewonger, 24 Rosewood Rd, Edison NJ 08817.

FOR SALE: Disk drive, IBM 2311 type, 7.25 million bytes. Almost new, manuals and documentation available. Asking \$750. P Arnett, 1730 S Bumby, Orlando FL 32806.

CLEANING HOUSE—If you want a list of items for sale, send SASE to Bob Baker, 15 Windsor Dr, Atco NJ 08004.

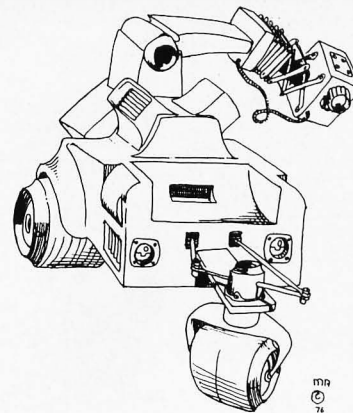

FOR SALE: Three 4 K Altair RAM boards @ \$180. Assembled, tested, excellent cond; memory ICs in sockets, less 100 pin edge connector, postpaid. One 1 K static RAM board, also Altair. As above \$100. John Martin, 808 Day St, Fairmont MN 56031.

FOR SALE: Paper Tape Splices — prepunched for any kind of 8 channel tapes, \$3.50 per 100, postpaid. H Corbin, 11704 Ibsen Dr, Rockville MD 20852.

WANTED: Automatic card reader for demonstration project in the New York City Public School System. Please call: (212) 852-2957 or write: Alex Aderer, 166 Bergen St, Brooklyn NY 11217.

FOR SALE: Altair 8800 system w/ 8 K memory, 88SIO interface, 8 K BASIC complete and ready to run. \$950. Also SWTP CT-1024 terminal complete with case \$300 and Sanyo Monitor \$150. Entire system with manuals guaranteed \$1,400. D Smith, (714) 993-9939, Fullerton CA.

WANTED: MOS KIM-1 or OSI series 400 system, also TI SR-52. Joe Torzewski 51625 Chestnut Rd, Granger IN 46530.

WANTED: Information or documentation for SYNER Data total term. If you have same or know how to repair, please contact: Paul Massod, 338 N Warren Av, Brockton MA 02401, (617) 587-9035.

FOR SALE: MARK-8 CPU circuit board (assembled). Needs 8008 chip, some memory, address and IO latches to get it going. MARK-8 and Intel's 8008 manuals included, \$20. Also Signetics Data Manual (1976) 1200 pages of TTL, ECL, linear, interface ICs, MOS memories, and their latest microcomps, \$8. Frank Canova Jr, 725 Myrtle Av, Green Cv Spgs FL 32043, Phone (904) 284-3408.

WANTED: Software for Altair (BASIC) to keep track of club members, print zip code sorted mailing labels, and "Membership Directory." Write for details. Jack Hardman, 140 Forest Av, Glen Ridge NJ 07028, (201) 429-8880.

FOR SALE: DUMP THE MEMORY of your 6502 system with software system which generates BYTE Standard signal for recording onto cassette. Documented software listing for only \$3. Timing variable to match your clock speed. Ideal for putting in PROM, with space for other programs. Dumps one page or many pages in one run. Don Rindsberg, 5958 S Shenandoah Rd, Mobile AL 36608.

altair^{T.M.} 680b

TECHNICAL INFORMATION

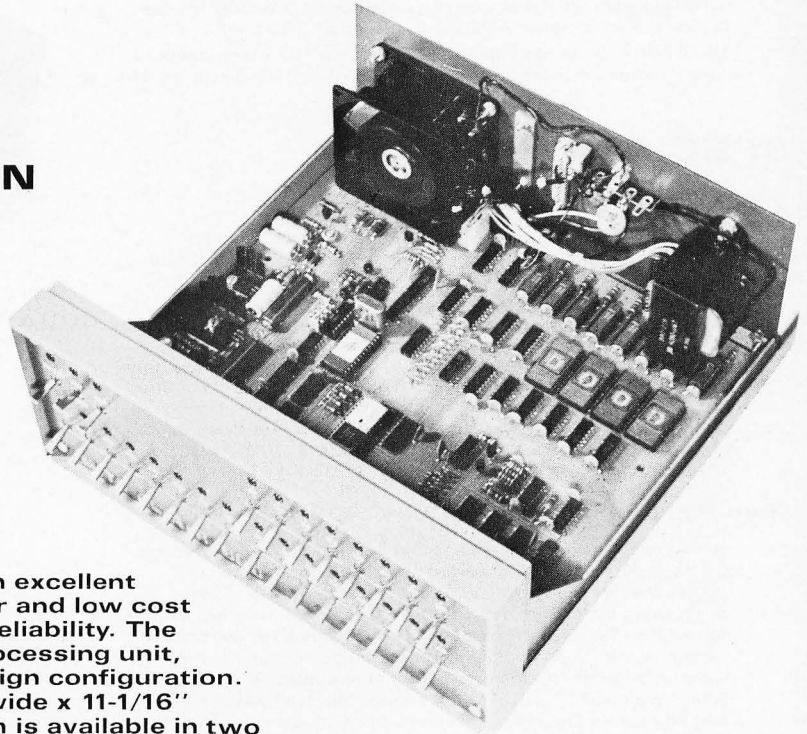

The ALTAIR 680b microcomputer is an excellent compromise between computer power and low cost structure, without sacrificing design reliability. The system is based on the 6800 microprocessing unit, which adapts nicely to a minimum design configuration. The ALTAIR 680b measures 11-1/16" wide x 11-1/16" deep x 4-11/16" high. The basic system is available in two configurations, depending on the intended application.

Almost all of the 680b circuitry is contained on a single large printed circuit board, including memory and a built-in I/O port. The full front panel model contains all of the controls necessary to program and operate the computer and includes an additional printed circuit board, which provides all of the logic circuitry necessary to reset, halt or start the processor. Also located on this board are switches and associated LED indicator lights for each of the sixteen address lines and eight data lines. The front panel circuit board mounts directly to the main printed circuit board via a 100-contact edge connector. The power switch is located on the back panel of the unit for safety purposes. A "turn-key" front panel model, which eliminates all control except restarting the processor, is also available.

The basic ALTAIR 680b computer can be subdivided into five functional sections. These are the MPU and clock, the memory, an I/O port, control and indication, and the power supply. The first three of these sections, along with the power supply regulation components, are located on the main printed circuit board.

At the heart of the 680b system is the 6800 Microprocessing Unit, which is largely responsible for the overall simplicity of the 680b design. The 6800 MPU contains three 16-bit registers and three 8-bit registers. The program counter is a two byte register which keeps track of the current address of the program. The stack pointer is also a two byte register which keeps track of the current address of the program and contains the next address in an external, variable length push-down/pop-up stack. The index register is a two byte register used to store data or a memory address for indexed addressing operations. There are two single byte accumulators used for holding operands and results from the arithmetic logic unit (ALU). The 8-bit condition code register indicates the results of an ALU operation. In this register there are two unused bits, kept at a logic one. The remaining six bits are used to indicate the status of the following: carry; half carry; overflow; zero; negative; interrupt.

The 6800 has seven different addressing modes, with the particular mode being a function of both the type of instruction and the actual coding within the instruction. The seven modes include the following: Accumulator Addressing — one byte instructions, specifying either of the two accumulators; Immediate Addressing — two or three byte instructions, with the MPU addressing the location given in the 2nd or 2nd and 3rd bytes when the immediate instruction is fetched; Direct Addressing — two byte instructions which allow the user to directly address the lowest 256 bytes of memory in the machine; Extended Addressing — three byte instructions, the second two bytes referring to an absolute address in memory for the operation; Indexed Addressing — two byte instructions, the second byte being added to the 16-bit index register to give the address of the operand; Implied Addressing — one byte instructions and the instruction itself gives the address; Relative Addressing — two byte instructions where the second byte is added to the lower 8 bits, allowing the user to address memory + 129 to -125 bytes from the location of the present instruction.

There are several timing and control signals required to operate the MPU. Two clock inputs are required, phase 1 and phase 2. These must be nonoverlapping and run at the Vcc voltage level. In the 680b the clock is a 2-MHz crystal controlled oscillator with logic to provide a 500-KHz two phase clock.

Sixteen active high address outputs are used to specify the sections of memory or I/O to be used. These can drive up to one standard TTL load and 130 pf. There are also eight bi-directional data lines with the same drive capability as the address lines.

NEW MEMORY FEATURES

MITS is pleased to announce the development of a 16K static memory card for the Altair 680b. With an access time of 215 nanoseconds and low power consumption of 5 watts, we feel that this is an excellent addition to the Altair 680b.

The 680b cabinet has room for up to three 16K static memory cards, thereby increasing the memory of the Altair 680b to 49K.

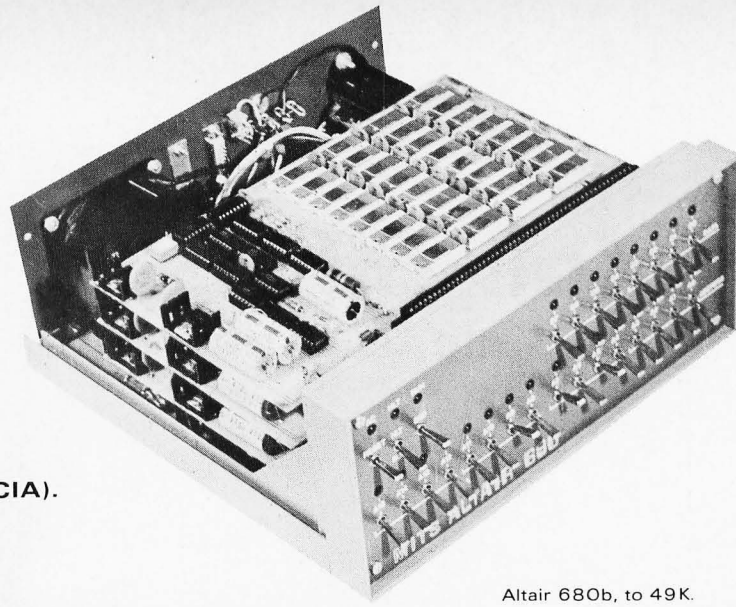

Altair 680b, to 49K.

SPECIAL FEATURES

PROM monitor.

1702A PROM monitor chip programmed so that you can immediately load and run paper tape object programs such as the text editor and assembler (see below).

Asynchronous Communication Interface Adapter (ACIA).

Allows the machine to transmit and receive a character at a time rather than one bit. Minimizes software needed for I/O routines. Contains crystal clock for baud rate synchronization. User-selectable for RS232, Baudot, TTY, 20ma current loop. Baud rates of 50, 75, 110, 134.5, 150, 200, 300, 600, 1200, 1800, 2400, 4800, and 9600.

Two Pass Resident Assembler and Text Editor

A two pass resident assembler and text editor will be available for assembly language programming. This software is compatible with Motorola's format for assembly language programs, text and object files. 8K bytes of memory are required to run this package. The assembler produces a full assembly listing on the second pass, including the hex codes for the location counter and the instruction mnemonics. A symbol table listing is also produced. The text editor has full capabilities for text editing, including line insertion, printing, deletion and modification; as well as commands for changing one string of characters to another and for searching the text buffers for a particular character string.

Basic Interpreter

A BASIC interpreter has been developed which will be comparable to the 8800 8K BASIC interpreter.

Buffered Data Lines

All data lines are buffered to provide fanout capability of over 20 standard TTL loads.

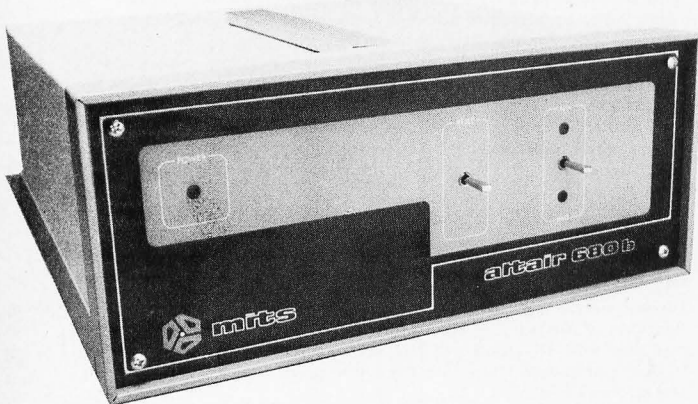

The Altair 680b is also available in this Turnkey Model which has a power indicator light and controls for RESET and RUN/HALT on the front panel. The system PROM monitor, when used in conjunction with a terminal, eliminates the necessity for toggling front panel switches to load bootstraps or to examine and change memory contents.

| Altair 680b Specifications | |
|---------------------------------|---|
| No. of Boards | Up to 3 additional |
| Microprocessor | |
| Model | 6800 |
| Technology | NMOS |
| Data Word Size, Bits | 8 |
| Instruction Word Size, Bits | 8 |
| Clock Frequency, | 500K Hz |
| Add Time, Register to Register, | |
| Microsec. Per Data Word | 2 |
| Number of Instructions | 72 |
| Input/Output Control | |
| I/O Word Size, Bits | 8 |
| Number of I/O channels | 256 Memory Address Locations Designated |
| Interrupt Capability | Std. |
| Type of Interrupt System | Maskable (Interrupt Request) and Non-maskable Interrupt |
| Software | |
| Resident Assembler and Editor | Yes |
| Higher-level language | BASIC |
| Monitor | Resident System Monitor on PROM |
| Complete Software Library | |
| Separately Priced | Yes |



2450 Alamo S.E. / Albuquerque, New Mexico 87106

Programming Quickies:

The Thompson Lister

Noel J Thompson, of the Hawaii Institute of Geophysics, 2525 Correa Rd, Honolulu HW 96822, submits the "Thompson Lister" program for the 6800 using Motorola's MIKBUG program. This program, shown listed at location 0000 in a symbolic assembly language format, is designed to list 6800 programs as an address, an operation code and an optional one or two byte field depending upon the length of the instruction. The sample Teletype output shown at the bottom of the listing was supplied by Noel as part of his listing of the entire program. The program figures out completely whether the first byte of an instruction calls for one, two or three bytes. Quoting from Noel's letter accompanying the program,

"Such a program has two important benefits. First, it provides an adequate

listing for your documentation of programs you are working on. You can use it over and over while you are developing a routine,

Second it detects the most common mistake that I find myself making in multi-length-instruction machines — the mistake of forgetting to put in the right number of bytes. If this lister comes up with funny things, probably you left out a byte."

The program is easily relocated by changing constants in the instructions at locations 0000, 0009 and 005D. The data memory used by THMPLSTR is located in the MIKBUG programmable memory region between locations A000 and A07F. Also, the program takes advantage of subroutines PDATA1, BADDR, OUT4HS, OUT2HS and OUTS which are found in Motorola's MIKBUG program.

| Addr | Hex Code | Label | Op | Operand | Commentary |
|------|----------|----------|------|----------|--|
| 0000 | CE 00 67 | THMPLSTR | LDX | #ANATSGN | Print an '@' sign using |
| 0003 | BD E0 7E | | JSR | PDATA1 | MIKBUG subroutine PDATA1; |
| 0006 | BD E0 47 | | JSR | BADDR | XHI := (address input) [using MIKBUG]; |
| 0009 | CE 00 64 | NEXTBYTE | LDX | #CRLF | Print carriage return and line feed |
| 000C | BD E0 7E | | JSR | PDATA1 | MIKBUG subroutine PDATA1; |
| 000F | CE A0 0C | | LDX | #XHI | X := XHI [XHI as defined by MIKBUG]; |
| 0012 | BD E0 C8 | | JSR | OUT4HS | Print current address as 4 hex characters; |
| 0015 | FE A0 0C | | LDX | XHI | X := XHI [fetch current address pointer]; |
| 0018 | A6 00 | | LDAA | 0,X | A := @X [fetch current data at X]; |
| 001A | B7 A0 0B | | STAA | TEMP | TEMP := A; |
| 001D | BD E0 CA | | JSR | OUT2HS | Print current data then space; |
| 0020 | FF A0 0C | | STX | XHI | XHI := X [after OUT2HS has incremented]; |
| 0023 | BD E0 CC | | JSR | OUTS | Print an extra space; |
| 0026 | 5F | | CLRB | | B := 0; |
| 0027 | B6 A0 0B | | LDAA | TEMP | A := TEMP; |
| 002A | 81 8C | | CMPA | #8C | is op code CPX ? |
| 002C | 27 18 | | BEQ | THREE | if so then go to 3 byte length case; |
| 002E | 81 8E | | CMPA | #8E | is op code LDS? |
| 0030 | 27 14 | | BEQ | THREE | if so then go to 3 byte length case; |
| 0032 | 81 CE | | CMPA | #CE | is op code LDX? |
| 0034 | 27 10 | | BEQ | THREE | if so then go to 3 byte length case; |
| 0036 | 84 F0 | | ANDA | #F0 | A := A & #F0 [mask off low order nybble]; |
| 0038 | 81 20 | | CMPA | #20 | is op code a branch? |
| 003A | 27 0B | | BEQ | TWO | if so then go to 2 byte length case; |
| 003C | 81 60 | | CMPA | #60 | is op code less than #60? |
| 003E | 25 08 | | BCS | | if so then go to 1 byte length case; |
| 0040 | 84 30 | | ANDA | #30 | A := A & #30 [mask to bits 5 and 4 left]; |
| 0042 | 81 30 | | CMPA | #30 | are bits 5 and 4 equal to '1'? |
| 0044 | 26 01 | | BNE | TWO | if not then length TWO is indicated; |
| 0046 | 5C | THREE | INCB | | B := B + 1 [here for two increments]; |
| 0047 | 5C | TWO | INCB | | B := B + 1 [here for one increment]; |
| 0048 | F7 A0 0A | ONE | STAB | BOX | BOX := B; |
| 004B | 27 10 | | BEQ | NEXTINST | if zero in BOX then reiterate; |
| 004D | 7A A0 0A | | DEC | BOX | BOX := BOX - 1; |
| 0050 | 27 05 | | BEQ | ONLYONE | if one in BOX then print only one byte; |
| 0052 | BD E0 C8 | | JSR | OUT4HS | print two bytes of 3 byte instruction; |
| 0055 | 20 03 | | BRA | SAVEADDR | go save address for next round; |
| 0057 | BD E0 CA | ONLYONE | JSR | OUT2HS | print one byte left in 2 byte instruction; |
| 005A | FF A0 0C | SAVEADDR | STX | XHI | XHI := X [save pointer to next address]; |
| 005D | 7E 00 09 | | JMP | NEXTBYTE | reiterate program forever till interrupt; |

Constants required:

| Addr | Hex Code | Label | Description |
|------|----------|---------|---|
| 0064 | 0D 0A 04 | CRLF | Carriage return, line feed, stop code in PDATA1 format; |
| 0067 | 40 04 | ANATSGN | Initialization prompting message in PDATA1 format; |

Sample listing on Teletype:

```
0018 A6 00
001A B7 A00B
001D BD E0CA
0020 FF A00C
0023 BD E0CC
0026 5F
0027 B6 A00B
002A 81 8C
```



BOOK REVIEWS

Computer Resource Book — Algebra by Thomas A Dwyer and Margot Critchfield, Houghton Mifflin, Boston, 1975; 8-1/4 x 11, 178 pages. Paperback \$4.20.

This book contains a collection of computer explorations of algebra that were designed to be carried out in any algebra course where a computer is available. Since the computer programs are written in BASIC, the book begins with a 25 page "whirlwind tour" of computer programming in BASIC. Following this introduction to BASIC are 10 sections on things to do with a computer while learning algebra. In evaluating this excellent resource book, one can conclude that the authors have taught computer programming and high school algebra, and have taught both subjects well. Dwyer and Critchfield have written a book which draws the reader into becoming an interested and active participant in learning algebra. They were able to put themselves in the reader's place by asking (and answering) some of the questions about algebra and computer programming which puzzle students. The book was designed to be read by high school students as well as teachers, and I suspect that many students will want to take it home with them after school.

As the authors point out in the introduction, this resource book is meant to be used in an algebra course as a supplement to a regular algebra textbook. Access to a time sharing system or an on site small computer is necessary when using the book. Teachers and students may want to integrate these computer-related algebra topics in their regular algebra courses or select programs from the book to use as course projects. Many of

the BASIC programming skills needed in using the book are presented in the prologue and the remainder are interspersed throughout the algebra topics.

The "Introduction to BASIC" section begins by illustrating the differences among system commands, BASIC statements, computer programs, user input, and computer output. The authors put the computer-programming novice at ease by taking a realistic, relaxed (and at times humorous) approach to using computers. For example, the reader is given numerous reminders at the beginning of the book to press the carriage return key after typing a line and is told "don't be afraid to make mistakes — you won't hurt anything." To avoid misleading the beginner, each BASIC statement is introduced and explained in the context of a complete, executable program rather than as a non-executable program segment. Sufficient margin notes are used to clarify lines and sections of program listings and sample executions are included with most of the program listings.

The 10 algebra topics included in this book are the language of algebra, operations with real numbers, linear equations in one variable, inequalities, open sentences in two variables, systems of linear equations, quadratic equations and functions, rational expressions and polynomial equations, polynomial functions and complex numbers, and computer-generated animation. Each algebra topic begins with a checklist of necessary computer programming skills and a short quiz on prerequisite knowledge of algebra. Next, several coaching and practice computer programs are listed and explained, followed by a number of application pro-



Now, you can buy an Altair 8800 or Altair 680 computer kit right off the shelf. Most all Altair options, software and manuals are also available. The MITS Dealer List below is just the beginning:

off the shelf

RETAIL COMPUTER STORE, INC.
410 N.E. 72nd
Seattle, WA 98115
(206) 524-4101

COMPUTER KITS
1044 University Ave.
Berkeley, CA 94710
(415) 845-5300

THE COMPUTER STORE
(Arrowhead Computer Co.)
820 Broadway
Santa Monica, CA 90401
(213) 451-0713

THE COMPUTER SHACK
3120 San Mateo NE
Albuquerque, NM 87110
(505) 883-8282

GATEWAY ELECTRONICS
2839 W. 44th Ave.
Denver, CO 80211
(303) 458-5444

GATEWAY ELECTRONICS
8123-25 Page Blvd.
St. Louis, MO 63130
(314) 427-6116

BYTE'TRONICS
Suite 103 - 1600 Hayes St.
Nashville, TN 37203
(615) 329-1979

CHICAGO COMPUTER STORE
517 Talcott Rd.
Park Ridge, IL 60068
(312) 823-2388

MARSH DATA SYSTEMS
5405-B Southern Comfort Blvd.
Tampa, FL 33614
(813) 886-9890

MICROSYSTEMS
6605A Backlick Rd.
Springfield, VA 22150
(Washington DC area)
(703) 569-1110

THE COMPUTER SYSTEMCENTER
3330 Piedmont Road
Atlanta, GA 30305
(404) 231-1691

THE COMPUTER STORE, INC.
120 Cambridge St.
Burlington, MA 01803
(617) 272-8700

THE COMPUTER STORE OF ANN ARBOR
310 East Washington St.
Ann Arbor, MI 48104
(313) 995-7616

COMPUTER PRODUCTS UNLIMITED
4216 West 12th St.
Little Rock, AR 72204
(501) 666-2839

the COMPUTER STORE, INC.
63 South Main St.
Windsor Locks, CT 06096
(203) 871-1783

the COMPUTER STORE of NEW YORK
55 West 39th St.
New York, NY 10018

THE COMPUTER ROOM
3938 Beau D'Rue Drive
Eagan, MN 55122
(612) 452-2567

NOTE: Altair is a trademark of MITS, Inc.

MITS, Inc. 2450 Alamo S.E. Albuquerque, N.M. 87106

grams and simulations. Most of the 125 programs which are listed are interesting enough to elicit an "I want to try it out" response on the part of students, and many of the programs are unavailable in other computer supplemented sources. Activities such as modifying the given programs to make them more efficient, revising programs to make them do different things, and creating new programs are suggested at the end of each algebra topic.

If you want to liven up your algebra classes with computer activities such as building an ultramatic root finder, making and breaking secret codes, writing robot coaching programs, programming Honest Hal the simulated used-car salesman, and many others, this fascinating book is for you and your students. Even if you only want to see how computers can be used to enhance learning mathematics or find some new ideas for mathematical applications of computers, the *Computer Resource Book — Algebra* is still appropriate.

My only complaint about this book is that it ends too soon; and where are the computer resource books for geometry, trigonometry, probability, and statistics?

Frederick H Bell
Associate Professor
School of Education
University of Pittsburgh
Pittsburgh PA 15260 ■

The Art of Computer Programming by Donald E Knuth. Volume I: Fundamental Algorithms. Addison-Wesley, Reading MA, 1975, \$20.95.

There is some doubt in my mind as to how to classify this series. It is undeniable that we have here a standard, perhaps even classic, reference work, which sits handy on many a programmer's desk. But it clearly is also a text, useful for self instruction and used in several university programming courses. The exercises, while very instructive, could also fall in the realm of recreational mathematics (another field the author has contributed to). It even makes entertaining reading at times (no mean feat for a text and reference work). I suppose the best description, however, would be that this is a cookbook of computer algorithms.

More specifically, it deals with "non-numerical analysis." Numbers occur only "coincidentally," with more stress given to the decision making capabilities of the computer. The numeric computing which is involved consists mainly of addition and subtraction (these qualities are among the stronger points of inexpensive computers,

bless 'em). Of course, the techniques presented are also of considerable use in numerical computing, as there is always a non-numerical background in programming.

By numerical computing, I refer to the solving of equations, finding of roots, and other number oriented calculations (the "traditional stuff"). While that aspect of the field is little covered by this series, that doesn't mean there is no mathematics involved. Indeed, Mr Knuth is himself a professional mathematician. This need not scare away those who are not, however, as the author kindly presents theory and algorithm with the minimum math needed to understand and use them, keeping more difficult analysis towards the end of each section, where only those with more interest need tread. (Some knowledge of basic math notation would be helpful, though.) Also optional are the exercises which conclude each section (the answers *are* included, by the way).

If this series is not just for the mathematician, who then? Everyone? Not quite. It is aimed at the person with more than a casual interest in computers, the programmer concerned not only with how to use some one else's subroutines, but with how to use the algorithms behind the subroutines to improve his own creations. The reader's relationship with the computer should be beyond the stage of introductions. For example, Knuth suggests that the reader should have written and debugged at least four programs on at least one machine. (The programmer who has written scores of programs for several machines may get at least as much value from the series. As I say, it is a reference, too.) It's for you if you're getting the hang of your programming units (be they hex machine codes or FORTRAN statements), and you want to start putting them together to *do* something.

To connect the units with the application in mind, you need algorithms. (Roughly, an algorithm is a step by step procedure for doing something.) That's what *The Art of Computer Programming* is all about. The algorithms are chiefly presented in two forms: in a general English-language outline form and, when appropriate, in the assembly language for a hypothetical computer of the author's own concoction, MIX (the "world's first polyunsaturated computer"). Knuth has several good reasons for getting us involved with this mongrel machine (read the book), but for our purposes there is the additional advantage of easier translation of algorithms, ie: from his assembly language to our assembly language. While many algorithms translate well to higher level languages like

BASIC, some things can be better done closer to the assembly language level, eg: systems programs.

While it's not necessary to the use of the series, I plan to have a MIX simulator running on the MOS Technology 6502, and I expect there will be simulators for other micros as well. This will allow very quick checkout and modification of the MIX algorithms given in *The Art of Computer Programming* before further translation, and make possible the exchange of programs with other hobbyists.

In particular, let's consider *Fundamental Algorithms*, which is the first volume of seven in *The Art of Computer Programming* (of which three have been published so far). Chapters 1 and 2 are contained therein. Chapter 1 features a concise tutorial of much of the math that is particularly useful to programming. You may skim this section, but don't be surprised if over the years you keep referring back to it. Then follows a complete presentation of MIX and the MIX language, including the description of a MIX simulator. In fact a well commented listing of the MIX simulator is given and explained (written in MIX, of course). This presentation will greatly help anyone interested in writing their own simulator (which is a very useful exercise).

Chapter 2 is titled "Information Structures," and begins the meat of the series. Major topics covered include stacks, arrays, linked lists, dynamic storage allocation, and trees. (These trees have roots and leaves, but [generally] aren't green and usually grow upside down.) Whether you know all or none of the above terms, this chapter should leave you with a good understanding of what they are and how to use them. No "TKIS" [page 42, January BYTE] is complete without some of these structures. Nor is any programmer.

Zhahai Stewart
PO Box 1637
Boulder CO 80302 ■

Humanizing Computer Systems by Keith R London, McGraw Hill, New York, \$15.

What is the people impact when computers are placed in a working environment? What are associated problems of developing and implementing systems to meet the requirements of an organization and yet satisfy the people — the employees?

This new book, "The people side of systems," is a valuable work which puts aside the technical aspects of computing and looks at the implications for people when a

computer comes into their every working day association.

The author is Keith R London who has produced considerable output related to management of computer systems. In this new book, he directs attention to how computers can cause disruptions in employee relationships.

Keith acknowledges the need and use of computers, but he also sees a need to reorient project leaders and systems analysts away from a pure hardware/software aspect to giving some attention to the impact the system has on those it comes into contact with: workers in a company or group. The thrust is to show how to integrate a computer with people.

This book is not directly of import to the average Byter other than giving some insight to better relationship with the rest of the family who may think, with some degree of justification, that the excessive interest hobbyists show towards do it yourself computers has placed them just this side of the funny farm. The book is a must for those who have to make computers work in a large "people" group.

Art Brothers
555 Avenue G
Boulder City NV 89005 ■

ACT-I

MICRO-TERM INC.



\$525 complete with high resolution 9" monitor • \$400 without monitor INCLUDED FEATURES:

- Underline Cursor
- RS232C or Current Loop
- All oscillators (horiz., vert., baud rate, and dot size) are crystal controlled
- 64 characters by 16 lines
- Auto Scrolling
- Data Rates of 110, 300, 600, 1200, 2400, 4800, and 9600 baud are jumper selectable

The ACT-I is a complete teletype replacement compatible with any processor which supports a serial I/O port. Completely assembled and dynamically tested.

Prices FOB St. Louis Mastercharge and BankAmericard

THE AFFORDABLE CRT TERMINAL

**MICRO-TERM INC. P.O. BOX 9387 ST. LOUIS, MO. 63117
(314) 645-3656**

Interested in Notes about Electronic Music?

Electronotes is the name of an excellent newsletter which will be of interest to anyone who is into electronic music experimentation. Published by Bernie A Hutchins, it is subtitled "Newsletter of the Musical Engineering Group." The address is 203 Snyder Hill Rd, Ithaca NY 14850... write for information on signing up for a subscription. The price of a typical subscription is \$16 for one year.

Bernie sent BYTE several copies of the newsletter, and a reprint book entitled *Musical Engineer's Handbook*. The newsletter has been published by him and his associates for several years, and is circulated to a select group of electronic music people. The beginnings of microprocessor automation in traditional electronic music are found in the pages of *Electronotes* where the November 1975 issue, EN#59, starts a series of tutorials on what a microprocessor can do for the electronic musician, written in terms familiar to the music person. The author of the series, which extends through four issues of *Electronotes*, is Bill Hemsath. The theme is continued in the March 1976 issue where Douglas Kraul discusses some elementary

points about "Analog Interfaces for Microprocessor Systems." *Electronotes* is jammed full of information on circuitry and equipment needed to produce electronic music sounds, and will provide an excellent and specialized forum for those who want to find out about progress in this field.

The *Musical Engineer's Handbook* is a publication in the same vein, as one might expect since it is made up of materials based upon past issues of *Electronotes*. Its dedication reads: "This book is dedicated to musicians everywhere and of all times, without whom many of us would have only electronics to do." It is a very thick photo offset publication (354 pages) in a GBC binding, containing fundamental information on the technology of electronics in music applications. The book has a combination of background theory with numerous practical applications circuits. It is an essential sourcebook for anyone seriously interested in the art and practices of electronic music. The book is available from *Electronotes* for \$18, in return for which you'll get thousands of dollars worth of ideas. ■

P.C. cards made simple — with COPYDAT!

1. Prepare the 1X artwork, using an opaque layout aid such as Chartpak, Bishop Graphics, or other similar product.
2. Make a negative: Place the artwork face down, cover with the negative material colored film side up (we recommend Scotchcal products), and expose with the Copydat. Typical exposure time is 1.5 minutes.
3. Develop the negative in developer provided with negative material.
4. Attach negative to pre-sensitized face of copper board. Place board and negative face down on Copydat. Expose. Typical exposure time: 30 seconds.
5. Save the negative for reuse, and develop the board in the developer provided.
6. Etch the board.
7. As a finishing touch, tin the board to avoid oxidation of the copper and to improve solderability.

Result: a custom, high quality, single-sided P.C. board.

With careful alignment, you can make doublesided boards too!

Alternatively, buy high-quality hardware assemblers from us — and these are predrilled as well (and feature plated-through holes):

P.S. The Copydat does a lot more than make high-quality P.C. boards. It makes superior blueline, blackline, sepia, and other diazo process copies, and you can make pressure-sensitive labels with it and even instrument front panels from pre-sensitized metal plates !!

from \$149.95 (B size prints)

**CELDAT Design Assoc.
P.O. Box 752
Amherst, N.H. 03031**

Still More BYTE's Books

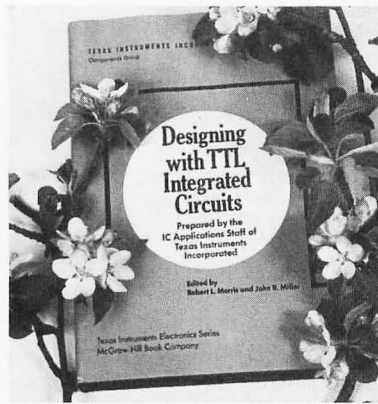

•**DESIGNING WITH TTL INTEGRATED CIRCUITS** by the Components Group, Texas Instruments Inc. Edited by Robert L. Morris and John R. Miller.

People often ask questions like "Where do I get basic information on hardware design?" One answer is in "Designing With TTL Integrated Circuits."

This book, published by McGraw Hill in 1971, is a fundamental starting point for any person designing peripherals and custom logic employing TTL integrated circuits. While its publication date precludes any reference to the later additions to the TTL 7400 series of components found in the **Data Books**, it is nevertheless the source of a wealth of ideas on TTL integrated circuits and design of logic with this family of circuits.

What is fanout? You may have heard this term mentioned at computer club meetings or in advertisements for circuitry, or in articles in **BYTE**. You can find out background information on the calculation of fanouts by reading the chapter on **Circuit Analysis and Characteristics of Series 54/74**.

Worried about noise, shielding, grounding, decoupling, cross talk and transmission line effect? (Or, more properly, did you know you should worry about these effects in certain circumstances?) Find out about general precautions and background information by reading the chapter on **Noise Considerations**.

The chapter on **Combinatorial Logic**

Design gives 53 pages of background information on Boolean algebra and practical representations of logic in the form of SSI gates. The chapter includes a description of Karnaugh mapping techniques and the minimization of logic. From combinatorial design, the book progresses into **Flip Flops**, including background information on the workings of these devices, and fairly detailed descriptions of the uses and applications of these devices including synchronization of asynchronous signals, shift registers, flip flop one shots, etc. Then the book returns to static combinatorial logic with its description of the **Decoders** available in the 7400 line as it stood in 1970-1971.

A chapter on **Arithmetic Elements** gives fundamental descriptions of binary arithmetic, diagrams of the basic gate configurations for combinatorial logic adders, and a section on number representations for use in computers. Much of the material in this section is dated, due to the fact that the later 74181 series of multiple function arithmetic units had not yet appeared when the book was written. But for a background on arithmetic operations implemented with the simpler 7483 circuits, this chapter is ideal. A chapter on **Counters** and a chapter on **Shift Registers** complete the detail logic sections. The book is closed out by a chapter on miscellaneous **Other Applications** including a simple binary multiplier, a 12 hour digital clock and a modulo-360 adder.



The most important use of this book is its value as an introduction to TTL logic. By reading and studying it, you will begin to understand the ways in which SSI and MSI TTL gates can be utilized in your own experimental logic designs. After studying this text, you should be able to make much more sense out of the technical information summaries typically published as specifications sheets and data catalogs.

Order your copy today from **BYTE's Books**, \$24 postpaid.

•**MICROCOMPUTER DESIGN** by Donald P. Martin, Martin Research. Edited and Published by Kerry S. Berland, Martin Research.

Purchase your copy of the definitive source for circuitry and hardware design information on the 8008 and 8080 computers today.

Even Intel, the originator of the microprocessor revolution, is hard put to compete with the wealth of information found in Martin Research's new second edition of **Microcomputer Design**. This is the book which was originally published as an expensive (but quite practical) engineering report in loose leaf form, at about the time the microprocessor technology was first catching on in the form of the 8008. This 388 page second edition of the manual is loaded with detailed information on how to build and use computers based on the 8008 and 8080.

But even if you do not intend to use the 8008 or 8080, the practical pointers on digital logic design, peripherals and applications of hardware techniques will more than justify the new low price of \$25 for this handbook. **Microcomputer Design** is a must for 8008 owners and 8080 owners who want to truly understand how their processors process.

Microcomputer Design is complete with numerous illustrations, tables and diagrams, plus reprints of the specifications sheets for the Intel processors. There are numerous practical examples of circuitry and many complete computer designs ranging from "minimal microcomputers" to a full blown 8080 processor.

Order your copy today, \$25 postpaid from **BYTE's Books**.

BYTE

PETERBOROUGH, NH 03458

___ Designing With TTL Integrated Circuits \$24

___ Microcomputer Design \$25

Send to: Name _____

Address _____

City _____ State _____ Zip _____

Check enclosed

Bill MC No. _____ Exp. Date _____

Bill BA No. _____ Exp. Date _____

Signature _____

Please allow six weeks for delivery.

decision boundary. There are innumerable ways to vary this technique.

For those who would like to try their luck at hand sent Morse decoding, I have included a brief flow chart outlining a typical process from approach (3). Successful models have been constructed by Pickering Radio Co (to name but one company... look at *Ham Radio*, *QST*, or other amateur radio magazines) and a computer model has been designed using about 4 K of memory on a PDP-12 as described in a master's thesis by J A Guenther. For those interested in the exact PDP-12 algorithm, Guenther's thesis is available for a nominal charge from the National Technical Information Service of the US Department of Commerce [See bibliography].

As you can see, the problem of translating hand sent Morse code is not easily solved. To further complicate matters, most of the really good information is classified, or even worse, proprietary to a particular company. So, I wish you all the best of luck, you'll probably need it. As a final note, just remember: When you think you've got the problem licked, Chisholm's Law of Human Interaction will apply (eg: Some joker — radio amateurs call them "lids" — will come along with a "fist" that will tear your algorithm apart).■

BIBLIOGRAPHY

1. Blair, C R, "On Computer Transcription of Manual Morse," *Journal of the Association for Computing Machinery*, pages 429-442, vol 6, no 3, July 1959.
2. Duda, J S, "Noise Reduction for CW Reception," *Ham Radio*, pages 52-55, September 1973.
3. Gold, B, "Machine Recognition of Hand-Sent Morse Code," *Institute of Radio Engineers Transactions on Information Theory*, pages 17-24, March 1959.
4. Gonzales, C and Vogler, R, "Automatic Radio-telegraph Translator and Transcriber," *Ham Radio*, pages 8-23, November 1971.
5. Guenther, J A, *Machine Recognition of Hand Sent Morse Code Using the PDP-12 Computer*, master's thesis, Air Force Institute of Technology, Wright-Patterson Air Force Base, Ohio, December 1973. Available as document number AD-786-492 for a nominal cost from the National Technical Information Service, US Department of Commerce, 5285 Port Royal Rd, Springfield VA 22151.
6. McElwain, C K and Evans, M B, "The Degarbler — A Program for Correcting Machine Read Morse Code," *Information and Control*, vol 5, pages 368-384, May 1962.
7. Petit, R C, "Morse-a-Verter," *QST*, pages 30-35, January 1971.

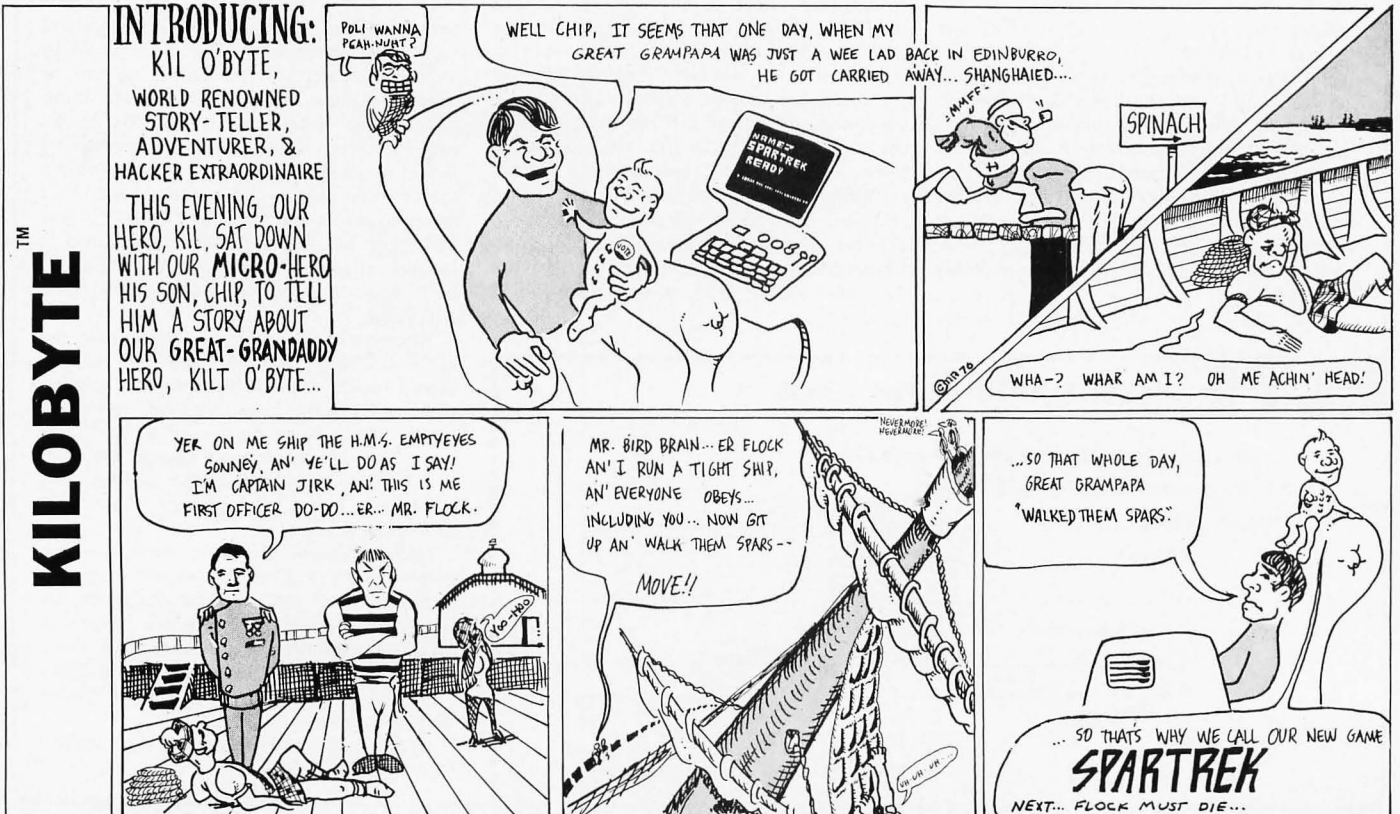

Waiting to leave at Logan Airport in Boston, Ed Zealy captured this interesting juxtaposition of transportation technologies. The tail of a 707 frames the distant image of a 727 masked against a sailing vessel leaving Boston as a part of "Operation Sail."

Travelogue

... Notes by Carl Helmers, Editor

On July 16, 17 and 18, the American Radio Relay League's 1976 National Convention was held in Denver CO at the Denver Hilton hotel. The ARRL is the amateur radio operator's main organization and representative in matters concerning the legal availability of amateur bands in the radio spectrum. Without the ARRL, amateur radio as it is today and has been practiced since early in this century would not exist. (For information on amateur radio, contact the ARRL at 225 Main St, Newington CT 06111.)

As part of the affair, reflecting the interest of many radio amateurs in computing applications to their field, the Denver Amateur Computer Society was asked to coordinate a series of microprocessor sessions at the convention, and this in turn helped attract a number of personal computing vendors and spectators to the exhibition area. BYTE was present at the con-

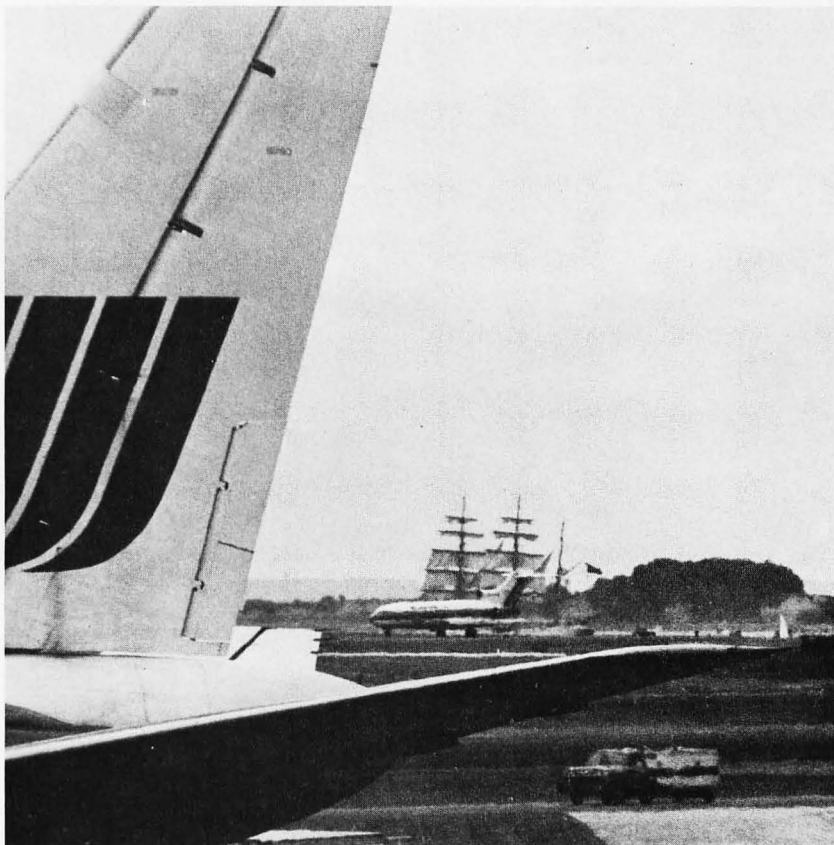

A sign in the lobby of the Denver Hilton greets the several thousand visitors to the ARRL convention.

CAPTAIN VIDEO

★
Ideal for communicating with your microprocessor!

- RS-232 interface x 32 characters \$400
- TV/TTY kbd./display (16 lines x 64 characters) \$500
- Keyboard/CRT Monitor (24 lines x 80 characters) \$700

ORDER FORM

Ship To _____

Subtotal \$ _____

Calif. residents add sales tax _____

Please find a check enclosed in the amount of total order: \$ _____

Bill my BankAmericard _____ exp _____

Mastercharge _____ exp _____

My signature as purchaser _____ date _____



Micon Industries
252 Oak Street
Oakland, CA 94607
(415) 763-6033

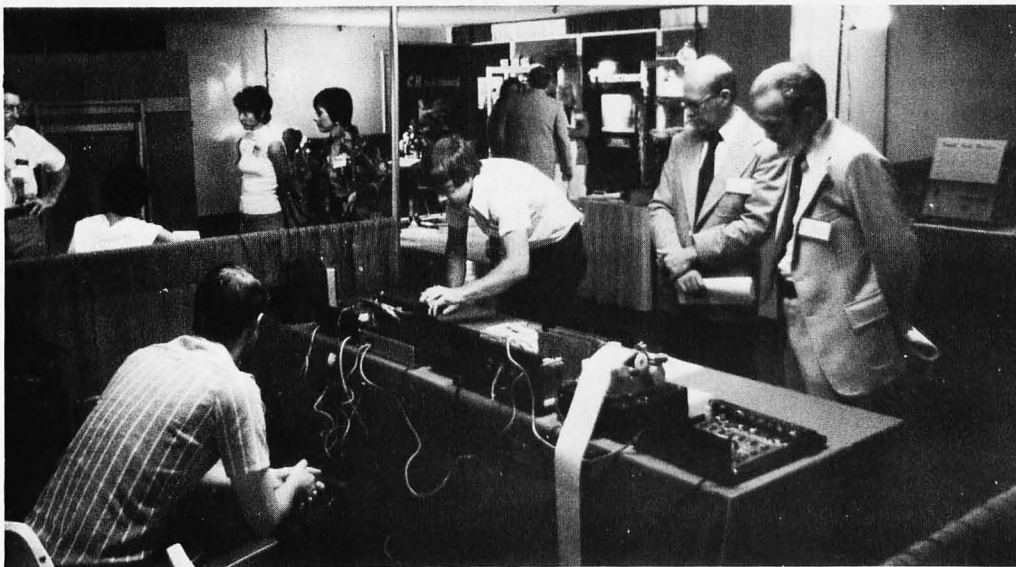

Gary Kay (leaning over table) and Joe Deres (seated) of Southwest Technical Products demonstrate their wares at the ARRL convention. The table contains an SWTPC 6800 system, CT-1024 terminal, GT-6144 graphics display unit, and printer.



Every manufacturer shows off the product in the factory. At MITS, the new Altair 880B machine is quite effectively integrated with three floppy disks, a Lear-Siegler ADM-3 terminal, and a disk operating system in the display room. Here Dave Bunnell and Carl Helmers are engaged in a conversation with the demonstration system in the background.

The interior of the main assembly area at MITS is illustrated in this shot taken during the tour of the facility.



vention with a booth in the exhibit area staffed by Deena and Ed Zealy, Beth Alpaugh and me. I also participated in one of the microprocessor oriented technical sessions by giving an informal talk at which I shared the forum with Jack Cox WOKMV.

After the convention, we all flew to Albuquerque where we spent some time talking with Ed Roberts and Dave Bunnell of MITS, then Beth and I flew to San Antonio to pay a visit to Dan Meyer, Gary Kay and Joe Deres at Southwest Technical Products. Perhaps the highlight of the whole trip (at least in my mind) was entirely unplanned. While at Southwest, Ron Komatz, the local representative for Motorola Semiconductor Products in Austin TX, walked in. In passing, he suggested something like "How would you like to come back with me to Austin this afternoon and take a quick tour through the Motorola Semiconductor wafer fabrication facility?" With an offer like that, we could hardly refuse . . .

So, after some hurried reservations changes and Ron's call ahead to the people



A candid shot of Ed Roberts, president of MITS, during an informal discussion in his office in Albuquerque.

at the Motorola plant, we drove up to Austin in Ron's car for a quick tour (total time, less than an hour and a half including 45 minutes of some informal discussion with several of the engineers and software people at Motorola).

It is in places such as the Motorola plant in Austin where the space age technology of integrated circuits and the technological leads of the American semiconductor manufacturers are so much in evidence. The silicon wafer fabrication plant is like a science fiction image: clean rooms with highly filtered air, workers dressed in lint- and dust-free smocks undergoing cleaning procedures prior to entering the fabrication area, exotic gases and electricity piped into the work areas, intricate optical instruments for the microscopic photo reproduction of IC mask patterns, air bearing transport slides for the disks of silicon being handled by the facility, red glowing diffusion ovens maintained at carefully controlled temperatures needed to dope the silicon chips with precise amounts of impurities at each stage of production.

The result at the end of multiple stages of the fabrication process, which we viewed through glass partitions, is a three inch wafer of silicon with hundreds to thousands (depending on the particular IC) of tiny circuit patterns, waiting to be ground down to less than 10 mils thick, scribed and separated into individual pieces which can be tested in automatic equipment then shipped overseas for assembly. It is the high technology of such semiconductor facilities which makes possible the personal computer as we know it today, and as it will improve and evolve in the future. ■

ALTAIR 8800 OWNERS

We recently received the following letter:

RUN

APRIL 26, 1976

GENTLEMEN:

I JUST WANTED TO TELL YOU THAT I THINK YOUR CLOCK FIX-IT KIT IS REALLY GREAT! I WAS HAVING TROUBLE RUNNING BASIC AND AFTER INSTALLING YOUR KIT FOUR OF MY MITS BOARDS THAT WEREN'T RUNNING CAME BACK TO LIFE AND NOW ARE HELPING ME TO WRITE THIS LETTER ON THE COMPUTER. ENCLOSED IS ANOTHER ORDER FOR A CLOCK KIT. THIS IS FOR THE SECOND ALTAIR THAT I'AM NOW IN THE PROCESS OF BUILDING. AGAIN MANY THANKS FOR SUCH A FINE PRODUCT.

SINCERELY
LUCY L. SMITH

OK:

How well does your Altair run?
A Clock Fix Kit is only \$15 postpaid.

PARASITIC ENGINEERING

PO BOX 6314

ALBANY CA 94706

NOT A KIT!
BURNED IN

BABY!

FULLY TESTED



Complete System in a case!

KEYBOARD: 62 key upper & lower case + Greek;

TAPE INTERFACE: High speed, 1200 Baud! Cassette, programs included;

VIDEO INTERFACE: E.I.A. Compatible;

MICROPROCESSOR: 6502 based system!

MEMORY: 2K or 4K byte RAM minimum system monitor + 3K ROM sockets;

2K
\$850.00

S.T.M. SYSTEMS INC.
P.O. Box 248
Mont Vernon, N.H. 03057

4K
\$1000.00

What's New?

Mating Game

What do you use for a plug which will mate your computer with the real world across a cable? For parallel interconnection, one option is this Hirose 20 pin connector which according to its distributor has been widely used in the video field wherever multiple wires must be used with quick connect and disconnect.

These connectors are heavy duty, and will handle audio, video and machine control

signals. They were designed for quick disconnect when the light colored button (see photo) is pressed. The contacts are high quality brass with silver plating and the cable assembly features a heavy duty wire lock.

Physical ratings are 350 VAC at sea level, 3 amperes per contact, insulation resistance 1000 megohm at 500 VDC, contact resistance 7 milliohms maximum. This press release information was provided by the Hirose distributor, John Anthony Television, Childs Park Rd, Dingmans Ferry PA 18238. As a special introductory offer to BYTE readers, the price of a combination male cable connector and female chassis connector is \$14.95. The same price applies to the alternate combination of female cable connector and male chassis connector. Normal prices are \$12.25 for male cable, \$12.50 for female cable, \$3.90 for female chassis, \$4.50 for male chassis. OEM and quantity discounts are available as well. ■

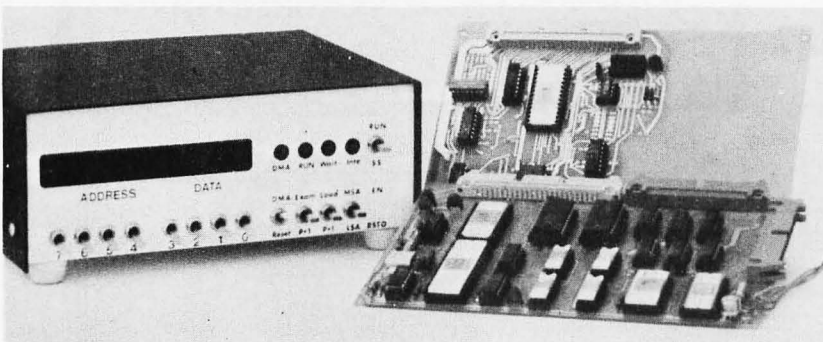
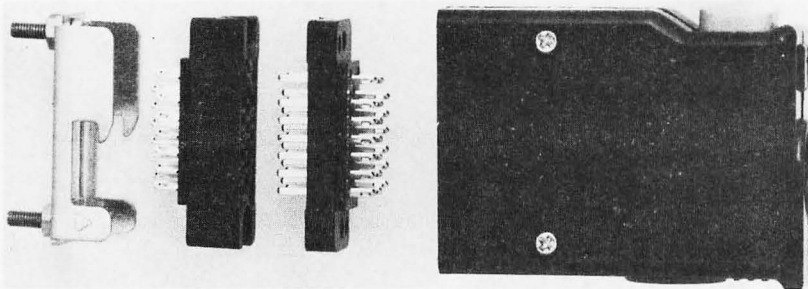

And Yet Another Dedicated Industrial Micro

Here is an 8080 processor board intended by its manufacturer, GNAT Computers, as a dedicated computer for industrial applications. The MC80 starts at \$189 and should find its way into communications systems, programmable logic for instrumentation and machine tools, and other processes where dedicated intelligence is required. In the experimenter's context, it would make a useful foundation for dedicated applications such as peripheral controllers, mobile computers for land, sea and air navigation, smart terminals, etc. The basic board has 256 bytes of programmable memory, expandable to 512, and space for up to 2 K bytes of custom applications programming in programmable ROMs. Optionally there is a front panel for development and maintenance checkout. Delivery is quoted as 30 days after receipt of order, from GNAT Computers, 8869-C Balboa Av, San Diego CA 92123. ■

Building a Homebrew CRT? Using a Commercial Digital Display Chassis?

If your answer is yes, then you'll probably want to think about the problem of creating an enclosure for your design. This new product, the VTE-101 CRT Terminal Enclosure, was shown off at the Trenton Computer Festival in May, and is designed to provide such an enclosure for the do-it-yourself person. The enclosure is made by a structural foam process which uses fire retardant high heat, high impact polystyrene. The enclosure is light weight, but is said to be rigid and tough. It is designed for a complete CRT terminal, and consists of a base section 19 inches (48.3 cm) by 21 inches (53.3 cm) by 4 inches (10.2 cm) and a shroud measuring 11.25 inches high (28.4 cm) featuring a smoke grey screen. It is said that the enclosure will take a monitor up to 14 inches (35.6 cm) diagonal measure. This housing sells for

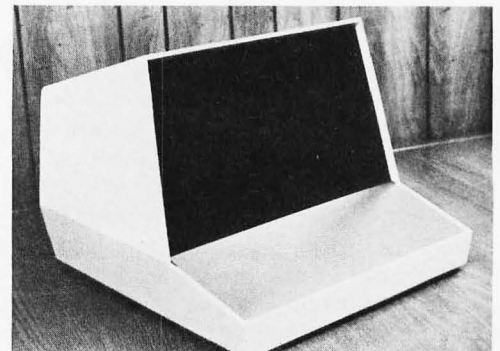

\$69.95, and less expensive models (without monitor shroud) are also available. The products are supplied with hardware, and additional openings can be cut in the material using ordinary woodworking tools. Contact Enclosure Dynamics, PO Box 6276, Bridgewater NJ 08807. ■

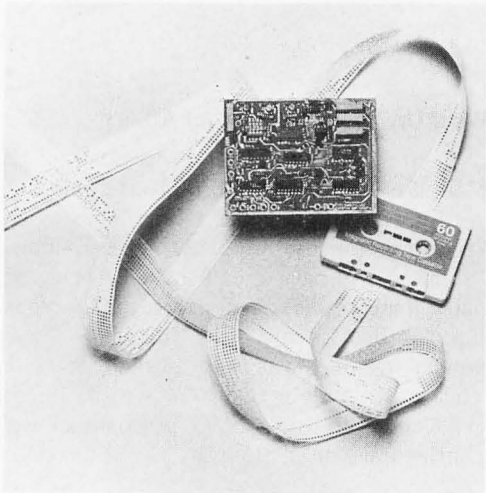

Here's an Interesting Combination of Peripheral Functions!

Electronic Product Associates Inc, 1157 Vega St, San Diego CA 92110, (714) 276-8911, sent along an announcement of this new, low cost audio cassette, Teletype or CRT terminal adapter which allows any serial TTL or MOS output to simultaneously interface a low cost audio cassette recorder via frequency shift keying (BYTE Standard) up to 300 baud and to a standard RS232 CRT and a 20 mA current loop Teletype. The adapter also simultaneously decodes BYTE Standard FSK data from low cost audio cassette players and from 20 mA current loop Teletype and RS232 CRT. Audio cassette information is decoded by a proprietary phase locked loop system developed by EPA which is said to be the most reliable method available for transferring digital data to and from low cost audio cassette players. The model TCC3 is 4.5 X 3.25 inches (11.5 cm X 8 cm) and mounts piggyback on the EPA Micro-68 development computer. The TCC3 price is \$129 in singles, completely assembled and tested. Delivery is quoted from stock. ■

Software New Product

33 Programs and Projects for the Altair 8800 is a new self-published book by Jacques Roth, 543 16th Av, San Francisco CA 94118. This book is a 51 page collection of information printed on loose leaf pages

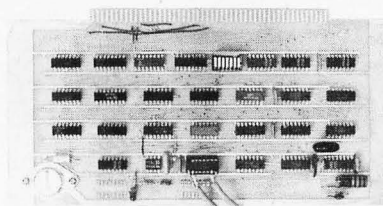

The Tarbell Cassette Interface

- Plugs directly into your IMSAI or ALTAIR
- Fastest transfer rate: 187 (standard) to 540 bytes/second
- Extremely Reliable—Phase encoded (self-clocking)
- 4 Extra Status Lines, 4 Extra Control Lines
- 25-page manual included
- Device Code Selectable by DIP-switch
- Capable of Generating BYTE/LANCASTER tapes also.
- No modification required on audio cassette recorder
- Complete kit \$120, Assembled \$175, Manual \$4

TARBELL ELECTRONICS

144 Miraleste Drive #106, Miraleste, Calif. 90732
(213) 832-0182

California residents please add 6% sales tax

BURKESHIRE SYSTEMS PRESENTS

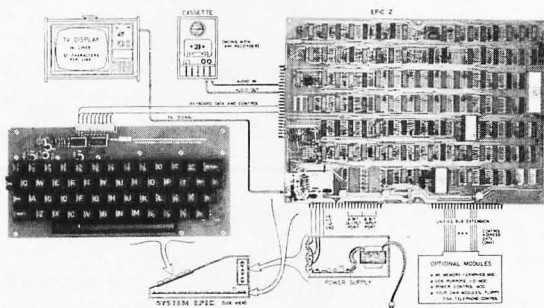

EPIC 2K & EPIC 2

KIT ASSEMBLED

DISCOVER THE EPIC 2: A COMPLETE ONE-BOARD MICRO-COMPUTER SYSTEM AT AN AFFORDABLE PRICE.

EPIC 2 features:

- Easy to use teletype-style fully encoded keyboard.
- Programs loaded and stored via your standard audio tape recorder.
- Video interface — displays 16 lines of alpha numeric characters on your TV set or optional video monitor.
- Unified extendable bus.
- 2 K RAM memory.
- 256 byte PROM bootstrap.
- 2 MHz 8080 micro-computer.
- 16 general purpose I/O lines.
- Standard programs included: Monitor, Text Editor, Game of Life, Blackjack Game.
- Memory expansion and our optional Vector Graphics Software Package allows you to create, display, and store graphics.
- Many more options to come!

Please send me _____ EPIC 2K (s). Enclosed is \$495 for each EPIC 2K ordered.

Please send me _____ EPIC 2 (s). Enclosed is \$775 for each EPIC 2 ordered.

(California residents include 6% sales tax)

I am allowing 90 days for delivery.

Name _____

Address _____ City _____ State _____ Zip _____

For additional information please write:

BURKESHIRE SYSTEMS P. O. Box 512 Mountain View, California 94040

with three hole punching. Programs range from the simple to the devious, and are all designed to run in less than 1 K bytes, with many taking fewer than 256 bytes. Projects include an XY scope plotter using an oscilloscope, two DACs and the PI/O board, a Pong game for the scope interface, a computer telephone dialer interface with several phone dialing programs, a monitor program, etc. Other programming projects include Tic Tac Toe, a 1 byte bubble sort program, and a package of 4 byte arithmetic functions including integer addition, subtraction, negation, move, set zero, left shift, right shift and multiply. The price of this collection is \$5.95 postpaid from Mr Roth. ■

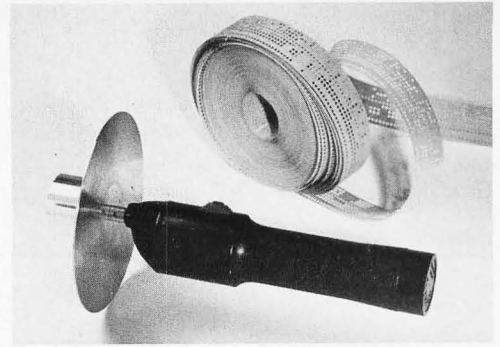

Wind Up Your (Paper Tape) Affairs

Continuous Expression Processor Inc, 12 Main St, Natick MA 01760, has come out with this cordless paper tape winder as an accessory for use in paper tape systems. (Suppose you have one of the hand powered paper tape readers. You can automate your input processes by using this paper tape winder to pull the tape through the reader.) The unit requires two "C" size flashlight cells and sells for \$29.95 postpaid in the continental United States. ■

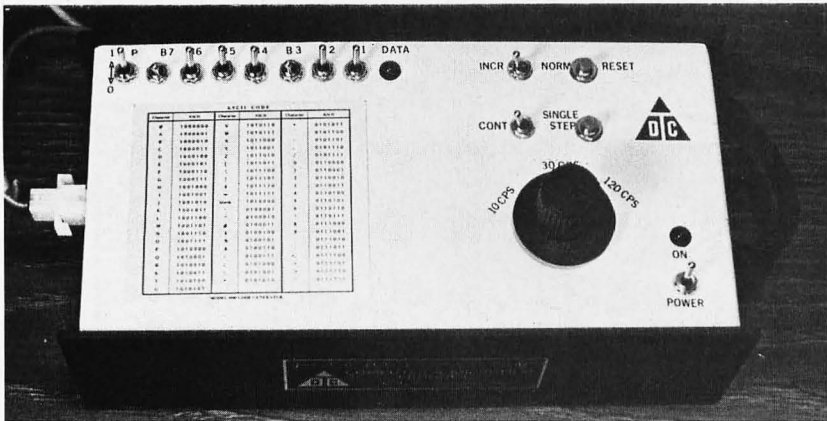

Attention: Computer Service People and Clubs

One way to check out computer terminals and other ASCII serial data and communications equipment is to utilize an ASCII pattern generator such as this new product of the Terminal Data Corporation

of Maryland, 11878 Coakley Cir, Rockville MD 20852. This self contained device comes with male and female RS-232 interface plugs, utilizes a 0.01% crystal oscillator for generation of 110, 300 and 1200 baud data rates, and automatically generates ASCII serial patterns: one at a time or continuously, the same character (set by toggle switches) or scanning through the character set. The Model #900 test set is offered as a kit for \$249, with a special introductory price of \$199 good until September 30 1976. The assembled and tested price is \$395. ■

Another Completely Packaged Computer

Electronic Tool Co, 4736 W El Segundo Blvd, Hawthorne CA 90250, has introduced a new microcomputer system, based on the

MOS Technology 6502 CPU, priced at \$675. The ETC-1000 comes with a 40 key keyboard, a programmable 8 digit display, IO interfaces, power supply and memory. All systems are fully assembled, tested and ready to run. According to its manufacturer, the ETC-1000 is intended for system development, control, and small scale data processing applications. As a development system, it provides system support for hardware and software design work. As a control system, it offers an inexpensive high speed computing capability in a sturdy rack mountable package.

The manufacturer describes the ETC-1000 as a "full capability high-performance computer system which you can have running 10 minutes after you open the box." The system needs no external

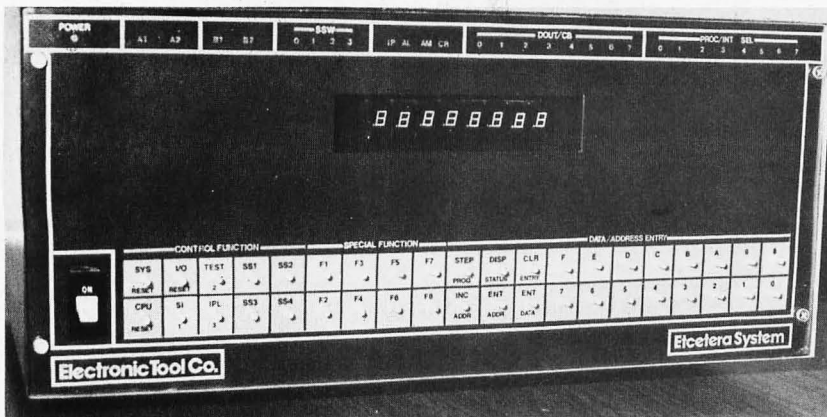

ANNOUNCING! MICROCOMPUTER PRODUCT SURVEY

60 companies manufacture main-frames and peripherals for micro-computing market. Do you know who they are? The MPS does! Hardware and software are expensive today for small business let alone a personal system. Before you buy invest in thoughtware, shop by comparison through MPS. No advertising, we just report the electronic parameters, software features, price and company profile of firms selling in the microcomputer market.

First Issue Nov. 15

FULL DETAILS.....\$1.00
SAMPLE ISSUE.....\$3.00
SUBSCRIPTION.....\$9.00

SBS

1800 Wayne #1
Bellevue Ne 68005

WANTED

Microprocessors Kit or Assembled
ALTAIR • SPHERE • MOTOROLA
INTEL & OTHERS
Altairs, immediate delivery.

Memories, I/O boards, chassis, power supplies, modems, peripherals, specials, prom programmers, ADCS, DACS, GPIOS, RS232 faces, and any associated software. Ask about our complete Altair system. Available now.

FORWARD INFORMATION AND/OR
INQUIRIES TO:

**AMERICAN USED MICROPROCESSORS,
EQUIPMENT & SUPPLY CORP.
AT THE CHICAGOLAND AIRPORT
BOX 515
PRAIRIEVIEW, ILLINOIS 60069
TELEPHONE (312) 634-0076**

For complete monthly catalog of items available and in stock Enclose \$10. for six issues. Many new unused items. Amazing values for everyone. Tested and guaranteed.

*Computer Mart
of
New York Inc.*

**NOW ON
LONG ISLAND**

IMSAI, SWTPCo, Digital Group
Processor Tech, Apple, OSI
TDL-Z-80, Seals, Cromemco,
Sphere, Tarbell, Oliver

Magazines, books, chips,
sockets, connectors, terminals.

**IT'S ALL HERE WAITING FOR YOU
FRIENDLY ADVICE TOO**

New York City
314 5th Ave
(32nd St)

Long Island
2072 Front St
East Meadow NY
Phone

FOR SALE

13 Altair 880 microprocessors, all in good physical condition, excellent working condition.

\$285.00 each

4K Dynamic memory
\$125.00

and

88 - ACR Boards
\$100.00

Call:

Dr. Dan Nash
405-524-1209
eves. and wknds.

**N. Y.'s Newest Store for
Micro and Mini Computer
Hardware and Software.**

We will be featuring a large selection of: IMSAI (kits and assembled) Processor Technology's full line. Also a selection of choice modules from Cromemco, Solid State Music and others. Plus: full line of TTL logic, discrete components, memory and MPU chips.

Audio Design Electronics
487 Broadway Suite 512
New York NY 10013

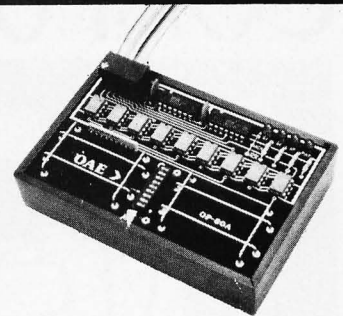

Pictured above is the new OP-80A High Speed Paper Tape Reader from OAE. This unit has no moving parts, will read punched tape as fast as you can pull it through (0-5,000 c.p.s.), and costs **only \$74.50 KIT, \$95.00 ASSEMBLED & TESTED.** It includes a precision optical sensor array, high speed data buffers, and all required handshake logic to interface with any uP parallel I/O port.

To order, send check or money order (include \$2.50 shipping/handling) to Oliver Audio Engineering, 7330 Laurel Canyon Blvd., No. Hollywood, CA 91605, or call our 24 hr. M/C-B/A order line: (213) 874-6463.

attachments such as Teletypes, power supplies, or memory expansions to provide basic programming capability and computer operation. Many expansion options are available, including communications, real-time and DMA interfaces, memory expansions, and various add-on CPUs.

A 40 key keyboard for control and data entry is mounted on the front of the ETC-1000. This keyboard includes a full set of hexadecimal keys for data and address entry, system function keys such as load, reset, examine memory, etc. Eight special function keys which may be sensed under program control by the user are available for assignment to user-specified functions.

An 8 digit LED panel display is also contained in the ETC-1000 control unit to display memory contents, system status and user programmed information.

The ETC-1000 contains a direct input output system consisting of eight latched output lines and eight latching input lines which may be used under program control to operate external devices. A hardware interrupt system with two levels is standard; eight additional levels are available. The company says one or two independent full duplex communications streams at speeds between 110 and 1200 bits per second are

supported by the ETC-1000 basic system when appropriate PROMs are included. Selection of speed is accomplished automatically by the hardware. 20 mA DC current loop interfaces are provided as standard, with EIA RS-232C capability optional.

The ETC-1000 CPU consists of a MOS Technology 6502 8 bit CPU, plus clocks, control logic, interface buffers, 1024 bytes of high speed RAM, and 256 bytes of ROM containing system control functions.

Software currently available includes a resident assembler, IO handlers, diagnostics and other support tools. The manufacturer says that BASIC and PLM support are expected to be available during the third quarter of 1976.

Availability of standard configurations is 30-60 days. ■

Attention Analog Interfacers . . .

National Semiconductor Corporation has just announced a new building block for analog input interfaces. This is the MM5356 8 bit analog to digital converter. The function provided by this chip is converting an input voltage of typically 0 to 10 V or -5 to +5 V into an 8 bit binary word. In order to operate properly, the circuit requires a con-

Stamp Out Cybercrud

COMPUTER



BYTE PETERBOROUGH, NH 03458

Have you every been victimized by one of a myriad computer based inter-personal putdowns? In Ted Nelson's book, *Computer Lib/Dream Machines*, you'll find an excellent essay on the nature of this "cybercrud."

Have you ever wondered where to go for a basic starting point in your quest for information about computer applications and uses? Ted Nelson's book, *Computer Lib/Dream Machines*, is the place for you to begin.

Computer Lib/Dream Machines is for the layman — the person who is intelligent and inquisitive about computers. It is written and self published by a philosopher who is also a self confessed computer fan and an excellent teacher of basic concepts. (For those who have not yet heard, ivory towers are constructed out of real and substantial white bricks.) The most important aspect of this book

is its inspirational data content. The machines we're all busy working on are deep personal expressions, and not the cold and inhuman monsters of the traditional stereotype. The book defines many of the terms and explains many of the techniques which can be used in the personal computer systems we're all busy constructing and programming. It performs this service in a way which adds color and excitement to this newest of art forms, the computer application.

Computer Lib/Dream Machines is must reading for the beginner, and is also a refreshing self examination for the old hand at programming and systems work.

You can order your copy of *Computer Lib/Dream Machines* from BYTE's Books for \$7. Send your order today to BYTE's Books, 70 Main St, Peterborough NH 03458. Help stamp out cybercrud.

Please add 50 cents for postage and handling. Please allow six weeks for delivery.

Send _____ copies of **Computer Lib/Dream Machines** to:

Name _____

Address _____

City _____ State _____ Zip _____

Check enclosed

Bill MC # _____ Exp. Date _____

Bill BA # _____ Exp. Date _____

Signature _____

version clock of at least 5 kHz and as much as 2 MHz. The actual conversion time required is specified in the timing diagram of its specification as 40 clock periods. Thus if the clock rate were 40 kHz, the unit could be used to generate a valid digital word 1 millisecond after the beginning of the "start conversion" input command signal. Operating at a typical microprocessor clock frequency of 1 MHz, the conversion time would be 40 μ s, corresponding to a maximum sample rate of 25,000 measurements per second.

Where would this item prove useful in the context of personal systems? Well, consider the problem of reading the voltage on a thermocouple used to measure temperature. After amplification and normalization with operational amplifiers, the signal could be read by the analog to digital converter and used in a program written to implement a digital feedback loop used in controlling temperature in some way. Consider the problem of deriving the coefficients used in controlling a digital speech synthesizer: An ADC is an essential input to the process of analyzing such data. Or simply consider the general laboratory problem of using your computer as a voltmeter: Put a voltmeter

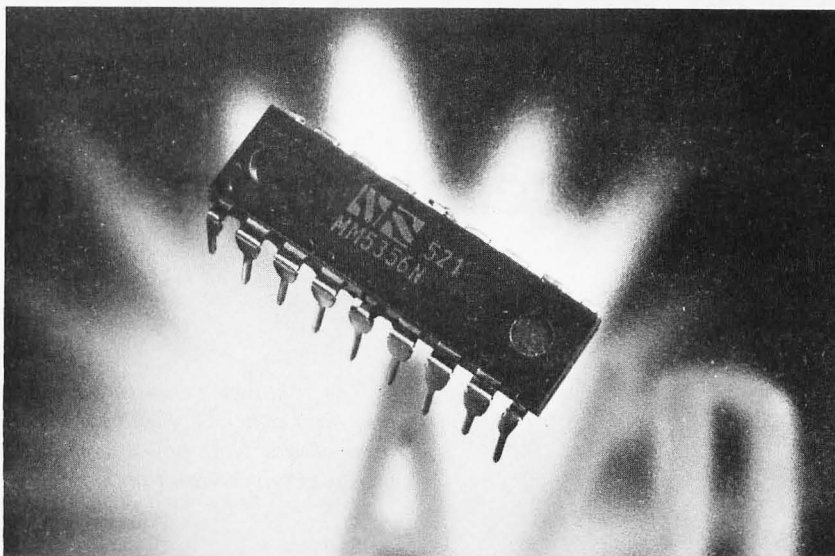

analog front end on this converter and have your TV display put out the values it reads.

National Semiconductor is located at 2900 Semiconductor Dr, Santa Clara CA 95051. The 100 piece price of this conversion chip is listed as \$7.95, so it certainly should be available at a reasonable price through distributors and retailers. ■

Photocopy or cut out this solicitation for information and send to:

CHEAP, INC.

7338 Baltimore Ave., Suite 200
College Park, Maryland 20740

JOINT VENTURE

GROUP OEM BUYS

CHEAP, Inc. was set up to coordinate joint venture OEM Group Buys! Depending upon the total quantity of commitments received, you can expect to pay from 20% to 70% of the retail sales price. Now you too can combine your orders with others throughout the country to purchase factory new electronic components at OEM rates. We will accept small Factory and Club commitments as well as individual commitments.

Circle below the products you may be interested in and estimate their quantity. After we receive this survey, we shall send, to you, more information, prices and delivery dates.

Memories: 91L02 _____, 2102 _____, 1702 _____
MicroP: Z80 _____, 8080A _____, 6800 _____
P.C. Boards: Computer Grade double buffered optional parity memory boards compatible with the Altair 8800 on one edge and the Altair 680 on the opposite edge; 4:8:16K _____
Floppy Disk Drives _____, Disk Controller _____
Mag. Tape Drives _____, Modems _____
TV Monitors _____, Oscilloscope _____
Sockets: 14 Pin _____, 16 pin _____
24 pin _____, 40 pin _____, Other _____
Software: Fortran _____, PL/1 Subset _____
Other: _____
Other: _____

EXTRA: We will consider purchasing general purpose P.C. Boards and Kits, etc. Write us about what you may have to offer and its OEM prices.

Attention: KIM-1 owners.

For Sale: Assembler program compatible with MOS Technology assembler. Uses KIM-1 cassette interface for storage of source and object programs. Also includes a text-editor program, and both run in 4K of memory. They are distributed on cassette in both source and object form, in case you wish to improve or modify them to suit your needs. Assembler/text-editor .. \$19.50 ppd. Write for details on sale of your programs on a commission basis.

Micro Software Specialists, Inc.
2024 Washington St
Commerce TX 75428.

STANDARDIZE!

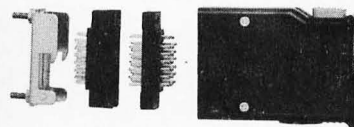

SPECIAL OFFER . . .

HIROSE 20 PIN CABLE +
CHASSIS MOUNT CON-
NECTOR

(solder) ONLY \$14.95
REGULARLY \$17.00

Rugged, Reliable, widely
used in video applications.
Qty. discount, no C.O.D's,
Details, Specs:

JOHN ANTHONY TELEVISION
DINGMANS FERRY
PA. 18328

A122

Excerpts from Future History

The following series of passages was compiled by reader John W Burgeson in a term paper he wrote for his "history of technology" course in the spring term of '25. Note how the attitudes remain the same, but the objects of the attitudes evolve with time.

John W Burgeson
101 Skyline Rd
Georgetown TX 78626

Who Wants an Automobile?

Toward the end of the last century, nobody "wanted" an automobile. Whether the invention of the horseless buggy was due to accident, play, tinkering or rational thinking on the part of people endowed with mechanical abilities is immaterial for our purposes. Surely the invention did not originate with the consumer and was not made with an eye to prevailing consumer wants. Even when the first cars appeared on the road and for many years thereafter, their use for mass transportation was envisaged neither by producers nor by consumers. But today, even small children in America feel the need for a car to take them and their parents shopping, visiting, and later to school. Between the early days of the automobile and the present situation there was a long period of social learning. The learning process was, of course, not spontaneous; first of all, it could not have taken place without the original invention; second, it was a function of numerous stimuli — personal experience, education, and reading, as well as propaganda and advertising. Thus it may be said that wants for automobiles were induced, or to use Galbraith's term, "contrived." But are not most of our wants contrived in this sense? And are not most of our contrived wants, in a certain sense, original with the buyer? It can hardly be said that such want-creation is artificial.

George Katona, The Mass Consumption Society, New York, McGraw Hill, 1964, page 55.

Who Wants a Percom?

Toward the middle of the 1970s, nobody "wanted" a percom. Whether the invention of the personal computer was due to accident, play, tinkering or rational thinking on

the part of people endowed with electronic abilities is immaterial for our purposes. Surely the invention did not originate with the consumer and was not made with an eye to prevailing consumer wants. Even when the first computers appeared in the offices of large companies and for many years thereafter, their use for mass personal use was envisaged neither by producers nor by consumers. But today, even small children in America feel the need for a percom to help them and their parents manage their affairs, help them with schoolwork, entertain them with electronic games and the like. Between the early days of the percom and the present situation there was a long period of social learning. The learning process was, of course, not spontaneous; first of all, it could not have taken place without the original invention; second, it was a function of numerous stimuli — personal experience, education, and reading, as well as propaganda and advertising. Thus it may be said that wants for percoms were induced, or to use Galbraith's term, "contrived." But are not most of our wants contrived in this sense? And are not most of our contrived wants, in a certain sense, original with the buyer? It can hardly be said that such want-creation is artificial.

George Katona Jr, The Mass Consumption Society (Second edition), New York, McGraw Hill, 1996, page 55.

Who Wants a Homer?

Toward the end of the last century, nobody "wanted" a homer. Whether the invention of the home robot-computer was due to accident, play, tinkering or rational thinking on the part of people endowed with cybernetic abilities is immaterial for our purposes. Surely the invention did not originate with the consumer and was not

made with an eye to prevailing consumer wants. Even when the first real-time mini-computers appeared and for many years thereafter, their use for personal home management, protection and entertainment was envisaged neither by producers nor by consumers. But today, even small children in America feel the need for a homer to help them and their parents to manage their lives, protect them, entertain them and the like. Between the early days of the homer and the present situation there was a long period of social learning. The learning process was, of course, not spontaneous; first of all, it could not have taken place without the original invention; second, it was a function of numerous stimuli — personal experience, education, and reading, as well as propaganda and advertising. Thus it may be said that wants for homers were induced, or to use Galbraith's term, "contrived." But are not most of our wants contrived in this sense? And are not most of our contrived wants, in a certain sense, original with the buyer? It can hardly be said that such want-creation is artificial.

George Katona III, The Mass Consumption Society (Third edition), New York, McGraw Hill, 2024, page 55. ■

ANY WAY YOU WANT IT!

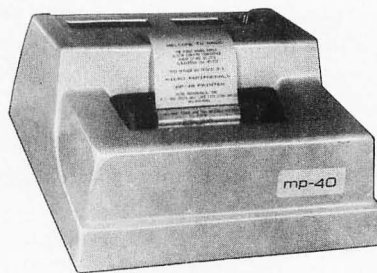

5 X 7 IMPACT DOT MATRIX • 75 LINES PER MINUTE
40 COLUMNS • 12 CHARACTERS PER INCH
6 LINES PER INCH • ORDINARY ROLL PAPER
CHOOSE FROM THESE THREE ASSEMBLED AND TESTED MODELS COMPLETE WITH CASEWORK AND POWER SUPPLY

- LCP-40 • Parallel I/F without character generator for special software fonts \$329
 - MP-40 • Parallel I/F with 64 character ASC II set \$425
 - SSP-40 • Serial RS232 or current loop - TTY compatible \$499
- OR SELECT THE "NO FRILLS" KP-40
- Mechanism, LCP I/F, PC and components \$179

SEND FOR FREE LITERATURE

Master Charge Welcome • Utah Residents Add 5% Sales Tax
mpi / P.O. BOX 22101 / SALT LAKE CITY / UT / 84122
801-566-0201

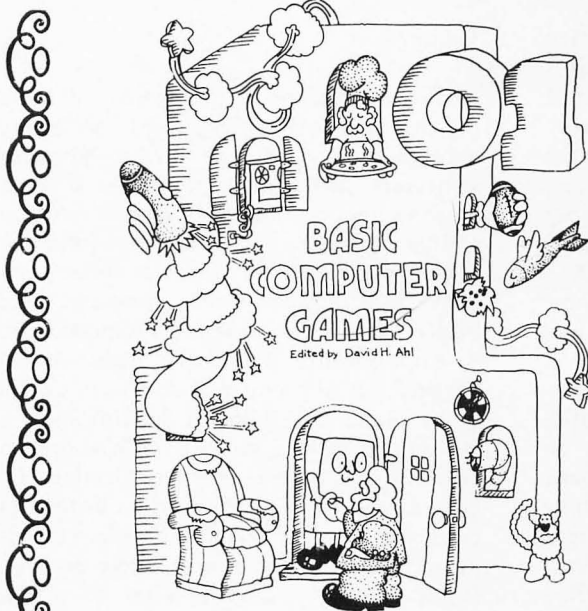

101 BASIC Computer Games is the most popular book of computer games in the world. Every program in the book has been thoroughly tested and appears with a complete listing, sample run, and descriptive write-up. All you need add is a BASIC-speaking computer and you're set to go.

101 BASIC Computer Games. Edited by David H. Ahl. 248 pages. 8½x11 paperbound. \$7.50 plus 75¢ postage and handling (\$8.25 total) from Creative Computing, P.O. Box 789-M, Morristown, NJ 07960.

Contents

| Game | Brief Description | | |
|--------|--|---------|--|
| ACEYDU | Play acey-ducey with the computer | HI-LO | Try to hit the mystery jackpot |
| AMAZIN | Computer constructs a maze | HI-Q | Try to remove all the pegs from a board |
| ANIMAL | Computer guesses animals and learns new ones from you | HMRABI | Govern the ancient city-state of Sumeria |
| AWARI | Ancient game of rotating beans in pits | HOCKEY | Ice Hockey vs. Cornell |
| BAGLES | Guess a mystery 3-digit number by logic | HORSES | Off-track betting on a horse race |
| BANNER | Prints any message on a large banner | HORBLE | Drill in simple kinematics |
| BASBAL | Baseball game | KINEMA | Govern a modern island kingdom wisely |
| BASKET | Basketball game | KING | Guess a mystery letter — computer gives you clues |
| BATNUM | Match wits in a battle of numbers vs. the computer | LETTER | John Conway's Game of Life |
| BATTLE | Decode a matrix to locate enemy battleship | LIFE | Competitive game of life (2 or more players) |
| BINGO | Computer prints your card and calls the numbers | LIFE-2 | Children's literature quiz |
| BLKJAC | Blackjack (very comprehensive), Las Vegas rules | LIT0Z | Children's arithmetic drill using pictures of dice |
| BLKJAK | Blackjack (standard game) | MATH01 | Monopoly for 2 players |
| BOAT | Destroy a gunboat from your submarine | MUGWMP | Locate 4 Mugwumps hiding on a 10 x 10 grid |
| BOMBER | Fly World War II bombing missions | NICDMA | Computer guesses number you think of |
| BOUNCE | Plot a bouncing ball | NIM | Chinese game of Nim |
| BOWL | Bowling at the neighborhood lanes | NUMBER | Silly number matching game |
| BOXING | 3-round Olympic boxing match | ICHECK | Challenging game to remove checkers from a board |
| BUG | Roll dice vs. the computer to draw a bug | ORBIT | Destroy an orbiting germ-laden enemy spaceship |
| BULCOW | Guess a mystery 5-digit number vs. the computer | PIZZA | Deliver pizzas successfully |
| BULEYE | Throw darts | POETRY | Computer composes poetry in 4-part harmony |
| BULL | You're the matador in a championship bullfight | POET | Computer composes random poetry |
| BUNNY | Computer drawing of the Playboy bunny | POKER | Poker game |
| BUZWD | Compose your speeches with the latest buzzwords | QUBIC | 3-dimensional tic-tac-toe |
| CALNDR | Calendar for any year | QUEEN | Move a single chess queen vs. the computer |
| CAN-AM | Drive a Group 7 car in a Can-Am road race | REVERSE | Order a series of numbers by reversing |
| CHANGE | Computer imitates a cashier | ROCKET | Land an Apollo capsule on the moon |
| CHECKR | Game of checkers | ROCKT1 | Lunar landing from 500 feet (with plot) |
| CHEMST | Dilute hydrocyanic acid to make it harmless | ROCKT2 | Very comprehensive lunar landing |
| CHIEF | Silly arithmetic drill | ROCKSP | Game of rock, scissors, paper |
| CHOMP | Eat a cookie avoiding the poison piece (2 or more players) | ROULET | European roulette table |
| CIVILW | Fight the Civil War | RUSROU | Russian roulette |
| CRAPS | Play craps (dice), Las Vegas style | SALVO | Destroy an enemy fleet of ships |
| CUBE | Negotiate a 3-D cube avoiding hidden landmines | SALVO1 | Destroy 4 enemy outposts |
| DIAMND | Prints 1-page diamond patterns | SLOTS | Slot machine (one-arm bandit) |
| DICE | Summarizes dice rolls | SNOOPY | Pictures of Snoopy |
| DIGITS | Computer tries to guess digits you select at random | SPACWR | Comprehensive game of spacewar |
| DOGS | Penny arcade dog race | SPLAT | Open a parachute at the last possible moment |
| EVEN | Take objects from a pile — try to end with an even number | STARS | Guess a mystery number — stars give you clues |
| EVEN1 | Same as EVEN — computer improves its play | STOCK | Stock market simulation |
| FIFPOP | Solitaire logic game — change a row of Xs to Os | SYNONM | Word synonym drill |
| FOTBL | Professional football (very comprehensive) | TARGET | Destroy a target in 3-D space — very tricky |
| FOTBAL | High School football | 3D PLOT | Plots families of curves — looks 3-dimensional |
| FURS | Trade furs with the white man | TICTAC | Tic-tac-toe |
| GOLF | Golf game — choose your clubs and swing | TOWER | Towers of Hanoi puzzle |
| GOMDKO | Ancient board game of logic and strategy | TRAIN | Time-speed-distance quiz |
| GUESS | Guess a mystery number — computer gives you clues | TRAP | Trap a mystery number — computer gives you clues |
| GUNNER | Fire a cannon at a stationary target | 23MTC | Game of 23 matches — try not to take the last one |
| GUNER1 | Fire a cannon at a moving target | UGLY | Silly profile plot of an ugly woman |
| HANG | Hangman word guessing game | WAR | Card game of war |
| HELLO | Computer becomes your friendly psychiatrist | WAR-2 | Troop tactics in war |
| HEX | Hexapawn game | WEKDAY | Facts about your birthday |
| | | WORD | Word guessing game |
| | | YAHTZE | Dice game of Yahtzee |
| | | ZOOP | BASIC programmer's nightmare |

The formal organizations used for clubs and societies can range from the totally informal (one person arranging a regular meeting place) to the setting up of all sorts of corporate nonprofit organizational structures, etc. The informal versions usually work best for small groups; formal organization tends to increase with the size of the group. Whatever the case, the less time spent on long drawn out nitpicking at business meetings, the more time there is to devote to more interesting matters

Meeting Activities for Computer Clubs

Dr Charles F Douds
381 Poplar St
Winnetka IL 60093

A bunch of you got together and started a computer group? Congratulations! That is a good thing for this wonderful and fast growing hobby. You are meeting once every month? Fine, that will help to spread the word about the latest products, glitches, and cures. New people keep showing up at your meetings wondering what it is all about? That's the way it went in Chicago, too. And lots of other places, I'm sure. But now you've gotten to know each other, you're beginning to wonder what you should do at your meetings.

That is an important point. The activities at meetings can make or break such an organization. People don't have to come, and they won't if they don't get something out of them. They want many different kinds of things. They want to learn something. They want to share their ideas. They want to ask questions. They want to socialize. They want to see things. They want help. Of course, not everyone wants all of these at the same time and most people don't want the same thing all the time. Variety and choice are important. If you look around you at other successful special interest organizations you will find many ideas for the kinds of things you might do. Here are some that I found.

Lectures

This is often the first thing you will think of, and quite easy to organize. The lecture may be by one of your own members or somebody invited in from outside. It could be an engineer or analyst from a local firm; a college professor; a sales engineer from one of the big electronics firms or other company utilizing electronics products. The bigger firms might even send somebody in.

Arrangements should be made well in advance. Usually you will do this in person or by phone and follow it up with a letter. Be sure to include detailed instructions on how to get to the meeting location. Of course, you have to get it set up in time to publicize the speaker and his topic. Perhaps he can join you for a meal before or after. Don't forget to send a letter of thanks afterwards. Better yet if you can send it to his boss when that is appropriate.

There are two main problems with lectures. One is finding out how good the speaker is beforehand. A major problem here is that he or she may be good for one kind of audience, but not for yours. It is very likely that your group will be a very mixed bag of hardware types, software types, and enthusiastic types that don't know much

Activities at meetings of computer organizations can make or break the group.



about hardware or software. That poses a real problem to a speaker in front of a large group.

The other problem with lectures is having too many of them. They are about the easiest kind of program to arrange, but people get tired of being talked at. Discussion with large groups doesn't work too well. A couple of poor speakers in a row can easily turn off a whole group. Program variety and member choice are important ingredients to a successful group.

Clinics

Clinics are less formal and often involve smaller groups than a lecture. More than one clinic can go on at the same time. People have a choice and different types of topics can be handled. A clinic is usually limited, for example, to one hour. It may also be a lecture, but it can take many different forms. The topics covered can be just about anything. They might include: design of an IO circuit, printed circuit artwork techniques, debugging procedures, an overview of high level languages, etc. The presentation may be in the lecture mode, or the author might simply talk, work on a blackboard, use flip charts, work at his computer keyboard, or use slides or transparencies.

Clinics are greatly enhanced if a handout is provided. It may be just a list of key points or provide details about what is being discussed. Sometimes a marketing minded manufacturer may be willing to provide material to a local member presenting a clinic about the manufacturer's equipment. For reference purposes handouts should include the author's name and address.

If hardware is used or demonstrated, you need to make sure that the group is small so that everyone can see. If you are meeting in a high school or a college and have a crowd, you might be able to use a closed circuit TV so that the people in the back of the room don't go away saying it was lousy, while the ones in the front say it was great. For the same reason, consider the use of PA systems if you are likely to have a large audience.

It is very important that the host check up well beforehand to find out what the author will need and what he or she is going to bring. Assume that the speaker will forget things like extension cords, chalk, and erasers. It is particularly important to check on projectors, screens, and electrical outlets. Make sure that they actually have power in them. Find out where the lighting switches are (especially in motels and hotels!) and where the background music can be turned off. Again, don't forget the thank you letters.

When you get to the point that on occasion several clubs get together for a "meet" that might last a weekend, or you decide to put on a real bash in just your own group, you will probably have several clinics.

This is great because people can then get to the topics that particularly interest them, and still not be trapped in a room for something they care little about. But many people will want to get to all the clinics. This can sometimes be worked out by careful scheduling and persuading the authors to present their clinics twice. This isn't quite as bad for the author as it sounds. An hour clinic is really only 50 minutes and usually at least another 10 minutes should be allowed for questions. Besides, the practice is good for him or her. (I expect to see a lot more women actively involved in this hobby than in other comparable ones such as ham radio or model railroading.)

Demonstration ("Hall") Clinics

If you don't have a lot of rooms for all the clinics you would like to provide, or if you just have one big room where several speakers would interfere with each other, "hall" clinics might solve your problem. They can literally be set up in the halls; but more usually a number of them will be held in a large room — the kind that used to be called a hall.

In the demonstration clinics one person does his thing for an extended period of time. Perhaps he is assembling a kit, laying out the artwork for a printed circuit board,

A lecture, with a good speaker on a topic of interest to the group, is one of the easiest types of activity to organize.

NOTE:

A brief version of this article originally appeared in the *Micro-8 Newsletter*, vol 2, no 2.

demonstrating his operating system, or whatever. The topics may be similar to the regular clinics, but the format is different. The author does not lecture. He simply talks about what he is doing. He explains and answers questions as he goes along. This gives people the chance to see all the details and exactly how things are done. People are free to move from one demonstration to the next spending as long as they like at each.

It is often important that tables or railings be set up to keep people a few feet back. This makes it possible for a half dozen or so people to see, while still being close enough to observe the details. It is best arranged so that the demonstrator can hand things to the viewers if he wishes to.

Participation Clinics

These clinics would be called "labs" in a school curriculum. The audience gets their heads and hands into the topic and learns by doing. These are good for such things as lessons on programming or introductory circuit design. These clinics require very careful preparation by the author. He or she should fully test out the lesson beforehand. Of course, not a whole lot can be accomplished in an hour or two, but the most important thing is that it gets people started. The author can only do a little bit of teaching, followed by a lot of individual helping. Often these kinds of clinics are best run by two people working together.

If equipment is going to be used — pin boards, voltmeters, etc — it may be necessary to have people sign up beforehand. Sometimes it may be possible to have people work in pairs. As long as the room doesn't get too crowded, it may be possible to let others in as spectators. The host should be prepared to shoo out excess people. The author will appreciate not having to do this for he or she may be busy with the instruction.

Make sure that there will be enough materials available for a reasonable number of people to participate. Don't call it a "participation" clinic if only two or three can do so.

Do It Yourself Clinics

In these kinds of clinic the audience builds something and takes home a working device. They are immensely popular if adequately publicized, but they often require a lot of work to prepare. The item is announced beforehand. It might be a logic probe or a simple power supply. Participants send in their checks for the cost of parts. The announcement includes the list of tools needed, specified *very* exactly. (You would

be amazed at the variety of soldering irons and pliers model railroaders will bring to build a printed circuit item!)

At the clinic the author then shows the participants how to build the device step by step. It is very important that there be adequate facilities for checking the devices, too. You are trying to provide people with their first success in a new (for them) endeavor. There is nothing like the feeling of going home with a gadget you know for sure works.

Obviously, it is important that the project be small enough so that it can be built and tested by the neophyte in the available time. It is important that this be checked out beforehand. If there are more than six or eight participants, the author should have one or two helpers — people who know a capacitor from a resistor, can read the color code, and who can recognize a cold-soldered joint.

It might be possible to have "advanced level" clinics of this sort. The problem is that people who are not adequately advanced will still sign up anyway. Not only are they likely to go away dissatisfied, but the author may get trapped into having to rebuild a half dozen units for these people. Keep the projects simple and short. With the complex chips available today, one still might be able to come up with relatively sophisticated projects.

Of course, other variations are possible. If it were clearly advertised as such in advance, it might be possible to start construction at one meeting and complete it at a second meeting. The more advanced builders would probably complete the project and be able to test it themselves, so the second session would involve a smaller group.

The host should make sure that there are suitable tables and adequate power outlets to accommodate all participants.

Show and Tell Sessions

Here we take a page out of the stamp collector's and photographer's book. It is a lot of fun to simply see each other's equipment. So much the better if it is up and working, but projects under construction can be very interesting, too.

I suppose you could even have prizes for the best shaped letters on a TV set — with a separate class for monitors. How about one for the hardest to read Teletype? Or the prettiest set up? Or the worst (or would it be "best"?) job of haywiring that actually works! The possibilities are endless. Why not announce that there will be prizes, but not announce the categories. I would expect that altogether too soon we will be having too

A panel discussion, with or without audience participation, can be a good round robin affair which helps clarify and present concepts on a given theme.

SAN FRANCISCO

Action Audio Electronics
Westlake Shopping Center
(415) 756-7440

1. Largest repair facility for computer kits in Northern California.

2. Easy access from all major freeways and BART. 4 blocks from Junipero Serra, Skyline, Highway 1, US 280 and Daly City BART.

3. We sell IMSAI, Cromemco, Blast-Master, Byte, etc.

4. Stop by for a free copy of "8800 BUS"; a current list of all 8800 bus compatible boards.

LEARN μ COMPUTER SOFTWARE

\$49.95 BUYS A COMPLETE COURSE IN PROGRAMMING FOR THE SMALL SYSTEM ENGINEER

- PRINCIPLES
- TECHNIQUES
- EXAMPLES
- APPLICATIONS

LOGICAL SERVICES INCORPORATED

Creative Computer Division
711 Stierlin Road
Mtn View, CA 94043
(415) 965-8365

FREE BROCHURE

8,192 X 8 BIT STATIC MEMORY EXCEPTIONALLY LOW POWER

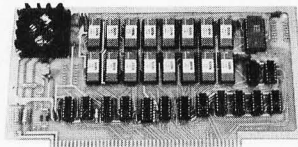

KIT \$295.00

- *ALTAIR 8800/IMSAI 8080 BUS COMPATIBLE
- *FAST 215 nS—FULL SPEED—FOR Z80 ALSO
- *EXCEPTIONALLY LOW POWER—LESS HEAT
- *LESS THAN OTHER "LOW POWER" MEMORY
- *BATTERY STAND-BY CAPABILITY
- *ALL SIGNALS TO MOS DEVICES BUFFERED
- *SOCKETS FOR ALL IC'S

PROTOTYPING BOARD
LOW PROFILE IC SOCKETS
EDGE CONNECTORS
DB25 CONNECTORS

SHIPPING EXTRA, ADD \$2.00
NJ RES. ADD 5% SALES TAX

ELECTRONIC CONTROL TECHNOLOGY
P.O. Box 6, Union, New Jersey 07083

JGM DEVELOPMENT LABS

P. O. Box 2345
W. Lafayette, IN 47906
(317) 463-7167

1/4 watt carbon film resistors.....\$0.03
5 percent, 50 per value min.

1/2 watt carbon comp resistors...\$0.02
10 percent, 50 per value min.

No-Nik wire strippers.....\$16.00
10,12,14,16,18,21,23,25,28,31
34,37,44 or 54 thousandths
wire diameter

Carbide PC board drills
wire size: 55 - 65.....\$2.88
66 - 70.....\$2.97
71 - 75.....\$3.06
76 - 78.....\$3.60
79 - 80.....\$3.60

Spec sheets are available.

We would be pleased to send you a 'GOODIES' catalog listing all kinds of hard to find products including: Molex, Bishop Graphics, AMP, CDC manuals and forms, PC drills and mills, electronics tools, PC board manufacturing supplies, resistors, and semiconductors.

HEY, ALTAIR... GOT THE TIME?

If not, you need COMPTek's NEW CL2400 Real-time Clock.

- Self-contained hardware clock
- Can be set and read by BASIC
- Programmable interrupts
- Top quality board, components, and I.C. sockets
- ALTAIR and IMSAI compatible
- Uses: 24 hour clock
Software timer
Event timer

KIT — \$98 ASSEMBLED — \$135

comptek

"Real World Electronics"

P. O. Box 516
La Canada, CA 91011



64 Pages of News about the Amazing Technological Breakthroughs in the Mini-Micro Computer Field!

Catalog includes:

- Reproductions of manufacturers complete catalogs including IMSAI's—normally \$1.00
- Articles and news on Mini-Micro Computers
- \$2.00 Gift Certificate
- Includes all this and more!

Catalog offers items like:

- \$289 complete Computer System for home use Not a kit!
 - Thorough Home Study Course on *How to Computer Program*. Includes text books and computer!
 - Low cost New and Used Peripherals
 - Many more items!
- Send \$1.00 now (refundable on first order) or Free with Business Card!
- Newman Computer Exchange
3960 Varsity Drive, Dept. 15
Ann Arbor, Michigan 48104

Swap shops and auctions, formal or informal, can be a good addition to a meeting which helps to solve nagging problems of what to do with surplus junk or where to find that critical part or subsystem (which is, of course, someone else's surplus junk).



many committees working on too many prizes, although I must admit that contests do seem to stir up interest and provide real progress among enthusiasts.

I think that the most important aspect of individual displays, apart from the conversations that develop, are the many ideas that one can acquire in such a short time. These may be little details that make life easier or they may be whole new vistas that weren't really meaningful until seen "in the flesh."

Workshops

Workshops can take many forms, cover many subjects, and be conducted in many ways. An expert might work on debugging equipment that participants bring in. Or two or three people might design a special interface. The area is set up in such a way that the audience can watch and listen, but they do not participate. It is important, of course, that the experts do their thinking out loud. Again, a PA system or closed circuit TV may be helpful.

A second type of workshop is essentially a "closed door" session, at least once it starts. Discussion among all the participants is expected. The output of such a workshop is often something that is going to benefit the whole club or others. For instance, the workshop might be devoted to developing a chart comparing the characteristics of certain types of kits, developing the rules and standards for a local computer conferencing network, or other such things. The output of the workshop might become a regular clinic at another meeting. Such workshops require minimal facilities on the part of the host, but the participants certainly have to come adequately prepared and a competent discussion leader is needed.

Panel Discussions

A good panel discussion can fit into many types of programs. The topic area should be definite, but not too narrow, ordinarily, for a hobby group. Sometimes the usual kind of

panel discussion, where the discussants speak their pieces then argue back and forth, is appropriate; but it is probably better for a computer group meeting to have a question and answer panel. The audience asks questions, and one or more panel members tell how they handle the problem. Sometimes members of the audience turn out to have good suggestions, too.

The moderator is the key person in setting up a panel. He or she must not hog the stage, must be able to summarize long or confused questions, and have a facility for steering the discussion among the panel members. The biggest difficulty is in getting the audience participating. It is often wise to have several questions planted with a few friends in the audience. It is entirely natural for people to hesitate to speak up in a crowd until they hear one or two questions that they recognize as being as simple, or simpler, than theirs. A dozen people may have the question in mind, but no one wants to be first. The other important point is to stop the session while the questions are still coming. Stop at a high point, not in a valley — and everyone will go away thinking how great it was.

Tape Slide Programs

Many of the activities above can be worked up into a prepackaged recorded program with accompanying slides. The visuals probably should be 35 mm slides because projection equipment is always available. It might be possible to use cassette tapes, but standard reels are probably better. The problem is that it may be awkward to get adequate sound volume for an ordinary size audience from a cassette machine, while there is seldom a problem with an ordinary home tape recorder.

Tape slide programs can be made successfully by amateurs, but they do not work out by simply recording a live clinic even if it uses a lot of slides. A script has to be prepared and worked over. The final taping



**A SUPERIOR "301"
TYPE OP AMP
*TWO FOR \$1***

SOMETHING FOR LINEAR FANS...

We bought a batch of 201s, which are the same as LM301s but with extended range and better specs. These are factory prime overruns, and are available in minidip or TO-99 style cases--please specify which case style you want.

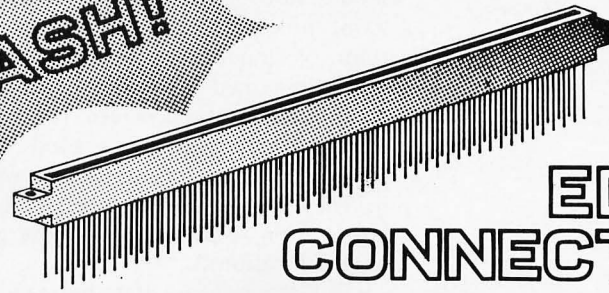
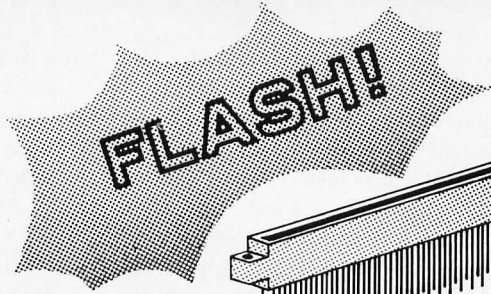

**100
PIN
EDGE
CONNECTOR**

\$5.00 EACH == \$22 FOR 5

SEVERAL ALTAIR OWNERS HAVE BEEN WANTING...A 100 PIN EDGE CONNECTOR THAT ACCEPTS ALTAIR PERIPHERALS. PEOPLE HAVE REPORTED A HARD TIME FINDING THESE CONNECTORS, SO WE GOT A BUNCH FOR OFF-THE-SHELF DELIVERY. DESPITE THE LOW COST, THESE CONNECTORS FEATURE GOLD-PLATED 3 LEVEL WIRE WRAPPING POSTS AND A SNUG FIT FOR YOUR PERIPHERAL CARDS. COME AND GET 'EM...

**new part,
old price!**

21021 1K RAM

\$1.95

SAME AS 2102 TYPE RAMS, BUT FULL COMMERCIAL TEMP RANGE (0-55°C), LOWER POWER (17 MA TYPICALLY), AND FASTER (450 NS WORST CASE GUARANTEED). A SUPER 2102.

150,000 μ f

at 10 V!

\$5.95

+2 LBS SHIPPING

LISTS FOR OVER \$14!

WE HAVE A LIMITED SUPPLY OF SPRAGUE POWERLYTIC CAPACITORS. DESPITE THE HUGE AMOUNT OF CAPACITANCE, SIZE IS ONLY 3 1/16 BY 4 3/16. IF YOU HAVE A MICROCOMPUTER WITH A FARAD DEFICIENCY, THIS IS THE TONIC...OR BUILD A BEEFY POWER SUPPLY AROUND IT.



SPECIAL:

TINY ROTARY SWITCHES

TINY ROTARY SWITCH. 1 POLE, 7 POSITION PLUS OFF. DANDY FOR PROGRAMMING OR MINIATURE ELECTRONIC PROJECTS.

6/\$3



**LOW PROFILE,
LOW COST SOCKETS**

16 PIN LOW PROFILE SOCKET, SOLDERTAIL, TIN PLATED: 10 FOR \$2.00

14 PIN LOW PROFILE SOCKET, SOLDERTAIL, TIN PLATED: 11 FOR \$2.00

LIMITED QUANTITIES ON BOTH

"HOW CAN I PLAY WITH MICRO-COMPUTER ICs WITHOUT BREAKING MY BUDGET?"

8008 CHIP SET: 1-8008, 8-2102s, 1-5203 EROM.

\$29.98

\$24.50

+2 lbs postage

**VECTOR'S
"SLIT-N-WRAP"**

This tool is a manual wrapping device, which supplies insulated wire from a spool directly to wrap posts without external prestripping or precutting. More than one level of wrap is rarely required. Speed your breadboarding time tremendously with this tool, and don't bother stocking all that pre-stripped and precut wire you would normally have to have.

+2 lbs **HOBBY WRAP TOOL**

\$41.95

Want the convenience of a power wrapper? Try our Hobbywrap tool. You get the tool, nicads, bit, charger, and instructions. Why solder? Save time and effort.

**Play with wire?
Request our flyer!**

If you're an experimenter looking for some state-of-the-art parts...a computer enthusiast requiring peripherals for your micro-computer system...a tinkerer looking for time-saving tools and gadgets...an audiophile who likes to play around with sound...a ham who needs a digital clock, or a memory board...a CBer who needs a home supply for his mobile rig...or even a mad scientist, you'll find something to tickle your fancy in our flyer.

If you don't have one, ask for one.

TERMS: Californians add tax. You may place BankAmericard® and Mastercharge® orders via our 24 hour answering service (415-357-7007). No CODs, the paperwork is too much. When weight is indicated, please add sufficient postage-excess refunded.

Please note that some items are limited quantity. First come, first served. Thanks for your patronage!

Orders under \$10 please add 50¢ service charge.

GODBOUT

BILL GODBOUT ELECTRONICS
BOX 2355, OAKLAND AIRPORT, CA 94614

should not be done by reading from the script unless the person is a professional actor or announcer. A clear, distinct cue signal, described at the very beginning of the tape, must also be provided. It takes a lot of work to put together a good tape slide program, but the results can be well worth it. They provide direct access to top notch information, especially for those groups in remote locations.

This is one way that the manufacturers might be able to make a name for themselves. Even if a program were purely promotional, it still would be interesting to meet the people at the plant, see their facilities, and to watch their products in action. Of course, it would be even better if they would go into the unique features and application possibilities.

As an example of such materials in a specialized field, the National Model Railroad Association has over 30 such programs available to its members for a deposit and return postage (educational material rate). The waiting list is months long.

Tours

With a little imagination, some pleading and cajoling, and a bit of persistence, you may be able to come up with some fascinating tours. Many of your group may never have seen a big computer installation. If they have, then they probably haven't seen a manufacturing operation. Or how about an automated security system? It does not matter if there are no electronics manufacturers around; there undoubtedly will be many applications nearby. Then there are the potential applications . . . quarries, turkey farms, mushroom growers, etc.

But don't forget your own members. Maybe some of them would be willing to show how they have things set up at home. Devise a way to get reasonably small groups around to several homes, making sure that only those who are wanted stay on until the wee hours of the night.

Swap Shops and Auctions

Auctions are a lot of fun. If you are having a two-day affair, schedule one for around 10 in the evening. It may last until 2 AM, but everyone has a lot of fun — except, perhaps, for the auctioneer. It usually takes a crew of people to put on a reasonable size auction. They need to be adequately prepared with a good set of forms, display tables, and enough space.

The usual type of swap session, along the lines of an amateur radio "hamfest" is well known, where everyone selling gets some table space and makes his own deals. While

auctions can easily collect a percentage of the sale price (often 10%), swap sessions are more easily handled by the host organizations collecting a fixed entrance fee from sellers, buyers, and lookers.

As a service to its members, there could be a swap session bulletin board at every meeting. Just bring a cork board, a bunch of 3 X 5 cards, and some thumb tacks. Even if the program scheduled flops, you might still pick up a bargain.

Mixer Sessions

If your club is small, everyone will soon get to know what each other's interests are; but once it gets over 30 or so people, this will no longer be true. There will be the devoted core who are doing most of the work organizing these programs and doing all the other things that need to be done. If you are one of them and think you know everyone's interests, you will probably discover that there are a lot of people showing up who don't know. At this point it is time for a mixer session.

Try putting signs up on the walls with words indicating topics for discussion. These might be the names of manufacturers, types of equipment, programming projects, etc. At this point a bit of the summer camp counselor is needed to get the people to assemble in these areas and to discuss the topic. Of course, it would be wise to have a few people designated to cover each one and to handle the initial introductions.

Once when I attended a regional model railroad convention, I wanted to find all the people I could who were interested in applying electronics to that hobby. I hung a piece of cardboard on my back with a few key words in large letters, met several interesting people, and was given the names of several others not at the convention. When a speaker has to cancel out at the last minute, you might try that idea. Hang a sign on everyone's back as they come in the door. I bet it will be one of your top-rated meetings.

Contests

Contests in many special interest and hobby groups often seem to wind up taking on a life of their own, leaving most of the membership out. Most contests can be won by the liberal application of not just skill and time, but also money. They certainly can provide an incentive to improve designs and techniques. A major problem is to determine what the goals of the contest are to be. It seems to me that for a bunch of enthusiasts, they should be to encourage participation and to have fun. They

A Summary of Meeting Activities

Lectures
Clinics
Demonstration ("Hall") clinics
Participation clinics
Do it Yourself clinics
Show and Tell sessions
Tape slide programs
Workshops
Panel discussions
Tours
Swap shops
Auctions
Mixer sessions
Contests
Business meetings

shouldn't get out of hand in terms of skill or money demands. When this happens, they just become spectator events. In my opinion, the major goal of contests should be to encourage active participation. We have enough TV watchers now; let's apply our imaginations and have more keyboard button punchers and TVT watchers!

Business Meetings

We hate them, but we can't seem to get along without them. Every organization has to have business meetings. Unfortunately, the kind of people who enjoy business meetings tend to be the ones who run them. Certainly there is little reason why a computer hobbyists group has to have a business meeting involving everyone as a part of every meeting. The amount of time spent on business meetings should be minimal!

The work of the organization should be done outside the whole group sessions by a steering committee. Undoubtedly, you will wind up electing officers (although the Chicago Area Computer Hobbyists Exchange operated for more than a year without any). The really important thing is for all to know who is making what kind of decisions or taking what type of actions. You can have officers and still be very confused about this. The titles don't make the difference. Sometimes they just seem to attract people who like titles for the sake of having the titles.

However, it is vital that procedures be maintained so that actions by the few can be overruled by the whole body, or a clique thrown out, when necessary. *You* are never close minded, secretive, or not doing things in the best interests of the organization, of course. But you can only prove this by making it easy for others to do things differently than what you think is best. Make it easy, and they will probably go along with you.

Do not overorganize! There is very little that needs to be "business like" about a hobby organization. It is not a business. People come voluntarily. They come to learn, for relaxation, for fun. The avocation is computers. It is not setting up committees for everything, or writing rules, regulations, and procedures inappropriate for an organization of volunteers.

Do set up committees, but only as needed to ensure that things get done, or to keep the organizational types out of everyone else's hair.

Keep the business meetings short and to the point. Provide a variety of types of programs. Don't be afraid to experiment. Provide choice and change. You'll have a great club. ■



Creative Computing Magazine

A bi-monthly 88-page magazine for students, hobbyists, and anyone curious about computers. Fiction, articles, humor about computers, cybernetics, careers, building info., etc. Emphasis on games, puzzles, and projects. Contemporary, non-technical approach. Subscription: £5.00 (UK), \$8.00 (USA), \$10.00 (Other).

Games & Puzzles Issue of Creative Computing

88 pages of games and puzzles for pocket calculators, computers, and humans. "Beating the Game," "Computer Chess," "Hunting a Wumpus in a Cave," building your own computer, reviews of 24 games, books, and much more! £1.00 (UK), \$1.50 (USA), \$2.00 (Other).

Futures Issue of Creative Computing

Artificial Intelligence (Bertram Raphael, Herbert Dryfus, etc.), Extraterrestrial Intelligence (Isaac Asimov, Martin Harwit, etc.), microprocessors, videodiscs as an ultimate computer input device, 4 new games, and more. 88 big pages! £1.00 (UK), \$1.50 (USA), \$2.00 (Other).

Artist and Computer

A high-quality, 4-color book edited by Ruth Leavitt which displays the work of 35 internationally-known computer artists. Each artist describes his or her work in non-technical terms. 16 illustrations. £3.35 (UK), \$5.70 (USA), \$6.70 (Other).

101 BASIC Computer Games

A collection of 101 games in BASIC, each one with a complete listing, sample run, and write-up. Over 30,000 copies sold. 248 pages. £4.75 (UK), \$8.25 (USA), \$9.25 (Other).

The Best of Creative Computing

A 328-page book featuring stories by Isaac Asimov and others; articles on cybernetics, robots, computer crime, privacy; computer games such as Star Trek, Rabbit Chase, Magic Square, Madlib, and 14 more; super computer graphics; cartoons; reviews; poetry; and more! £5.50 (UK), \$9.70 (USA), \$10.70 (Other).

Creative Computing T-Shirt

Albert Einstein portrait produced by Blocpix™ process. Scarlet trim, black design. Available in adult sizes: S, M, L, XL. £2.50 (UK), \$4.00 (USA), \$5.00 (Other).

Star Trek People Computer Images

Six 8½x11 computer images on heavy stock of Kirk, Spock, McCoy, Scott, Chekov, and T'Pol. £1.00 (UK), \$1.50 (USA), \$2.00 (Other).

Mr. Spock Computer Image

Big 17x22" computer scanner image. Heavy stock. Comes in strong mailing tube. £1.00 (UK), \$1.50 (USA), \$2.00 (Other).

Orders in the UK

Creative Computing
60 Porchester Road
Southampton SO2 7JD, England

Orders in the USA and elsewhere:

Creative Computing
P.O. Box 789-M
Morristown, N.J. 07960, U.S.A.

What's New?

The following item is adapted from a press release provided by A P Products, Box 110, 72 Corwin Dr, Painesville OH 44077. It is printed here for its value as background information on the use of solderless prototyping jigs to try out experimental circuits on a temporary basis.

Solderless Breadboards

What is a solderless breadboard? How does it work? What advantages does it offer? Where can it be used? And how?

Before the invention of modern solderless breadboards, designing and testing any given electronic circuit was an aggravating,

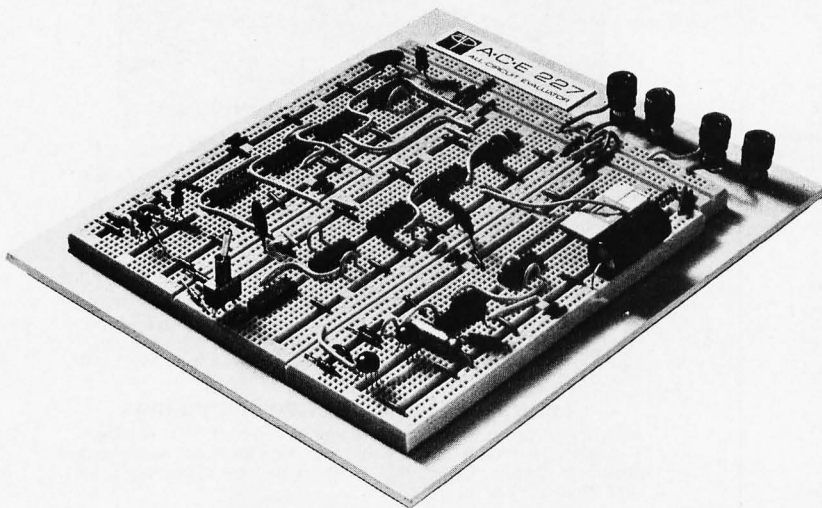

tedious, and time consuming task. First a circuit would have to be designed on paper. Then the schematic diagram of the circuit would have to be translated into a circuit board parts layout for either point to point or printed circuit wiring. If a printed circuit were to be used, as was most often the case, the circuit layout would have to be transferred to a copper-clad board, the copper selectively etched, holes drilled, and components soldered in place. Then, if a component proved the wrong value, it would have to be desoldered and a new one

BYTE'S BUGS

On page 68 of the August issue, there is a typographical error in the box "A Note About Construction." The Motorola part number referenced at two places in the box should be "MCM6571L" not "MCM6517L" as printed. ■

soldered in place. If the printed pattern were in error, a whole new board would have to be designed, etched, drilled, filled and soldered.

When A P Products came up with the idea of arranging a breadboard with a matrix of interconnected holes, the process was simplified. The interconnections are made by conductive spring clips that grip each component lead firmly to establish a good electrical connection without soldering. The matrix of holes was placed on a tenth inch (.254 cm) spacing pattern to conform with standard component lead spacing.

The interconnection pattern was designed to provide ample access to each lead of each component, especially with modern transistor and integrated circuitry in mind. And distribution strips were designed to provide power and signal lines where needed.

Circuit design testing now becomes a matter of plugging in components and wires. Integrated circuits and discrete components plug into the solderless breadboard and ordinary 22 gauge solid wire jumpers are used to interconnect them.

A given circuit can now be prototyped in minutes rather than hours or days. Many designers work directly with component specification sheets, many with schematic diagrams. Changes in parts values are as easy as pulling out one part and plugging in another. And the geometry of the modern solderless breadboard translates into a printed circuit layout readily once the circuit is ready to commit to hardware.

In addition, solderless breadboards can serve as a basis for semipermanent circuits in applications where the need for a given circuit requires reliability but does not require longevity.

Applications for modern solderless breadboards are as wide as all of electronics. There are professional applications in machine control, data processing, test and measurement, device testing, prototyping and equipment adjunctive aids. There are hobby applications ranging from communications to photography to automobiles to biofeedback to music to model railroading and more. And, of course, solderless breadboards are perfect for educational and instructional applications.

Solderless breadboards and breadboarding aids come in many sizes and prices, and have been used in designs as simple as a logic probe or as complicated as a small computer.

A P Products has available a free catalog of their ACE All Circuit Evaluator solderless breadboards, Super Strips™, terminal and distribution strips, integrated circuit test clips and accessories. ■

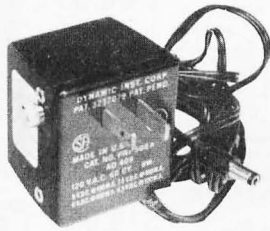

UNIVERSAL POWER SUPPLY

A unique plug-in supply by Panasonic. Useful for calculators, small radios, charging many & various small NiCad batteries. Adjustment screw plug on the side changes output voltage to 4½, 6, 7½, or 9 volts DC at 100 MA. Output cord with plug, 6 ft long.

No. SP-143C \$4.50 3/\$12

POWER SUPPLY

LAMBDA 5VDC 74 AMP

LV-EE-5-OV \$125.00

NJE 5/OUP-D5

5 VDC 32 AMP \$75.00

CLOCK KIT \$14.00

Includes all parts with MM5316 chip, etched & drilled PC board, transformer, everything except case.

SP-284 \$14.00 each 2/\$25.00

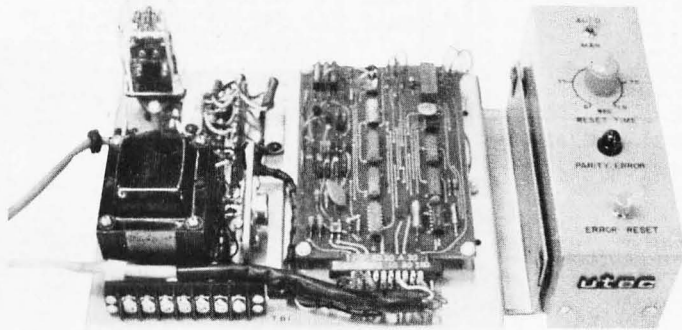

PARITY DETECTOR

New packaged, made for RCA, detects even or odd parity, baud rate 110, 150 or 134.46. Built-in logic supply for the IC's, operates from standard 115 vac. Control panel allows manual or automatic reset mode of operation. Aluminum enclosure (not shown), covers the electronics. TTY compatible.

Ship wgt. 10 lbs. \$16.50

COMPUTER DISPLAY TUBE

New Sylvania 9 inch CRT, 85 degree deflection, with tinted faceplate. Same as used in Viatron systems (buy a spare). With complete specs.

Ship wgt. 5 lbs. \$15.00

LINEAR by RCA, brand new, gold bond process

| | | | | | |
|------|--------|-----------|--------|--------|--------|
| 301 | \$.60 | 747 | \$.82 | MM5314 | \$3.00 |
| 307 | .52 | 748 | .50 | MM5316 | 3.00 |
| 324 | 1.80 | 1458 | .96 | 7001 | 8.00 |
| 339A | 1.60 | 3401 | .80 | | |
| 741 | .50 | 555 timer | .60 | | |

MEMORY SYSTEM \$125.00

New memory system by Honeywell, small ... measures only 9x4x1 inches. 1024 core memory, 1024 words with 8,9,10 bits/word. Random access, with all logic, register, timing, control, core select and sense functions in one package. New, booklet of schematics and data. Looks like a good beginning for a mini-computer. Limited supply on hand.

Ship wgt 3 lbs. #SP-79 \$125.00

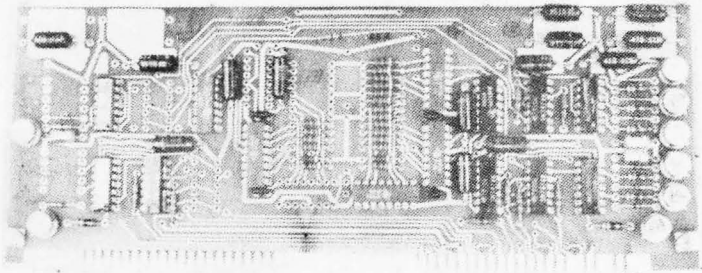

DATA ENTRY AUDIO TERMINAL

Sends and receives hard copy or audio of touch tone data sent & received. Output 600 ohms for phone lines. ITT touch phone pad with oscillators. Hard copy by strip printer 5 characters per inch, 35 digits visually displayed at once. Prints & receives touch tone codes, digits only. Power supply etc. all in the one case. With two units you can send and receive with monitoring of visual & audio tone at both stations.

Original cost \$1065 Ship wgt. 25 lbs. \$49.00 each



Please add shipping cost on above.

PHONE 617-595-2275 FREE CATALOG SP-8 NOW READY
MESHNA PO Bx 62 E. Lynn Mass. 01904

Meshna

CRYSTALS

THESE FREQUENCIES ONLY

| Part # | Frequency | Case/Style | Price |
|--------|--------------|------------|--------|
| CY1A | 1.000 MHz | HC33/U | \$5.95 |
| CY2A | 2.000 MHz | HC33/U | \$5.95 |
| CY3A | 4.000 MHz | HC18/U | \$4.95 |
| CY7A | 5.000 MHz | HC18/U | \$4.95 |
| CY12A | 10.000 MHz | HC18/U | \$4.95 |
| CY14A | 14.31818 MHz | HC18/U | \$4.95 |
| CY19A | 18.000 MHz | HC18/U | \$4.95 |
| CY22A | 20.000 MHz | HC18/U | \$4.95 |
| CY30B | 32.000 MHz | HC18/U | \$4.95 |

CLOCK CHIPS — CALCULATOR CHIPS

| | | |
|--------|---|--------|
| MM5309 | 6 Digit, BCD Outputs, Reset PIN | \$5.95 |
| MM5311 | 6 Digit, BCD Outputs, 12 or 24 Hour | 4.95 |
| MM5312 | 4 Digit, BCD Outputs, 1 PPS Output | 4.95 |
| MM5314 | 6 Digit, 12 or 24 Hour, 50 or 60 Hz | 4.95 |
| MM5316 | 4 Digit, Alarm, 1 PPS Output | 6.95 |
| MM5318 | Video Clock Chip, For Use With MM5841 | 9.95 |
| CT7001 | 6 Digit, Calendar, Alarm, 12 or 24 Hour | 6.95 |

CALCULATOR CHIPS

| | | |
|--------|---------------------------------------|--------|
| MM5725 | 6 Digit, Four Function, Less Decimal | \$2.95 |
| MM5738 | 8 Digit, 5 Function; +, =, x, ÷, % | 2.95 |
| MM5739 | 8 Digit, 4 Function, Floating Decimal | 2.95 |
| CT5300 | 12 Digit, 4 Function and % | 7.95 |

MISC. MOS

| | | |
|-------------|--------------------------------------|---------|
| MM5320 | TV Camera Sync. Generator | \$19.95 |
| MM5330 | 4 1/2 Digit DVM Chip | 9.95 |
| MM5369 | 60 Hz Timebase Circuit From 3.58 MHz | 3.95 |
| MM5841 | Video Generator for MM5318 | 18.00 |
| MC1408-17 | 7 Bit Digital to Analog Converter | 9.95 |
| MK5007 | 4 Decade Counter with Latches | 10.95 |
| LD110/LD111 | 3 1/2 Digit DVM Chip Set | 25.00 |
| 95H90 | 100 MHz — 10 Counter For Prescalers | 13.95 |

THE NEW RCA CA3140 MOST USEFUL OP AMP SINCE THE 741 CA3140 vs. 741 at a glance

| Input Resistance R _i (MΩ) | CA3140T.S | CA741CT.S |
|--|-----------|-----------|
| R _i (MΩ) | 1,500,000 | 2 |
| Input Current I _b (pA) | 10 | 80,000 |
| Slew Rate, SR (closed loop) (V/μs) | 9 | 0.5 |
| Gain-Bandwidth Product, f _t (MHz) | 4.5 | 1.0 |

DIP SWITCH

These switches feature seven SPST slide switches in a molded dip. They are ideally suited for microprocessor applications.

| | |
|--|-----------------------------|
| REPLACEMENT WIRE — BOBBINS FOR WIRING PENCIL | |
| W36-3-A-Pkg. 3 | 250 ft. 36 AWG GREEN \$1.95 |
| W36-3-B-Pkg. 3 | 250 ft. 36 AWG RED \$1.95 |
| W36-3-C-Pkg. 3 | 250 ft. 36 AWG CLEAR \$1.95 |
| W36-3-D-Pkg. 3 | 250 ft. 36 AWG BLUE \$1.95 |

VECTOR WIRING PENCIL

Vector Wiring Pencil P173 consists of a hand held featherweight (under one ounce) tool which is used to guide and wrap insulated wire. Fed off a self-contained replaceable bobbin, onto component leads or terminals installed on pre-punched "P" pattern Vectorboards. Connections between the wrapped wire and component leads, pads or terminals are made by soldering. Complete with 250 Ft of red wire.

| | | | | | |
|-------------------------|---------------|------|-------|------|------|
| PHENOLIC | 64P44 062XXXP | 4.50 | 6.50 | 1.72 | 1.54 |
| EPDXY GLASS | 64P44 062 | 4.50 | 6.50 | 2.07 | 1.86 |
| | 64P44 062 | 4.50 | 6.50 | 2.56 | 2.31 |
| | 64P44 062 | 4.50 | 17.00 | 5.04 | 4.53 |
| EPDXY GLASS COPPER CLAD | 64P44 062C1 | 4.50 | 17.00 | 9.23 | 8.26 |
| | 64P44 062C2 | 4.50 | 17.00 | 6.80 | 6.12 |

1/16 VECTOR BOARD

| Series | Part No. | Finish | Post Size | 25 pcs | 50 pcs |
|--------|----------|-----------|-----------|----------|--------|
| T42 | T44-1 | T44 | 025 sq | 1.50 | 1.00 |
| T46 | T46-1 | T46 | 028 sq | 1.75 | 1.25 |
| T49 | T49A | T49 | 025 sq | 1.75 | 1.25 |
| F21 | PKG. 100 | Terminals | \$3.50 C | \$13.00M | |

VECTOR TERMINALS

| | |
|-------------------|-------------|
| Nibbling Tool | \$6.95 |
| Replacement Punch | \$3.75 Each |
| Diagonal Cutter | \$8.50 ea. |

NIBBLING TOOL DIAGONAL CUTTER

This nibbling tool is perfect for cutting, trimming or notching sheet metal up to 16 gauge. It operates like a pair of shears and will cut through aluminum or brass up to 1/16 inch. We have the tool that can do a job that other tools can't. It's the only tool that can cut through sheet metal, printed circuit boards and prototyping material.

64 KEY KEYBOARD

This keyboard features 64 unenclosed SPST keys, unattached to any kind of P.C.B. A very solid molded plastic 12" x 4" base suits most applications.

JOYSTICK

These joysticks feature four 100K potentiometers, that vary resistance proportional to the angle of the stick. Sturdy metal construction with plastics components only at the movable joint. Perfect for electronic games and instrumentation.

MICROPROCESSOR COMPONENTS

8080 SUPPORT DEVICES

| | | | | |
|-------|------|---|---------|---------|
| 8080A | 8212 | 8 BIT INPUT/OUTPUT PORT FOR 8080 | \$ 5.95 | 8080 |
| | 8216 | NON INTERRUPT BI-DIRECTIONAL BUS DRIVER | 7.95 | \$24.95 |
| | 8224 | CLOCK GENERATOR AND DRIVER FOR 8080 | 12.95 | |
| | 8228 | SYSTEM CONTROLLER AND BUS DRIVER FOR 8080 | 12.95 | |

| CPU'S | | RAM'S | | | |
|---------|--------------|---------|--------|----------|---------|
| 8008 | 8 Bit CPU | \$19.95 | 1101 | 256 x 1 | \$ 2.25 |
| 8080 | Super 8008 | 24.95 | 1103 | 102 x 1 | 2.95 |
| 8080A | Super 8008 | 34.95 | 2101 | 256 x 1 | 6.95 |
| | SR'S | | 2102 | 1024 x 1 | 1.95 |
| 2504 | 1024 Dynamic | \$ 9.00 | 2107 | 4096 x 1 | DYNAMIC |
| 2516 | Hex 32 BIT | 7.00 | 2111 | 256 x 4 | 7.95 |
| 2519 | Hex 40 BIT | 4.00 | 7010 | 1024 x 1 | 29.95 |
| 2524 | 512 Dynamic | 2.95 | 7489 | 16 x 4 | 2.49 |
| 2525 | 1024 Dynamic | 3.00 | 8101 | 256 x 4 | Static |
| 2527 | Dual 256 BIT | 6.95 | 8111 | 256 x 4 | Static |
| 2529 | Dual 512 BIT | 4.00 | 8509 | 16 x 4 | Static |
| 2532 | Quad 80 BIT | 3.95 | 91102 | 1024 x 1 | Static |
| 2533 | 1024 Static | 1.95 | 74200 | 256 x 1 | Static |
| 3341 | Fifo | 6.95 | 93410 | 256 x 1 | Static |
| 74LS670 | 16 x 4 Reg | 3.95 | MM5262 | 2K x 1 | .99 |

BIPOLAR PROM SPECIAL

| | | |
|----------------|--|--------|
| 6300-1 (70 NS) | 256 x 4 OPEN COLLECTOR BIPOLAR PROM (EQUIVALENT TO 82S126) | \$2.95 |
| 6301-1 (70 NS) | 256 x 4 TRI STATE BIPOLAR PROM (EQUIVALENT TO 82S129) | \$2.95 |

Special Requested Items

| | | | | | | | | |
|-----------|--------------------|---------|---------|---------|----------|---------|--------|---------|
| RC4194 | Dual Track V Reg | \$ 5.95 | N8197 | \$ 2.00 | MK5007 | \$10.95 | MC4044 | \$ 4.50 |
| RC4195 | ±15V Track Reg | 3.25 | 4024P | 2.25 | 8263 | 5.95 | LM3909 | 1.25 |
| F9368 | Decoder | 3.95 | DM8130 | 3.25 | 8267 | 2.75 | MM5320 | 19.95 |
| LD110/111 | D/A Chip Set | 25.00 | CA3250 | \$2.50 | 8268 | 1.15 | 4072AE | .45 |
| CA3130 | Super CMOS Op Amp | 1.39 | MC14016 | .56 | 8626 | 3.00 | 7422 | 1.50 |
| MC1408L7 | D/A | 9.95 | 2525 | 6.00 | 8880 | 8.00 | 7497 | 4.00 |
| F3341 | FIFO | 6.95 | 2527 | 3.95 | 4511AE | 2.50 | 74186 | 5.00 |
| MM5841 | Character Gen | 18.00 | CD4516 | 2.50 | XR4136 | 2.00 | 74279 | 9.90 |
| AY5-0100 | Push Button Dialer | 17.50 | MM5309 | \$ 5.95 | 4566AE | 3.00 | 82390 | 4.00 |
| CDP1802 | CPU Microprocessor | 39.95 | DM8131 | 4.00 | ICM 7205 | 29.95 | MCT-2E | 2.95 |

Continental Specialties

PROTO BOARD 203

breadboard Prototyping with 5 Volt, 1 AMP Regulated Power Supply Included!

Proto Board 100

Here's a low cost, big 100 Capacity breadboard kit with all the quality of all Socket and the rest of the Proto Board family. Complete down to the last nut, bolt and screw. Includes 2 0T-35S Sockets, 1 0T-35B Bus Strip, 7 5-way binding posts, 4 rubber feet screws, nuts, bolts, and easy assembly instructions.

THE MINI-BREADBOARD BUDGET KIT

Proto Board 101 Compact, Resistorless 10 x 14 pin DIP capacity, 2 1/2" x 4 1/2" x 4 1/2" wide \$29.95

Proto Board 102 Compact 12 x 14 pin DIP capacity, 7 1/2" x 4 1/2" x 4 1/2" wide \$39.95

DESIGN MATE 1

For the circuit designer who needs a component without solder. Resistorless, Transistor, Linear Digital IC's in TO-9 Packages, 3-pin 8-pin and 14-pin. Also, components fit directly into Sockets and Bus Strips, resistorless and easy. Plus, DESIGN MATE 1 is 10M Ω variable impedance power supply (up to 1500V at 600mA @ 100Hz). Now that's a design flexibility for you!

You can even monitor the DM-1's internal power supply or external circuits, thanks to the built-in 0-15V voltmeter. If you're an electronics DM-1 is a must for your laboratory. It comes to you completely wired, tested and ready to go for only \$54.95

LOGIC MONITOR

Simultaneously displays static and dynamic logic states of DTL, TTL, HTL or CMOS DIP IC's. Pocket size. \$84.95.

| OT Type | #holes | price |
|---------|-----------|-------|
| OT-595 | 590 | 12.50 |
| OT-598 | bus strip | 2.50 |
| OT-478 | 470 | 10.00 |
| OT-475 | bus strip | 2.25 |
| OT-355 | 350 | 8.50 |
| OT-358 | bus strip | 2.00 |
| OT-185 | 180 | 4.75 |
| OT-182 | 120 | 3.75 |
| OT-85 | 80 | 3.25 |
| OT-75 | 70 | 3.00 |

DIGITAL CLOCK KIT — 3 1/2 INCH DIGITS

This clock features big 3 1/2" high digits for viewing in offices, auditoriums, etc. Each digit is formed by 31 bright 0.2" LEDs. The clock operates from 117 VAC, has either 12 or 24 hr. operation. The 6 digit version is 27" x 3 1/2" x 1 1/2", and the 4 digit is 18" x 3 1/2" x 1 1/2". Kits come complete with all components, case and transformer. Specify 12 Or 24 Hr. When Ordering

| | |
|---------------------|---------------------------|
| 4 DIGIT KIT \$49.95 | 4 DIGIT ASSEMBLED \$59.95 |
| 6 DIGIT KIT \$69.95 | 6 DIGIT ASSEMBLED \$79.95 |

Satisfaction Guaranteed. \$5.00 Min. Order. U.S. Funds. California Residents — Add 6% Sales Tax — Data Sheets 25c each. Send a 13c Stamp (postage) for a FREE 1976 Catalog

JAMES
1021 HOWARD AVE., SAN CARLOS, CA. 94070
PHONE ORDERS — (415) 592-8097

5 FUNCTION ELECTRONIC CALCULATOR RADOFIN MODEL 8P

\$8.95

FEATURES:

- 8 Digit Display
- 5 Functions consists of addition, subtraction, multiplication, division, percentage; with constant on all functions, with full floating decimal point.
- Power source is 1 piece 9V DC Battery 006P, Jack for AC adapter
- Black superfine grained finish plastic cabinet

5 FUNCTION ELECTRONIC CALCULATOR WITH WALLET-NOTEBOOK AND POCKET CHECKBOOK RADOFIN MODEL 1710

\$19.95

FEATURES:

- 8 Digit Display
- 5 Functions consists of addition, subtraction, multiplication, division, percentage; with constant on all functions, with full floating decimal point.
- Power source is 6 AAA cells 9V DC
- Wallet & 2 tone lexon; cabinet is black plastic.

3 1/2 DIGIT DVM KIT

This 0-2 VDC .05 per cent digital voltmeter features the Motorola 3 1/2 digit DVM chip set. It has a .4" LED display and operates from a single +5V power supply. The unit is provided complete with an injection molded black plastic case complete with Bezel. An optional power supply is available which fits into the same case as the 0-2V DVM allowing 117 VAC operation.

A. 0-2V DVM with Case \$44.95

B. 5V Power Supply \$14.95

JE700 CLOCK

The JE700 is a low cost digital clock, but is a very high quality unit. The unit features a simulated walnut case with dimensions of 6" x 2 1/2" x 1 1/2". It utilizes a MAN72 high brightness readout, and the MM5314 clock chip.

\$17.95

Liquid Crystal Temperature Display

This clock makes an attractive addition to any desk. It has an extruded, black anodized aluminum case. It displays hours, minutes, and seconds with .11 inch displays, and comes complete with a liquid crystal thermometer. It operates off 115 VAC at 50 or 60 Hz.

\$24.95

KIT - ALL COMPONENTS & CASE \$34.95 WIRED & ASSEMBLED \$39.95

JE803 PROBE

The Logic Probe is a unit which is for the most part indispensable in trouble shooting logic families: TTL, DTL, RTL, CMOS. It uses the power it needs to operate directly off of the circuit under test, drawing a scant 10 mA max. It comes with a MAN73 readout to indicate any of the following states by these symbols: (H) - 1 (LOW) - 0 (PULSE) - P. The Probe can detect high frequency pulses to 45 MHz. It can be used at MOS levels or circuit damage will result.

\$9.95 Per Kit

T-L 5V 1A Supply

This is a standard TTL power supply using the well known LM309K regulator IC to provide a solid 1 AMP of current at 5 volts. We try to make things easy for you by providing everything you need in one package, including the hardware for only

\$9.95 Per Kit

exelar

This watch is manufactured by National Semiconductor. It provides 5 functions; hours, minutes, seconds, date, A.M. indicator dot. Accuracy is assured to 5 seconds per month by precision quartz crystal. If something should go wrong with the watch, repair is assured within 48 hours after it is received. Complete with steel black leather band.

ES4-YS 3 MICRON GOLD PLATE BEZEL \$29.95

DIGITAL ALARM CLOCK

This 4 digit Novus Alarm Clock is a very reliable and smartly styled unit. It provides such features as an alarm settable to any minute of the day, a 7 minute snooze alarm, a power failure indicator, and even an A.M., P.M. indicator.

\$17.95

Novus

NOT A KIT

FAIRCHILD

ANNOUNCES THE

FAIRCHILD**SOLID STATE TECHNOLOGY KIT**

- FOR THE EXPERIMENTER WITH TASTE FOR "STATE OF THE ART" PRODUCTS
- COMPLETE SPECIFICATIONS ARE PRINTED ON THE BACK OF EACH TECHNOLOGY KIT

FTK0020



CARD FRONT

FTK0020

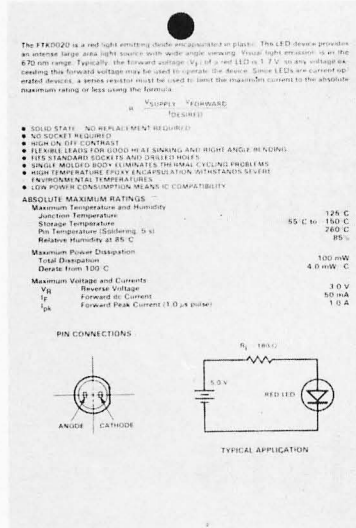

CARD BACK

FTK0011



CARD FRONT

DIGITS

| | | |
|---------|---------------------------------|--------|
| FTK0001 | 0.5" High Common Cathode Digit | \$1.00 |
| FTK0002 | 0.5" High Common Anode Digit | 1.00 |
| FTK0003 | .357" High Common Cathode Digit | .75 |
| FTK0004 | 0.8" High Common Cathode Digit | 2.00 |
| FTK0005 | 0.8" High Common Anode Digit | 2.00 |

0.8" HIGH DISPLAY ARRAYS

| | | |
|---------|---------------------------------|------|
| FTK0010 | 12 Hour, 3½ Digit Clock Display | 7.00 |
| FTK0011 | 24 Hour, 4 Digit Clock Display | 8.00 |

LED LAMPS

| | | |
|---------|-------------------------------------|------|
| FTK0020 | 10 Red LED Lamps | 1.00 |
| FTK0021 | 5 Mixed Colored LED Lamps | 1.00 |
| FTK0022 | 10 LED Mounting Clips | 1.00 |
| FTK0023 | 5 Three Piece LED Mounting Adapters | 1.00 |

PHOTO TRANSISTORS

| | | |
|---------|--------------------------------|------|
| FTK0030 | 5 Flat Lens Photo Transistors | 1.00 |
| FTK0031 | 5 Round Lens Photo Transistors | 1.00 |
| FTK0032 | 3 Flat Lens Photo Darlington | 1.00 |
| FTK0033 | 3 Round Lens Photo Darlington | 1.00 |

- THESE PRODUCTS ARE PACKAGED FOR OUTSTANDING WALL DISPLAY APPEARANCE

- FULL **FAIRCHILD** PRODUCT LINE TO FOLLOW

PHOTO ARRAYS

| | | |
|---------|------------------------------|-------|
| FTK0040 | 9-Element Tape Reader Array | 16.00 |
| FTK0041 | 12-Element Card Reader Array | 24.00 |
| FTK0042 | Reflective Opto Coupler | 4.00 |

COUPLERS

| | | |
|---------|---------------------------------|------|
| FTK0050 | 3 General Purpose Opto Couplers | 1.00 |
| FTK0051 | Darlington Opto Coupler | 1.00 |

MOS CLOCK CIRCUITS

| | | |
|---------|--|------|
| FTK0400 | Digital Clock/Calendar Circuit (FCM7001) | 7.00 |
| FTK0401 | Digital Clock/Calendar with BCD Outputs (FCM7002) | 7.00 |
| FTK0402 | Direct Drive Digital Clock Circuit with AC Output (FCM3817A) | 5.00 |
| FTK0403 | Direct Drive Digital Clock Circuit with DC Output (FCM3817D) | 5.00 |
| FTK0405 | Direct Drive Digital Clock/Calendar Circuit (FCM7015) | 6.00 |

KITS

| | | |
|---------|----------------------|-------|
| FTK0106 | Automobile Clock Kit | 40.00 |
|---------|----------------------|-------|

- DEALER'S AND WHOLESALE'S INQUIRIES INVITED—PRICE LIST AVAILABLE.

- BUY WITH PRIDE THE PRODUCTS BUILT BY THE INDUSTRY'S LEADER — **FAIRCHILD**

Satisfaction Guaranteed. \$5.00 Min. Order. U.S. Funds.
California Residents — Add 6% Sales Tax
Send a 13c Stamp (postage) for a FREE 1976 Catalog.

JAMES

1021 HOWARD STREET
SAN CARLOS, CA 94070
PHONE ORDERS — (415) 592-8097

Clubs and Newsletters

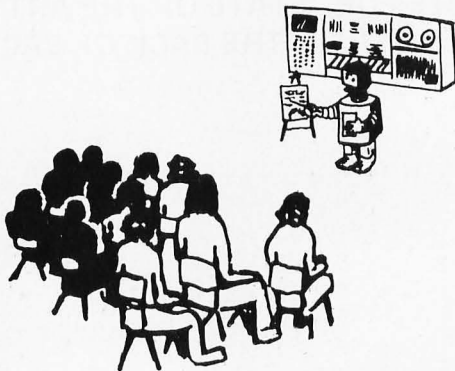

LICA of NY

In issue number 5 of STACK, the newsletter of the Long Island Computer Association, is a department heading "LICA, Where Goest Thou?", written by Albert L deGraffenried. It describes the double-barreled reward of exchange of information, and comradery, which is also found in other types of clubs, as well as hidden assets, such as the easy crossing of age and credentials boundaries. There are group benefits too, both given and received, and Al cites what radio hams have contributed to the community in times of disaster. This leads to what a computer club has: "group power" — the unique ability to solve *numerically* large problems which may have substantial social impact and perhaps dollar returns for the club.

Al may have hit upon a really good idea. Maybe your particular community has a need that your club or group could fill. This could be an area to explore. We'll be looking forward to seeing what progress LICA makes in this direction, in future issues.

Morris Balamut is editor of STACK, POB 864, Jamaica NY 11431.

AMRAD Computerfest

The Amateur Radio Research and Development Corp is sponsoring a Computerfest to be held on October 24 1976 at the Vienna Community Center, 120 Cherry St, Vienna VA, near Exit 11S of the Washington DC Beltway. The exposition will be almost entirely devoted to small computers of the type suitable for home use. There will be displays of microcomputer systems by various manufacturers' reps, as well as tables for used or surplus equipment, circuit boards and parts. Admission will be \$4 at the door, \$3.50 advance registration by mail. Make checks payable to AMRAD. Write: COMPUTERFEST, POB 682, McLean VA 22101.

AMRAD is a nonprofit club. The members for the most part have amateur radio licenses, although two thirds of their activities are now focused on microcomputer subjects.

Denver Amateur Computer Society — DACS

DACS has informed us of the appointment of Jim Clark as the new editor of the DACS newsletter. They would like to set up an exchange of newsletters with other clubs. Send your newsletters to Jim Clark, 538 So Swadley St, Denver CO 80228.

Tektronix 4051 Users Group

Vic Kley, POB 2117, Berkeley CA 94702, is an enthusiastic user of the Tektronix 4051 scientific computer. This is a machine which has a desk top package including keyboard and storage tube vector graphics display, as well as built-in mass storage and BASIC interpreter. Its internal architecture is that of a Motorola 6800, and it interfaces for scientific use to the IEEE 488 parallel bus standard (the Hewlett Packard instrumentation bus).

To date, there has been no organized user's group for this machine. Vic Kley would like to remedy that situation. Any persons interested in the concept of an independent 4051 users group should contact him at the above address.

CENOACA

Lee Lilly of the Central Oklahoma Amateur Computing Association issues a newsletter called *NEWSBITS* and offers to establish a regular exchange of newsletters with other clubs. Write: CENOACA, Box 2213, Norman OK 13069. Anyone interested in joining the club? They meet on the second Saturday of each month at 10 AM in the Oklahoma City Warr Acres

S. D. SALES CO.

P. O. BOX 28810 - B
DALLAS, TEXAS 75228

4K LOW POWER RAM BOARD KIT

THE WHOLE WORKS

Imsai and Altair 8080 plug in compatible. Uses low power static 21L02-1 500 ns. RAM's, which are included. Fully buffered, drastically reduced power consumption, on board regulated, all sockets and parts included. Premium quality plated thru PC Board.

\$89.95

8 Digit LED
"METRIC MASTER"

\$19.95

"RAPID MAN - 12"

\$29.95

\$1,000,000 CALCULATOR PURCHASE!

We bought the entire stock of a major manufacturer. New, guaranteed units.

Five functions PLUS complete Metric Conversion functions. Rechargeable batteries. Small, hand held size. With AC charger.

12 Digit - Desk Top Style. Sturdy design. With memory and four complete functions. Big, bright display.

ALARM CLOCK KIT SIX DIGIT LED

Thousands of hobbyists have bought and built our original clock kit and were completely satisfied. But we have received many requests for an alarm clock kit with the same value and quality that you have come to expect from S. D. So, here it is! THE KIT INCLUDES:

- 1 Mostek 50252 Alarm Clock Chip
- 6 Hewlett Packard .30 in. common cathode readouts
- 15 NPN Driver Transistors
- 2 Switches for time set
- 2 Slide Switches for alarm set and enable
- 1 Filter Cap
- 4 IN4002 Rectifiers
- 1 IN914 Diode
- 1 .01 Disc Cap
- 15 Resistors
- 1 Speaker for alarm
- 1 LED lamp for PM indicator

\$9.95

PCB - \$3.00
XFMR - \$1.50

60 HZ CRYSTAL TIME BASE - FOR DIGITAL CLOCKS

\$5.95

KIT FEATURES:

- A. 60 hz output with accuracy comparable to a digital watch
 - B. Directly interfaces with all MOS Clock chips
 - C. Super low power consumption (1.5 Ma typ.)
 - D. Uses latest MOS 17 stage divider IC
 - E. Eliminates forever the problem of AC line glitches
 - F. Perfect for cars, boats, campers, or even for portable clocks at ham field days. BUY TWO FOR \$10.00!
 - G. Small size, can be used in existing enclosures.
- KIT INCLUDES CRYSTAL, DIVIDER IC, PC BOARD PLUS ALL OTHER NECESSARY PARTS AND SPECS.

TTL INTEGRATED CIRCUITS

| | | | |
|-------------|------------|-------------|--------------|
| 7400 - 19c | 7430 - 19c | 7476 - 35c | 74153 - 75c |
| 7402 - 19c | 7432 - 34c | 7480 - 49c | 74154 - 1.00 |
| 74L04 - 29c | 7437 - 39c | 7483 - 95c | 74157 - 75c |
| 74504 - 44c | 7438 - 39c | 7485 - 95c | 74161 - 95c |
| 7404 - 19c | 7440 - 19c | 7586 - 45c | 74164 - 1.10 |
| 7406 - 29c | 7447 - 85c | 7490 - 65c | 74165 - 1.10 |
| 7408 - 19c | 7448 - 85c | 7495 - 75c | 74174 - 95c |
| 7410 - 19c | 7451 - 19c | 7498 - 75c | 74181 - 2.50 |
| 7411 - 29c | 7453 - 19c | 7498 - 89c | 74191 - 1.25 |
| 7413 - 50c | 7473 - 39c | 74121 - 38c | 74192 - 1.25 |
| 7420 - 19c | 7474 - 35c | 74123 - 65c | 74193 - 1.00 |
| | 7575 - 35c | 74141 - 75c | 74195 - 69c |

MOTOROLA RTL IC'S

Brand new, factory prime. Hard to find, but still used in a variety of projects. (See the RTL Cookbook by Howard W. Sams.)

| | | |
|--------------|--------------|---------------|
| MC724P - 59c | MC780P - 89c | MC791P - 69c |
| MC725P - 59c | MC785P - 49c | MC792P - 59c |
| MC764P - 49c | MC787P - 89c | MC799P - 89c |
| MC767P - 69c | MC788P - 49c | MC970P - 89c |
| MC771P - 49c | MC789P - 59c | MC9709P - 69c |
| MC775P - 89c | MC790P - 89c | MC9760P - 69c |

"CUBO" -DIGITAL ALARM CLOCK CUBE A PERFECT GIFT - NOT A KIT!

The CUBO Alarm Clock mfg. by Corvus, division of MOSTEK CORP. Originally sold for \$49.95. We bought out their entire inventory. All new, individually gift boxed. Mini size (2 1/2" cube) with maxi performance.

- FEATURES:
- A. 4 Digit H.P. Bright Display
 - B. "Second Hand" LED Activity Indicator
 - C. 24 Hour Alarm; 12 hour real time format
 - D. 10 Minute Snooze
 - E. Auto Display Dimming - Adjusts to Ambient Light
 - F. AM/PM Indicator
 - G. Power Failure Indicator
- Uses Famous Mostek MK50250 MOS LSI IC

\$14.95 EACH

(Add 75c P.&H.)

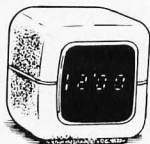

1000 MFD FILTER CAPS

Rated 35 WVDC. Upright style with P. C. leads. Most popular value for hobbyists. Compare at up to \$1.19 each from franchise type electronic parts stores.

S.D. SPECIAL 4 for \$1.



SLIDE SWITCH ASSORTMENT

Our best seller. Includes miniature and standard sizes, single and multi-position units. All new, first quality, name brand. Try one package and you'll re-order more. SPECIAL - 12/\$1.



MOTOROLA POWER DARLINGTON

Back in Stock!

Like MJ3001. NPN 80V, 10A. HFE 6000 TYP. TO-3 case. We include a free 723 C volt reg. with schematic for power supply. SPECIAL - \$1.99

WESTERN DIGITAL UART

No. TR1602B. 40 pin DIP. This is a very powerful and popular part.

NEW - \$6.95 with data
LIMITED QUANTITY

FAIRCHILD BIG LED READOUTS

A big .50 inch easy to read character. Now available in either common anode or common cathode. Take your pick. Super low current drain, only 5 MA per segment typical.

YOUR CHOICE: 6 for \$7.50

FND - 510 Common Anode \$1.50 ea.
FND - 503 Common Cathode \$1.50 ea.

INTEL 1702A 2K ERASEABLE PROM'S

\$6.95

We tell it like it is. We could have said these were factory new, but here is the straight scoop. We bought a load of new computer gear that contained a quantity of 1702A's in sockets. We carefully removed the parts verified their quality, and are offering them on one heck of a deal. First come, first served. Satisfaction guaranteed.

BACK IN STOCK!

RESISTOR ASSORTMENT

1/4 W 5% and 10%. PC leads. A good mix of values. 200/\$2.



74S200

256 Bit High Speed RAM
Same as 82S16
\$3.95

1K PROM BACK IN STOCK!
82S129. 256X4. Bipolar, 50 NS.
FAST. WITH SPECS.

\$3.95

8T97B

Hex Tri-State Buffer. Back in stock.

\$1.25

UP YOUR COMPUTER!

21L02-1 1K LOW POWER 500 NS STATIC RAM
TIME IS OF THE ESSENCE

And so is power. Not only are our RAM's faster than a speeding bullet but they are now very low power. We are pleased to offer prime new 21L02 - 1 low power and super fast RAM's. Allows you to STRETCH your power supply farther and at the same time keep the wait light off.

8 FOR \$17.50

SALE ON CUT LEAD SEMICONDUCTORS

Leads were cut for PCB insertion. Still very useable. All new, unused. Some House no.

- 1N914/1n4148 100/\$2.
- 1N4002 1 Amp 100 PiV 40/\$1.
- 1N4745A 16V 1W Zener 20/\$1.
- EN2222 NPN Transistor 25/\$1.
- EN2907 PNP Transistor 25/\$1.
- 2N3904 NPN Driver Xstr 25/\$1.
- 2N3392 GE Pre-amp Xstr 25/\$1.
- C103Y SCR. 800MA 60V 10/\$1.

C&K MINI TOGGLE SWITCH

No. 7103 SUB MINI SPDT Center OFF.
SPECIAL - 99c

TERMS:

Money Back Guarantee. No COD. Texas Residents add 5% tax. Add 5% of order for postage and handling. Orders under \$10. add 75c. Foreign orders: US Funds ONLY!

CALL YOUR BANK AMERICARD OR MASTER CHARGE ORDER IN ON OUR CONTINENTAL UNITED STATES TOLL FREE WATTS: 1-800-527-3460

Texas Residents Call Collect
214/271-0022

S. D. SALES
P. O. Box 28810 - B
Dallas, Texas 75228

ORDERS OVER \$15. CHOOSE \$1. FREE MERCHANDISE

Branch Library at NW 63rd and MacArthur, Oklahoma City.

Atlanta Bootstrap Volume

Jim Stratigos of the Atlanta Area Micro-computer Hobbyist Club (AAMHC) has sent us the first issue of their newsletter. In an editorial they say that they will try to print items of interest such as software and hardware articles, tutorial or instruction columns, meeting notices and minutes, club activities, and hope to include a swap/buy/sell column in the near future. Anyone wishing more information concerning the club should write: Jim Stratigos, Editor, Box 33140, Atlanta GA 30332.

VCCS — Change of Address

The Ventura County Computer Society has a new address: The VCCS, POB 525, Port Hueneme CA 93041. The society meets at the Camarillo Library, Ponderosa Dr, Camarillo, the last Saturday of the month. Two exceptions are: in November, on the 20th, and in December on the 18th.

The Shift Register

Eric Rehnke, (216) 888-7531, of the Cleveland Digital Group sent along a copy of the June newsletter, volume 1:7. It included a biorhythm program, impressions of the MOS Technology KIM-1, and a number of language conversions. The CDG hopes to put out a small booklet on the differences between systems so users will not have problems converting from one basic to the next.

CACHE Register

In volume 1:5 of this Chicago area based club's newsletter, CACHE reports that they have 145 members. In attendance at the May meeting were Dr Suding of the Digital Group, as was the president, Dick Bemis. Besides showing Digital products, Dr Suding engaged CACHE members in a discussion of the hobbyist field, and of the new Z-80 from Zilog. Bill Precht continued his popular clinic on programming basics. They say that the response to this discussion was so good, the steering committee is planning a series of talks on the relative merit and drawbacks to the major chips. The club's mailing address is: POB 36, Vernon Hills IL 60061.

Personal Systems of San Diego

In the June issue of the San Diego Computer Society newsletter, a feedback sheet was included. These sheets were to be

mailed back, or turned in at the next meeting. It is linked to a column called "Interaction" by Ron Eade. The column surveys the results of the previous forms, or sheets. These sheets are numbered from 0-60. 1-9 are ways you may assist the club as a whole, ie:

"I will type articles for the newsletter,"
"I will volunteer. . . .,"
"I will help. . . .,"
"I will write. . . ."

10-45 deals with SIG (special interest groups). This is divided into four subgroups, hardware, chips and systems; hardware, systems support; software, and applications. The last section deals with regional organizations meetings, ie: Coast, East County, South County. By circling the appropriate numbers, you are informing the steering committee of your willingness to participate in club activities, and you will be informed as to when and where your SIG will meet. This is probably an excellent way to exchange information in large clubs. The club's mailing address is: POB 9988, San Diego CA 92109.

Homebrew Class

The Homebrew Computer Club's newsletter has a new face. According to Robert Reiling and Joel Miller, Laurel Publications will be donating typesetting services on their computerized typesetting/text editing system as well as providing graphics, layout and editorial services. This certainly increases the appeal and readability; looks good. Bob will continue as chief editor, and Tom Pittman is the man to write to regarding the mailing list. POB 626, Mountain View CA 94042.

Triangle of North Carolina

The Triangle Amateur Computer Club meets every fourth Sunday at 2 PM at the Dreyfus Auditorium, Research Triangle Institute, Research Triangle Park, NC. They are currently exploring a club interchange standard, have a monthly newsletter, and are starting software and hardware club projects. For more information on this Raleigh, Durham, Chapel Hill area club, contact: Russell Lyday Jr at (919) 787-4137 or write Triangle Amateur Computer Club, POB 17523, Raleigh NC 27609.

A Bit of Ham from Louisiana

Emil Alline (WA5WUJ) passed a note along informing us of the formation of the "Crescent City Computer Club." The address is now Box 1097, University of New Orleans, New Orleans LA 70122. They meet at 8 PM on the second Friday of every

A COMPLETE 1K RAM SYSTEM FOR ONLY \$459.00 IN KIT FORM \$709.00 ASSEMBLED & TESTED

With CPU card, buffered mother card, power supply as described below and cabinet. The VERAS System is developed around the popular F-8 Series of chips which in our estimation is the finest and most versatile Micro processor now available.

The VERAS System can be made into a 17K processor by merely adding four of our optional memory boards. The kit includes everything you need to build the VERAS F-8 Computer as described. All boards, connectors, switches, discrete components, power supply and cabinet are supplied. Programming manual, data book and simplified support documentation supplied. 8K Assembler and Editor (paper tape) available on request with minimum order of 8K RAM.

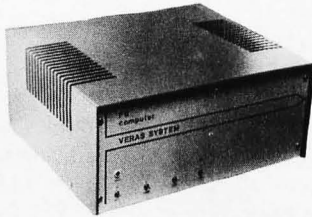

7" x 16" x 14-3/4"

OUR 4K STATIC RAM BOARD FEATURES: (OPTIONAL)

- Outputs buffered.
- On board decoding for any four of 64 pages.
- Address and data lines are fully buffered.
- 32 2102-1 static RAM's, 500 ns. or less, requiring no refreshing.
- No onboard regulators to cause heat problems. (Chassis mounted)
- 4K memory boards with connector, buffers and static RAM's are available in kit form for **\$149.00**

The fully buffered mother board will accept (4) 4K RAM boards for a total of 16K bytes of memory. Individual power terminals for each 4K RAM board are provided. Memory expansion beyond 16K bytes can be accomplished by the addition of more mother boards. Extra buffered mother boards with connector are available in kit form for **\$45.00**

Our modular power supply is designed around a high frequency toroid transformer which affords a large saving in size and weight, and keeps filtering to a minimum. It is rated at +5V at 10 amps and -5V and ±12V at 1 amp. This power supply will drive our CPU, four memory boards and some peripherals.

POWER SUPPLY KIT \$139.00

All boards are high quality G-10, double sided, solder plated with gold plated edge connector.

PACKAGING FEATURES ARE:

- A) Complete modular plug-in construction.
- B) Specifically designed rugged aluminum card rack with provisions for voltage regulators (TO-220 supplied) to keep heat off the boards.
- C) Designed for convection or optional forced cooling.
- D) All I/O ports brought out to the rear panel connectors for easy accessibility.
- E) Auxiliary DC power available at the rear panel to power peripherals.

Veras Systems is currently developing the following:

UV PROM board, DMI and DMA board, Cassette, modern, video board and more. All these boards will have innovative design, something you will come to expect from VERAS SYSTEMS.

Computer dealers and hobbyist club inquiries are invited.

Expected delivery time 30 days or less.

THE VERAS F8 COMPUTER

THE SYSTEM DESIGNED WITH THE USER IN MIND FOR BOTH COMMERCIAL & HOBBYIST USE

THE CPU BOARD FEATURES:

- Two I/O ports each on the CPU and ROM chip make 32 bidirectional TTI lines.
- The Fairbug* programmed storage unit provides the programmer with all I/O subroutines, allows the programmer to alter or display memory, and register its contents via teletype.
- Programmable internal timer is built into the ROM chip.
- Built in clock generator and power on reset are built into the CPU chip.
- There is a local interrupt with automatic address vector.
- It is expandable to 65K bytes of memory.
- 20 mil loop and/or RS232 interface included.
- 1K of on board 2102 RAM.
- Serial interface built into PSU chip.

The More Flexible and Expandible Computer at a Comparative Price.

VERAS SYSTEMS

Warranty: 90 days on parts and labor for assembled units. 90 days on parts for kits. Prices, specifications and delivery subject to change without notice.

*Fairbug is a registered trademark of Fairchild Corp.

VERAS SYSTEMS
A Div. of Solid State Sales, Inc.
Box 74B, Somerville, MA 02143
(617) 547-1461

Enclosed is check for \$ _____
or Master Charge # _____

VERAS F-8 Computer Kit Assembled
 4K Ram Board Quantity _____
 Power Supply Kit

Name _____
Address _____
City, State _____ Zip _____

| | |
|---|------------|
| INTEL 8080 CPU | \$29.50 |
| 2518-HEX 32 BIT SR | \$6.00 |
| 2102-1 1024 BT RAM | \$2.60 |
| 5280-4K DYNAMIC RAM | \$12.50 |
| 5202A UV PROM | \$12.50 |
| MM5203 UV PROM | \$12.50 |
| 1702A UV PROM | \$12.50 |
| 5204-4K PROM | \$24.95 |
| MINIATURE MULTI-TURN TRIM POTS 100, 500, 2K, 5K, 10K, 100K, 200K | \$7.5 ea. |
| 3/2 \$2.00 | |
| MULTI-TURN TRIM POTS Similar to Bourns 3010 style 3/16"x5/8"x1-1/4"; 50, 100, 1K, 10K, 50K ohms | \$1.50 ea. |
| 3/4 \$4.00 | |
| LIGHT ACTIVATED SCR'S TO-18, 200V 1A. | \$1.75 |
| TRANSISTOR SPECIALS | |
| 2N3585 NPN Si TO-66 | \$1.95 |
| 2N3772 NPN Si TO-3 | \$1.60 |
| 2N4908 PNP Si TO-3 | \$1.00 |
| 2N6055 NPN Si TO-3 Darlington | \$1.30 |
| 2N5086 PNP Si TO-92 | 4/5 \$1.00 |
| 2N4898 PNP TO-66 | \$1.60 |
| 2N4040 PNP GE TO-5 | 5/5 \$1.00 |
| 2N3919 NPN Si TO-3 RF | \$1.50 |
| MPSA 13 NPN Si TO-92 | 3/5 \$1.00 |
| 2N3767 NPN Si TO-66 | \$1.70 |
| 2N2222 NPN Si TO-18 | 5/5 \$1.00 |
| 2N3055 NPN Si TO-3 | \$1.80 |
| 2N3904 NPN Si TO-92 | 5/5 \$1.00 |
| 2N3906 PNP Si TO-92 | 5/5 \$1.00 |
| 2N5296 NPN Si TO-220 | \$1.50 |
| 2N6109 PNP Si TO-220 | \$1.55 |
| 2N3866 NPN Si TO-5 RF | \$1.75 |
| 2N3638 PNP Si TO-5 | 5/5 \$1.00 |
| 2N6517 NPN Si TO-92 | 3/5 \$1.00 |
| CIMOS (DIODE CLAMPED) | |
| 74C02 -25 4016- 50 4035- 1.75 | |
| 74C10 -25 4017- 1.30 4042- 1.60 | |
| 4001 -25 4018- 1.40 4047- 2.60 | |
| 4002 -25 4019- 1.60 4049- 2.60 | |
| 4006 -1.60 4022- 1.20 4050- 1.70 | |
| 4007 -25 4023- 25 4055- 1.20 | |
| 4009 -60 4024- 1.25 4056- 1.20 | |
| 4010 -60 4025- 25 4071- 30 | |
| 4011 -25 4027- 65 4077- 1.70 | |
| 4012 -25 4028- 1.50 4081- 25 | |
| 4013 -50 4029- 1.75 4076- 1.20 | |
| 4015 -1.40 4030- 90 | |
| LED READOUTS | |
| FND 500-5" C.C. | \$1.95 |
| HP 7740-3" C.C. | \$1.40 |
| MAN-7-3" C.A. | \$1.25 |
| NS 33-3 dig. array | \$1.35 |

| | |
|--|------------|
| PRINTED CIRCUIT BOARD | |
| 4-1/2" x 6-1/2" SINGLE SIDED EPOXY BOARD 1/16" thick, unetched | \$5.00 ea. |
| 5/5 \$2.20 | |
| VECTOR BOARD 1" SPACING 4.5" x 6" SHEET | \$1.25 |
| 4 WATT IR LASER DIODE \$7.95 | |
| 2N 3820 P FET | \$1.45 |
| 2N 5457 N FET | \$1.45 |
| 2N 4891 UJT | \$1.45 |
| TIS 43 UJT | \$1.35 |
| ER 900 TRIGGER DIODES | 4/5 \$1.00 |
| 2N6028 PROG. UJT | \$1.65 |
| VERIPAX PC BOARD | |
| This board is a 1/16" single sided paper epoxy board, 4 1/2" x 6 1/2" DRILL, LED and ETCHED which will hold up to 21 single 14 pin IC's or 8, 16, or LSI DIP IC's with busses for power supply connector. \$4.00 | |
| MV 5691 YELLOW-GREEN BIPOLAR LED | \$1.25 |
| MT-2 PHOTO TRANS | \$1.60 |
| RED, YELLOW, GREEN OR AMBER LARGE LED's | ea. \$1.20 |
| 14 PIN DIP SOCKETS | \$1.25 |
| 16 PIN DIP SOCKETS | \$1.28 |
| MOLEX PINS | 100/\$1.00 |
| 1000/\$8.00 | |
| 8 PIN MINI DIP SOCKETS | \$1.25 |
| 10 WATT ZENERS 3.9, 4.7, 5.6, 8.2, 12, 15, 18, 22, 100, 150 or 200V | ea. \$1.60 |
| 1 WATT ZENERS 4.7, 5.6, 10, 12, 15, 18 OR 22V | ea. \$1.25 |
| Silicon Power Rectifiers | |
| PRV. 1A, 3A, 12A, 50A 125A | |
| 100 .06 .14 .30 .80 3.70 | |
| 200 .07 .20 .35 1.15 4.25 | |
| 400 .09 .25 .50 1.40 6.50 | |
| 600 .11 .30 .70 1.80 8.50 | |
| 800 .15 .35 .90 2.30 10.50 | |
| 1000 .20 .45 1.10 2.75 12.50 | |
| SILICON SOLAR CELLS | |
| 2 1/4" diameter | |
| .5V at 500 ma. . . . \$5.00 ea., 6/\$27.50 | |
| REGULATED MODULAR POWER SUPPLIES | |
| + - 15 VDC AT 100ma | |
| 115VAC INPUT | \$27.95 |
| 5VDC AT 1A, 115VAC INPUT | \$24.95 |
| 12 VDC AT 5 AMP | \$24.95 |
| IN 4148 (IN914) | 15/\$1.00 |

| | |
|---|--------------------|
| TANTULUM CAPACITORS | |
| .22UF 35V 5/\$1.00 | 6.8UF 35V 3/\$1.00 |
| 47UF 35V 5/\$1.00 | 22UF 35V \$1.40 |
| 68UF 35V 5/\$1.00 | 33UF 35V \$1.40 |
| 1UF 35V 5/\$1.00 | 30UF 6V 5/\$1.00 |
| 3.3UF 35V 4/\$1.00 | 100UF 35V \$1.50 |
| 4.7UF 35V 4/\$1.00 | 150UF 15V \$1.40 |
| M7001 ALARM CLOCK CHIP. . . . \$6.00 | |
| NATIONAL MOS DEVICES | |
| MM1402 - 1.75 | MM5057 - 2.25 |
| MM1403 - 1.75 | MM5058 - 2.75 |
| MM1404 - 1.75 | MM5060 - 2.75 |
| MM5013 - 2.50 | MM5061 - 2.50 |
| MM5016 - 2.50 | MM5555 - 4.75 |
| MM5017 - 2.70 | MM5556 - 4.75 |
| MM5055 - 2.25 | MM5210 - 1.95 |
| MM5056 - 2.25 | |
| TTL IC SERIES | |
| 74L00 -25 7441 -85 74126 -60 | |
| 7400 -18 7442 -55 74150 -100 | |
| 7401 -18 7445 -75 74151 -80 | |
| 7402 -18 7446 -80 74153 -79 | |
| 7403 -27 7447 -69 74154 -105 | |
| 7404 -22 7448 -77 74155 -100 | |
| 7405 -22 7472 -40 74157 -75 | |
| 7406 -35 7473 -40 74161 -100 | |
| 7407 -33 7474 -40 74164 -105 | |
| 7408 -25 7475 -50 74165 -105 | |
| 7409 -25 7476 -40 74173 -95 | |
| 7410 -16 7480 -48 74174 -120 | |
| 7411 -25 7483 -80 74175 -95 | |
| 7412 -40 7485 -88 74180 -100 | |
| 7413 -45 7486 -45 74177 -100 | |
| 7414 -100 7489 -200 74181 -240 | |
| 7416 -33 7490 -48 74190 -115 | |
| 7417 -33 7491 -75 74191 -110 | |
| 7420 -18 7492 -49 74192 -80 | |
| 7425 -30 7493 -49 74194 -125 | |
| 7426 -35 7494 -80 74194 -90 | |
| 7427 -28 7495 -80 74195 -74 | |
| 7430 -16 7496 -73 74196 -110 | |
| 7432 -30 74107 -40 75324 -1.75 | |
| 7437 -30 74121 -39 75491 -60 | |
| 7438 -30 74123 -75 75492 -60 | |
| 7440 -18 74125 -60 | |
| MINIATURE DIP SWITCHES | |
| CTS-206-4 Four SPST switches in one minidip package. | \$1.50 |
| CTS-206-8 Eight SPST switches in a 16 pin DIP package. | \$2.55 |
| ALCO MINIATURE TOGGLE SWITCHES | |
| MTA 106 SPDT | \$1.20 |
| MTA 206 DPDT | \$1.70 |
| AY 5-1013-A30K ser./par., ser., universal UUART. | |
| | \$6.95 |

| | |
|---|----------|
| Full Wave Bridges | |
| PRV 2A 6A 25A | |
| 200 .95 1.25 2.00 | |
| 400 1.15 1.50 3.00 | |
| 600 1.35 1.75 4.00 | |
| SANKEN AUDIO POWER AMPS | |
| Si 1010 G 10 WATTS | \$1.60 |
| Si 1020 G 20 WATTS | \$1.95 |
| Si 1050 G 50 WATTS | \$24.95 |
| CCD 110 LINEAR 256 X1 BIT SELF SCANNING CHARGED COUPLED DEVICE \$99.00 | |
| CCD 201 100 x 100 CHARGE COUPLED DEVICE | \$135.00 |
| LINEAR CIRCUITS | |
| LM 309K 5V 1A REGULATOR | \$1.25 |
| 723 -40 +40V REGULATOR | \$1.50 |
| 301/748 Hi Per. Op. Amp. | \$1.31 |
| 320T 5, 12, 15, OR 24V NEGATIVE REG. | \$1.50 |
| 709C Op. Amp. | \$1.31 |
| 741A or 741C OP AMP. | \$1.31 |
| 710 COMPARATOR | \$1.35 |
| CA 3047 Hi Per. Op. Amp. | \$1.70 |
| 340T 5, 6, 8, 12, 15, 18, 24V POS REG. TO-220 | \$1.50 |
| 101 OPER. AMP. HI PERFORM. | \$1.75 |
| LM 308 Oper. Amp., Low Power | \$1.95 |
| 747 DUAL 741 | \$1.65 |
| 555 - DUAL TIMER | \$1.00 |
| 537 - PRECISION OP. AMP. | \$1.70 |
| LM 3900 - QUAD OP. AMP. | \$1.49 |
| LM 324 - QUAD 741 | \$1.50 |
| 560 - PHASE LOCK LOOP | \$2.00 |
| 561 - PHASE LOCK LOOP | \$2.00 |
| 565 - PHASE LOCK LOOP | \$1.25 |
| 566 FUNCTION GEN. | \$1.65 |
| 567 - TONE DECODER | \$1.70 |
| LM 1310M FM STEREO DEMOD. | \$2.75 |
| 8038 IC VOLTAGE CONTROL. OSC. | \$3.90 |
| LM 370 - AGC SQUELCH AMP. | \$1.15 |
| 555 - 2us - 2 HR. TIMER | \$1.45 |
| 553 QUAD TIMER | \$2.50 |
| ICD 810 OPTO ISOLATOR | \$1.90 |
| 1458 DUAL OP AMP. | \$1.60 |
| LM 380 - 2W AUDIO AMP. | \$1.95 |
| LM 377 - 2W Stereo Audio Amp. | \$2.50 |
| LM 381 - STEREO PREAMP. | \$1.50 |
| LM 382 - DUAL AUDIO PREAMP | \$1.50 |
| LM 311 - HI PER. COMPARATOR | \$1.90 |
| LM 319 - Dual Hi Speed Comp. | \$1.25 |
| LM 339 - QUAD COMPARATOR | \$1.50 |
| TRIACS SCR'S | |
| PRV 1A 10A 25A 1.5A 6A 35A | |
| 100 .40 .70 1.30 .40 .50 1.20 | |
| 200 .70 1.10 1.75 .60 .70 1.60 | |
| 400 1.10 1.60 2.60 1.00 1.20 2.20 | |
| 600 1.70 2.30 3.60 1.50 3.00 | |

Terms: FOB Cambridge, Mass. Send Check or Money Order. Include Postage. Minimum Order \$5.00, COD'S \$20.00



SOLID STATE SALES
P.O. BOX 74B
SOMERVILLE, MASS. 02143 TEL. (617) 547-4005

WE SHIP OVER 95% OF OUR ORDERS THE DAY WE RECEIVE THEM

month in Room 2120 of the science building of the University. He also notes that the FCC and ARRL are taking steps toward making it easier than ever before to become a ham and with more privileges than ever.

Chicago Area F-8 Users

If you live in the Chicago area, Louis Burgyan is interested in meeting other F-8 users. He may be reached at (312) 327-0472, evenings.

The Computer Network of Kansas City

The *KC Thru-Put* is the organ of this Kansas City group. President Earl Day writes a column called "Day Dreams," and Bart Schwartz is editor. The group first met in May with 12 members and as of the July issue, number 2, has increased to 37. At the June meeting the possibility of making an educational program for the local PBS (Public Broadcasting Station) channel was discussed, but was deferred until the club is more established. Anyone wishing to contact this organization may write: *KC Thru-Put*, 968 Kansas Av, Kansas City KS 66105.

Microcomputer Society of Florida

In the *Marsh Data Systems Newsletter* number 5, Don Marsh writes that the Microcomputer Society of Florida has chapters in Vero Beach, Ft Myers, Sarasota, Jacksonville, Gainesville, as well as Tampa. The society will soon be publishing a newsletter of its own. They suggest that their chapters consider getting a free write-up in the local papers. Computer groups are newsworthy. In Tampa they have had a write-up in each of the major papers, and have been on television twice.

For more information contact: Marsh Data Systems, 5405B Southern Comfort Blvd, Tampa FL 33614.

New York Amateur Computer Club

Elections of club officers have been held, but as of the June newsletter, the results were not yet complete. Club member David Ripps is scheduled to speak on the topic of "Systems Monitors and Their Features." The newsletter also included a report from the technical committee, an article by Alan Yorinks, "A Short Course in Digital Logic

Troubleshooting," and a humorous essay on the living room workshop by MCS III.

The address is: NYACC, c/o R Schwartz, 1E, 375 Riverside Dr, New York NY 10025.

ACGNJ News

In June at the general meeting, Marty Nichols, Tom Kirk, and Roger Amidon gave a presentation on the "String Language Processor." The high level language was running on 8080 based systems at the meeting. The demonstration was given with video monitors which were set up around the meeting room.

The bylaws were also printed, in this, the July volume 2:7 issue. A "Life for the M6800" reprint, and an article, "Interfacing the Original TV Typewriter to a Computer" by Monty Shulte, were included.

The address is: ACGNJ, UCTI, 1776 Raritan Rd, Scotch Plains NJ 07076.

Computer Hobbyist Group - North Texas

In volume 2:6 of the newsletter, they state that at the May meeting they were honored with the first look at three new products by the Southwest Technical Products Corp (SWTPC). Displayed at the meeting were a dual cassette controller/interface, a graphics controller for input to CRT, and a small but quick printer. TCHG-NT's address is: 2377 Dalworth 157, Grand Prairie TX 75050.

A Roving Computer Show for the Experimenter?

Well, not quite; but a firm called Marketing Ventures Inc, 5012 Herzel PI, Beltsville MD 20705, is organizing a show called TECHNIHOBBY USA which will be travelling to four cities in the US this fall. The boundaries defined for the show's content are not limited to computers alone, but encompass amateur radio, radio control models, do it yourself electronics, as well. The firm is looking for participation by local clubs in its exhibitions to be held:

| | |
|---------------|------------------------|
| Boston | November 4, 5 and 6 |
| Washington DC | November 12, 13 and 14 |
| Atlanta | November 19, 20 and 21 |
| Los Angeles | December 5, 6 and 7 |

For further information contact Robert E Harar, at (301) 937-7177. ■



DELTA ELECTRONICS

POST OFFICE BOX 2, AMESBURY, MASSACHUSETTS 01913 Phone (617) 388-4705

AMP Security System Card Reader

This card reader was made by AMP for use in SECURITY SYSTEMS. A stiff 2 1/8" x 3 3/8" card (credit card size) is inserted, which closes a micro-switch. A 115v AC solenoid is then energized, which pulls down a set of wipers to read through holes in the card. The wipers are arranged in 3 8 bit bytes + 1 bit, for a total of 25 bits. By turning the card over, 48 bits are possible.

This device is ideal for security systems...entry can be controlled by means of a card with an almost infinite number of combinations, rather than using an easily duplicated key. As another example, an entire Social Security number, plus an entry code, could be read from a card. 5" x 5" x 9" deep. Shipping weight 6 lbs.

STOCK NO. B5353

\$19.95 each, 2 for \$35

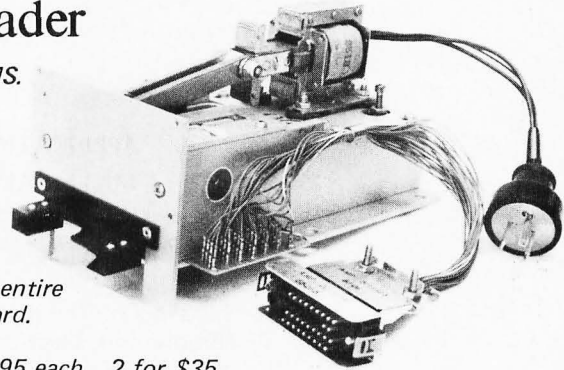

Wood Cabinets

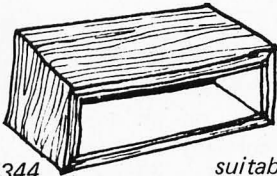

B5344

One of the problems with home-brew projects is finding a suitable enclosure, one that will do justice to your latest pride & joy. We have 2 wood cabinets that are

suitable for small projects. B5344 has real teak veneer on all 4 sides

over a 1/2" particleboard base. Outside dimensions are 13 3/4"W x 5 1/8"H x 6 3/4"D, with a 1/2" deep recess

in the front. Mounting holes in the bottom. B7129 has a walnut vinyl covering over a 3/8" plywood base. Outside dimensions are 8 3/4"W x 4 1/4"H x 10 3/4"D. With small vent and rubber feet on the bottom.

STOCK NO. B5344

Teak cabinet

Shipping weight 6 lbs.

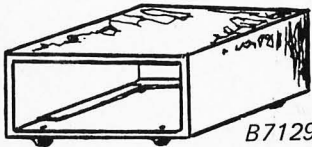

B7129

\$7.95 each, 2/15.00

STOCK NO. B7129

Walnut cabinet

Shipping weight 3 lbs.

\$5.95 each, 2/10.00

Switchcraft Push Button Switch Assembly

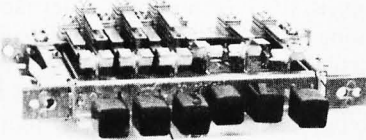

Switchcraft series 7000 push button switch assembly, with 6 sections. 5 sections are interlocked in a 1-of-5 pattern, and the 6th button is momentary, which releases the others. Sections 4 & 5 may be depressed together; the others are excluded by means of a lockout bar. The switch comes

with 12 sets of contacts: 6 SPST, normally open, 3 SPDT, and 3 DPDT, all rated at 3 amps. The

contacts may be arranged in any order, up to 4 in each section. Buttons are 1/2" square black, on 5/8" centers. Overall size 5 1/2" wide x 3 1/2" deep x 1 3/4" high. This versatile switch lists for well over \$30! Shipping weight 2 lbs.

STOCK NO. B6408

\$2.50 each, 3 for \$6.00

Lead-Acid Storage Battery

Lead acid storage batteries are still the cheapest & easiest to work with of all types of batteries. Two of these would be ideal for keeping the memory up in your computer when the power is off. They are rated at 6 ampere-hours, 6 volts. 2 1/4" x 3 3/4" x 5 1/2" high. The fill holes have screw-in caps and an overflow container is provided, making this battery spill proof. We provide charging data, you provide the electrolyte. 3 lbs.

STOCK NO. B5074

\$5.95 each, 2/11.00



Power Transformers

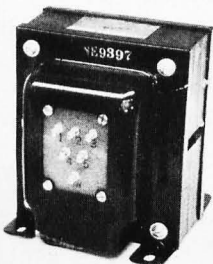

B9397....(shown) A versatile power transformer from a line printer manufacturer. The primary is tapped for operation at 115v or 230v. There are 4 secondaries: 34v centertapped @ 3 amps, 17v @ 4 amps, 11v @ 5 amps, and 6.3v @ 1.5 amps. This would make an ideal transformer for a +5 volt and ±15 volt power supply. 3 3/4" x 4 1/2" x 4 3/4" high. Shipping weight 10 lbs.

STOCK NO. B9397

\$12.95 each, 2 for \$24

B9940....Dual 115v primaries, 3 secondaries: 17v center tapped @ 10 amps, 22v center tapped @ 5 amps, and 25v center tapped @ 7 amps. 3 3/4" x 4 3/4" x 4 1/2" high, shipping weight 15 lbs. Another good +5v and ±15v supply transformer. STOCK NO. B9940

\$14.95 each, 2 for \$28

Send for our latest free catalog. Minimum order \$5, phone orders welcome. Include sufficient postage (2 lbs min.), excess will be refunded. BANKAMERICARD & MASTERCHARGE welcome, ALL numbers needed for processing. Minimum charge \$15.

theless, amateurs and experimenters may find that a perusal of the patent literature is quite fruitful.

Howard L Grams
2616 N Salisbury St
W Lafayette IN 47906

**APPLICATIONS DIGEST,
MATERIALS NEEDED**

I am compiling a "Microcomputer Application Digest" to be published by Howard W Sams & Co. The text is arranged by subject (Biorhythms, Electronic Music, Speech Analysis, RTTY, Terminals, Business Systems, Security, Video Art, Video Games, etc). Each section will cover several real systems, a brief tutorial on the subject, block diagrams, list of components, and names of contributing parties. Sources of additional information will also be provided.

At this point, I am seeking inputs from all interested persons who wish to share their experience to increase the exchange of information in their application area.

To keep it simple, I would like those who want to be in the book to drop me a postcard with your name, address, phone number, and a brief explanation of your application. I will then send you a form to fill out which will put the information into a standard easy to read format. This will then be collated into the book.

Not all applications need to be up and running to qualify for the text. Ideas, well thought out, are as valuable as finished systems.

If you wish our field to expand, I urge you to take time to drop me a postcard and to expound on your efforts with microcomputers—it's by spreading ideas that new ideas grow.

Mitchell Waite
H S Dakin Co
3101 Washington St
San Francisco CA 94115

NEXT OF KIM . . .

Congratulations on an excellent magazine! I look forward to its arrival every month as each issue contains at least one article (and usually 3 or 4) that I can use immediately.

I would also like to publicly thank one of your advertisers for their fast delivery times, their prompt no-questions-asked warranty service, and their excellent newsletters. This company is MOS Technology. After months of fighting with two other computer manufacturers, I ordered a KIM-1. The KIM-1 is, in itself, a fantastic product, but with MOS Technology backing it, it is, in my opinion, the best buy on the market today!

There are presently three KIM-1 owners who work here at Eastern Washington State College. Also, the chemistry department has an Altair 8080 and the psychology department has a DEC PDP-8/F. We would like to invite anyone in the greater Spokane area (or anywhere else) who is interested in building a system or learning more about microprocessors and/or programming techniques to contact either myself or Dr R Keefer. I am a technician for the psychology department and Dr Keefer is a professor for the mathematics department. Perhaps we may have enough interested people to start a computer club or a KIM-1 users group.

Keep up the good work.

Tony Kjeldsen K7VNT
5315 N Allen Pl
Spokane WA 99208

PS I'm afraid I must agree with B L Donelan (June 1976 BYTE) concerning the December issue cover.

First Come First Served

**Back Issues
of BYTE**

\$1.50



We have very few of some of them and a large supply of others, but no more than 2,000 of any one issue. Orders will be filled on a first come, first served basis until the supply is exhausted. **DO NOT SEND MONEY**, we will enclose a bill with your order for the number of issues we are able to supply plus a 25 cents EACH postage and handling charge.

The back issues listed below are available from BYTE. Circle issues desired

Dec 75 Jan 76 Feb 76 Mar 76 June 76 July 76

Bill me Bill MC BAC No. _____ Exp. Date _____

Name _____

Address _____

City _____ State _____ Zip _____

BYTE 70 Main Street Peterborough, NH 03458

It's all right here

Prompt service
In-depth inventories

BRIGAR electronics

Offices & Warehouse: 10 Alice Street, Binghamton, New York 13904 • Tel: 607-723-3111

SAVE

SAVE

PHONE ORDERS
607 723 3111

MINIATURE LAMPS

INCANDESCENT LAMPS

CHICAGO MINIATURE LAMPS #387
SAME AS #327 EXCEPT LONGER LIFE
28 volts .04 amps. Bulb Style T-1-3/4
Mid-Flange Base. BRAND NEW BOXED, 100
per box. 40,000 pcs in stock.
PRICE SCHEDULE
1 - 99 .. 40¢ each 100 - up .. 35¢ ea.

NEON INDICATING GLOW LAMPS

NE-2 neon lamps, with dropping resistor
to operate directly from 115 VAC.
Nominal Watts - 1/17. T-2 Clear Bulb,
wire terminals.
25,000 pcs in stock. Mfd by G.E. Co.
10¢ each up to 1000 pcs.
1000 pcs & up 7¢ each.

INDICATOR LIGHTS

BRITE-GLO INCANDESCENT LAMPS

BRITE-GLO Incandescent Lamps
Ultraminaturized Series, 100,000 hr. life
Versatile, low cost indicator lamp. Ideal
for Stereo Amplifiers, Mobile Equipment,
Instrumentation, Computer and Display
Panels, Etc.
High temperature, T 1-3/4 lamps - Metal
Base - Wire Terminals. Metal base in-
creases light output and protects lamp
from damage.
41,685 pcs - 6.3 volts, 75 ma, 8" wire
leads.
40,263 pcs - 6.3 volts, 200 ma, 13" wire
leads.

DISCOUNT SCHEDULE

| | |
|---------|---------|
| 1 - 99 | 25¢ ea. |
| 100-499 | 20¢ ea. |
| 500-999 | 15¢ ea. |
| 1000-UP | 12¢ ea. |

BARGAINS PRECISION RESISTORS

BRAND NEW - FINEST QUALITY

| QUAN | MFR | TOL. (%) | OHMS | WATTS | PRICE Each |
|--------|---------|----------|-------|-------|------------|
| 10,686 | T.I. | 1 | 191 | 1/8 | \$.04 |
| 3,000 | Electra | 1 | 191 | 1/8 | .04 |
| 29,900 | I R C | 1 | 243 | 1/8 | .04 |
| 75,000 | T.I. | 1 | 2,43K | 1/8 | .04 |
| 35,000 | F.I. | 1 | 909 | 1/4 | .06 |
| 7000 | T.I. | 1 | 10 | 1/2 | .07 |
| 3000 | Electra | 1 | 15.4 | 1/2 | .07 |
| 5700 | Electra | 1 | 28 | 1/2 | .07 |
| 7900 | I R C | 1 | 53.6 | 1/2 | .07 |
| 7200 | I R C | 1 | 90.9 | 1/8 | .04 |
| 6600 | I R C | 1 | 1650 | 1/8 | .04 |
| 1800 | I R C | 1 | 6190 | 1/8 | .04 |
| 1000 | I R C | 1 | 2670 | 1/8 | .04 |

Computer Grade Capacitors

PHONE ORDERS
607 723 3111

Instant off-the-shelf
delivery.

| QUAN. | MFD. | VOLTS | SIZE | PRICE EA |
|-------|-------|-------|-------------------|----------|
| 350 | 30000 | 5 | 1-3/8 x 4-3/16 | \$1.50 |
| 494 | 60000 | 5 | 3" x 4-1/2" | 1.50 |
| 1016 | 25000 | 6 | 2-1/16" x 4-9/16" | 1.50 |
| 527 | 40000 | 7 | 2" x 5" | 1.50 |
| 353 | 15000 | 10 | 2" x 4-1/8" | 1.25 |
| 869 | 15000 | 10 | 2" x 4-7/16" | 1.25 |
| 277 | 40000 | 10 | 3" x 4-1/2" | 1.70 |
| 316 | 74000 | 10 | 3" x 4-3/4" | 2.00 |
| 375 | 15000 | 12 | 2" x 4-3/8" | 1.25 |
| 267 | 14000 | 13 | 2" x 4-3/8" | 1.25 |
| 600 | 10000 | 15 | 2-1/16" x 4-1/2" | 1.25 |
| 529 | 12500 | 16 | 2" x 4-1/8" | 1.25 |

Computer Grade Capacitors

MALLORY

PRICE SLASHED

CG (STANDARD) 85°C Supplied with PVC Insulating Sleeve

| Quan. | Mfd. | Vdc | Size | Each |
|-------|------|-----|-------------------|-------|
| 10000 | 1100 | 35 | 1-25/64 x 2-11/64 | \$.75 |
| 25000 | 100 | 350 | 1-25/64 x 2-11/64 | .50 |
| 10000 | 80 | 400 | 1-25/64 x 2-11/64 | .60 |

POTTER SUB-MINIATURE

& BRUMFIELD GENERAL-PURPOSE

RELAYS

TYPE KH 5505 (Identical to KHU17D11)
COIL: 24vdc, 650 ohms.
CONTACTS: 4PDT, 3amps at 30vdc or 120 vac
Small rugged DC relay with clear poly-
carbonate dust cover. Contacts are gold
flushed silver.
Mounts by solder terminals or 3-48 stud
5/16" long. Also mounts as plug-in.
6500 pc in stock, BRAND NEW, while they
last at this price. \$1.25 each

LAMINATED PHENOLIC PLASTIC PANELS

BRAND NEW PHENOLIC SHEETS

Grade LE- Natural
Type - FBE, Mil Spec: 15035, .062" thick
Needed by all experimenters, amateurs and
radio men for insulating parts - terminal
strips - building sets or for research &
development, etc.
Stock # 560 - 6" x 6" x .062" 42¢ each
" # 561 - 6" x 12" x .062 82¢ each
" # 563 - 12" x 12" x .062 \$1.58 ea
" # 564 - Full sheets 38" x 47" x .062"
\$13.00 each.

BRAND NEW QUALITY SHEETS

High-Speed Reset Counter Veeder-Root

4 FIGURE COUNTER MANUAL RESET
115VDC/115VAC
VEEDER ROOT 177604

115VAC (Rectifier supplied). Basic
counter is 115VDC, 5 watts 4 figure,
black on white background. Push button
reset. Dim.: 1-7/8" width 1-1/8" high
x 2-1/2" deep.



\$1295

LIGHTED \$2.95 Each

PUSHBUTTON SWITCHES



Unit can be used on 6 v
or in series for 12 volt
SPST, mom, PC board gold
plated pins for wiring or
easy installation.
10,000 pcs in stock

Mfr: Grayhill Switch Co. Widely used on computers, machine tools,
office machines, guidance control and a
wide variety of applications.

Electrolytic Capacitors

TUBULAR, HIGH RELIABILITY



| QUAN. | MFD. | VDC | EACH | QUAN. | MFD. | VDC | EACH |
|--------|------|-----|--------|-------|------|-----|--------|
| 600 | 100 | 3 | .30 | 1055 | 30 | 350 | \$1.00 |
| 375 | 250 | 3 | .35 | 246 | 40 | 350 | 1.14 |
| 298 | 500 | 6 | \$1.00 | 967 | 4 | 450 | .98 |
| 299 | 1000 | 6 | 1.00 | 400 | 10 | 450 | 1.07 |
| 571 | 1200 | 6 | 1.02 | 529 | 15 | 450 | 1.07 |
| 375 | 1500 | 6 | 1.10 | 453 | 20 | 450 | 1.14 |
| 313 | 2000 | 6 | 1.11 | | | | |
| 597 | 100 | 12 | .60 | | | | |
| 4000 | 50 | 15 | .30 | | | | |
| 26,000 | 200 | 15 | .30 | | | | |
| 416 | 1500 | 15 | 1.10 | | | | |
| 350 | 2000 | 15 | 1.10 | | | | |
| 2500 | 10 | 25 | .25 | | | | |
| 1161 | 2000 | 25 | 1.40 | | | | |
| 2600 | 10 | 50 | .40 | | | | |
| 1000 | 500 | 50 | .80 | | | | |
| 825 | 100 | 50 | .95 | | | | |
| 1099 | 150 | 50 | .90 | | | | |
| 6549 | 250 | 50 | .98 | | | | |
| 1942 | 300 | 50 | 1.07 | | | | |
| 10,500 | 60 | 150 | .70 | | | | |
| 520 | 80 | 150 | .90 | | | | |
| 290 | 300 | 150 | 1.00 | | | | |
| 476 | 40 | 200 | 1.00 | | | | |
| 409 | 100 | 250 | 1.39 | | | | |
| 284 | 200 | 250 | 1.50 | | | | |
| 255 | 5 | 350 | .90 | | | | |
| 281 | 10 | 350 | .90 | | | | |
| 20,000 | 4 | 250 | .35 | | | | |
| 339 | 8 | 250 | .70 | | | | |
| 400 | 16 | 250 | .60 | | | | |

METALLIZED PAPER FILM

| QUAN | MFD | VDC | EACH |
|--------|-------|-----|-------|
| 899 | .1 | 100 | \$.35 |
| 437 | .33 | 100 | .40 |
| 400 | 1.0 | 100 | .45 |
| 1360 | .22 | 150 | .40 |
| 820 | .022 | 200 | .35 |
| 4200 | .033 | 200 | .35 |
| 400 | .1 | 200 | .40 |
| 771 | 1.0 | 200 | .40 |
| 417 | 1.5 | 200 | .40 |
| 1100 | .001 | 400 | .35 |
| 1100 | .0022 | 400 | .40 |
| 1600 | .022 | 400 | .45 |
| 565 | .047 | 400 | .50 |
| 4000 | .022 | 600 | .25 |
| 389 | .05 | 600 | .30 |
| 500 | .1 | 600 | .30 |
| 600 | .2 | 600 | .30 |
| 717 | .25 | 600 | .30 |
| 30,000 | .01 | 100 | .15 |
| 1000 | .047 | 100 | .20 |
| 291 | .22 | 400 | .30 |



HIGH POWER DUMMY LOAD



Mfg. Eastern Microwave. #10-1254...RF Coaxial Load Resistor utilizing water flow to cool and provide a load resistance of 50 ohms for inputs from DC to 4000 MHz. Maximum power input is 1000 watts. Requires a flow of .218 GPM min. per 100 watts of input power; 100 psi pressure. Compression fittings on water line inlet and outlet for copper tubing supply lines. Has a Flange type coaxial fitting, friction type, 13/16" I.D. with 2-1/4" flange. Completely shielded unit of machined aluminum. Size: 1-5/8" diameter by 5-3/8" long. Shipping weight, 2 lbs.
5,000 pcs in stock, NEW BOXED.....\$14.95 each.....

Cherry Electrical Products



These switches are postage stamp sized precision switches which feature long operating life & high electrical capacity for their size 5 amp, 1/4 HP, 125-250 vac, SPDT, quick disconnect terminals. 2,000 pcs in stock without lever. .75¢ each 2,400 pcs in stock with extended roller lever. 95¢ ea

TANTALUM CAPACITORS

SPRAGUE

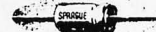

TYPE 109D

TUBULAR SINTERED-ANODE TANTALEX CAPACITOR
#109D147X9060T2

1620 pcs - 140 uf ±10% - 60vdc \$2.00 ea.

GENERAL ELECTRIC



PLAIN FOIL TANTALUMS -135°C
(Use CL31 instead of CL30, or CL33 instead of CL32 for Mylar Dielectrics)
CL3035-POLARIZED

3,000 pcs CL31BE180MPE, 18uf - 15vdc 65¢ each

300 pcs CL31BE550MPE, 55uf - 15vdc 85¢ each

900 pcs CL33BL020MNE, 2.0uf - 75vdc \$1.00 each

MTP/MPH ULTRA-MINIATURE TANTALUM CAPACITORS

MALLORY



MTP TYPES

10,550 pcs MTP685M020P1D, 6.8uf - 20vdc 55¢ each

2,100 pcs MTP106M030P1A, 10uf - 30vdc 75¢ each

1,028 pcs MTP336M010P1A, 33uf - 10vdc 65¢ each

MALLORY



TAS SOLID ELECTROLYTE TANTALUM CAPACITORS

4996 pcs, 4.7uf ±10%, 6vdc, TAS475K006P1A 35¢ ea

394 pcs, .47uf ±10%, 6vdc, TAS474K006P1A 38¢ ea

1430 pcs, 47uf ±10%, 6vdc, TAS476K006P1C 40¢ ea

326 pcs, 220uf ±20%, 6vdc, TAS227M006P1G \$1.20 ea

285 pcs, 5.6uf ±10%, 10vdc, TAS565K010P1C 40¢ ea

4574 pcs, 10uf ±10%, 10vdc, TAS106K010P1C 40¢ ea

900 pcs, 15uf ±20%, 10vdc, TAS156M010P1C 40¢ ea

887 pcs, .068uf ±10%, 20vdc, TAS683K020P1A 51¢ ea

152 pcs, 2.2uf ±20%, 20vdc, Sprague 40¢ ea

1457 pcs, .47uf ±10%, 35vdc, TAS474K035P1A 51¢ ea

GENERAL ELECTRIC

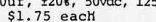

PLAIN FOIL TANTALUMS -135°C

365 pcs G.E. 40uf ±20%, 50vdc, 125°C

Type: 2K105AA6M. \$1.75 each

1168 pcs SPRAGUE, 40uf, ±20%, 50vdc, 125°C

Type: 22D005A3M. \$1.75 each C

All Orders F.O.B.
Binghamton, NY.
Minimum Order \$5.00
NY State Residents
Please add sales tax

BRIGAR ELECTRONICS publishes a monthly flyer
If you want to be placed on our active mail
list, send us your
Name
Address

SAVE

ATTENTION PDP-8 LOVERS!

Thought I would drop a line to BYTE and say how much I enjoy the magazine. I first got into home computing in 1973. A friend down in Texas found a used PDP-8 and called me. We went down on business and at the same time stopped over to see the machine. We bought it and back home made a crate from dimensions in the manual. Next trip down we carried the crate knocked down on the plane, crated it and shipped it back. It went on the air with very little trouble and we immediately had a vast amount of software from DEC and the users group DECUS. We now have six PDP-8s in the Washington DC area with one fellow just finishing a homebrew machine with the Intersil IM6100 chip. Out of this group all the fellows are electrical engineers, none of which has a computer science background. Two of us are interfacing surplus speech synthesizers and are interested in using the 8s for signal processing and speech synthesis. One other is interested in motion picture photography and is interfacing a high resolution CRT system to his 8 and an animation camera. The PDP-8s are the straight 8 version first built about 1966 being implemented with discrete components throughout. We have spare cards and the

maintenance is done by each person, although the more experienced of us give help to the others. We are looking forward to articles in BYTE on PDP-8 and IM6100 type systems; no doubt they will start with the introduction of the IM6100 kit by PCM. We are of course always glad to hear from other PDP-8 people.

Frank Gentges
3512 Orme Dr
Temple Hills MD 20031
(301) 894-2613

A SALUTE TO THE PDP-8 AND FAREWELL

This letter is an opinion in response to the article in BYTE #9, "Chip Off the Olde PDP 8/E" by Robert Nelson [page 60] in which he made the incredible statement, "The PDP-8 at this point may truly be *the* universal computer" and which concluded with the statement that "Many of the microprocessor chips available today were not designed to be the heart of a general purpose minicomputer . . . (but) . . . were primarily designed . . . (for industrial control applications) . . ."

Mr Nelson either overlooks or never knew that the PDP-8 was frequently sold not as a computer but as a controller. In any case,

Christmas!

Can it be that there are still hackers* out there who haven't yet subscribed to BYTE?

From the way new subscriptions are inundating Debby, Deena and crew, it seems there are thousands of hackers* who are only now discovering what a blessing it is to have BYTE come each month whether they remember to go out and buy it or not.

Perhaps you know one or more unfortunate who each month runs the risk of missing BYTE. Perhaps you ARE one.

Give him a gift. Give her a gift. Give yourself a gift.

As our holiday gift to you, each subscription after the first at the regular \$12 rate (which by the way saves you \$3 a year over single copy price) will cost only \$10 (a vast \$5 saving over single copy price).

Considering it can take as long as six weeks to process a subscription, it's not a bit too early to give the perfect gift for the hacker* who hasn't yet subscribed.

*microists, cybernuts, byters, kluges, etc . . . see letter on pages 18-20 about our identity crisis.

BYTE GIFT
70 Main St
Peterborough NH 03458

Name
Address
City State Zip

BILL ME Check for \$12 enclosed

Bill BankAmericard No.

Bill Master Charge No.

BYTE GIFT
70 Main St
Peterborough NH 03458

Name
Address
City State Zip

BILL ME Check for \$10 enclosed

Bill BankAmericard No.

Bill Master Charge No.

NOTE: If you're taking advantage of this offer, please use these coupons instead of the yellow card. If you're sending more than one \$10 gift sub (Santa Claus incarnate!), photocopy or otherwise copy the coupons. An elf from Mars has been hired to handle gift subscriptions exclusively, and the color yellow makes him dangerously bilious.

7400N TTL

| | | | | | |
|---------|-----|---------|------|----------|------|
| SN7400N | .16 | SN7400N | .25 | SN74154N | 1.00 |
| SN7401N | .16 | SN7401N | .22 | SN74155N | .99 |
| SN7402N | .21 | SN7402N | .45 | SN74156N | .99 |
| SN7403N | .16 | SN7403N | .39 | SN74157N | .99 |
| SN7404N | .18 | SN7404N | .37 | SN74158N | 1.25 |
| SN7405N | .24 | SN7405N | .32 | SN74159N | .99 |
| SN7406N | .20 | SN7406N | .50 | SN74160N | 1.10 |
| SN7407N | .29 | SN7407N | .50 | SN74161N | .99 |
| SN7408N | .25 | SN7408N | 5.00 | SN74162N | 2.10 |
| SN7409N | .25 | SN7409N | .50 | SN74163N | 1.10 |
| SN7410N | .18 | SN7410N | .98 | SN74164N | 1.25 |
| SN7411N | .30 | SN7411N | .70 | SN74165N | 1.20 |
| SN7412N | .33 | SN7412N | .89 | SN74166N | 5.50 |
| SN7413N | .45 | SN7413N | .89 | SN74167N | 2.10 |
| SN7414N | .70 | SN7414N | 3.50 | SN74168N | 8.95 |
| SN7415N | .35 | SN7415N | 2.25 | SN74169N | 1.50 |
| SN7416N | .35 | SN7416N | .45 | SN74170N | 2.10 |
| SN7417N | .33 | SN7417N | .75 | SN74171N | .90 |
| SN7418N | .33 | SN7418N | .49 | SN74172N | .90 |
| SN7419N | .33 | SN7419N | .49 | SN74173N | 1.50 |
| SN7420N | .33 | SN7420N | .79 | SN74174N | 1.25 |
| SN7421N | .33 | SN7421N | .79 | SN74175N | 1.25 |
| SN7422N | .33 | SN7422N | .79 | SN74176N | .90 |
| SN7423N | .33 | SN7423N | .79 | SN74177N | .90 |
| SN7424N | .33 | SN7424N | .79 | SN74178N | .90 |
| SN7425N | .33 | SN7425N | .79 | SN74179N | .90 |
| SN7426N | .33 | SN7426N | .79 | SN74180N | .99 |
| SN7427N | .33 | SN7427N | .79 | SN74181N | 2.49 |
| SN7428N | .33 | SN7428N | .79 | SN74182N | 2.95 |
| SN7429N | .33 | SN7429N | .79 | SN74183N | 2.95 |
| SN7430N | .33 | SN7430N | .79 | SN74184N | 1.95 |
| SN7431N | .33 | SN7431N | .79 | SN74185N | 2.20 |
| SN7432N | .33 | SN7432N | .79 | SN74186N | 5.00 |
| SN7433N | .33 | SN7433N | .79 | SN74187N | 5.00 |
| SN7434N | .33 | SN7434N | .79 | SN74188N | 3.95 |
| SN7435N | .33 | SN7435N | .79 | SN74189N | 1.19 |
| SN7436N | .33 | SN7436N | .79 | SN74190N | 1.19 |
| SN7437N | .33 | SN7437N | .79 | SN74191N | 1.25 |
| SN7438N | .33 | SN7438N | .79 | SN74192N | .89 |
| SN7439N | .33 | SN7439N | .79 | SN74193N | .89 |
| SN7440N | .33 | SN7440N | .79 | SN74194N | .89 |
| SN7441N | .33 | SN7441N | .79 | SN74195N | .75 |
| SN7442N | .33 | SN7442N | .79 | SN74196N | 1.25 |
| SN7443N | .33 | SN7443N | .79 | SN74197N | .75 |
| SN7444N | .33 | SN7444N | .79 | SN74198N | 1.75 |
| SN7445N | .33 | SN7445N | .79 | SN74199N | 1.75 |
| SN7446N | .33 | SN7446N | .79 | SN74200N | 5.59 |
| SN7447N | .33 | SN7447N | .79 | SN74201N | .90 |
| SN7448N | .33 | SN7448N | .79 | SN74202N | 1.79 |
| SN7449N | .33 | SN7449N | .79 | SN74203N | 6.00 |
| SN7450N | .33 | SN7450N | .79 | SN74204N | 6.00 |
| SN7451N | .33 | SN7451N | .79 | SN74205N | 6.00 |
| SN7452N | .33 | SN7452N | .79 | SN74206N | 6.00 |
| SN7453N | .33 | SN7453N | .79 | SN74207N | 6.00 |
| SN7454N | .33 | SN7454N | .79 | SN74208N | 6.00 |
| SN7455N | .33 | SN7455N | .79 | SN74209N | 6.00 |
| SN7456N | .33 | SN7456N | .79 | SN74210N | 6.00 |
| SN7457N | .33 | SN7457N | .79 | SN74211N | 6.00 |
| SN7458N | .33 | SN7458N | .79 | SN74212N | 6.00 |
| SN7459N | .33 | SN7459N | .79 | SN74213N | 6.00 |
| SN7460N | .33 | SN7460N | .79 | SN74214N | 6.00 |
| SN7461N | .33 | SN7461N | .79 | SN74215N | 6.00 |
| SN7462N | .33 | SN7462N | .79 | SN74216N | 6.00 |
| SN7463N | .33 | SN7463N | .79 | SN74217N | 6.00 |
| SN7464N | .33 | SN7464N | .79 | SN74218N | 6.00 |
| SN7465N | .33 | SN7465N | .79 | SN74219N | 6.00 |
| SN7466N | .33 | SN7466N | .79 | SN74220N | 6.00 |
| SN7467N | .33 | SN7467N | .79 | SN74221N | 6.00 |
| SN7468N | .33 | SN7468N | .79 | SN74222N | 6.00 |
| SN7469N | .33 | SN7469N | .79 | SN74223N | 6.00 |
| SN7470N | .33 | SN7470N | .79 | SN74224N | 6.00 |
| SN7471N | .33 | SN7471N | .79 | SN74225N | 6.00 |
| SN7472N | .33 | SN7472N | .79 | SN74226N | 6.00 |
| SN7473N | .33 | SN7473N | .79 | SN74227N | 6.00 |
| SN7474N | .33 | SN7474N | .79 | SN74228N | 6.00 |
| SN7475N | .33 | SN7475N | .79 | SN74229N | 6.00 |
| SN7476N | .33 | SN7476N | .79 | SN74230N | 6.00 |
| SN7477N | .33 | SN7477N | .79 | SN74231N | 6.00 |
| SN7478N | .33 | SN7478N | .79 | SN74232N | 6.00 |
| SN7479N | .33 | SN7479N | .79 | SN74233N | 6.00 |
| SN7480N | .33 | SN7480N | .79 | SN74234N | 6.00 |
| SN7481N | .33 | SN7481N | .79 | SN74235N | 6.00 |
| SN7482N | .33 | SN7482N | .79 | SN74236N | 6.00 |
| SN7483N | .33 | SN7483N | .79 | SN74237N | 6.00 |
| SN7484N | .33 | SN7484N | .79 | SN74238N | 6.00 |
| SN7485N | .33 | SN7485N | .79 | SN74239N | 6.00 |
| SN7486N | .33 | SN7486N | .79 | SN74240N | 6.00 |
| SN7487N | .33 | SN7487N | .79 | SN74241N | 6.00 |
| SN7488N | .33 | SN7488N | .79 | SN74242N | 6.00 |
| SN7489N | .33 | SN7489N | .79 | SN74243N | 6.00 |
| SN7490N | .33 | SN7490N | .79 | SN74244N | 6.00 |
| SN7491N | .33 | SN7491N | .79 | SN74245N | 6.00 |
| SN7492N | .33 | SN7492N | .79 | SN74246N | 6.00 |
| SN7493N | .33 | SN7493N | .79 | SN74247N | 6.00 |
| SN7494N | .33 | SN7494N | .79 | SN74248N | 6.00 |
| SN7495N | .33 | SN7495N | .79 | SN74249N | 6.00 |
| SN7496N | .33 | SN7496N | .79 | SN74250N | 6.00 |
| SN7497N | .33 | SN7497N | .79 | SN74251N | 6.00 |
| SN7498N | .33 | SN7498N | .79 | SN74252N | 6.00 |
| SN7499N | .33 | SN7499N | .79 | SN74253N | 6.00 |
| SN7500N | .33 | SN7500N | .79 | SN74254N | 6.00 |

CONSUMER ELECTRONICS

PONG SUPER PONG

SINGLE GAME \$59.95
4 GAMES IN ONE \$89.95

FOR YOUR HOME TV

GAMES INCLUDED IN SUPER PONG ARE:

- PONG
- SUPER PONG
- CATCH
- HANDBALL

FEATURES OF PONG AND SUPER PONG

- Incremental speed on volleys increases excitement.
- Playing field adjusts to any size screen.
- Game appears in color or in black & white, depending on television set.
- Unmistakable "PONG" sound accompanies each volley.
- Digital scoring flashes on the screen between each point.
- 2 player challenge or Solitaire.
- Hooks up simply to any model television set, the screen actually becomes the playing field.
- English and other techniques can be used to make any member of the family a Pong champion.
- Battery operated by 4 size "D" flashlight batteries included with the Unit.

AC Adapter (Eliminates Batteries) \$9.95



MINIATURE TOGGLE

| | | | | | | | | |
|------|----|------|----|-----|------|------|------|------|
| DDOT | ON | OFF | ON | 2Z1 | 2.95 | 2.55 | 1.87 | 1.70 |
| | ON | NONE | ON | 2Z3 | 2.95 | 2.15 | 1.58 | 1.43 |
| | ON | OFF | ON | 121 | 2.35 | 1.95 | 1.43 | 1.30 |
| | ON | NONE | ON | 123 | 2.05 | 1.65 | 1.21 | 1.10 |

SPOT - SERIES PB, PB1
Maintained Action Switch, Push To Make Contact, Reset Push Again To Release Action

Push Button
PB-123 \$1.75
PB-126 \$1.75

THUMBWHEEL SWITCHES

THUMBWHEEL SWITCH ONLY
Part No. Description Price
SR 12 10 Position BCD 0N 2.50
SR 12 10 Position BCD 0N 2.50
SR 12 10 Position BCD 0N 2.50

DISCRETE LEDS SPECIAL SALE!

1/25" dia. 1/190" dia.

| | | | |
|-------------|--------|-------------|-------|
| XC209Red | 10/\$1 | XC111Red | 8/\$1 |
| XC209Green | 4/\$1 | XC111Green | 4/\$1 |
| XC209Yellow | 7/\$1 | XC111Yellow | 4/\$1 |
| XC209Orange | 4/\$1 | XC111Orange | 4/\$1 |

2/200" dia. 1/185" dia. 2/200" dia. 1/085" dia.

| | | | | | |
|-------------|-------|-------------|--------|-------------|--------|
| XC222Red | 5/\$1 | XC526Red | 10/\$1 | XC566Red | 10/\$1 |
| XC222Green | 4/\$1 | XC526Green | 7/\$1 | XC566Green | 7/\$1 |
| XC222Yellow | 4/\$1 | XC526Yellow | 4/\$1 | XC566Yellow | 7/\$1 |
| XC222Orange | 4/\$1 | XC526Orange | 4/\$1 | XC566Orange | 7/\$1 |
| SSL-22RT | 8/\$1 | XC526Clear | 7/\$1 | XC566Clear | 7/\$1 |

MAN 7 \$99 DL33B \$99

DISPLAY LEDS SUPER SAVINGS!

MAN 7 \$99 DL33B \$99

DL707 DL747 DL33B

| TYPE | POLARITY | HT | TYPE | POLARITY | HT |
|--------|---------------------|-----------|----------|-----------------------|-----------|
| MAN 1 | Common Anode | .270 2.49 | MAN 3620 | Common Anode-Orange | .300 .99 |
| MAN 2 | 5 x 7 Dot Matrix | .125 3/1 | MAN 3640 | Common Cathode-Orange | .300 .99 |
| MAN 3 | Common Cathode | .125 3/1 | MAN 4710 | Common Anode-Red | .400 .99 |
| MAN 4 | Common Cathode | .125 3/1 | DL 747 | Common Anode-Red | .300 .99 |
| MAN 5 | Common Cathode | .125 3/1 | DL 707 | Common Anode-Red | .300 1.50 |
| MAN 6 | Common Anode-Red | .300 1.95 | DL 728 | Common Cathode | .500 1.90 |
| MAN 7 | Common Anode-Yellow | .300 1.95 | DL 747 | Common Anode | .400 2.25 |
| MAN 8 | Common Anode-Red | .300 .99 | DL 750 | Common Cathode | .600 2.49 |
| MAN 9 | Common Anode-Red | .300 .99 | DL 750 | Common Cathode | .600 2.49 |
| MAN 10 | Common Anode-Red | .300 .99 | DL 750 | Common Cathode | .600 2.49 |
| MAN 11 | Common Anode-Red | .300 .99 | DL 750 | Common Cathode | .600 2.49 |
| MAN 12 | Common Anode-Red | .300 .99 | DL 750 | Common Cathode | .600 2.49 |
| MAN 13 | Common Anode-Red | .300 .99 | DL 750 | Common Cathode | .600 2.49 |
| MAN 14 | Common Anode-Red | .300 .99 | DL 750 | Common Cathode | .600 2.49 |
| MAN 15 | Common Anode-Red | .300 .99 | DL 750 | Common Cathode | .600 2.49 |
| MAN 16 | Common Anode-Red | .300 .99 | DL 750 | Common Cathode | .600 2.49 |
| MAN 17 | Common Anode-Red | .300 .99 | DL 750 | Common Cathode | .600 2.49 |
| MAN 18 | Common Anode-Red | .300 .99 | DL 750 | Common Cathode | .600 2.49 |
| MAN 19 | Common Anode-Red | .300 .99 | DL 750 | Common Cathode | .600 2.49 |
| MAN 20 | Common Anode-Red | .300 .99 | DL 750 | Common Cathode | .600 2.49 |
| MAN 21 | Common Anode-Red | .300 .99 | DL 750 | Common Cathode | .600 2.49 |
| MAN 22 | Common Anode-Red | .300 .99 | DL 750 | Common Cathode | .600 2.49 |
| MAN 23 | Common Anode-Red | .300 .99 | DL 750 | Common Cathode | .600 2.49 |
| MAN 24 | Common Anode-Red | .300 .99 | DL 750 | Common Cathode | .600 2.49 |
| MAN 25 | Common Anode-Red | .300 .99 | DL 750 | Common Cathode | .600 2.49 |
| MAN 26 | Common Anode-Red | .300 .99 | DL 750 | Common Cathode | .600 2.49 |
| MAN 27 | Common Anode-Red | .300 .99 | DL 750 | Common Cathode | .600 2.49 |
| MAN 28 | Common Anode-Red | .300 .99 | DL 750 | Common Cathode | .600 2.49 |
| MAN 29 | Common Anode-Red | .300 .99 | DL 750 | Common Cathode | .600 2.49 |
| MAN 30 | Common Anode-Red | .300 .99 | DL 750 | Common Cathode | .600 2.49 |
| MAN 31 | Common Anode-Red | .300 .99 | DL 750 | Common Cathode | .600 2.49 |
| MAN 32 | Common Anode-Red | .300 .99 | DL 750 | Common Cathode | .600 2.49 |
| MAN 33 | Common Anode-Red | .300 .99 | DL 750 | Common Cathode | .600 2.49 |
| MAN 34 | Common Anode-Red | .300 .99 | DL 750 | Common Cathode | .600 2.49 |
| MAN 35 | Common Anode-Red | .300 .99 | DL 750 | Common Cathode | .600 2.49 |
| MAN 36 | Common Anode-Red | .300 .99 | DL 750 | Common Cathode | .600 2.49 |
| MAN 37 | Common Anode-Red | .300 .99 | DL 750 | Common Cathode | .600 2.49 |
| MAN 38 | Common Anode-Red | .300 .99 | DL 750 | Common Cathode | .600 2.49 |
| MAN 39 | Common Anode-Red | .300 .99 | DL 750 | Common Cathode | .600 2.49 |
| MAN 40 | Common Anode-Red | .300 .99 | DL 750 | Common Cathode | .600 2.49 |
| MAN 41 | Common Anode-Red | .300 .99 | DL 750 | Common Cathode | .600 2.49 |
| MAN 42 | Common Anode-Red | .300 .99 | DL 750 | Common Cathode | .600 2.49 |
| MAN 43 | Common Anode-Red | .300 .99 | DL 750 | Common Cathode | .600 2.49 |
| MAN 44 | Common Anode-Red | .300 .99 | DL 750 | Common Cathode | .600 2.49 |
| MAN 45 | Common Anode-Red | .300 .99 | DL 750 | Common Cathode | .600 2.49 |
| MAN 46 | Common Anode-Red | .300 .99 | DL 750 | Common Cathode | .600 2.49 |
| MAN 47 | Common Anode-Red | .300 .99 | DL 750 | Common Cathode | .600 2.49 |
| MAN 48 | Common Anode-Red | .300 .99 | DL 750 | Common Cathode | .600 2.49 |
| MAN 49 | Common Anode-Red | .300 .99 | DL 750 | Common Cathode | .600 2.49 |
| MAN 50 | Common Anode-Red | .300 .99 | DL 750 | Common Cathode | .600 2.49 |

IC SOLDERTAIL - LOW PROFILE (TIN) SOCKETS

8 pin \$1.17 16 pin \$1.18 24 pin \$1.18 28 pin \$1.18 36 pin \$1.18 40 pin \$1.18

14 pin \$2.27 20 pin \$2.27 24 pin \$2.27 28 pin \$2.27 36 pin \$2.27 40 pin \$2.27

16 pin \$3.20 24 pin \$3.20 28 pin \$3.20 36 pin \$3.20 40 pin \$3.20

16 pin \$4.45 24 pin \$4.45 28 pin \$4.45 36 pin \$4.45 40 pin \$4.45

16 pin \$5.45 24 pin \$5.45 28 pin \$5.45 36 pin \$5.45 40 pin \$5.45

16 pin \$6.45 24 pin \$6.45 28 pin \$6.45 36 pin \$6.45 40 pin \$6.45

16 pin \$7.45 24 pin \$7.45 28 pin \$7.45 36 pin \$7.45 40 pin \$7.45

16 pin \$8.45 24 pin \$8.45 28 pin \$8.45 36 pin \$8.45 40 pin \$8.45

16 pin \$9.45 24 pin \$9.45 28 pin \$9.45 36 pin \$9.45 40 pin \$9.45

16 pin \$10.45 24 pin \$10.45 28 pin \$10.45 36 pin \$10.45 40 pin \$10.45

16 pin \$11.45 24 pin \$11.45 28 pin \$11.45 36 pin \$11.45 40 pin \$11.45

16 pin \$12.45 24 pin \$12.45 28 pin \$12.45 36 pin \$12.45 40 pin \$12.45

16 pin \$13.45 24 pin \$13.45 28 pin \$13.45 36 pin \$13.45 40 pin \$13.45

16 pin \$14.45 24 pin \$14.45 28 pin \$14.45 36 pin \$14.45 40 pin \$14.45

16 pin \$15.45 24 pin \$15.45 28 pin \$15.45 36 pin \$15.45 40 pin \$15.45

16 pin \$16.45 24 pin \$16.45 28 pin \$16.45 36 pin \$16.45 40 pin \$16.45

16 pin \$17.45 24 pin \$17.45 28 pin \$17.45 36 pin \$17.45 40 pin \$17.45

16 pin \$18.45 24 pin \$18.45 28 pin \$18.45 36 pin \$18.45 40 pin \$18.45

16 pin \$19.45 24 pin \$19.45 28 pin \$19.45 36 pin \$19.45 40 pin \$19.45

16 pin \$20.45 24 pin \$20.45 28 pin \$20.45 36 pin \$20.45 40 pin \$20.45

16 pin \$21.45 24 pin \$2

“The PDP-8 is an old warhorse which should be put out to pasture.”

sophistication is where you find it. The 8080 is far more sophisticated than the PDP-8 so if one needs a capable computer, regardless of the imputed applications intent of the designers, the 8080 is better than the PDP-8 hands down.

The PDP-8 was truly a marvel for its time and for this DEC deserves great praise. However, the PDP-8 is an old warhorse which should be put out to pasture. A group within DEC's environs realized the PDP-8 was over the hill so they broke away from Data General and made the NOVA which was a vast improvement, conceptually, over the PDP-8. But now the original NOVA and its replacement the SUPERNOVA are both also over the hill, eclipsed if you please, by later innovations. The DEC people felt the hot winds of change blowing on their collective necks so they developed the PDP-11 (no doubt partly in reaction to the success of the NOVA which is a mighty fine little computer except for the possibility it is somewhat wasteful in its utilization of memory address space). But it is not my purpose to discuss the PDP-11.

It is fantastic that Mr Nelson claims the PDP-8 is easy to understand from a software standpoint. It is not all that difficult to understand, but he must have meant that the PDP-8 is easy to understand when compared with other computers. The PDP-8 is not a “clean” machine — it has some complications that are needlessly tedious when compared with a classic von Neuman computer such as the IBM 7090 (the 7090 was somewhat larger than the PDP-8). The so-called microinstructions are enough to drive a beginner right up the wall. The 8080 has its little complications; but, if desired, one could select a subset of the 8080 instructions [*Such as Charles Howerton used in his July 1976 BYTE article on page 22*] which if used for comparison with the PDP-8 would be both simpler and more powerful than the PDP-8. Many complications in programming have to do with addressing. Compared to the pain of addressing on a PDP-8, addressing in the 8080 could not be easier. Addressing only 4 K on the PDP-8 requires 24 bits: 12 bits for the instruction and another 12 bits for an indirect address vector. The poor little 8080 “industrial controller” directly addresses 64 K in the same 24 bits.

Mr Nelson says the PDP-8 has a “convenient parallel word length of 12 bits.” Convenient for what? The only thing I can think of is a 12 bit A to D converter or reading all 12 levels of a punched data card. One hardly needs 12 bits for an operation code (8 bits allows 256 possible operations)

and 12 bits is a short and limited address field. In the “olden” days, before ASCII, the 12 bit word could hold two characters at 6 bits each, but that is ancient history.

The autoindexing locations in octal 0010 to 0017 are kind of cute. The Data General NOVA extended this concept to also allow auto decrement locations, but neither the auto increment or auto decrement locations are used very much these days because no program is really quite sure they are not used by some other program which leads to the consequence that they are not used by anyone. In a sense, the NOVA was an extension of the PDP-8 in concept, but the NOVA people should have looked elsewhere for inspiration.

Now for some fundamental theory. Mr Nelson points out that instructions can be manipulated and data words can be executed, concerning which he says, “Software people will recognize this convenience.” Convenience my foot — this is a bucket of worms. Before the invention of index registers and indirect addressing, this was the only method available for instruction modification. Very few modern programmers play such games with instructions because it unduly complicates on line debugging and prevents a program being written as “pure procedure.” A program consists of pure procedure when it *never* changes any location that is peculiar to (is assigned to) the procedure block itself. Such a program has the virtue that it can be placed into read only memory (ROM, PROM or EROM) or protected programmable memory. A conventional PDP-8 program cannot be written as pure procedure because the return vector from a subroutine is always stored into the first location of the subroutine. This is the classic subroutine linkage and is how it was done on most computers for many years. Thus, it follows that the PDP-8 and read only memory do not get along together.

The interrupt structure of the PDP-8 (and the NOVA) is quite crude when compared with most modern computers (maxi, mini, and micro). The PDP-11 has a particularly nice vectored interrupt structure.

I think that the article by Mr Nelson is an excellent example of the smoke screen that is thrown up when discussing a machine that is quite deficient in terms of registers. He mentions the multiplexer (DX) register and the temporary register (TEMP) that are absolutely unavailable to you in any sense; but, when thrown in with the “real” registers, it seems to up the count. He also includes features common to all CPUs such as the PC, MAR, IR and the ALU which is not a register anyway.

World's Lowest IC Prices

TTL

| | | | |
|-------|------|-------|------|
| 7400 | 14 | 74151 | 60 |
| 7402 | 14 | 74157 | 60 |
| 7404 | 16 | 74160 | 75 |
| 7410 | 14 | 74161 | 75 |
| 7420 | 14 | 74163 | 75 |
| 7427 | 25 | 74165 | 80 |
| 7438 | 25 | 74173 | 1.25 |
| 7440 | 14 | 74174 | 75 |
| 7445 | 45 | 74175 | 75 |
| 7447 | 65 | 74177 | 70 |
| 7450 | 14 | 74180 | 80 |
| 7451 | 14 | 74181 | 1.50 |
| 7473 | 22 | 74191 | 1.00 |
| 7474 | 23 | 74192 | 70 |
| 7493 | 50 | 74193 | 70 |
| 7495 | 49 | 74198 | 1.00 |
| 74107 | 29 | 9602 | 50 |
| 74116 | 1.00 | 9300 | 75 |
| 74123 | 50 | 9312 | 70 |
| 74150 | 60 | | |

SCHOTTKY

| | | | |
|--------|------|--------|------|
| 74S02 | 25 | 74S172 | 3.50 |
| 74S37 | 40 | 74S175 | 1.50 |
| 74S85 | 2.00 | 74S181 | 3.50 |
| 74S139 | 1.50 | 74S197 | 1.50 |
| 74S140 | 50 | 74S257 | 1.50 |
| 74S153 | 2.50 | | |

HIGH SPEED

| | | | |
|-------|----|--------|----|
| 74H00 | 20 | 74H51 | 20 |
| 74H01 | 20 | 74H52 | 20 |
| 74H04 | 20 | 74H74 | 40 |
| 74H10 | 20 | 74H103 | 50 |
| 74H11 | 20 | 74H106 | 50 |
| 74H40 | 20 | | |

LOW POWER SCHOTTKY

| | | | |
|---------|------|---------|------|
| 74LS00 | 25 | 74LS164 | 1.50 |
| 74LS02 | 25 | 74LS174 | 1.50 |
| 74LS10 | 25 | 74LS175 | 1.50 |
| 74LS73 | 40 | 74LS193 | 1.50 |
| 74LS75 | 50 | 74LS251 | 1.50 |
| 74LS151 | 85 | 74LS253 | 1.50 |
| 74LS153 | 95 | 74LS257 | 1.50 |
| 74LS157 | 1.50 | 74LS258 | 1.50 |
| 74LS163 | 1.50 | | |

CMOS

| | | | |
|------|----|------|----|
| 4001 | 16 | 4027 | 40 |
| 4002 | 16 | 4028 | 60 |
| 4006 | 90 | 4030 | 35 |
| 4007 | 16 | 4040 | 95 |
| 4008 | 70 | 4042 | 60 |
| 4011 | 16 | 4043 | 75 |
| 4012 | 16 | 4044 | 70 |
| 4013 | 35 | 4049 | 38 |
| 4015 | 80 | 4050 | 38 |
| 4016 | 35 | 4066 | 65 |
| 4019 | 70 | 4068 | 35 |
| 4020 | 90 | 4069 | 16 |
| 4021 | 95 | 4071 | 16 |
| 4023 | 16 | 4073 | 16 |
| 4024 | 75 | 4075 | 16 |
| 4025 | 20 | 4516 | 85 |
| | | 4585 | 85 |

LINEARS

| | |
|--------|------|
| NE555V | 43 |
| NE556A | 90 |
| 741V | 30 |
| 1458V | 52 |
| 566V | 1.25 |
| 567V | 1.35 |
| 540L | 2.00 |

RAMS

| | |
|------|------|
| 2102 | 1.50 |
|------|------|

PROMS

| | |
|------------|------|
| 82S23 S123 | 1.95 |
|------------|------|

Order Minimum \$10.00 Add \$1.00 shipping and handling charge per order California residents add 6% sales tax All orders shipped promptly

Order the famous lasis 6 volume Programmed Learning Course "Microcomputer Design is a Snap" for \$99.50 and receive a special \$10.00 credit on any group of IC's.

Satisfaction 100% guaranteed.

(C.O.D. Orders: Phone (day or night) 408/354-1448

ELTRON

PO Box 2542 B
Sunnyvale, CA 94087

A virtue of the PDP-8 which must be admitted is the large amount of software that has been written for it. Considering that practically none of it may be placed into ROM, this treasure trove is of little value unless you have it on disk or other fast mass storage device. Now you are beginning to talk the kind of bucks that would be better spent for a more effective computer. It is not nice for me to say it, but this vast store of freely available software contains a heck of a lot of junk that would be more trouble to understand and get working than it is worth. You obviously need systems programs like an editor, assembler, and a debug executive, but beyond these you need little more. These should properly be supplied by the manufacturer anyway!

Contrary to Mr Nelson, I say the PDP-8 or its near equal the IM6100 are not at all the "ideal machine for the computer hobbyist." If you could "fall in" and get one for nothing, then take it, but for your hard earned bucks — no way man.

Webb Simmons
1559 Alcala Pl
San Diego CA 92111

There are two sides of every coin, and we

print your letter to give an example of a critique which might be made. Does anyone else have some information or opinions to contribute on the basis of personal experience with PDP-8s?

Digital Equipment Corporation is the source of a whole industry, the minicomputer industry, and the PDP-8 is historically the first successfully marketed minicomputer. (Successfully is defined here as widely sold and installed.) All present microcomputer work owes its heritage to the earlier minicomputer industry and indirectly to Digital Equipment Corporation and the PDP-8.

We caution readers that just as Robert Nelson may be a bit pro-PDP-8 in his recent two part article, the above letter represents and emphasizes the other side of the coin. An important item to remember in forming your own opinion about the matter is that virtually any machine with the characteristics of programmability can be used in the small computer systems context. If you are having a race to see who is the fastest, who uses the least memory, who has the best software development systems, etc, then differences in the design and history of a computer architecture will enter into the decision.

BYTE T-shirts are here!



At last! No more wardrobe crises! BYTE T-shirts are here! Now you have the perfect garb for computer club meetings, Altair Conventions, playing Shooting Stars and computer chess. (A pair of trousers from your own closet is suggested as an addition to the BYTE T-shirt. The Bytique can't do everything for you.)

BYTE T-shirts are of top quality 100% cotton or cotton-polyester. The original design, by artist Judy Lee Rehling, is silk screened in red on white shirts with blue trim on collars and sleeves, or on blue heather shirts. Each shirt is mailed first class for safe, rapid delivery to you.

The \$5 price includes handling and first class postage.

Send to: _____ In unusual cases, processing may exceed 30 days.

The Bytique

PO Box 274

Jaffrey Center NH 03454

Please send me extra large blue heather
 large white with blue trim and
 medium red letters
 small T-shirts @ \$5 each (includes handling and first class postage)

Total enclosed \$ _____

Bill MasterCharge No. _____ Exp. Date _____

Bill BankAmericard No. _____ Exp. Date _____

Name _____

Address _____

City _____ State _____ Zip _____

Signature _____

Other colors, styles I'd like to see _____



TOUCH TONE PARTS KIT

Basic kit of parts for building touch tone generator. Includes MC14410P touchtone chip, 12 key Chomerics keyboard plus 1 MHz crystal. Comes with a set of applications showing typical circuits.

All three components \$16.95

MC14412 UNIVERSAL MODEM CHIP

MC14412 contains a complete FSK modulator and de-modulator compatible with foreign and USA communications. (0-600 BPS)

FEATURES:

- .On chip crystal oscillator
- .Echo suppressor disable tone generator
- .Originate and answer modes
- .Simplex, half-duplex, and full duplex operation
- .On chip sine wave
- .Modem self test mode
- .Selectable data rates: 0-200
0-300
0-600

- .Single supply
VDD=4.75 to 15VDC - FL suffix
VDD=4.75 to 6 VDC - VL suffix

TYPICAL APPLICATIONS:

- .Stand alone - low speed modems
- .Built - in low speed modems
- .Remote terminals, acoustic couplers

| | |
|----------------------|---------|
| MC14412FL..... | \$28.99 |
| MC14412VL..... | \$21.74 |
| 6 pages of data..... | .60 |

Crystal for the above.....\$4.95

MC14411 BIT RATE GENERATOR.

Single chip for generating selectable frequencies for equipment in data communications such as TTY, printers, CRT's or microprocessors. Generates 14 different standard bit rates which are multiplied under external control to 1X, 8X, 16X or 64X initial value. Operates from single +5 volt supply. MC14411..... \$11.98
4 pages of data..... .40
Crystal for the above..... \$4.95

REMOTE CONTROL TRANSMITTER. MC14422P is a 22 channel ultra-sonic remote control transmitter I.C. CMOS uses little power and only a few external passive components. Applications include TV receivers, security controls, toys, industrial controls and locks. 16 pin DIP plastic pkg. MC14422P..... with specs.....\$11.10

BRAND NEW!!! Monsanto 7-segment LED readouts! Common anode, .27" character height. Same size as the famous MAN-1. Still packaged in original factory blister strips. MAN-52(green) or MAN-82(yellow)\$1.29.10/\$11

4 DIGIT COUNTER. MM74C926 is a 4 digit counter with 7 segment output. Carry output for cascading and internal display select allows outputting of counter or set of internal latches. 3 to 6V operation. Great for clocks, event and frequency counters. MM74C926 - with spec sheet.....\$12.00

3 DECADE (BCD) COUNTER CHIP
MC14553BCP consists of 3 negative edge triggered synchronous counters, 3 quad latches and self scan multiplexed, TTL compatible outputs.
MC14553BCP.....\$8.72
Spec sheets.....\$.60

TELETYPE CODE CONVERSION CHIP
MM5220BL converts 5 level Baudot into 8 level ASCII. Use this chip to make your old TTY talk to your new computer. MM5220BL.....\$18.00
Specs for the above..... .30

MOS TIME BASE KIT.
Only 1" X 1.5". Input 5 to 15 VDC, output is 60HZ square wave for portable or mobile clocks. PC board is drilled! MTBK-60HZ.....\$5.88



AMP LANNY

Says

PROJECT HEXED???

If mailing fees and poor service have got you spooked, and looking for those new devices is goblin up your project time, and you don't know witch way to turn-let the cats at TRI-TEK help!!!!!!!!!!!!!!!!!!!!!!!!!!!!



GOLD CHIP

Linear Integrated Circuits

Brand new process by RCA in which the aluminum metalization has been replaced by gold. The chip is then hermetically sealed. What this means to you is unprecedented reliability and uniformity. Plastic parts that meet mil specs!! Tri-Tek is proud to be the first to bring this new level of performance to you at SURPLUS PRICES. Why buy regrades??

- CA301A..Improved,general purpose op-amp,8 pin dip..59c
- CA307...Super 741 op-amp. 8 pin dip.....52c
- CA324...Compensated quad op-amp, 14 pin dip....\$1.80
- CA339A.. Low offset quad comparator. 14 pin dip...\$1.59
- CA741C..Famous general purpose op-amp, 8 pin dip.. 45c
- CA747C..General purpose dual op-amp, 14 pin dip... 82c
- CA748C..Externally compensated 741, 8 pin dip.....49c
- CA1458..General purpose dual op-amp. 8 pin dip..... 69c
- CA3401..Quad single supply (5-18V) op amp. 14 pin.. 89c

Another super buy from RCA. CA555 timer. 8 pin dip. 59c

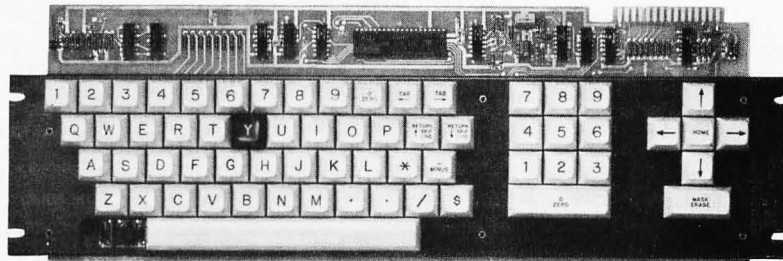

ALPHA-NUMERIC KEYBOARD

Made by Licon for Motorola Data Systems. Includes full upper case alpha and numeric with separate numeric and cursor control pads. Self scanning with ROM encoder. These beautiful keyboards are modern design and recent manufacture. Outputs are TTL compatible and have open collector buffers with resistive pull-ups. Encoding is in ASCII with some special control codes. Code table is supplied. There are only a few of these high quality KB's and at our price they wont last long.... \$39.95

NEW!

DATA BOOKS BY NATIONAL SEMICONDUCTOR DIGITAL. Covers TTL, DTL, Tri-State, etc. \$3.95
LINEAR. Covers amplifiers, pre-amps, op-amps, .. \$3.95
LINEAR APPLICATIONS. Dozens of application notes and technical briefs covering the use of op-amps, regulators, phase locked loops and audio amps..... \$3.25
CMOS Gates, Flip Flops, registers, functional blocks \$3
VOLTAGE REGULATORS. A must for anyone making a power supply. Complete theory including transformers, filters, heat sinks, regulators, etc..... \$3.00
MEMORY. Information on MOS and Bipolar memories: RAMS, ROMS, PROMS and decoders/encoders. . . \$3.95
INTERFACE. Covers peripheral drivers, level translators, line driver/receivers, memory and clock drivers, sense amps display driver and opto-couplers..... \$3.95 (Outside U.S., add postage for 1.5lbs)

SPECIAL FUNCTIONS DATA BOOK contains detailed information for specifying and applying special amplifiers, buffers, clock drivers, analog switches and D/A-A/D converter products.....\$3.25
AUDIO HANDBOOK contains detailed discussions, including complete design particulars, covering many areas of audio with real world design examples...\$3.25

NI-CAD BATTERIES. Battery pack of 5 cells. Delivers 6.25V @ 500mAH. Wire leads. These are brand new and fresh!!! NCB-6252..... \$3.25, 4 pks,\$12.00

T.V. CLOCK CHIP SET. MM5318/5841 two chip set forms basis for time of day display on your TV screen. Interesting and convenient way to keep time.
MM5318/5841 Set.....\$22.45.....Specs.....\$1.00

D-A CONVERTER BY ZELTEX
8 bit precision hybrid circuit for use in controllers, timers, volt meters, etc. Molded plastic package with P.C. pins. Super buy on this better than usual subsystem. ZELTEX model ZD430. DAC-430.....\$4.95

PRECISION REFERENCE AMP.
LH0070-1H provides a precise 10.0 volts for use in BCD A to D converters or meter calibrators. Typical initial accuracy is .3% (± .03V). Comes in TO-5 can.
LH0070-1H.....with specs.....\$5.35



TRI-TEK, INC.

6522 NORTH 43RD AVENUE.
GLENDALE, ARIZONA 85301
PHONE 602 - 931-6949

We pay shipping on all orders over \$10 US, \$15 foreign in US funds. Orders under \$10, please add \$1 handling. Please add insurance. Master Charge and Bank America cards welcome, (\$20 minimum). Telephone orders may be placed 11AM to 5PM daily, Mon thru Fri. Call 602-931-4528. Check reader service card or send stamp for our latest flyers packed with new and surplus electronic components.

BYTE

reader service

To get further information on the products advertised in BYTE, fill out the reader service card with your name and address. Then circle the appropriate numbers for the advertisers you select from this list. Add a 9 cent stamp to the card, then drop it in the mail. Not only do you gain information, but our advertisers are encouraged to use the marketplace provided by BYTE. This helps us bring you a bigger BYTE.

- A116 Action Audio Electronics 121
- A70 American Microprocessors 113
- A107 Audio Design Electronics 113
- A111 Brigar 137
- A120 Burkeshire 111
 - BYTE's Back issues 136
 - BYTE's Books 63, 105, 114
 - BYTE's Subs 138
 - BYTE's T-Shirts 142
- A37 Celdat 104
- A126 Cheap, Inc. 115
- A127 Comptek 121
- A83 Computer Mart of NY 113
- A87 Creative Computing 117, 125
- A41 Cromemco 1
- A125 DEC 11
- A7 Delta 135
- A78 Digital Group 15
- A47 Electronic Control Tech. 121
- A102 Eltron 141
- A9 Godbout 123
- A109 iCOM 69
- A67 IEEE 25
 - * IMS 8, 35
- A117 Intel 21
- A38 ISC 91
- A15 James 128, 129, 139
- A130 JGM Development Labs 121
- A122 John Anthony TV 115
- A90 Logical Services 121
- A132 M & R Enterprises 71
- A124 McGraw Hill 27
- A18 Meshna 127
- A93 Micon 107
- A71 MPI 117
- A 133 Micro Software
- A77 Micro-Term 103
- A119 Midwestern Scientific Inst. 58, 59
- A57 Mikos 95
- A112 MiniTerm 67
 - * MITS CIV, 3, 4, 5, 6, 19, 23, 24, 39, 40, 97, 98, 101
- A134 Nash 113
- A22 National Multiplex 93
- A129 Newman Computer Exchange 121
- A40 Ohio Scientific Inst. 29
- A64 Oliver Audio Engineering 113
- A63 Parasitic 80, 109
- A85 Per Com Data 41
- A23 Polymorphic Systems 65
- A24 Processor Technology 72, 73
- A131 Small Business Systems 113
- A26 Scelbi 17
- A27 SD Sales 131
- A59 Solid State Sales 133
- A29 Southwest Tech. CII
- A30 Sphere CIII
- A99 STM Systems 109
- A96 Synchro Sound 50, 51
- A121 Tarbell Elec. 111
- A82 Technical Design Labs 61
- A32 Tri-Tek 143

*Reader service inquiries not solicited. Correspond directly with company.

BOMB

BYTE's Ongoing Monitor Box

Feedback is what keeps a linear amplifier in line. Like a linear amplifier, BYTE can use a bit of feedback. The BOMB analysis is done once a month to provide encouragement to authors and some formal feedback on how readers appreciate articles. BYTE pays the winning author a \$50 bonus, so you can encourage the authors you like by voting your preferences. Remember that with few exceptions BYTE authors are just readers who have sat down at their typewriters to tell a story about what they've done or what they know about some aspect of this technology.

BOMB Results for July

Results of the BOMB survey for the July BYTE were as follows: First place winner was James R Jones, for his article "Coincident Current Ferrite Core Memories." The runners-up were tied: Bob Baker, for "Put the 'Do Everything' Chip in Your Next Design" and Richard J Lerseth for "A Plot Is Incomplete Without Characters." Who'll win the August BOMB? Find out next month. Who'll win the October BOMB? You can affect the course of events by supplying a personal evaluation of this issue's articles. Watch for the tally in January's BYTE. ■

| PAGE | ARTICLE | LIKED | | | | | | | | | | |
|------|--|-------|---|---|---|---|---|---|---|---|---|------|
| | | LEAST | 1 | 2 | 3 | 4 | 5 | 6 | 7 | 8 | 9 | BEST |
| 12 | Hickey: Computer. . .vs. . .Hand Sent Morse Code | 0 | 1 | 2 | 3 | 4 | 5 | 6 | 7 | 8 | 9 | 10 |
| 26 | Hosking: A Ham's Application Dreams | 0 | 1 | 2 | 3 | 4 | 5 | 6 | 7 | 8 | 9 | 10 |
| 30 | Grappel-Hemenway: Add This 6800 Morser. . . | 0 | 1 | 2 | 3 | 4 | 5 | 6 | 7 | 8 | 9 | 10 |
| 36 | Krakauer: Efficient Storage. . . | 0 | 1 | 2 | 3 | 4 | 5 | 6 | 7 | 8 | 9 | 10 |
| 42 | Sewell: If Only Sam Morse Could See Us Now | 0 | 1 | 2 | 3 | 4 | 5 | 6 | 7 | 8 | 9 | 10 |
| 52 | Filgate: Morse Code Station Data Handler | 0 | 1 | 2 | 3 | 4 | 5 | 6 | 7 | 8 | 9 | 10 |
| 74 | Guthrie: Mathematical Function Unit—Part 2 | 0 | 1 | 2 | 3 | 4 | 5 | 6 | 7 | 8 | 9 | 10 |
| 82 | Baker: Keep PACE with the Times | 0 | 1 | 2 | 3 | 4 | 5 | 6 | 7 | 8 | 9 | 10 |
| 90 | Fylstra-Wilber: Homebrewery vs Priesthood | 0 | 1 | 2 | 3 | 4 | 5 | 6 | 7 | 8 | 9 | 10 |
| 118 | Douds: Meeting Activities. . . | 0 | 1 | 2 | 3 | 4 | 5 | 6 | 7 | 8 | 9 | 10 |

M 6800

CRT'S PDQ only \$149

Compatible with

Motorola Evaluation Kits

SWT Kits

Cramer Kits

With a CRT interface module from Sphere you can communicate with your computer . . . PDQ! No fooling around with blinking lights, you get up to 32 characters by 16 lines of instant display on your television set or video monitor.

The Sphere CRT module interfaces to your Motorola 6800 product with easy to connect flat ribbon cable bus through 16 lines of address bus, 8 lines of data bus, the VMA, the phase #2 clock and the read/write port.

Mail this coupon today for your CRT PDQ - OK!

Please send me _____ Sphere CRT interface kits.
Enclosed Check/Mastercharge/BankAmericard

Amount \$ _____ Card No. _____

Name _____

Address _____

City _____ State & Zip _____

Limited offer, prices subject to change • Allow up to 30 days for delivery.

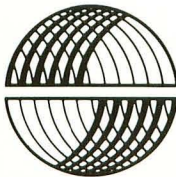

SPHERE
CORPORATION

Distributorships
Available

Dept. 104 P. O. Box 213 Bountiful, Utah 84010 (801) 292-8466

The small wonder

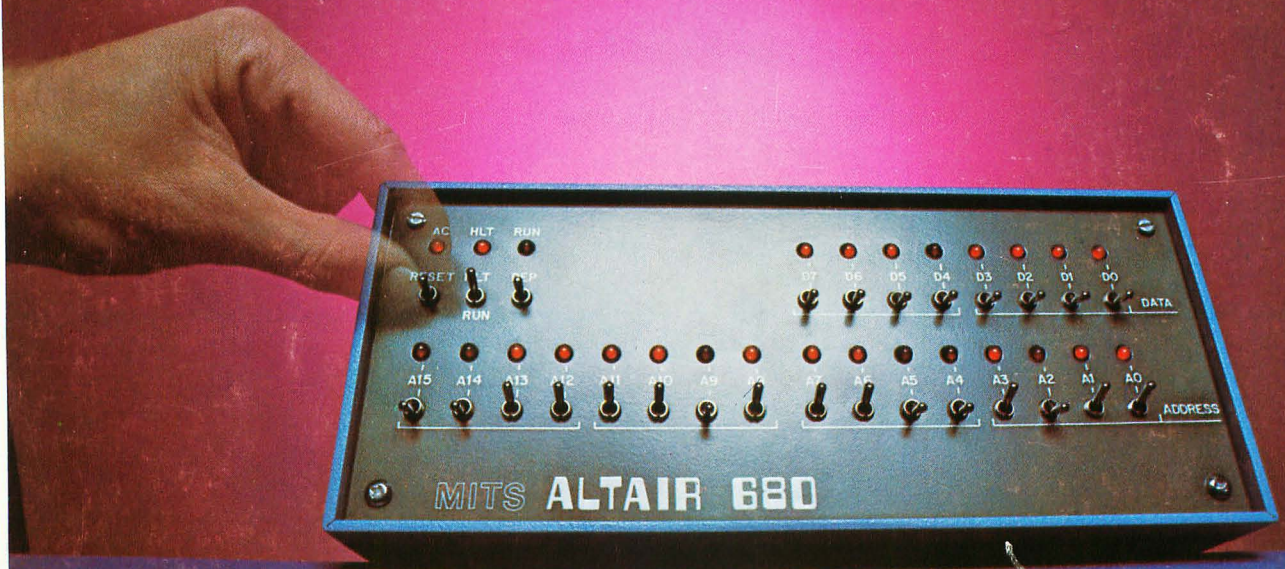

of the micro-world

Measuring just 11" wide x 11" deep x 5" high, and weighing a mere 7 pounds, the Altair™ 680b is a complete, general-purpose computer.

The secret to this revolutionary, small computer is its CPU board. This double-sided board fits along the bottom of the Altair case and plugs directly into the front panel board. It contains the new 6800 microprocessor, 1,024 bytes of RAM memory, a 256 byte PROM monitor, provisions for 768 bytes of additional PROM or ROM, and a single Interface port with a Motorola ACIA serial interface adapter which can be configured either RS-232 or TTY. A five level Baudot interface option is also available.

The Altair 680b can be programmed from front panel switches, or it can be interfaced to a video display terminal, or teletypewriter. Three additional circuit boards can be plugged inside the Altair 680b for further memory and interface expansion. The first of these boards is a 16K static RAM memory board.

Software already developed includes Altair 680 BASIC with all the features of the 8K BASIC previously developed for the Altair 8800. These include Boolean operators, the ability to read or write a byte from any I/O port or memory location, multiple statements per line, and the ability to interrupt program execution and then continue after the examination of variable values. This software takes only 6.8K bytes of memory space and a copy is included free with the purchase of the Altair 680 16K memory board.

Other software includes a resident two pass assembler. The Altair 680b is also compatible with Motorola 6800 software.

The Altair 680b is ideal for hobbyists who want a powerful computer system at an economic price. Altair 680b owners qualify

for membership in the Altair Users Group, and like other Altair owners, they receive a complimentary subscription to **Computer Notes** and complete factory support.

PRICES:

| | |
|---|-------|
| Altair 680b kit with complete, easy-to-understand assembly manual, operator's manual, and programming manual..... | \$466 |
| Assembled Altair 680b..... | \$625 |
| Altair 680b Turnkey model kit..... | 395 |
| Expander Card 680MB (required to expand 680)..... | \$ 24 |
| Altair 680BSM 16K static RAM board kit with 680 BASIC..... | \$685 |
| Altair 680 BASIC when purchased separately..... | \$200 |
| Baudot option..... | \$ 42 |

MAIL THIS COUPON TODAY

- Enclosed is a check for \$_____
- BankAmericard # _____ or Master Charge # _____
- Altair 680b Kit Assembled Other (specify) _____
- enclose \$8 for postage and handling
- Please send free information package.

NAME _____

ADDRESS _____

CITY _____ STATE & ZIP _____



2450 Alamo SE/Albuquerque, NM 87106, 505-243-7821

NOTE: Altair is a trademark of MITS, Inc.

Price, specifications subject to change. Please allow up to 60 days for delivery.