

12490

®

JANUARY 1984 Vol. 9, No. 1
\$3.50 in US
\$3.95 in Canada/£2.10 in UK
A McGraw-Hill Publication
0360-5288

BYTE

the small systems journal

1984



FUTURE TRENDS



Inside Apple

Vol. 1, No. 4

A dot matrix printer that will improve your image.

Meet the Apple® Imagewriter, the newest dot matrix printer for your Apple Personal Computer.

And with all that it has going for it, just maybe the best dot matrix printer on the market.

Take legibility, for instance.

The Imagewriter crams 140 x 160 dots into each square inch. So you get text that's highly readable and high resolution graphics, besides.

And is it fast.

The Imagewriter cruises at an unbelievable 120 characters per second. And that's just in the text mode. It's even faster printing graphics. 180 characters per second, to be exact.

What's more, the graphics dump is up to 60% faster than other comparably priced dot matrix printers. And that makes the Imagewriter fast enough to handle the Lisa.™

Yet it's just as at home with an Apple III or Apple IIe. Thanks to Apple software experts who designed the control electronics to give the Imagewriter perfect compatibility. Not to mention some special capabilities

like superscript and subscript, to name just two.

Now, with all this high-speed performance, you'd expect the Imagewriter to make the Devil's Own Noise. It doesn't. In fact, the Imagewriter is specially constructed — with overlaid seams and special sound-deadening materials — to achieve a remarkable 53 dB. How loud is a remarkable 53 dB? You'd make more noise if you read this aloud.

The Imagewriter even has quiet good looks, since we designed it to look like the rest of the Apple Family.

Yet even with all its improvements, the Imagewriter is a better deal than any other dot matrix printer with comparable performance. And you can print that.

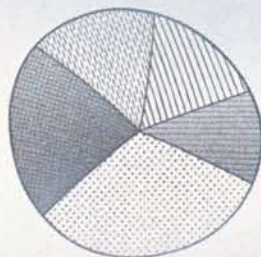

**APPLE PRESENTS THE
E IMAGEWRITER APPLE PR
ESENTS THE IMAGEWRITER APPLE PRESENT
S THE IMAGEWRITER APPLE PRESENTS THE IMAGEWRITER APPLI**

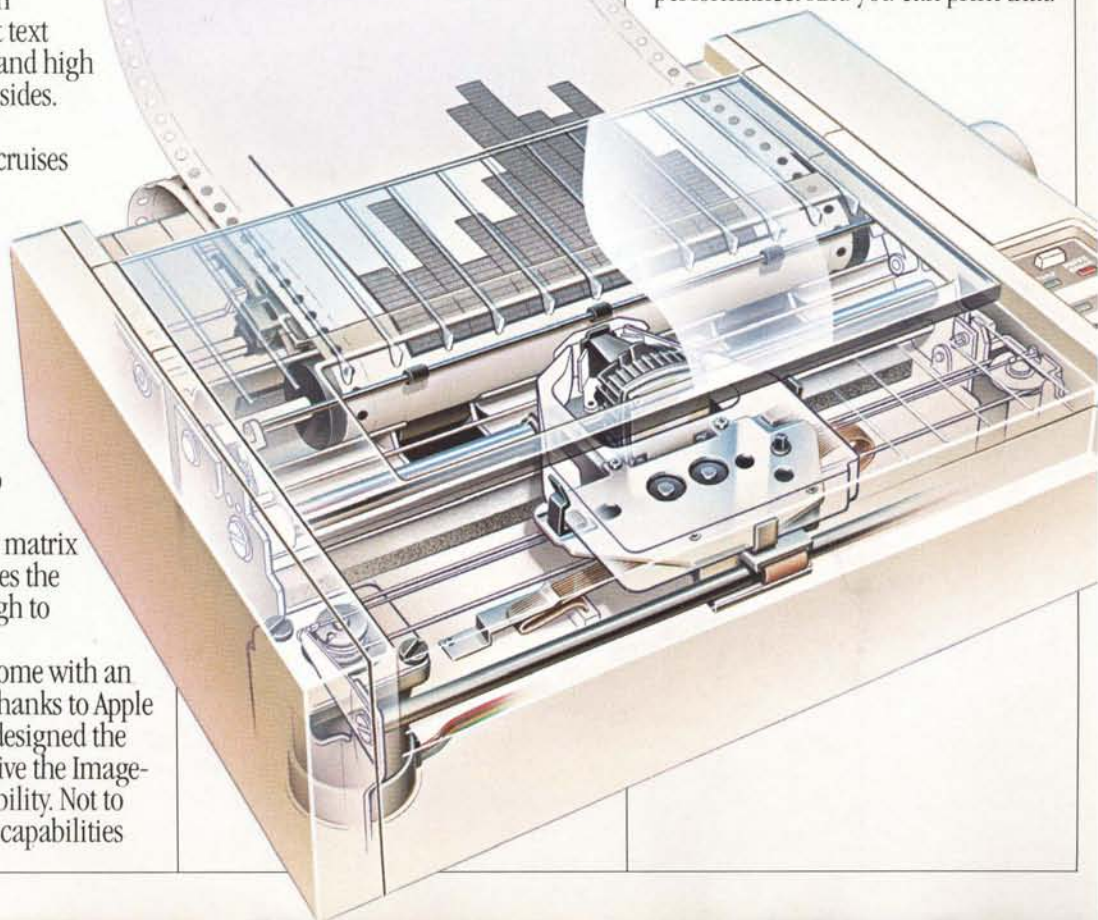



Charge!

Go out there and get the Apple Personal Computer System you really want. Now. Without laying out your extra cash. Without tying up your other lines of credit. With the Apple Card. The only consumer credit card reserved exclusively for the purchase of Apple Computers, peripherals and software.

Like all our products, it works simply:

Fill out an application (short, to the point and annotated in English) at an authorized Apple dealer honoring the Card. Your salesperson will call in the application and in most cases get an approval for you right on the spot.

You can then take your Apple system home. You don't even have to wait for the Card; we'll mail it out to you. And by the time you get it, you'll probably be well into doing whatever you bought your Apple system to do.

There is no annual fee for the Card, although a couple of restrictions do apply. The first purchase must include an Apple Personal Computer and you have to put 10% down. And subsequent purchases need to be at least \$100 if made with the Card. Oh, yes — you'll also have a credit limit.

When you use the Apple Card to make additional purchases, all you have to do is show the Card and sign the invoice. As long as it's within your credit limit, of course. Our dealers get a little nervous when someone signs for half their inventory. You understand.

You'll also receive monthly statements that include the latest purchases, credit available, and the minimum payment due. You'll also be happy to know Apple Card credit terms are affordable and the payments can be spread out. It's all

spelled out for you at the time your Card is approved.

So stop by a participating authorized Apple dealer and get an Apple Card. Just think of it as credit where credit is due.

Give your floppy disks the boot.

We call it the "floppy disk shuffle." It happens when you have two or more software programs on floppies and you need to work with both. What do you do? You put one disk in, boot it, do your work, take it out, put the other disk in, boot it, do your work — you get the idea.

Well, you can stop shuffling any time now.

Thanks to a unique new software program called Catalyst™ from Quark, Inc. Specially designed for your Apple III and ProFile™ hard disk.

Catalyst allows you to take a wide variety of software programs and store them on your ProFile. Once they're on your ProFile, you just select the program you want from the Catalyst menu that appears on your monitor — then Catalyst does the rest. You'll never have to boot those programs again.

What kinds of programs will work with ProFile and Catalyst?

Almost anything written for the Apple III including copy-protected programs like VisiCalc®, Quick File™ and Apple Writer III. Or languages like Pascal, BASIC, or COBOL.

And once you've loaded these programs into your ProFile, the only diskette you may ever need is the Catalyst.

So if you have an Apple III and a ProFile and more floppies than you care to flip through, get yourself a Catalyst. And boot those disks for good.

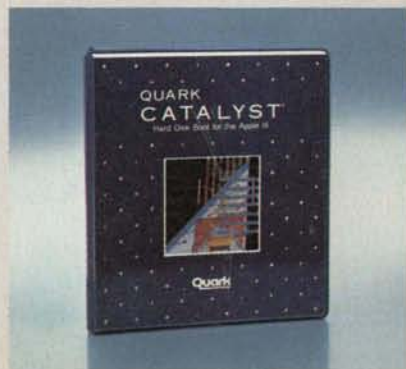

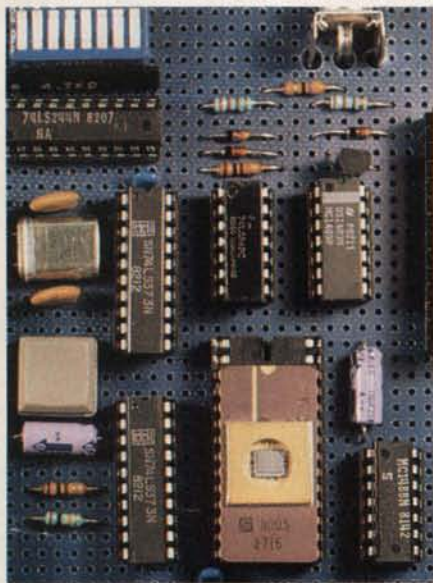

Page 37



Page 122



Page 172

Columns

37 Build the Circuit Cellar Term-Mite ST Smart Terminal, Part 1: Hardware by Steve Ciarcia / Thanks to advancing technology, you can construct an intelligent video terminal with just 21 integrated circuits.

53 BYTE West Coast: Beyond the Word Processor by Phil Lemmons / Tomorrow's text editors may facilitate text composition from the earliest conceptual stages to the analysis of finished documents.

61 User's Column: Too Many Leads, or What in *;?1#''*? Goes First? by Jerry Pournelle / Jerry covers a lot of territory this month, beginning his journey of a thousand words with a trip to the Circuit Cellar.

Themes

100 1984 and Beyond by G. Michael Vose / The year calls up inevitable associations with George Orwell's novel of a futuristic, technologically oppressed society and raises questions concerning the present and future significance of technology to our own culture.

104 Reason and the Software Bus by Michael F. Kornis / The Reason research project, exploring artificial intelligence, has developed a software bus that may have a significant effect on future software. As a hardware bus uses ICs, so the software bus manipulates various program components to provide integration, networking, and multitasking.

122 A General-Purpose Robot-Control Language by Dan Prendergast, Bill Slade, and Nelson Winkless / By bridging the communication gap between people and robots, a plain-language system called Savvy increases the usefulness of these mechanical assistants.

134 1984, the Year of the 32-bit Microprocessor by Richard Mateosian / As manufacturers rush to introduce their 32-bit designs, it's time to take a look at what these microprocessors are and what they're good for.

154 Memory Cards: A New Concept in Personal Computing by Mark Mills / Picture a microcomputer without a keyboard, without a power supply, and small enough to fit in your wallet. That's just one possible application of memory-card technology.

172 Computer-aided Design by Rik Jadrnicek / CAD capabilities on desktop systems can simplify a variety of tasks, from flowcharting to product design, but the choices in hardware and software can be baffling.

213 Speech Recognition: An Idea Whose Time Is Coming by George M. White / While the multidisciplinary nature of the technology may slow its advance, speech recognition is well on its way to becoming a major factor in our interactions with machines.

226 Using Natural-Language Systems on Personal Computers by Jane Eisenberg and Jeffrey Hill / Artificial intelligence offers possible solutions to the problems of communication between people and computers.

243 Portables—1984 and Beyond: Idea-Processing Software and Portable Computers by David Winer and Peter Winer / When your personal computer leaps off your desktop and into your briefcase, what type of software will accompany it?

251 Beyond the Application Program: A Different Approach to Integrated Software by John Banning / Element managers that implement objects such as spreadsheet tables and paragraphs may supplant the traditional concept of the application program.

Reviews

267 Reviewer's Notebook by Rich Malloy / This month's notes touch on Sequent Computer Corporation's Chameleon Plus and new trends in the printer market.

268 The Zenith Z-100 by Ken Skier / Supporting both 8-bit and 16-bit software, the Z-100 also offers impressive color graphics.

BYTE is published monthly by McGraw-Hill Inc., with offices at 70 Main St., Peterborough, NH 03458, phone (603) 924-9281. Office hours: Mon—Thur 8:30 AM — 4:30 PM, Friday 8:30 AM — Noon, Eastern Time. Address subscriptions to BYTE Subscriptions, POB 590, Martinsville, NJ 08836. Address changes of address, USPS Form 3579, and fulfillment questions to BYTE Subscriptions, POB 596, Martinsville, NJ 08836. Second-class postage paid at Peterborough, NH 03458 and additional mailing offices. USPS Publication No. 528890 (ISBN 0360-5280). Postage paid at Winnipeg, Manitoba. Registration number 9321. Subscriptions are \$21 for one year, \$38 for two years, and \$55 for three years in the USA and its possessions. In Canada and Mexico, \$23 for one year, \$42

282 Pinball Construction Set by Elaine Holden / Tired of the same old pinball games? Try creating your own with this software-design package.

288 The TRS-80 Model 16B with Xenix by Steve Barry and Randy Jacobson / One of the most significant features of Radio Shack's new computer is its Unix-derived operating system.

324 Naturallink to Dow Jones News/Retrieval by Mark Haas / A new software package from Texas Instruments simplifies access to a financial database.

339 The Vamp DVM-1 Computer/TV Interface Kit by Richard F. Gillette / The picture quality of your display can suffer when you use a radio-frequency modulator to interface your computer's video output to a standard color television, but a kit from Vamp offers an alternative.

349 The Einstein Compiler by Peter Callamaras / In addition to speeding up Apple-soft BASIC programs, the Einstein compiler provides statistical information on the programs compiled and can function as a debugging tool.

354 The Basis 108 by Seth P. Bates / Apple compatibility is just one of this German import's interesting features.

Features

362 Bubbles on the S-100 Bus, Part 1: The Hardware by Louis Wheeler / Using Intel's BPK 72 Bubble-Memory Prototype Kit, you can put together a 128K-byte bubble-memory board for an S-100 bus system.

384 Mockingbird: A Composer's Amanuensis by John Turner Maxwell III and Severo M. Ornstein / The chief purpose of this music notation editor from Xerox is to help composers capture their ideas by speeding up the notation process.

403 The VU68K Single-Board Computer by Edward M. Carter and A. B. Bonds / You can construct a 68000-based system for under \$200.

417 Translating the SAS Language Into BASIC by Jeff Bass / A preprocessor program that translates SAS-like statements into equivalent BASIC statements permits SAS-like programs to run on a microcomputer.

437 A Software Review Method That Really Works by Andrew Citron / The group walk-through, a process of "playing computer," provides a workable means of correcting programming problems.

442 Real-Time Clocks and PC-DOS 2.0 by David Broadwell / A device-driver program for the clock chip on a typical multifunction board takes advantage of special provisions in the IBM PC operating system.

Nucleus

- 4 Editorial: Revisiting the Luddites
- 9 MICROBYTES
- 14 Letters
- 451 BYTE's User to User
- 459 Ask BYTE
- 466 Software Received
- 471 Event Queue

- 476 Books Received
- 478 Clubs and Newsletters
- 480 What's New?
- 557 Unclassified Ads
- 558 BYTE's Ongoing Monitor Box, BOMB Results
- 559 Reader Service

Cover painting by Robert Tinney

for two years, \$61 for three years. \$53 for one year air delivery to Europe. 17,100 yen for one year surface delivery to Japan. \$37 surface delivery elsewhere. Air delivery to selected areas at additional rates upon request. Single copy price is \$3.50 in the USA and its possessions, \$3.95 in Canada and Mexico, \$4.50 in Europe, and \$5.00 elsewhere. Foreign subscriptions and sales should be remitted in United States funds drawn on a US bank. Printed in the United States of America.

Subscription questions or problems should be addressed to:
 BYTE Subscriber Service, POB 328, Hancock, NH 03449

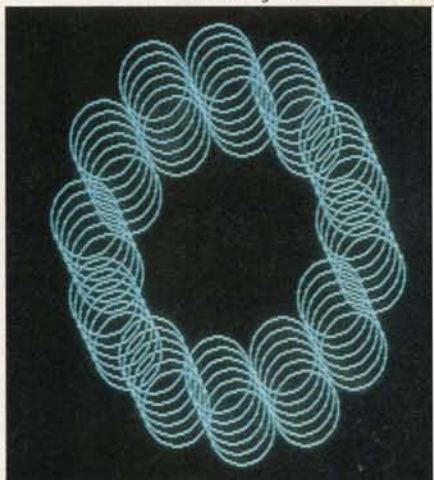

Page 268



Page 288



Page 339

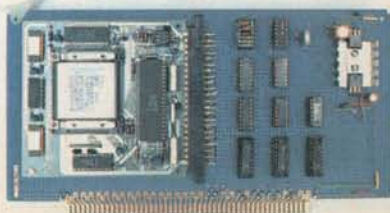

Page 362

Editor In Chief: Lawrence J. Curran

Managing Editor: Philip Lemmons

Senior Technical Editors: Gregg Williams, Richard Malloy, G. Michael Vose

Technical Editors: Richard S. Shuford, Arthur A. Little, Stanley Wszola, Bruce Roberts, Gene Smarte, Richard Krajewski, Jane Morrill Tazelaar; Anthony J. Lockwood, New Products Editor; Steve Ciarcia, Consulting Editor; Mark Welch, Staff Writer; Alan Easton, Drafting Editor.

West Coast Editors: Ezra Shapiro, Technical Editor; Donna Osgood, Assistant Editor. McGraw-Hill, 425 Battery Street, 4th Floor, San Francisco, CA 94111, (415) 362-4600

Copy Editors: Nancy Hayes, Chief; Warren Williamson, Elizabeth Kepner, Joan V. Roy, Dennis E. Barker, Anne L. Fischer, Bud Sadler, Margaret Cook

Assistants: Faith Kluntz, Beverly Jackson, Lisa Jo Steiner, Peggy Dunham

Production: David R. Anderson, Assoc. Director; Virginia Reardon, Production Manager; Jan Muller, Michael J. Lonsky, Sherry McCarthy, Chief Typographer; Donna Sweeney, Valerie Horn, Len Lorette

Advertising: Deborah Porter, Supervisor; Marion Carlson, Rob Hannings, Cathy A. R. Drew, Lisa Wozmak, Jeanne Cilley, Jeanna Reenstierna; Patricia Akerley, Reader Service Coordinator; Wai Chiu Li, Quality Control Manager; Linda J. Sweeney, Advertising/Production Coordinator

Advertising Sales: J. Peter Huestis, Sales Manager; Sandra Foster, Administrative Assistant
Circulation: Gregory Spitzfaden, Director; Andrew Jackson, Subscriptions Manager; Barbara Varnum, Asst. Manager; Agnes E. Perry, Louise Menegus, Jennifer Price, Jane Varnum, Phil Dechert, Mary Emerson; James Bingham, Single-Copy Sales Manager; Linda Turner, Asst. Manager; Carol Aho, Edson Ware

Marketing Communications: Horace T. Howland, Director; Vicki Reynolds, Coordinator; Stephanie Warnesky, Graphics Design Manager; Michele P. Verville, Research Manager

Business Manager: Daniel Rodrigues

Controller's Office: Kenneth A. King, Asst. Controller, Mary E. Fluhr, Acct. & D/P Mgr.; Karen Burgess, Linda Short, Vicki Bennett, Vern Rockwell, Lyda Clark, Janet Pritchard, JoAnn Walter, Julie Ferry, Patricia Burke

Traffic: N. Scott Gagnon, Manager; Brian Higgins, Cynthia Damato

Receptionist: Linda Ryan

Personnel/Office Manager: Cheryl A. Hurd

Associate Publisher/Production Director: John E. Hayes

Publisher: Gene W. Simpson;
Doris R. Gamble, Publisher's Assistant

Editorial and Business Office: 70 Main Street, Peterborough, New Hampshire 03458, (603) 924-9281

Officers of McGraw-Hill Publications Company: President: John G. Wrede; Executive Vice Presidents: Paul F. McPherson, Operations; Walter D. Serwatka, Finance & Services. Senior Vice President-Editorial: Ralph R. Schulz. Senior Vice President Publishers: Harry L. Brown, David J. McGrath, James R. Pierce, Gene W. Simpson, John E. Slater. Vice President Publishers: Charlton H. Calhoun III, Richard H. Larsen, John W. Patten. Vice Presidents: Kemp Anderson, Business Systems Development; Shel F. Asern, Manufacturing; Michael K. Hehir, Controller; Eric B. Herr, Planning and Development; H. John Sweger, Jr., Marketing.

Revisiting the Luddites

As 1984 dawns, only a small fraction of the general population of this nation owns or regularly operates a computer. Indeed, there is still widespread concern that the increasing encroachment of computers into daily life carries with it the threat of substantial unemployment as computers displace people on the job. We think an article that appeared last summer in the Wall Street Journal ("The Luddite Answer to Unemployment") addresses the fears of those who remain unconvinced that computers aren't threatening. The article was written by Bruce Bartlett, executive director of the Joint Economic Committee of Congress. We've reprinted it here because we think Mr. Bartlett's views deserve an even broader audience. . . . **Lawrence J. Curran, Editor in Chief**

In the early 1800s a group of British workers, concerned that the introduction of machinery was destroying jobs in the textile industry, went about destroying such machines in the hope of saving jobs. They issued proclamations in the name of the mythical King Ludd of Sherwood Forest and became known as Luddites. They still exist, although they no longer smash textile equipment. Instead, they issue dire warnings about how computers and robots are destroying jobs and will create an economic crisis unless the federal government adopts massive new programs to absorb the new unemployed.

Wassily Leontief, a Nobel laureate in economics, argues that increasing technology and automation will lower real incomes, as workers attempt to forestall technological innovation by reducing their wages. Nevertheless, he sees the tide of technology moving relentlessly onward, leaving in its wake a vast army of unemployed. Assemblyman Tom Hayden in California put the issue even more starkly:

"The economy is moving toward dependence on machines instead of human labor as a means of producing goods in each plant, and toward high-technology, capital-intensive in-

dustries in place of older, established craft or labor-intensive processes. As this 'progress' rolls on, fewer and fewer jobs are created per dollar invested. Each recovery from recession involves a greater investment of capital in expensive, high-tech industry, and this in turn makes greater unemployment a growing likelihood."

Echoing the Line

There is, of course, not a scrap of evidence in either theory or history to suggest that technological development won't increase employment and real incomes today just as it always has. Those who suggest otherwise are just echoing the Luddite line.

One can go back as far as Adam Smith for evidence. In the first chapter of "The Wealth of Nations" Smith tells his famous story about the pin factory where a single worker without machinery "could scarce, perhaps, with his utmost industry, make one pin in a day, and certainly could not make twenty." But with the introduction of machinery a single worker could make as many as 4,800 pins a day. Given the number of pinmakers in England at that time and the demand for pins, such machinery should have created about 99% un-

How Cromemco plugs you into the state of the art.

Cromemco offers you the most complete line of S-100 boards and peripherals in the business. These boards use the new IEEE-696 state-of-the-art standard. One-stop shopping can satisfy your design needs the easy way.

You can build one system, or a hundred, exactly the way you want, and upgrade existing systems with a simple board swap or addition. And since we design our own boards for our own systems, we always take advantage of the latest developments in IC technology.

68000 microprocessor performance. Cromemco's Dual Processor Unit gives you the best of both worlds: the

68000 and the Z-80A microprocessors on the same board. It's the easiest way to move into 68000 performance and still use your existing 8-bit software. Or use Cromemco's Z-80A CPU board or our Z-80A-based single board computer.

For selection, Cromemco can't be matched. From the well-known SDI High Resolution Color Graphics board to the new 512MSU, 512K byte RAM board. From our highly reliable Local Area Network interface (C-NET) to our wide variety of general purpose interface boards. And you can put them in one of our 8-, 12-, or 21-slot card cages with our 12 amp PS-8 power supply to get your system into operation fast.

We have over 30 S-100 boards to fill your needs. And all are supported by a broad line of software. Our Board Products Catalog has the latest information. Call today for your copy, or to get the name of our nearest dealer or distributor. Or, write Cromemco, Inc., 280 Bernardo Avenue, P.O. Box 7400, Mountain View, CA 94039. Tel: (415) 964-7400. In Europe: Cromemco A/S, Vesterbrogade 1C, 1620 Copenhagen, Denmark.

In the U.S., contact your local Hall-Mark or Kierulff distributor.

Cromemco

Circle 119 on inquiry card.

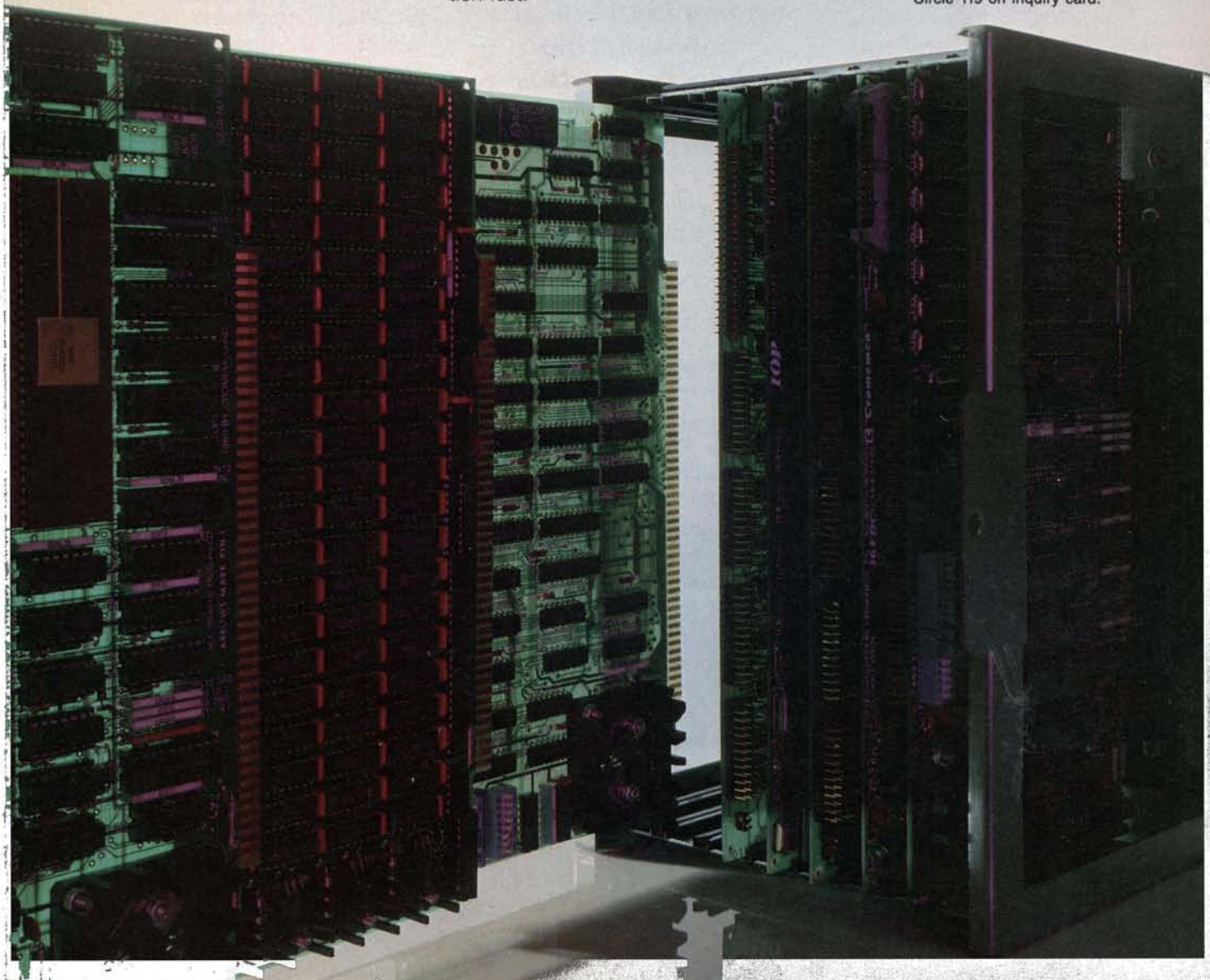

employment in the pinmaking industry. Obviously it did not because the vast increase in pinmaking productivity resulting from mechanization so lowered the cost of making pins that new uses for them were discovered. Moreover, the increased real income of those who previously used high-cost, handmade pins increased demand for other products and gave rise to employment in other industries, not the least being makers of machines for pinmaking.

Another aspect of the new Luddite argument is that rising productivity is not altogether a good thing. As Robert Kuttner asks in *The Atlantic*, "What would happen if all the physical goods were produced by robots? The one worker who flipped the switch would boast astronomically high productivity. What should he be paid? And what would everyone else do for a living?" Somewhat along these same lines I have heard members of Congress express concern that if productivity rises too rapidly in the current recovery more output will be achieved without reducing unemployment.

Again, the flaw is static analysis—assuming that things won't change, that technology and automation won't change relative prices or incomes, that the economy will essentially continue to produce the same goods in the same quantities only using less labor.

One might respond by asking what our economy would look like without rising productivity. In 1910 the Bell System had 121,310 employees. Approximately 7 million calls were placed that year, or 57 per employee. In 1981 the Bell System had 874,000 employees, who serviced over 219 billion calls. Had there been no increase in productivity since 1910 it would have required close to 4 billion employees to service that many calls. The result, of course, has been that telephones are widely available and calls can be made at very modest cost compared with 1910. This has given rise to vast numbers of jobs in every industry which simply couldn't exist

without efficient, inexpensive phone service.

While it may be obvious in the long run that rising productivity and technological innovation create more jobs than they destroy, might there still be short-run adjustment problems to consider? According to two British researchers, J. D. Whitley and R. A. Wilson, who studied the employment effects of technological change in the British microelectronics industry, probably not. They identify interrelated factors that contribute to overestimates of employment loss from new technology.

**'Those who dwell
on the apparent
adverse effects of
technological change
on employment are
only creating
unnecessary fear
and anguish among
workers...'**

First, people tend to overgeneralize from particular case studies. It might seem obvious that a firm employing 10 secretaries that could get the same work from one with a word processor would then lay off nine. But studies of firms adopting such technology indicate that actual job displacement amounts to about 10% of the potential effect. In this case, therefore, only one secretarial position is likely to be permanently lost in that firm.

Second, people tend to be overly optimistic about the speed at which new technology will be adopted. They imply that adopting it is somehow costless. Yet it is clear that creating and implementing technology requires previous investment in both physical and human capital.

Third, Whitley and Wilson found that there is a tendency to exaggerate the extent to which microelectronics represents a completely revolutionary technology. "Even if microelectronics represents the major source of tech-

nological change likely to occur during the 1980s and 1990s," they say, "it will need to result in a marked acceleration in the pace of improvement in productivity for it to displace labor faster than achieved by previous generations of technological change. The general consensus appears to be that the new technology is best regarded as a development from previous technologies rather than a revolutionary change." Again, the data indicate that the potential for job loss is much less than has been generally feared.

Unnecessary Fear

The authors might also have mentioned that to the extent productivity is enhanced it will forestall layoffs which might take place in plants and industries where union wage demands would otherwise exceed productivity growth.

The Luddite argument has no more validity today than it had in 1811. Those who dwell on the apparent adverse effects of technological change on employment are only creating unnecessary fear and anguish among workers who worry they will be laid off. Though they may not in fact advocate restrictions on the introduction of technology, as the Luddites did, they may be sowing seeds of discontent which could take root in other ways. Already there is pressure for trade restrictions, industrial policy, plant-closing laws and government bailouts for companies in declining industries. The new Luddite argument only adds to the pressure.

All this isn't to say that some specific individuals may not become unemployed as a result of technological change. Legitimate efforts should be made to ease their plight and help them find new work. But such instances shouldn't obscure the larger good to society from increased productivity. —Bruce Bartlett

Reprinted with permission of the *Wall Street Journal* © 1983, Dow Jones and Co. Inc. All rights reserved.

Net Results ...



Net results are what you get with **PerComNet™** ... the sophisticated, user-installable Local Area Network from PERCOM DATA CORPORATION.

PerComNet IBM® interface cards are available *now* to provide true networking capabilities for IBM and most IBM compatible personal computers. This includes the sharing of peripheral devices such as printers, modems, floppy disk drives, and all PERCOM DATA High Performance PHD™ Hard Disk Drives.

PerComNet provides these **net results**:

- Token passing reliability.
- Built-in 64K FIFO buffer, to speed data transmissions.
- Signal regeneration at each node to eliminate noise, regardless of network size.
- User installation simplicity.
- Optional NBS encryption for data security.
- Support for simultaneous voice/data transmissions.
- Operating system compatibility for MS-DOS™, CP/M®, UNIX™, and uNETix®. uNETix for PerComNet is distributed by Percom Data.

If you want **net results** ... PerComNet is the logical, economical and reliable choice. PERCOM DATA has a PerComNet OEM Evaluation Package* ready for your immediate use. The package includes all the hardware, and communications and file transfer utilities you need for configuring a network of three IBM PC computers. Package price is only \$1695.

To order your evaluation package or to get more information contact us today!

PERCOM DATA CORPORATION

11220 Pagemill Road • Dallas, Texas 75243

Name: _____ Title: _____

Company: _____

Address: _____

City: _____ State: _____ ZIP: _____

I'd like you to send me more information.

I'm very interested, please have your rep call me at _____

I'd like to know more about your PHD Hard Disk.

PERCOM DATA
CORPORATION

Expanding Your Peripheral Vision

DRIVES • NETWORKS • SOFTWARE

11220 Pagemill Road, Dallas, Texas 75243 (214) 340-5800

1-800-527-1222

*Does not include operating system or application software.

PerComNet and PHD are trademarks of Percom Data Corporation. • IBM is a registered trademark of International Business Machines. • MS-DOS is a trademark of Microsoft, Inc. CP/M is a registered trademark of Digital Research. • UNIX is a trademark of Bell Laboratories. • uNETix is a registered trademark of Lartech Systems Incorporated. COPYRIGHT Percom Data Corporation 1983 • All prices, and descriptions subject to change with notice.



Brilliant!

Here's another brilliant idea from the makers of the popular MicroAngelo® graphics board — the SCION PC 640.

Whether you're a systems developer or an end-user, this solidly-designed color graphics board is your best choice for high-resolution color graphics on the IBM PC, as well as many PC-compatibles.

Here's why:

- 640 × 480 × 16 out of 4096 colors
- Memory-mapped for very high speed operation
- Over 60 2-D drawing primitives, accessible from Basic, Fortran, C, Pascal or Assembler
- High-level software packages available for painting,

business graphics, CAD and slide production

For more information on why the PC 640 may be a brilliant idea for you, please contact Jim Mather at (703) 476-6100, TWX: 710-833-0684, or write: SCION Corporation, 12310 Pinecrest Road, Reston, Virginia 22091.



The PC640 Professional Color™ board delivers superior resolution at 640 × 480, and the simultaneous use of 16 out of 4096 colors.

SCION

MICROBYTES

Staff-written highlights of late developments in the microcomputer industry.

COMDEX: IBM CLONES AND A NEW TANDY ENTRY

Two major electronics companies, including one of the pioneers of the computer industry, jumped into the crowded market of IBM PC compatibles at last month's Comdex show in Las Vegas. Sperry Corp., inventor of the Univac mainframe, introduced its Sperry Personal Computer. Sperry says its PC is fully compatible with the IBM but can run 50 percent faster and can talk to both Sperry and IBM mainframes. Prices range from \$2643 (one floppy-disk drive, 128K bytes of RAM, and a monochrome monitor) to \$5753 (one 10-megabyte Winchester, one floppy disk, 128K RAM, and a color monitor). Lower-priced models are scheduled to be available this month. . . .ITT Corp. showed its XTRA computer, which is claimed to be operationally compatible with the IBM PC. Major features of the XTRA include a mouse, 128K to 640K bytes of RAM, color graphics, a processor-unit footprint 30 percent smaller than IBM's, and prices about 5 percent lower than comparable IBM units. . . .Radio Shack introduced its Tandy Model 2000, an MS-DOS system using an 8-MHz Intel 80186 central processor instead of the 4.77 MHz 8088 of the IBM PC and look-alikes. The Model 2000 retails for about \$3000 with two disk drives and a monochrome monitor or \$4400 with a 10-megabyte hard disk. . . .Radio Shack also announced that it will support the Ovation software package for the Model 2000. Ovation is a modeless word-processor, spreadsheet, information-management, graphics, and communication package.

COMDEX: A HARDWARE DATABASE HELPER

Cogent Data Technologies borrowed an idea from the mainframe and minicomputer worlds to develop a back-end processor for database processing in multiuser systems. Its Database Machine—a card for the IBM PC, XT, and 3270-PC—incorporates Winchester control, database commands, and a multitasking operating system. Using an on-board 80186 chip as a coprocessor allows 64K-byte files to be written in just over a tenth of a second, Cogent claims. One card will be needed for each hard disk in a network and will cost from \$1500 to \$1700.

COMDEX: INTEGRATED SOFTWARE

Among the many integrated software packages making their debuts were 20/20 from Access Technology Inc. and DayFlo Inc.'s Personal Information Manager. 20/20 will run on numerous micros, minis, and mainframes. It incorporates spreadsheet modeling, graphics, data management, scheduling, text processing, and interfaces to external programs. It will sell for about \$500. . . .DayFlo allows free-form data entry, revision of formats of existing files, word processing, note-taking, forms design, and integration of external programs such as spreadsheets. It runs on the IBM PC and costs \$495.

COMDEX: OPERATING SYSTEMS

Digital Research Inc. introduced two new versions of Concurrent CP/M, a generic version for OEMs and an IBM PC end-user version featuring windowing. DRI says the OEM version is compatible with PC-DOS and supports DR Soft/Net, networking software also introduced by DRI at Comdex. The end-user package will be available through April 1 at promotional prices starting at \$150. . . .Cosmos Inc. announced that it is now an authorized Pick system licensee. Cosmos was showing its Revelation relational database-management system for the IBM PC. The Revelation system allows both MS-DOS and Pick applications to run on the PC. (Pick Systems, the developer of the program, will offer an implementation for the IBM PC XT sometime this quarter.)

COMDEX: A 32-BIT MICRO

Silicon Valley Micro Inc. introduced two 32-bit portable computers with some IBM PC compatibility. Descriptively named the \$5000 Model and the \$10,000 Model, each features both a National Semiconductor NS32032 microprocessor and an Intel 8088, an 80-column thermal printer, a 9-inch, 80 by 25 monitor, a Unix subset and MS-DOS, and serial and parallel ports. In addition, the \$5000 Model has two half-height 360K-byte floppy-disk drives and 512K bytes of RAM. The \$10,000 Model adds a 140-megabyte hard disk, a ¼-inch 60-megabyte tape drive, and 2 megabytes of RAM.

COMMITTEE ON IN-FLIGHT COMPUTER USE WAITS FOR TEST RESULTS

"Very few airlines that allow portable computers on their planes have actually tested them," said Andreas Fraga, chief avionics engineer at Eastern Airlines, after the December meeting of SC-156, the committee studying potential hazards portable computers might present to airplane navigation equipment. Convinced that "ignorance is our worst enemy," Fraga wants testing before portable computers are used in planes. One possible result of the study might be a list of approved computers that flight attendants could refer to. Only three computer manufacturers and five airlines sent representatives to the meeting. Committee SC-156 of the Radio Technical Commission for Aeronautics meets again February 28-29 in Washington, when preliminary test results may be available.

APPLE ANNOUNCES INTEGRATED SOFTWARE, HARD DISK FOR THE APPLE IIe

Apple Computer has unveiled Apple Works, a \$250 integrated software package for the Apple IIe that includes a word processor, a database manager, and a spreadsheet. A similar program for the Apple III, called III E-Z Pieces, will be available this month. Apple also announced that the Profile, a 5-megabyte hard-disk drive previously available only for the Apple III and the Lisa, will be available for the Apple IIe for under \$2200.

INMOS ANNOUNCES A 32-BIT 10-MIPS "TRANSPUTER"

Inmos Corp. has announced the IMS T424 transputer, a 32-bit microprocessor with 4K bytes of on-chip high-speed (50-nanosecond) RAM. Inmos says the transputer will execute an average of 10 million instructions per second.

UNIX ADDED TO DEC PROFESSIONAL, IBM PC XT, AND APPLE LISA

The Santa Cruz Operation Inc. announced that it will market Microsoft's Xenix operating system for the IBM Personal Computer XT, the Digital Equipment Corporation Professional 350, and the Apple Lisa for \$595 to \$795.

Digital Equipment Corp. announced PRO/V7M, based on Unix version 7, which will cost \$695 for its Professional Computer.

FOUR COMPANIES OFFER IBM COMPATIBLES WITH EXTRA FEATURES

Seequa Computer Corp. and Intertec introduced dual-processor IBM-compatible computers, both with 8086 and Z80 processors. The Seequa XT includes a 10-megabyte hard disk for \$3995, without a monitor. Intertec's HeadStart, with a 3½-inch floppy-disk drive, is priced from \$3495. North Star Computers Inc. and Onyx Systems Inc. introduced multiuser 80186-based computers. The North Star Dimension allows up to 12 users to access the system, which includes a 15-megabyte hard disk and two workstations for \$7000. Onyx's 186 Series allows multiple users to use Concurrent CP/M-86, or a single user may use MS-DOS; a single-user system is \$4495.

NANOBYTES

Dysan Corp. is entering the software publishing business in an effort to enhance the market position of 3¼-inch disks and drives. Dysan plans to enhance and standardize the documentation of the top 100 software packages and market them on 3¼-inch disks. . . . **Tandon Corp.** announced that it will begin selling 10- and 15-megabyte hard-disk subsystems to IBM Personal Computer users through dealers. Previously, Tandon sold products only to manufacturers. . . . **Digital Research Inc.** has announced a FORTRAN-77 compiler that was developed using a new technology DRI says will enable it to develop and translate compilers more quickly than in the past. . . . **Tri-Data** has unveiled the Oz Guardian, a \$750 modem that verifies passwords before permitting access to a system. The modem may be programmed to hang up and call back the phone number associated with that user. . . . **Softech Microsystems Inc.** has announced a family of network software products based on its p-System operating system. Initially available for Corvus's Omninet, software for up to eight users costs \$750. . . . **Eastman Kodak** has announced that it will manufacture and market Drivetec's high-density 5¼-inch disk drive for use in image storage and analysis applications. Kodak hopes to use its Isomax high-density disk with the drive, which can store 2.8 megabytes of data on a high-density disk. . . . **Lotus Development Corp.** is reportedly working on a version of its popular 1-2-3 spreadsheet program for Motorola's 68000 microprocessor.

Introducing The Computer That Blew Their Socks Off At Comdex.



HeadStart™ is the smallest, smartest, fastest, most powerful business computer you can buy. And networkable up to 255 user stations.

Fast? HeadStart's RAM Disk concept permits nearly 50 times faster response than conventional microcomputers. 8 or 16 bit and up to 1 megabyte of user memory.

For more information, call or write: Intertec, 2300 Broad River Road, Columbia, SC 29210. Phone 803/798-9100.

Circle 195 on inquiry card.

intertec™

Introducing COMPAQ PLUS, the first high-performance portable personal computer.

The makers of the COMPAQ™ Portable Computer, the industry standard, announce another breakthrough—the COMPAQ PLUS™ Portable Personal Computer. No other personal computer can handle so much information in so many places.

The new COMPAQ PLUS offers the power of an integrated ten-megabyte fixed disk drive in a portable. You get problem-solving power that no other personal computer can match.

Plus a bigger payload

How much is ten megabytes?

Enough to tackle jobs that can't be conveniently handled on most personal computers.



Information that would fill your company's ledgers can be stored on the fixed disk drive of the COMPAQ PLUS.

A mailing list of 100,000 names, addresses, cities, states, and Zip codes.

A full year of daily prices for every stock on the New York exchange.

Inventory records on a quarter million items.

The entire San Francisco phone book. And room left over for Peoria.

The fixed disk drive keeps all the information seconds away, ready to be searched, sorted, retrieved, analyzed or updated.

Plus better use of your time

The integrated fixed disk drive will store programs. That means your most

used programs and data can be permanently kept in the COMPAQ PLUS, ready to call up and run.

With programs permanently stored, the COMPAQ PLUS becomes a well-informed traveling companion, a tool to help you apply your best thinking anytime, anywhere.

You could store a complete library of accounting programs on the disk—payables, receivables, general ledger, and payroll—with the company's books.

You could store an inventory control program with your inventory records and a list management program with your mailing list and a filing program with your personnel files.

The COMPAQ PLUS is also equipped with a 360K byte diskette drive for entering new programs, copying data files, and making backup copies.

Plus more programs

More programs means more versatility. And the COMPAQ PLUS is impressively versatile because it runs all the popular programs written for the IBM® Personal Computer XT, available in computer stores all over the country. And they run as is, with no modification whatsoever.

And the high-capacity portable multiplies the productivity of every program it runs. Your inventory and its



The COMPAQ PLUS runs all the popular programs written for the IBM Personal Computer XT.

control programs can go with you to the factory. Your books and your accounting programs can go with you to a board meeting. Your building specs and your project management programs can go with you to the construction site.

You're buying a computer to solve problems. Why not have more problem-solving programs to choose from?



Specially designed shock isolation system protects the fixed disk from jolts.

Plus a traveler's toughness

Life can be tough on the road. A true portable has got to be tougher. The COMPAQ PLUS is.

Its integrated fixed disk drive is unique, designed specifically to travel. Rough roads and hard landings don't bother it because of a specially designed shock isolation system that protects the disk from jolts and vibration.

All the working components are surrounded by a uniquely cross-membered aluminum frame. This structure, common in race car design technology, strengthens it side-to-side, front-to-back, and top-to-bottom.

The outer case is made of LEXAN®, the same high-impact polycarbonate plastic used to make bulletproof windows and faceplates for space suit helmets.

Does a portable personal computer really have to be this tough? Take a good look at your briefcase and then decide.

Plus ease of use

The COMPAQ PLUS is big where it counts.

The display screen is big. Nine inches diagonally. Big enough to show a full 25-line-by-80-character page that's easy to read even if you're leaning back in your chair.

The keyboard is full-sized and typewriter-style for easy control.

With its built-in display, the COMPAQ PLUS makes a smooth, low profile on your desk, not an obstacle that you have to talk around.

Plus an easy way to get started

If you're buying your first personal computer and you're not sure how much capacity you need, your choice is easier now.

Start with the COMPAQ Portable with single or double 320K byte diskette drives. If you need more capacity later, upgrade to the COMPAQ PLUS. A conversion kit is available that turns the COMPAQ Portable into a COMPAQ PLUS, complete in every detail and capability.

Plus a lot more

The COMPAQ PLUS also works with optional printers, plotters, and communications devices designed for IBM's personal computer family.

It has two IBM-compatible slots for adding optional expansion boards. With companion programs, they'll let you share information with a network of personal computers in your office, communicate with your headquarters computer files while you're away, or add memory capacity if your needs grow.

The COMPAQ Portable, the industry standard in portable personal computers. ▼

The problem-solving power of a high-performance desktop personal computer can now go where you need it.



It's got high-resolution graphics and text on the same screen. A detached keyboard. Programmable function keys. Expandable memory. Dozens of other features that simply make it do a better job of personal computing.

And when you see all that the COMPAQ PLUS has to offer, you'll be pleasantly surprised by the price. The fact is, it costs hundreds less than comparably equipped desktop personal computers.

See the first high-performance portable personal computer. The COMPAQ PLUS—performance, programs, productivity. Plus problem-solving power.

The new COMPAQ PLUS, the first high-performance portable personal computer. ▼

COMPAQ PLUS Specifications

Storage

- One integrated 10-megabyte fixed disk drive
- One 360K byte diskette drive.

Software

- Runs all the popular programs written for the IBM XT.

Memory

- 128K bytes RAM, expandable to 640K bytes

Display

- 9-inch diagonal monochrome screen
- 25 lines by 80 characters
- Upper- and lowercase high-resolution text characters
- High-resolution graphics

Interfaces

- Parallel printer interface
- RGB color monitor interface
- Composite video monitor interface
- RF modulator interface

Expansion board slots

- Two IBM-compatible slots

Physical specifications

- Totally self-contained and portable
- 20"W × 8½"H × 16"D

For the name of the Authorized Dealer nearest you, call 1-800-231-0900.

©1983 COMPAQ Computer Corporation
COMPAQ™ and COMPAQ PLUS™ are trademarks of COMPAQ Computer Corporation.
IBM® is a registered trademark of International Business Machines Corporation.
LEXAN® is a registered trademark of General Electric Company.



COMPAQ

PLUS™

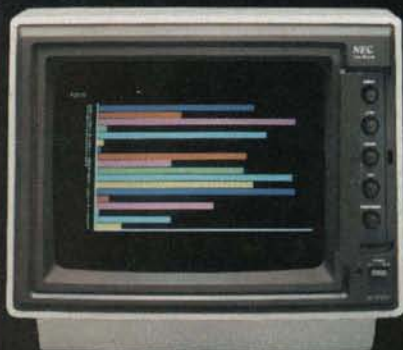

Get the total picture.

IBM COMPATIBLE - \$599!

Improve your present computer system with a high-resolution color monitor from NEC.

NEC's JC-1216 gives you the highest resolution you can get in a color monitor. And it can reproduce as many different colors and shades as the best microcomputers can generate. Compatible with a wide variety of computers, including IBM,* Zenith, H-P, and others, including NEC's own PC-8000 and PC-8800.

Compare these specs with your present monitor:

12-inch diagonal screen

RGB input signal with TTL level

Switchable Pos/Neg display characters

80-character, 25 line display

640[H] x 240[V] resolution

8 x 8 dots, 10MHz video bandwidth

*NEC CG-91 cable required



Productivity at your fingertips

NEC

NEC Home Electronics (U.S.A.), Inc.
Personal Computer Division
1401 Estes Avenue
Elk Grove Village, IL 60007
(312) 228-5900

NEC Corporation, Tokyo, Japan

Letters

In Praise of the Morrow

I have just finished "The Morrow Micro Decision" (October, page 306) by Tom Wadlow. As the satisfied owner of one of these fine machines, I must take exception with a few of his statements.

A user does not have to suffer the indignities inflicted by the Control key. This is the only review on the Morrow that I've read (and I've read at least three others) that does not mention that Morrow offers two terminals. The more expensive terminal has a much more professional "feel"; the Control key is located beside the Lock key.

I agree with the complaint about the ports. However, the latest advertisements show that a parallel port has been added. Didn't the author get the latest information before writing his review? The MD-11, another recent introduction, should also have been mentioned. It offers hard-disk storage.

As a first-time microcomputer user, I found the documentation quite adequate. Perhaps Mr. Wadlow would prefer Apple; as far as I know, you still have to pay extra for its documentation. As far as configuring the terminal, I cannot imagine a dealer who would not assist in this admittedly distasteful task.

My only real complaint is that I am still waiting for the database manager.

I guess the Morrow ads are correct; maybe it does take a special breed to recognize the value of the Morrow machines.

Gregory Diehl
Data Processing Consultant
2561 Hungary Spring Rd.
Richmond, VA 23229

Two other major microcomputer publications reviewed the Morrow Micro Decision small-business computer in September. Based on these reviews and my own 11-month experience as an MMD owner, I can only conclude that Tom Wadlow's October review was superficial because of an impending deadline.

In any case, I believe Mr. Wadlow seriously underestimated a machine that may be the best buy available for the first-time business user uninterested in portability.

I have tried in vain to explain to colleagues the utility of the MMD's "virtual-

drive" feature for saving files when confronted with a filled-up disk, for copying files from one disk to another without leaving Wordstar, and for other ways to avoid a few of the irritations that plague users.

I appreciate the CP/M interrupt that allows me several tries at a BDOS (basic disk operating system) error before giving up and retreating to the operating system. Although I'm sure other manufacturers could offer these BIOS (basic input/output system)/BDOS modifications, I know of no other under-\$2000 microcomputer that does. Do any over-\$2000 machines offer them?

Similarly, I've found the disk-emulation feature convenient; friends and coauthors with Osbornes or IBMs simply mail me a disk if they don't have a modem. I wish Mr. Morrow had included a disk-formatting option as well, so I wouldn't have to stockpile supplies of my friends' disks.

In the only "benchmark" in the review, Mr. Wadlow says the bundled Correct-It spelling checker is slow in "loading and sorting," based on his "test" of a single sentence of 14 words. As anyone who has used various spelling checkers knows, most of the time in operating these packages is spent checking the sorted object file against the master dictionary. My own "test" (without leaving Wordstar, thanks to the MMD virtual-drive feature) found that Correct-It took only 5.6 seconds to "load and sort" this 334-word letter. It then took another 75 seconds to check each of these words against its 36,000-word dictionary. Given what a spelling-checker does, I submit that this is *not* slow.

Mr. Wadlow may have revealed himself as a dedicated "Selectric" keyboarder when he complained about the location of the Control key on the MMD keyboard. As in almost all Lear-Siegler ADM terminals, the Control key is conveniently located in an easily learned position, immediately below the Z key. But those used to stretching beyond the left-hand shift key (as on Apples, IBMs, and many other terminals) will have trouble adjusting. I can assure Mr. Wadlow that the only drawback to an experienced user is the difficulty of making a one-hand stretch to achieve "Ctrl-Y" (line-delete in Wordstar), and I have often thought of this as fortunate.

My fellow members in the Morrow Micro Decision Users Group have found

many ways they can use the Micro Decision as a fully equipped, low-cost solution to business needs. I only hope BYTE will assign a more sophisticated reviewer to Mr. Morrow's latest offspring, the 11-megabyte/128K/\$2745 MD-11 (with bundled software, of course).

Andrew J. Boots
2619 Washington Ave.
Chevy Chase, MD 20815

In "The Morrow Micro Decision" Tom Wadlow states that, "The basic drive is single-sided single-density and stores about 200K bytes." I do not think this can be true because my machine has single-sided double-density disks on it. They hold only about 200K bytes.

He implies, at the end of the same paragraph, that programs written for the IBM PC can be run on the Micro Decision. This statement, the way it is worded, is inexcusable from a reviewer. How can one run a program written for a 16-bit machine on an 8-bit machine? While the format is readable, unless the program is written so that the Z80 can read it, it is unusable.

Also, he should have admonished people to be careful with any compatible software, i.e., Xerox 820, Osborne I. These program formats are usable only if there has been no configuration in the software that addresses the hardware ports, etc. If they are not written to be transportable, they will not work. Most of the software manufacturers that I have contacted are not sure if their Xerox or Osborne formats will run on the Micro Decision. If they don't, you may lose the price of the software, unless you can go inside and rewrite that part of the software.

I don't know where Mr. Wadlow got his prices, but an ad in the same issue lists different prices for the MMD. But the point of his article that really made me mad was his assessment that "The Micro Decision would make a good second computer for people who are familiar with CP/M systems or for those who have had experience with computers." Because I do not fall into either category, I have to interpret that Mr. Wadlow thinks the system would not be good for me. However, I did not have any trouble with the MMD. I found the turnkey menus to be invaluable. Had I purchased a system that was not supported in the way the MMD was, I would probably have been turned off by computers. Instead, I am enthus-

astic about them. I have learned the 8080 assembly language and have started writing many programs. I would not hesitate to recommend the MMD to someone who had never laid hands on a computer system before. In all fairness, I think that Mr. Wadlow's evaluation was somewhat biased simply because he was not a novice user.

David M. Gambs
2612 N.E. Skidmore
Portland, OR 97211

Tom Wadlow responds:

In my opinion, the purpose of a review is threefold: first, the equipment should be reviewed to see if it lives up to the manufacturer's claims; second, the equipment should be compared with the competition and its merits and faults should be brought to light; and third, a machine should be examined to see if it is all it should be—i.e., does it have any serious design errors?

I seem to have stepped on some toes with my review of the Micro Decision. Non-Micro Decision owners said they appreciated the review because it suggested things they should watch out for when purchasing any machine. Micro Decision owners' opinions were mixed. Some said the machine was a mistake and they would not recommend it to anybody. Others think it's the best thing since peanut butter. I think it is a good machine with some problems that should be examined out in the open, not hidden under the gloss of an undercritical review.

Terminals:

The BYTE article pipeline is unfortunately long and, as you can see, this sometimes causes problems. The system I received from Morrow had an ADM-20 terminal, and Morrow was not supporting the Liberty at the time. I had never touched a Liberty (I have since) and therefore could not make any comments about it.

Keyboard:

Over the course of my career, I have extensively used approximately 25 different keyboards ranging from keypunches and teletypes to my current Lisp Machine keyboard (which has seven different kinds of shift keys, any combination of which may be and often is used with a single alphanumeric character). The issue of the "best" keyboard is touchy. I will simply settle for saying that the ADM-20 keyboard is far from the "best." The Liberty is much better.

Compatibility:

If you read the first paragraph under Disk Storage in my article, you will see that I did not say that programs written for the IBM-PC can run on the Micro Decision. I said that conversion programs to run on the Micro Decision that allow you to read IBM PC disks (which implies text files only, since binary files would be useless to the MMD) are available.

MD-11:

The MD-11 was announced just shortly before the October issue of BYTE hit the stands. And prices can change dramatically over the large fraction of a year between submission of an article and its publication.

I still stand by my review.

Name Change

We appreciate David Fiedler's mention of us in the table accompanying "The Unix Tutorial, Part 2" (September, page 257). However, we changed our name from Unisoft Inc. to Unicorp Software Inc., to avoid confusion with Unisoft Systems Corp. of Berkeley. Also, there was a typographical error in our phone number. The correct number is (212) 307-6800, not (212) 327-6800 as published.

Mark Pearson
President
Unicorp Software Inc.
303 West 42nd St.
New York, NY 10036

Unix Update

In my recent article on Unix typesetting ("Typesetting on the Unix System," October, page 253), I did not want to sound negative about either Scribe or TEX, nor did I intend to portray any formatting system as being better than the others. There is at least one factual error in the article: TEX does not require non-ASCII symbols, but rather provides an alternative to using them (various escape sequences).

Good documentation—*The TEX Book*—was scheduled for publication by Addison-Wesley in late 1983. TEX is actually written in WEB, a Pascal preprocessor language that is capable of producing code for a wide variety of machines. A new macro package to produce tables (a TBL equivalent) and a set of bibliographic for-



25 Mb the hard way.



25 Mb the Rana way.

Letters

mats (using a Scribe-like database) are now available.

There are two important ways in which TEX surpasses troff when measured by traditional typesetting standards. First, TEX provides kerning, whereas troff does not. Kerning is the moving of small letters underneath large overhanging letters, as in the digraphs To and Ve. Second, TEX and Scribe allow for different design sizes, while troff has width tables for only a single design size. Traditionally, good type designers always drew several variations of a single typeface to suit the optical requirements of different print sizes. Current trends point back to this tradition.

Bill Tuthill
Imagen Corporation
2660 Marine Way
Mountain View, CA 94043

The Model 4's Hitches

All in all, I was quite pleased with Rowland Archer Jr.'s review of the new Radio Shack TRS-80 Model 4 (October, page 292). I recently purchased a 64K-byte

two-disk-drive version myself, and I am glad that I did. However, as with all things electronic, there are always a few hitches and glitches and compromises. Some of the problems with the TRS-80 were covered in the Archer article; however, there are a few niggling gripe points that he either failed to uncover or simply omitted for lack of space.

For one thing, there is the matter of the on-board speaker and the sound that can be generated with a new statement in TRSDOS 6.0. I defy anyone to find a reference to that statement and the method for its use in either the BASIC section of the *Disk System Owner's Manual* or in the *Radio Shack Model 4 Quick Reference Guide*. (Or, for that matter, in any other piece of documentation that comes with your new computer.) In order to be able to make use of this feature, I had to contact my dealer, who in turn had to call the nearest Radio Shack Computer Center, who then informed us of the following:

- 1) The proper statement syntax is SOUND X,Y where X is the pitch and Y is the duration.
- 2) The permissible range of values for pitch is 0-7.

3) The permissible range of values for duration is 1-31.

He then gave us the following program with which to provide ourselves with a demonstration of the Model 4's sound-making capabilities:

```
10 FOR X=.1 TO 7 STEP .1
20 PRINT X
30 SOUND X,1
40 NEXT X
50 END
```

Unfortunately, I was not impressed. This feature, with its limited ranges of both pitch and duration, is less than useless. Radio Shack could have omitted it and no one would have missed a thing. Fortunately, one is still able to generate a regular range of TRS-80 sound through the previous method of sending the appropriate values to an output port. (After doing some reading about the Job Control Language features of the Model 4, I realized that the primary reason for the inclusion of this piddley sound capability was for use as an alerting device when the computer is being used for a multiplicity of different processing tasks in a business or other office environment.)

ALF COPY SERVICE

1315F Nelson Street

Denver, CO 80215

(303) 234-0871

FAST • RELIABLE • LOW COST

If you produce software, ALF's disk copying service is the quick, convenient answer to your duplication needs. Most orders are shipped in less than a week. Every disk we copy is verified bit by bit and guaranteed 100% flawless.

We can copy virtually any soft-sectored mini format. Standard formats: Apple II (including nibble-copy proof, double-boot, and fast load), Apple III, Atari, IBM PC, Kaypro, NEC PC8000, Osborne, TRS-80 I and III, Zenith Z-90 and Z-100, and more. Copy protection is available for most formats.

Our "no frills" pricing means you don't have to buy extras you don't need—set-up charges start at \$10, and copying charges are 30¢ to 40¢ per side. (See blank disk prices at right. Minimum: 50 copies.) Quantity discounts available for large orders.

Of course, we have the frills too: label application, 3-hole vinyl pages, printing of labels and sleeves, shrink packaging, heat sealing, and much more. We can put your product in a customized package—vinyl folder or IBM-style binder/slip case—for a low price in small or large quantities.

ALF is one of the oldest and most trusted names in the duplication business. ALF designs and manufactures copying machines that other copying services and software publishers around the world rely on every day. Our complete understanding of duplication technology assures you of the finest reproduction available.

We're eager to solve your duplication and packaging problems—whether you want one service or a total package. Give us a call today!

BLANK DISKS

ALF buys large quantities of disks for our disk copying service—and we can pass our savings on to you. If you're buying hundreds of disks, ALF is your ideal source for top quality disks at a reasonable price. We buy our disks in bulk packages, avoiding the expense of fancy printing and labeling.

The disks listed below are 5 1/4", single sided, double density (except as noted), unlabeled, with hub reinforcement ring. Other disks are available, call for details.

3M	\$165 per 100
MEMOREX	\$165 per 100
NASHUA	\$160 per 100
NASHUA <small>(single density)</small>	\$140 per 100
VERBATIM	\$190 per 100

Without sleeves: add \$2.50 shipping per 100.

With tyvek sleeves: add \$7 plus \$2.50 shipping per 100.

Packed in boxes of 10 with tyvek sleeves: add \$15 plus \$3.00 shipping per 100.



Introducing the First 2.5 Mb Minifloppy Drive.

Isn't it just like Rana Systems to introduce a floppy disk drive for the IBM® with the mass storage benefits of a hard disk, plus the floppy's strength of removable media. The first minifloppy that stores an incredible 2.5 megabytes on a single diskette. Imagine, storing a word processor, a spelling checker, mailing list, and dictionary on one floppy. With megabytes to spare.

Rana's new drive needs only 10 floppies to give you all the capacity of five 5-megabyte hard disks. And that's not the limit. In fact, there is no limit. Like any floppy with its removable media, you can use diskette after diskette to increase your storage. Our expanded capacity disk drive not only acts like a hard disk, it also serves as an ideal back-up for one.

And that's just the beginning, because Rana's drive introduces totally new "closed loop servo" minifloppy technology, making the drive insensitive to temperature or humidity. Rana's controller card can be used with standard internal drives also, so you don't have to

use an additional slot. Our drive comes with its own power supply, software enhancements for PC-DOS 2.0 and 1.1, and CP/M-86®, and a box of diskettes. Everything you'll need to make your IBM operate to its maximum potential.



The new 2.5 megabyte minifloppy drive, available first for the IBM® PC and XT and soon for the Apple®. It's Rana's latest proof that to stay a step ahead, you've got to lead the way.

Always a step ahead.



RanaSystems

21300 Superior Street, Chatsworth, CA 91311 213-709-5484. For dealer information call toll free: 1-800-421-2207. In California only call: 1-800-262-1221. Source Number: TCT-654. Available at all participating Computerland stores and other fine computer dealers. See us at Comdex Booth #326-427. Circle 388 on inquiry card.

® IBM is a registered trademark of International Business Machines, Inc. ® CP/M-86 is a registered trademark of Digital Research. ® Apple is a registered trademark of Apple Computer, Inc.

The new 384K Quadboard by Quadram is the most comprehensive board you can buy for the IBM PC or XT. Now with added hardware features and advanced software. But our same low price.

NEW EXPANDED QUADBOARD
Quadboard now delivers 9 of the most needed PC functions/features. To let you get the most out of your Personal Computer. And help you work better and faster.

THE WORLD'S BEST SELLING MULTIFUNCTION BOARD IS NOW EVEN BETTER

All of these features are standard on the new Quadboard:

- **Parallel Port:** With the new Quadboard, you get a Parallel Port. Perfect for operating most printers and other parallel devices.
- **Serial Port:** There's

a Serial Port, too. Fully programmable, use it to connect to plotters, modems, and other serial devices.

• **Chronograph:** And Quadboard's Chronograph (Real-time clock/calendar) keeps your system's clock up-to-date.

• **Game Port:** The new Quadboard has an IBM compatible Game Port. Plug in a joystick or game paddles, and fire away.

• **I/O Bracket:** Quadboard now comes with a special I/O bracket. Use it to organize your expansion port connectors. Snaps right onto the back of the PC.

EXPANDABLE TO
384K

NEW

\$295

Socketed with no RAM installed

QUADBOARD™

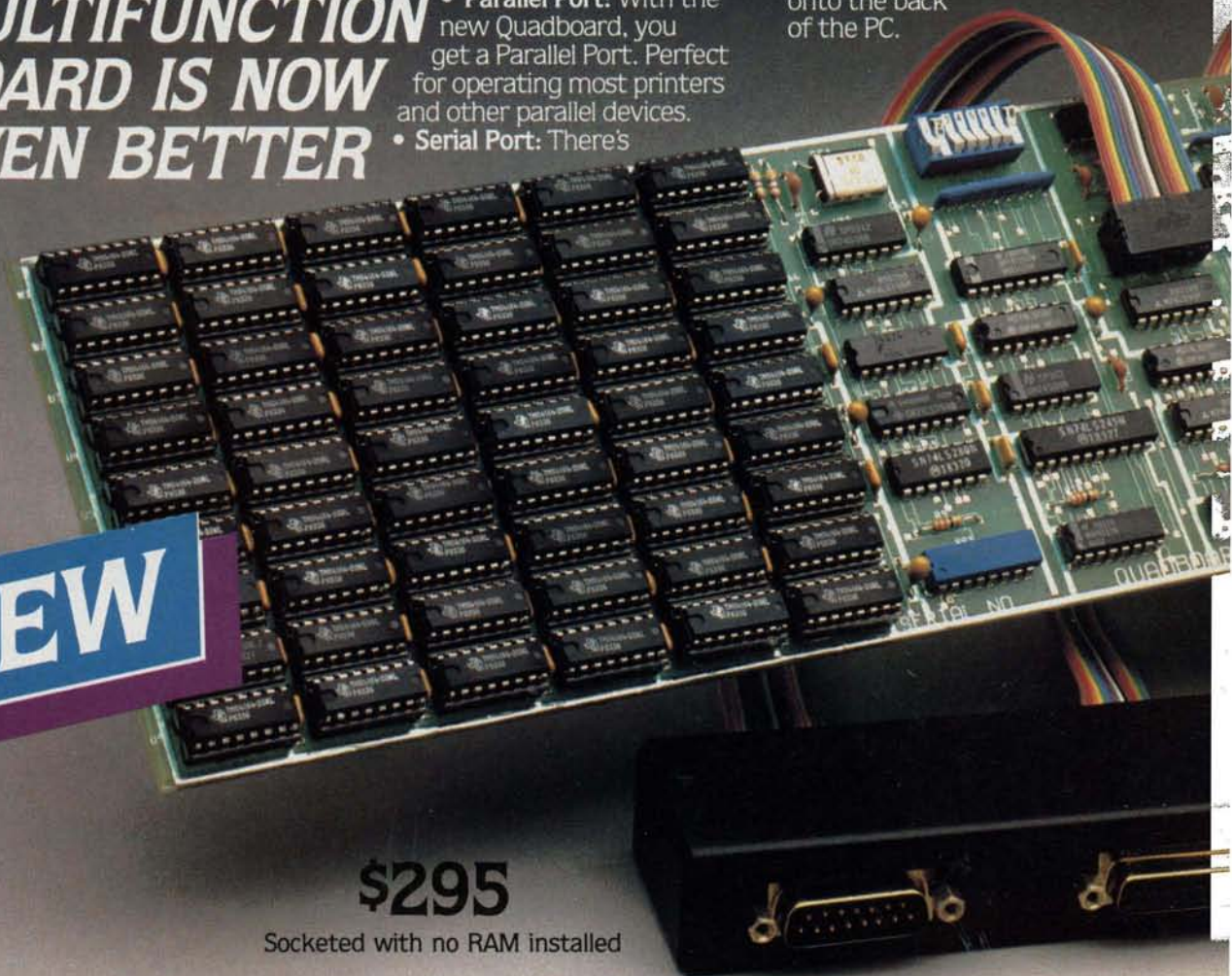

• **Expandable to 384K:**

The new Quadboard is expandable in 64K increments for up to 384K additional RAM. With full parity checking standard. With the new Quadboard and a fully populated system board, you can take your PC's memory up to the 640K limit.

• **QuadRAM Drive:** Plus, with Quadboard you get advanced QuadMaster Software. Including the QuadRAM Drive program. Use it to set up multiple RAM Drives in Quadboard memory. Solid state drives that let you store and retrieve data quickly and easily. Or take advantage of QuadMaster disk caching. To access frequently

used data whenever you need it.

• **MasterSpool:** QuadMaster Software also includes MasterSpool. Use it to set up a software print buffer quickly and easily. This advanced spooler lets you pause at any time, back up or move forward in a file. Choose just the amount of buffer space you need and stop waiting on your printer.

• **Qswap:** Another feature of QuadMaster Software is Qswap. With Qswap change line printers 1 and 2 back and forth, with just a few keystrokes, as often as you like.

QUADBOARD STANDS OUT FROM THE PACK

Now more than ever Quadboard is the first and only board your IBM PC or XT may ever need. No other board even comes close. Because Quadboard is designed for performance. Engineered for dependability.

And built in the continuing tradition of Quadram Quality.



There are many imitators, but only one leader. So make sure you ask for Quadboard by Quadram, the leader in micro-computer enhancement products.

Compare. See why more Quadboards are bought than any other multifunction board...

Features/Functions	Quadboard	SixPakPlus
Memory Available	0-384K	0-384K
Parallel & Serial Port	Yes	Yes
Clock/Calendar	Yes	Yes
I/O Bracket	Standard	Optional
Game Port	Standard	Optional
Diagnostic Testing	Yes	Yes
Advanced Spooler	Yes	No
Simple Menu Setup	Yes	No
Disk Cache	Yes	No
LIST PRICE WITH 384K*	\$795	\$970

*Manufacturer's suggested list price for board with all available features/functions as shown (options included). SixPakPlus is a trademark of AST Research Inc.



4355 International Blvd./Norcross, Ga. 30093
(404) 923-6666/TWX 810-766-4915 (QUADRAM NCRS)

INTERQUADRAM In Europe

Interquadram, Ltd.
442 Bath Road/Slough, England
Interquadram GmbH.
FASANENWEG 7/6092 Kelsterbach/West Germany
Interquadram S.A.R.L.
41 Rue Ybry./92522 Neuilly/France

Circle 298 on inquiry card.

BY QUADRAM

Letters

Perhaps Radio Shack should have taken the money that was spent on incorporating that insipid attempt at a sound statement and spent it on providing the Model 4's keyboard with a functioning "ON" light. After the computer has been turned on and before TRSDOS has been booted up, there is absolutely no way to tell that it is on: no cursor on the screen and no lights on the keyboard or front panel. It's such a simple thing, yet it seems to have completely slipped the attention of the engineers at Radio Shack. And it is important: I've had my Model

4 for only two months and I've already inadvertently left it on overnight several times (once with the cover on it).

And, of course, there are the seemingly obligatory documentation typos and ambiguities. When attempting to get the communications software that is included with TRSDOS 6.0 (a useful and sophisticated program, I might add) up and running, the unsuspecting Model 4 user is led on a wild goose chase for an appendix that doesn't exist: the included reference to Appendix L should have been to Appendix I. Once I got the Comm pro-

gram going and experienced difficulty in downloading a file from my disk space in Compuserve, I discovered that the problem lay with the instructions for transferring a file from a mainframe to a TRS-80. We are first told to "Type in the command which causes the mainframe to list the file, but do not press <ENTER>." The next instruction tells us to "Specify your receive file by pressing <CLEAR><6> followed by <CLEAR><9>," after which we are to type in the filename in response to the prompt. The third step begins by instructing the user to "Press <CLEAR><6> followed by <CLEAR><:;> to open the receive area of memory." If the file to be downloaded is smaller than the available area of memory, we go to the next instruction. We are then told to "Press <ENTER> to start the file listing." The instructions are both clear and quite detailed, but the confusion results from assuming the user, who is being walked through the procedure verbatim, will suddenly break out of the rote mold and provide one key step that they have assumed to be one of common sense. When I attempted to carry out these instructions, I began by issuing the prescribed FILGE command to list my file:

TYPE filename

but did not press <ENTER>. I then did the <CLEAR><6><CLEAR><9> to specify my receive file. The Comm program responded with the appropriate prompt and I typed in the filename

Filename: filename

Now, anyone with an ounce of computer literacy knows that, ordinarily, in order to get the computer to "take" the information that has just been typed on the keyboard, the user must press <ENTER>; but remember, the instructions have been set up for the user to follow precisely, step-by-step. The first instruction told us not to press <ENTER> in a situation where we normally would have, and the first half of the second instruction had us press keys that caused the computer to do something without having to press <ENTER>. So the immediate assumption, at least on my part, was that I was not to press <ENTER> again until explicitly instructed to do so in the fourth step of the procedure. Therefore, without pressing <ENTER> after typing in the name of the receiving file, I tried to open the receive area of

Computer Supplies Shipped Anywhere



No matter where you use a micro computer or word processing machine, top quality supplies from Pryor are only a phone call away. We offer a full inventory of items, from ribbons and



printwheels to binders and furniture, diskettes, and magnetic tape... over 1600 items in all... and everything's in stock. You can expect instant turnaround of all orders, even overnight express if you wish.

PRYOR
Full line computer supplies since 1959

Over 67,000 customers rely on Pryor every day.
Call toll-free for your own catalog now.

Ext. 5038 **1-800-558-6866**

Bored Waiting? Here's The Board You've Been Waiting For.

Now
Available!

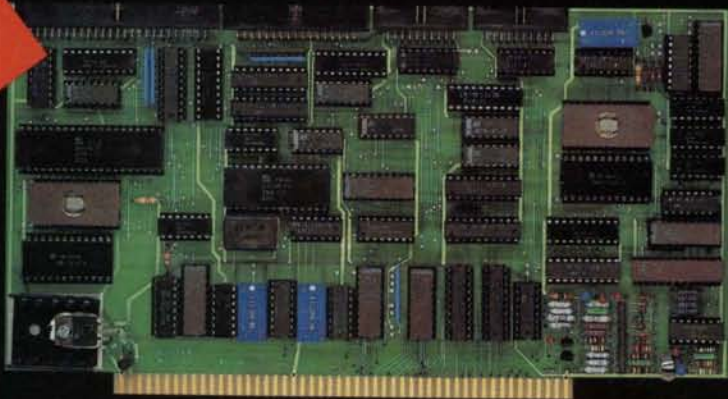

A hard disk and cartridge tape controller together on one board? Magic? Not really. It's Teletek's HD/CTC. The hard disk and cartridge tape drive controller provide the support necessary to interface both rigid-disk drives and a cartridge tape deck to the S-100 bus.

- A Z-80A CPU (optionally Z-80B) providing intelligent control of the rigid-disk and cartridge tape drives.
- Support of 5 1/4" rigid-disk drives with transfer rates of

5 megabits per second. Minor changes of the on-board components allow the support of other drive types/sizes and transfer rates up to 15 megabits per second. (Interface to disk drive is defined by software/firmware on-board.)

- Controller communications with the host processor via 2K FIFO at any speed desirable (limited only by RAM access time) for a data block transfer. Thus the controller does not

constrain the host processor in any manner.

- Two 28-pin sockets allowing the use of up to 16K bytes of on-board EPROM and up to 8K bytes of on-board RAM.
- Individual software reset capability.
- Conforms to the proposed IEEE-696 S-100 standard.
- Controller can accommodate two rigid-disk drives and one cartridge tape drive. Expansion is made possible with an external card.

Teletek's HD/CTC Offers A Hard Disk
Controller, Plus Cartridge Tape Controller,
All On One Board.

TELETEK

100%

CERTIFIED ERROR FREE

SENTINEL
SENTINEL
DISKETTES

Guaranteed
when properly
used to
Read, Write
Error-Free as long
as you
own them.

Sentinel Computer Products, Division of Packaging Industries Group, Inc.

QUALITY YOU MAY NEVER NEED. But it costs no more!

The expert technicians who produce and monitor the quality of our diskettes have developed new state-of-the-art technology using equipment we design and build ourselves, unlike any other diskette maker. That's why our burnishing method uses a unique, dual-sided technique which provides an advanced degree of surface smoothness, the key to consistent high quality



SENTINEL[®]

performance. In addition, a superior, high quality lubricant assuring extra long life and a quality control program which includes certifying every Sentinel Diskette are reasons we can offer you the industry's most exacting guarantee. For unsurpassed information security, choose Sentinel brand, and ask your dealer about the new 2-PACK in a resealable storage case.

The Professional's Diskette — Ideal for Personal Use.

Sentinel Computer Products, Division of Packaging Industries Group, Inc.,
Hyannis, MA 02601 Tel: 617-775-5220

Letters

memory with the <CLEAR><6><CLEAR><:;> command and got a couple of graphics characters printed following the receiving filename for my trouble.

Needless to say, I was extremely non-plussed, so I began to experiment with the command sequences listed in the remainder of the instructions, only to be rewarded with open files, empty files, a half-hour of toll and connect charges, and one massive headache. By the time I finally deduced the nature of the problem, I was fit to be tied.

Now don't get me wrong; I love my new Model 4 and wouldn't trade it for a whole room full of other types of computers (they each have their own set of drawbacks anyway), but I do wish that companies would pay a little less attention to rushing things to the market to beat the competition and a little more attention to providing comfort and convenience to the people who are plunking down a couple of thousand dollars for the companies products.

Tom Greenwell
2017 East Walnut Ave.
Visalia, CA 93277

Hearing Loss and CRTs

Like reader Page (Letters, October, page 30), I am bothered by the high-frequency audio output of monitors and televisions. This has kept me from watching TV (not such a bad thing) but also has caused me trouble when using my computer.

My solution was to build a plywood box with a glass front for the monitor. The glass is clamped down on foam-tape weather stripping and all the joints of the box (and the cord hole) are sealed with silicone RTV. As the glass is tightened down on the foam tape and the final leaks are closed, the squeal goes away. Of course, the monitor runs hotter than before, and I turn it off during breaks. The monitor has worked fine for two years in the box.

I suggest that the box be sized generously to allow internal air flow and that its exterior not be covered with papers, etc. To control high-frequency sound it is necessary to get it as airtight as possible.

I note that all the current research into health problems from VDTs (video-display terminals) has ignored this problem and suggest it as a good topic for re-

CLEO makes the mainframe connection.



Your PC can do more. CLEO Software is the answer to your interfacing problems.

The communications features of the CLEO-3270 Software package allow your microprocessor to emulate a cluster of IBM terminal devices.

You don't even need to change software on your mainframe computer, because for all it knows, it's communicating with a 3271-12, 3275-12, or 3276-XX cluster. And the CLEO program will support multiple devices.

If your IBM mainframe doesn't support remote 3270 clusters, you need remote batch communications. CLEO-3780 Software is your answer.

For full details contact Phone 1, Inc., 461 North Mulford Road, Rockford, IL 61107; phone (815) 397-8110. Telex 703639

PC with
CLEO
Software

PC

PC

PC

PC

PC

Standard Features-CLEO 3270

- Bisynchronous 3276-2 protocol to 9600 baud
- SDLC 3271-12 and 3275-12 protocol
- Up to eight line cluster activity
- Selectable control unit address
- User install program for various CRTs
- 3278 emulation for ASC11 CRTs
- Available for CP/M™, MP/M™, MsDOS™, TurboDOS™, Unix™, and Xenix™
- 3276-12 protocol, coming soon

Standard Features-CLEO 3780

- Point-to-point and multipoint communications
- Available for CP/M™, MP/M™, MsDOS™, TurboDOS™, Unix™, and Xenix™
- Supports transparent mode
- Coded in C language

CP/M is a Trademark of Digital Research, Inc.
MP/M is a Trademark of Digital Research, Inc.
MsDOS is a Trademark of Microsoft, Inc.

TurboDOS is a Trademark of Software 2000, Inc.
Unix is a Trademark of Bell Labs
Xenix is a Trademark of Microsoft, Inc.

Circle 287 on inquiry card.

CLEO

STATE OF THE ART, WORLD'S APART

The UCSD p-System™ bringing
the future closer to you.



SYSTEM CENTER FOR **NEC** PERSONAL COMPUTER
AUTHORIZED DISTRIBUTOR FOR **NEC**

PASCOT

17981 Skypark Circle Suite B, Irvine, Calif. 92714 / Phone: (714)261-5220

UCSD-p System / Trade Mark of the Regents of the University of California

Letters

search. Perhaps the reason it has been ignored is that our society of TV watchers has acquired a notch in its hearing at the critical frequency. An interesting question is where in the hearing system the notch occurs.

Another question that seems to get little attention in the current VDT studies is the effect of screen flicker with short-persistence phosphor screens and/or poor drive circuitry that doesn't keep the characters still on the screen.

Doug Milliken
245 Brompton Rd.
Williamsville, NY 14221

Regarding the letter from Reverend John Page—this high-frequency noise is a ubiquitous phenomenon caused, I believe, by the fact that the monitors are designed by deaf engineers. Most men have lost their hearing at 15.7 kHz by their early twenties and thus build and design the monitors with cheap flyback transformers that vibrate at the flyback frequency. The medical problem is thus with the engineers and not with those who can hear those frequencies. Measurements near the cooling holes of many monitors give readings as high as 90 dB (decibels).

I have also been trying to find a monitor without this defect. I am going to try wrapping the flyback transformer completely, which will require rewiring it to the board so the wrapping can go under it as well. However, a better course would be to put pressure on the manufacturers to build better equipment.

William G. Unruh
Department of Physics
University of British Columbia
Vancouver, B.C.
Canada V6T 2A6

I believe that John Page has identified a problem with CRTs (cathode-ray tubes) that may be of much more immediate concern than the recent controversy about CRT radiation hazards. I, too, have experienced ringing in the ears and headaches after extended sessions at the keyboard, two feet away from a monitor that, as most do, puts out a 15-kHz squeal from its horizontal oscillator. An informal poll of several friends reveals that about half of them have experienced the same symptoms or worse, but these were attributed to fatigue. It would appear that the difficulties mentioned by Mr. Page are

Three ways to Speed up your Apple II & Apple IIe for \$295

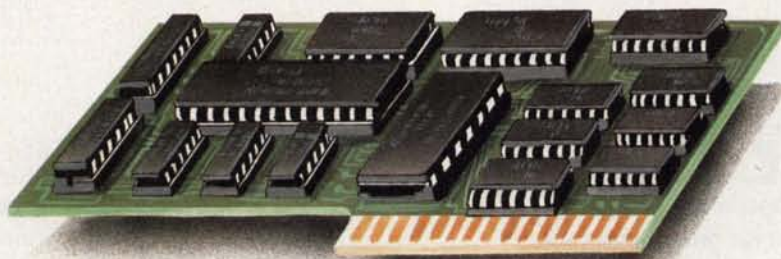
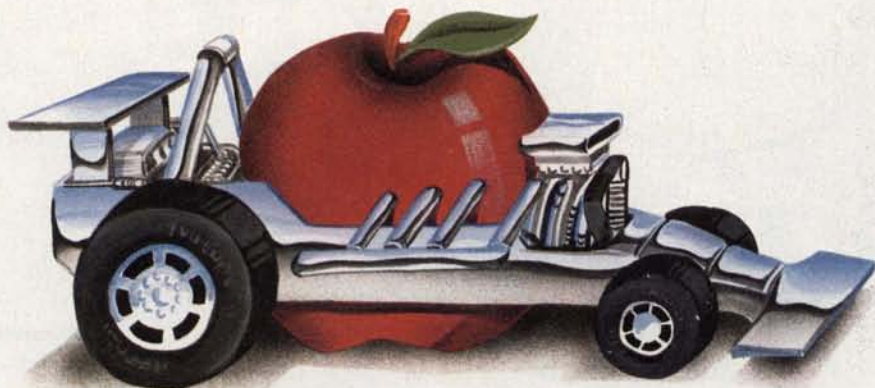
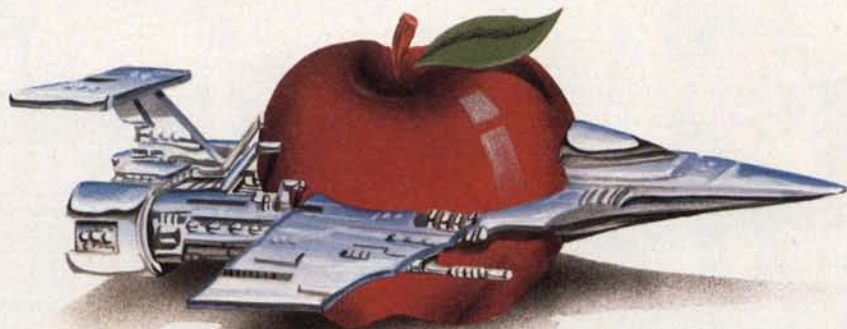

The Speedemon™ from McT.

- Speedemon™ ● Makes any Apple II, II+, or IIe run 3½ times faster.
- Speedemon™ ● Makes your Applesoft, Apple Fortran, Word Processing, D.B. Master, Pascal, or Visicalc programs run up to 3½ times faster.
- Speedemon™ ● Costs less than any other speed up card.
- Speedemon™ ● Available immediately by mail. (We guarantee shipment within 7 days from receipt of order.)
- Speedemon™ ● Costs only \$295.

Circle 238 on inquiry card.

Please send me _____ Speedemons™ by return mail at \$295 each. I have enclosed \$ _____
 I have an: Apple II Apple II plus Apple IIe This is for: Business Use
 Or charge my: Visa Mastercard American Express Personal Use
 My Acct.# is _____ Expires _____
 Name _____
 Address _____
 City _____ State _____ Zip _____
 Calif. Res. Add 6½% Sales Tax. Mail to: McT • 1745 21st Street • Santa Monica, CA 90404

 A PRODUCT OF
 MICRO COMPUTER TECHNOLOGIES

Dealer Inquiries Invited

Apple is a registered trademark of Apple Computers, Inc. VisiCalc is a registered trademark of VisiCorp, Inc. DB Master is a registered trademark of Stoneware, Inc.

Satisfying More Than With Innovation



GrapplerTM + Printer Interface

The Original Apple[®] graphics printer interface. Since its introduction three years ago, the Grappler has been imitated by many, but never matched. Now with exclusive features for the Apple IIe and full support of new Epson[®] graphics, the Grappler + remains the most intelligent interface available. Over twenty-seven commands give Apple users full control over any graphics or text on the Apple screen, including a new 80 column text dump. Performance, reliability and support have made the Grappler + the #1 selling intelligent Apple interface.



BufferboardTM For Apples and Printers

The innovator in "dock-on" printer buffering. The Bufferboard easily adds memory to your current Apple interface system, freeing your computer for additional input. Easily upgradable from 16K, the Bufferboard can store up to 20 pages of text. It fits neatly inside your Apple, "docking" onto your existing printer interface.* No clumsy boxes or cables, no external power supplies... just convenience and economy. With the Bufferboard, you might never wait for your printer again.



* Versions for standard Grappler +, Epson APL and Apple Parallel Interfaces.

135,000 Apple® Owners And Excellence.

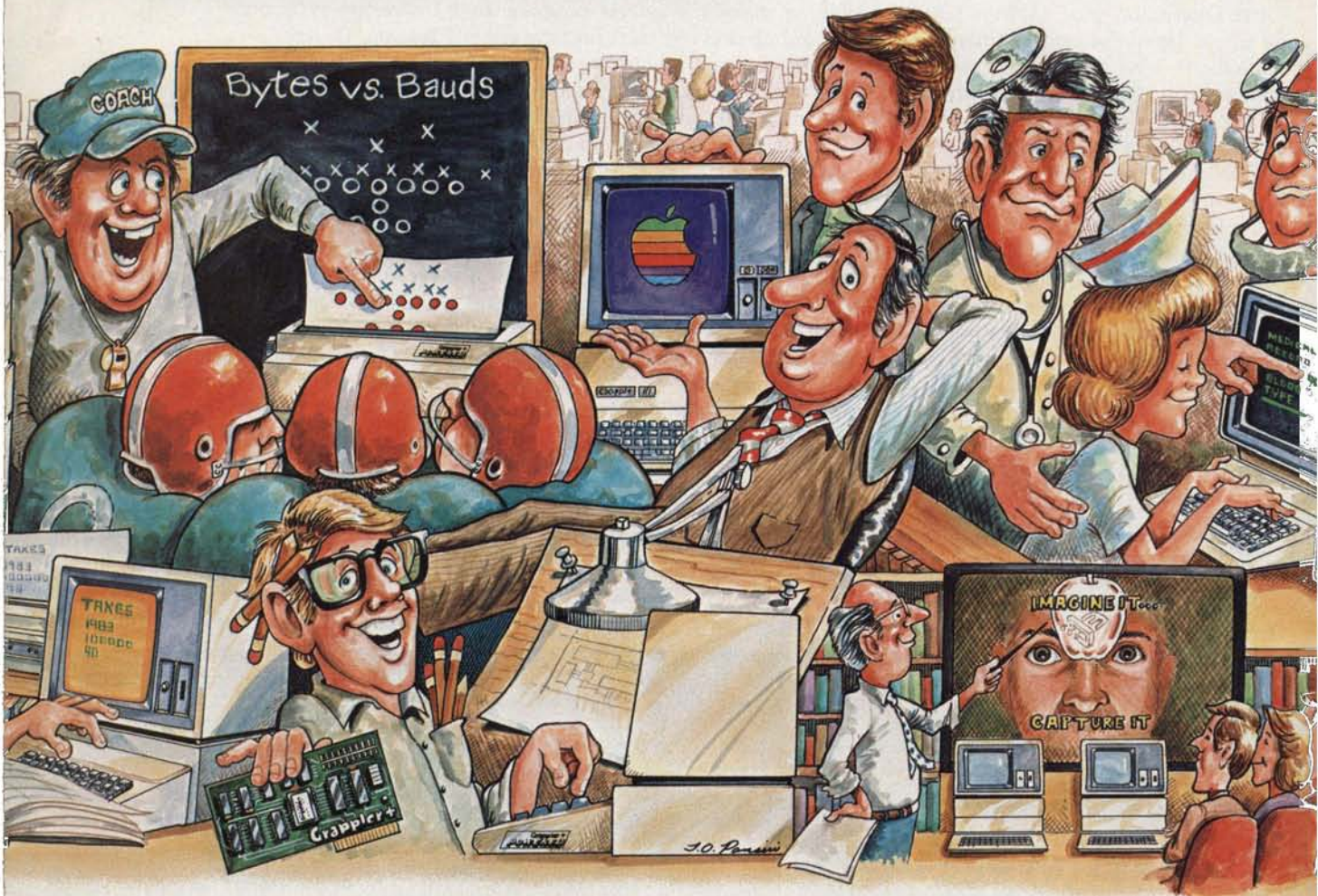

BUFFERED Grappler +

The most sophisticated buffered Apple printer interface available. The New Buffered Grappler + combines the industry leading features of the Grappler + with the time saving economies of the Bufferboard.**

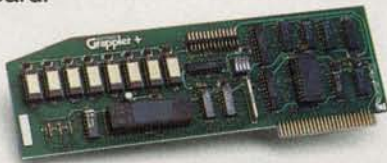

With this much interface power, you'll never need anything else. And the price will surprise you, too.

** Not available for IDS printers.

Apple is a registered trademark of Apple Computers, Inc.
Epson is a registered trademark of Epson America Inc.

Over 135,000 Apple® computers are using Orange Micro products. Innovation and excellence have made us the #1 manufacturer of intelligent printer interfaces. The top selling Grappler + has become an industry standard, recommended by more software houses and Apple dealers. To meet your growing needs, Orange Micro will continue to introduce new products. Recent innovations include the Grappler + for IDS color printers and the new Orange Interface, with text screen dumps and formatting at a low price. There is an Orange Micro product designed for your application. For a complete demonstration, see your Apple dealer today.

 **Orange Micro**
inc.

1400 N. Lakeview Ave., Anaheim, CA 92807 U.S.A.
(714) 779-2772 TELEX: 183511 CSMA

© Orange Micro, Inc., 1983

International Distributor Inquiries Invited.

Letters

not limited to individuals with special inner-ear problems but are instead suffered by many of us to a greater or lesser degree.

This same phenomenon is discussed in greater detail in a letter to *Softalk* (October Open Discussion, page 43) from J. Barry Smith of Massachusetts, a professional audiologist who was able to measure 15-kHz sound-pressure levels as high as 44 dB at the operator's ear. I think this problem may be widespread, especially among the female population of computer operators, who typically have more acute hearing than men.

I have no direct answer for John Page in his search for a silent terminal. I think he has identified a problem that we all may share, and I hope if an answer exists that it will be given widespread publication.

Gary Keene
5 Tangerine
Irvine, CA 92714

Model 100 Flaws

In Mahlon Kelly's informative (and justly enthusiastic) article about the Radio

Shack Model 100 ("The Radio Shack TRS-80 Model 100," September, page 139), a problem is presented and left unsolved: because the editor will not let you back into BASIC with an ill-formed text, Mr. Kelly points out on page 156, "It's possible to make the edited program so screwed up that you can't find the error and you can't even get out by hitting the Reset button." Because turning the power off and on will simply bring you back to the same point, the problem can be annoying indeed.

The solution is this: use function keys F7 and F6 to cut the whole program, putting it into the paste buffer. Then press F8 to get into BASIC with what is now a null program. Then you can simply paste the whole thing in, and BASIC will not only accept it but obligingly flag all your syntax errors.

There is another problem that Kelly doesn't mention. If you want to upload a file through TELCOM but press the download function key by mistake, as soon as you name the file that you expect to be transferred, that file will be wiped out to make room for what the Model 100 expects to receive. There is no fix, but my solution (because I can never remember

which is up and which is down) is to write "Hither" and "Thither" in ink under the relevant function keys.

Ronald de Sousa
Department of Philosophy
University of Toronto
Toronto, Ontario
Canada M5S 1A1

Support for Modula-2

I was very interested to read in your August issue about new releases of Modula-2 ("The Debate Goes On..." by Jerry Pournelle, August, page 312). I have been using Modula-2, with increasing enthusiasm, for several years now, using Professor Wirth's E.T.H. compiler, and feel that Modula-2 will most likely become the successor to Pascal, because of its elegant and straightforward solution of so many of Pascal's problems. However, this will really depend on a number of commercial implementations of Modula-2 becoming available, with the backup and support that this implies, rather than with the responsibility resting on the user to sort out any problems that arise. In many respects the situation is like Unix three

Shift into Ultradrive with Targa™ by CMC

■ Targa is your answer for a quality, hassle-free hard disk subsystem.

■ Targa interfaces with most popular microcomputers and carries the finest limited warranty in the industry.

■ At under \$2000 (sug. ret. for 5MB), Targa is an exceptional buy in terms of price/performance.

■ Available in 5, 10, 15, 20, and 40 MB models.

■ Seriously interested? Call us toll free at 1-800-CMC-INTL. In Washington dial 1-206-885-1600.

CMC International

Bellevue, Washington 98005
Circle 63 on inquiry card.

HIGH PERFORMANCE

NOW AVAILABLE IN A THREE-SPEED



SPEED

Class

STYLE

INTRODUCING THE NEW DS 220 MULTI-MODE MATRIX PRINTER

First there was the Datasouth DS180. The original high-performance printer. The printer that raised the standards of on-the-job performance to new heights. A tough act to follow.

And now, following in the same tradition, is the new Datasouth DS220. State-of-the-art performance, taken to higher levels. In a new 3-speed multimode form. Ready to run data, near letter quality and graphics output—in a single printer.

At data speed, the Datasouth DS220 leaves competitors in the dust. By using high speed tabbing to zip over blank spaces and true logic seeking to print the next available

character, the Datasouth DS220 charges through printed copy at speeds rivaling more expensive line printers.

At 40 CPS NLQ speed, the Datasouth DS220 creates near letter quality output with the kind of class that might make you wonder if it was produced by a daisy wheel printer. With its fine tuned 18 x 48 dot matrix, multiple fonts are produced with the precise clarity required for word processing applications.

And for graphics, the Datasouth DS220 adds high performance style to popular microcomputer applications programs through high resolution dot

addressable output. Sharp new details emerge from business charts and graphs, and engineering drawings.

And those are just its printing capabilities. Its fully instrumented dashboard allows push button programming of up to fifty features for forms control, communications and print style selection.

Best of all, the Datasouth DS220 costs much less than you might expect for a high performance three speed. Go to your nearest showroom and run a Datasouth DS220 through the gears. See how little it costs to own three high performance printers in one high performance package.

datasouth

H I G H P E R F O R M A N C E M A T R I X P R I N T E R S

AVAILABLE NATIONWIDE
THROUGH OUR NETWORK OF
SALES AND SERVICE DISTRIBUTORS

Datasouth Computer Corporation
Box 240947 · Charlotte, NC 28224
704/523-8500 · Telex 6843018 DASOU UW

Letters

years ago, and sufficient commercial support could so easily make Modula-2 the standard language for many real-time microcomputer applications, in the same way that it has established Unix.

H. W. Thomas
Electrical Engineering Laboratories
The University
Manchester
England M13 9PL

The Future of Programming Languages

As a professional programmer and longtime user of the C programming language, I am very happy to see the increased interest in this area. Also, as the teacher of a beginning C programming course organized through AnaHUG, a local computer club, I was grateful for James Joyce's excellent introduction to the language ("A C Language Primer," August, page 64, and September, page 289). However, I would like to correct one statement in Part 1 of the series that could confuse the novice C programmer. While

discussing the printf() function, Mr. Joyce states, "All arguments of a function must be on the same line in C." He then adds, ". . . the entire string in printf must be on the same line." This is a contradiction to *The C Programming Language* by Kernighan and Ritchie, which states (on page 179) that in C source code, "Blanks, tabs, newlines, and comments (collectively, white space). . . are ignored except as they serve to separate tokens." In addition, that text states (on page 181) that, "[In a string] a \ and an immediately following newline are ignored." It has been my experience that Unix C compilers follow *The C Programming Language* in this respect. For example, using Unix C compilers I have used printf function calls of the form

printf

("This is an example of a format string \ split across a line. Numbers follow: %d %d %d",

5*75,
7*7,
99-83);

Note that in this example the format string is split across a line (the second line

must be left-justified or the extra spaces will appear in the printed output), and the additional arguments are on separate lines (which might allow comments following each).

John F. Belsher
Custom Programming
1283 San Paulo
Placentia, CA 92670 ■

BYTE's Bugs

Insert GOTO

William N. Carter of San Francisco raised the point that the program by Ed Juge in Mahlon Kelly's "The Radio Shack TRS-80 Model 100" (September, page 139) needs a correction. Line 140 calls for GOSUB 360; that subroutine lacks a RETURN. The program will work just fine if you change it to a GOTO 360, move the PR\$=L\$ to the second statement in line 60, and delete line 160. ■

FREE SHIPPING
Order line: 800-354-7330

SANYO SUPER SYSTEMS

SYSTEM #1 \$1195 SANYO MBC-550

- SANYO GREEN MONITOR
- GEMINI 10 X • SOFTWARE •

Sanyo MBC-550 Single Drive Computer • Sanyo CRT-36 Monitor • Star Micronics Gemini 10X • Cabling • WordStar • CalcStar • Easywriter • MS-DOS • Sanyo Basic •

SYSTEM #2 \$1525 SANYO MBC-555

- SANYO GREEN MONITOR
- GEMINI 10X • SOFTWARE •

Sanyo MBC-555 Dual Drive Computer • Sanyo CRT-36 Monitor • Star Micronics Gemini 10X • Cabling • WordStar • CalcStar • SpellStar • InfoStar • Mail Merge • Easywriter • MS-DOS • Sanyo Basic •

PRINTERS

C. ITOH

Prowriter 8510	\$345
F-10 Serial or Parallel	\$940
8510SP (Prowriter SP)	\$565

COMREX

CR-2	SAVE
------	------

DIABLO

620 RO	\$860
630 RO	\$1715

EPSON

RX-80	SAVE
RX-80 F/T	SAVE
MX-80 F/T	SAVE
FX-80	SAVE
FX-100	SAVE

JUKI

6100	\$480
------	-------

NEC

2010	\$780
2050	\$905
8023A	\$385
3510	\$1370
3550	\$1715

STAR MICRONICS

Gemini 10X & 15X	SAVE
Delta 10	SAVE

PRINTERS

OKIDATA

82A	\$359
83A	\$559
84P	\$980
84S	\$1065
92	\$419
93	\$699

TALLY

MT 160L w/tractors	SAVE
MT 180L w/tractors	SAVE
Spirit 80	SAVE

TOSHIBA

1350 Serial or Parallel	\$1450
TRANSTAR	
130P	\$675
120P	\$450
T315	\$450

TERMINALS

TELEVIDEO

910+	\$555
914	\$540
924	\$670
925	\$705
950	\$905
970	\$980

COMPUTERS

HYPERION

Single Drive System	\$2325
Dual Drive System	\$2665

PIED PIPER

Communication I	\$975
-----------------	-------

TELEVIDEO

803	\$1799
-----	--------

SANYO

MBC-550 System	\$1195
MBC-555 System	\$1525

MODEMS

HAYES

1200	\$490
1200B	\$435
300	\$205

Prices reflect 3% to 5% cash discount.

Product shipped in factory cartons with manufacturer's warranty.

Free shipping is on UPS ground only. Prices & availability

subject to change without notice. Send cash-

ier's check or money

order...all other

checks will

delay ship-

ping two

weeks.

SILICON SPECIALTIES
2034 WEST SOUTHERN
MESA, ARIZONA 85202
602-969-0909



New!

Three Winchester Internal Hard Disc Drive Systems!

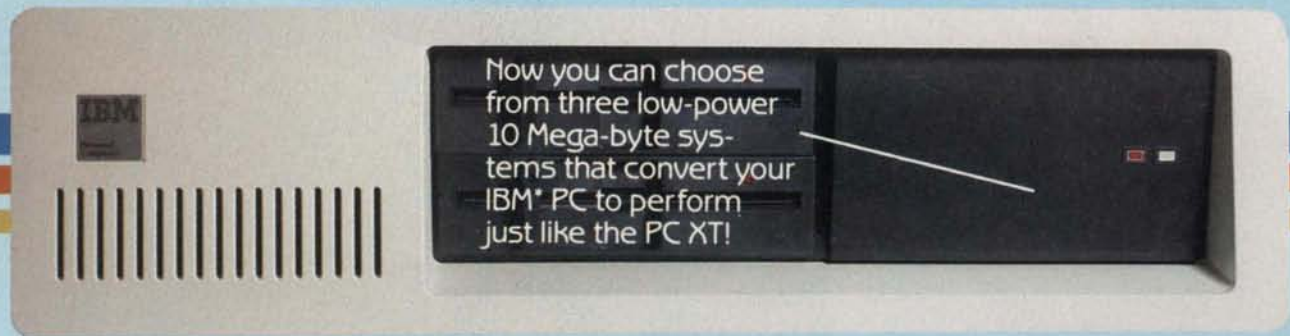

Now you can choose from three low-power 10 Mega-byte systems that convert your IBM® PC to perform just like the PC XT!

Maynard Electronics introduces three Winchester Hard Disc Drive Systems — the only drive systems to offer you 10 Mega-bytes of formatted capacity with complete internal installation! These systems offer the user countless benefits and features: capability of booting off the hard disc; additional functions while requiring only **one** card slot in your PC; and, use of available power, thereby preventing overheating problems which have affected other drives. Handling heavyweight data was never easier.

All three systems are quality engineered and work with DOS

2.0 without any special software drivers and also run with other operating systems designed to make use of the XT hard drive system. All you need is the IBM® DOS 2.0 Manual and you're ready to run!

Each system is equipped with a low-power hard disc drive, complete software, cable, a SandStar™ Card and Hard Disc Controller Module. SandStar™ is the first family of modular peripherals created for the IBM® PC. Simple instructions for easy installation are included and all components are backed by an Unconditional One Year Parts and Labor Guarantee.

WS 1

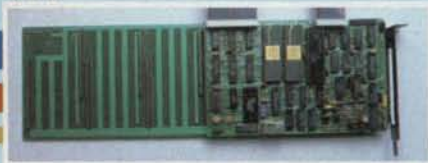

This System is equipped with the SandStar™ Multi-function card. In addition to the Hard Disc Controller Module, you can add up to three other SandStar™ Modules while using only **one** card slot. The following modules are available: Serial Port, Parallel Port, Clock Calendar, Game Adaptor, SASI Host Adaptor and Prototyping Module.

WS 2

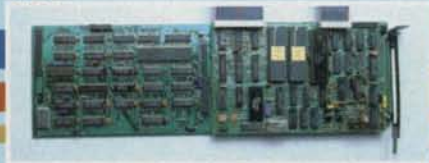

This System is equipped with the SandStar™ Floppy Drive Controller Card. The Card can control, in addition to the Hard Disc Drive, two floppy drives mounted inside your PC and optionally two additional 5¼" or 8" drives mounted externally. This leaves three system slots for other expansion boards.

WS 3

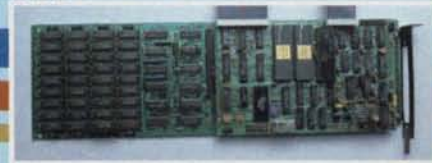

This System is equipped with the SandStar™ Memory Card. In addition to controlling the Hard Disc Drive, the Memory Card allows you to add 64K bytes to 576K bytes of memory using only one card slot.

To expand your PC to perform like the PC XT, one of our Winchester Hard Disc Drive Systems is right for you. And if you have already made the wise decision to install any of Maynard's SandStar™ Cards, the SandStar™ Hard Disc Controller Module may be purchased separately.

TO ORDER, CONTACT YOUR LOCAL DEALER OR DISTRIBUTOR.



MAYNARD ELECTRONICS

400 East Semoran Blvd. • Suite 207
Casselberry, Florida 32707
305/331-6402

We make modern times better.

Circle 237 on inquiry card.

*IBM is a trademark of the International Business Machines Corporation.
**COMPAQ is a trademark of the COMPAQ Computer Corporation.

You're traveling through 140°

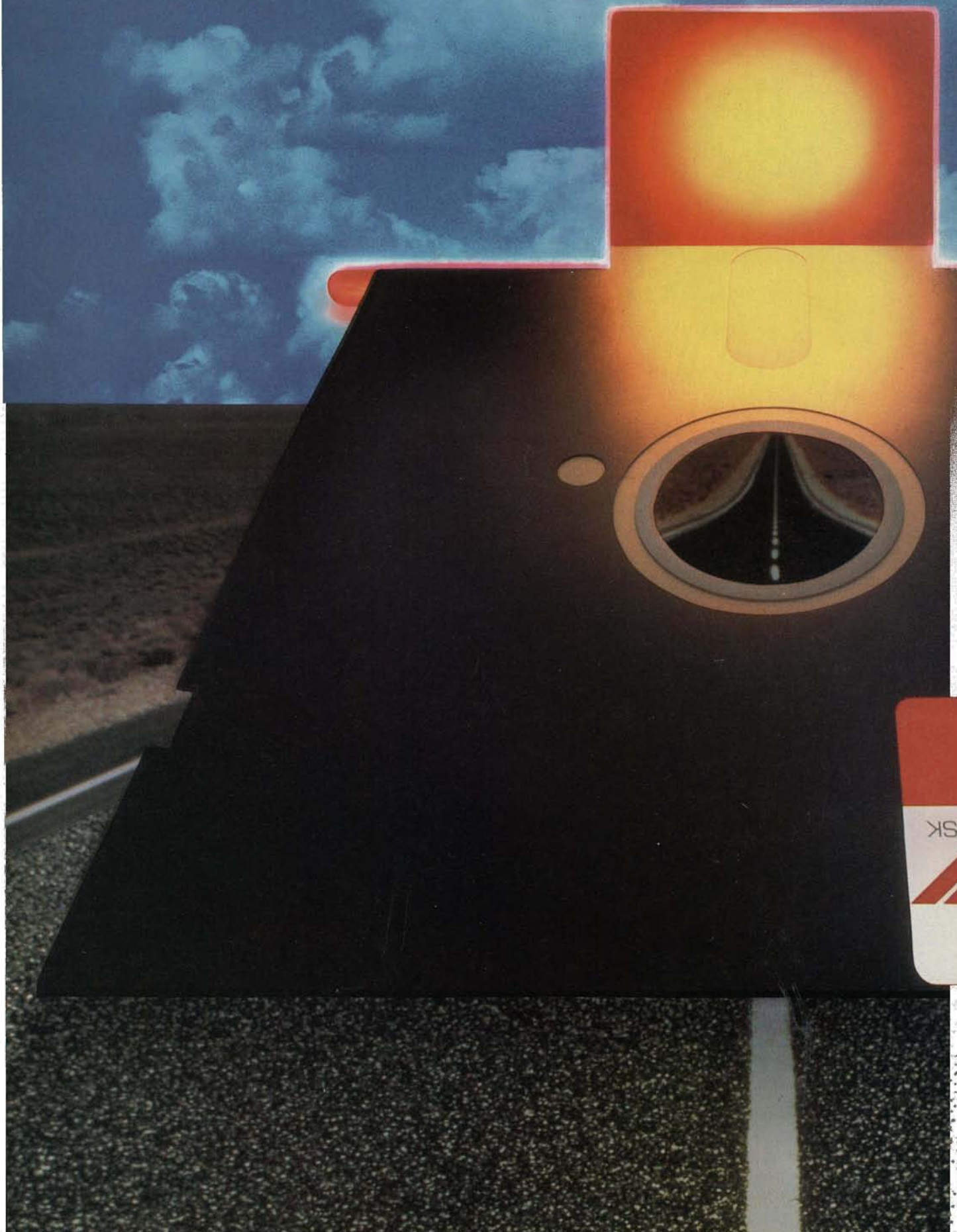

ISK

terrain at 300 rpm.

**Only one disk
guarantees safe passage
through the torrid zone
of drive heat.**

Maxell.

A lifetime warranty. And manufacturing standards that make it almost unnecessary. Today and in the long run, you'll be glad you chose Maxell.

Consider this: Every time you take your disk for a little spin, you expose it to hazardous drive conditions. Temperature build-up can sidetrack data. Worse, take it to the point of no return. Maxell's unique jacket construction defies heat of 140°F. And keeps your information on track.

And Maxell runs clean. A unique process impregnates lubricants throughout the oxide layer. Extending media and head life. How good is Gold? Maxell's the disk that many drive manufacturers trust to put new equipment through its paces. It's that bug-free.

So you can drive a bargain. But in accelerated tests, Maxell floppys lead the industry in error-free performance and durability. Proving that if you can't stand the heat you don't stand a chance.





maxell®

IT'S WORTH IT.

Maxell Corporation of America
60 Oxford Drive, Moonachie, N.J. 07074
201-440-8020

Circle 236 on inquiry card.



THE UNDERRATED VIRTUES OF PLAIN VANILLA

Our Lemon has hogged the limelight, our Lime has made it to the White House, and our Orange and Peach have shared in the glory too. But there's a band of unsung heroes in the shadows with all of the surge protecting, noise filtering capabilities of their colorful cousins, with the same insured lifetime guarantee, and the same expert technology of EPD.

The only difference is color. (Or lack of it).

The Electro-Clamp™ line from EPD is made to do the same job, but blend into more sedate surroundings with its quiet, neutral exterior. The four Electro-Clamps share the same specifications as The Lemon™, The Lime™, The Peach™ and The Orange™, so if your needs for surge protection lean toward the conservative, choose Electro-Clamp™ I, II, IV, or V.

Remember, technology is more than skin deep.

DON'T PLUG IN WITHOUT US.



Electronic Protection Devices Inc.
P.O. Box 673, Waltham, MA 02254
(617) 891-6602 • 1-800-343-1813

Circle 151 on inquiry card.



Build the Circuit Cellar Term-Mite ST Smart Terminal

Part 1: Hardware

National Semiconductor's NS455A Terminal-Management Processor permits an easy, economical terminal design

by Steve Ciarcia

Did the the personal computer revolution begin in 1975 with the MITS Altair 8800 microcomputer? Most people think so, but I believe that the first personal computer product appeared two years earlier under the unassuming name of TV Typewriter. This construction project, described by Don Lancaster in *Radio Electronics* magazine (see reference 6) was a simple video-display terminal, a basic building block for those of us who were dreaming about building a computer. The circuit logic was a wiring nightmare of controlled race conditions, but it worked. Of course, its uppercase-only 16-line by 64-column display and total ignorance of control codes (it didn't even scroll) seem primitive today.

A few months after Don's article was published, the Mark 8 computer project appeared in *Radio Electronics* (see reference 10). The Mark 8, based on the Intel 8008 microprocessor, was the first real microcomputer (though the word had not yet been coined) and was the trigger that launched me and many others into the microcomputer hobby. Many of us who had built Don's terminal might not have been otherwise able to comprehend and use the Mark 8 as quickly as we did. (I built something different from the Mark 8, but the first article I ever wrote was for the Mark 8 constructor's newsletter. Coincidentally, my first BYTE article described how to

build a vector-graphics display for an 8008-based system—see reference 2.)

Advancing Display Technology

Wiring up the TV Typewriter was a monumental job, but the basic circuit was really not unlike a commercial video-display terminal of the same period. If you ever opened the case of a video terminal from the early 1970s, you were probably amazed at the complexity. There were usually several large printed-circuit boards (each containing 70 to 100 integrated circuits), a large power supply, the keyboard, wires and diodes, and of course the cathode-ray tube (CRT) replete with high-voltage wires and "Danger—Do Not Touch" signs.

These early terminals were basically "glass Teletypes," performing only simple functions and displaying only uppercase characters. The lack of sophistication matched the level of integrated-circuit (IC) technology available at the time.

Many discrete logic circuits were needed to detect even the simplest functions such as linefeed and cursor-home. Each command was treated independently by the hardware: it was necessary to have separate circuitry to detect each control character and cause the appropriate function to occur. For instance, for the terminal to respond correctly to the ASCII (American National Standard Code for Information Interchange) Return character, the terminal-control logic had to be able to detect when

a hexadecimal 0D value was received from the host computer or typed on the keyboard, to change the current cursor position to the beginning of the line, and possibly to scroll the screen up one line (if automatic linefeed is on) and blank the new line. Connecting sets of NAND and NOR gates to accomplish this is a considerable task.

For a long time, advances in IC technology were met by demands for increased performance in terminals. The first real simplifying breakthrough came with the microprocessor. Using the power of this new development, designers could implement features that had been prohibitively expensive and could freely add new functions to terminals. Off-line editing with character insertion and deletion, function keys with multiple-character transmission, and multiple-page display memories were just a few of the features that found their way into the terminal marketplace. And as microprocessors became more advanced, terminals incorporating the latest silicon intelligence could no longer be called "dumb." The watchword in the terminal trade became *smart*.

Somewhat surprisingly, the first microprocessor-based intelligent terminals were no less complicated inside than the dumb variety. Computer circuitry had replaced much of the discrete logic, but the expanded functions had also necessitated increased complexity in the low-level display-driver circuitry. An integrated

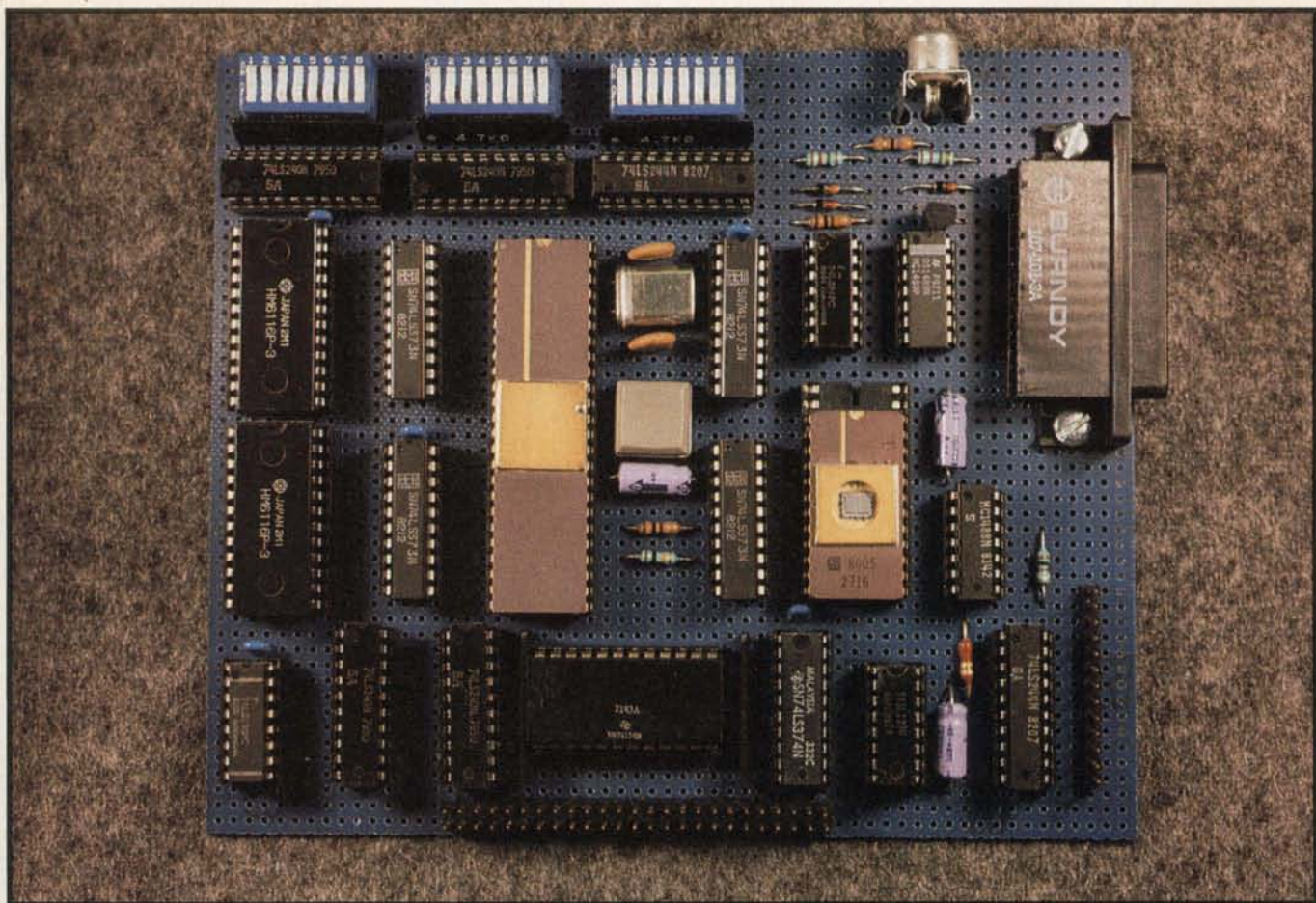

Photo 1: The prototype board of the Term-Mite ST intelligent video-display terminal.

solution to discrete video circuitry was needed.

The second technological achievement resulting in lower circuit complexity was the development of integrated CRT-controller (or video-controller) chips, such as the National Semiconductor DP8350 and the Intel 8275. Usually used in combination with a microprocessor, programmable CRT controllers incorporate many of the discrete counters, registers, and character-attribute circuits needed in a modern terminal. (See references 5 and 9.)

The new controller chips made it easy to do tricks with character attributes: blinking, blanked, or underlined characters; half-intensity or reverse video; and expansion to double height, double width, or both. Also, a terminal manufacturer could now easily make a whole family of terminals just by changing the control firmware. Either a simple "glass Teletype" model or a sophisticated editing terminal with write-protected

fields and multiple display pages could be built with only minor hardware differences simply by changing the programs controlling the microprocessors. Figure 1 on pages 40 and 41 should give you an idea of how the combination of the microprocessor and the video-controller chip served

to make hardware design much simpler while again increasing the terminals' sophistication.

For a long time now I've wanted to present a smart-terminal project from the Circuit Cellar, but even with the reduced circuit complexity afforded by a CRT controller I've never been

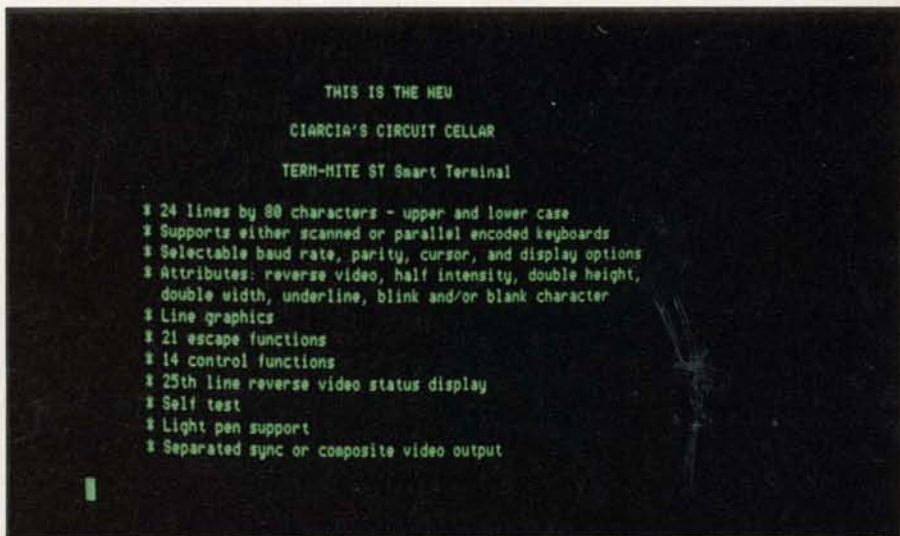

Photo 2: Unretouched photo of the Term-Mite's screen.

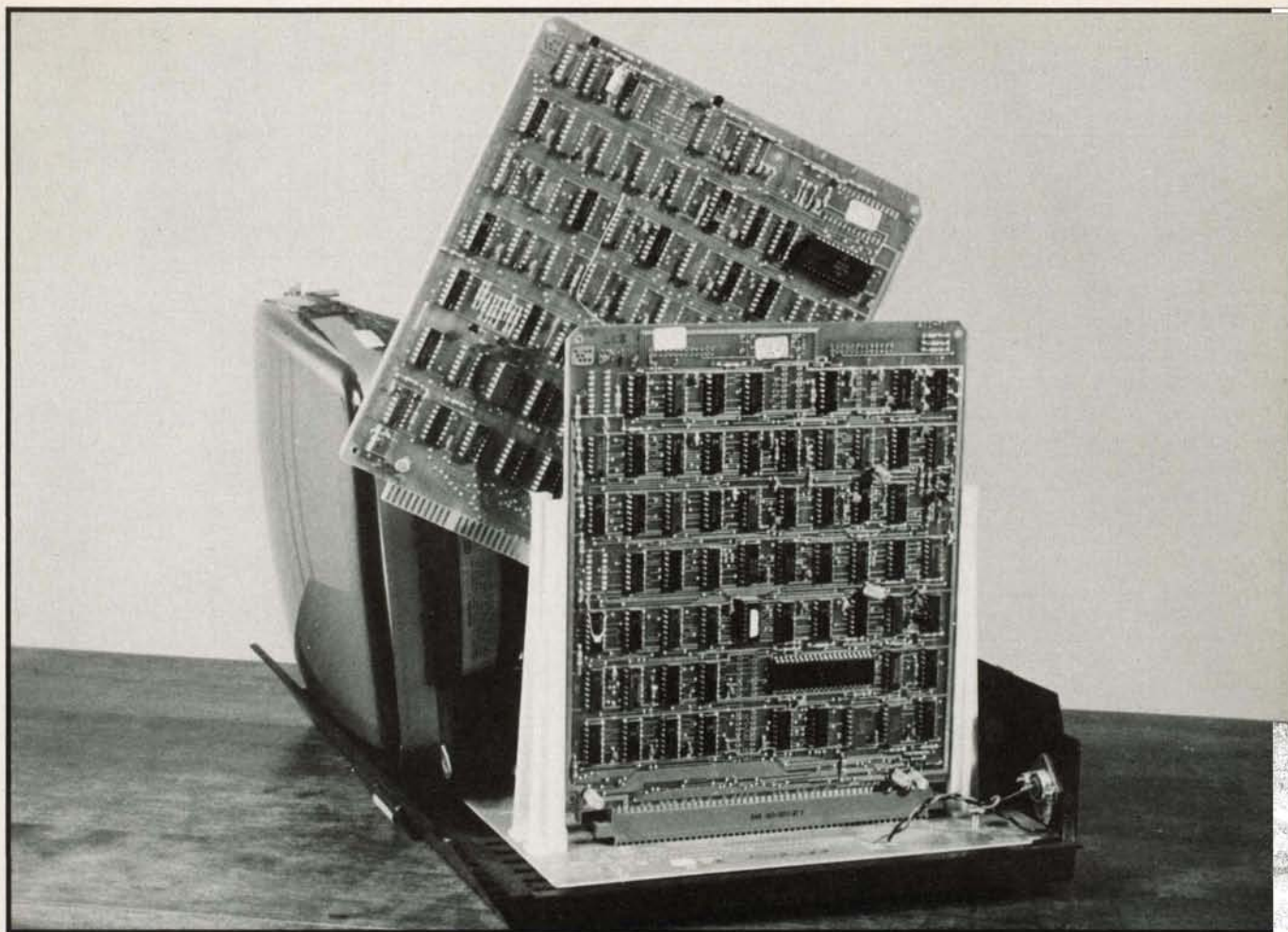

Photo 3: Video terminals designed only a few years ago had to use over 100 discrete-logic circuits to obtain even rudimentary control functions.

able to devise a reasonable design containing fewer than about 30 IC packages. (Yes, the MPX-16 computer I began in November 1982 does contain 121 chips, but my battle scars from that project still pain me at times.) While I was still deliberating, developments in technology caught up with me.

Semiconductor makers had provided both crucial elements: the microprocessor and the CRT controller. The next logical step was to incorporate their functions into a single IC package. National Semiconductor Corporation has done just that, and more, with the NS455A *Terminal-Management Processor* (TMP). Incorporating most of the processor, video, and communication functions in a single 48-pin dual-inline package, the NS455A allows the design engineer to reduce a terminal's chip count while maintaining a high level of performance. Just six chips can perform

the basic operations.

In two articles, this month and next, we'll look at the NS455A's characteristics and see how to build an intelligent video terminal, called the Term-Mite ST, which is equal to many on the market costing \$1000 or more. Its 21-chip design provides the most-needed features, as shown in table 1, such as 24 lines of 80 characters each, uppercase and lowercase; a full set of character attributes; and line (block) graphics. A block diagram of the Term-Mite ST terminal appears in figure 2.

Inside the NS455A TMP

Integrated into the NS455A TMP are all the system-control functions except the video RAM (the random-access read/write memory used to store the display data) and I/O (input/output) buffers. The TMP replaces the separate microprocessor, program ROM (read-only memory), CRT

controller, DMA (direct memory access) logic, character generator, UART (universal asynchronous receiver/transmitter), and data-rate generator typically used in other terminal designs. In place of these, the TMP provides a control processor, display-timing control circuitry, and direct interface logic for the keyboard, monitor, memory, and serial communication.

A complete listing of the NS455A's capabilities is shown in table 2, while figure 3 on page 43 shows a pinout diagram (3a) and a block diagram (3b). The architecture and instruction set for the TMP are derived, with some differences, from that of the Intel 8048-series of microprocessors. Extra instructions have been added and the architecture tailored to allow the NS455A to serve more efficiently as a terminal controller. Within the TMP are three distinct functional sections: processor, I/O, and display

(1a)

DISCRETE LOGIC

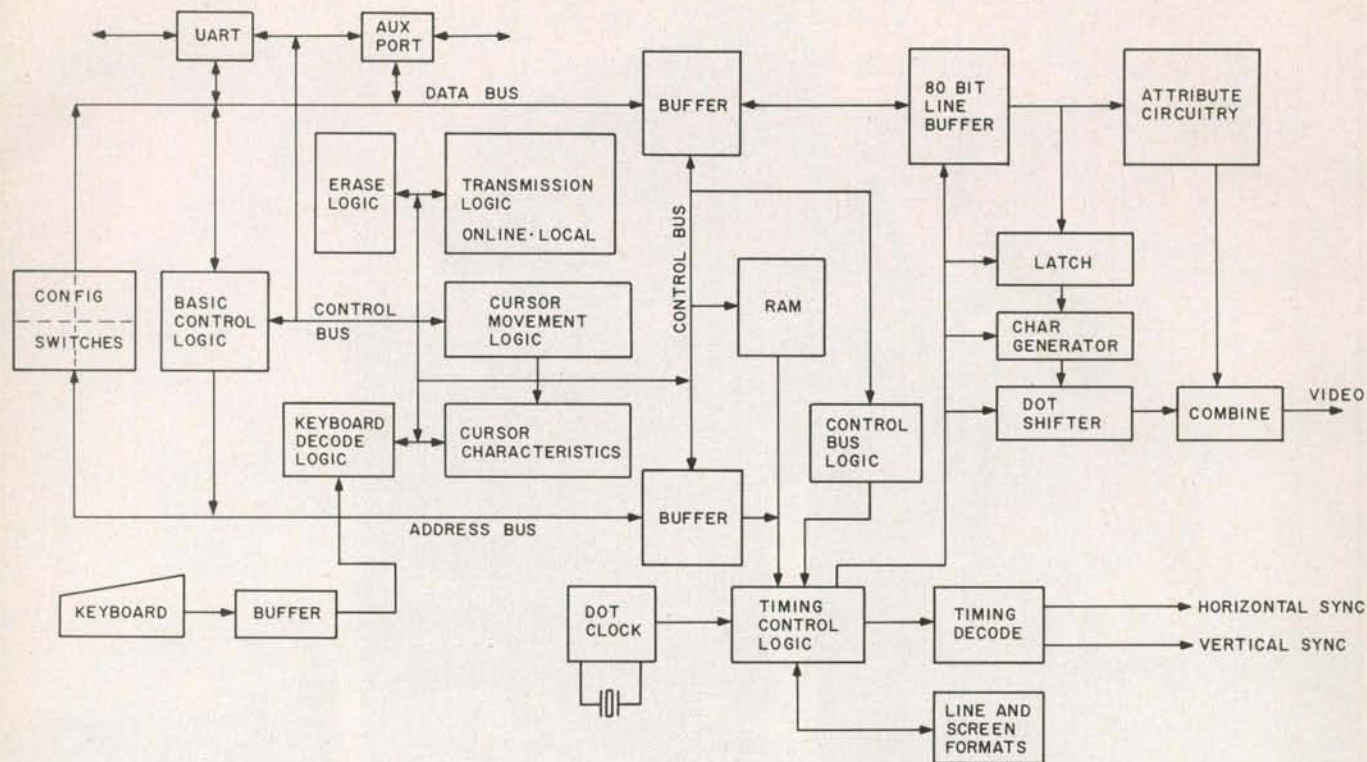

(1b)

MICROPROCESSOR AND CRT CONTROLLER

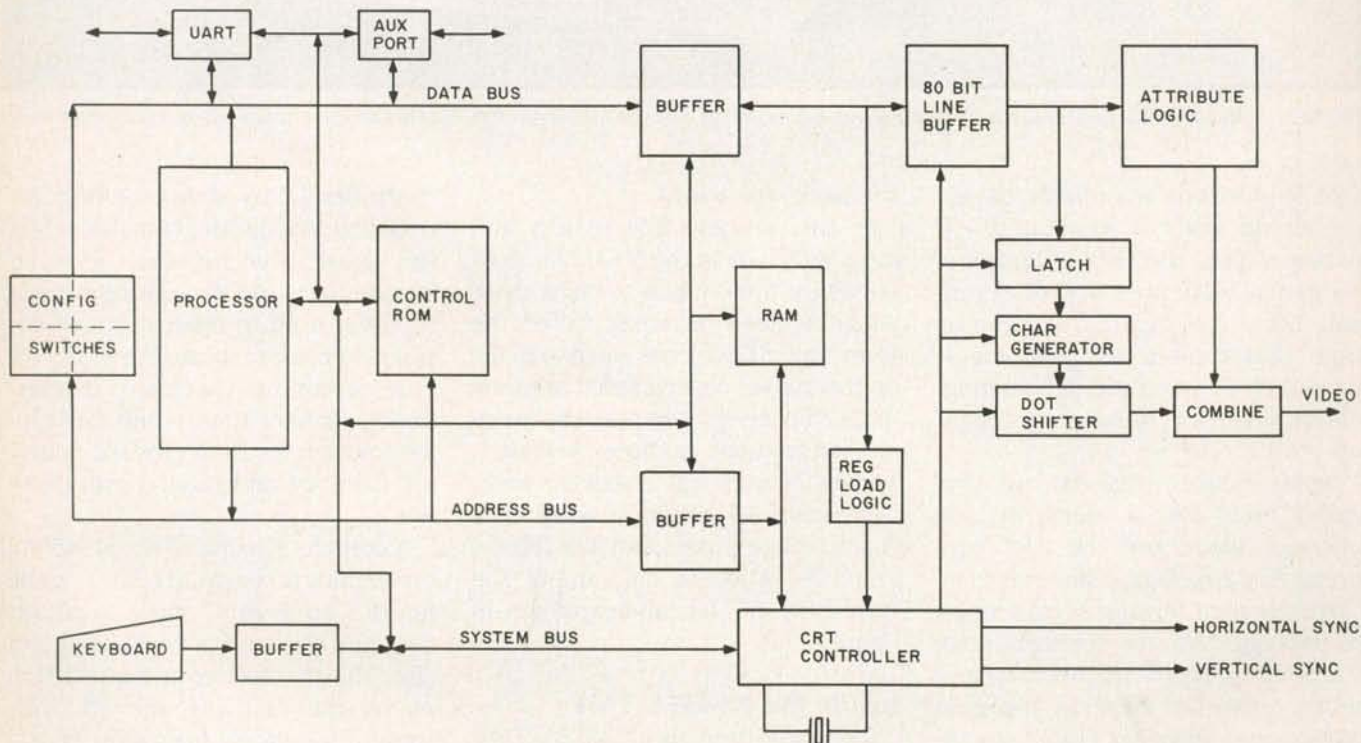

driver. Let's look at each of these in turn.

Processor and Memory

Since the processor in the TMP is a modified implementation of the

Intel 8048 architecture, I'll review the 8048 to make comparison easier.

The basic 8048 was designed as a self-contained microprocessor; it includes ROM for its factory-set permanent program as well as temporary

storage in the form of scratch-pad RAM. It operates on 8-bit data but has an 11-bit program-counter (PC) register, so that it can address up to 2K bytes of program. The standard 8048 has an eight-entry fixed-size

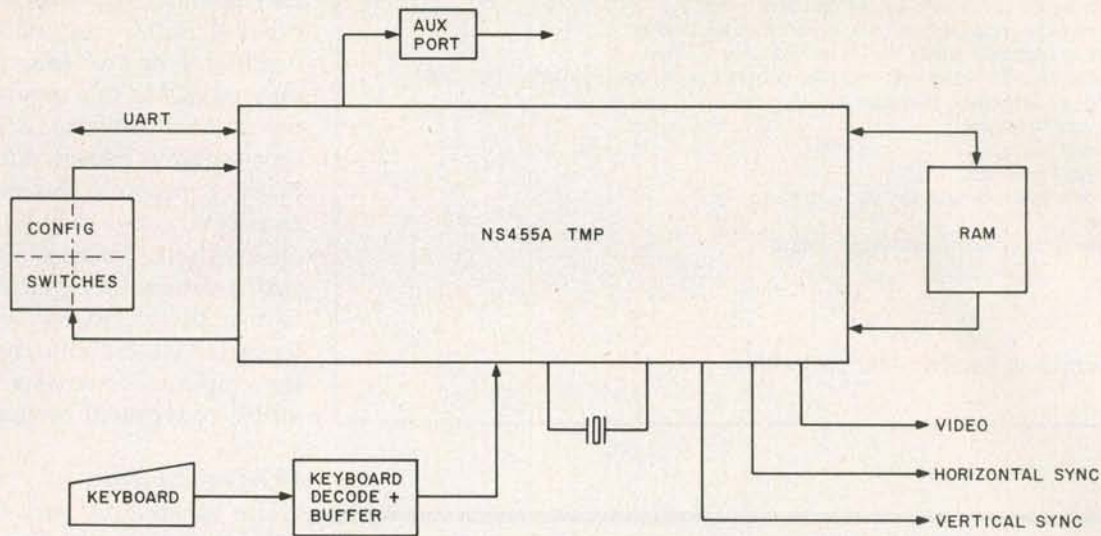

Figure 1: Three generations of video-display terminals become increasingly less complex as semiconductor technology advances.

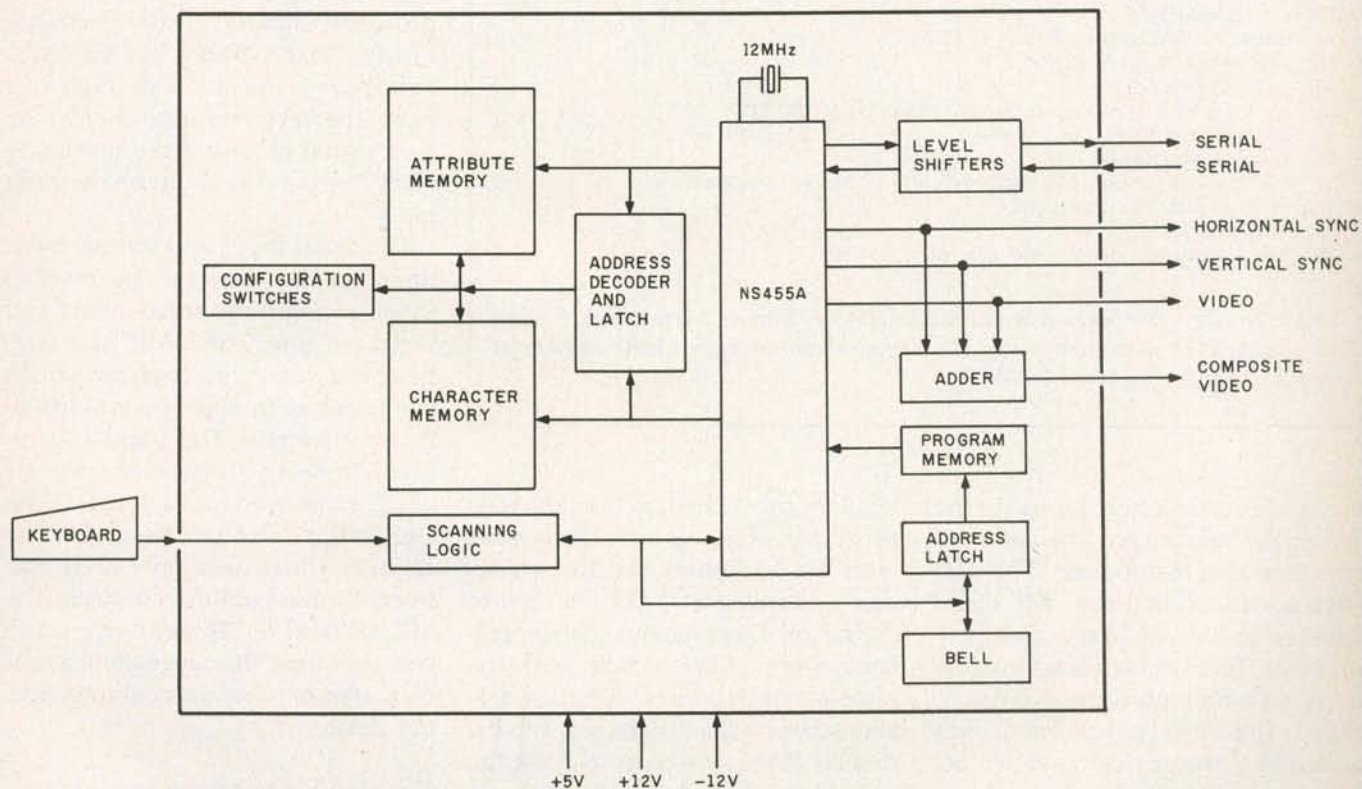

Figure 2: A block diagram of the Term-Mite ST terminal circuit board.

stack used to store return addresses during subroutine calls and interrupt handling; the stack pointer consists of 3 reserved bits in the processor status word (PSW). A set of general registers in the RAM, R0 through R7,

can be used for fast-access storage. In addition, an alternate register bank, also located in the on-chip RAM area, can be selected and used just like the primary set. Finally, the standard 8048 has three parallel I/O ports,

which can be used to communicate with external peripherals or to address additional memory. (I used the 8748, a cousin of the 8048, in my recent H-Com project; see reference 3.)

When National Semiconductor en-

1. 24 lines by 80 characters, uppercase and lowercase
2. supports either scanned or parallel-encoded keyboards
3. selectable data-rate, parity, cursor, and display options
4. attributes: reverse video, half intensity, double height, double width, underlined, blinking, and/or blank character
5. 21 Escape functions
6. 14 Control functions
7. line (block) graphics
8. twenty-fifth-line reverse-video status display
9. self-test
10. separate-sync or composite-video output

Table 1: Features of the Term-Mite ST terminal.

1. enhanced 8048 instruction set and architecture
2. on-board ROM, 2K by 8-bit; up to 8K by 8-bit external
3. on-board RAM, 64 by 8-bit
4. programmable display format
5. 16-bit display-memory bus (direct-video and attribute-RAM interface)
6. built-in timer
7. real-time clock (may be programmed for 1 Hz)
8. video-control signals
9. eight independent character attributes
10. pixel graphics
11. programmable cursor
12. CRT refresh at 50 or 60 Hz
13. light-pen support
14. on-board UART, programmable data rate up to 19,200 bps
15. character generator (128 characters in 7- by 11-dot character area)
16. single +5-V (volt) supply
17. interface compatibility with popular 8- and 16-bit microprocessors
18. up to 18-MHz clock frequency
19. 48-pin package
20. 8-bit parallel port (multiplexed with external ROM)

Table 2: Features of the National Semiconductor NS455A Terminal-Management Processor. This integrated circuit normally comes with a terminal-control program mask-programmed into the 2K bytes of on-board ROM.

hanced the architecture for use in the Terminal-Management Processor, instructions that manipulate 16-bit data were added, so that the TMP could manage up to 64K bytes of display memory. To support these instructions, an 8-bit high-order extension, called the *high accumulator*, was added to the existing 8-bit accumulator. In addition, 8-bit high-order extensions were added to the R0 and R1 registers to allow them to point to the full 64K bytes of display RAM. The original roster of three I/O ports was trimmed to a single bidirectional port, and 2 more bits were added to the program counter to accommodate up to 8K bytes of program storage.

All the other changes from the 8048 processor were directly associated with the additional tasks of video-display driving and I/O required to do the job. Display-management registers were added to help with the screen-refresh chores. A cursor register serves to load characters into the display RAM as well as to mark the current cursor position. A whole set of video-timing-chain registers is used to set the display configuration for the screen: how many characters per line, how many lines per frame, horizontal and vertical synchronization timing, etc.

While the characters to be displayed are stored in RAM, the program that drives the NS455A's pro-

cessor resides in ROM. The NS455A may operate with either internal or external ROM; external ROM may function all by itself (disregarding the internal ROM), or it may supplement the internal program. Although address space is provided for up to 8K bytes of program, the standard on-chip ROM size is only 2K bytes. The off-the-shelf NS455A TMP comes with a standard program, masked into the 2K-byte ROM, which is intended to illustrate the capabilities of the chip and serve as a tutorial example of terminal programming.

I/O-Port Section

The single I/O port is an 8-bit bidirectional parallel type, with data transferred on pins RE0 through RE7. It is written into and read from using the processor instructions OUT PORT and IN PORT. In the Term-Mite ST, the encoded keyboard is read and the RS-232C handshaking-protocol signals (Data Terminal Ready, Clear to Send, and Ready to Send) are transmitted through this port. The keyboard uses only 7 bits, so a signal to sound the terminal's "bell" beeper is sent out on the extra bit.

The serial input and output functions are handled by the on-chip UART through the serial-in line and serial-out line. The UART also contains the data-rate generator, which can be set up by software for virtually any data rate. The standard program, however, contains only the set of 12 most-used rates from 110 to 19,200 bps (bits per second). The serial I/O lines need only to be buffered by level-shifting devices (the MC1488 and MC1489) to give you a complete RS-232C data path to a host computer or other data-communicating device.

Display-Driver Section

The third section is the video-display driver and control section. It is made up of the character generator, the CRT-refresh logic, the character-attribute logic, and many now-integrated, formerly discrete functions. Because the NS455A provides all these capabilities by itself, the only additional ICs needed are display

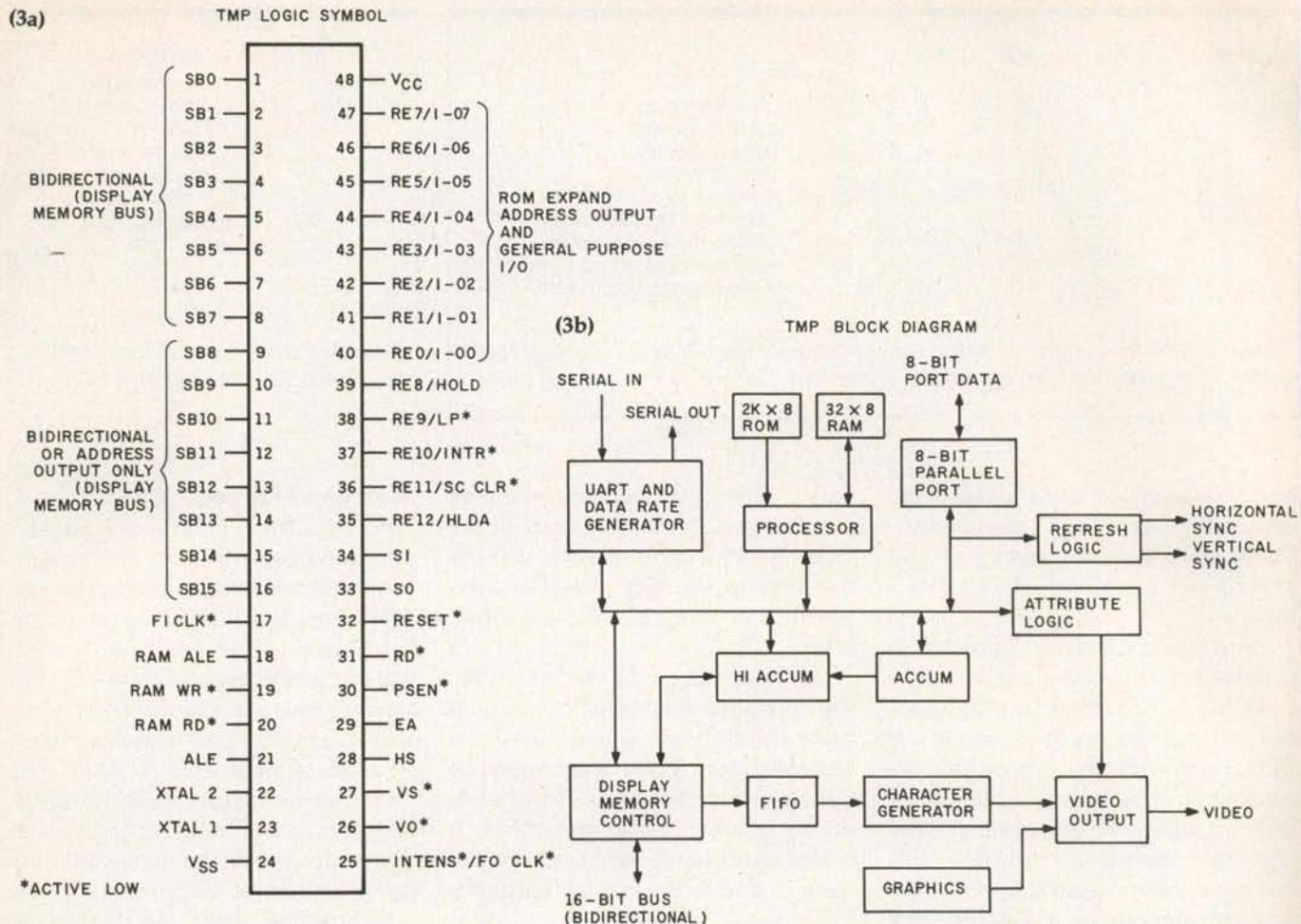

Figure 3: A pinout diagram (3a) and a block diagram (3b) of the National Semiconductor NS455A TMP.

memory, an RS-232C buffer and a driver, and a bus-interface latch or two. In fact, an absolutely minimal video terminal could be constructed from 6 chips, and a relatively high-performance unit could be built from only 15.

You may not be as familiar with the complex workings of the CRT driver and control section as with the other two preceding sections. Indeed, because the screen image must be refreshed 60 times every second, the video circuitry stays very busy. The best way to see what happens is to follow a character from display memory until it appears on the screen.

First, the character is read by the display-access logic from the display RAM into the FIFO buffer (a small first-in, first-out storage area). The FIFO buffer contains only four entries, but it is needed so that the processor and display-refresh logic,

which both require continual access to the RAM, will not contend with each other for that access.

(The refresh logic has to push characters through the analog video section at a constant rate; if the refreshing is delayed, the display will flicker where characters or parts of the image are being missed. In older designs using CRT-controller chips, the usual technique was to allow the processor to run only during the horizontal and vertical retrace times of the electron beam—barely 40 percent of the time. Such approaches, once considered necessary, can severely limit throughput; you can recognize the terminals that employ this scheme as the ones whose displays flicker when they are updated.)

A FIFO buffer solves the problem. The refresh logic can fill the buffer faster than the video logic can empty it, so when the buffer is sufficiently

full, the processor is allowed to grab and use a display-memory cycle. The processor has to be held off only intermittently, and then not for very long.

As the character code leaves the FIFO buffer, the proper pattern of display dots (picture elements, or pixels) in a bit-mapped dot matrix is selected by the character generator according to the character's shape. What dot value leaves the generator at a given instant depends not only on what the character is but also the current scan line (vertical position) of the video raster. In the case of the Term-Mite ST, the character information is retrieved from the character generator's ROM, where the dot patterns are stored, using the ASCII code value as a high-order address; the scan-line position is used to set up the low-order address bits. The dots for all the characters in a scan

Strobe Number	A15	A14	A13	A12	
0	0	0	0	x	page 0 memory
1	0	0	1	x	page 1 memory
2	0	1	0	x	page 2 memory
3	0	1	1	x	page 3 memory
4	1	0	0	x	terminal-characteristics switch
5	1	0	1	x	miscellaneous-status switch
6	1	1	0	x	UART-configuration switch
7	1	1	1	0	scanned keyboard-input port
8	1	1	1	1	auxiliary/printer-output port

Table 3: Memory-mapped I/O addressing as used in the Term-Mite ST. The final hardware of the project does not support the printer port.

Bit	Attribute
0	reverse video
1	half intensity
2	blinking
3	double height
4	double width
5	underlined
6	blanked
7	graphics

Table 4: Character attributes supported by the NS455A in the Term-Mite ST.

line are assembled into a parallel field containing dark and bright dots. These dots are then serialized and shifted out to the screen, one at a time.

Information on other character attributes may be sent along with the basic black- or white-dot data. Specialized logic was incorporated in the 455A to modify the dot output according to the display attributes selected, but, generally speaking, the logical process for accomplishing this has not changed from that previously implemented by many external logic gates.

Eight special character attributes are provided by the 455A: blinking, double height, double width, graphics, half intensity, reverse video, underlined, and blanked character. A terminal built around the 455A can specify the attributes in two ways: internally or externally.

Internal attributes make use of two attribute latches (AL0 and AL1) inside the TMP chip. These latches can be read by external circuitry. Their states are determined by the most significant bit (MSB) in the character-code byte (the character set is therefore limited to the 128 standard ASCII 7-bit characters). If the MSB is a 0, AL0 is activated; if the MSB is a 1, AL1 is activated. The latch status and the incoming character dot values completely specify the final appearance of the displayed character.

When the TMP is configured for *external attributes*, a 16-bit-wide display memory is used. The lower 8 bits specify the character, and the upper 8 bits are used to handle the attribute

data. Although this arrangement doubles the memory needed in the video RAM section, it gives you the freedom to use any possible combination of attributes for any character.

The remaining video logic involves the horizontal sync (synchronization) pulse and the vertical sync pulse. The horizontal sync pulse is generated by the video circuitry in the TMP, but its timing is under program control. It is the terminal designer's responsibility to decide the crystal frequency

A terminal built around the 455A can specify attributes in two ways: internally or externally.

used to drive the TMP, the number of characters per line, the size of the character cell, and the tolerances of the CRT's driver circuits. In most cases, all of these variables must yield something close to 15,750 Hz (hertz) for the frequency of the horizontal sync signal; the frequency must allow the display of 80 characters per line plus enough time to permit the electron beam to retrace to the beginning of the next scan line. The vertical sync pulse will occur at either 50 or 60 Hz depending on where in the world the terminal is to be used (in North America 60 Hz would be used). The necessary programming has already been done in the standard NS455A and in my Term-Mite ST project.

Memory-Mapped I/O

Because there is only one parallel port and one serial port, I/O by conventional methods is limited in the TMP. But, fortunately, by mapping I/O registers into memory addresses, you can greatly expand the TMP's I/O capabilities. (See reference 4.) For example, a printer port could be placed at address hexadecimal F000. The processor would just act like it is putting data into a memory location at that address, but the data would actually be sent to the printer.

Technically, there are 16 bits of memory-address space, which could in theory define 64K (65,536) I/O locations. However, it's only necessary to put in circuits to decode only the 4 high-order bits to designate nine specific memory-address allocations. These are listed in table 3. As with all construction projects, I had to observe practical limits when I froze the design. Even though the NS455A can support the printer port, the Term-Mite ST as presented in this article does not incorporate it, and only eight of the nine I/O addresses are available.

Term-Mite ST Design Details

The Term-Mite ST is an intelligent video-display terminal built from 21 integrated circuits (or 18 if you use a parallel-encoded keyboard). Shown in the schematic diagram of figure 4 on page 46, the circuit is intended to operate with the same ordinary 2K-byte terminal-control program mask-programmed into the generic NS455A but contained instead in a 2K-byte type-2716 EPROM (erasable

Number	Type	+5 V	GND	+12 V	-12 V	Number	Type	+5 V	GND	+12 V	-12 V
IC1	6116	24	12			IC12	74LS373	20	10		
IC2	6116	24	12			IC13	74LS373	20	10		
IC3	74LS373	20	10			IC14	2716	24	12		
IC4	74LS373	20	10			IC15	74LS374	20	10		
IC5	74LS138	16	8			IC16	74LS154	24	12		
IC6	74LS240	20	10			IC17	74LS123	16	8		
IC7	74LS240	20	10			IC18	74LS244	20	10		
IC8	74LS240	20	10			IC19	MC1488	7		14	1
IC9	74LS240	20	10			IC20	MC1489	14	7		
IC10	74LS240	20	10			IC21	74LS86	14	7		
IC11	NS455	48	24								

Table 5: Power connections for integrated circuits in figure 4 (page 46). Another EPROM could be substituted for the 2716 in some applications.

programmable ROM). The Term-Mite ST could potentially handle up to 8K bytes of external program memory (a type-2764 EPROM), which would allow the control program to be enhanced—perhaps to include more features or to emulate the display protocols of popular commercially sold terminals.

The display format is 24 lines of 80 characters, with a 25th reverse-video status line. The particular TMP version I have chosen uses a 12-MHz crystal and displays characters in a 5-by 7-dot matrix in a 7-by 10-dot character area. The masked program automatically configures the correct horizontal and vertical frequencies.

In figure 4, IC1 through IC5 constitute the video-display memory section. Two type-6116 static RAM chips (IC1, IC2) form a 2K-word display memory of 16-bit words. The low-byte chip (IC2) contains the ASCII character codes, while the high-byte chip (IC1) holds the screen attributes. The attributes supported are listed in table 4, with their relation to bits in IC1 shown.

IC3 and IC4 are the type-74LS373 address latches for the display memory. When any access to external display memory occurs, the address of the location is set on lines SB0 through SB15 and loaded into these two latches on the occurrence of the address-latch-enable strobe (RAM ALE) signal. Address bits A12 through A15 are decoded through a 74LS138 (IC5) to provide eight enable lines for the memory-mapped I/O as described previously. Depending upon whether the instruction is a

memory-read or memory-write operation, either the active-low $\overline{\text{RAM RD}}$ or $\overline{\text{RAM WR}}$ line will be logic 0 (active).

Not all the decoded address-strobe signals are used in the Term-Mite ST, and only eight of the nine possible are implemented. To cut down on the number of chips, I decided to limit the display memory to a single 4K-byte page and not include a printer-output port. The software as supplied still supports four pages and the printer, so you may expand on

**As with all
construction projects
I had to observe
practical limits when
I froze the design.**

the basic design if you feel resourceful and feel like wiring a few more chips.

The remaining memory-mapped I/O devices are three configuration switches (buffered through IC6, 7, and 8—three 74LS240 chips) and 12 bits of scanned keyboard data (buffered through IC9 and 10). Each device is addressed and its data gated onto the bus during the $\overline{\text{RAM RD}}$ pulse. Next month I'll describe these switches and the scanning logic in greater detail.

On the right-hand side of the TMP (IC11) is the program-memory (EPROM) and user-I/O circuitry. In a process similar to that described for the display memory, an address is

loaded into the latches IC12 and IC13 during the active state of the ROM ALE; the EPROM data is read during the $\overline{\text{PSEN}}$ pulse. Type-2716, -2732, or -2764 EPROMs may be used (with proper jumper selection).

A parallel keyboard, instead of a scanned keyboard, may be connected to the Term-Mite ST through the type-74LS244 buffer IC18. Of the 8-bit input port, 7 bits are used to transfer ASCII data, while the eighth bit is borrowed for RS-232C handshaking. The keyboard strobe (active-low) connects directly to the RE10 TMP line and generates an interrupt when active.

Serial communication is handled directly by the TMP through an on-board UART. The data rate and protocol are set via configuration switches, and full handshaking is supported. The MC1488 buffer and MC1489 driver are connected directly to the TMP.

The TMP also has a direct output line for a bell signal trigger. The pulse is generated whenever a Control-G code is output or whenever the cursor reaches column 72 on the display screen. The trigger pulse is only a few microseconds long, so that a monostable multivibrator, or one-shot (IC17), is needed to stretch the pulse and drive a self-contained piezoelectric transducer.

Video output from the TMP is in the form of separate horizontal sync, vertical sync, and luminance signals. IC21, in combination with some discrete components, merges these to generate a composite-video signal. Because of the wide bandwidth re-

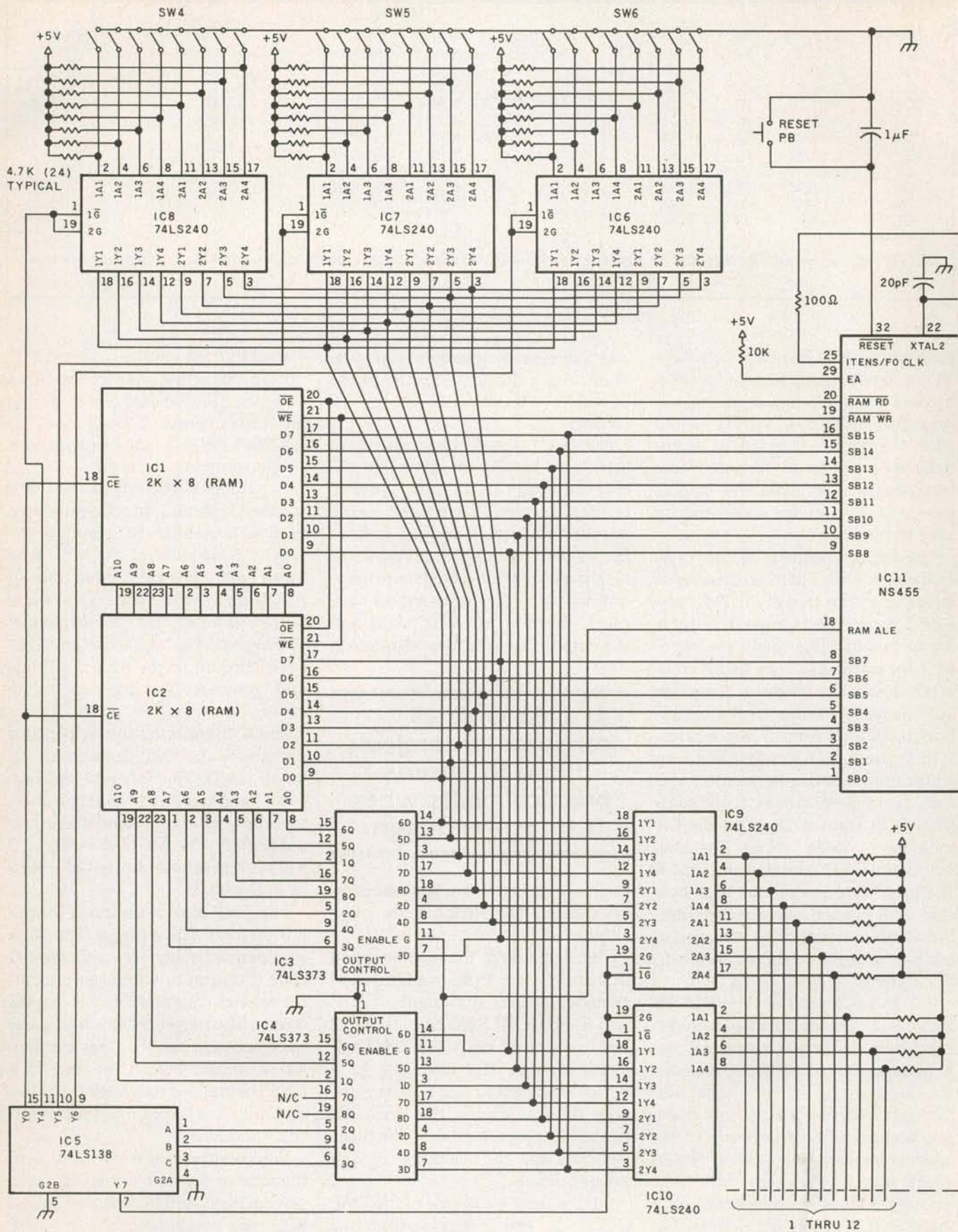
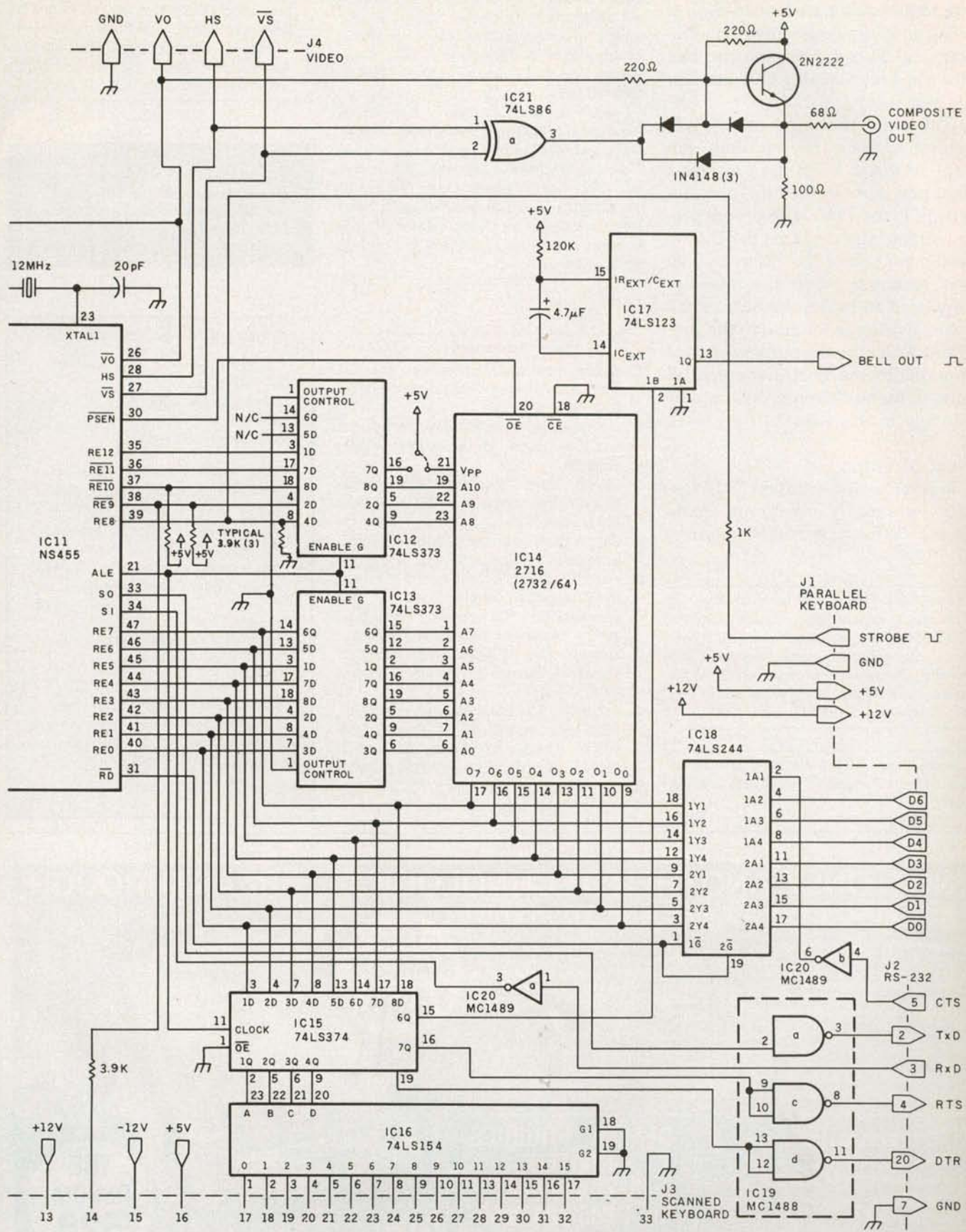

Figure 4: Schematic diagram of the Term-Mite ST. The NS455A's usual stock terminal-control program is here contained in a 2K-byte type-2716 EPROM (erasable programmable ROM).



quired for the 80-column display, you would probably have limited success using an RF (radio-frequency) modulator and TV set. I recommend that you use a high-quality CRT monitor for best results.

Although the current 2K-byte control-software release does not support it, the hardware provides a light-pen input in the form of an interrupt to the TMP. With proper programming, you could get the TMP to remember where the electron beam was scanning when the interrupt happened and subsequently return a value giving the location to the program. And with the proper software running in the host computer, all sorts of menu-driven tasks could be handled in this way.

Next Month:

In part 2 we'll examine the TMP software more closely and explain exactly what all the Escape and control sequences do.

Steve Ciarcia (pronounced "see-ARE-see-ah") is an electronics engineer and computer consultant with experience in process control, digital design, nuclear instrumentation, product development, and marketing. In addition to writing for BYTE, he has published several books. He can be contacted at POB 582, Glastonbury, CT 06033.

Special thanks to Bob Harbrecht of National Semiconductor Corporation for his help with this project.

Editor's Note: Steve often refers to previous Circuit Cellar articles as reference material for each month's current article. Most of these past articles are available in reprint books from BYTE Books, McGraw-Hill Book Company, POB 400, Hightstown, NJ 08250.

Ciarcia's Circuit Cellar, Volume I covers articles that appeared in BYTE from September 1977 through November 1978. Ciarcia's Circuit Cellar, Volume II contains articles from December 1978 through June 1980. Ciarcia's Circuit Cellar, Volume III contains articles from July 1980 through December 1981. Ciarcia's Circuit Cellar, Volume IV, soon to appear, will contain articles from January 1982 through June 1983.

References

1. Cayton, Brian, and Mort Herman. "The CRT 9007 Video Processor and Controller." BYTE, April 1983, page 96.
2. Ciarcia, Steve. "Make Your Next Peripheral a Real Eye Opener." BYTE, November 1976, page 78.
3. Ciarcia, Steve. "Build the H-Com Handicapped Communicator." BYTE, November 1983, page 36.
4. Ciarcia, Steve. "Memory-Mapped I/O." BYTE, November 1977, page 10.
5. Haas, Bob. "Single Chip Video Controller." BYTE, May 1979, page 52.
6. Lancaster, Don. "TV Typewriter." *Radio Electronics*, September 1973, page 43.
7. Lancaster, Don. *TV Typewriter Cookbook*. Indianapolis: Howard W. Sams & Company, 1976.
8. Roberts, H. Edward, and William Yates. "Altair 8800 Minicomputer." Part 1, *Popular Electronics*, January 1975, page 33. Part 2, *Popular Electronics*, February 1975, page 56.
9. Tennant, Chris. "The Intel 8275 CRT Controller." BYTE, May 1979, page 130.

10. Titus, Jonathan. "Build the Mark 8 Minicomputer." *Radio Electronics*, July 1974, page 29.
11. Wierenga, Theron. "Construction of a Fourth-Generation Video Terminal." Part 1, BYTE, August 1980, page 210. Part 2, BYTE, September 1980, page 126.

To receive a complete list of Ciarcia's Circuit Cellar project kits available from the Micromint, circle 100 on the reader service inquiry card at the back of the magazine.

The following items are available from:

The Micromint

561 Willow Ave.

Cedarhurst, NY 11516

(800) 645-3479 for orders

(516) 374-6793 for information

1. Complete Term-Mite ST video-display-terminal kit including NS455A, printed-circuit board, IC sockets, DB-25S serial connector, and all other components but without keyboard or CRT monitor. Board size is approximately 4½ by 6½ inches with 0.156-inch 44-pin edge connector. Price \$239
2. Complete assembled and tested Term-Mite ST terminal circuit board. Price \$279

Please add \$5 for shipping in the continental United States and \$25 for all other countries. New York residents please add 7 percent sales tax. Allow four to six weeks for delivery.

NOT ONLY ANOTHER TECHNOLOGICAL BREAKTHROUGH BUT ALSO EASY TO USE AND TO INSTALL

Modems are the most important device used to link two products together through ordinary telephone lines at miles apart. The INCOMM STARCOM, a 300/1200 bps Auto Dial, Auto Answer, Auto Log On modem was introduced to

link two high speed devices together with having absolutely NO knowledge of computers or communications in general. Anybody can install and operate the STARCOM Family in a few minutes.

- STARCOM is a 300/1200 bps Auto Dial/Auto Log On/Auto Answer Modem.
- OSCOM is a 300/1200 bps Auto Dial/Auto Log On/Auto Answer with Osborne (TM) Computer Software (included) modem.
- COMSOFT is a communication software package.
- OEM MODEM BOARD is also available for custom installation.

FREE \$150.00 value subscription to Official Airlines Guide with purchase of each Starcom or Oscocom. Get immediate electronic access to airline fare and schedule info. OAG Electronic Edition can save you at least 30% on most business trips and could save you thousands of dollars annually!

DEALER INQUIRIES
INVITED
(312) 459-8881
or 1-800-323-2666

INCOMM

115 N. WOLF RD. WHEELING, IL 60090

THE
STARCOM
\$450.



THE
OSCOM
\$520.

SO COMPACT:

Only 1¼" x 6½" x 7½". 1.5 lbs.
Fits in your coat pocket!

"I just eliminated eye fatigue by replacing the CRT Display Tube on my computer"

Now you can eliminate the strobe, flicker and fatigue from your computer terminal with a new **Soft-View™** replacement CRT from Langley-St. Clair.

Now you can upgrade your monitor with a new European amber phosphor tube.

Available for the TRS-80,* TeleVideo, Kaypro, Heath, DEC, Zenith and a wide variety of other monitors, these new replacement display tubes use amber or green phosphors which exceed the European standards for persistence and color.

And the "decay" or fade-out rate of the phosphor is the same as the "refresh" or scanning rate of the computer screen, so the display glows gently, rather than flickering like a strobe light - an annoying problem with black & white or inexpensive green phosphor tubes.

Now, you can upgrade your terminal or computer to world-class performance with the installation of a Langley-St. Clair **Soft-View™** CRT!

Call our toll-free number to determine which tube will fit your computer or monitor.

LSIS Soft View™ CRT'S

- #DK34G Amber Phosphor w/Anti-Glare \$99.95
- #H234G Amber Phosphor w/Anti-Glare \$99.95
- #K934G Amber Phosphor w/Anti-Glare \$99.95
- #GN31G Green Phosphor w/Anti-Glare \$89.95
- #GN42 Green Phosphor \$79.95
- #GN42G Green Phosphor w/Anti-Glare \$89.95
- #OR34 Amber Phosphor \$89.95
- #OR34G Amber Phosphor w/Anti-Glare \$99.95

- Also available:
- #R22G Red Phosphor w/Anti-Glare \$139.95
 - #B22G Blue Phosphor w/Anti-Glare \$139.95

Plus: \$7.00 for packing and UPS shipping
\$17.00 for Overseas, Parcel Post or UPS Blue Label
Add Sales Tax where applicable.

Inquire about the CRT's we have available for many other computer models.

*Soft-View™ is a trademark of Langley-St. Clair Instrumentation Systems, Inc.

TRS-80, TeleVideo, Kaypro, Heath, DEC and Zenith are Registered Trademarks of Tandy Corp., TeleVideo Corp., Non Linear Systems, Inc., Heath Co., Digital Equipment Co. Corp. and Zenith.

Circle 484 on inquiry card.

- Available in slow decay green or medium decay "European Amber" (the standard in Europe).
- Made with Lead/Strontium impregnated glass that stops X-ray emission.
- High-contrast face glass that also cuts U.V. radiation.
- Frosted glass with extra Anti-Glare benefits.
- Easily installed . . . comes with pre-mounted hardware.
- Warranted for one full year against manufacturing defects or tube failure.
- Ideal for word processing and programming, yet fast enough for games and graphics.

Phil DeLaney,
KAYPRO user.

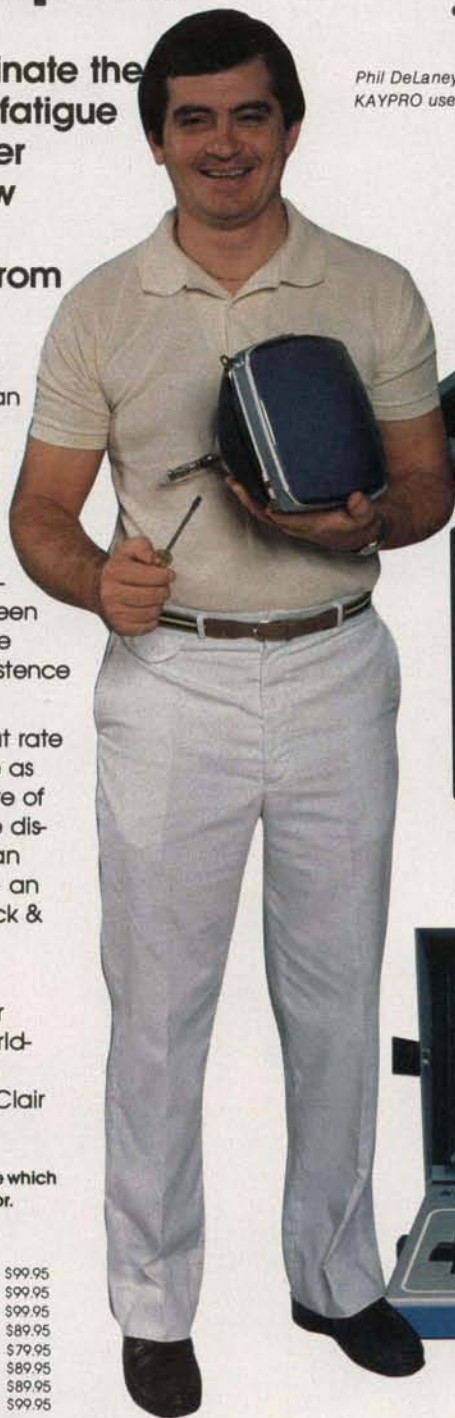

**NOW!
ALSO
FOR
IBM
PC**

To order or for more information, call:

800 221-7070

In New York call 212 989-6876

Langley-St. Clair

Instrumentation Systems, Inc.
132 W. 24th St. New York, NY 10011



PGS did it.

With the no-compromise monitor, the Princeton HX-12, PGS set the industry standard for price/performance in a high resolution RGB color monitor.

Now, we've done it again with the SR-12: our new super-resolution RGB monitor that meets the most demanding expectations at a price that will surprise you.

And PGS has set new standards in monochrome monitors, too, with the new MAX-12 amber monitor that's as easy on the eyes as it is on your budget.

The monitor to meet your needs

All three PGS monitors are engineered for no-compromise performance: to provide you with a cleaner, sharper image than any other monitor in the same price class. The HX-12 and the SR-12 both feature uncompromising color convergence for crisp whites without color bleed. The MAX-12 offers impressive clarity in a monochrome monitor with easy-on-the-eyes amber phosphor.

And all three monitors come with a shielded cable that plugs directly into the IBM PC or XT.

And does it a

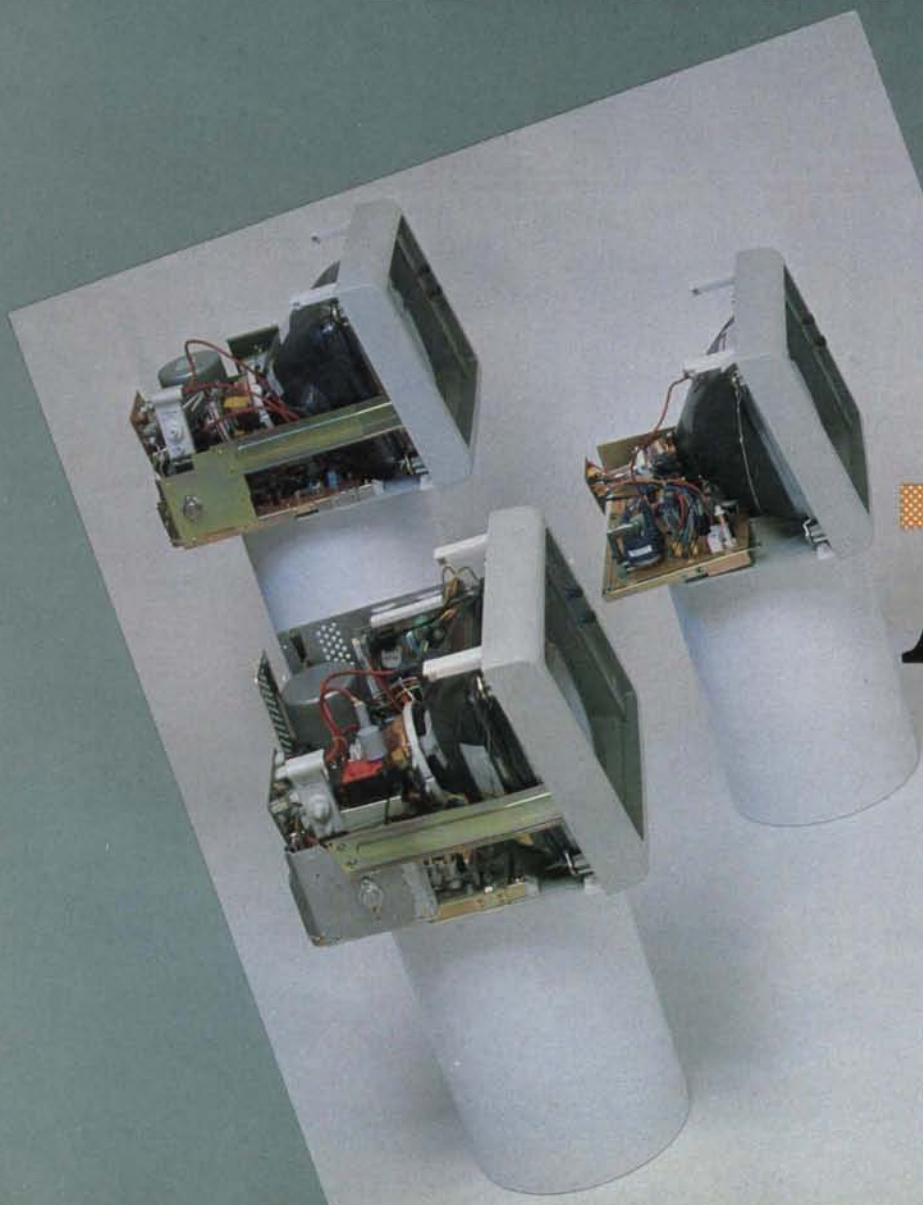

And a

Check the specifications

The HX-12 has the highest resolution (690x240) and the finest dot pitch (.31 mm) in its class. And yet its suggested retail price is comparable to many medium resolution monitors. The HX-12 brings no-compromise color to the PC and now, with the PGS RGB-80 board, to the Apple IIe as well.

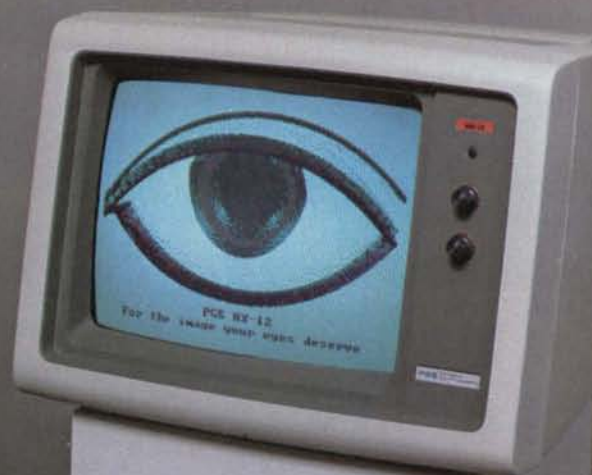

gain.

The new SR-12 also features a .31 mm dot pitch supporting 690 horizontal resolution. However, by increasing the horizontal scan rate to 31.5 KHZ, the SR-12 can support 480 vertical resolution in non-interlaced mode. This results in a very high quality, flickerless image with the ability to generate text that is truly of monochrome quality, making it equally suitable for word processing and for color graphics. Suggested retail price, a remarkable \$799.



gain.

The new MAX-12 offers you an amber monitor with 720x350 resolution at a suggested retail price (\$249) that is actually lower than the leading green-on-black competitor. And the MAX-12, unlike many other amber monitors, runs off the IBM PC monochrome card—no special card is required. Clarity of the MAX-12 is enhanced by **dynamic focusing circuitry** which ensures sharpness not only in the center but also in the edges and corners.



A non-glare screen is standard on all PGS monitors, color or monochrome—a feature your eyes will really appreciate in a long work session.

Whatever your needs, from word processing to super resolution graphics, there's now a no-compromise PGS monitor that sets the standard. Ask your dealer for a demonstration and let your eyes decide. Or call for more information and the name of your nearest dealer.

You can look to PGS for the image your eyes deserve.

800-221-1490

Circle 290 on inquiry card.

PGS Princeton Graphic Systems

1101-I State Road
Princeton New Jersey 08540
609 683-1660
TLX 6857009 PGS Prin

industry breakthrough.



NEW 2 (yes TWO!) YEAR UNCONDITIONAL WARRANTY ON ALL AMDEK MONITORS

It's new . . .

It's exciting . . .

. . . another first for the industry with Amdek's bold 2-year warranty on monitor electronics . . . and an unprecedented 3-year warranty on monitor CRT's. Yes, it includes all parts & labor! And, all warranties in existence are automatically extended to the new 2-year warranty.

Amdek has always been thoroughly committed to the highest quality standards . . . quality that's inherent in every monitor component and every connection . . . quality that's triple checked before every shipment. That's why we dare to offer this extended warranty.

You expect top quality equipment to operate trouble-free for years. We agree. This industry-first warranty is our answer to your expectations. Enjoy Amdek performance . . . and keep coming back for more!

See our complete line of color and monochrome monitors, plus the new 3" disk drive, plotters and expansion boards at your local authorized Amdek dealer.



AMDEK

2201 Lively Blvd. • Elk Grove Village, IL 60007

(312) 364-1180 TLX: 25-4786

REGIONAL OFFICES: Calif. (714) 662-3949 • Texas (817) 498-2334

Amdek . . . your guide to innovative computing!



AMDEK OFFERS LOCAL SERVICE ON MONITORS AND DISK DRIVES

Xerox Service Centers across the USA will be equipped to service and repair Amdek monitors and disk drives, including the new 3" micro-floppy-disk drives. Contact your local Amdek dealer for more details.

Beyond the Word Processor

The time has come for text-editing software to surpass the paper operations it mimics

by Phil Lemmons

To date, most personal computer software has enabled us to do familiar tasks more efficiently. With a word processor, for example, we can prepare documents, alter them, and generate clean copies more easily than is possible using a typewriter, paper, liquid correction fluid, and an eraser. While the Block Move commands in word processors make rearranging text simpler and encourage writers to revise, nothing about word processors makes it easier to create a document when the ideas are still in a formative stage or to analyze a document that is already complete.

Spreadsheets are the great exception. They let us analyze related numerical parameters in a way never before available to individuals. Some may dispute this view, saying that spreadsheets just let us look at more alternatives than we could using paper and calculator. The contribution of the spreadsheet program, in this view, is merely an improvement in efficiency over customary methods.

But spreadsheet software contributes much more than increased efficiency. As you watch the effects of changing one figure ripple through a whole model, you are able to think in larger terms than a calculator and paper allow. Furthermore, the visual rippling itself sometimes is tantamount to a graphical simulation of the problem under study. You gain a better understanding of relationships

in the model and a feeling for the probable consequences of different kinds of changes. When a change causes startling results, you realize that either the model doesn't reflect reality or the reality is different in some important way from what you thought. The spreadsheet software provides a ready means for analyzing the startling result.

The time has come for text-editing software to surpass the power of the paper operations it mimics. To date, word processors have taken conceptually complete documents and printed them out neatly. The most interesting and difficult part of preparing many text documents, however, comes much earlier—when concepts are inchoate and their interrelationships are dimly understood. Text editors for programmers have provided "macros" that permit automatic execution of a series of operations, but the operations chained are usually a series of search-and-replace operations designed to achieve a result that conforms to the rigid syntax of a programming language.

Can software help us grope through the earlier stages of text composition? Can it help us analyze finished documents?

Let's take a case in point. In the early stages of composition, the writer is thinking things through. Although the writer is putting words on paper, he or she is grappling with concepts that encompass more than single

words or phrases or even paragraphs. Take a work of fiction, for example. As the author writes, he or she thinks about large ideas such as characters, atmosphere, and plot. The author may be reflecting on the character George and whether he develops convincingly, or about how to give a scene a spooky atmosphere before George enters, or about how to build suspense before the climax. The writer thinks in terms of George's character as it extends and evolves throughout the novel. He or she thinks of the scene that is meant to be spooky as one that builds on preceding scenes and prepares for subsequent scenes and wonders how to build suspense in terms of creating and resolving tensions between characters.

Regardless of what the writer is thinking, however, the word processor can directly manipulate words and phrases only. What the word processor can directly manipulate is much smaller than what the writer's mind can directly manipulate.

How could text-editing software help the writer grapple more directly with concepts larger than words and phrases? I offer a few suggestions, again with reference to fiction. A utility called Character could extract some specifiable number of sentences before and after each occurrence of a character's name (let's call these "character blocks") and assemble all the extractions (in a

"character summary") for convenient viewing by the writer. The CHARACTER command might have switches that select specifiable kinds of information from the character blocks rather than the entire blocks. For example, verbs, adverbs, and adjectives that express feeling might all be pulled out of the manuscript to give the writer a check on the character's emotional evolution. Terms likely to be used in physical descriptions of the character might similarly be extracted. A pop-up menu headed "Character" might have these sub-headings:

- Feelings
- Physical description
- Actions
- Associations
 - People
 - Places
- Spoken words

Another command, PLACES, could extract all the passages in which the character is mentioned in connection with any country, city, town, building, room, and so on. A command called ATMOSPHERE could extract all passages containing terms of color, feeling, sound, etc., in connection with a specifiable place.

The next step in making software more useful to a writer would be to allow use of Boolean operators with these commands. It would be useful, for example, if a writer could ask for all passages containing references to both the character Tom and the room cellar.

This special text editor would gain tremendous power if it enabled the writer to insert markers that correspond to milestones, such as chapter breaks, scene breaks, climax, denouement, and so on. The other commands could then present their data in relation to the milestones. It would be handy, for example, to see how a character's feelings or actions after the climax compared with those before. Using Boolean operators along with milestones, the writer could quickly select information that shows how a character feels about a certain place both before and after the climax of the story. Since characters'

emotions are often expressed in relation to the objects around them, the combination of milestones and Boolean operators would be a powerful characterization tool.

An equally useful extension would let the writer specify a new command, a list of menu items to appear when the command is invoked, and a list of words and phrases to search whenever the writer used the command and specified a menu item.

It is worth noting that none of these suggestions for developing an editing program for writers of fiction would do anything to replace or diminish the writers' creativity. The commands would merely give the writer quick access to information that related to developing concepts in the story. The writer could check how the text on disk compared to the writer's current ideas about a character, place, and so on. As the writer's ideas changed, the editing commands would help extract the relevant passages to speed the reshaping of the text to reflect the writer's changed ideas.

Special Functions for Special Needs

Just as fiction writers have special needs, so do writers of other kinds of documents. In writing a proposal for funding, for example, it would be useful to have the document summarized instantly in terms of its references to objectives set in the RFP (Request for Proposal). Tracing each objective against a time line would be another helpful feature. Inveterate proposal writers could suggest other features.

In narrative writing, it would be useful to be able to extract the sequence of tenses in a piece; in history especially, to extract the sequence of dates and times.

Business writers could suggest special editing features for business plans and annual reports. Commands that extracted all numerical information and plotted it against a time line would be useful during writing. Another helpful command would extract paragraphs containing references to specified divisions, departments, positions, or persons.

Boolean operators would be as helpful here as in fiction.

Other missing facilities would help writers in all fields. One problem in any extended piece of writing is to make strong transitions from one section or chapter to the next. A command that extracted the last two paragraphs of each section and the first two paragraphs of the following section would let the writer have a quick look at all the transitions in the document.

Good Signs

Two programs that go beyond word processing are now on the market: Thinktank, from Living Videotext in Palo Alto, California, and Zyindex, from Zylab Corporation in Chicago, Illinois. Both these programs recognize that a collection of words can be much more than a finished document. They give the user new ways of getting hold of information contained in text files.

In the case of Thinktank, available for the Apple IIe for \$150 and the IBM PC for \$195, you obtain information through a tree structure. A document is a large outline. There are headings and subheadings ad infinitum, but you see only as much of the outline as you wish. The EXPAND and COLLAPSE commands control what you see. Thinktank displays a "+" in front of every heading that has further information under it. You know you have reached the end of a branch when a "-" sign precedes a heading. If you use the EXPAND command on an item that is preceded by a "+", the next level of branches will be displayed. You can expand your way through level after level. When you want to concentrate on the more general levels of the outline, you use the COLLAPSE command to hide the levels that give details. By expanding and collapsing, you can delve into the tree of data or concentrate on only the broad headings. You can also move items about in the structure, promoting them to higher levels or moving them to other parts of the outline. You can insert new items and merge old ones as well.

Thinktank, then, is most useful when a document is in the formative

THE NEW STANDARD. THE MICROSOFT MOUSE.

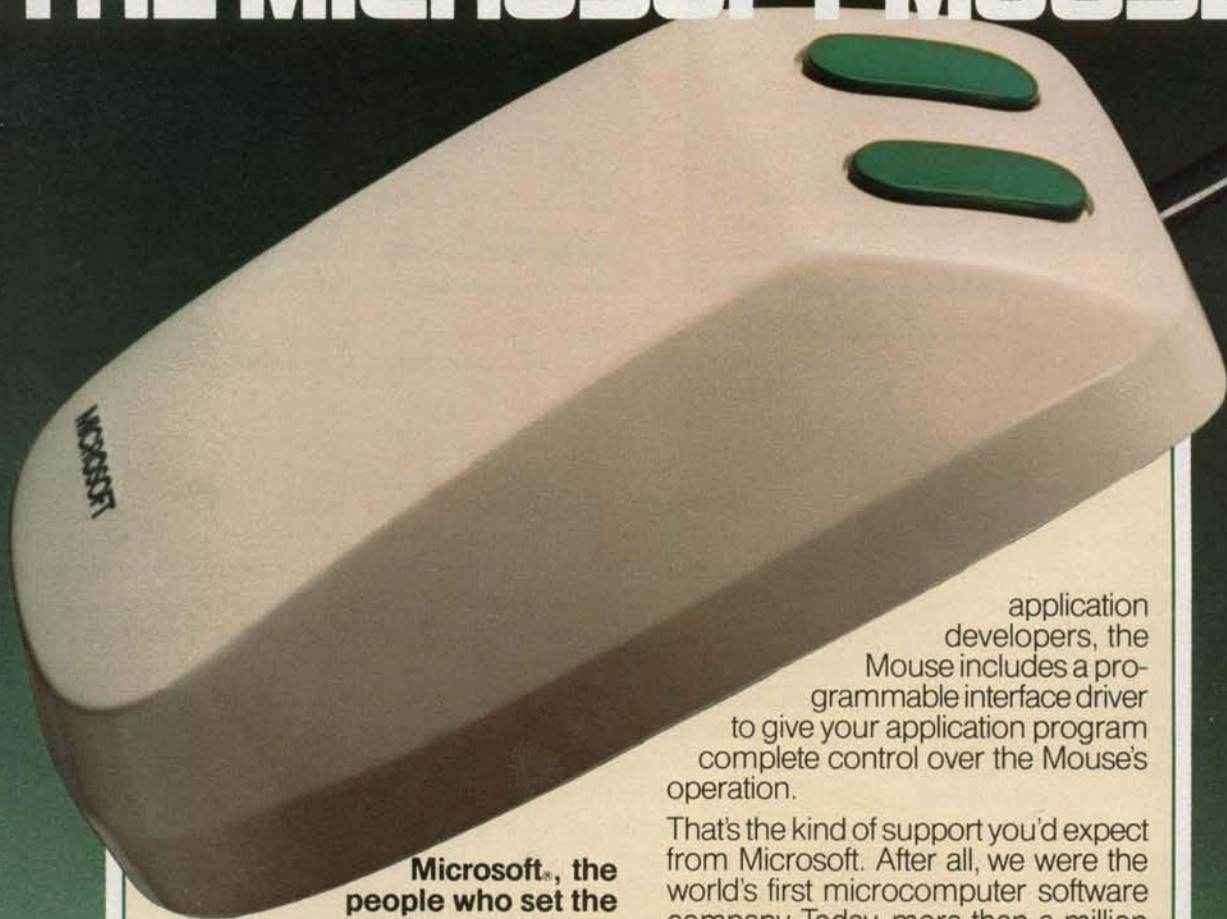

Microsoft®, the people who set the standard for software, have done it again with the Microsoft Mouse.

Our expertise in both hardware and software has gone into the development of the Microsoft Mouse. Now you can plug in the most exciting computer product of the year and put it to work.

The Mouse lets you move the cursor freely and naturally, then execute commands at the push of a button.

The Microsoft Mouse is a complete system. It comes with an on-screen tutorial, a practice application, and the Multi-Tool™ Notepad, a mouse-based text editor, so you can begin using the Mouse right away. And for

application developers, the Mouse includes a programmable interface driver to give your application program complete control over the Mouse's operation.

That's the kind of support you'd expect from Microsoft. After all, we were the world's first microcomputer software company. Today, more than a million microcomputers are running Microsoft-languages, operating systems, application programs, and hardware-software combinations.

You can get the Microsoft Mouse in either a bus or serial version for the IBM® PC or PC XT.

Ask your Microsoft dealer for a demonstration of the Microsoft Mouse — a whole new standard.

BETTER TOOLS FOR MICROCOMPUTERS

MICROSOFT™

Microsoft is a registered trademark, and MS and the Microsoft logo are trademarks of Microsoft Corporation.



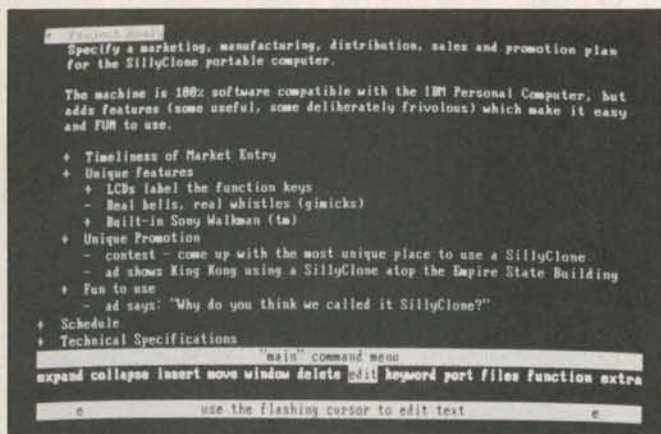

Photo 1: Thinktank in use, with the main command menu shown. The EXTRA command at right leads to a second list of commands. Each item preceded by a "+" can be expanded to show subheadings or paragraphs, while each item preceded by a "-" represents the end of a branch.

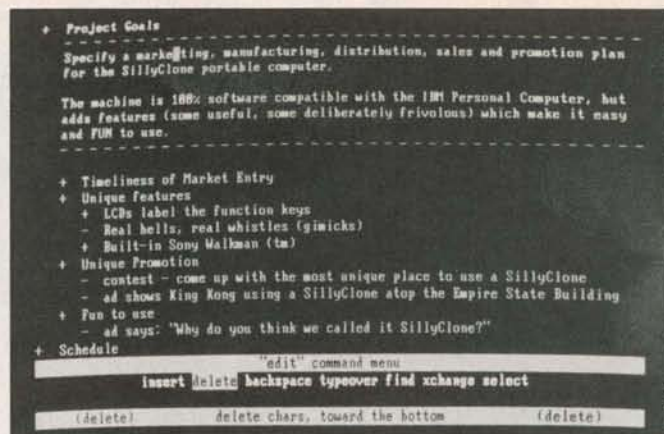

Photo 2: The edit menu of Thinktank. Although not a word processor in the usual sense, Thinktank does include a good text editor.

stages. As your ideas change and various aspects of them become more and less important, you can alter the document to reflect the changes. However much rearranging you do, Thinktank leaves you with a neat outline that looks as if you understood the subject when you started out.

In a way, Thinktank is analogous to a spreadsheet. A spreadsheet lets you rearrange numbers and relationships until you find a coherent arrangement that shows how to attain your goals. Thinktank manipulates text in a way that lets you rearrange its internal logical relationships until the structure supports a main idea. A spreadsheet is a number manipulator. Thinktank is a text manipulator.

Living Videotext calls Thinktank an "idea processor" to distinguish it from a word processor. While the term is a bit optimistic, it will have to do until a better one comes along. Thinktank's specific contribution is to apply tree structures to text. Its more general contribution is to treat a body of text as a database whose parts happen to be text.

Photo 1 shows a sample screen from Thinktank. As the main command menu reveals, Thinktank lets you search for items based on keywords. This search differs from one in a word processor in that it finds paragraphs or branches that contain a keyword—not just the keyword. In other words, you can confine your search for a keyword to a particular

area. Selecting the EXTRA command at the right of the main menu brings a menu of extra commands, including PROMOTE, which promotes a subheading to a higher level. Photo 2 shows the edit menu, displayed after you select the EDIT command from the main menu.

Zyindex, too, treats text as a database. This program lets you search a body of text for occurrences of any word, or of any two or more words within a specifiable number of words of each other. What makes Zyindex so much more valuable than the Search function of a word processor is the availability of Boolean operators. You can look for any occurrence of either "Johnson" or "Holmes" within 100 words of "embezzlement." Or any occurrence of both "Johnson" and "Holmes" within 100 words of "embezzlement."

Zyindex works by making an index of all the informational words in what it calls a textbase. That is to say, the index excludes "noise" words, such as prepositions and conjunctions. You make a search request with Zyindex by combining content terms with connector words. The connector words are OR, AND, NOT, WITHIN, and () [parentheses]. NOT represents the exclusive OR, and the parentheses are used to mark the scope of the other connectors. Zyindex will print out all the files that conform to a request or let you peek at the relevant passages within those

files. Zyindex runs on the IBM PC, requires 192K bytes of RAM and two double-sided drives, and costs \$295.

Zyindex enables you to test for relationships among items in an index. You can extract relevant information quickly to test a theory, to support an argument, to confirm an association, or to speed analysis of a body of text that resides on disk.

Programs like Thinktank and Zyindex show that word processing is the least interesting part of processing text; the interesting parts are during the generation of ideas, which Thinktank aids, and during the analysis of a body of information accumulated in text files, which Zyindex aids. These programs hold great promise because they show that programmers are thinking of ways to let personal computer users do more with text than print clean copies and individually addressed form letters.

If anything is holding back development of software for text manipulation, it is the failure of those of us who create, edit, and analyze text to specify features that would be useful to us. In the age of the typewriter, there was no point in dreaming of such features. In the age of the personal computer, expressing our dreams may result in products that make such features a reality. ■

Phil Lemmons is managing editor of BYTE. He can be reached at POB 372, Hancock, NH 03449.



**WITH THE PASSWORD™ MODEM AND
TELPAC™ BEN FRANKLIN COULD HAVE
PUBLISHED THE FRIDAY EVENING POST.**

The Password™ modem and Telpac™ software deliver text fast, far, cheap, and letter-perfect. Fast? Ten times faster than an expert typist (and four times faster than most other modems). Far? Crosstown or crosscountry. Letter perfect? Multiple accuracy checks of your text are just one editorial benefit. Cheap? Thousands of words by phone lines, for less than express mail. And if the text is to be typeset,

the cost will be half or less – the proofreading zero!

Password is USR's virtually automatic modem: 300/1200 baud, auto dial/answer, auto mode/speed select, two-year warranty. \$449.* Telpac, the USR friendly telecommunications software package, \$79. Write or call for complete descriptions – both Telpac and Password do far more than this!



U.S. ROBOTICS INC.

1123 WEST WASHINGTON • CHICAGO, ILLINOIS 60607
(312) 733-0497

Circle 366 on inquiry card.

*Suggested list for Password complete with power adapter, phone cable, RS232 interface.

Password, Telpac, and USR logo are trademarks of U.S. Robotics Inc.



Displays and hard copy output courtesy of ISSCO, SAS GRAPH™, SAS Institute Inc., Swanson Analysis Systems, Inc. and GDS-Applied Research of Cambridge. CPM-86 is a registered trademark of Digital Research, Inc. Copyright © 1983, Tektronix, Inc. All rights reserved. #UNO-220. VTI100 is a registered trademark of Digital Equipment Corporation.

Powerful text editing. High-speed graphics. Color copies. The new desktop family from Tek!

VT100 text editing and PLOT 10 color graphics are now packaged as basic desktop units and priced from \$3995* complete.

Tek's new 4100 Series desktop terminals answer a range of resolution, screen size, color palette and local intelligence needs. All three feature outstanding 60 Hz non-interlaced displays and rapid 16-bit graphic processing speeds.



As simulated, Tek's 60 Hz refresh rate and bright phosphors result in a flicker-free image with perceivably better definition than that provided by 30 Hz terminals quoting greater pixel densities.

Standard capabilities include 38.4K baud communications; easy color selection from the keyboard; 4096 x 4096 addressable display space; a separate display surface for alphanumerics or communications dialog; and compatibility with ANSI X3.64 screen editors, including DEC VT100 extensions.

Each offers an unconditional, one-year on-site warranty. Tek Warranty-Plus extends this coverage two additional years at minimal cost.

	4105	4107	4109
Display Size	330mm (13")	330mm (13")	483mm (19")
Displayable Colors			
Graphics	8	16	16
Alphanumeric	8	8	8
Palette	64	64	4,096
Resolution	480x360	640x480	640x480
Segment Memory		128K Bytes	256K Bytes
Price	\$3,995	\$6,950	\$9,950
Warranty-Plus	\$195	\$295	\$395

For less than \$1,600, you can add Tek's compact, plug-compatible 4695 Color Graphics Copier. With a palette of up to 125 shades, the 4695 lets you reproduce graphic and alphanumeric displays on report-size paper or transparency film at the push of a button.



All 4100 Series terminals feature programmable keyboards with innovative Joydisk for convenient graphics input.

At any time, you can plug into Tek's new 4170 Local Graphics Processing unit. The CP/M-86-based 4170

provides up to 886K RAM for standalone programming and pre- or post-processing—to help you conserve host power while you build upon a central data base.

Factor in compatibility with Tek PLOT 10 software and 4110 Series terminals, and you'll discover the first desktop graphics that you can't outgrow. Call your Tek Sales Engineer for a demonstration. For the number, or for literature, contact:

U.S.A., Asia, Australia, Central & South America, Japan

Tektronix, Inc.
P.O. Box 4828
Portland, OR 97208
Phone: 800/547-1512
Oregon only: 800/452-1877

Europe, Africa, Middle East

Tektronix Europe B.V.
Postbox 827
1180 AV Amstelveen
The Netherlands
Telex: 18312—18328

Canada

Tektronix Canada Inc.
P.O. Box 6500
Barrie, Ontario L4M 4V3
Phone: 705/737-2700
*All prices quoted are U.S. Domestic only.

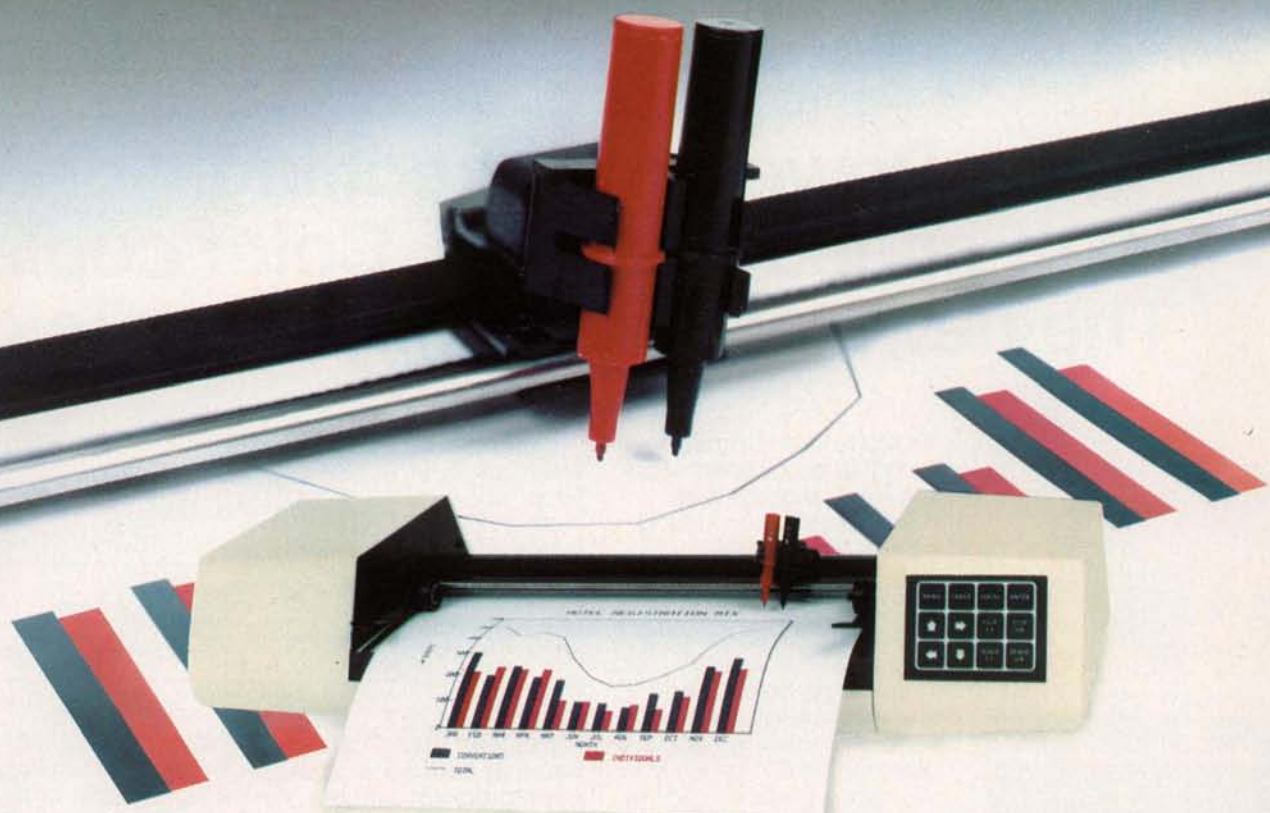

Good things come in 2s. The DMP-40-2 is a good example.

TWO PENS, poised and able, help you create vivid multicolor business graphics quickly and simply, or let you plot and draw different line widths for critical drafting applications.

TWO FORMAT SIZES give you the freedom to generate vibrant graphics for reports and presentations. The standard $8\frac{1}{2} \times 11$ " format is ideal for use in the report body, while the larger size is suitable for foldouts and photo reductions. Both the standard and larger 11×17 " formats are available in bond, vellum and acetate film (for colorful overlays or overhead transparencies). The two formats are interchangeable with drafting sizes A and B. No extra-cost accessories are needed when plotting on different surfaces.

TWO INTELLIGENCE LEVELS provide the flexibility to plot in either a 'smart' or incremental mode. With internal firmware that occupies 16-thousand bytes, the DMP-40-2 borders on brilliance. It's capable of automatically generating such complex figures as circles, arcs, ellipses and general curves with a single simple command.

More software is tailored to the Houston Instrument DMP-40 Series than for any other plotter. Well over a hundred programs are available, offered by scores of capable vendors. Each program has been configured in concert with Houston Instrument, so there are no rude surprises when you hit 'return.' Versatile programs for business graphics, investment analysis and computer-aided drafting are all available, with more added virtually on a daily basis.

Choose 2 for the show, and treat yourself to superior multi-color graphics at a very 'budget friendly*' price.

For the name, address and phone number of your nearest distributor or dealer, write Houston Instrument, 8500 Cameron Rd., Austin, Texas 78753. Phone 512-835-0900 or 800-531-5205 if outside Texas. In Europe contact Bausch & Lomb Belgium NV., Rochesterlaan 6, 8240 Gistel, Belgium. Tel. 059-27-74-45, tlx 846-81399.

houston instrument

*Suggested US Retail \$995.

Meets FCC class B requirements. UL Listed.

4P011

Too Many Leads, or What in *;?!#"*? Goes First?

In a heavy news month, our user covers several important items

by Jerry Pournelle

This has been the month of the changing lead. It began with upgrading the Eagle 1600. Then Tyler Sperry brought over the Kaypro 10, a portable machine with a hard disk. We'd no sooner got that running than the Osborne Computer Corporation filed for Chapter 11, and that needed commenting on. Then I got upset by the mess Congress is making out of attempts to promote computer literacy, but before I could write anything about it, Epson sent us yet another version of Valdocs for the QX-10.

Just after that, I got a copy of the legal reasoning in the *Apple v. Franklin* suit, which holds that "a computer program, whether in object code or in source code, is a 'literary work' and is protected from unauthorized copying." There are some powerful implications in that. For one thing, if program publishers rely on copyright, how can they expect to enforce those silly licensing agreements they foist off on us?

If all that weren't enough, I went to CP/M East in Boston, where Digital Research's Gary Kildall displayed DR Logo and Bill Godbout held a big

clambake to celebrate Compupro's tenth anniversary. Godbout also unveiled the Compupro 10, formerly yclept Shirley, and there's a story to go with that. Rod Coleman was there, too, with the new Sage IV, which is a good candidate for the best available computer based on the 68000 chip. Finally, after CP/M East I paid my very first visit to BYTE headquarters in Peterborough, New Hampshire.

Any one of these events would be important enough for the lead item in the column, but none of them is, because on the way to Peterborough I stopped at Steve Ciarcia's Circuit Cellar.

Quicksilver

Steve has designed an absolutely dynamite upgrade to the IBM PC. He asked me not to do the full story this issue, because he's still playing around with the way he wants to package it. That's fine, but if you're at all short of money, don't buy anything for your PC until you've seen Ciarcia's Quicksilver. I can darned near guarantee it will be the first thing you'll want.

Quicksilver is a one-card computer that uses the IBM PC as a power supply, disk drive, and smart terminal. It has its own CPU (central processing unit, or brain) aboard. Using Quicksilver is simple: you preload a PC BASIC compiler that appears as if it's in ROM and write a program in BASIC, doing all your debugging and logic testing in the usual way. Then you run it under Quicksilver, which compiles the program in seconds as you "load" it. Then it executes the compiled program. The results are astounding. I might not have believed it if I hadn't seen it myself: programs run *100 times as fast*.

If that weren't enough, Quicksilver also lets you run CP/M-80 programs and has a C compiler. There's also a structured assembler and a text editor integrated with the BASIC compiler. I didn't myself see those features work, but I've no reason to doubt that they do. Ciarcia has a habit of getting things right.

Incidentally, for the congenial doubters among our readership: there really is a Circuit Cellar, and it really is in Steve's basement.

THE PRINTER STORE

SERVICE, COMPUTER AND SOFTWARE COMPATIBILITY, and LOW PRICE,

are among the many factors to consider when purchasing a printer. At the **PRINTER STORE** we specialize in printers, so our professional staff can help you choose the right printer for your personal and business needs. Every **Printer Purchase** includes:

- 1) Low Prices
- 2) Same Day Shipping
- 3) Free Technical Support
- 4) Full Service Option



IDS 480

- 110 CPS, Bi-Directional, Logic Seeking
- 24 x 9 Dot Matrix, 10, 12, 16.7 CPI, Plus Proportional Spacing
- Parallel and Serial Port Standard

\$CALL

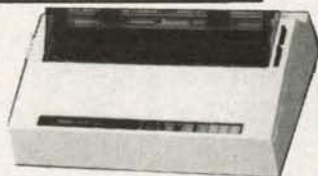

BROTHER HR-15

- 13 CPS - Bi-directional - Super & Subscript
- 10, 12, 15 and Proportional Spacing Pitch
- Optional Tractor, Sheetfeed and Keyboard

Parallel **\$CALL**
Serial **\$CALL**

DOT MATRIX PRINTERS

EPSON SERIES

- FX 80 **\$ CALL**
- FX 100 **\$ CALL**

OKIDATA SERIES

- 82A **\$ CALL**
- 83A **\$ CALL**
- 92A **\$ CALL**
- 93A **\$ CALL**
- 84 (parallel) **\$ CALL**

C. ITOH SERIES

- 8510 Prowriter **\$ 395**
- Prowriter II **\$ CALL**

IDS SERIES

- Microprism 480 **\$ 395**
- Prism 80 **\$ CALL**
- Prism 132 **\$ CALL**

GEMINI SERIES

- Gemini 10X **\$ CALL**
- Gemini 15X **\$ CALL**
- Delta 10 **\$ CALL**

Toshiba P 1350 **\$ CALL**

LETTER QUALITY PRINTERS

BROTHER SERIES

- HR-1 **\$ CALL**
- HR-15 **\$ CALL**
- HR-25 **\$ CALL**

COMREX SERIES

- CR-1 **\$ 650**
- CR-2 **\$ CALL**
- CR-25 **\$ CALL**

C. ITOH SERIES

- F-10 40 CPS **\$ CALL**
- F-10 55 CPS **\$ CALL**

NEC SERIES

- 2010 **\$ CALL**
- 2030 **\$ CALL**
- 2050 **\$ CALL**
- 3510 **\$ CALL**
- 3530 **\$ CALL**
- 3550 **\$ CALL**
- 7710 **\$ CALL**
- 7730 **\$ CALL**

NEC Accessories **\$ CALL**

We carry a full line of Cables and Accessories
Call (714) 241-0701 and ask us about...

PHONE REBATE:

We are so confident of our **LOW PRICES** and **SUPPORT** that we are going to ask you to make the initial investment by calling us. In return, when you buy your printer from us, we will rebate the cost of your call and deduct it from your invoice.

HOW TO ORDER: Our phone lines are open from 8 a.m. to 6 p.m. PST, Monday - Friday. We accept VISA, MASTERCHARGE (at no extra charge), personal checks take two weeks to clear. COD's accepted. Same-day shipment on orders placed before 1 p.m. Manufacturer's warranty applicable on all equipment. Prices subject to change.

However, if you picture a basement as a damp, messy place, get rid of that image. Ciarcia's Circuit Cellar is none of that. Most of it is carpeted, with paneled walls and designer furniture, more rec room than cellar. In the middle of all that is a work area with wide Formica-topped counters and lots of test equipment.

It's also neat. In fact, although they're tearing Steve's house apart to put in a new kitchen, the whole place is neat, which suggests that Steve and his wife, Joyce, have some fundamental secret that escapes the rest of us. Every time I see a place like his, I get fantastic plans. If I just add storage cabinets here and bookcases there, I too could have some bare counter tops, and chairs not piled with paper and boxes, and somewhere to put things as they come in.

Then I come home to Chaos Manor. Ah, well.

Survival

I'm writing this in early October. Just at the moment, in obvious reaction to the Osborne disaster, both computer and mainstream magazines are full of articles and editorials about "the great shakeout" in the micro industry. A number of companies are said to be in trouble, and "experts" are predicting that we've reached a new age in micros, one in which only the giants like IBM can survive.

I don't believe that.

I suppose the micro industry will be dominated by the giants—but there's plenty of room for the others. In U.S. business as a whole, about 10 percent of all sales are made by companies with a gross income of less than half a million dollars. There are some 5 million of them. Another 35 percent of all sales are made by the 520,625 companies with gross incomes of \$500,000 to \$25 million. At the other end of the spectrum, a bit less than half of all sales are made by the 2355 companies with gross incomes of \$100 million or more.

That's all U.S. business, from steel rails to books to coffee spoons. The computer industry is skewed a bit more toward smaller companies. I

It Meets Your Needs... Whatever They Are

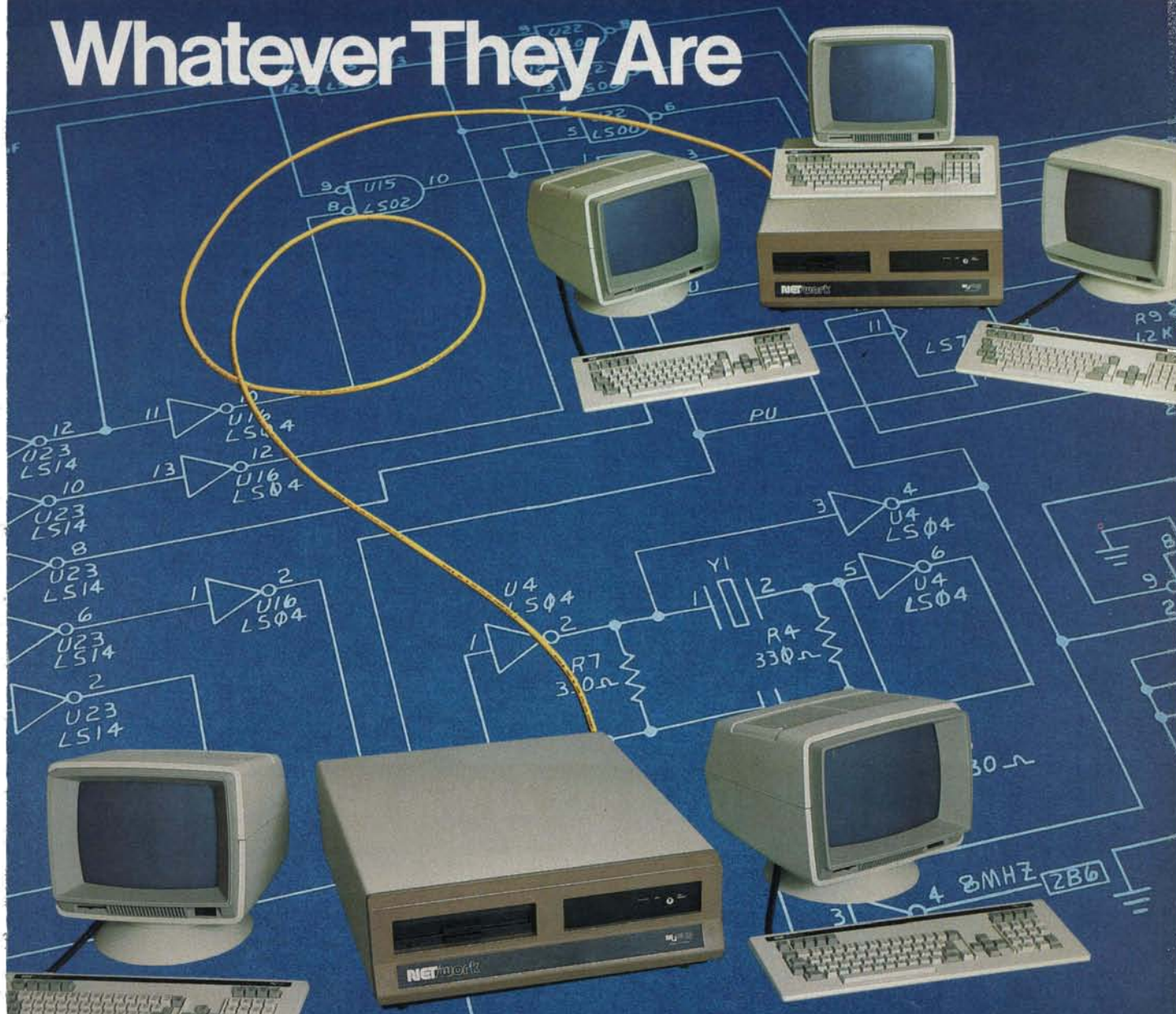

Large Multi-user Capability

A truly professional, reliable solution—the NET/work 8816 has been specifically designed for installation in demanding multi-user applications. The low starting price allows you to start with two users and grow later to many thousands without the expense of replacing existing equipment or software as you grow. We offer three types of Local Area Networking, including Ethernet, with full shared multi-system resources. AND IT WORKS. Gone are the bottlenecks that make shared-processor multi-user systems too sluggish for real time applications. What's more, we offer an unbeatable combination in a video terminal with our NET/worker. You get styling, operating comfort, value and reliability.

All MuSYS systems utilize TurboDOS, the Industry Standard Multi-user Operating System. Mainframe capability at microcomputer prices, and compatible with virtually all CP/M Software. NET/work systems give you advanced features such as 8MHz processors, high speed hard disk drives with storage capacities up to 280MB, and 16 bit future upgrade path.

This system meets your needs...WHATEVER THEY ARE. Call or write, MuSYS Corporation, 1752-B Langley, Irvine, California 92714. (714) 662-7387 toll free outside California 1-800-852-5362. TWX 910-595-1967. Cable MUSYSIRIN.

Dealer and OEM inquiries welcome.

MUSYS
CORP

We design the future.

NET/work is a trademark of MuSYS Corporation. TurboDOS is a trademark of Software 2000, Inc. CP/M is a trademark of Digital Research, Inc. Ethernet is a trademark of Xerox Corporation.

think it will stay that way, because the micro world changes like dreams, and smaller, leaner companies, with fewer links in the decision chain, can respond faster to changes in technology.

The giants look to big sales, hundreds of thousands of copies of nearly identical units. While they're setting up to do that, the small, adaptable, fast-moving outfits get their innings.

Example: there's a persistent rumor that IBM has developed a small, portable computer based on the iAPX186 CPU chip. The problem is that Intel isn't producing the chips fast enough. It has had to put its customers on allocation.

IBM can't work that way. However, if you really want an iAPX186 computer, Slicer will be glad to sell you one. It comes without frills. There's no case and no power supply, but it works. Jim Hudson and I are doing an article on the Slicer, which is a good buy for technically sophisticated users. My point, though, is that

Slicer can make profits on its machine, even though the company will never have any large share of the microcomputer market.

Another example: I first met Rod Coleman at a West Coast Computer Faire. Forty days before the Faire, his Sage Computer Technology company was destroyed by a disastrous fire. Rod was standing there with his three working machines. None had a hard disk; he'd show you melted fragments and refer to them as "our well-burned-in disk drive." In less than a year, Sage was doing a million dollars' worth of business annually; I recently got an announcement that the company had had a million-dollar month, and it hasn't stopped growing. The Sage IV may well be the best 68000-chip computer on the market.

Yet another example: even as Osborne was getting into trouble, Kaypro was growing by leaps and bounds. The reasons for that are complex, and indeed Kaypro couldn't possibly be doing as well as it is if

Osborne hadn't led the way; but it does show that small, well-made, and well-thought-out systems can thrive. The Kaypro 10 is the first portable machine to use a hard disk. Other innovations are coming.

A final example. Bill Godbout just threw a big party to celebrate the tenth anniversary of Compupro. Here's a company with a reputation for armor-plated high-technology hardware. It very nearly dominates the development systems market. Now it's trying to expand its market share by selling easy-to-use business systems.

Last time I looked, Compupro had maybe 2 percent of the micro market. That doesn't sound like much—but if you look at Compupro's actual dollar income, it has been doing business at a steadily rising rate. Most accountants would sell their livers for that kind of profitability.

At the height of the Osborne boom, the company was shipping around 8000 computers a month, which generated sales on the order

AZTEC C — 'C' PROGRAM DEVELOPMENT SYSTEM
PORTABLE SOFTWARE APPLE CP/M IBM

WHY PROFESSIONALS CHOOSE AZTEC C

MANX

SOFTWARE SYSTEMS

- AZTEC C is the most complete implementation of UNIX V7 'C' available for microcomputers.
- AZTEC C is portable. 'C' code can be freely moved between UNIX V7 and microcomputer systems. AZTEC C is available for PC DOS (MSDOS), CP/M 86 (MP/M 86), CP/M 80 (MP/M 80), APPLE DOS, MODEL III (IV), COMMODORE 64, and ATARI. All versions of AZTEC C are source compatible.
- AZTEC C is a complete development system that includes relocating assembler, linkage editor, library utility, debugging aids, overlay support, interfaces to Microsoft and Digital Research development software, and run time routines for I/O, utility, and scientific functions. Source for all library routines is provided.
- AZTEC C generates fast native code for the 6502, 8080, Z80, 8088, and 8086.
- Cross compilers are available for PDP-11, 8086, 8080, and 6502 processors.
- Since its release in 1981, AZTEC C has been acquired by several thousand users. Commercial applications include a wide variety of business, scientific, word processing, database, entertainment and financial applications.

PRICE LIST

AZTEC C86	PC DOS (MSDOS)	\$249
AZTEC C86	CP/M 86 (MP/M 86)	249
AZTEC C80	CP/M 80 (MP/M 80)	199
AZTEC C-II	APPLE DOS	199
AZTEC C65	COM-64 OR ATARI	199
AZTEC C65	COM-64 OR ATARI	2,000
AZTEC Cross Compilers	PDP-11	2,000
AZTEC Cross Compilers	Other	500

Order by phone or mail. Specify product and disk format. Check. Money Orders, C.O.D. VISA, MC, and purchase orders are acceptable. NJ add 6% sales tax.

MANX
SOFTWARE SYSTEMS
Box 55, Shrewsbury, NJ 07701

Order phone: (201) 780-4004
Tech information: (301) 530-7997
Tech support: (201) 530-7708

Shipping: COD, 2nd day delivery, or Canada, add \$5. Canada 2nd day or US next day delivery, add \$20. Outside North America, add \$20, and for 2nd day add \$75.



ALL THE HARD PART IS MAKING SURE MINI DISKS COME ERROR FREE.

THE HARD PART IS MAKING SURE THEY STAY THAT WAY.

A disk is built with certain safeguards. That's why most disk makers offer guarantees that the product you receive comes to you error free.

We at Memtek Products are concerned that the minidisk remains error free. *Every* time you use it. After exposure to dust, cigarette smoke, fingerprints, even wear caused by your computer. And so, we have built safeguards around the disk, as well.

Memtek Products' latest innovation... acknowledgment of a real world beyond the laboratory.

The hub ring. Designed to prevent our minidisks from jamming in your machine. Rigid. Durable. Reinforced.

The coating. A critically-controlled coating of high-energy magnetic oxide particles that covers the disk's surface, which is then micro-polished to improve head to disk contact, preventing dropouts, lowering head abrasion.

The lubrication system. A constant lubricant protects both the disk surface and the drive head from wear.

The sleeve. Comes with a soft liner that protects the disk while gently cleaning the surface.

The guarantee.

We'll replace, free, any minidisk if it fails to accurately store and retrieve data due to a defect in materials or workmanship for up to 5 years from date of purchase. Simply mail the disk back.

The Memtek lineup.

Premium, double and quad density minidisks as well as 10- and 15-minute computer cassettes and a 5 1/4" disk drive head cleaner.



WE PLAY FOR KEEPS™

of \$100 million a year. That may not be big by IBM standards, but it's not peanuts, and it made Osborne one of the Big Ones in the micro field.

There are 5.5 million U.S. companies, and just about every one of them will spend \$2000 a year on microcomputers. There are at least a million people who spend a thousand dollars a year on personal computer products, and I'd be greatly surprised if that number didn't hit 10 million in the next few years. One-half of one percent of that is \$105

million—Osborne's peak income.

Look at it another way. Assume sales are distributed by company size roughly the way they are in U.S. business as a whole.

Of \$20 billion total sales, 10 giants will get half. The other half will support a thousand companies with average sales of 10 million dollars, which in practice is more likely to be 900 smaller outfits and 50 large ones. Even so, there's plenty of room.

This isn't to say that things won't get tricky. They always do when

you're up against large resources. The big boys can survive mistakes that bankrupt small companies. They can afford to lose money setting up store outlets and service centers. They can also afford to advertise.

The smaller outfits also have some advantages. They don't have to tool up for big production runs, and their decision structures are leaner, so they can track new technology better. They may not have in-house service organizations, but as the industry matures there'll be more and more trained technicians. Some will stay independent, others will work for service companies like Xerox, which is rapidly becoming something like a cross between AAMCO and Tuneup Masters, only for micros. Parts outfits will spring up. Somebody's going to get rich out of stocking spare parts, repair kits, and instruction sheets.

It may happen that someday all the really exciting developments in the computer field will come from the research labs set up by the giants; but that hasn't happened yet, and I don't really think it will. In fact, I see small computers as the great equalizers. I think they're going to change the structure of business in this country, not just for the micro business, but for everyone, making it much easier for small outfits to compete with the giants; but that's a topic for another column.

Upgrading the Eagle 1600

One of the things we're hard at work on is Inferno, an Adventure-style game based on the novel that Larry Niven and I published some years ago. The original plan was that Larry and I would write the script for the game, and my son Alex would do the code. Alas, Alex finds himself spread almost as thin as I am. Fortunately, though, Marty Massoglia, who's both an experienced programmer and as mad on games as we are, became available just as we despaired of getting the project accomplished.

There remained the problem of what language to write it in. Since the original contract calls for the game to run on the IBM PC, we needed something available in PC-DOS; but we have delusions of sell-



Touch-Tone® In...ASCII Out.

Turn any Touch-Tone® phone into a remote data entry terminal

By combining the capabilities of an intelligent modem with a DTMF to ASCII converter, Teltone has unlocked countless opportunities for you. With a Teleport 300 on your computer, you can use any Touch-Tone® phone in the country as a remote data entry terminal, or, if you wish, a control panel.

Imagine the possibilities: Branch office order entry, Inventory control, Remote control of environmental systems, Data logging, Emergency access to process control systems, Credit card authorizations, etc. The list goes on and on.

It's a full-featured smart modem

The Teleport 300 is a fully equipped intelligent modem: Bell 103J compatible, auto answer and originate, with tone and pulse repertory dialing and call progress indications. It's menu driven and user programmable. An internal buffer lets the

Teleport handle DTE speeds from 75 to 9600 baud.

Teleport delivers front end hardware security

You can program the Teleport 300 to respond only to a pre-determined series of DTMF signals. Unless the correct DTMF tones are detected, callers are not connected to your computer. It's an effective hardware barrier in front of any software security scheme you may be using to protect valuable programs and data.

List price is \$399.95.

To get all the Teleport details, call:
1-800-227-3800 ext 1130

Dealer inquiries are invited. Call the Teltone Telcom Components Division: (206) 827-9626 ext 220.

Teltone Corporation
10801 120th Avenue NE
P.O. Box 657
Kirkland, WA 98033
TWX 910 449-2862

Touch-Tone® is a registered trademark of AT&T.

TELSTONE®

PRINTERS

C. ITOH

Prowriter



120 cps, 4 fonts (includes proportional), 8 sizes, 160 x 144 dpi, friction & tractor feed. A worthy rival of Epson.

Prowriter \$399.88
Prowriter 2 719.88

Starwriter

Letter-quality, 40 cps, 136 columns 10 & 12 pitch, uses Diablo wheels & ribbons (Qume code). The Printmaster is the 55 cps version. The A10 Starwriter (18 cps) is the new, low-speed version with the same specs.

A10 Starwriter \$609.88
Starwriter 1219.88
Printmaster 1569.88
Tractor Feed 289.88
Sheet Feed 609.88

DIABLO

620 \$999.88
630 1979.88
Series 32 1049.88

EPSON

RX/FX Epsoms CALL

IDS

Micro 480 \$529.88
P-Series 80 1079.88
w/4-color 1439.88
P-Series 132 1239.88
w/4-color 1669.88

INFORUNNER

Riteman



A compact printer with 120 cps, 10/17 cpi, 160 x 144 dpi graphics, optional tractor (pin/friction std.). Parallel \$349.88

MANNESMANN TALLY

MT-160 L



The **MT-160 L** (160 cps) features 8 fonts (including a correspondence font), parallel & RS-232C interfaces, friction/tractor feed. The **MT-180 L** is a 136 column version. The **Spirit** (80 cps) features 4 fonts, italics, dot graphics & friction/tractor feed.
MT-160 L \$649.88
MT-180 L 849.88
Spirit 329.88

NEC

2010/2030 \$879.88
2050 999.88
3510 1549.88
3530 1639.88
3550 1899.88
7710/7730 2159.88

Silver Reed EXP-550 & EXP-500

Silver Reed's printers are exceptional. Both the **EXP-550** (17 cps) and the **EXP-500** (12 cps) feature sub and super script, underlining, backspace, proportional printing capabilities, multiple pitch (10, 12 or 15 cpi) and Diablo 1610/1620 code emulation, which makes them compatible with nearly every word processing program available. The **EXP-550** features a page-inject system.

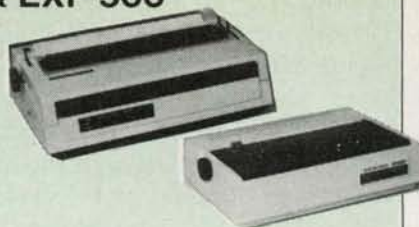

EXP-550 (Parallel) \$669.88
EXP-550 (RS-232C) \$689.88
EXP-550 Tractor Feed \$139.88
EXP-500 (Parallel) \$439.88
EXP-500 (RS-232C) \$469.88
EXP-500 Tractor Feed \$129.88

OKIDATA

Microline Series



The **92/93** printers (160 cps) & the **84** (200 cps) are exceptional. Tough, reliable, they produce superior draft quality, correspondence quality & graphics. Features include 10, 12 & 17 cpi, a correspondence font, sub/super scripts, underlining, dot graphics (120 x 144 dpi) & friction/pin feed (adjustable tractor is optional on the **92**, standard on the **93**).

The **PC Plug-n-Play ROMs** turn the **92/93/84** into 100% IBM-PC compatible printers. Our very best selling printer line.

The **84 Step 2** (200 cps) is a high-speed matrix printer with 10, 12, 17 cpi, plus correspondence modes in all sizes. Dot graphics are standard (120 x 144 dpi).
Microline Series \$CALL

PANASONIC

KX-P1090

The **KX-P1090** printer (80 cps) is a sharp new entry by Panasonic. 10, 12 & 17 cpi, sub/super scripts, underline, friction/tractor feed & dot graphics. It uses most Epson code, so it's easily installed on software. Service nationally by Panasonic.
KX-P1090 \$349.88

SMITH CORONA

Messenger



The **Memory Correct III Messenger** (12 cps) features 10, 12 & 15 cpi, variable line spacing, backspace, auto-correction and a dual parallel/RS-232C interface. True daisy wheel printing makes it an exceptional typewriter & printer. Ideal for the home or small office.
Memory Correct III Messenger \$599.88

STAR MICRONICS

Gemini 10X/15



Gemini 10X \$299.88
w/RS-232C 399.88
Gemini 15 459.88
w/RS-232C 569.88
Delta 10 529.88
w/RS-232C 619.88

TOSHIBA

P 1350 \$1759.88

CABLES

IBM-PC \$39.88
Osborne-1 39.88
TRS-80 39.88
Model I/III/IV 39.88
Model II/16 39.88
Centronics 39.88
Male/Male 39.88
Male/Female 39.88
VIC-20/Commodore 64 59.88
Apple II+/Ile 89.88
Parallel Card/Cable 89.88

QUADRAM

Microfazer

A print buffer with pause, copy & reset controls. It comes with a 9V power supply and cable to printer. There are so many buffer sizes (from 8K to 512K), & so many configurations (Parallel/Parallel, Parallel/RS-232C, RS-232C/Parallel & RS-232C/RS-232C) that you should call (800) 343-0726 for prices.

MONITORS

NEC



JB 1205M (amber) \$179.88
JB 1201M (green) 159.88

AMDEK

300A (12" amber) \$164.88
300G (12" green) 149.88
310A (amber) 149.88

QUADRAM

QuadChrome



690 x 240 resolution, 80 columns x 24 lines, 16 colors & exceptional performance. Cable included.
QuadChrome (RGB) \$509.88

PRINCETON GRAPHICS

HX-12

Same spec's & performance as the **QuadChrome**.
PGS HX-12 (RGB) \$499.88

MODEMS

US ROBOTICS

Password

0-300/1200 baud direct-connect modem with auto-dial/answer, full/half duplex, voice/data. Uses LSI technology. Cables & power supply included (specify type of computer).
Password \$379.88
*Courier 479.88
*Uses Osborne-1 modem port & includes Telepac communications software for the Osborne.

DC HAYES

Smartmodem

0-300 or 0-300/1200 baud direct-connect modems with auto dial/answer, full/half duplex, power supply & modular cable (RS-232C cable optional). **1200B** is an in-board modem for the IBM-PC & includes **Smartcom II**.
300 \$219.88
1200 539.88
1200B w/Smartcom II (IBM PC) 459.88

PERIPHERALS

For the IBM-PC...

We carry a variety of peripherals for the IBM-PC, including: Quadram Quadboards, Quad 512, QuadLink, QuadDisk & single-function boards; AST products; Tandon's TM-100-2 double-drive; QCS's Big Blue & Hard Disk; a Hard Disk/Tape subsystem; Tecmar's Graphics Master; the Paradise Multi-Display Card; & the Eagle PC & Columbia 1600-1 personal computers.
Call (800) 343-0726 for prices & orders.

For the Apple II...

We also carry numerous Apple II+/Ile peripherals, including: Pkaso Printer Cards; MicroSoft 280 Cards, RamCards & Premium Packs; Video's Video Term, UltraTerm & Enhance; Rana Elite Disk Drives; AMT's MicroDrive; Saturn Systems Accelerator II & Memory Board; Quadram's eRAM 80 Column Card; & Kensington's System Saver; & the Novation Apple II. We also carry the Franklin 1000 & Ace 1200 personal computers.
Call (800) 343-0726 for prices & orders.

Accessories

We also carry cables, diskette/diskette boxes, switch boxes, surge protectors & printer paper.
Call (800) 343-0726 for prices & orders.

Information/Orders

(603) 881-9855

Orders Only:
(800) 343-0726

No Hidden Charges:

- You get FREE shipping on all orders within the 48 states.
 - Most orders delivered within 10 days or less. UPS 2nd Day and Overnight available for most areas.
 - Easy payment terms: We accept all major credit cards, certified checks, money order, company checks or personal checks (allow 21 days for personal checks).
 - We never charge extra for credit cards.
 - Credit cards are not charged until order is shipped.
 - We accept CODs up to \$1000 (add \$10 handling fee per order) payable with certified check or money order.
 - We have a \$50 minimum order.
- Company Purchase Orders accepted on a limited basis & upon approval only. Sorry, no cash or foreign orders accepted.

All our equipment is shipped with full manufacturer's warranty. We are an authorized dealer for all products we sell to insure warranty support, & we're authorized for warranty work on a number of printers. We also offer extended warranty plans for most printers.

We prepared this ad in November, & prices do change. Call to verify them.

Our Computer Showroom is now open in Amherst, New Hampshire, five miles west of Nashua (one hour from Boston).

MasterCard

VISA

HIGH TECHNOLOGY AT AFFORDABLE PRICES

THE BOTTOM LINE

MILFORD, NH 03055-0423 □ TELEPHONE (603) 881-9855

ing this to the 8-bit CP/M world as well, so it needed to be portable. Of course, we'd originally intended to write it in Pascal, that being what Alex is most familiar with; and although Marty isn't, he didn't think it would give him any real trouble, since if you know a couple of computer languages it's not so hard to learn another.

There remained the question of what machine to use. The obvious answer, an IBM PC, was out: we ordered our PC direct from IBM last June. In late June IBM returned the check with a letter saying it had to be certified. By the time we sent a certified check it was early July. Since then IBM keeps telling us Real Soon Now, but as of October 9 there's no PC in sight [it arrived on November 1].

We do have the Eagle 1600, which runs PC-DOS and is a lot faster than the IBM PC. The only incompatibility would be screen-format commands and graphics, and we hadn't planned special graphics for Inferno anyway, so the Eagle looked like a

good choice. Marty took the Eagle, along with Pascal/MT+86, which is the brand of Pascal that Alex favors for microcomputers. A few days passed while Marty familiarized himself with the machine, and with Pascal, and decided on the structure of the game.

Then came the problems. Pascal/MT+86 wouldn't compile. Instead, Marty got "Out of Memory" messages. He also had some suspicions about the text editor. Eaglewriter, which is Lexisoff's Spellbinder adapted for the Eagle, puts some strange formatting characters into the text. It also refuses to put in linefeed characters; like Write (which we do not yet have running on the Eagle), Eaglewriter uses a bare carriage return, no linefeed, as the "newline" marker.

"I don't think MT+ will compile it even if we have enough memory," Marty said.

"Well, that's easy to fix," said I. "Just write a little assembly-language filter that copies the files and puts in linefeeds. I have one here for the

8080. Surely it's not so hard to do for the 8088."

"Well, it is," said Marty, "because the assembler won't accept input without linefeeds."

At that point I had to leave town, and I turned the matter over to Alex. When I got back, he'd talked to the people at Eagle Computer and found out a lot of things.

First, that's not an 8088 in the Eagle. It's an 8086, which is exactly like an 8088, except it fetches data 16 bits at a time. Second, although ours came with only 128K bytes' worth of memory chips, the Eagle has sockets for 512K bytes of memory. You don't need to use up a bus slot to get it, either; those sockets are on the main board.

Alex called California Digital and ordered a slew of 64K-byte memory chips. Since they're 64K-byte by 1-bit memory, you need eight such chips for each 64K bytes of memory you're adding. However, both the Z-100 and the IBM PC require *nine* chips for each 64K bytes of added memory. This is because they do *parity checking*, a form of memory test, and thus need the extra memory to store the parity bits in. The Eagle doesn't do parity checking. Anyway, Alex ordered 20 memory chips, enough to put in 128K bytes of additional memory and bring the Eagle up to 256K bytes (plus a few spares).

[Last-minute notes: Eagle tells me it did a lot of work on parity checking and found that it decreases the overall reliability by 15 percent. The company decided it was better not to do it.]

Then the Eagle software people called. They'd tried Pascal/MT+86 in a system with 512K bytes of memory and *still* got "Out of Memory" errors. It seems those odd formatting characters in Eaglewriter, plus the lack of linefeeds, fool MT+86 into believing you're trying to compile one enormous statement.

However, there's a remedy. If, when you save your file under Eaglewriter, you add "/1" after the filename, the format characters are stripped out, and linefeeds are added after each carriage return. That's known as an undocumented feature.

NRZ DIGITAL DATA RECORDER



FEATURES:

.4800 BAUD data rate (3" per second) 1 ERROR in 10⁸ BITS • RS-232 or TTL interface — NO EXTERNAL INTERFACE REQUIRED • ASYNCHRONOUS COMMUNICATIONS STANDARD "HANDSHAKING" • SPEED STABILITY — LONG TERM ±.1% • COMPATIBLE with DC-3 • Works with CERTIFIED DATA or high quality FeO AUDIO TAPES • OPTIONS: 115v ac, 220v ac, 12v ac; Stand alone; Rack-mountable; 9600 BAUD; Buffered Version

The PD-1 SERIES DIGITAL DATA RECORDER continues to set new NRZ INDUSTRY STANDARDS. Its tachometer feedback LC stabilized motor circuit and heavy duty drive mechanism provide STABILITY, ACCURACY and RELIABILITY. You get LESS BIT DROP-OUT when capturing crucial information at HIGHER DATA TRANSFER RATES . . . at a MUCH LOWER COST. \$335.00

USED IN:

• PROCESS CONTROL • POINT-OF-SALE • TELEPHONE SWITCH LOGGING (Call Activity and Station Message Detail) • DIAGNOSTIC SUPPORT (local/remote) • HARD DISC BACKUP (for personal or small computer systems) • Many Other Applications

• An intelligent, buffered version of this device is also available.

TO ORDER, DIAL:
(201) 356-9200

**Pegasus**
DATA SYSTEMS
236 Lackland Drive
Middlesex, N.J. 08846

Great Prices! Great Service!

If you're looking for rock-bottom prices and fast, personal service, take a close look at 800-SOFTWARE.

Because we buy in volume, we're able to sell and service the products you want at prices that finally make some sense. But don't take our word for it. Compare and see for yourself.

OUR SERVICE CAN'T BE BEAT.

We take care of you like our business depends on it. Because it does.

When you call 800-SOFTWARE, you get the fastest delivery available anywhere. Which means that nearly every order is filled the day we get it. And that our unique Order Tracking System™ is on the job, keeping tabs on your order, every step of the way.

Our giant inventory—one of the largest in the United States—also assures you of the fastest possible service. Everything's in stock so you don't have to wait.

Technical support? Business software expertise? Customer service? We've got it—and it's the best you'll find *anywhere*.

But, put us to the test. Let us prove what we've proven to satisfied customers around the world.

That our prices *are* lower. That our service is better. That there really and truly is a difference. We look forward to your call.

TO ORDER CALL TOLL-FREE 800-227-4587

or 415-644-3611

Order Desk and Technical Support open:
6:30 a.m.-9:00 p.m. Monday through Friday
10:00 a.m. to 4:00 p.m. Saturday and Sunday

CHECK OUT ALL OUR INCREDIBLE BUSINESS SOFTWARE PRICES:

WordStar® \$269	dBase II™ \$439	SuperCalc 2™ \$169	MultiPlan™ \$189	PC DEMO \$18 for 3 issues of the new PC software demo "disk magazine"
Perfect Writer \$259	4-Point Graphics™ \$129	Lotus 1-2-3™ \$369	MicroPro® ProPak \$389	
ADVANCED LOGIC SYSTEMS™ Z-Card \$129 CP/M Card \$359 Smartterm II \$149 ALPHA™ Apple-IBM Connection \$199 Database Manager II \$225 Type Faces \$ 95 Other Products CALL APPLIED SOFTWARE TECHNOLOGY™ Versatorm \$289 ASHTON-TATE™ dBASE II \$439 dBASE II User's Guide \$ 20 Friday! \$219 ASPEN™ Grammatik \$ 60 Random House Proofreader \$ 39 Random House Thesaurus \$119 ATI TRAINING™ Training Modules \$ 65 CENTRAL POINT SOFTWARE™ PC Copy II \$ 35 Copy II Plus \$ 35 CDEX™ Training Modules \$ 65 C.M.B. III ENTERPRISES™ WS-Patch & WS-Keys \$ 45 COMPUTING!™ Power! \$119 CONDOR™ Database Management 3 \$369 CONTINENTAL™ Home Accountant CALL DIGITAL RESEARCH™ Access Manager \$225 CBASIC \$109 CBASIC-86 CALL CB-80 Compiler \$379 CB-86 Compiler CALL Concurrent CP/M 86 \$259 CP/M 86 (IBM) \$ 49 Display Manager \$299	PASCAL/MT+ \$259 PASCAL/MT+ 86 \$299 PERSONAL BASIC \$119 SPP CALL Other Products CALL FOX AND GELLER™ Quickcode \$229 dUJil \$ 75 dGraph \$229 FREDERICK ELECTRONICS™ Plantonics Color Graphics Card \$439 HAYES™ SmartModem 1200 \$549 SmartModem 1200B (w/Smartcom) \$489 HERCULES™ Hercules Card \$409 HOWARDOSOFT™ Tax Preparer CALL HUMANSOFT™ DBPlus \$ 95 IMSI™ 4-Point Graphics (IBM PC) \$129 Bisybase \$179 Investment Manager \$179 Accounting Series CALL Datasafe \$ 89 IUS™ EasyWriter II \$229 EasySpeller II \$129 Easy Mailer CALL EasyWriter/Speller/Mailer CALL EasyWriter/Speller/Filter CALL EasyFilter \$249 Financial Management Series \$299/MOD Other Products & Specials CALL LEXISOFT™ SpellBinder \$269 LIFETREE SYSTEMS™ VolksWriter \$129 Display Manager International \$155	VolksWriter Deluxe \$179 LOTUS™ 1/2/3 \$369 METASOFT™ Benchmark \$299 MICROLAB™ Tax Manager \$179 MICROPRO® WordStar \$269 WordStar/MailMerge \$369 Professional Pack (WS/MM/SS/Sl) \$389 WordStar (Optional Professional Pack (SS/Star Index/Free WS 3.3 Update) \$169 WordStar/InfoStar \$539 MailMerge \$139 InfoStar \$289 CalcStar \$129 DataStar \$179 SuperSort \$149 DBPlus \$139 ReportStar \$229 StarIndex \$129 StarBurst \$139 Apple Packages and Other Products CALL MICROSOFT® Basic Compiler \$295 MBasic 80 Interpreter \$275 C Compiler \$379 COBOL Compiler \$549 Flight Simulator \$ 45 Fortran \$259 Fortran 80 \$349 Mouse \$169 Multiplan™ \$189 Multi-Tool Expert Systems CALL Pascal Compiler \$259 Premium Pack \$509 Premium Softcard \$379 Ramcard \$ 89 Softcard™ \$259	System Card CALL MICROSTUF™ Crosstalk \$119 MOUSE SYSTEMS™ PC Mouse \$249 OASIS™ The Word Plus \$129 Punctuation and Style \$109 ORGANIC™ Milestone \$269 PBL CORPORATION™ Personal Investor \$105 PC DEMO™ Demo Disk \$ 18 PEACHTREE™ PeachText 5000 \$239 PERFECT SOFTWARE™ Perfect Writer \$259 Perfect Speller \$129 Perfect Writer/Speller \$359 Perfect Filter \$279 Perfect Calc. \$169 All Four Perfect Products \$699 PETER NORTON™ Norton Utilities \$ 59 PICKLES AND TROUT™ (CP/M for TRS) \$169 TRS-80 Model II, 16 & 12 Hard Disk \$225 PROFESSIONAL SOFTWARE™ Word Plus PC \$279 Word Plus PC w/Boss \$349 QUADRAM™ Quadboard (64K) \$325 Quadboard (256K) \$489 Quadlink \$559 ROSESOFT™ Pro Key \$ 59 SOFTWARE PUBLISHERS™ PFS File \$ 95 PFS File (IBM) \$105 PFS Report \$ 95 PFS Graph CALL	SOFTWARE SYSTEMS™ Multimate \$349 SORCIM™ SuperCalc 3 \$279 SuperCalc 2 \$169 SpellGuard \$129 SuperWriter \$179 TYLOG™ dBASE Window \$139 VERTEX SYSTEMS™ Xeno Copy \$ 75 VIDEX™ Enhancer II \$119 Videoterm \$269 Ultraterm CALL VISICORP® VisiCalc® \$189 VisiCalc® IV \$189 Advanced VisiCalc® CALL VisiTerm \$ 85 VisiDex \$189 VisiFile \$239 VisiSchedule \$239 VisiTrend/Pilot \$239 VisiWord \$279 VisiSpell \$169 Other Products CALL FLOPPY DISKETTES (Boxes of Ten) MEMOREX™ 8" SS/SD \$ 29 8" SS/DD \$ 30 8" DS/DS \$ 43 5¼" (SS) \$ 30 5¼" (DS) \$ 40 Maxell 8" SS/DD \$ 42 8" DS/DD \$ 48 5¼" SS/DD \$ 32 5¼" DS/DD \$ 42 Larger Quantities CALL IN HOUSE SPECIALS AND NEW PRODUCTS CALL

- Purchase orders accepted. Please call in advance.
- Prompt U.P.S. or Federal Express shipping.
- Overnight delivery available.
- Call for shipping charges, other low software prices or for a free catalog.
- Prices may change.

800-SOFTWARE

940 Dwight Way Berkeley, CA 94710

- International and national dealer requests welcome.
- Quantity discounts available.
- Call to inquire about our Corporate Sales Dept.

CA residents add sales tax.

Copyright 800-SOFTWARE 1981



Alas, the Eagle is just *loaded* with undocumented features. It's a wonderful machine, and the documents are just great if all you want to do is run Eaglewriter and Eaglecalc, but ye gods they're incomplete if what you want is to understand the system.

Anyway, if you use the /1 option, the result is a normal ASCII file that compiles nicely. It would even have compiled with the original memory available. On the other hand, Pascal/MT+86 will use as much memory as the machine has

available, and the more you have, the faster things go. Best to have a lot, thought Alex, and when our memory chips came from California Digital, he put 16 of them in.

He swears he did it right. I wasn't here, but I believe him. However, when he turned on the machine, it wouldn't talk to the keyboard. The IBM PC runs a memory check every time you turn it on, so if you have a lot of memory you can go get coffee while the system comes up; but alas, there's not even a voluntary memory-

test program for the Eagle. However, when Alex replaced one of the memory chips—the first one, fortunately, since it's very hard to get at the memory while the machine is sufficiently assembled to be in an operative condition—things ran fine.

Since then we've had a couple of glitches, none fatal, and we very much wish we had some good diagnostic programs.

On the other hand, the time that the Eagle takes away with one hand, it gives back with the other: it's *fast*. You don't have to wait forever for programs to compile. It has a much nicer keyboard than the PC. It has eight IBM PC expansion slots in addition to the empty memory sockets. It's a great deal cheaper than a PC XT. It's designed for multiple users (under MP/M-86). I don't know whether it runs Concurrent CP/M-86 right out of the box, but it can't be hard to get it running. (As I've said before, I think Concurrent CP/M is *the way* to go for PC machines.)

[Late update: the Eagle does have memory tests. You hold down the "T" key on power-up or reset. This is yet another undocumented feature.]

As I write this, they're working hard at Eagle to update the documents and revise some of the software. I wish them well at it—but I sure wish they'd hurry. The Eagle is too good a machine to let the lack of documents and software developments spoil it.

Meanwhile, Marty and Dr. Cheryl Chapman are collecting their notes on what's wrong with the Eagle's documents. By the time you read this, we'll have written them up and sent them in to the Eagle people, who I'm pretty sure will make good use of them.

Write Now . . .

While Tony Pietsch takes in the Munich Oktoberfest, Noor Singh has been doing the work at Proteus Engineering and has now installed and optimized Write for some 40 different 8080, 8085, and Z80 systems. There's no 16-bit version yet, but it's unlikely you have an 8-bit machine, terminal, or printer that won't run

GET REAL 16 BIT POWER

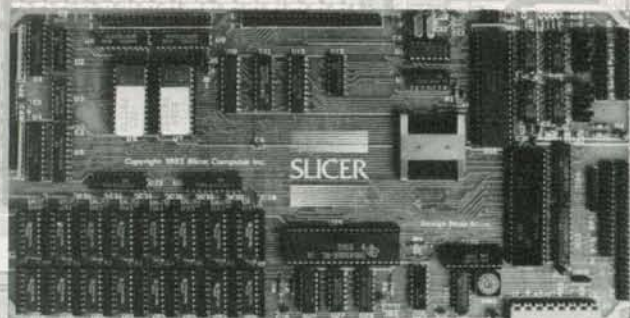

THE SLICER

A SINGLE BOARD COMPUTER FEATURING THE INTEL 80186

(see Byte magazine April '83)

- Full 8MHz 16-bit microprocessor having complete software compatibility with the 8086 and 8088
- 256K Bytes of RAM plus 32K Bytes of EPROM memory capacity on board
- 90 line expansion interface for more memory and peripherals consist of 16 bit data bus, 20 bit latched address bus and all important 80186 control signals
- Floppy disk controller can run the combination of 8", 5-1/4", 3-1/2" drives simultaneously
- SASI port for hard disk controller
- Two full function RS232C serial ports with individually controlled baud rates from 50 to 38.4K baud
- Baud rate for console port acquired automatically
- 8K of EPROM contains drivers for peripherals, commands for hardware checkout and software testing
- Source for monitor and bios included on disk
- Bios for CP/M 86* supports 8", 5-1/4", 3-1/2" drives and the Xebec 1410 controller for hard disks
- Board size 6" x 12" power requirements +5 @ 3A, +12V @ 60mA, -12V @ 50mA
- Complete documentation included.

Sold in various forms:

Assembled and tested	\$1,075.00
Full Kit	895.00
NEW Easy Kit (hard to get parts)	450.00
Bare Kit (board, Rom, doc, and disk)	150.00
CP/M 86* available	85.00
Regular U.P.S. shipping within continental U.S. is included.	

Available Now!

Choose 8 MHz CPU for speed
6 MHz CPU for speedy delivery

SLICER COMPUTERS INC. 2543 Marshall St. N.E.
Minneapolis, MN 55418 (612) 788-9481

SLICER™

Mastercard, Visa, check, money order or C.O.D. orders accepted. Please allow 4 weeks for delivery.

*CP/M a trademark of Digital Research, Inc.

BASF QUALIMETRIC™ FLEXYDISKS.® A GUARANTEED LIFETIME OF OUTSTANDING PERFORMANCE.

BASF Qualimetric FlexyDisks feature a unique lifetime warranty, firm assurance that the vital information you enter on BASF FlexyDisks today will be secure and unchanged tomorrow. Key to this extraordinary warranted performance is the BASF Qualimetric standard... a totally new set of criteria against which all other magnetic media will be judged.*

You can count on BASF FlexyDisks because the Qualimetric standard reflects a continuing BASF commitment to perfection in magnetic media. One example is the unique two-piece liner in our FlexyDisk jacket. This BASF feature traps damaging debris away from the disk's surface and creates extra space in the head access area for optimum media-head alignment. The result is a guaranteed lifetime of outstanding performance.

For information security that bridges the gap between today and tomorrow, look for the distinctive BASF package with the Qualimetric seal. Call 800-343-4600 for the name of your nearest supplier.

Circle 39 on inquiry card.

*Contact BASF for warranty details.

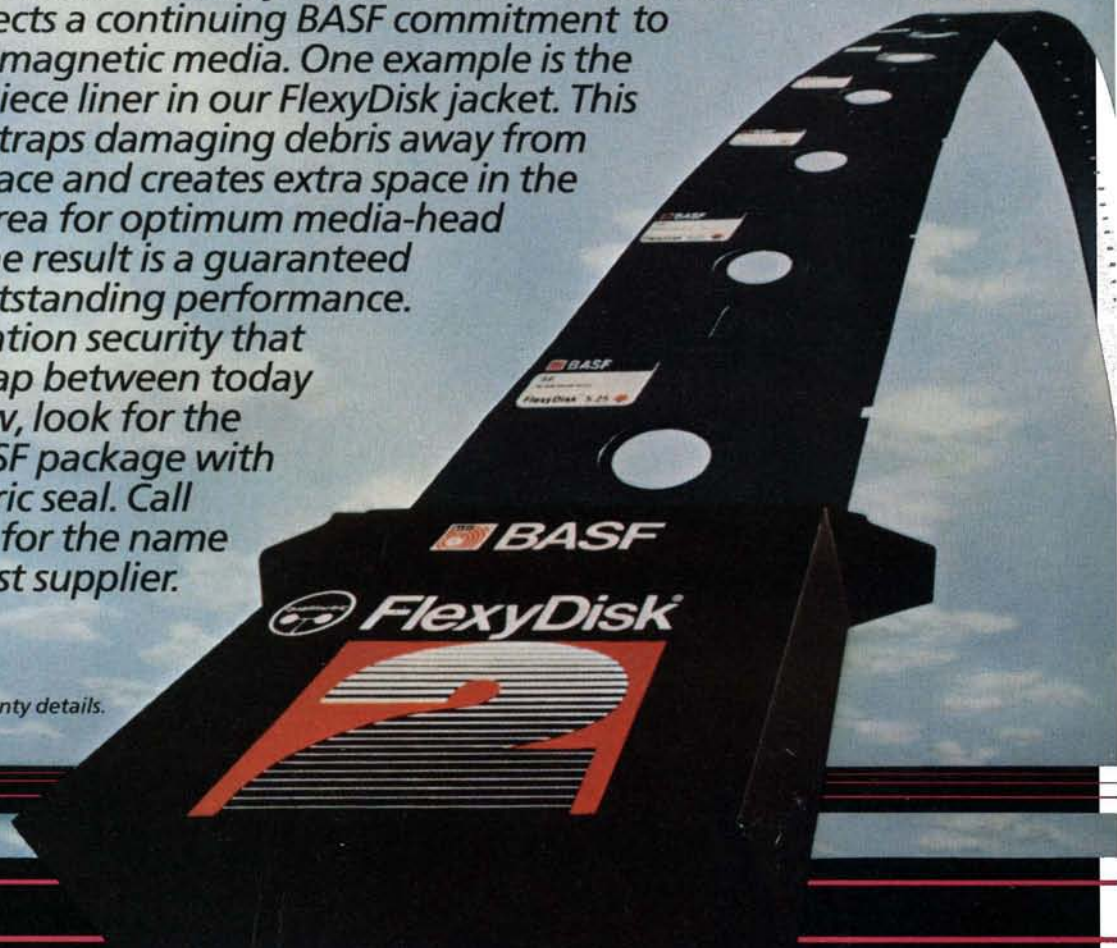

ENTER TOMORROW ON BASF TODAY.



BASF

© 1983 BASF Systems Corp., Bedford, MA

A conventional portable computer isn't so portable.



A conventional computer will take over your office.



A Hyperion portable computer is portable.



A Hyperion keeps a low profile.



How we designed the H for p

Our first step was to remember how a person is designed.

A person isn't designed to carry a nearly 30 lb. object that bangs against the hip and cramps the fingers. So the Hyperion is a manageable 18 lbs. and travels in an easy-to-carry tote bag.

A person isn't designed to work in the shadow of a computer. So the Hyperion

keeps a low profile.

A person isn't designed to worry about an expensive computer being dropped by baggage handlers. So the Hyperion fits under an airplane seat. Easily.

A person isn't designed with a phone attached to his ear. So the Hyperion has a telecommunications hook-up that finds numbers, dials, and makes a connection

A conventional portable
isn't fit for airline travel.



A conventional
computer is
just a computer.

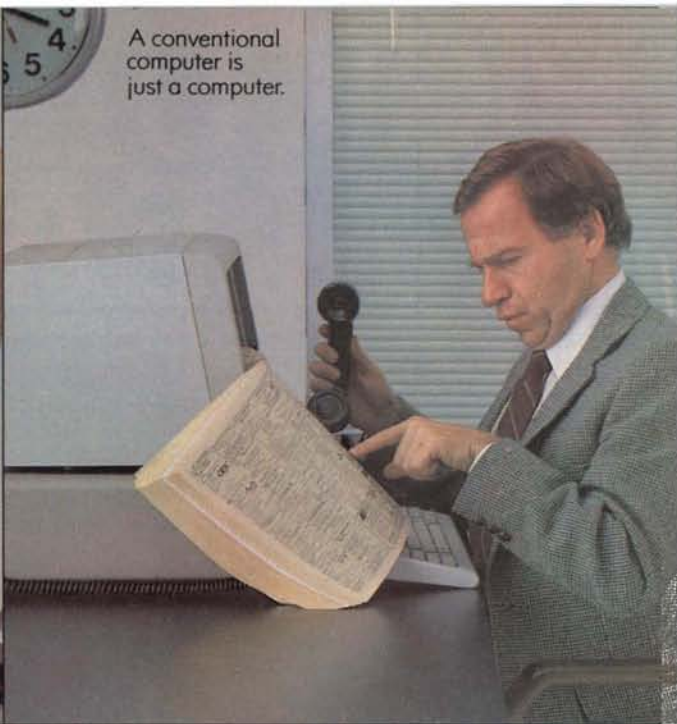

The Hyperion can go
with you anywhere.



A Hyperion
computer is also
a telecommuni-
cations link.



Hyperion personal computer for persons.

without a person ever picking up the receiver.

And no person, no matter what design, wants to work harder than needed. So the Hyperion has all the power needed, and uses IBM® compatible software — the best and easiest to use software written.

But no matter what we say about the Hyperion, the only way to see the difference is to come in and pick one up. In person.

Hyperion is a registered trademark of Bytec-Cormem Inc.

For the dealer nearest you call
1-800-323-1717, Ext. 246. In Illinois
1-800-942-8881, Ext. 246. In Canada
call 1-800-267-1002 or 1-613-226-7255.

Hyperion™

You'll never look at computers
the same way again.

Circle 50 on Inquiry card.



PICK UP WHERE IBM® LEAVES OFF.

Portable or desktop, you're way ahead when you pick up a **CORONA PC.™** Because we give you everything you've ever wanted in an IBM¹-compatible PC and more. For a great deal less.

COMPATIBLE AND MORE.

Our systems run all software that conforms to IBM PC programming standards. And the most popular software does.

We deliver twice the memory, with room for eight times as much.

We deliver a fast-access 320K floppy drive, a communication port and an improved IBM PC keyboard with indicator lights.

Our systems include high-resolution monitors (12" desktop, 9" portable) for crisper, cleaner displays, and both have built-in high-resolution graphics (640 x 325).

You get a complete system, ready to go to work.



MORE VERSATILITY.

With all the necessary features built into the main unit, the four expansion slots can be used for your special needs. For example, color or our optional 10MB hard disk.



MORE SPEED.

Our RAM-disk software gives you temporary disk-type storage that works many times faster than disks.

PLUS SOFTWARE.

Our systems come with the operating system: MS-DOS.² A programming language:

GW BASIC.² A training course: PC Tutor.³ A professional word processor: MultiMate.⁴ Plus DOS utilities and demonstration programs. Or you can get the p-System⁵ from N.C.I. and write or run portable Pascal packages.

ALL FOR A GREAT DEAL LESS.

Even with all the extra features and performance, our systems still cost significantly less than the equivalent IBM PC.

Drop by your nearest **CORONA PC** dealer for a very convincing demonstration. Or contact us at 31324 Via Colinas, Westlake Village, CA 91361. (213) 991-1144 or (800) 621-6746 toll-free. Telex 658212 WSLK, in Europe 76066 CDS NL.



© Corona Data Systems 1983. 1. TM International Business Machines. 2. TM Microsoft. 3. TM Comprehensive Software Support. 4. TM Softword Systems. 5. TM University of California.



CORONA
data systems, inc.™

with Write. For instance, he's figured out a way to reverse scrolling on the VT-100, which everyone told us wasn't possible, or at least not simple, since the VT-100 doesn't have an insert/delete line.

While I was at CP/M East, Charles Stevenson, chief programmer for Micropro, told me he's been having some problems with modern dot-matrix printers, because many of them don't do superscripts and subscripts by scrolling the paper up and down, but actually write little bitty letters and numbers in the appropriate places. Wordstar doesn't like that.

Neither did Write, but Noor Singh has found a way to make Write work fine with the new Epson FX-80 printer. We've now got Write on all the Kaypro machines, the Otrona, and the Z-100 (under CP/M-80). It runs with the Telewidget (Televideo) terminals, the Z-29, and the Lobo Max-80. Barry Workman and Noor Singh are installing it on the Osborne 1 and the Epson QX-10 (two versions, one for the Valdocs keyboard, the

other for their nonstandard CP/M Teletype-layout keyboard). It runs on nearly all printers, serial and parallel.

Write will be supplied as part of the software package (along with Superwriter, Supercalc, and some other stuff) with new Compupro computers. Other versions, including those for older Compupro machines, will be marketed by Workman and Associates.

The Printer Install program will come with any version of Write that you buy. Workman's present market plan is to restrict the Terminal Install programs supplied, so if you order Write, be sure and tell the company what kind of machine and what kind of terminal you want Write for. I presume the company will have a reasonable policy regarding updates if a purchaser wants to change terminals.

Sweet-P

We got our Sweet-P plotter some time ago, along with a care package to make it work with the IBM PC. There was also a support pack for the

Kaypro machines. Our Kaypro machines have been under intense use, and there wasn't any real reason to hang a plotter on one anyway. We did budget space for the Sweet-P at the desk where we intend to set up our IBM PC.

Alas, the PC hasn't arrived, and the Sweet-P sits in lonely splendor waiting for a computer.

That's a real pity, because the Sweet-P is one heck of a machine. There is close competition, but none so vigorously supported and advertised.

We were curious how hard the machine was to use; Alex got to play with one on a Kaypro at a graphics show. You can use LPRINT statements from within MBASIC to run the Sweet-P. For legends and titles, you don't have to specify each letter stroke; the plotter has a built-in character set. Character size and print direction can be changed, too.

Sweet-P has changeable pens; you have to change them yourself, but that keeps the price (of this model) down. Sweet-P currently connects as

IBM PC-8087 SUPPORT FROM MICROWARE

87FORTRAN/RTOS™ is a MicroWare adaptation of the Intel Fortran-86 compiler, a full ANSI-77 subset with 8087 extensions and overlays. It generates in line 8087 code allowing use of all 8087 data types, including 80 bit reals and 64 bit integers. The complete subset I/O is supported including Internal and External Files and List Directed I/O.

87FORTRAN/RTOS uses the Intel large memory model, allowing data/code structures which utilize the full megabyte. The compiler provides direct access to 8088 ports and supports logical operations on 8 and 16 bit operands normally treated in assembly language. It is ideal for large applications which are number intensive or control hardware.

87PASCAL/RTOS™ is Intel's ISO-Standard Pascal with 8087-8088 exceptions. These make it possible to use all the 8087 data types directly, while generating modules in one of the three Intel Memory Models.

87FORTRAN/RTOS and

87PASCAL/RTOS include RTOS and support for one year. each **\$1350**

PC TECH JOURNAL REVIEW:

"The MicroWare package is preferable ... it executes the basic operations more rapidly and MicroWare provides a free update service."

87BASIC™ includes patches to the IBM Basic Compiler and both runtime libraries for USER TRANSPARENT and COMPLETE 8087 support. Provides super fast performance for all numeric operations including trigonometrics, transcendents, addition, subtraction, multiplication, and division. **\$150**

87MACRO™ - our complete 8087 software development package. It contains a "Pre-processor" which converts 8087 instructions into 8088 escape codes, source code for a set of 8087 macros, and an object library of 8087 functions which include transcendents, trigonometrics, hyperbolics, encoding, decoding and conversions. **\$150**

PLM-86 with RTOS. **\$1100**

MICROWARE BEST SELLERS!

8087-3 CHIP in stock with 180 day warranty and 8088 exchange. **\$199**

FASTPAK™+8087 includes one runtime library (87BASIC or 87MACRO), the 8087 chip, the 87/88GUIDE, and installation instructions. **\$375**

MATRIXPAK™ manages a **MEGABYTE!**

Written in assembly language, our runtime package accurately manipulates large matrices at very fast speeds. Includes matrix inversion and the solution of simultaneous linear equations. Callable from MS Fortran 3.13, MS Pascal 3.13, SSS Fortran, and MicroWare 87MACRO, 87BASIC, and RTOS compilers. each **\$150**

87/88GUIDE - an excellent tutorial on writing 8087 code and interfacing it with compilers. Full of code that runs! **\$30**

MICROSOFT FORTRAN 3.13

MICROSOFT PASCAL 3.13 These new IEEE compatible compilers support both double precision and the 8087. each **\$289**

MICROSOFT C COMPILER includes Lattice C and the MS Librarian. **\$399**

64K RAM Upgrade. **\$59**
 SuperSoft Fortran. **340**
 SSS 8087 Support. **50**
 SuperSoft Voice Drive. **895**
 87BASIC+. **75**
 TRACE86 Utility. **125**
 Microsoft Business Basic Compiler. **495**
 Computer Innovations C86. **345**
 STSC APL★PLUS/PC. **545**
 64K QUADRAM. **319**
 Sandstar WS2 Hard Disk System. **1355**
 Novation 212 SmartCat. **495**
 HALO Graphics. **call**
 Energraphics. **call**

RTOS™ — Real Time Multi-Tasking Operating System

RTOS is a MicroWare configured version of iRMX-86, Intel's legendary operating system. It includes the Intel Assembler, ASM-86, which supports the 8086, 8087, 8088 and 80186. All modules produced by the compilers or ASM-86 are combined, loaded and managed with the Utilities LINK-86, LOC-86 and LIB-86. These products make it possible to load modules anywhere in RAM, and resolve external references between runtime modules. Overlays with a single root job are supported by the linker. RTOS/ASM-86/LINK-86/LOC-86/LIB-86. **\$600**

iRMX-86, LINK-86, ASM-86, LOC-86 and LIB-86 are trademarks of Intel Corp. IBM PC is a trademark of IBM Corp.

**Micro
Ware**

P.O. Box 79
 Kingston, MA
 02364
 (617) 746-7341

**You Can
Talk To Us!**

"I built this 16-bit computer and saved money. Learned a lot, too!"

Save now. Build the H-100 kit, a computer that will keep pace with technology for years to come.

Advanced 16-bit computing at a kit price! With most circuit boards already pre-wired, H-100 is our easiest computer kit. And our manuals ensure that "We won't let you fail!"

Dual microprocessors deliver 16-bit speed and 8-bit compatibility. The industry standard S-100 card slots allow a host of peripherals and memory expansion to 768K RAM.

A high-density (320K) 5.25" drive is standard. Powerful options include an internal multi-megabyte Winchester drive (available soon).

See the world's first 16-bit/8-bit computer kit, plus peripherals and

software...at your Heathkit Electronic Center.† Or mail the coupon today for a FREE Heathkit catalog!

H-100 SERIES COMPUTER SPECIFICATIONS:

USER MEMORY:
128K-768K bytes*

MICROPROCESSORS:
16-bit: 8088
8-bit: 8085

DISK STORAGE:
Built-in standard
5.25" disk drive,
320K bytes/disk

KEYBOARD:
Typewriter-style,
95 keys, 13
function keys,
18-key numeric pad

GRAPHICS:
Always in graphics mode.
640h/225v resolution;
up to eight colors
are available**

*128K bytes standard.
**Optional.

COMMUNICATIONS:
Two RS-232C Serial
Interface Ports and
one parallel port

DIAGNOSTICS:
Memory self-test
on power-up

AVAILABLE SOFTWARE:
Z-DOS (MS-DOS)
CP/M-85
Z-BASIC Language
Microsoft BASIC
Multiplan
SuperCalc
WordStar
MailMerge
Data Base
File Manager
Most standard
8-bit CP/M
Software

Buy from
the leader in
electronic kits
and save!

†Heathkit Electronic Centers are units of Veritechnology Electronics Corporation. Heath Company and Veritechnology Electronics Corporation are subsidiaries of Zenith Radio Corporation. CP/M is a registered trademark of Digital Research Corporation.

a Centronics printer; the serial option will be available soon. If you want to use both the plotter and your printer from the same Centronics port, Enter Computer will soon sell you a "Split-P" printer switch. (I get the feeling that we have not heard the last bad pun product name from these people. . . .)

More PC Stuff

Ada, for the tiny few who don't know, is the Department of Defense all-purpose computer language, and whatever its merits or lack thereof, knowing Ada is a sure guarantee of a job for years to come. Despite some claims to the contrary by companies that ought to know better, there is no complete Ada compiler for a micro system. However, there are healthy subsets up and running.

The best of these, for my money, is Janus Ada from RR Software. The company now has floating point for its PC-compatible version (both PC-DOS and CP/M-86 operating systems), provided that you have an 8087 chip in your system. RR has also cleaned up its documents a bit; they always were well organized.

I can't check out the latest version, since IBM has kept my money all these months without shipping me a machine; but I have run RR's earlier versions, which certainly work. Janus will compile itself, sure proof that you can write complex programs in this subset of Ada. I have high confidence in RR, and I have yet to hear of a more complete Ada compiler that will run on a microcomputer.

RR, otherwise known as Randy and Isaac, is another good example of what hard work and ingenuity can accomplish. The two started quite literally in a garage, and the West Coast Computer Faire was their first show; now they've about reached the takeoff point.

Simplifying My Life

I like small computers. I don't suppose there are too many readers who doubt that. However, they can sure use up a lot of time, and time is the one commodity we don't have mouldering piles of here at Chaos Manor, so I'm always looking for

Get your full-color

FREE

Heathkit
Catalog!



Heathkit

CLIP COUPON AND MAIL TODAY TO:
Heath Company, Dept. 334-132
Benton Harbor, MI 49022

Please send my FREE Catalog,
with details on the new 16-bit/8-bit
H-100 Computer Kit, today!

Name _____

Address _____

City _____ State _____

CP-219R2 Zip _____



step into the future ... *COHERENT*

COHERENT™ is the most powerful UNIX™-compatible operating system available for the IBM PC™, IBM XT™ and compatibles

Now you can have the multi-user, multitasking programming capability of a mainframe on a microcomputer. The UNIX-like environment of COHERENT lets you take C code developed using UNIX V7 system utilities and compile and run it on the IBM PC. Through COHERENT'S highly-optimized kernel you can access over 145 different commands including a C-compiler, a text-formatter and LEX and YACC.

Hard disk support presently includes the IBM XT, Genie (removable cartridge), Corona, Davong,

Corvus and Tecmar. Memory cards supported include the AST Megaplus (with or without clock), the Tecmar multifunction board and Tall Tree Systems (512K byte) JRAM cards. Support for more devices and more IBM PC compatibles will be available by the time this ad appears.

The cost of all this — far less than the cost of similar UNIX-based operating systems. Remember, when you buy COHERENT from NCI you receive all the documentation and technical support you need to operate it.

For more information call or write:

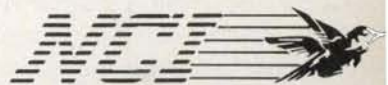

Network Consulting Inc.
Discovery Park,
3700 Gilmore Way, Suite 110,
Burnaby, B.C. Canada V5G 4M1
(604) 430-3466

COHERENT is a trade mark of Mark Williams Co. UNIX is a trade mark of Bell Laboratories. IBM PC and IBM XT are trade marks of International Business Machines Corporation.

Circle 267 on inquiry card.

BYTE January 1984

LOG 1983 Volume One

Phone	Rhodes, Eli	. . .	161
	Rick Foss	Travel agent	33
	Roth, Jennifer	. . .	70
	Rotow	Fortune Systems	25
	Salzer, Shirin	Bellingham	91
	Seelig	CTI	48
	Seitz	. . .	95
	Slicer	. . .	170
	Smelev, Sev	. . .	5
	Smith, Harlan	. . .	166
	Space Initiative	50	50
	Sperry, Tyler	. . .	139
	Sperry, Tyler	113	113
	Spinrad	. . .	16
	Still, Joe	. . .	91
	Tanden	. . .	174
	Topol	Russian emigre	118
	Van Erink, Herb	ARCO	93
	Z-100	Pascal - Ludwig	103
	Zenith	Ingish	48
Program	BIOS	149
	BIOS	diddle	156
	Characters	generator	31
	Diddle	12
	Diddle	concatenate string fields	17
	Diddle	Fns of other cpdata	10
	MDE	parameters - strings	106
	MDB	REVISE - discussion	13
	MDB	sort/merge	105
	Names	Spear carriers	30
	Parse	notes	115
	Parser	116
Relativism	Stine on aliens	40-41
Suits	Notes	Kosmo etc	34-37

Table 1: An example page from Jerry's index.

ways to use these machines to buy me more time.

One thing that eats time is the telephone. It isn't just the time on the telephone; it's finding the messages and phone numbers and all the detritus from phone calls. I long ago learned that anything written on loose paper vanishes into the swim, so I keep a bound log book with page numbers.

One of the most valuable commodities a writer can have is a good idea. Those, too, get lost if not written down. I get some of my best ones while running, when I can't make notes, so I carry a tiny tape recorder and dictate; then when I get home I can transcribe those notes. I used to keep special books just for that, but it became impossible to find

anything, so all that goes into the log with the phone calls.

So far, so good, but I use up two or three of those logs each year; and how the devil can I find a phone number, or an idea, from several years back? After about the hundredth time I found myself thumbing through old log books, I had an idea. What I needed was an index to the logs. It seemed a simple enough program to write.

The log books aren't machine-readable. I've had to go through them one at a time and enter the data (and I have to do it since no one else can interpret my cryptic notes); but it takes only about half an hour to do a whole book, and once done it's done forever. I have my index organized under three headings:

"Major," "Minor," and "Subminor," which, if not original, is at least clear.

The output prints on paper (see table 1) and can be pasted into the front of the log book. It organizes the stuff in a hierarchy, with the Major headings (things like "Do," "Phone Numbers," "People," "Ideas") on the left. The Minor categories include "Programs" (under "Do," of course), people's names for the phones and addresses (with cross-entries for who they are or what they do or where I met them). Subminor is mostly notes. Then on the far right side of the index is the page.

Once the entries are made (as I said, about half an hour per log book), the program automatically sorts them, starting with the Subminor, then Minor, and finally Major headings, so that all the names are in alphabetical order within the "Phone" category, and that sort of thing. This gets printed and put in the book, and I can even do it periodically for the current log so I'm not always thumbing through it. Saves no end of time.

Another thing the index program does is remember just what log book this is: that is, 1983-1, 1979-3, etc. Another part of the program will combine index entries from different books. The result is that I have an enormous index that lets me find stuff running all the way back to 1978 when I began the log-book system (or will when I get through entering 1978 and 1979).

There's nothing all that wonderful about my scheme, and doubtless there are better ways to organize log books, but this works for me. The nice part is that the whole program didn't take more than a couple of hours to write. A story goes with that.

A long time ago I wrote a "Minimum Data Base" (MDB), which is a quick and dirty program for organizing telephone numbers, addresses, recipes, thoughts, characters in books, and the like. It has a good SORT routine built into it. When I decided to do this program, I realized that MDB had nearly all the mechanisms I needed for my index routine.

Hire performance.

Gifford gives you more.

When you go with Gifford, you get more than you ever thought possible from a multiuser computer system. Or a computer company. More productivity. More flexibility. More expandability. More speed. And more support.

It means *total performance* for every Gifford customer.

Gifford systems can run *both* 8 and 16-bit programs, giving you an incredible choice of over 5,000 CP/M® or MP/M™ applications. And we developed this feature, so when we say it really works, it really does.

In addition, our systems can run popular single user programs, while giving you multiuser benefits such as the ability to share resources like printers and hard disks, plus advanced security features to protect sensitive information. And you can run true multiuser programs with features like file lockout, record lockout and shared data bases.

All Gifford systems use CompuPro's proven S-100 based products, making it easy to accommodate any

performance enhancements.

For example, expansion's a snap ... literally. Just snap in an expansion board, add a terminal, and you're ready to handle more. And since every system has twenty bus slots, there's plenty of power for everyone.

Gifford keeps on giving.

To make absolutely sure you get all the performance you hire, we support everything we sell. Should you ever need to call us, use our hotline to reach a knowledgeable representative.

And, if the problem can't be solved with words, it can be diagnosed via modem. If the problem is hardware related, we'll replace any defective CompuPro part within 24 hours *free* for two full years. Support continues with our two, three and five day hands-on seminars.

Meet our specs.

Just look at what our popular \$9990 three user system includes: 320K static RAM memory, two 8" DS/DD floppies, the Gifford F5-21

Winchester 21Mb drive, a CompuPro enclosure with IEEE 696/S-100 bus with 20 slots and nine I/O ports. Plus dBASEII™ SuperCalc-86™ and MP/M-86™

Other exclusive features include time accounting for users and projects, electronic mail, system scheduler, non-destructive memory test, MP/M II queue calls, and more. As well as expansion capabilities for up to six users.

Make the cut.

If you need our kind of performance, cut the coupon or give us a call. We'll send you a free brochure detailing our exclusive high performance features, our two year warranty, and the benefits of selecting an IEEE 696/S-100 bus-based system.

But if you don't need to hire us, there's only one possible reason. You already have.

Gifford Computer Systems is a Full Service CompuPro® Systems Center.



The powerful Gifford System 321 shown with optional GCS-80 terminals.

GIFFORD COMPUTER SYSTEMS

1922 Republic Avenue, San Leandro, CA 94577
(415) 895-0798 A Division of G&G Engineering
I'D LIKE THE WHOLE STORY.
Please send me your brochure.

Name _____ Title _____

Organization _____ M/S _____

Address _____

City _____ State _____ Zip _____

Phone _____

Please have a representative call me. By-P

GIFFORD COMPUTER SYSTEMS San Leandro, CA (415) 895-0798 San Francisco, CA (415) 391-4570 Los Angeles, CA (213) 477-3921
 Miami, FL (305) 665-9212 Houston, TX (713) 680-1944 Amherst, NY (716) 833-4758 Telex: 704521

Circle 170 on inquiry card.

MDB was originally written in CBASIC. I later converted it to CB-80, which was the first Compiled CBASIC; but since CB-80 won't run with CP/M 1.4, we kept the CBASIC version around. Alas, CBASIC doesn't have some of the nifty features that Compiled CBASIC does (such as checking for undeclared variables, and really good functions). Even so, we'd done a lot of the conversion, and when I did the index program I did some more. More important, though, when I began

writing programs, MacLean insisted that I think about program structure as I wrote them; and although MDB isn't any model of structured programming, it's a heck of a lot more so than most old BASIC programs were, which is why I was able in one evening to write my index system.

Alas, it was while writing it that I discovered a real bug in the newest version of Compiled CBASIC.

That's Not a Bug, It's a Feature
When my late mad friend MacLean

first talked me into trying my own programming in BASIC, one of the things that drove me nuts was the "redimensioned array error." That is: in early BASIC (and many late-model versions for that matter) you must tell the machine the size of any array, and you must do that one and only one time; any subsequent attempt to change the array size gets the error message.

When CBASIC, and later Compiled CBASIC (otherwise known as CB-80 and CB-86), first came out, a major feature was *dynamic array dimensioning*, i.e., you could dimension any array as often as you wanted to. There are lots of advantages to this. It saves memory and frustrations.

Of course, any data in the array will be lost if you redimension it. That's only to be expected. Alas, it isn't *automatically* lost; that is, if you have string variables stored in an array and redimension it, the strings are still out there in memory, only now there's no way to get at them, not even to erase them. Some versions of BASIC have a "garbage collection" feature, which is a little subprogram that every now and then goes through memory to see if there are lost strings it can erase to reclaim memory. Some don't.

With Compiled CBASIC, according to the instructions, you have to do something nonintuitive to get rid of those strings:

1. Declare a string variable. Say NULL\$, for example.
2. Never define that variable. (I presume the default is "", but the documents never say.)
3. Set each element of the string array equal to NULL\$.
4. Dimension the array to 0.
5. Redimension the array to the new value.

That's complicated, but you can see that it saves the compiler a lot of work. Alas, there's no way for you to get out of doing your part of that work. Compiled CBASIC has really excellent functions, comparable in some ways to Pascal functions and procedures, but you cannot pass an array to one of them as a parameter.

EE/EPROM PROGRAMMERS & UV ERASERS



GANGPRO-8™ MULTIPROGRAMMER \$995.00

GANGPRO-8™ allows user to program up to 8 EE/EPROMS simultaneously using the latest state of the art programming algorithms. It can test and duplicate a wide variety of devices from 16K to 256K. There are no personality modules to buy. 8 digit alphanumeric display prompts user with messages. This unit is extremely easy to operate and is ideally suited for a production environment.

QUV-T8™ series UV EPROM ERASERS

QUV-T8/2T (\$97.50) is an industrial quality eraser designed in a steel enclosure with a 5" wide tray, UV indicator lens, antistatic pad, 60 minute rugged timer and safety interlock switch are standard. Capacity is 24 EPROMS. 15-20 minutes erase time for 15 EPROMS.

QUV-T8 / Z (\$124.95) Similar to QUV-T8/2T (with 40% faster Erase Time)

QUV-T8/2N (\$68.95) Same as the QUV-T8/2T version without the timer and safety interlock switch.

QUV-T8/1 (\$49.95) Economy model in a molded two part plastic case. Erases 15 EPROMS in 15 minutes.

*MCS-48 is a registered trademark of Intel Co.

PROMPRO-7™ SERIAL RS-232 STAND-ALONE \$489.00

MCS-48™ FAMILY PROGRAMMING WITH PROMPRO-7
PROMPRO-7™ is an intelligent self-contained unit, ideally suited for engineering development, or for field service & production. It can program and verify a wide variety of 8K to 128K EPROMS. This unit has a 32K (4K BYTES), internal RAM Buffer that could be accessed by the user through a computer or terminal. This unit can also program the micro chips such as the 8478, 8749, 8751, 8741, 8742, 8755. The price includes all modules up to 32K EPROMS & The 8748 & 8749H Micros. Upload/download is done by either Motorola or Intel Hex format.

PROMPRO-8™ SERIAL RS-232 STAND-ALONE \$689.00

This extremely versatile programmer has as much as 128K (16Kx8) of internal RAM dedicated to the EE/EPROMS. This RAM buffer can be accessed either through a computer terminal, or by user target system (EPROM emulation). PROMPRO-8 8 digit alphanumeric display prompts user with the system messages. A keypad option is available for standalone editing. An impressive range of devices are programmed (as standard feature).

The Right Equipment for Your Eproms at the Right Price!



AVAILABLE SOFTWARE DRIVERS
1. IBM PC 2. APPLE II 3. MDS-ISIS 4. CPM
5. TEKTRONICS 80C2 6. ATARI 7. TRS-80 COLOR 8. FLEX
LOGICAL DEVICES, INC.

1321-E N.W. 65th PLACE · FORT LAUDERDALE, FLORIDA 33309
TEL. (305) 974-0967 · TWX. 510-955-9596
DISTRIBUTORS WELCOME FOR QUALIFICATIONS

WASHINGTON (UPI) — The U.S. Air Force/NASA have developed an experimental spacecraft given the title XTM. Due to the vague description as to the design or purpose of the XTM, the press is still in the dark about many aspects of the craft, its intended mission. It has been discovered, however, that at least three pilots have been lost in the current flight testing program of the mysterious

TIME MACHINE I

Starfire Games offers you the ultimate challenge in adventure games: Time Machine I. First in a series of time travel episodes, Time Machine I catapults you into mind bending mystery where the extraordinary is commonplace and dangers are as real as any human experience.

You are the fourth test pilot to fly the joint Air Force/NASA XTM series experimental "craft", a vehicle which transverses through time, the true last frontier. Provided with the newly modified but still untested version of the craft, XTM-3, your mission is to rescue the three previous test pilots who are lost somewhere in the infinity of time itself.

Not far into the mission, you discover this task is more than you could have imagined. Never knowing what you will encounter next, you maneuver your ship from one

adventure to another. You draw upon every resource to survive events ranging from battles with Vikings in the past to outwitting aliens in the future for your ship, the lost pilots, even your very life. But prepare, your final challenge is to return to your own time era safely, a feat which has not been accomplished by any pilot before you.

Time Machine I is available for your IBM PC or XT (64K, disk drive), Apple II+ or IIe (48K, disk drive, DOS 3.3), Commodore 64 (cassette or disk drive), Atari 400 and 800 (48K disk drive). TRS-80 version to be released soon.

*Ask for Time Machine: \$34.95 at your local dealer or order direct. Visa, Mastercard, Money Orders
Checks accepted (Calif. residents please add 6½% sales tax). Dealer inquiries invited*

STARFIRE GAMES, Division Omnisoft Corporation
Dept. ST3, 9960 Owensmouth Avenue, Suite 3;
Chatsworth, CA 9131
(213) 709-490

IBM PC and XT, Apple II+ and IIe, Commodore 64, Atari, and TRS-80 are registered trademarks of
IBM Corp., Apple Computers Inc., Commodore Business Systems Inc., Atari Inc., and Tandy Corp. respectively.

THE BUFFER DID IT.

Who Stole The 1500 Letters From The Computer?

Let's just say you've got to send a letter to 1500 different people. Would you like to spend 22.5 hours* or 60 seconds of computer time?

With a garden-variety buffer, the computer has to mix, merge and send 1500 addresses and 1500 letters to the buffer. Trouble is, most buffers only store about 32 letters. So after 32 letters, the computer's down until the printer's done. Altogether, you're talking 22.5 hours.

In the case of our new (not to mention amazing) ShuffleBuffer, computer time is 60 seconds flat. Just give

ShuffleBuffer one form letter and your address list, and it takes care of the mixing, the merging, and the printing. But that's not all ShuffleBuffer's stolen from the computer. Oh, no.

Who Changed and Rearranged The Facts?

Again, ShuffleBuffer's the culprit. You want to move paragraph #1 down where #3 is? Want to add a chart or picture? No problem. No mystery, either. Any buffer can give you FIFO, basic first-in, first-out printing. And some

buffers offer By-Pass; the ability to interrupt long jobs for short ones. But only ShuffleBuffer has what we call Random Access Printing — the brains to move stored information around on its way to the printer. Something only a computer could do before. Comes in especially handy if you do lots of printing. Or lengthy manuscripts. Or voluminous green and white spread sheets. And by the way, ShuffleBuffer does store up to 128K of information and gives you a By-Pass mode, too.

And Who Spilled The Beans 239 Times?

Most buffers can't tell the printer to duplicate. If they can, they only offer a start/stop switch, which means you're the one who has to count to 239. Turn your back on your buffer, and your printer might shoot out a room full of copies. ShuffleBuffer, however, *does* control quantity. Tell it the amount, and it counts the copies. By itself.

So, What's The Catch?

There isn't any. Sleuth around. You won't find another buffer that's as slick a character as this one. You also won't find one that's friendly with any parallel or serial computer/printer combination. This is the world's only universal buffer. With a brain.

Who Wants You To Catch A ShuffleBuffer In Action?

You guessed it. We do. Just go to your local computer dealer and ask him to show you a ShuffleBuffer at work. Or, you can call us at (215) 667-1713, and we'll clue you in on all the facts directly.

* Based on an average 4000 character letter & 128K buffer.

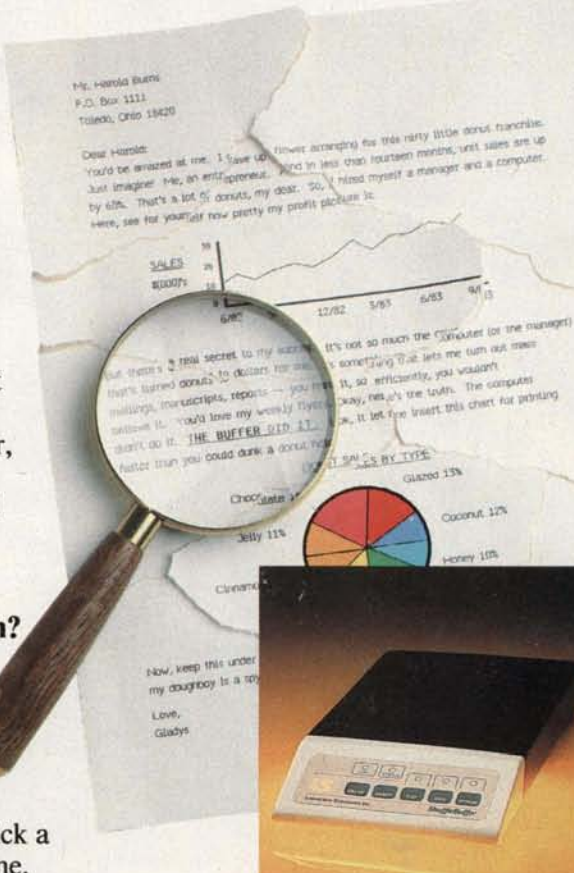
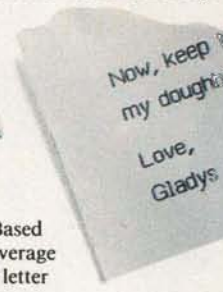
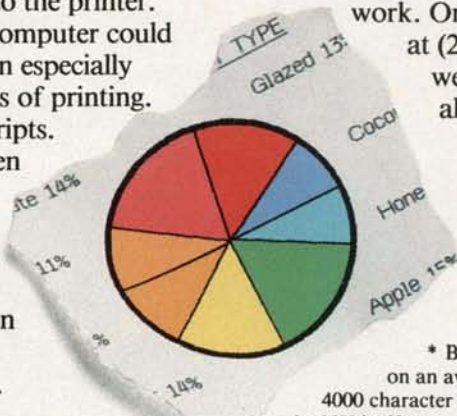
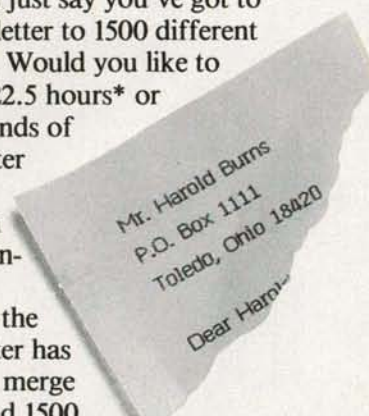

ShuffleBuffer
The Buffer with a Brain
Interactive Structures Inc.
146 Montgomery Avenue
Bala Cynwyd, PA 19004

TAKE THE CATALOG

CHALLENGE

- For Savings
- For Selection
- For Service

Other companies waste time and overhead producing expensive catalogs. Computers and More doesn't. Putting the latest products and best prices in our customers' hands, not catalogs, is our goal. We challenge any catalog company to match our pricing, selection and service. Take the catalog challenge and save!

If you could, it would be easy to write a "Kill String Array" function to do all that. Oh, well.

The problem comes when you forget and *never dimension the array in the first place*. Unlike Microsoft BASIC, CBASIC has no default array size. It doesn't even default to 0! The result is a terrible bug in your program.

If you leave an undimensioned array in a Compiled CBASIC program, the compiler won't find it. Your program will compile fine. It will run, too, until you try to do something with that array, at which point the whole system goes off into the land of lost bits. There's no error message. However, nothing whatever is happening, and nothing you can do (other than to reset the machine) has any effect. This can be frustrating, and indeed it took me half an hour to figure out what had gone wrong with a simple modification to my Minimum Data Base.

I suppose it's not too high a price to pay for dynamic redimensioning, but it's sure frustrating if you don't think of it.

Actually, it's worse than that. There's *no* range checking in Compiled CBASIC, meaning that if you exceed the boundaries of an array, you don't get the "Subscript out of Bounds" error you'd expect. It just hangs up the machine so that you have to reset. That is too high a price to pay.

Example:

```
REM A program to test arrays
Integer i,j
Real a(2)
Dim A(2,2)
FOR i = 1 TO 3
FOR j = 1 TO 2
  A(i,j) = i + j
  Print "Watch it crash"; A(i,j)
NEXT
NEXT
```

This will hang up as soon as the boundary of the array is exceeded. However, it hasn't told you *why*; it just stops the machine. This is enough to drive you crazy and is a real fault in Compiled CBASIC. Better you should use Modula-2, and I

NEC • PIED PIPER • TELEVIDEO • TANDON • MICROSOFT • SKS • VISICORP • HYPERION • WORDSTAR • ALTOS

COMPUTERS

Desk Top		Portable	
IBM P/C 2-320K	2195	Columbia VP	2349
IBM XT	On Sale!	Corona 1-320K	1989
Columbia 1600-1	2289	Corona 2-320K	2295
Columbia 1600-4	3494	Kaypro II	CALL
Corona 2-320K	2389	Kaypro 4	1669
Eagle 1620	3995	Teletote	1289
Eagle 1630	4995	Epson HX-20	CALL
Televideo TS-803	1949	SKS Nano	New!
Epson QX-10	ON SALE!	SKS Pico	New!
DEC Rainbow 100	CALL	NEC - All Models	Sale!
Zenith - All Models	CALL	Compaq 1 Drive	CALL
DEC Rainbow 100 Plus	CALL	Apple Compatible	CALL
Eagle IIe-1	1298	STM Pied Piper	999
Franklin DMS	CALL	Zorra 9 in.	1776

ACCESSORIES

IBM		Apple	
Supervision by CCS	679	Z-card by ALS	139
Z/Plus by CCS	699	Dual Interface (Par & Ser)	CALL
Graphics Card by Hercules	367	80 Col/64K for file	118
STB Video Board	349	PKASO card	127
Baby Blue by Microlog	459	Par Interface	59
Vista PC Master	339	Koala Touch Tablet	89
Vista Multicard 64K	269	VIP Graphics Card	116
PC Modem Plus	309	Premium SFT cd file	349
Tandon TM 100-2	235	SUP R MOD	49
CDC Disk Drive DS/DD	247	Appl. Card w/6 HZ & 64K	299
Disk Controller by Maynard	157	Disk Drive	199
Davong 5 Meg	1189	Drive Controller	59
Davong 15 Meg	1889	Disk Emulator 294K	519
Keytronic New 5150	189	Ultraterm	289
Amdek MAI	CALL	MicroModem II	269
USI Color/Graphics 1/2 Para	289	Smart Modem 1200	519
Corona-Corvus Mtn	CALL	D-CAT	149
Quadram Quadlink	469	Kraft Joystick	44
Quadram Quadboard II 64K	299	Davong 5 Meg	1359
Tecmar 1st Mate	239	Microbuffer II	209
Tecmar Expansion Chassis	769	80 Col. cd	99
MBI Monte Carlo GT 64K	289	Buf. Grappler+	CALL
		Wizard 16K	53

Printer Accessories

Sooper Spooler	289	Microbuffer (In line 32KP)	219
Microspooler (P to P 16K)	189	Microbuffer (In line 32KS)	219
Microspooler (P to P 64K)	229	64K for MB	139
Soundtrap	89	Optimizer by ACT	CALL

Terminals

Wyse 300	1019	Mann-Tally Pixy 3	689
Wyse 200	1019	Sweet-P	528
Adds - All Models	CALL	Amplot-4	719
T.V. 910+	569	Amdek X-Y	569
T.V. 925C	749	Amdek 6 Pen Auto	999
T.V. 950C	969	Amdek II Digital	1069
Qume 102A	549	C. Itoh CX (Par)	549
Qume 102G	549	C. Itoh CS (Ser)	549
Qume 108A	679	Strobe 8 Pen	799
Zenith	CALL	Houston Ins. Hi-Pad	759

Plotters

PRINTERS

Letter Quality		Dot Matrix	
NEC 3550 (IBM)	1695	C. Itoh 8510	339
Canon Ink Jet	634	C. Itoh 1550	645
JUKI 6100	489	Epson FX-80	CALL
Silver-Reed 550	669	Epson RX-80	CALL
Transtar 120	459	OKI 82A	349
Transtar 130	699	OKI 83A	589
Transtar 140	1089	OKI 80	319
NEC 2010	859	OKI 92A	449
NEC 2015	859	OKI 93	739
NEC 2050 (IBM)	CALL	Riteman	369
F-10 Starwriter	1099	Gemini Delta 10	549
F-10 Printmaster	1349	Toshiba P1350	CALL
S/C TP2	CALL	NEC 8023	389
HR-1	659	NEC 8025	699
HR-15	On Sale!	IDS Prism 80	Sale!
Diablo 630	CALL	IDS Prism 132	1165
Daisywriter 48K	1099	Mann-Tally 160L	619
DTC 380-Z	1049	Mann-Tally 140L	849
Brother HR-25	NEW!	Transtar 315	CALL

MONITORS

Color		Monochrome	
Princeton HX-12	469	Taxan Amber	129
Amdek II+	427	Taxan Green	129
Amdek I	269	Zenith 122A	125
NEC JC1203 (IBM)	519	Zenith 1236	97
Taxan RGB-3	489	Amdek 310A	169
Quadram Quadchrome	609	Amdek 300	159
Zenith - NEW	CALL	NEC 1201	157

SOFTWARE

IBM		Apple	
Zork I	27	Tax Preparer	147
Millionaire	39	Home Accountant	49
Wizardry	39	Great Plains	CALL
Wordstar	269	Peacree	CALL
Easywriter II	259	PFS: Solutions	CALL
Volkswriter	119	PFS: File	84
Viscalc (256K)	179	PFS: Report	84
Multiplan	189	PRS: Graph	84
1-2-3	329	dBase II	397
PFS: Graph	93	Visifile	169
PFS: File	93	Versaform	264
PFS: Report	83	T.J.M.	CALL
PFS: Squibbons	CALL	List Handler	59
dBase II	397	Word Handler	139
Visifile	209	Wordstar	249
Tax Preparer	169	Bank Street Writer	47
Versa Form	265	Screenwriter II	CALL
Infostar	319	Magic Window	97
Personal Pearl	199	Magic Calc	99
Home Acct Plus	112	Zork 1	27
Peacree	CALL	Zaxxon	27
Property Management	329	Chopflipper	26
Digital Research	CALL	Frogger	24
Visi-On	NEW!	Wizardry	39
Megawriter	69	Jumpman	29

COMPUTERS



TO ORDER: Phone orders invited using Visa, MasterCard, or bank wire transfers. Visa, MC, service charge of 2%. Mail orders may send charge card number (include expiration date), cashiers check, money order, or personal check (allow 10 business days for personal or company checks to clear). Please add 3% (\$5.00 minimum) for UPS shipping, handling, and insurance. All equipment is in factory cartons with manufacturer warranty. Opened products not returnable. Restocking fee for returned merchandise. Equipment subject to price change and availability. Retail prices differ from mail order prices. Calif. residents add 6% State Tax. Company and school P.O.s accepted on approval. IBM & Apple are registered trademarks.

and More

The Catalog Challengers!

3620 - 30th Street
SAN DIEGO, CA 92104

TO ORDER
(619) 291-1442

• TRANSTAR • QUADRAM • DAVONG • CORVUS •

intend to convert all my programs from CB-80 to Modula-2 as soon as possible.

JRT Pascal Yet Again

[**Editor's Note:** *Alas. At press time, BYTE was notified that JRT Systems (45 Camino Alto, Mill Valley, CA 94941) had filed for chapter 11 bankruptcy on November 18, 1983. This is not a complete liquidation, but a "re-organization." We thought the JRT delivery-problem saga had come to a conclusion in the April 1983 BYTE (see "Open Correspondence on JRT Pascal," Letters, page 18). Shortly thereafter, the number of complaints began to slow down—but scattered grousing continued. In any event, the slow delivery of the \$29.95 software deal of the century most likely will be slowed down even more.*]

I'm getting weary of the accusation that I've said bad things about JRT Pascal because the BYTE advertising staff pressures me on behalf of publishers who charge a great deal more than JRT's \$29.95.

For the record: I have *never* heard one word from the BYTE advertising staff suggesting that I make any modifications in my column whatever, and the only time the editorial staff asked me to change something was because they feared a lawsuit. On that one occasion, I modified one sentence, and even then I retained the substance of my remarks, changing only the tone. Blame me for my columns, or blast me for my opinions, but do not accuse me of petty cowardice.

I reviewed one of the 2.x versions of JRT Pascal, and I was not impressed. Since then I have received many letters from users concerning version 3.0, and the consensus is that if you can *get* version 3.0 you will like it.

Flat statement: JRT Pascal version 3.0 is a bargain at \$29.95. Qualifications: it's a bargain in comparison to a lot of stuff on the market, and its value depends in good part on what you intend to do with it. If what you want is a fast-compiling nonstandard p-code language that works quite well and has no more anomalies than languages selling for 10 times the price, by all means send in your \$29.95. You must then be prepared to wait, but the odds are reasonable that

you'll eventually get more than your money's worth.

Indeed, as a language for writing real programs intended for the CP/M 2.x operating system, JRT Pascal is considerably better than "real" Pascal. If I had to write a number of reasonably sized programs, and I intended to stay with the CP/M 2.x operating system and not transfer the programs to anything else, I might well choose JRT Pascal as the language to write them in.

If I wanted to get some idea of the flavor of Pascal, and I didn't want to spend much money, I'd *certainly* get JRT Pascal 3.0.

JRT Pascal 3.0 has fixed most—not all, but most—of the bugs that plagued the earlier versions. As a programming language, it's comparable to Sorcim's Pascal/M in both ease of use and speed of compilation. The execution speed is comparable to any other p-code (intermediate code) Pascal, including UCSD Pascal. Like Pascal/M (but unlike UCSD Pascal), there's no integration of editor and compiler, but of the three, I'd about as soon use JRT Pascal as either of the others for production work.

The bugs that are left are, according to my correspondents, fairly harmless or very subtle. Since the professor who (in a letter praising JRT Pascal) spoke of the "subtle" bugs didn't tell me what they were, I can only guess at what he meant. One bug I found was a failure to compile a program because it had the following line:

```
{a comment} (*another comment*)
```

which was intended to illustrate the principle that you could use either kind of comment marker in a Pascal program. Standard Pascal (including both Pascal/M and Pascal/MT+) will compile that, since standard Pascal doesn't recognize physical lines.

There are other nonstandard features to JRT Pascal. For example, in the case above, the compiler didn't even attempt to work on the program; it simply told me there was an "unclosed comment." That is *not* a standard Pascal error message.

Another JRT problem can be

caused by multilayered procedure nesting and indirect recursion. Most users won't find this a problem.

JRT Pascal does not format numbers in the same way as either Pascal/M or Pascal/MT+ (which don't format them the same way either). Thus, the same program will have a different output depending on which compiler you use.

I deliberately took out some semicolons in a JRT 3.0 program. The compiler dutifully reported "' expected". Alas, the *standard* Pascal error messages are "Error #6 Illegal symbol (possibly missing ";" on line above)" and "Error #14 ';' expected (possibly on line above)." Perhaps the JRT error reporting system is *better* than Niklaus Wirth's, but it isn't the same.

JRT is worth playing with. It's cheap for the compiler alone, and you get a bunch of useful utilities with it. As I've said many times, I like the price, and I wish other publishers would drop their prices to something reasonable. JRT has a lot of satisfied users. Indeed, it may in many ways be more useful than "real" Pascal. However, that doesn't make JRT into standard Pascal.

In addition, JRT Systems got far more orders than it was geared up to fill. I have lots of letters from readers who ordered JRT Pascal and received nothing, neither software nor acknowledgment of order, for months. Sarah Smith, of Lisp Machine Inc., sent in an order in December, had the check cashed in January, got an acknowledgment of order in March, had them refuse to check the order in May, complained in June, and in August received a form letter stating that it couldn't find the order and wanted a copy of canceled check or bank-card bill. (The form letter offered to refund the money once proof of payment was furnished.)

Ms. Smith, like me, is a professional; the time it would take to get a copy of canceled check or bank-card bill would chop pretty deeply into the bargain value of JRT Pascal.

Thus, fair warning: JRT Pascal 3.0 works and has enthusiasts I respect. The manual is well written, and there

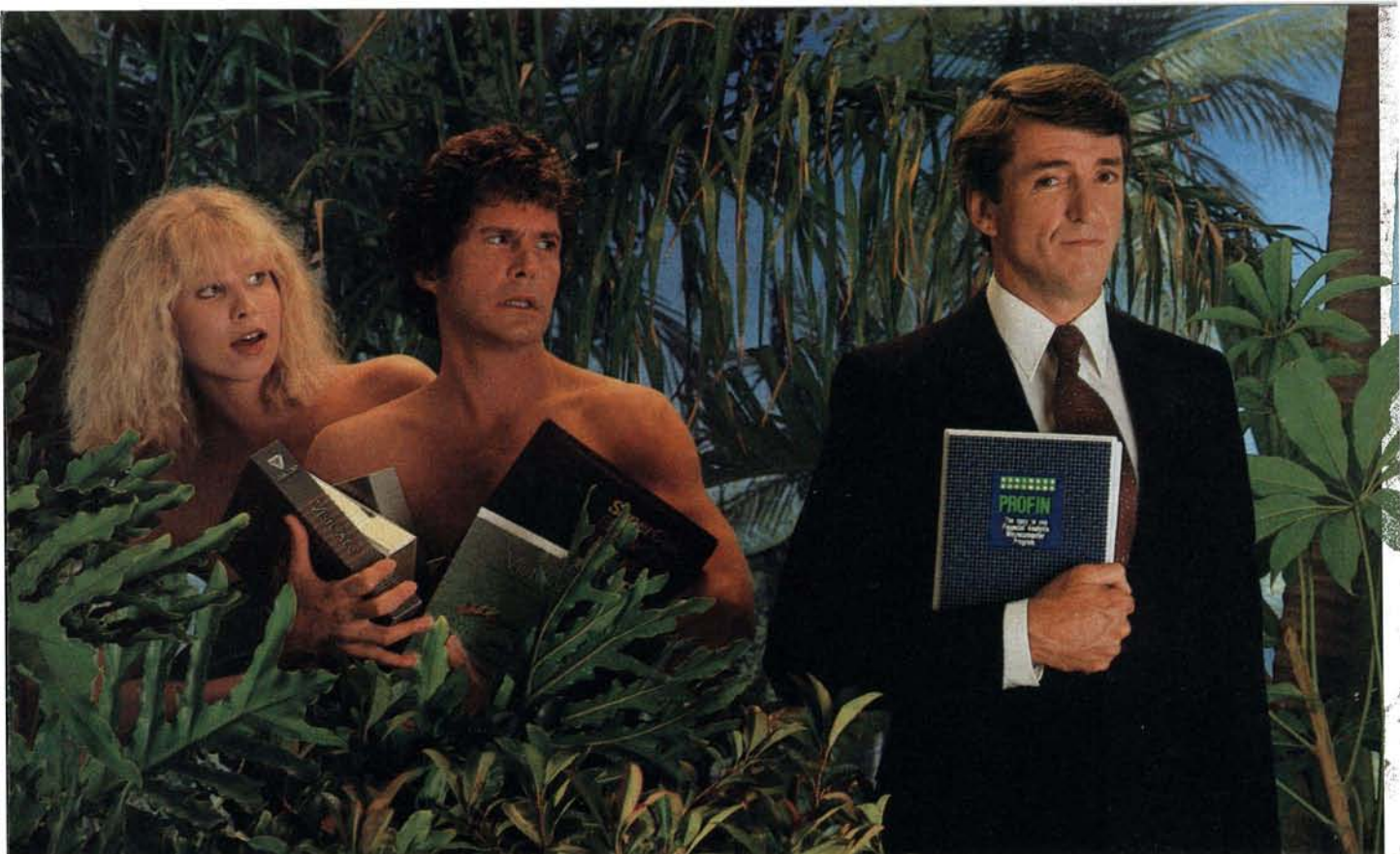

IN THE BEGINNING THERE WERE SPREADSHEETS... NOW PROFIN™ GOES BEYOND.

If you're a very busy person wondering why it should take hours to set up the mathematical calculations for financial analysis on a microcomputer, the answer is it shouldn't.

If you think there should be some way to see income statements, interest schedules, capital expenditure reports, tax schedules, return on equity, discounted cashflow, and balance sheets without spending days laying out a spreadsheet, you're right — there should.

In fact, there is! It's Profin.™

MATCHING THE TOOL TO THE JOB.

From now on, using a universal spreadsheet to do the highly specific work of financial analysis will be considered just fun for hobbyists.

But, if you're a business person with little computer experience and even less spare time, you can quickly and easily use Profin to figure forecasts and budgets, return on equity, discounted cashflows, net present values, capital expenditure, interest calculations, depreciation comparisons and taxation scheduling — with the reports laid out for you automatically.

FINANCIAL REPORTS IN MINUTES.

Because Profin is menu-driven, you simply answer a series of questions. You can complete your analysis

Circle 48 for Dealer Inquiries. Circle 49 for End-User Inquiries.

in 30 minutes, or change prices, costs, inflation rates, interest rates, capital costs, and foreign exchange rates, then immediately see revised reports.

In the beginning, spreadsheets were great. At least, they were all we had. Now there's more, with the specialized tool for a specialized job: Profin.

Available under \$300 for CP/M-80, MS-DOS, and IBM PC-DOS from your local retailer or from most distributors.

Also available: Planfin.™ For sales, marketing and other executives who just want simple forecasts and budgets without detailed capital and loan analysis, Planfin gives you operating income statements plus net income and discounted cashflow reports in less than 15 minutes. Under \$200.

**BUSINESS™
SOFTWARE**

Please send me more information about how Profin and Planfin beat the spreadsheets for budgets and forecasts.

Name _____

Address _____

City/State/Zip _____

Computer Brand Owned or Planned to Buy _____

Mail to: Business Software, Inc.

12021 Wilshire Blvd. #194

Los Angeles, CA 90025

are a lot of goodies that come with the program. However, if you order the program and don't get delivery, do *not* complain to BYTE or to me. Just be patient, and keep trying. Eventually you'll get satisfaction. At least you can continue to hope so.

I've heard that Mr. Tyson of JRT Systems is working on a Modula-2 compiler. I wish him well at it, but I do hope he'll pay more attention to the language standards than he did with his Pascal.

[Late addition: Borland's Turbo Pascal, for \$49.95, is standard, produces native code (rather than p-code), and has a built-in editor. More next month, but it looks pretty good.]

BDS C

BDS C is a healthy subset of the C programming language. It uses some nonstandard library implementations; in that sense, it has some similarities to JRT Pascal.

The remarkable thing about BDS C was that it could be done at all; before Leor Zolman wrote his compiler,

there was no C language for the 8085 or Z80 machines; at least, nothing that compiled in reasonable time and had most of the features of real C. Once Zolman showed that it could be done, a number of other outfits got into the act.

Zolman has a new version, 1.5a, of his C compiler. This one works only

**BDS C's major
advantage is that it
compiles faster than
any other 8-bit C
compiler and finds
most trivial errors in
seconds.**

with CP/M 2.x; anyone still running CP/M 1.4 can't use it.

There is an improved floating-point package. Source code for most library routines is provided. The documents have been somewhat improved, but fair warning: the BDS C documents are not an introduction to the C

language. You'll need both Kernighan and Ritchie (*The C Programming Language*) and some other good introductory book if you don't know how to use C.

There's a good index and a fair but improvable table of contents. The instructions for using BDS C, assuming you know something about programming in the C language, are clear.

BDS C's major advantage is that it compiles *fast*; faster than any other 8-bit C compiler. Furthermore, it finds most trivial errors in seconds. It's not the lowest-priced C compiler on the market, since Q/C is \$99. At \$130 postpaid (from Workman and Associates), though, it's still a bargain.

In addition, there's a debugger, a library manager, and other goodies. There's a good overlay or "swapping" system so that you can write and run really big programs in BDS C. BDS C purchasers are encouraged to join the BDS C User's Group; the User's Group distributes a lot of interesting



GRAPHICS-PLUS is a field installable enhancement board for the popular Zenith¹ Z19 video terminal adding many powerful features found only on terminals costing much more. GRAPHICS-PLUS provides Tektronix² 4010 compatible vector drawing graphics, VT100³ compatible 80 and 132 column display formats, off-screen scrolling memory, programmable function keys, "Plain English" menu-driven Set-up mode, and a host of other enhancements. Installation can be accomplished within 15 minutes using only a screwdriver.

GRAPHICS-PLUS an enhancement For Z19 Terminals from Northwest Digital Systems

- Tektronix² 4010 Compatible Graphics
- 512 Horiz by 250 Vert Resolution
- 80/132 Col and 24/49 Line Text Displays
- Seven Page Off-Screen Text Memory
- Menu-driven "Plain English" Set-up Mode
- 16 Programmable Keys- 128 Chars Each
- Optional Hardcopy Port
- Simple Field Installation

1 TM Zenith
2 TM Tektronix
3 TM DEC

GP-19 Upgrade for Z19 Terminal	\$ 849
Z19 Terminal With GP-19 Installed	\$ 1495

Northwest Digital Systems

P.O. Box 15288, Seattle, WA 98115 (206) 362-6937

Score another first for ACE.



A lot of people who've never heard of ACE's impressive record of firsts in multiprocessing are about to sit up and take notice. Why?

It's our latest wonder: Multiprocessor CP/M Plus*.

ACE has developed a linkup between its powerful multiuser microcomputer, the Discovery, and the fastest and most powerful version of CP/M* ever marketed.

The result is a multiprocessor that does more than just emulate CP/M or rely on a lesser operating system that's "CP/M compatible." It actually delivers pure CP/M (either CP/M-86* or CP/M Plus) to any of Discovery's up to 16 on-line users.

With easy command line editing, quick file accessing through user-defined automatic search paths and comprehensive "help menus," CP/M Plus is as friendly as they come — and with big performance extras.

Like large files, directory hashing, data buffering, time and date stamping, and an extensive utility set that can accept English words.

All of which means that ACE's linkup with CP/M Plus will continue to give Discovery owners access to the largest selection of applications software in the world for years to come.

That's something to think about. Because who wants a multiuser system that's friendly and powerful today but unfriendly tomorrow when new software using CP/M

Multiprocessor CP/M Plus.™

Plus features hits the scene?

Our latest triumph is just one of a line of firsts.

ACE pioneered multiprocessing for microcomputers back in 1979 when we introduced a Discovery featuring what was then the revolutionary concept of dedicating a CPU to each on-line user.

Two years later, we moved further ahead of the pack with our next singular feat: the first user-processor on a single board, the dpc-180*. Everything was there: memory, CPU, serial I/O.

Nice.

Which made our 1982 breakthrough — the amazing 16-bit dpc-186*, mated with CP/M-86 — seem like business-as-usual to us even though it caught the competition flat-footed.

With room to grow from 128K to 1MB of expansion memory, and designed for systems also using our 8-bit board, this breakthrough let individual users tap into either 8- or 16-bit computing power with one

central Discovery unit.

And because each Discovery system is controlled by our own dpc/os*, tried and proven in more than 10,000 Discovery and OEM installations around the world, any user on line can take advantage of interprocessor communication, file and record locking, fully managed multiple printers, private directories, plus many other features.

So what little wonder does ACE have up its sleeve now? Stay tuned. Because soon you'll hear the news about our Concurrent CP/M-86*, which will give the owners of our Discovery all the benefits of 16-bit computing power, CP/M's comprehensive software selection, and efficient multi-tasking capabilities. So each user can get several projects underway with a few quick taps on the keyboard.

Meanwhile, it'll be business as usual for ACE, keeping ahead of the crowd while turning out the best multiuser multiprocessor micro on the market, backed by one of the best nationwide service networks you could hope for.

So if you're a computer dealer, distributor, or systems house who wants to join the group that scores high with a multitude of users, just give us a call at **(800) 821-6596**. (In California, it's **(213) 351-5451**.)

And do us a small favor. Tell us you've heard of us.



ACTION COMPUTER ENTERPRISE
The Multiprocessing Company.

Action Computer Enterprise, Inc. (Corporate Headquarters): 430 No. Halstead St., Pasadena, CA 91107. TWX 910-588-1201 ACTION PSD
ACE/Europe: Boschdijk 189, Box 1275, 5602 BG, Eindhoven, Netherlands, Tel. 040-452658, Telex 51767 ACE ENL ACE/Asia, G/Floor Lee Wah Mansion, 171-177 Hollywood Rd, Hong Kong.
Tel. 5-441692 or 5-442310, Telex 75332 PACIC HX Canada: Future Electronics, Inc., 237 Hymus Blvd., Pt. Claire, Quebec H9R5C7, Canada, Tel. (514) 694-7710, Telex 05-823554.

*CP/M Plus, CP/M, CP/M-86, and Concurrent CP/M-86 are either trademarks or registered trademarks of Digital Research, Inc. / *dpc-180 and dpc / os are registered trademarks of Action Computer Enterprise, Inc.
Serviced nationwide by Bell & Howell Company

PC PEACOCK™

Brings Living Color to Your IBM PC™

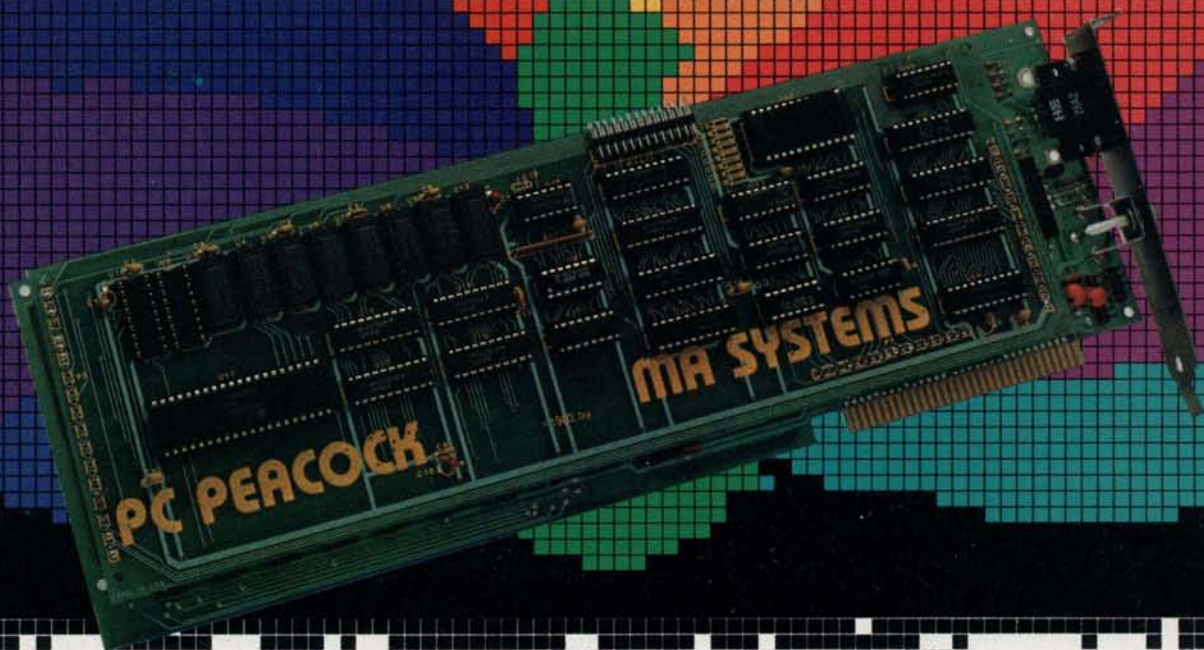

Computing is dull in black and white. But it doesn't have to be.

PC PEACOCK brings the excitement of color to your IBM computer. Pictures, charts and graphs "come alive" in multicolor brilliance. PC PEACOCK works with all color and composite monochrome displays to produce crisp, detailed images.

You'll see your favorite programs in the splendor of color. PC PEACOCK is fully compatible with all software for your IBM PC — including the wide variety of graphics programs. The medium multicolor mode and high resolution monochrome mode enhance your display capabilities for business, home and education.

And PC PEACOCK is convenient. Its parallel port allows you to connect a printer to your computer without wasting an additional expansion slot. Connections for all displays (RGB, composite, monochrome and televisions) are included.

PC PEACOCK is designed to provide years of worry free performance and is backed with an outstanding TWO YEAR warranty.

So bring living color to your IBM PC, with the PC PEACOCK Color Graphics Adapter. PC PEACOCK is available now at your local IBM dealer.

For more information on all of MA System's IBM and Apple products, please call or write.

MA SYSTEMS
INCORPORATED

2015 O'Toole Ave., San Jose, CA 95131 (408) 943-0596

Circle 231 on inquiry card.

IBM PC is a trademark of
International Business Machines Corp.

PC PEACOCK is a trademark of MA Systems, Inc.

programs and utilities.

All in all, BDS C is a reasonably priced way to get involved with the C programming language, or even to find out whether you really want to learn it. In my view, C is more useful on 16-bit machines, and I'm on record as saying I think Modula-2 is a more interesting language. On the other hand, a lot of people don't agree with me. You can certainly write some useful programs in BDS C; one of the most useful programs I own is a text comparator that one of Leor's friends wrote for me.

Once More, the Epson

When the Epson QX-10 computer first came out, the company was still evolving both hardware and software. I had a very early model, shipped long before Epson began selling the machines, and there was always some question of whether my system was truly integrated, especially when I had some real problems with the Valdoks software that comes with it.

The people at Epson couldn't have been nicer about it. The other day they sent out a systems-programming manager, who brought a new machine straight out of stock. We swapped.

I also have the new Valdoks software, version 1.18, which has a number of new features and is also considerably faster than the old Valdoks.

Alas, it doesn't have all the promised features of Valdoks, and apparently it retains some undocumented features as well. Moreover, although the new Valdoks is fast, it's not fast enough for me, my wife, or my assistant. In particular, it is *not* designed to be used as a substitute for an office machine. It simply takes too darned long to get a business letter out using Valdoks. Just getting the envelope addressed can take a full minute or longer.

Moreover, the FX-80 printer that came with the Epson QX-10 is not designed for use with letterhead or other single-sheet-feed paper. If you use a Micro Peripherals Printmate 99 printer with the Epson, that will solve one of the problems, but the

Valdoks software doesn't know how to make use of the 99's best features, so that's not so useful either.

Valdoks might not be so bad if you use only tractor-feed paper, no letterhead, and you're mostly writing documents, not letters. It does have some good features, although you'd better get used to being patient.

We're at the moment installing Write on the Epson QX-10; we'll have versions for both the Valdoks and the regular Teletype-layout keyboards. Write will, of course, run under CP/M, not TPM and the Valdoks software, and it won't have all the cross-index features and other nifty conceptions Valdoks attempts. Our present version of Write probably won't be able to take advantage of the bit-mapped screen and other goodies that the QX-10 hardware features. We'll see.

Meanwhile, my opinion of the QX-10 remains: the hardware is fine, and if Epson ever gets software worthy of it, it will have a nice little machine. On the other hand, does the industry need yet another Z80 computer for more than \$2500, especially if there's no software to take advantage of the unique hardware features of the QX-10? If Epson had released the QX-10 with appropriate software a year ago, it would have been competitive; I don't think it is now.

I've also seen no reason to change my opinion about Valdoks: noble idea, but too ambitious for the machine. To get all the features Valdoks offers, you need both a bit-mapped screen (which the QX-10 has) and a fast 16-bit or larger CPU (which the QX-10 doesn't have). I've a great deal of admiration for what was accomplished with Valdoks, but I cannot in good conscience recommend it to anyone who has actual production work to perform. It's just too darned slow.

There's one more difficulty.

Valdoks is slow in large part because Epson wanted it to be user-friendly; but alas, this wasn't even managed completely. If you get disk errors, Valdoks can report things like

Error 01 Disk B Retry Y/N?

Less for Your Money

If you do word processing on your personal computer, you probably know that there are many programs for sale to help you with your spelling. But the biggest spelling error you'll ever make is paying too much for your spelling correction software. The Random House ProofReader gives you less for your money — less trouble, that is, and fewer spelling errors. The Random House ProofReader is based on the world famous Random House Dictionary. It contains up to 80,000 words, depending on your disk capacity. You can add new words with the touch of a key. It shows you the error and the sentence it's in. It instantly suggests corrections. It even re-checks your corrections. And it costs half as much as other programs with far less power. The Random House ProofReader is compatible with all CP/M 2.2[®], MS-DOS[®] and IBM Personal Computer[®] systems.

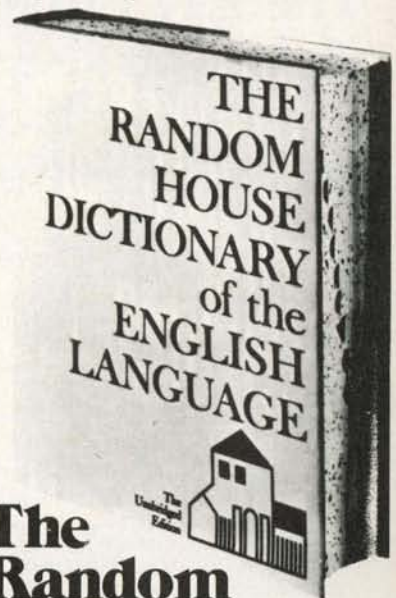

The Random House ProofReader \$50

For orders or information, see your local dealer or call 505-281-3371. Master card and VISA accepted. Or write Random House ProofReader, Box 339-B, Tijeras, NM 87059. Please enclose \$50 and specify your computer model, disk size and memory.

Random House and the House design are registered trademarks of Random House, Inc. CP/M is a registered trademark of Digital Research, Inc. IBM and IBM Personal Computer are registered trademarks of International Business Machines, Inc. MS-DOS is a registered trademark of Microsoft, Inc.

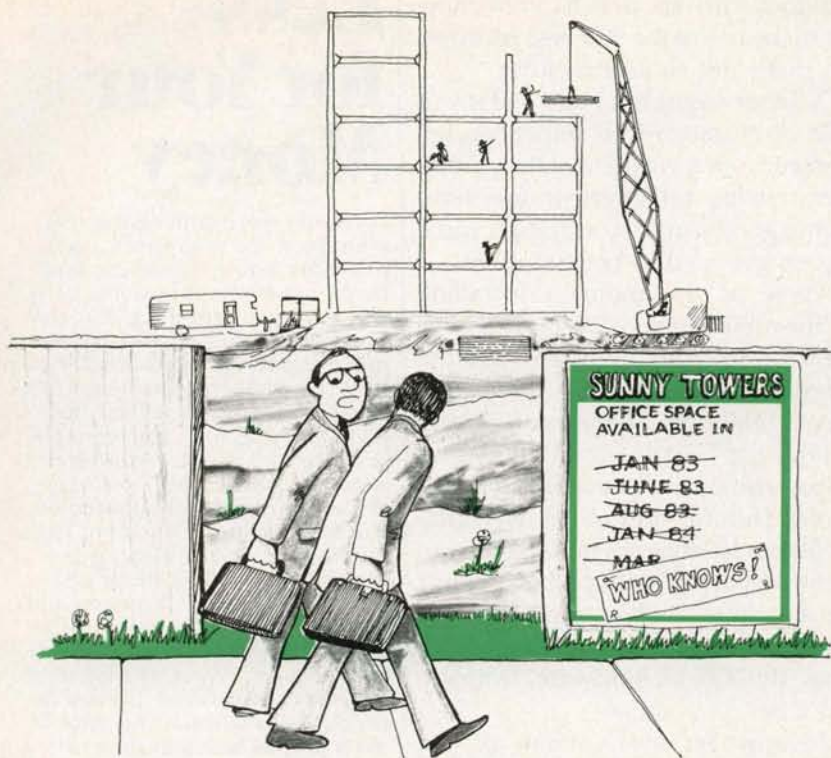

"They're obviously not using the ETI Project Control System"

The ETI Project Control System Helps you keep All the pieces and people In Place, On Time and Within Budget

The ETI Project Control System is a visual project management tool. It allows the user to divide large, complex projects into individual tasks and operations.

Based on the proven CPM and PERT methodologies, the ETI Project Control System is available now and easy to use.

Compatible with IBM Personal Computers*, it offers uncluttered displays, extensive user flexibility and a suggested **\$295.**** retail price of only

With a few keystrokes, the ETI Project Control System user can draw a task chart to fit nearly any project. Each task may include name, duration, capital cost, labor cost, overhead cost, person(s) responsible, manpower requirements or manpower mix, amount completed, starting and ending dates (including early and late dates) and a narrative description.

In addition to the task chart, which graphically shows task relationships and sequence, the ETI Project Control System features several management aiding displays. There are schedule charts that show the critical path, scope and complexity of the project. There are also personal schedules for individuals or equipment, assignment lists and charts that show either budgeted or actual costs.

A change made in one chart is simultaneously made in all the charts. This feature can quickly and graphically show the schedule implications of any change in the project plan.

The ETI Project Control System puts the user in control. The information entered is not subject to any pre-set program of analysis. The user decides what variables are important and chooses the level of detail.

Better understanding and control of complex projects is only one result of using the ETI Project Control System. It can also help find schedule threats and test alternatives, or seek the best cost/time tradeoffs. As a communications tool, the Project Control System can be of great benefit. All displays are "what you see is what you get." Data developed and collected with the program can be printed and circulated in the same form as displayed on the screen.

The ETI Project Control System can help make you a better manager. Circle our reply number for more information.

ETI PROJECT CONTROL SYSTEM

ETI • 5848 EXECUTIVE DRIVE
LANSING, MI 48910 • (517) 887-2480

*Requires IBM Personal Computer 128K of RAM, monochrome display, one disk drive, PC-DOS. IBM and PC-DOS are trademarks of International Business Machines.

**Includes program diskette and User Manual. Price subject to change without notice.

and if you hold down the "Y" key very long, it will give the same message a number of times, since Valdocs features a large type-ahead buffer.

You can also get "Error FF" and other such cryptic messages. Now agreed: that's no more mysterious than the infamous "BDOS Error on B: Bad Sector" or such like; but it's certainly no less frightening to the naive user, and if you learn CP/M's error messages you've learned something about CP/M and other small machines. Learning what "Error FF" is teaches you nothing but Valdocs.

Conclusion: if you want yet another Z80 CP/M machine, the QX-10 will do, but there are probably better deals pricewise. The unique features of the QX-10 are implemented only in Valdocs, but alas, that's so slow that despite my encouraging him to use a computer (he has an Osborne at home), my editorial assistant prefers a Selectric typewriter for just getting the work done here.

I like the bit-mapped screen, which lets boldface words appear on the screen in boldface (as well as on the output copy), and I like a lot of the other features of the QX-10; if Epson ever gets software worthy of the machine, it'll have something really great.

As of October 1983, it doesn't.

Rana

If this were a news column, this item would have to be the lead. Alas, by the time you read this in January others will have printed it first.

Not long ago I went out to Rana, an outfit that makes really advanced disk drives for popular machines like the Apple and the Atari. I brought home some of the drives, which we installed on our Apple and Atari machines, and waited for the boys to report, since those are their machines and they're out in back where I don't see them often.

Their report is wild enthusiasm. Don't get standard Apple drives. Get Rana's package, which includes a new disk-controller card and a whole

MicroAge[®]

**"THEIR ENTHUSIASM ABOUT OUR GROWTH
IN ALASKA WAS CONTAGIOUS...IN LESS
THAN TWO YEARS WE'VE EXPANDED INTO
FOUR COMPUTER STORES!"**

"MicroAge's enthusiasm was catching! The same can do energy that started MicroAge during the pioneering days of microcomputing is now a matter of company policy."

"Plus, MicroAge helped us get key product lines for Alaska!"

"We're believers in MicroAge. Their industry knowledge and insight into recent product developments has given us the flexibility to think and react before our competition does. We started with 4 people in a single store in 1981...now we have 4 stores and 26 people."

"At MicroAge, they speak our language...success!"



Jay Wisthoff
MicroAge Franchisee

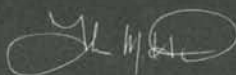

Tom Hunter
MicroAge Franchisee

To build your own professional computer sales organization with MicroAge, write to:

MicroAge[®]
COMPUTER STORES
"The Solution Store"[®]

1457 West Alameda • Tempe, Arizona 85282
(602) 968-3168

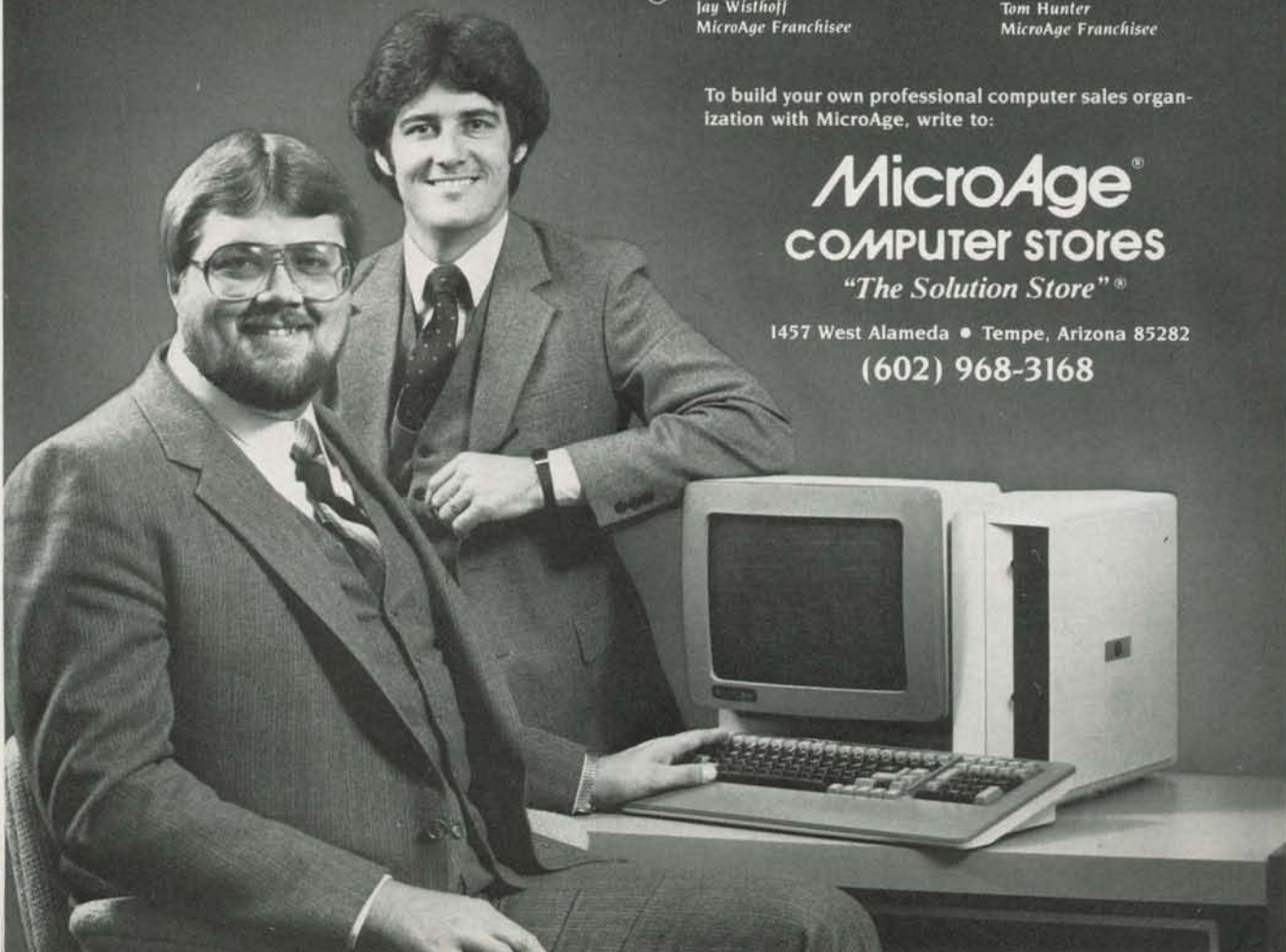

MicroAge franchisees Jay Wisthoff and Tom Hunter shown with Televideo products.

Circle 243 on inquiry card.

Items Reviewed

CB-80	\$500	Rana Disk Drives	Elite 1 (Apple) \$379
CB-86	\$600	Rana Systems	1000 (Atari) \$449
Digital Research		21300 Superior St.	
POB 579		Chatsworth, CA 91311	
Pacific Grove, CA 93950		(213) 709-5484	
(408) 649-3896			
Eagle 1600	1620 \$4495	Repton	\$39.95
Eagle Computer Company	1630 \$6995	Spider City	\$39.95
983 University Ave.	1640 \$8995	Sirius Software Inc.	
Los Gatos, CA 95030		10364 Rockingham Dr.	
(408) 395-5005		Sacramento, CA 95827	
		(916) 366-1195	
Epson QX-10	\$2995	Slicer Computer	\$1075
Epson America		Slicer Controls/Computer	
23155 Kashiwa Court		2543 Marshall St. NE	
Torrance, CA 90505		Minneapolis, MN 55418	
(213) 534-0360		(612) 788-9481	
Janus/Ada D-Pak	8080 \$500	Sweet-P Plotter	\$795
RR Software	8086 \$700	Enter Computer	
POB 1512		6867 Nancy Ridge Dr.	
Madison, WI 53701		San Diego, CA 92121	
(608) 244-6436		(619) 450-0601	
JRT Pascal	\$29.95	Write	\$239
JRT Systems		Minimum Data Base	\$49.50
45 Camino Alto		BDS C	\$130
Mill Valley, CA 94941		Workman and Associates	
(415) 388-0530		112 Marion Ave.	
Turbo Pascal	\$49.95	Pasadena, CA 91106	
Borland International		(213) 796-4401	
4807 Scotts Valley Dr.			
Scotts Valley, CA 95066			
(408) 438-8400			

bunch of stuff. It all works faster than standard Apple, with fewer loading errors. It works with the Applicard CP/M converter card, too.

We never had any other disk drive for the Atari, but I can testify that the Rana Atari drive works flawlessly on our Atari 800, loading Repton and Tank Attack and other games (on which more another time) and reporting all kinds of information that the Atari standard drives don't.

However, I'd have waited for a less

exciting month to write all that, disk drives for my popular computers not being my major area of interest, if the Rana people hadn't showed me what they're up to out there, which is no less than the demise of the hard disk.

Rana will very shortly sell you a 5¼-inch floppy disk that holds 2.5 megabytes formatted.

That's a lot. Syquest will for \$90 or so sell you a "hard-disk cartridge" system that holds 5 megabytes. Rana's system requires preformatted

disks, but the disks will sell for \$15 at first, less later, so that expense is hardly a problem.

The Rana system puts "burst tones" on either side of the data tracks on the disk. These tell the disk head precisely where the track is, meaning the track can be narrower, and the tracks can be closer together, so that distortions of the media won't give you bad sector errors. If you want to know more about the technology, read something

ONLY **SYSTAT**TM HAS THE POWER, SPEED, AND ACCURACY OF MAINFRAME STATISTICS PACKAGES.

MS-DOSTM, PC-DOSTM, CP/MTM, UNIXTM

SYSTAT, INC. 1127 ASBURY AVENUE

INTRODUCTORY PRICE \$399

EVANSTON, IL 60202

(312) 869-7282

How Sweet it is!

only
\$1995⁰⁰

"What a feeling!" That's just how you'll feel knowing you've purchased an IBM-compatible Personal Computer with full color graphics capability at a price far, far below anyone else. Not only does the Handwell PC outperform everyone in price, but it comes loaded with standard features that some competitors don't even offer as options. Due to its eight expansion slots, you'll be able to upgrade your Handwell PC with many add-ons and options today and tomorrow, thus making it obsolescence-proof. When buying the Handwell PC, you will be able to take advantage of the enormous, off-the-shelf software library written for the IBM PC — thus accessing some of the finest user-friendly software available. All-in-all, the Handwell can, by combining quality, performance and unbelievable price, offer you a truly high-performance PC at substantial savings. So, stop and smell the roses along the way and see how sweet it is!

Monitor not included in price shown

Simulated Display



... a new breed of personal computer



STANDARD FEATURES: • Full Graphics capabilities (640 dots x 200 lines) • 128K Ram (expandable to 256K) • Two RS232 Serial Ports • One parallel printer port • Color Display Card • Fully detachable, IBM-compatible Keyboard • 8 Expansion Slots • One 5¼-inch Floppy Drive (327Kb-formatted) • MS-DOS Operating System (MS-DOS 2.0 and CP/M compatible) • 8088 Processor • Spooler (part of system memory, can be used as a printer buffer) • Real Time Clock and Calendar

 **Handwellcorp.**

4962 El Camino Real
Los Altos, CA 94022
415 962-9265

*IBM is a registered trademark of International Business Machines
*CP/M is a registered trademark of Digital Research, Inc.
*MS-DOS is a registered trademark of MicroSoft, Inc.

Dealer and OEM inquiries invited
For further information call
800-821-3628

technical; I'm more interested in the implications.

RAM disk, i.e., a way to fool your system into thinking a lot of memory is a disk drive, is becoming standard on most advanced systems like Sage and Compupro and will be standard on all systems in a few years. Pion's Interstellar Drive and Semidisk already offer ways to put battery backup on your RAM disk, making it pretty secure; once again, that will be standard one of these days.

With a megabyte of RAM disk and

floppy disks holding 2.5 megabytes, many of the advantages of Winchester hard disks simply go away. After all, hard disks are not as reliable as floppies. They are subject to problems when there are extreme humidity variations. They don't like shock and vibration. They have to be "backed up," which is to say you want copies of what's on them, and that takes time and has to be done. Their major advantages are speed and lots of storage.

I don't make it as a flat prediction,

but I do put it as a subject for thought. Given lots of RAM disk, and 2.5-megabyte floppies, is there really a need for hard disks at all? However that develops, Rana is a company worth watching.

Time Eaters . . .

I'm not very good at arcade games. My timing just isn't that good. Consequently, I prefer games of strategy to joystick shoot-the-enemy games.

My boys, however, have different preferences. The other day an enormous package of Atari games arrived from Sirius, and since then we've had trouble getting them to come in for dinner. There's no room to report on all of them; I'll get to them next month.

Meanwhile, my own favorite is the Atari version of Repton. I didn't much care for that one on the Apple, but I find myself wasting more time than I should on the Atari version. There's also Spider City, which is mostly shoot-'em-up but does have some strategic decisions involved.

My all-time favorite, though, is still Epyx's Crush, Crumble, and Chomp. There's something exceedingly attractive about burning down and stomping the Pentagon flat, and in general making an even bigger mess of Washington than the politicians have. . . .

Sigh

My notebook contains six or eight other items I ought to have got to, but I'm out of space. I'm also out of time, since I've got another speech to give tomorrow and my plane leaves in an hour.

I love this world of little machines, but it can wear you thin. ■

Jerry Pournelle welcomes readers' comments and opinions. Send a self-addressed, stamped envelope to Jerry Pournelle, c/o BYTE Publications, POB 372, Hancock, NH 03449. Please put your address on the letter as well as on the envelope. Due to the high volume of letters, Jerry cannot guarantee a personal reply.

Jerry Pournelle is a former aerospace engineer and current science-fiction writer who loves to play with computers.

Professional Graphics at Practical Prices

Add our Imaginator™ graphics upgrade card to your H/Z-19 terminal or H/Z-89 computer. It's quick and easy. You gain intelligent, highly efficient graphic display capabilities proven in countless Heath/Zenith terminal and computer updates.

Check Imaginator's special features:

- High resolution 504 x 247
- Accessible through any high level language FORTRAN, Pascal, BASIC, etc.
- Onboard microcomputer eliminates processing load on host
- Source code available
- Rich graphics instruction set
- Mix text and graphics
- Tektronix® 4010-4014 compatibility option with GIN mode
- Comprehensive documentation includes numerous examples
- Fully buffered for asynchronous operation
- All original H/Z features remain intact

Now check Imaginator's low cost:

- Assembled complete \$445.
- Kits from \$215.

Also ask us about our Imaginator 2 upgrade for H/Z-29 terminals.

Call or write us today for additional information.

**CLEVELAND
CODONICS, INC.**

18001 Englewood • Cleveland, OH 44130 (216) 243-1198

Your H-19 Can Do This...

IMAGINATOR



Tektronix® Registered trademark of Tektronix, Inc.
Codonics and Imaginator are trademarks of Cleveland Codonics, Inc.

A CASE THAT'S AS ADVANCED AS YOUR COMPUTER!



A. The strong stainless steel tongue and groove frame, designed for moisture and dust resistance, is the only one of its kind.

B. Secure three-point latching is provided by lock and key combined with an easy to use combination lock. Our Sureglide™ cam action swivel closures hold even when the case is dropped.

C. Customized foam interior is die cut to fit and protect your computer. On larger cases the lid is padded with convoluted urethane foam for complete protection. On 20" cases the lid contains a folio designed to hold floppy discs, full 15" printout paper and manuals.

D. A sturdy wall of high impact resistant ABS (used in football helmets and auto bumpers) provides durable outer protection as well as good looks. The inconspicuous exterior of the case camouflages your computer for added security.

E. Comfortable padded handle makes carrying easy. Larger models also have easy glide reinforced wheels and the convenient T-bar pull handle that flips up when you need it, folds down for travel.

American Tourister computer cases offer you a way to carry, protect and camouflage your personal computer or printer in style. They're built with the same high quality and features that have made American Tourister luggage famous for more than 50 years.

Quality control atmospheric, stress and "abuse" tests

maintain the strict American Tourister quality standard. And in the event of loss, damage or theft, the unique American Tourister lifetime case registration program will verify the date of purchase for insurance claims. Available in metallic graphite gray and classic black.

**FULL ONE YEAR LIMITED WARRANTY
30 DAY MONEY-BACK GUARANTEE!**
USE YOUR VISA, MASTERCARD OR AMERICAN EXPRESS



TO ORDER, CALL TOLL FREE **1-800-341-6311**

IN RHODE ISLAND, CALL 401 273-2020.

© 1983 American Tourister®, Inc. 91 Main Street, Warren, RI 02886



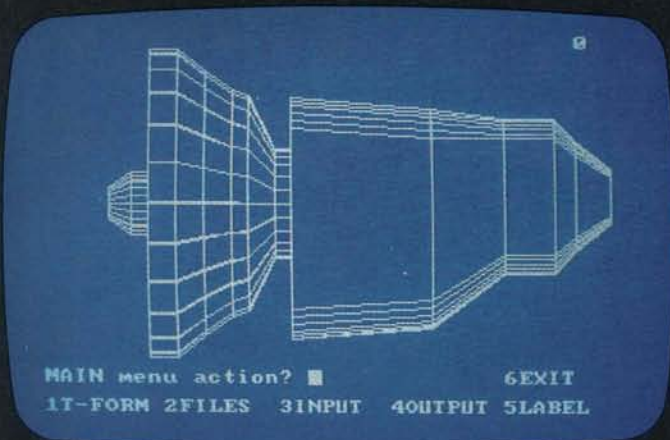

1 Create a 3-D object.

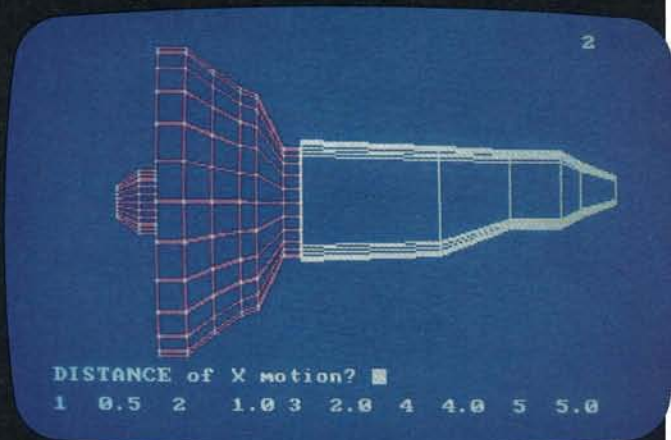

2 Modify it to get the best design.

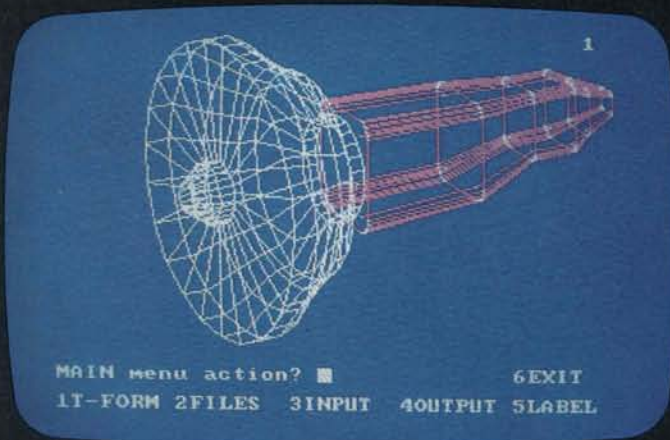

3 Rotate it to examine it from any angle.

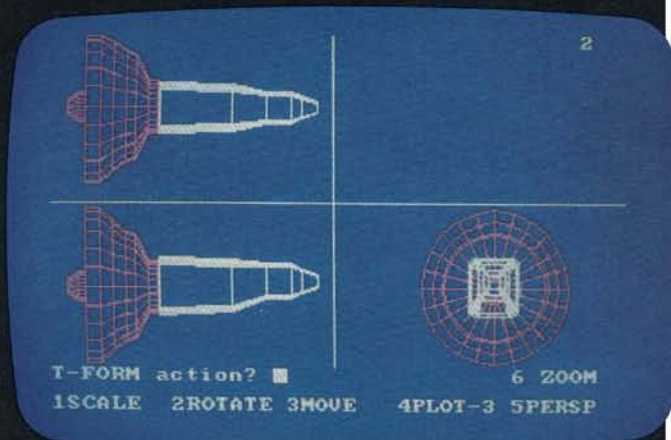

4 Study it in 3 simultaneous orthogonal views.

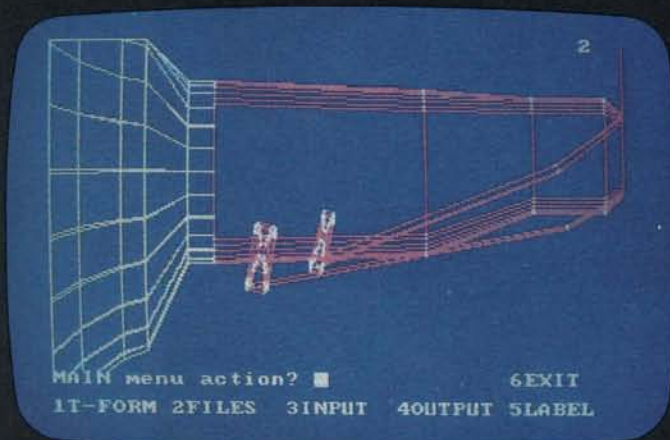

5 Zoom in on part of it and add details.

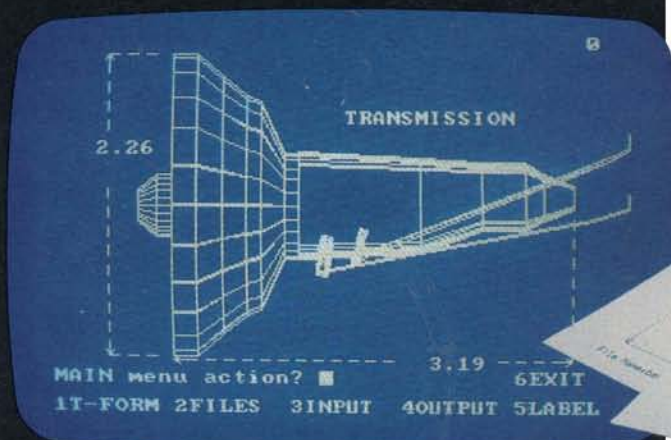

6 Add dimensions and design notes before plotter output.

SCREEN YOUR DESIGNS BEFORE THEY GET ON PAPER.

Turn your microcomputer* into a 3-D CAD system.

Find your best idea, faster. Now, there's a faster, easier way to find the best answer to your design problems. In minutes, you can create, evaluate and perfect your design ideas using your micro and the MCS 3-D CAD system.

Anyone with even minimal computer experience can master our easy-to-use CAD system. It's a simple, menu-driven structure requiring no complicated commands or lengthy keyboarding. You're free to think design, not computers.

Let your micro do the busy work. First, rough sketch your idea using our 3-D Space Tablet™ cursor, our high-res 2-D digitizer, your micro's keyboard, or any combination of the three.

Then, use Advanced Space Graphics™ software to make design changes that normally take hours to do on paper. . . . Scale, rotate or move your 3-D wireframe model about any axis. Duplicate it. Create its mirror image. Section it along several planes. Join it with other components stored on file. Study it from 3 simultaneous orthogonal views, or from an isometric perspective. Add arcs and

circles. Generate surfaces of revolution. You do the thinking, your computer does the work.

Dimensions are computed and changed automatically, as your model changes. When you're ready for hard copy, Advanced Space Graphics lets you add text and output your finished design to a plotter or printer.

The advantages of "true" 3-D. Only our system offers "true" 3-D hardware/software capabilities on a micro. You can use our Space Tablet cursor to actually draw in three dimensions and create, or trace, all kinds of 3-D shapes, even irregular surfaces. True 3-D lets you "reach" into your drawing to grab a point, or figure, and pull it to a new location. It's remarkably easy to translate complex 3-D shapes and ideas into a usable format. Our 3-D CAD system is being used in engineering, architectural, medical, chemical, field mapping, educational, art and many other applications.

A complete 3-D CAD system. The MCS 3-D CAD system includes Advanced Space Graphics software, the 3-D Space Tablet cursor (patent pending), a high performance interface card and a complete user's manual. Our versatile, yet surprisingly affordable system gives you everything you need to do 3-D on your micro. Except, of course, ideas.

For more information, call: (203) 872-0602. Micro Control Systems, Inc., 27 Hartford Turnpike, Vernon, CT 06066.

MICRO CONTROL SYSTEMS, INC.

*IBM PC and a variety of work-alikes are supported. A more basic version is available for the Apple II+ and Apple IIe. Support for a variety of plotters and 2-D graphics tablets available now. The most widely used high-resolution screen displays will be supported by the beginning of 1984.

IBM PC © International Business Machines Corp. Apple II+ and Apple IIe © Apple Computer, Inc.

Circle 482 on inquiry card.

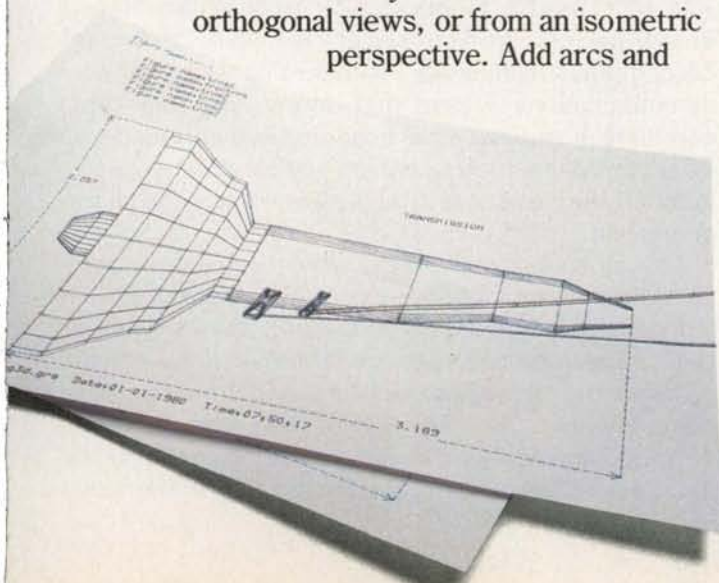

1984 and Beyond

*"Under the spreading chestnut tree
I sold you and you sold me;
There lie they, and here lie we
Under the spreading chestnut tree."*

—George Orwell, 1984

1984. Just another year? Or the dawn of a sinister new era, an era of individual paranoia and cultural stagnation born of fear and suspicion? A time when people's movements, habits, and thoughts are monitored by a centralized power that possesses the technology to gather, record, and collate mountains of data?

Or could 1984 bring the beginning of a Pax Orbis Terrarum of prosperity made possible by a technology that places power in the hands of virtually all citizens, an information autocracy that closes communications gaps and binds knowledge workers into a diverse but cohesive community?

These are complex questions that may have no answers. Despite our thematic cover, this issue of BYTE makes no attempt to examine the social, psychological, and political impact of microcomputer technology—after all, this is a technical journal.

Instead, as is our editorial wont at the turn of each new year, this issue offers some speculation on the specific technical innovations that will affect the personal computer industry in 1984—32-bit microprocessors, natural-language systems, credit-card-sized memory devices, and others.

Before delving into these matters, however, we may all do well to reflect on the implications of our headlong assault on the bounds of technological possibility.

Eric Blair, writing under the pen name George Orwell, created in 1947-48 his "negative Utopian" vision of a world dominated by fascists who possessed awesome technology. The real world was trying to cope with the aftermath of an unprecedentedly destructive war, with the ugliness of Hitlerian genocide, with the throat-clogging fear of the power of nuclear war technology. In this atmosphere, Blair, a fanatical anticommunist, chose to warn the world of the peril represented by the emerging Russian state by conjuring up the vision that is 1984.

The reality of the current world is not nearly so bleak. Nevertheless, there are legitimate concerns about the use of computer technology in modern society. While there may be no Big Brother inside your personal computer, the fabric of life in the West is strongly tied to this technology.

In fact, as this month's cover by visionary Robert Tinney depicts, Western society is heavily dependent on computer technology—it makes possible the telecommunications system that drives our complicated commercial and industrial economy and permeates all its sectors. As a society, we are addicted to computers in much the same way that we are addicted to petrochemicals.

Any dependency can be exploited. Our culture's computer (and information) dependency can be used against individuals and groups as easily as it can be used for them. The negative uses of information have been documented by writers such as David Burnham in his comprehensive book *The Rise of the Computer State*.

The government is a major user of information. The most extensively shared information pool in the world

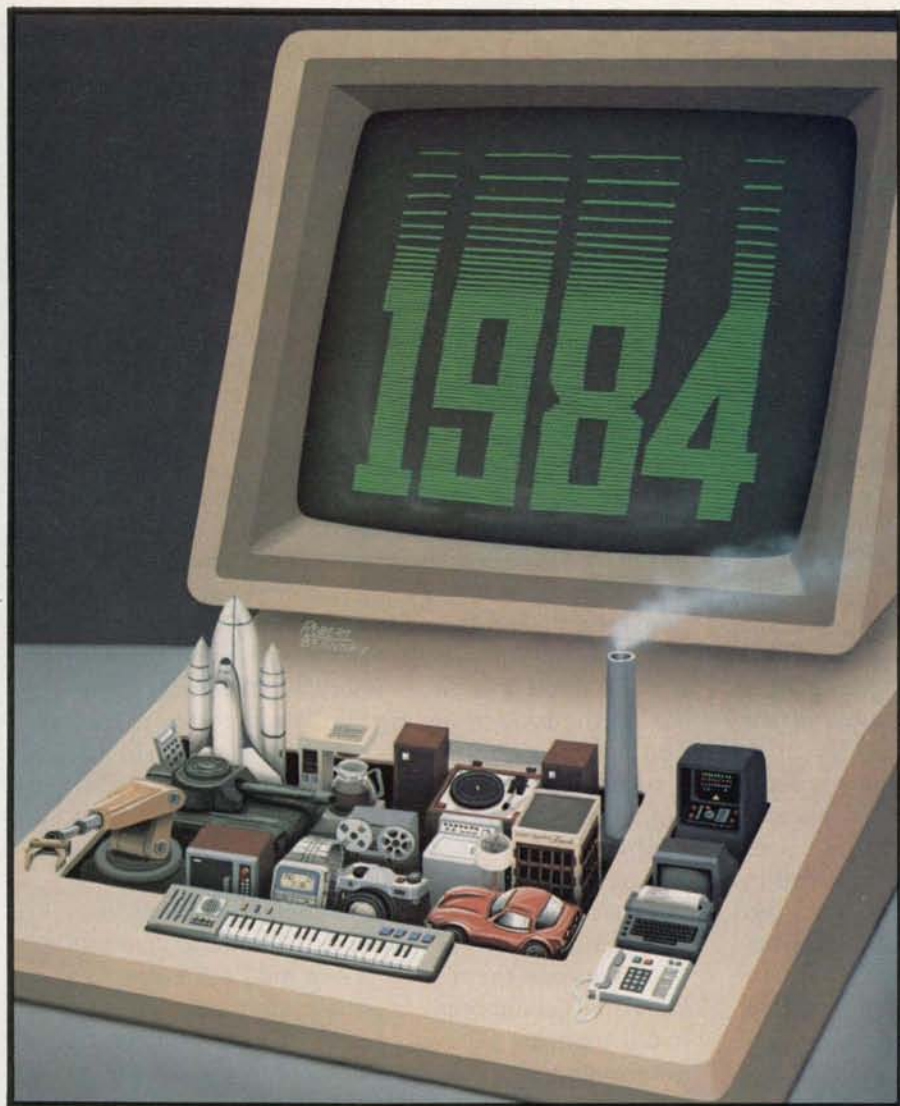

Painting by Robert Tinney

is the FBI-coordinated National Crime Information Center, a computerized network linking more than 57,000 local, state, and federal law-enforcement agencies. The IRS is another agency keen to collect and sift information. Its latest efforts include buying the mailing lists of swank department stores and luxury-car dealerships to track the buying habits of well-heeled taxpayers (*Fortune*, September 8, 1983).

As Kent Greenwalt of Columbia University Law School suggests, intensive information gathering could produce a nation of sheep, all trying to keep their records clean. Such a response could sap the vitality and diversity of our culture.

With the advent of home banking and shopping services, virtually every financial transaction we make will become part of a computer-controlled record. As the text box on page 102 suggests, unauthorized use of these databases may be impossible to prevent. The information society may soon be victimized by a new class of criminal, the information thief.

Currently, no laws prevent the use of information intercepted during data transmission over telephone lines.

While tapping phone lines is illegal, using the information garnered from a tap is not. The sender virtually relinquishes his ownership of computerized information by the mere act of telephone transmission. This presents the specter of thieves intercepting information transmitted from a bank computer to your personal computer and using the information to empty your account.

In the face of these gloomy possibilities, though, is the bright prospect that personal computers also have many beneficial aspects. They can have a democratizing influence on society by making access to information available to large numbers of people. They can aid communication among groups and individuals, further shrinking the distances separating the people of the global community.

However computers ultimately affect our personal and public lives, you, the BYTE reader, will be one of the first to know. Theme issues planned for 1984 will cover topics such as data security, mass storage systems, new chip technology, and communications.

—G. Michael Vose

- 104 Reason and the Software Bus by Michael F. Korn

- 122 A General-Purpose Robot-Control Language by Dan Prendergast, Bill Slade, and Nelson Winkless

- 134 1984, the Year of the 32-bit Microprocessor by Richard Mateosian

- 154 Memory Cards: A New Concept in Personal Computing by Mark Mills

- 172 Computer-aided Design by Rik Jadrnicek

- 213 Speech Recognition: An Idea Whose Time Is Coming by George M. White

- 226 Using Natural-Language Systems on Personal Computers by Jane Eisenberg and Jeffrey Hill

- 243 Portables—1984 and Beyond: Idea-Processing Software and Portable Computers by David Winer and Peter Winer

- 251 Beyond the Application Program: A Different Approach to Integrated Software by John Banning

Does Your Computer Need "Debugging"?

by Bruce Bierman

You are in your private office sitting behind your microcomputer, transmitting highly classified data to another computer system. There is no reason for you to suspect that the information you are sending is being intercepted. Nevertheless, today's electronic eavesdropping devices make stealing your precious data a simple operation. The interception may occur during data transmission, when floppy disks are being mailed, as a result of illegal access of a mainframe using a micro, or because an ex-employee knows the password to your system. But no matter how it occurs, unless you are aware of the vulnerability of your computer system, you leave your data open to a new class of criminal-information thieves.

Computers connected to telephone lines are especially vulnerable. Data transmitted from computer to computer can be intercepted. Most computers used to send data to another computer can be called by an unauthorized "hacker." Once an intruder gains access to the computer, he or she breaks past the password level by writing a computer program that generates possible combinations of characters until the password is found. Another method finds the "back door" access left behind by the original programmer—à la *WarGames*—but this is not usually the case. Once the password has been found, the intruder has total access to the computer system.

Dialing into a remote computer using a modem and a terminal or another computer enables a user to gain complete access to that system.

Computer data transmitted on telephone lines can also be recorded using wiretapping devices. The recordings can be input into another computer for decoding, allowing the thief to read your information. This vulnerability also applies to Facsimile Transmission Machines (FAX), which send pictures of documents over telephone lines. A tap on a FAX line is the equivalent of an outside individual having access to your documents and a copy machine.

I have personally been involved in tracking down information leaks from a major computer company whose coming years' marketing plans and price lists turned up in a competitor's office. The recording of a PanaFax telephone data-transmission line between the U.S. and Japan proved to be the source of the leak.

Transmitted computer data is made up of erratic sound patterns. Therein lies a legal loophole—

currently, no laws protect the interception and recording of these sound patterns. The law does protect an individual's privacy in a telephone conversation, but not the individual's transmitted data.

Using sophisticated electronic eavesdropping devices, recorded ASCII (American National Standard Code for Information Interchange) transmissions can easily be decoded to text on a printer. There are programs available on the market that absorb strings of data recorded on tape and analyze the nature of the data format. The program can determine if the data is ASCII or an encoded or encrypted file. After establishing the type of file, it creates a program to read and print the information.

Although there are devices that protect large computers from unauthorized access by using a call-back verification method, these devices can be defeated. Establishing where the authorized locations of dial-back are and diverting the call-back to another location using an array of available telecommunications equipment on the market is one method. Even if an individual cannot break into the system using his own micro, there are still ways to intercept the transmitted information by placing devices on the data line or within the computer system itself to monitor its operation. This is called "bugging" a computer, which is quite different from a computer with bugs. In bugging or tapping a computer, you can set up the appropriate access necessary to monitor the system's operation using a microcomputer with a program that logs all the functions taking place.

The detection method for finding these back doors, or "debugging," is quite different from correcting errors in a system. This type of debugging demands that all logical paths are defined to establish their finite termination points within the system. Software taps can take a long time to find, while hardware taps are more visible and take much less time to identify.

It may be possible to prevent access to your computer system by hackers or pirates, but a great deal of high-tech espionage is still possible. The professional thief will not spend hours and days figuring out passwords and back doors when he can simply place a tap on your telephone line. All he has to do then is sit back and wait for you to begin transmitting data.

Bruce Bierman is president of Communical Inc. (1400 Grant Ave., Novato, CA 94947), a computer-security consultant firm.

KEY TRONIC PERFECTS THE IBM* PC KEYBOARD



Familiar Key
Legends Rather
Than Symbols

SHIFT Key in Familiar
Typewriter Location

LED Indicators On All
Lock Keys To Show Status

RETURN Key in Familiar
Typewriter Location

Convenient
ENTER Key

Enhance your IBM* Personal Computer System with a Key Tronic keyboard peripheral. This low-profile keyboard is plug-compatible and has familiar key placement. It also features reliable microprocessor electronics, solid-state capacitance switches, and positive tactile feedback.

Special keyboard available for the handicapped — factory direct.

*IBM is a registered trademark of IBM Corporation

Also available in Foreign and Dvorak layouts.

Suggested Retail Price: \$269.00

To order Model KB-5150 call Toll Free 1-800-262-6006 for the retailer closest to you. (7am-3pm Pacific Time)
Warranty information may be obtained, free of charge, by writing to the address below.

 **key tronic**

THE RESPONSIVE KEYBOARD COMPANY

DEPT. E • P. O. BOX 14687 • SPOKANE, WASHINGTON 99214 USA

RETAILERS: For the Distributor in your area, call Toll Free 1-800-262-6006 Dept. D (7am-3pm Pacific Time)

Reason and the Software Bus

A narrative about future software

by Michael F. Korn

With the dawn of 1984, a look into the state of software production provides a view of contrasting extremes. At one extreme are advanced software projects, including the Japanese ten-year project in supercomputers and intelligent software. In this world, heavily funded software research facilities produce expert systems, natural-language interfaces, advanced CAD/CAM (computer-aided design/computer-aided manufacturing) software, and more.

At the other extreme lies the world of day-to-day business and industrial programming, a world where 60 percent of all software is still written in assembly language. In this world, armies of software technicians labor intensively to produce small advantages, and a request to a corporate data-processing department for a simple report may be bottlenecked for two years.

What is the future of the software industry? Will more intelligent software put the less competitive software factories out of business? Will the COBOL programmer become an extinct species? Indeed, will all applications programmers be replaced by automated programming software? As artificial-intelligence techniques permeate computer science, the answer to each of these questions may be yes.

The Reason Research Project

In the summer of 1981 I began a research project in artificial intelligence. Its long-term goal was to develop a highly intelligent software system. I wanted the system to be as independent of its supporting hardware as possible and also to be easily portable to succeeding generations of com-

puters, to take advantage of increases in processing power, speed, and memory-addressing range. I called the project the Reason research project.

As the project gained momentum, I took on an assistant. Our first two years of effort resulted in a new software technology—the Reason software bus—and an advanced software environment that provides multiple windows and tasks. We call this environment—as an in-house joke and with all due respect to Visicorp's Visi On and Apple's Lisa—Lision. This article describes the work of the Reason research project and its possible effect on future systems software.

Before I describe the Reason software bus and Lision, I'd like to review the research background of the project.

A Large-Scale Technology

Because of the project's ambitious goals, I knew it would involve many lines of code and intricate algorithms. To have a hope of success, I had to begin by thinking at industrial levels: not a few programs and hundreds of lines of code, but hundreds of programs and thousands of lines of code.

In software engineering, techniques that are effective at low levels of production may not remain so at high levels. Selecting the correct technology base for development and production was an important challenge.

Possible System Models

In choosing a technology for our software, I considered various currently available choices including

tools like Unix, C, Pascal, and Modula-1 as well as structured-programming techniques, function-oriented languages, and object-oriented operating systems. I even reviewed current experiments that vary from von Neumann's stored-program, register-based model of computing hardware design toward increasingly parallel processing techniques.

Ultimately, we reduced the field to three contenders: object-oriented operating systems, function-oriented languages, and a new model—a "software bus."

Object-oriented operating systems and function-oriented languages are based on systems theory and algebra, respectively, and both derive from sound theoretic origins. Each of these orientations can be applied at some level of engineering effort.

However, important questions remain. What are the costs of implementing these systems, and what resources will they consume in order to operate efficiently?

Ultimately, I chose to use the third system model, the software bus, as the basic tool for the Reason research project. As we will see in a moment, this model springs from an extremely successful engineering metaphor, rather than from algebra or systems theory. I thus began with a system model that I guessed would be practical, without first worrying if the model could be shown to be complete in the mathematical or theoretical sense.

The Hardware Bus

It was the impact of the hardware bus on the recent history of computers that made me think a software

Artificial Intelligence: Reason's Generational Approach

The standard approach to a project with the scope of Reason requires many programmers and much money. We did not have such resources and did not wish to seek venture-capital funding. For these reasons, we took a risky approach to reaching our ultimate goals. We had to bootstrap not just our efforts, but the technology itself.

We chose to build the Reason technology in generations of tools. The idea was that each new generation would be more powerful and efficient than the previous one, taking us a step closer to our goals, and that

with each generation we would build the next.

This strategy was very risky because if even one generation of tools should fail, the project's overall success would be cast into doubt.

The systems and tools described in the main text represent the first generation of the project—the Reason software bus. This generation of tools is not intended to take up directly the question of artificial intelligence. Instead, these tools greatly accelerate the creation of more powerful program components.

Using these tools, the Reason research project has been able to generate a complex software system quickly. The tools seem to be more efficient than anything any of us involved in the project has used before.

We also feel that the Reason software bus fulfills the other criterion of each generation of our technology: to represent a small but significant step toward the project's

long-term goal of artificial intelligence in software. How do I mean this?

No system, human or machine, can achieve advanced intelligence unless the system can manipulate its own components. To do this, the system must have a model to use as a guide. If the system is a machine, the model must be simple and clear enough for a program to understand.

These criteria were crucial in deciding that the software bus was the most appropriate model to use for the first generation of our project. The Reason software bus is a simple, packet-switching data-transmission protocol. In addition to fulfilling this generation's goal of greatly increased programming productivity, it is also a model simple and clear enough for a program to understand. The next generation of integrated components running on the bus may well address directly the issue of the ability of the Reason software bus to understand its own model.

bus would be practical. Bused hardware designs, using integrated circuits, have been extremely effective in advancing electronic engineering in recent years. Most microcomputers, for example, include a hardware bus as an integral part of their design.

The bus setup enables engineers to design such computer systems in an open-ended fashion. Simply by making them conform to the hardware bus protocol, engineers can create exciting new hardware and peripherals compatible with existing systems. Other engineers can configure new and different systems out of existing chips and integrated circuits. Field technicians can repair all these products by replacing modular boards.

Telecommunications systems display another successful application of busing protocols. Communications networks, which bus data from one location to another in small packets, are indispensable to today's information-processing industry.

The Reason Software Bus

The power of the bus as a system model is all the more remarkable in that the bus is little more than a data-transmission protocol. What in-

terested the members of the Reason research project was whether this busing concept could form the basis for a similarly successful generation of software tools. Could we apply the same design metaphor, so successful in hardware and telecommunications, to the creation of an equally successful new software technology?

The Reason software bus uses the bus metaphor to create a new software technology. In its basic form, the software bus is a simple protocol for transmitting data packets from one bus-integrated software component to another. The bus protocol looks like a standard telecommunications protocol, with six transmitted parameters and two returned parameters.

Bus-integrated components are independent software modules, the metaphorical counterparts of the integrated circuits in a hardware bus design. They are passive software packages, activated by transmissions along the software bus.

Once activated, a bus-integrated component may initiate transmissions that activate other bus-integrated components. In such an orientation, the software implementing the bus is in control. Individual soft-

ware components are not even aware of a world outside themselves. Instead, they simply receive and transmit data packets from origins to destinations.

Power and Flexibility

Like their counterparts working in hardware-bus environments, Reason design engineers using the software bus can develop powerful bus-integrated components, confident that Reason system engineers can quickly configure the bus with various combinations of these components to create complex applications systems. Reason maintenance personnel can repair or update such systems merely by replacing one or more bus-integrated components with newer and more powerful components.

Reason and Unix

A comparison with Unix illustrates the power and flexibility of a software-bus design. The Unix operating system allows standard output from one program to be rerouted as the standard input to another program. This capability, called piping, is a hallmark of Unix flexibility.

Now consider an environment in which *all* input and output of any

System Models in Software

Why can't you request a list of all the programs that operate under CP/M? Of the programs that interact with each other? Of the means they use to interact?

Because no such list exists, nor is it likely to exist soon. This is because the system model for CP/M programs is unclear. People can and do write CP/M programs in any fashion they choose. The question of system modeling comes up only after the programs are written, when it is too late. CP/M is just one of many programming environments in which the system model does not receive high priority.

However, new programming environments are being designed in a different way. Designers choose a system model first, and then create programs.

We considered three such models for Reason. Object-oriented environments, function-oriented environments, and software-busing environments.

A number of current experiments are aimed at developing object-oriented computer operating environments. An "object" can be anything from a byte memory switch to a whole suite of programs, depending on the flexibility of the system's "object dictionary." Object-oriented environments depend heavily on descriptive tables and dictionaries.

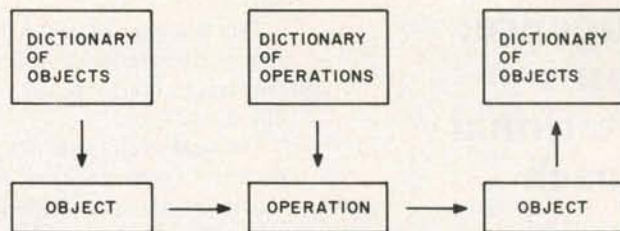

Figure 1: An object-oriented operating system model.

The preliminary manual of one such project contains terms like hierarchy, node, keys, locks, badges, and zone-in-item-space. More simply, however, figure 1 illustrates the kind of model an object-oriented operating system proposes.

In this environment, operations performed on objects create new or altered objects. Each of these objects and operations is stored in one or more dictionaries. As operations alter objects in the environment, the environment's dictionaries are updated to reflect these changes. Thus, a list of available programs, which was difficult to obtain for CP/M, is easily obtained in an object-oriented environment. You simply examine the system's dictionaries.

Function-oriented programming environments extend to the design and construction of new programming languages

and to the future of computing hardware. Function-oriented environments are especially exciting when designed in tandem with hardware design.

In such an environment, the function-oriented software is designed to break large functions down into sequences of smaller functions. The software then ships these smaller functions to parallel processors so that the various portions of a problem are solved piecemeal but simultaneously.

The Reason design team did not choose either of these models, despite their respective attractions. Instead, we chose to develop a software bus. Although it was a newer, less well-tested system model, we felt the Reason software bus gave us the even greater power and flexibility we required to reach our long-term goals.

program component is "standard," i.e., is known to the software bus and occurs across an active bus transmission line. Such transmission lines can be run in series, in parallel, or in any other logical combination. Transmissions from any component can be rerouted to any other component on the bus by a simple command reconfiguring the bus. Such is the flexibility and power of the software bus.

Software-Bus Technical Details

The Reason software bus is a data-transmission protocol between discrete bus-integrated components. Its function is analogous to the functions performed by a hardware bus. In fact, the Reason protocol looks much like a standard packet-switching network protocol, with six transmitted parameters:

- user identification (person or component ID)
- logical transmission-line number (unique data path)
- transmission-origin routing name
- transmission-destination routing name
- transmission verb or command expression (e.g., LOGON, LOGOFF, WRITE, NEXT, etc.)
- transmission data packet

and two returning parameters:

- returned data packet
- transmission status message

The Reason software bus supports each discrete integrated component by providing a code page, a data page, an operations stack, and a data stack. Figure 1 on page 108 demon-

strates how these supporting resources interact.

Each time a transmission session on the bus activates a bus-integrated program, a Reason context is created. A newly created timesharing operation is called a task. It is common to have multiple contexts within a single task. It is also possible to have multiple tasks within a single context.

The code page contains the optimized machine-language code that is the bus-integrated program. The Reason protocol allows code pages to vary in size, up to 64K bytes.

Importantly, all Reason bus-integrated components are recursively reentrant. Neither multiple simultaneous contexts nor multitasking applications require multiple copies of the same program code page. Components can invoke themselves or

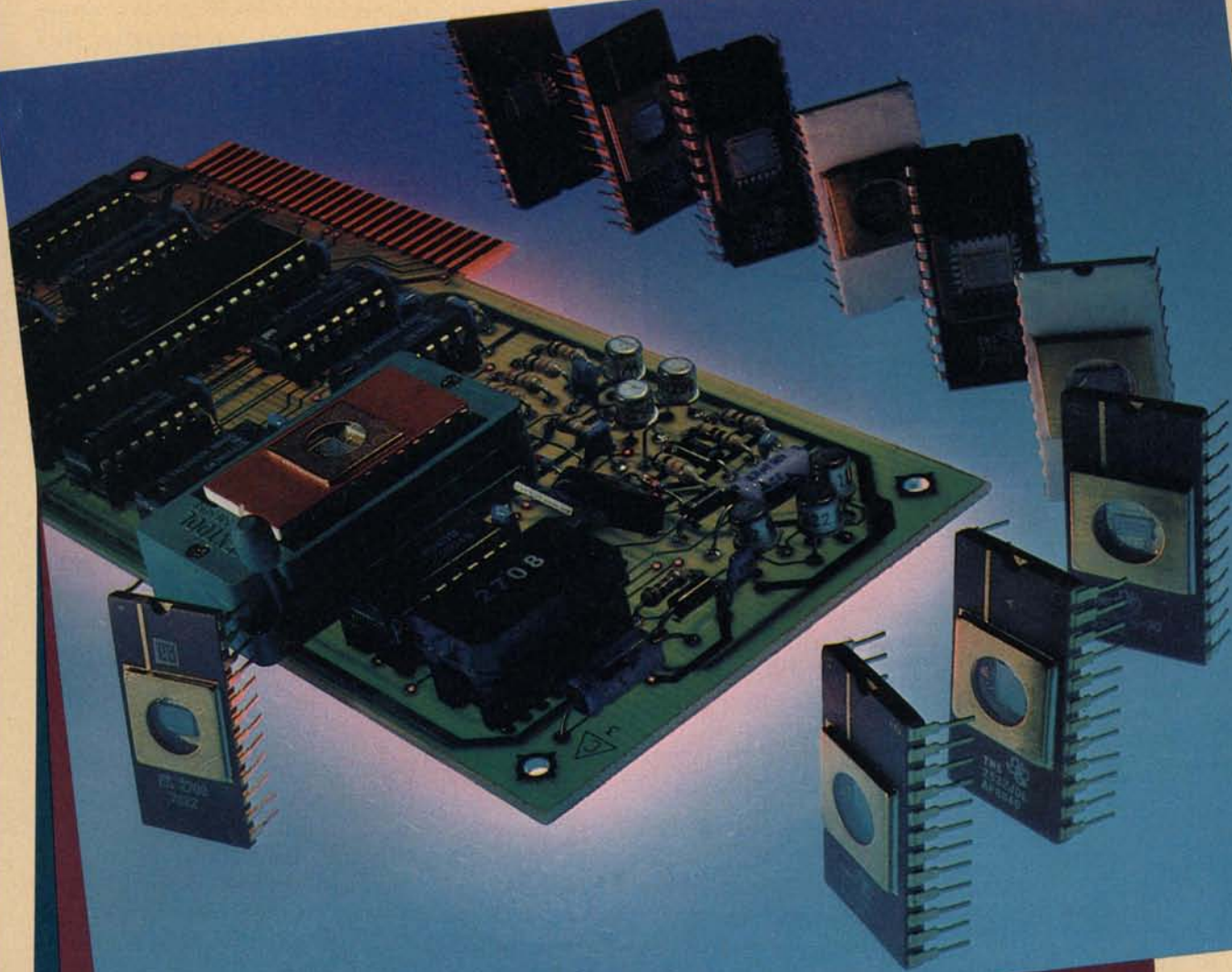

The Apparatus EPROM Blaster, Now for the IBM/PC, Apple II and TRS-80.

Apparatus's EPROM Burner: It's new. It's more powerful and now available for all three of today's most popular personal computers. And the price has dropped by over 20%.

Increased Capabilities

The Apparatus EPROM Burner (A.P.B.) programs most 24 pin 4, 8, 16 and 32k EPROMS, but now it can also program 64k devices. And with all personality modules and software included, Apparatus's EPROM programmer is the most sophisticated system on the market.

The A.P.B. system can verify, read, program and copy the EPROM; copy between different ROM types; read or save EPROM data on storage devices; program directly from computer memory and more.

And a Lower Price

Even with increased capabilities we've been able to lower the price 20% to \$119.00 (\$129.00 for the IBM/PC). This price includes all the personality modules, operating software and the instruction manual.

If you're looking for a powerful, versatile and cost efficient EPROM burner, contact us today, Apparatus, Inc., 4401 S. Tamarac Parkway, Denver, CO 80237, (303) 741-1778. Or to order call

800/525-7674

IBM/PC is a trademark of IBM
TRS-80 is a trademark of Tandy Corp.
Apple II is a trademark of Apple Computer

Circle 29 on inquiry card.

 **Apparatus, Inc.**



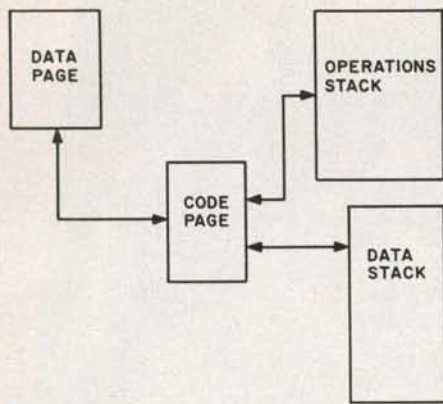

Figure 1: The interacting resources of the Reason software bus. Each software component on the bus has a code for the program's source code, a data page for variable storage, and operations and data stacks, the "scratchpads" for program operation.

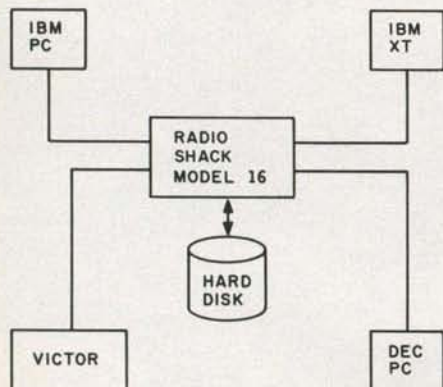

Figure 2: Each microcomputer runs a version of a Datanet. Datanet masks the differences between each node microprocessor and the network environment. Microcomputers in the network share data as well as execute programs interactively.

can be invoked many times concurrently and still require only one copy of the object code.

New data pages are supplied for each concurrent invocation, and, as long as the data pages are kept separate, everything operates smoothly. Reason provides a data page for each context. Reason also provides an operations stack and a data stack for each task.

Selecting a Language

Selecting a computing language to implement the Reason software bus

was difficult. We needed a high degree of machine independence but could not afford the run-time overhead of previously existing pseudo-code languages like Pascal.

Pascal also was too high-level for our purposes, as we needed to work more directly with the machine. We looked at FORTH but decided it was too slow in execution and cumbersome in its linking process. We felt C was fast enough, but it still didn't let us get close enough to the machine.

The N Language

Finally, we chose to develop our own language to support the project. We decided to create a language with two different syntaxes: it would be simultaneously an assembly language and a high-level language. We dubbed this language a "meta-assembler" because of its dual syntax. We called it N, for Network language. (See the accompanying box for details on N, its speed, and its unusual dual syntax.)

The Network Control Program

The Reason software bus is an internally networked data-transmission protocol. In effect, it is a network of independent software components. This network is integrated using a control program somewhat analogous to an operating system. In Reason, this program is appropriately termed a network control program, or simply NCP. By loading a network control program into a machine and creating origin and destination dictionaries, you configure the system.

It is the responsibility of the network control program to support the software bus. How a program is loaded into a code page, how contexts and tasks are started, and how data pages and stacks are allocated are all problems that the NCP must resolve.

Unlike an operating system, however, a network control program is merely another discrete integrated program on the Reason software bus. Network control programs are every bit as interchangeable as any other component in the system. You can construct many different NCPs,

simple or complex, to satisfy specific engineering needs. This has interesting implications, especially for networks involving a variety of computers.

In figure 2, all computers might be running copies of the same network control program and sharing the network equally. Or some computers could be running different NCPs with different functions and orientations. One or more might be running NCPs in a slave mode, and one machine or more might have a master NCP installed, determining the specific tasks of the other computers.

The problems of networking personal computers—from the same manufacturer, let alone of different brands—have been hard to solve at the software level using other technologies. Once the Reason software bus has been installed on a number of machines, however, these problems shrink to the less difficult activity of configuring network control programs for different tasks and relationships among the networked computers.

Building the First NCP

Datanet, the first network control program written for the Reason project, is designed as a multicontext, single-tasking, microcomputer network control program. It is a discrete, integrated component on the Reason software bus. This first NCP manages up to 1 megabyte of RAM (random-access read/write memory) and up to 12 concurrent program contexts and uses as little as 300K bytes of floppy disk storage or as much as 15 megabytes of hard-disk storage.

Copies of Datanet operating concurrently on different microcomputers can be used to create a network machine. Each computer in the network shares program contexts and exchanges data. Network machines can duplicate tasks for redundancy, or a large problem can be broken up into smaller activities to take advantage of the parallelism of the network.

The design of Datanet allows maximum flexibility. As figure 3 illustrates, the Datanet kernel is nothing more than a network transmission

Text continued on page 122

Draw your own conclusions with a Six-Shooter.™

The Sweet-P™ Six-Shooter. The six-pen graphics plotter that made a big noise at COMDEX. It goes for \$1095. And goes. And goes.

The Good Guys from Enter Computer, Inc., really showed 'em at COMDEX.

They pulled out the Sweet-P Six-Shooter. And it blew everyone away. Especially the competition.

The Six-Shooter graphics plotter uses six pens, not just two. They change and cap automatically in a fraction of a second. And they can draw at 14 inches a second on a plotting area of 8½ x 11-inches or 11 x 17-inches.

But it's *what* they draw that caused all the excitement.

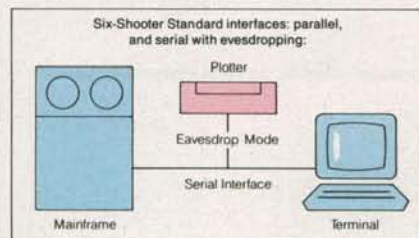

Trademarks: Sweet-P, Six-Shooter, Personal Plotter, Enter Computer, Inc.; Apple Computers; H-P, Hewlett-Packard; IBM, International Business Machines; CP/M, Digital Research.

Presentation-quality graphics in six colors. Graphs of all kinds...bar, pie, line, scatter and surface. Information taken from spread sheets or D.I.F. files, and reproduced in minutes on paper or acetate (for overhead transparencies).

The Six-Shooter showed its friendly side, too. It's compatible with IBM, Apple and major CP/M-based micros. Which means, of course, that it can use most of the graphics software created for them. Including many packages that support Hewlett-Packard's plotters.

If you're networking, get this: the Six-Shooter has two ports that let you switch from parallel interface to RS-232 serial interface and back again. It'll even eavesdrop on the line between your computer and any terminal, listening for the signal to start plotting.



Servicing is available at any of more than 80 Xerox Service Centers throughout the country. And software assistance and advice is as close as your telephone. Just call the Good Guys direct. And toll-free. In California, call (800) 227-4371. Anywhere else in the U.S., call (800) 227-4375.

Get hold of a Six-Shooter now at your nearest computer store. Then draw your own conclusions. In six colors on paper or acetate. In minutes. For \$1095.



The good guys from out of the West.

Enter Computer, Inc.,
6867 Nancy Ridge Drive,
San Diego, California 92121.
Telephone (619) 450-0601.
Milan, Italy: (392) 323597.

**Enter Computer.
The Sweet-P Personal
Plotter Company.**

Circle 19 on inquiry card.

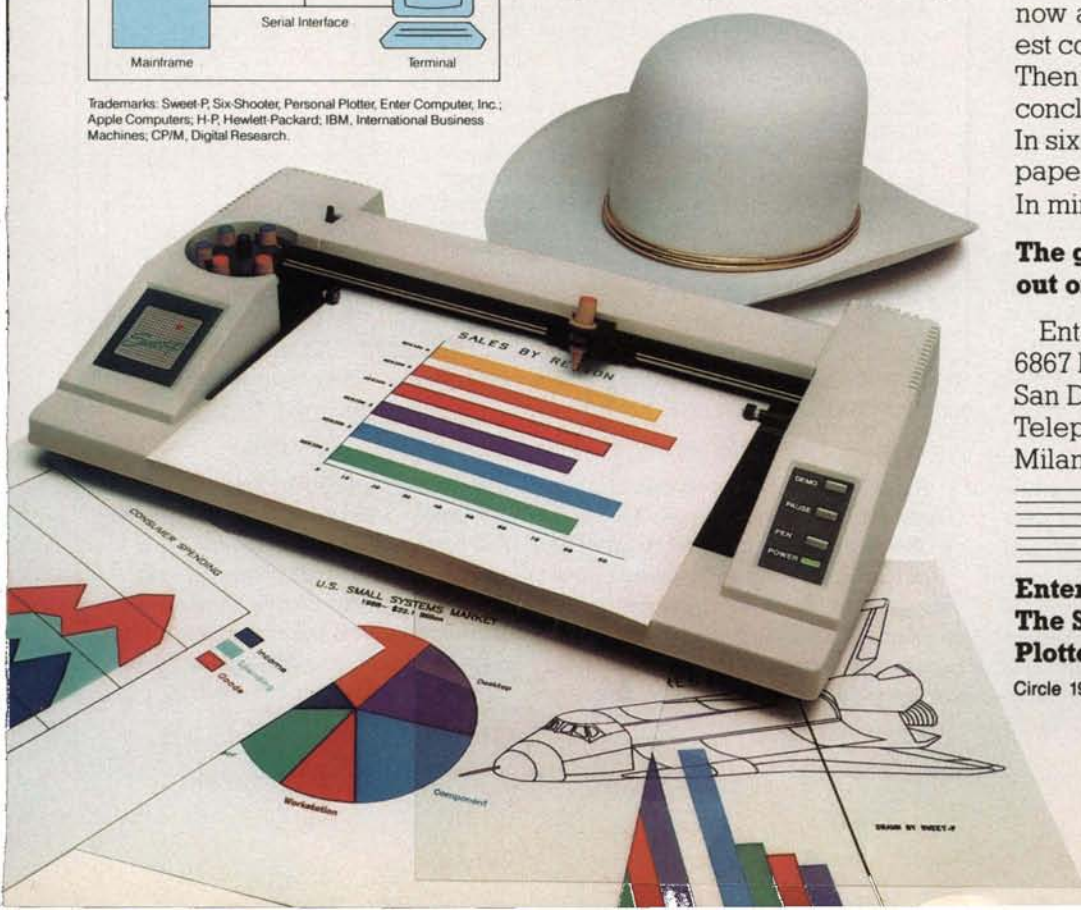

The Reason Network Language

The N language is an assembler for a very well defined, imaginary, stack-oriented, pseudocode-like machine. Programs can be written, one p-code per line, exactly as with assemblers for real machines. But high-level syntax can also be used, which is why we call it a "meta-assembler."

Unlike many other p-code machines, the N p-codes never appear in the target machine. The N compiler outputs what in Reason is called a Compiler Normal Form file. This file is then passed through O, the Reason binary code generating optimizer. And, the final form of an N language program is optimized binary machine language for the target machine.

The result is that N language programs are highly portable yet very fast. Currently the N language operates on the Motorola 68000 and the Intel 8086 family of processors. Reason also plans to create optimizer tables for the National Semiconductor 16032 and other microprocessors.

N language programs can be written in normal assembly-language format or in high-level syntax. Listings 1 and 2 demonstrate N's unusual feature of a dual syntactical structure.

Significantly, both forms of the program are equivalent. O will output the identical optimized binary machine code regardless of the form used.

O, another product of the first generation of Reason, is a 900 template optimizer with expression reduction and register allocation. Since the optimizer is table driven, only one copy of the optimizer is required for all target machines. Changing the optimizer's tables generates machine code for a new target machine.

A study published in the Gilbreath article cited in the main text displayed times for execution of a prime-number generating program written in several different compilers on the Motorola 68000. A comparison of results (table 1) for the same prime-number generator written in N yields some indication of the efficiency of N and O on the 68000 relative to the nine top performers in the Gilbreaths' study.

Listing 1: The assembler-like syntax variation of the proprietary language, N.

```

START:      #LCD{K}          /* LOAD ADDRESS OF INTEGER VARIABLE */
            #LOD{I}          /* LOAD INTEGER ONTO STACK          */
            #LCI{0}          /* LOAD INTEGER CONSTANT ONTO
STACK                                     */
            #CPI{GE}         /* IS K GREATER THAN OR EQUAL TO 0 ? */
            #JCF{ELSE}       /* JUMP IF K LESS THAN 0            */
THEN:       #LCI{1}          /* LOAD INTEGER CONSTANT ONTO
STACK                                     */
            #LCD{N}          /* LOAD ADDRESS OF INTEGER VARIABLE */
            #SVD{I}          /* SAVE INTO INTEGER VARIABLE       */
            #JMP(CONTINUE)   /* JUMP AROUND ELSE                 */
ELSE:       #LCI{-1}         /* LOAD INTEGER CONSTANT ONTO
STACK                                     */
            #LCD{N}          /* LOAD ADDRESS OF INTEGER VARIABLE */
            #SVD{I}          /* SAVE INTO INTEGER VARIABLE       */
CONTINUE:

```

Listing 2: The high-level syntax of N.

```

START:      IF [K >= 0] THEN [N:=1] ELSE [N:=-1]
CONTINUE:

```

Computer	Language	Time (seconds)
68000 8 MHz	Assembly	0.49
68000 8 MHz	SMPL (Ebnek)	2.6
68000 8 MHz	N	2.85
68000 8 MHz (Sun PM68K)	Pascal (Telesoft)	4.28
68000 8 MHz (Sun PM68K)	Ada (Telesoft)	4.4
68000 Wicat 150WS	C (Johnson)	4.71
68000 8 MHz (HP-9830)	Ada (Telesoft)	4.0
68000 8 MHz (HP-9830)	Pascal (Telesoft)	5.0
68000 8 MHz	Pascal (Softech Nat.)	5.0
68000 8 MHz	Pascal (IMS Inc.)	5.8
68000 8 MHz (HP-9830)	Pascal (Hewlett-Packard)	5.9

Table 1: Results of a prime-number generating program in a variety of languages running on 68000 processors.

Reason optimization tools will also include a table-driven, assembly-language source generating optimizer to be called S. This optimizer will generate native assembly language files in one-to-one correspondence with the binary output of the code generating optimizer. S would be used in the event that an O-optimized N program

were not fast enough for some special implementation. In such a case, compiler normal form would be passed through S to produce native assembly-language source. An engineering technician would then further optimize this source by hand, until it was as close to assembly-language speeds as the implementation required.

For people who want power.



And something more.



If you are seeking power in software we believe we have created the program you seek.

And our opinion is shared by a great many computer analysts who consider 1-2-3™ from Lotus® the most productive program in the marketplace.

Like many great ideas the essence of its success is its simplicity. With 1-2-3, you have spreadsheet, information management and graphic functions—all in one program.

You can switch from one function to another with the touch of a key, instantaneously. Although it seems faster.

In effect, it's a perfect combination of raw power and spectacular speed.

But for those who want more, 1-2-3 is specially designed so you can develop customized applications for your business needs. And the world's largest electronic spreadsheet has enough operators, functions and commands to perform virtually any task you ask of it.

In fact, the only limit is your imagination. 1-2-3 from Lotus is power and something more.

Call 1-800-343-5414 (In Massachusetts call 617-492-7870) and find out more about 1-2-3 from Lotus.

 **Lotus**
The hardest working software in the world.

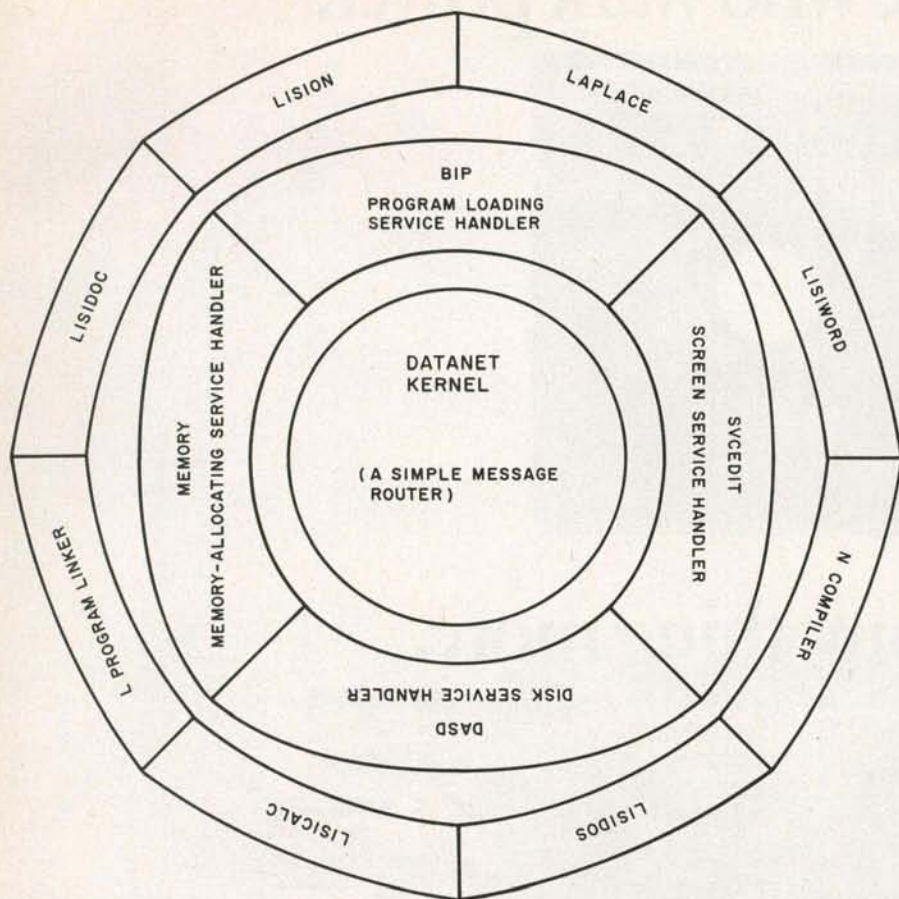

Figure 3: The Datanet system is constructed from a layered collection of discrete components with a single message router at the center. There are no operating systems or applications programs, just a collection of components, each sending messages to all the other components.

Text continued from page 108:

manager. All of the actual work is performed by the Datanet system service handlers (SSHs), independent modules through which Datanet routes all transmissions.

Datanet comes with several resident system service handlers, and additional disk-resident SSHs are available as well. Datanet's use of disk-resident SSHs allows an engineer wide flexibility in dynamically extending or constricting Datanet for specific environments.

The Laplace Interpreter

With an NCP and other bus-integrated programs available, it remained to complete the actual software bus by linking these components.

To picture this problem, consider how a printed-circuit board joins unrelated components in a hardware bus design to create products. How are two popular 16-bit computers—

the DEC Rainbow and the IBM PC—related? From our human point of view, the difference between these two computers is clear. They look different, they have different keyboards, and they come from different manufacturers.

Yet, from an engineering standpoint, they and other computers share many of the same integrated circuits and components. Under their covers may lie the same microprocessor, memory chips, and logic circuitry. Seen from the point of view of an integrated-circuit manufacturer, each of these computers might be thought of as merely a different *user view* of mostly identical components.

How could we on the Reason research project construct software user views? Obviously, in software we could not use a physical surface such as a printed-circuit board. Instead, we would need an algorithmic language to logically connect our various

software-bus components. To speed up development of the Reason project's user views (the applications software), we decided that this language would be interpreted.

Existing Choices

Once again, we undertook a review of the existing technology in the area of interpreters. We looked first, of course, at BASIC. The syntax style of BASIC is easy to learn and use, which means that programming neophytes might be able to develop user views on the Reason software bus.

Because BASIC programs are readable after any number of revisions, maintenance is fairly easy. But BASIC lacks the modularity necessary for large engineering projects. We had to reject it as the language of choice.

APL has simple and efficient modularity, but its syntax is too esoteric and difficult to maintain. FORTH, the only other interpreter we considered at length, is extensible: user-defined commands can extend the language's vocabulary with new words—a very desirable feature. Another FORTH advantage is its ability to get at the machine.

But FORTH did not fulfill our syntactical requirements for readability. So, as you might expect, once again, we decided to create our own interpreter, combining all these desirable features. We call it Laplace.

Laplace is an interpretive language in the same syntax family as BASIC. It has the modularity and recursion of APL. It also has the extensibility and machine facilities of FORTH. The Laplace interpreter is one more bus-integrated component, a discrete software module running on the Reason software bus.

A Laplace Listing

Listing 1 is a prime-number program coded as a user-defined command in Laplace. Versions of this program in many different languages appeared in an article by Jim Gilbreath and Gary Gilbreath (see "Eratosthenes Revisited: Once More through the Sieve," January 1983 BYTE, page 283). Listing 1 allows comparison of Laplace syntax with that of other languages.

Number One Add-On Products for IBM PC



The Multifunction Cards that let you get the most out of your IBM PC.

AST Research Number One Add-Ons let you realize the full potential of your IBM PC or PC-XT without wasting valuable slot space. By combining your memory and input/output requirements on a single card, you can take advantage of more of the capabilities IBM designed into the PC, while leaving space for future enhancements as they are introduced. AST Research multifunction boards can add user memory from 64K to 512K to your PC bringing your PC memory to its maximum of 640K. You also receive the added features of serial ports, parallel ports, a clock/calendar, game adapter port, and SuperPak™ — the utility diskette with the most powerful disk emulator and print spooler software available.

SixPakPlus™ — Up to 384K memory, serial port, printer port, optional game port, and clock/calendar on a single card.

I/O Plus II™ — Up to 2 serial ports, optional printer port, optional game port, clock/calendar on a single card. No memory.

MegaPlus II™ — Up to 512K memory, up to 2 serial ports, optional printer port, optional game port, and clock/calendar on a single card.

ComboPlus™ — Up to 256K memory, serial port, printer port, and clock/calendar on a single card.

Communication Products — Other AST Research Number One products include system enhancements and mainframe communications products such as 3270 SNA and 5251 terminal emulation, 3780 RJE support and AST-PCnet™ — the Local Area Network specifically designed for the IBM PC.

AST Quality

All AST Research multifunction boards come with the **AST "Plus"** — our unsurpassed reputation for quality, reliability, after-sales support, and overall design excellence — which give our products the best price/performance ratio in the industry.

AST Research Number One Add-On Products are available at Computerland, Entré, Businessland and other computer stores worldwide. Contact AST Research, Inc. for the dealer nearest you. (714) 540-1333/863-1333 TELEX: 295370ASTR UR

PCnet is a registered trademark of Orchid Technology, Inc.

Circle 456 on inquiry card.

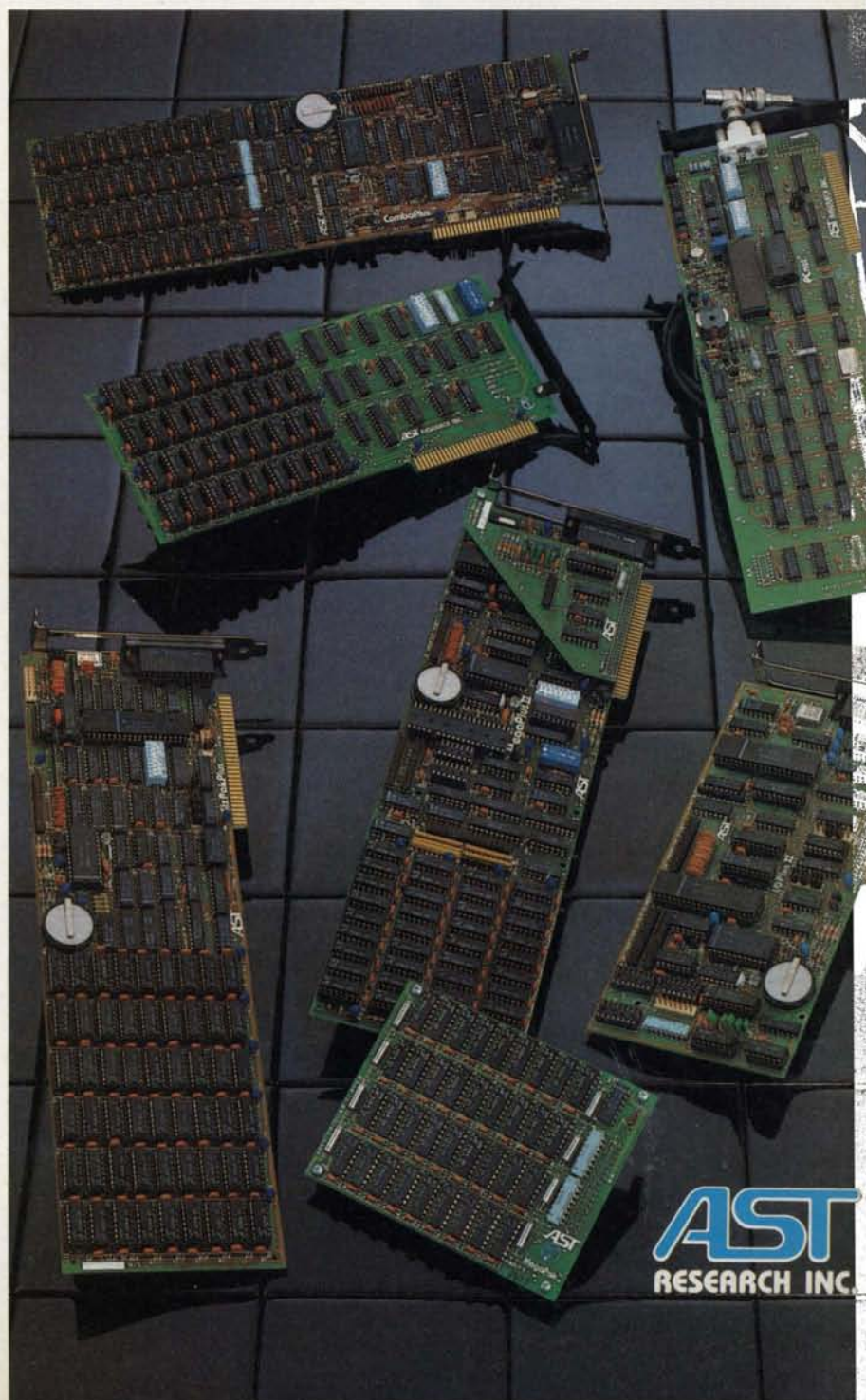

AST
RESEARCH INC.

CARD TRICKS.



(Or how to add six functions to your IBM PC/XT with just one multifunction card)

It's not magic. And it isn't sleight of hand. It's ConsoCard from Consolink...the multifunction card for your IBM PC OR PC/XT that performs six tricks from a single slot space.

- **Up to 384K expansion memory** for larger in-memory data bases.
- **Printer spooling** for computing even when the printer is printing.
- **RAM disk emulator** for fast access to frequently used files.
- **TWO asynchronous RS-232 ports** for communication with other computers.
- **Battery powered chronograph** for accurate time keeping.

One Card. Six Tricks.



ConsoCard

Without it, your IBM
isn't playing with a full deck.

Circle 109 on Inquiry card.

IBM and the IBM logo are a registered trademark of International Business Machines Corporation.

CONSOLINK
CORPORATION

1840 Industrial Circle • Longmont, CO 80501
(303) 651-2014 • Toll Free 800-525-6705

Subsidiary of Consolidated Packaging Corporation

Listing 1: A prime-number generator written for the Laplace interpreter.

```
100 DEF, PRIME
110 DIM,flags[8191]{i},m{i},count{i},prime{i},k{i},i{i}
120 ?"10 iterations"
130 FOR{M = 1,10}:count = 0
140 FOR{i = 0,8190}:flags[i] = 1:NEXT!
150 FOR{i = 0,8190}
160 IF {flags[i] = 0}THEN:GOTO,210
170 prime = i + i + 3:?prime:k = i + prime
180 IF {k > 8190}THEN:GOTO,200
190 flags[k] = 0:k = k + prime:GOTO,180
200 count = count + 1
210 NEXT!
220 NEXT!
230 ?count," primes"
240 END!
```

Our First User View

With Laplace in our software toolbox, it was now time for the acid test. Could the Reason research project accomplish anything with these shiny new software tools? It was time to construct the first user view.

To preserve the bus metaphor and perform this task efficiently, this user view would have to be a selection of discrete bus-integrated components fitted together via interpretive Laplace programs and merged into a system configuration. Of course, with this as with all user views, the computer user would not need to see inside the creation.

From the user's point of view, this new creation seems just like any other large, complex application program, in the same way that a DEC Rainbow and an IBM PC appear to a user as distinct computers, rather than two different user views of mostly the same components.

We chose to develop an advanced user view—a complete software environment comparable to Visicorp's Visi On and the software running on Apple's Lisa.

Could we develop, without high-resolution hardware or a mouse, a user view of such sophistication? We decided to try and to refer to this environment as Lision.

Lision

In order to fully test the productivity of the new software tools, we assigned one senior software engineer full-time to the project. Single-

handedly, this engineer would have to connect existing bus components together with Laplace algorithms to form

- a multiple-screen context (window) applications interface
- a disk operating system, similar in its functions to MS-DOS, which would operate out of any of the screen contexts
- an advanced spreadsheet program
- a full-service text editor
- a document printer/formatter for combining text files into large printed documents
- a database-management system

The result, Lision, operates efficiently in 320K bytes of RAM, using as little as 300K bytes of disk space. (See photos 1 through 11.)

The document printer/formatter can produce documents of up to 500 pages and automatically generates a table of contents, headers, etc. The disk operating system can perform directories, memory dumps, interactive debugging, generic file copies, deletes, merges, and even generic N compiles or native assemblies.

The Lision text editor does line or column move or copy, group search or replace, wrap-around paragraph managing, and even sorting. The spreadsheet is fully programmable. It includes all the transcendental functions, IF...THEN statements, user definable commands, and a wide range of full programming features.

**This 3 hour coffee break
is brought to you
by your printer.**



**Wait-less Computing™
is brought to you
by MicroSpooler.™**

In the business world, time means money. So you want your computer to make the most of every minute. But while your printer is busy printing, your computer is busy... **waiting**.

MicroSpooler™ from Consolink keeps your computer free for use even when your printer is operating. It stores data, then sends it at the fastest rate your printer will accept. There's no down time, so there are no needless coffee breaks. And your computer is back on the job in seconds... **working** instead of waiting.

Because MicroSpooler™ is a stand-alone buffer, it can be easily

installed in-line between almost any printer and computer, as well as communications and peripheral devices. And its attractive case and compact size allow it to fit comfortably in any office environment.

Standard features include:

- 16K memory—expandable to 64K
- Status readout—displays amount of data stored or number of copies left to run (up to 99)
- Internal power supply—eliminates extra cost and bulky adaptors

MicroSpooler™ from Consolink. When you want your computer to **wait** less... and **work** more.



CONSOLINK
CORPORATION

COLUMNS		LIS-CALC					
ACME CO. 1984 P		INSERT	JAN	FEB	MAR	APR	MAY
1							
2							
3							
4	GROSS REVENUES	COPY					
5	DEM Price (un)	MOVE	125.00				
6	DEM Sales (un)	unused	0.00	4000.00	4000.00	4000.00	4000.00
7	DEM Sales (\$)		0.00	100000.00	100000.00	100000.00	100000.00
8							
9	INVESTMENT REVENUES						
10	Investment Base		300000.00				
11	Interest Rate		.11				
12	Investment Income		2750.00	2750.00	2750.00	2750.00	2750.00
13							
14	WIDGET RESEARCH EXPENSES						
15	Research Assistant		2500.00	2500.00	2500.00	2500.00	2500.00
16	IRS & SSC overhead		625.00	625.00	625.00	625.00	625.00
17	Research Fee		3000.00	3000.00	3000.00	3000.00	3000.00
18	Product Royalty		3000.00	3000.00	3000.00	3000.00	3000.00
19	Travel Budget		250.00	250.00	250.00	250.00	250.00
20	Equipment Budget		850.00	850.00	850.00	850.00	850.00

Photo 1: Lisicalc, the Transoft spreadsheet, shown with one of its pop-up menus.

EDITING		LIS-CALC				
23	ADMINISTRATION EXPENSES					
24	President Salary	4000.00	4000.00	4000.00	4000.00	4000.00
25	V.P. Finance Salary	4000.00	4000.00	4000.00	4000.00	4000.00
26	V.P. Marketing Salary	4000.00	4000.00	4000.00	4000.00	4000.00
27	IRS & SSC overhead	3000.00	3000.00	3000.00	3000.00	3000.00
28	Office Rent & Utilities	3500.00	3500.00	3500.00	3500.00	3500.00
29	Travel Budget	500.00	500.00	500.00	500.00	500.00
30	Equipment Budget	500.00	500.00	500.00	500.00	500.00
31	Total Admin Expenses	19500.00	19500.00	19500.00	19500.00	19500.00
100	DEF,ADMIN					
110	LOOKUP,A,1,125,"ADMINISTRATION EXPENSES"IN					
120	LOOKUP,A,n,125," IRS & SSC overhead"IN					
130	FOR<I=JAN,DEC>:CSUM,WC0[1],n,1-j;X,WC0[1],n,1;NEXT					
140	LOOKUP,A,m,125,"Total Admin Expenses"IN					
150	FOR<I=JAN,DEC>:CSUM,WC0[1],n,1-j;X,WC0[1],n,1;NEXT					
160	FOR<I=n+1>:LSUM,1,B,Mix,NC[1];NEXT					
170	EDITLINE,n,1,j;IEXPENSE[EXPENSE]=j;IEXPENSE[EXPENSE]I					
180	END					

Photo 2: The spreadsheet shown with the program it automatically generates. Programs in the Laplace interpreter can generate spreadsheets, and use of the spreadsheet generates programs.

OPEN		LIS-WORD				
1	AUG	CONTEXTA	1819	BAR GRAPH	2750.00	
2		CONTEXTB	1820	DATABIOS	5630.20	
3		CONTEXTC	1821	DATAMET	1582.33	
4		WINDOW	1822	DOCUMENT	2500.00	
5			1823	EDIT	625.00	
6	0.00	4000.00	1824	LAPLACE	3000.00	
7	0.00	100000.00	1825	REPORT	3000.00	
8			1826	SPREAD	250.00	
9			1827			
10			1828			
11	0.00	2500.00	1829	(all of the above, to be integrated w/		
12	0.00	2750.00	1830	he SMALL BUSINESS PACKAGE		
13		5630.20	1831	The small business package will i		
14		1582.33	1832	business packages which other micro so		
15	0.00	2500.00	1833	will be integrated on the software bus		
16	5.00	625.00	1834			
17	0.00	3000.00	1835	COMPONENT		
18	0.00	3000.00	1836			
19	0.00	250.00	1837			
20	0.00	850.00	1838			

Photo 5: The spreadsheet and word processor in different windows. The user is preparing to copy the title "SMALL BUSINESS PACKAGE" from the text file at right directly into the spreadsheet at left. Large blocks of text can also be moved.

EDITING		LIS-WORD				
1	AUG	CONTEXTA	1819	BAR GRAPH	2750.00	
2		CONTEXTB	1820	DATABIOS	5630.20	
3		CONTEXTC	1821	DATAMET	1582.33	
4		WINDOW	1822	DOCUMENT	2500.00	
5			1823	EDIT	625.00	
6	0.00	4000.00	1824	LAPLACE	3000.00	
7	0.00	100000.00	1825	REPORT	3000.00	
8			1826	SPREAD	250.00	
9			1827			
10			1828			
11	0.00	2500.00	1829	(all of the above, to be integrated w/		
12	0.00	2750.00	1830	he SMALL BUSINESS PACKAGE		
13		5630.20	1831	The small business package will i		
14		1582.33	1832	business packages which other micro so		
15	0.00	2500.00	1833	will be integrated on the software bus		
16	5.00	625.00	1834			
17	0.00	3000.00	1835	COMPONENT		
18	0.00	3000.00	1836			
19	0.00	250.00	1837			
20	0.00	850.00	1838			

Photo 6: The heading now appears in the spreadsheet.

SEARCH		LIS-WORD				
1	REPLACE	CONTEXTA	1819	BAR GRAPH	2750.00	
2		CONTEXTB	1820	DATABIOS	5630.20	
3		CONTEXTC	1821	DATAMET	1582.33	
4		WINDOW	1822	DOCUMENT	2500.00	
5			1823	EDIT	625.00	
6	0.00	4000.00	1824	LAPLACE	3000.00	
7	0.00	100000.00	1825	REPORT	3000.00	
8			1826	SPREAD	250.00	
9			1827			
10			1828			
11	0.00	2500.00	1829	(all of the above, to be integrated w/		
12	0.00	2750.00	1830	he SMALL BUSINESS PACKAGE		
13		5630.20	1831	The small business package will i		
14		1582.33	1832	business packages which other micro so		
15	0.00	2500.00	1833	will be integrated on the software bus		
16	5.00	625.00	1834			
17	0.00	3000.00	1835	COMPONENT		
18	0.00	3000.00	1836			
19	0.00	250.00	1837			
20	0.00	850.00	1838			

Photo 9: Preparing to do a descending alphabetic sort on a column of words.

SETTINGS		LIS-CALC				
1	TRANSOFT 1984 PROTECTIONS	JAN	FEB	MAR	APR	
2						
3						
4						
5						
6						
7						
8						
9						
10						
11						
12						
13						
14						
15						
16						

Photo 10: A Lisilword window overlapping a Lisicalc window.

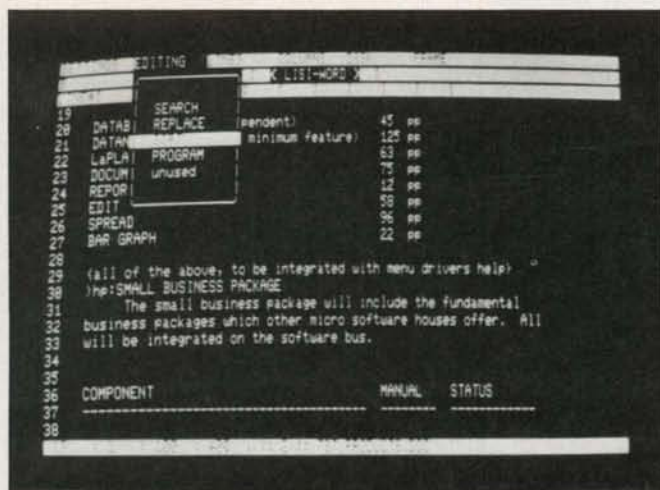

Photo 3: Lisiword, the word processor, preparing to sort a list of numbers in a text file.

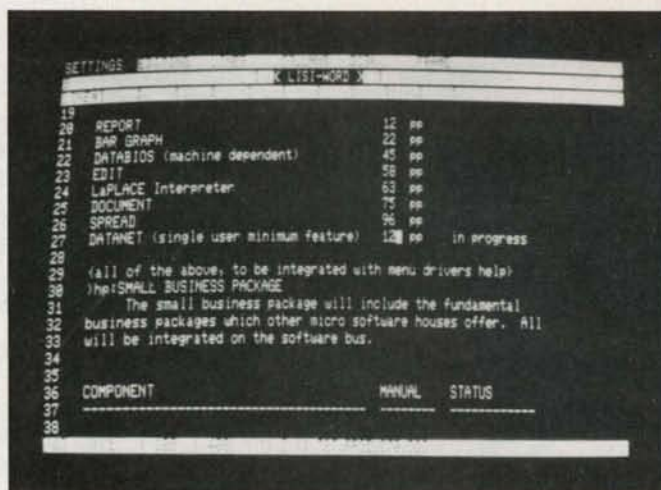

Photo 4: The page numbers in the text file are now in ascending order.

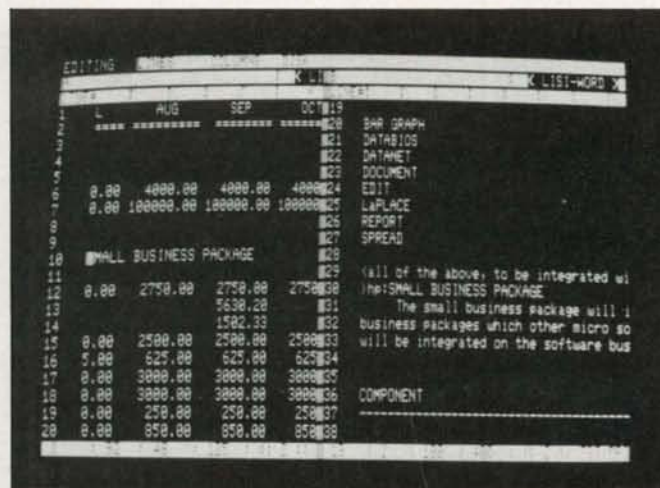

Photo 7: Preparing to copy a column of numbers from the spreadsheet into the text file.

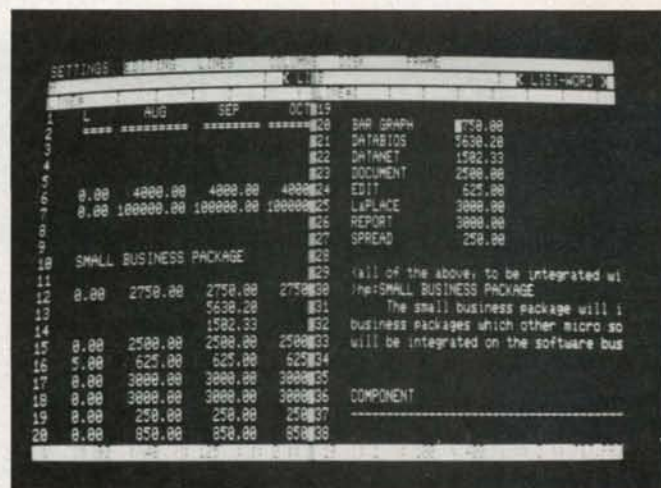

Photo 8: The numbers now appear in the Lisiword text file.

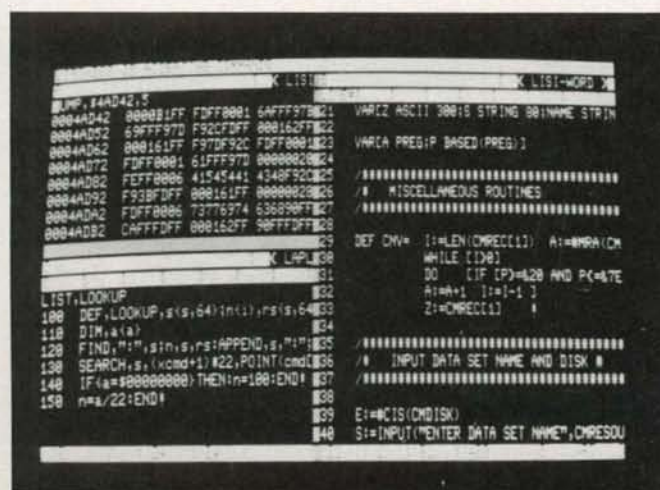

Photo 11: Three Lision windows showing a dump for a machine language file in hexadecimal, a program written in the Laplace interpreter, and a program written in the N compiler.

Lision's database-management system is not quite finished at this writing. When complete, it will include masked screen display, data entry, and creation; automatic report generation and creation of report formats; and impromptu inquiry in an English-like query language.

Lision features a single-line menu at the top of the display for highlighting current user options. Function keys take the place of the mouse for selecting menu options and do not disturb the normal cursor position in the current window. Furthermore, the system features user-programmable function keys (softkeys) to automate menu selections or any other operations.

Lision allows multiple programs to operate simultaneously, each with its own different screen. Windows can be placed anywhere on the display and may be of any size. They may overlap, be side to side, on top of one another, and so on (the desktop metaphor). Data can be transferred from any window into any other.

THE SYSTEM

JOIN NOW AND SAVE!

dBase II™
\$359

(For SYSTEM members only)

WORDSTAR™
\$259

(For SYSTEM members only)

"THE SYSTEM" HAS THE NEW IBM PC JR. SOFTWARE NOW! CALL FOR OUR LOW PRICE

DO YOU QUALIFY to be a member of "the SYSTEM"?

CALL TOLL FREE NOW!...

800-421-4003

In California call 1-800-252-4092



THE PRICE WAR

In every battle, we came up the victors. Not only in price, but in service and support as well.

Call to order: **1-800-257-5217**
(in NJ 609-424-4700)

We carry:

Intertec Data Systems
Corvus Concept
Corvus Hard Disk
C. Itoh Printers



TriStar Data Systems
2 Keystone Avenue
Cherry Hill, NJ 08003
609-424-4700
215-629-1289

WE SERVICE WHAT WE SELL

Using the new software bus tools, the Reason research project created Lision in less than 10 person-weeks. Lision was begun on July 15, 1983, and the first draft of this article was written on September 27, 1983, using Lision.

Summary

Design work on the Reason software bus began on July 1, 1981. Final cleanup on this generation of tools should be completed before you read this article. The bus and Lision are currently operational, although they require beta testing and bug fixes.

The entire Reason software bus was developed in less than 36 engineering person-months. Equipment used in the project comprised two 68000-based desktop computers and an IBM PC system modified by inclusion of a 68000 board manufactured by Analytical Engines Inc. of Austin, Texas.

One favorable compiler timing comparison and one favorable applications development project do not a technology make. Of course, we at the Reason research project are excited about our progress. We have high hopes for the future. However, if software-busing concepts, and the Reason software bus in particular, are to become a factor in future technology, they must remain productive across a number of tests and within a number of different environments.

If they continue to be productive, it's possible that software-busing concepts may form a new software technology with dramatic effects on the software choices of the future.

Because of this possibility, members of the Reason research project, together with other associates, have formed a company called Transoft Corporation to market the products of Reason research. Lision, no doubt under another name, will be one of the company's first products. ■

Michael F. Kornis has been a software engineer for 18 years. He has worked in systems design for IBM, as a DP Manager for Tymshare, and until 1981 was a principal in Computhink (now called Momentum Inc.). A student of mathematics, his primary interest is in artificial-intelligence software. He can be reached at Transoft Corporation, 233 Page St., San Francisco, CA 94117.

PRO-MODEM 1200



It's about time.

Time for your computer to make the telephone connection – with an intelligent, full 212A 300/1200 baud modem – with a real time clock/calendar – and with the capability to expand into a complete telecommunications system. It's time for PRO-MODEM 1200. Much more than just a phone modem.

When you're on-line, time is money. PRO-MODEM telecommunication systems help you save. By monitoring the duration and cost of your phone calls. And by sending and receiving messages, unattended, at preset times when the rates are lower. . . with or without your computer.

Compare the \$495 PRO-MODEM 1200 with any other modem on the market. For example, you'd have to buy both the Hayes Smartmodem 1200 plus their Chronograph for about \$950 to get a modem with time base.

PRO-MODEM 1200 is easy to use. A convenient "Help" command displays the Menu of operating command choices for quick reference whenever there's a question about what to do next. Extensive internal and remote self-diagnostics assure that the system is operating properly. Some of the other standard features include Auto Answer, Touch Tone and Pulse Dialing, and Programmable Intelligent Dialing.

PRO-MODEM does more. It lets you build a full telecommunications system with features like Auto Dialer, Incoming and Outgoing Message Buffering, Business/Personal Phone Directory, Programmable Operating Instructions, a 12-Character Alpha-Numeric Time and Message Display, and versatile PRO-COM Software. PRO-MODEM commands are Hayes compatible so you can use most existing telecommunications software without modification.

There's much more to the PRO-MODEM story. See your local dealer for complete details. He'll show you how to save time. And money.

Prometheus Products, Inc., 45277 Fremont Blvd., Fremont CA 94538, (415) 490-2370



PROMETHEUS

The Texas Instruments Quite simply, the best on the market today

"This is the machine IBM
should have designed.

It is the optimum
personal computer."

Popular Computing
October 83

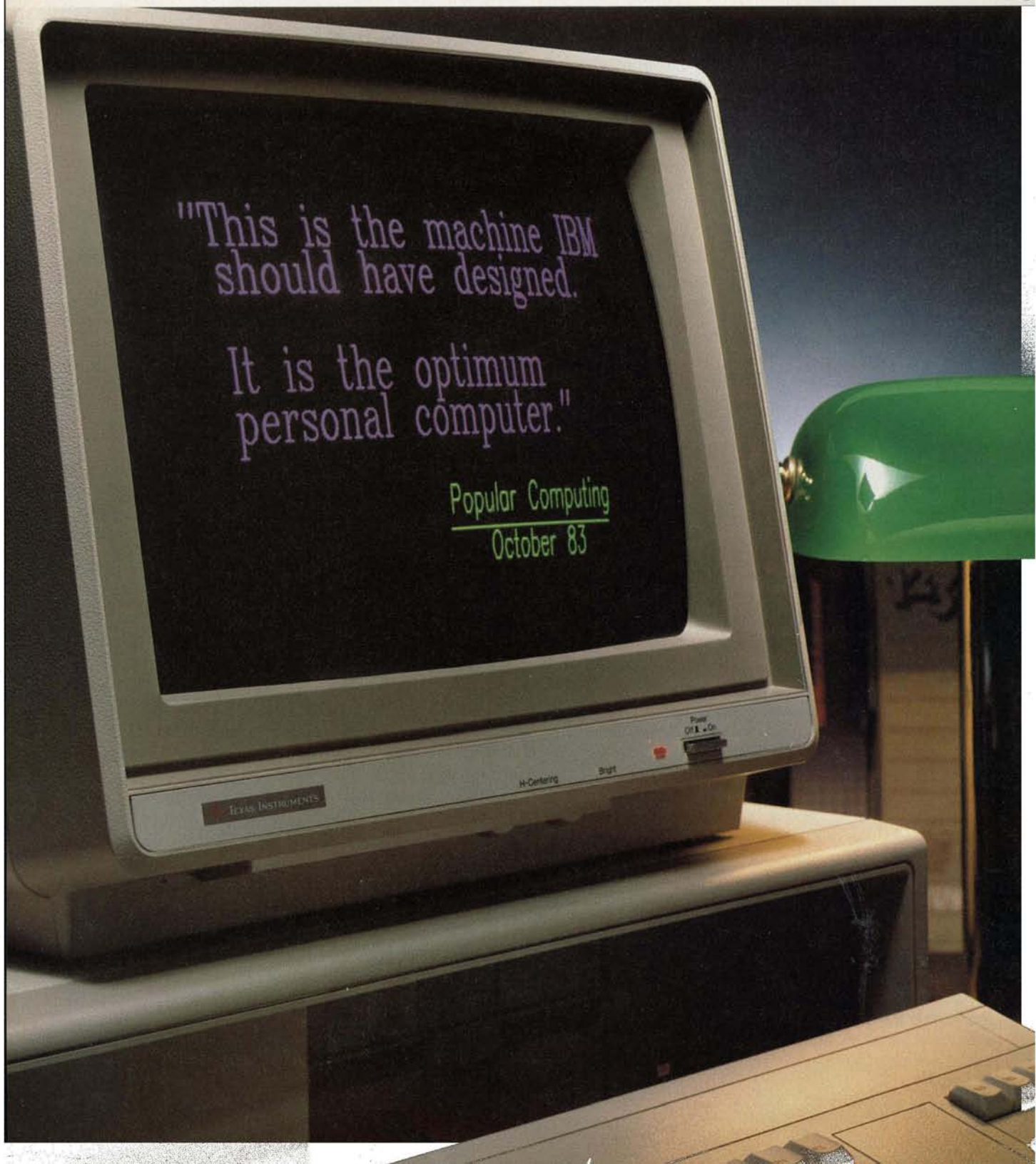

Professional Computer. personal computer And tomorrow.

For your best performance and productivity,
rely on the TI Professional Computer.

Critics have called it "the machine IBM should have designed." And "the optimum personal computer." And thousands of demanding business and professional people have had similar praise for the design, software availability and dependability of the Texas Instruments Professional Computer. Here's why.

Best internal design.

With the TI Professional Computer, you avoid the possibility of computer underbuy or overbuy. Unlike IBM, our standard PC can grow to XT capability — so you don't have to choose between a PC or an XT. If you need more computer after you buy the standard TI Professional Computer, add features like internal memory up to 768K RAM. And internal 10 megabyte Winchester disk. Or other expansion capabilities which you can add using our 5 built-in option slots. So you get more computer without buying a new one.

Best graphics.

Our high resolution monitors give you some of the sharpest displays available, 3-plane graphics and the capability for 8 simultaneous colors or monochrome shades (IBM and Apple give you only 4). Plus, unlike IBM, the same software runs on either the color or monochrome monitor.



Best software available today.

Literally hundreds of third-party software packages are available for the TI Professional Computer. Including the best-sellers like Lotus 1-2-3™. TI and leading third-party software suppliers are committed to developing new programs to help keep your business ahead.



Best keyboard.

Superior design makes this the easiest to use keyboard. You get 12 programmable function keys for faster, easier use. Separate numeric keypad and cursor controls. And isolated edit/delete keys to prevent accidental loss of data.

Best new features for the future.

Come in to a participating dealer today for a demonstration of the TI Professional Computer using our revolutionary speech recognition† capability. Soon you will be able to add the recently announced Speech Command™ option to the TI Professional Computer. This will enable you to operate the computer with simple voice commands. Which lets you work a lot faster and easier.

Best support equipment.

We offer companion equipment like the OMNI 800* Model 850 and 855 printers for reliable hard copy output. And, in early 1984, the EtherLink™ Local Area Network to connect your office workstations. All backed by the TI worldwide network of service and support.

See the TI Professional Computer for yourself. It is, quite simply, the best. Today and tomorrow. Now at participating ComputerLand stores and independent dealers. For the location nearest you, and answers to questions about your computing needs, call 1-800-527-3500.



**TEXAS
INSTRUMENTS**
Creating useful products
and services for you.

* OMNI 800 and Speech Command are trademarks of Texas Instruments Incorporated.
EtherLink is a trademark of 3Com Corporation.
1-2-3 is a trademark of Lotus Corporation.

† Now being demonstrated nationwide. Available early 1984.
Copyright © 1983 Texas Instruments 2773-040PC

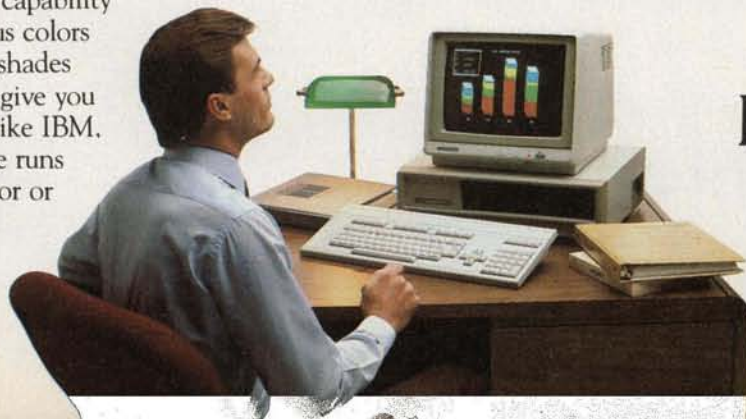

A General-Purpose Robot-Control Language

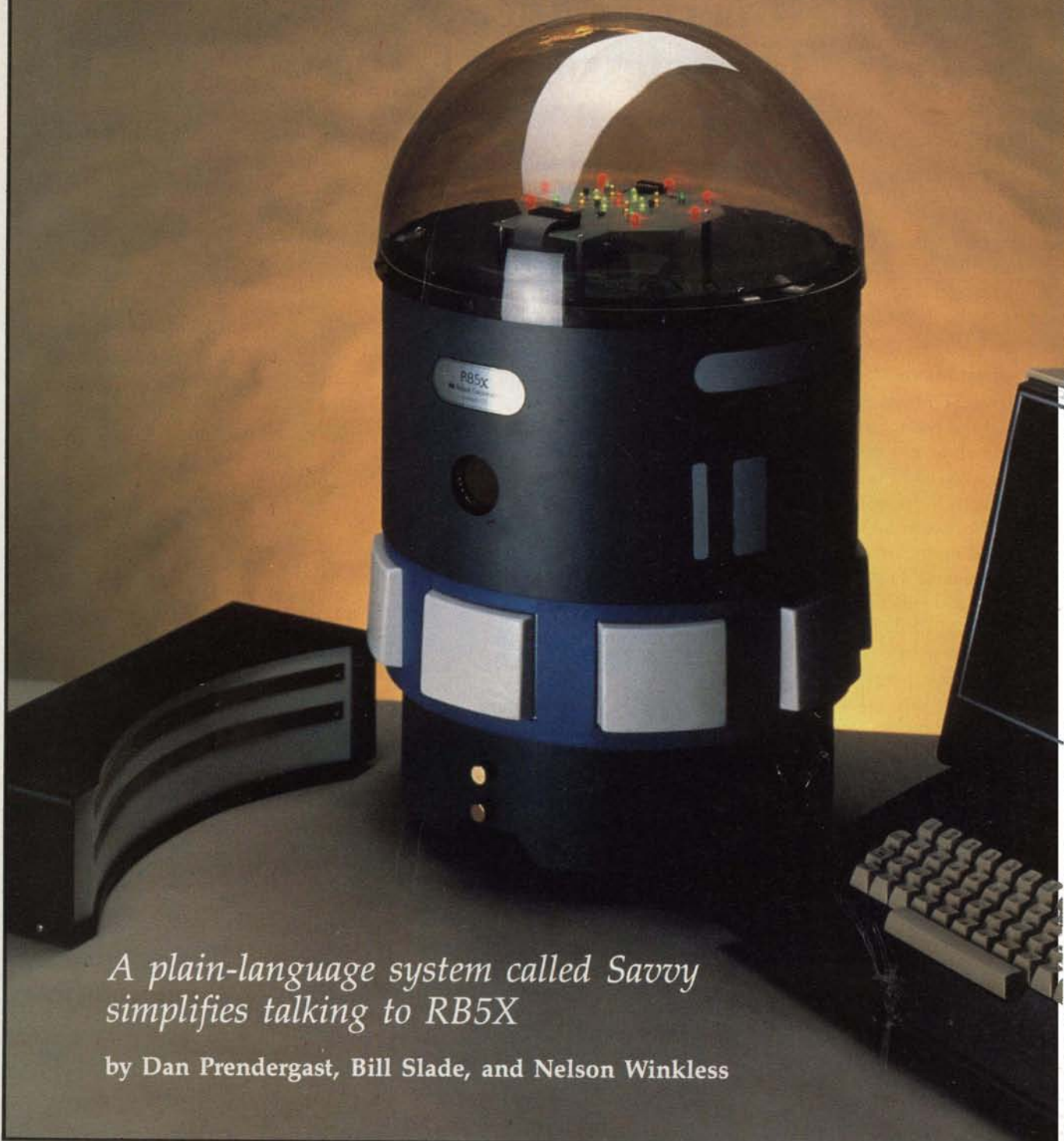

A plain-language system called Savvy simplifies talking to RB5X

by Dan Prendergast, Bill Slade, and Nelson Winkless

RB5X is a little fellow, almost 2½ feet tall. He is cylindrical, available with or without an arm, and has a domed plastic top (see photo 1). With two powered-drive wheels and two casters for balance, he can pivot around his own center point, rotate 360 degrees within his own diameter, and move forward or backward at about 4 inches per second. He's equipped with a ring of bumper switches, a highly directional sonar system capable of sensing remote objects or barriers at distances ranging from 10 inches to 35 feet. Infrared sensors under his body can detect markers on the ground, including a line that guides him to a charger at which he feeds his two sealed lead-acid batteries (see photo 2).

RB5X is a personal robot, the first in a series under development by RB Robot Corporation. RB5X is an example of state-of-the-art personal robots now reaching the market for the first time.

The robot can be fitted with a vacuum cleaner (see photo 3), a trailer, a voice, a compass for navigation, and even a fire detector and extinguisher. With speech-recognition equipment, RB5X can come when called and respond to useful spoken commands.

Notably, the robot is designed for growth. This initial design uses an INS-8073 8-bit processor from National Semiconductor with Tiny BASIC in ROM (read-only memory) and 8000 bytes of RAM (random-access read/write memory) to program control of the robot. Memory can be expanded with another 16,000 bytes of RAM, plus 4K-byte EPROM (erasable programmable ROM) cartridges for prewritten programs. The system motherboard provides several slots for expansion. Options as well as additional plug-ins developed by RB Robot and other companies are all designed to use this bus.

Robots, even more than mass-marketed computers, are expected to com-

municate with people in a convenient and friendly style. RB5X's programming language, Tiny BASIC, has some good features and packs a lot of power in a very small package, but convenience and friendliness with nontechnical strangers cannot be counted among its good features. For example, to sound the robot's horn, it's necessary for a programmer to type an instruction such as `@#7801=#80`. To make the horn stop, a different instruction is needed. This isn't what the average person has in mind for conversation with a robot. When we designed RB5X, we knew that a natural language for control of robots would be essential to their general ac-

**Robots, even more
than mass-marketed
computers, are
expected to
communicate with
people in a convenient
and friendly style.**

ceptance in society. The open question was, "How soon could it be done?"

The first steps were taken with remarkable speed. In June of 1983, the RB Robot staff examined a software system called Savvy developed by Excalibur Technologies Corporation. This system showed that the state of the art in plain-language programming and communication with computers had moved faster than anticipated. Even in its first release, Savvy offered a way to leap almost immediately from communication exclusively in computer code to communication in plain language.

We do not intend to do a full exposition of Savvy in this article. (The Savvy programming language will be reviewed in the February BYTE.) Briefly, the Savvy system integrates a computer operating system, an indefinitely extensible computer lan-

guage, utilities, and applications.

Savvy is integrated with an adaptive pattern-recognition process (APRP) that lets it determine and act upon the *meaning* of imprecise inputs, program names, or instructions. For example, if Savvy has been programmed to recognize the instruction BLOW THE HORN, it will without further training recognize such mistyped or rephrased instructions as BLWO YOUR HRON, BLWO THEH ORN, etc.

Any specified input can be connected in Savvy with any specified output. Thus, the Savvy system can be trained so that if it sees a pattern that seems more like BLOW YOUR HORN than anything else, it should output the instruction `@#7801=#80`. Furthermore, Savvy can learn that HONK and SOUND WARNING SIGNALS and OBLAY DER ORNHAY all mean BLOW YOUR HORN. If you then type SOUND THE HORN, the correct Tiny BASIC code will be emitted.

RB Robot contracted with Excalibur for development of a new robot-control language (RCL) that uses the Savvy system on the Apple II computer. Programs are written in plain language, then automatically cross-compiled into Tiny BASIC code that is downloaded into the robot's computer.

Working in RCL with Savvy, a programmer of RB5X doesn't need to remember whether the command to move forward is `@#7802=#9` or `@#7801=#20`; he simply types MOVE FORWARD. RCL is more than a simple substitution of English words for computer code. The programmer can at any time add to the RCL vocabulary. In fact, the programmer creates a new language in using the system; he not only adds synonyms to the existing commands but creates new commands and extends the language as far as desired.

If the operator writes a routine in RCL that causes the robot to run in a circle, the name of that routine (probably RUN IN CIRCLES or MAKE A CIRCLE) becomes part of the RCL vocabulary. RUN IN CIRCLES becomes a command with

Photo 1: RB5X, a personal robot, standing next to the "charger/nest." When the robot finds the nest, the two metal contacts on the front make contact with the metal strips of the curved surface of the charger and recharge the robot's batteries. (Photos courtesy of RB Robot Corporation.)

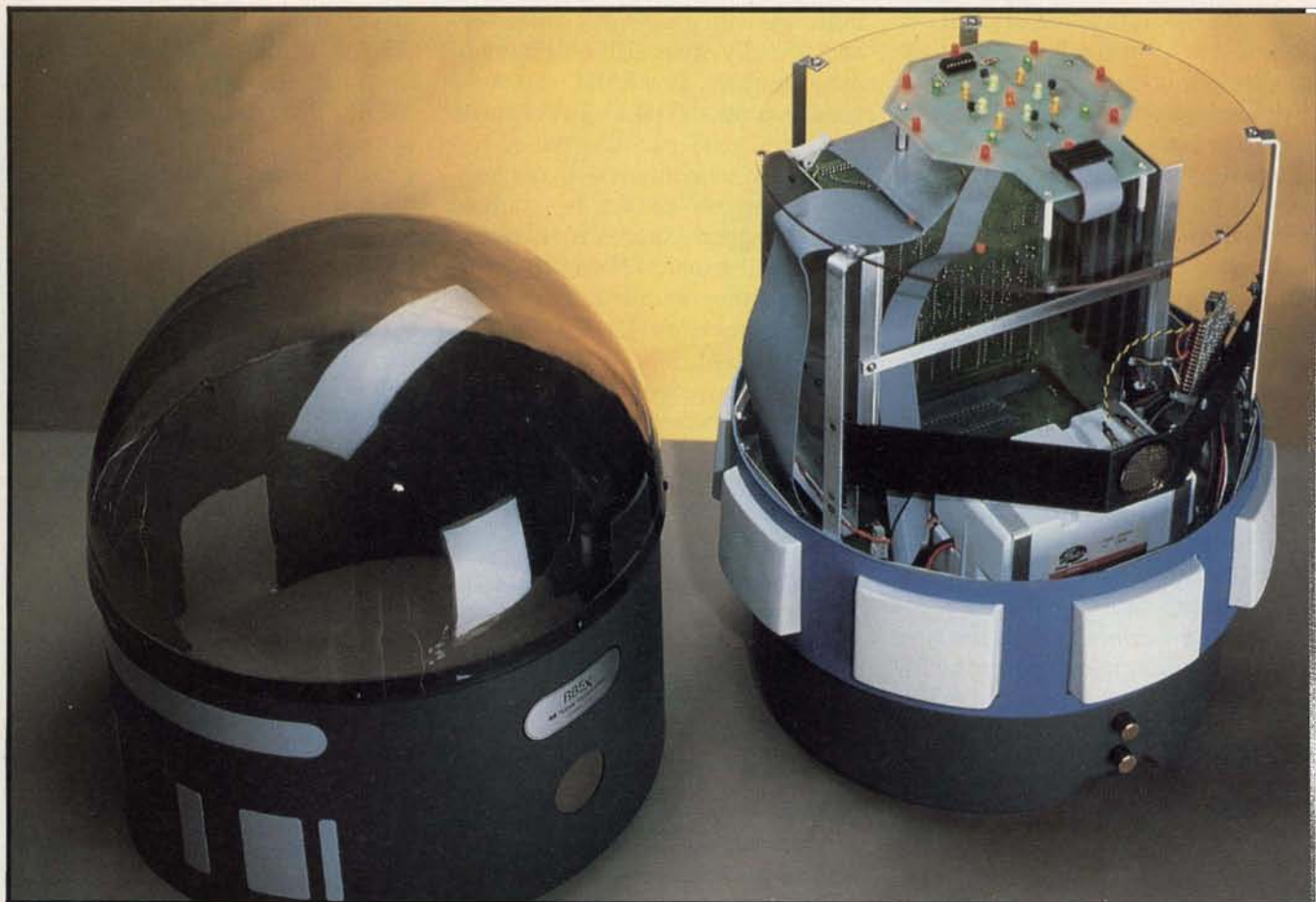

Photo 2: An internal view of RB5X that shows the main circuit board and rechargeable batteries.

as much authority as any Savvy primary-language command like ADD, EDIT, or SAVE. Perhaps the operator wants the robot to do a dance while humming its own tune. The robot may be instructed to MOVE FORWARD, then RUN IN CIRCLES, then MOVE BACKWARD. It is unnecessary to tell the computer to go and find the subroutine called RUN IN CIRCLES, fetch it, and then run it. The name of the routine itself, RUN IN CIRCLES, implies all that, and Savvy does it automatically without requiring detailed instructions.

You can think of Savvy as an automatic programmer that knows all of the details about the computer system. It tells the computer how to accomplish the steps of the task, specifies memory allocation, data types, linking, and blocking. Savvy tells the computer when to open and close files and how to move through the structural hierarchy from one point in the system to another. Savvy

knows more about the internal operations of an Apple or IBM Personal Computer system than most human programmers. It follows the step-by-step instructions of a human programmer to code the program.

Savvy and a programmer must be able to communicate. RCL is the vocabulary created to enable that communication. If any wording choice seems unbearably bad to any RCL user, that person can associate some preferred name with the bad one and use *that*. To each his own.

Skilled programmers, proud of their ability to operate in obscure codes, may choose to give RCL an efficient vocabulary of very short names. You might teach the system that MF means the same as MOVE FORWARD, MB, MOVE BACKWARD, and RIC, RUN IN CIRCLES. Using this kind of technique does not necessarily hide the meaning from newcomers to the code. Savvy interprets each command in terms of its

original, underlying vocabulary. Unless the programmer takes steps to obscure the meaning of the program (which can be done), the program task is ultimately documented by the system in plain text.

The vocabulary is constantly expanding because new fundamental instructions are continuously being added to the system for operation of the arm and hand, sensory systems, and other peripherals. The RCL programmer can add instructions, updating the system at any time, simply by defining the new terms to the system. RCL users will often develop new fundamental instructions that seem useful to them and add them to their own systems. No users group has yet been formed to publish and maintain a dictionary of terms common to all RCL users, though such action would facilitate standardization from system to system.

Developing RCL was essentially a job of writing a compiler as an ap-

plication program in Savvy. The mechanics of the system were determined by the nature of the existing Tiny BASIC software and hardware. The National Semiconductor micro-processor, memory, and supporting circuitry are packaged specifically as a Tiny BASIC engine.

The goal in developing RCL was straightforward: create a plain-language programming environment that will let a user readily create and edit "scripts" to govern a robot's behavior. We did *not* want to limit the effective utilization of all of the hardware features of RB5X, and we wanted to make good use of Tiny BASIC. We aimed to create a flexible, easily extensible set of programming constructs.

The INS-8073 directly supports an RS-232C port through which a terminal can communicate with the Tiny BASIC interpreter/monitor in the RB5X. It was clear that with a correctly functioning robot, we didn't need two-way communication with Tiny BASIC. We could work just one way, downloading a program from the Apple to the robot.

Communications resolved, the next concern was storage of the Tiny BASIC program text. The typical syntax of a BASIC statement is statement numbers and then statement text. Therefore, a program file folder was named SOURCE, which had as its indexing item STATEMENT NUMBER and the two items BASIC TEXT and MEANING. BASIC TEXT is the program statement, and MEANING is a diagnostic and educational remark for the user.

By way of clarification, Savvy terminology, as well as structure, is somewhat different from convention. Savvy uses the word *folder* for what is commonly called a "file," *page* for "record," *item* for "field," and *task* for "program." (Yes, there is debate about this, but we'll not enter it here.)

The folder structure for stored Tiny BASIC text in RCL is:

```
SOURCE (a folder)
1 Id    STATEMENT NUMBER
2 Item  BASIC TEXT
3 Item  MEANING
```

Each robot script is, in fact, a Savvy task and is edited by the Savvy task editor. The "primitive" programming elements of RCL are the kinds of commands we suggested above. For example,

```
GO FORWARD
SPIN RIGHT 90 DEGREES
WAIT this many seconds <1>
TURN ON HORN
SAY this phoneme <1>
```

From these discrete instructions, the Savvy task editor compiles the Tiny BASIC text necessary to accomplish the function specified.

Here is the process for compiling a single line of Tiny BASIC: Increment the current line number to form the STATEMENT NUMBER for this statement, copy the appropriate piece of text to the BASIC TEXT, copy any meaningful text description to the MEANING, and then save this page of data in the SOURCE folder. Two tasks have been written to accomplish this compilation:

```
INCREMENT STATEMENT
NUMBER (a task)
```

```
1 Does ADD the STATEMENT
NUMBER and STATEMENT
NUMBER INCREMENT VALUE
2 and COPY from SUM to
STATEMENT NUMBER
3 and END
```

```
COMPILE the BASIC statement
<1> which means <2>
(a function)
```

```
1 Does INCREMENT STATE-
MENT NUMBER
2 and COPY from (1) to BASIC
TEXT
3 and COPY from (2) to
MEANING
4 and SAVE new page in
SOURCE
5 and END
```

With these two tasks, it's easy to write one-liners to compile a statement. Some RCL primitives are very simple. For example, STOP ALL MOTION (a task) does a COMPILE of the BASIC statement @#7802=#0 (which means STOP ALL MOTION). In another example, the primitive WAIT goes through logic to determine if a specified waiting period is shorter than one second. (In many

Text continued on page 130



Photo 3: RB5X with an optional vacuum-cleaner attachment.

"I've got a big problem keeping sales leads organized."



"Not me. I've got marketing management software from JEB."

With MMS microcomputer software, you can keep track of prospects and effectively organize follow-up of every one.

You can rapidly send sales leads to the field. Then generate reports to analyze their value. Produce direct mail lists, labels ... and more. JEB gives you an efficient way to increase your company's sales and profitability. And you can do all this for only \$595.

The Marketing Management System (MMS) software package is ready to run on CP/M, PC-DOS and MS-DOS microcomputers and can be adapted for minicomputers. And with JEB, you can rely on our assistance to help modify the program to meet your specific needs. Our MMS program gives you the efficient marketing management you demand.

I want to know how JEB can help me.

- Please send more information.
 Please have a salesperson call.

Name _____

Title _____

Company _____

Address _____

City _____ State _____

Zip _____ Phone (____) _____

JEB Systems, Inc.

57 Main Street, P.O. Box 70
 Franconia, N.H. 03580
 (603) 823-5587/7021

JEB 3

Listing 1: The Charger Finder routine written in RCL with Savvy. The program instructs the robot to search for a metal tape on the floor and follow that tape to the "charger/nest."

```

1 RESET THE ROBOT
2 INITIALIZE MEMORY
3 BEGIN A REPEATING PROCEDURE
4 INITIALIZE MESSAGES
5 CLEAR ALL VARIABLES
6 BEGIN A REPEATING PROCEDURE
7 GO FORWARD
8 LEAVE IF ANY BUMPER TOUCHED
9 DOES THE variable R compare = to ZERO
10 LEAVE THIS REPEATING PROCEDURE
11 END TEST
12 REPEAT THIS REPEATING PROCEDURE
13 LEAVE IF TAPE IS SENSED
14 MOVE WITH BETA INTELLIGENCE
15 REPEAT THIS REPEATING PROCEDURE
16 FOLLOW TAPE
17 MAINTAIN CHARGE
    
```

Listing 2: The Charger Finder routine compiled into Tiny BASIC code. This program is transferred from the Apple II computer into the RB5X's on-board computer.

Tiny BASIC Text	Meaning of Text
10 T = 10	Number of whole seconds
20 GOSUB 1000	Go wait
30 T = 10	Number of whole seconds
40 GOSUB 1000	Go wait
50 @#7803 = #98	Initialize I/O
60 N = TOP	Initialize experience block
70 O = TOP + #FF	Initialize inhibition block
80 M = TOP + #200	
90 FOR P = N TO M	
100 @P = #FF	
110 NEXT P	
120 REM START A LOOP	Begin A Loop
130 @#7803 = #98	Initialize I/O
140 CLEAR	Clear variables
150 REM START A LOOP	Begin A Loop
160 @#7802 = #09	Go forward
170 Y = @#7800	Test for bumper contact
180 IF Y < 255 GOTO 230	Exit if any contact
190 IF R < 0 GOTO 210	Make a comparison
200 GOTO 230	Exit this Loop
210 REM END HERE	Fall through to here
220 GOTO 150	Repeat this Loop
230 REM EXIT TO HERE	
240 X = #02	Turn on LED 1
250 GOSUB 1100	Go turn on a bit
260 R = @#7802 AND #40	Test for tape sense
270 IF R = 0 GOTO 310	Exit if tape sensed
280 GOSUB 2000	Go to Beta Subroutine
290 REM RETURN GOES HERE	Return to here
300 GOTO 120	Repeat this Loop
310 REM EXIT TO HERE	
320 REM START A LOOP	Begin A Loop
330 @#7803 = #98	Initialize I/O
340 CLEAR	Clear variables
350 REM START A LOOP	Begin A Loop
360 @#7802 = #08	Right forward
370 X = #02	Turn on LED 1
380 GOSUB 1100	Go turn on a bit
390 R = @#7802 AND #40	Test for tape sense
400 IF R = 0 GOTO 440	Exit if tape sensed
410 Q = @#7802 AND #20	Test for charger contact
420 IF Q = 0 GOTO 440	Exit if charger sensed

Listing 2 continued on page 128

NOW 256K

SORRY CHARLIE!

If you just bought a 16-bit 8088 computer with a 160K drive, 256K RAM, Ramdisk and spooler software, MS-DOS, Wordstar, CalcStar, EZ Writer, Color graphics BASIC and a printer port, you're going to be sorry when you read this ad. Why? Because Scottsdale Systems will give you all this for \$1099.

The color graphics board built-in to the PC-Plus™ generates a resolution of 640x400 dots in monochrome, and generates 8 colors. The circuit board is presocketed for 256K, and an 8087 chip, and is warranted for a full year by 50 Sanyo Service Centers.

The PC-Plus will run many programs written for the IBM-PC®, yet costs less than one-third as much. Due to the huge demand for the PC-Plus you may have to wait, but give us a call for more information. Better safe than sorry!



PC PLUS™ \$1099
 PC DELUXE™ Call

TELEVIDEO



Single user systems now backed nationwide by Xerox. Single user systems now include Word processing, spreadsheet and graphics software (along with CP/M or CP/M-86). Local installation of multi-user systems available via TRW.

TPC	Call
803	\$1849
1603	\$2289
802H	\$4319
806/20 mb.	\$4859
816/40 mb.	\$9275

ALTOS

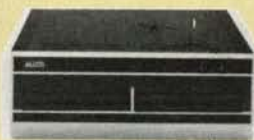

From the lowest-priced dual-floppy multi-user systems to true 16-bit 10 Mhz. multi user systems. Local service available via TRW. We will configure, test and install your systems for an additional charge (call for prices).

5-80-2	\$1998
5-80-10	\$3629
5-86-10	\$5795
5-86-40	\$7995
8000-10	\$4679
8000-14	\$8118

SANYO



Our best selling Z-80 system just went down in price. Each system includes, dual drives, CP/M®, Sanyo Basic, Wordstar™, MailMerge, Spellstar, Calcstar, InfoStar, a games disk, and 2 boxes of disks. Nationwide service.

Sanyo 1150 (640K)	Call
Sanyo 1160 (1.2mb)	Call
Sanyo 1250	Call

COLUMBIA



Each Columbia now comes with MS-DOS, CP/M-86, Basic (with IBM-PC® compatible color graphics), Perfect Writer™, Perfect Speller™, Perfect Calc™, Perfect Filer™, Fast Graphs, Home Acc't Plus, Space Commanders, Diagnostics, and The Columbia Tutor. The VP is 38 lbs. portable with a built-in 9" monitor. The 1601 is the desktop unit. Both computers come with dual 320K drives, and are backed by Bell and Howell.

VP	\$2349
1601	\$2479
1600-4 (10mb)	\$3545

TERMINALS



Adds Viewpoint 3A+ Emulates the ADM-3A, detached keyboard, keypad, 12" green display, nationwide Adds service.

Viewpoint 60	\$589
Wyse 50	\$508
Wyse 100	\$694
Televideo 914	Call
Televideo 924	\$689
Televideo 970	\$1044
Altos II	\$724
Zenith Z-29	\$656
Zenith ZT-1	\$469
Qume 102	\$544

HOUSTON INSTRUMENTS

DMP-29	\$1795
DMP-40	\$745
DMP-41	\$2340

ZENITH Z110

\$2699



Scottsdale Systems Ltd.

617 N. Scottsdale Road, Suite B, Scottsdale, Arizona 85257

(602) 941-5856

Call 8-5 Mon.-Fri.



We participate in arbitration for business and consumers through the Better Business Bureau of Maricopa County.

SERVICE/ORDERING

INTEGRATION: Prices listed are for new equipment in factory sealed boxes with manufacturer's warranty. We will pretest your equipment, integrate your system, configure your software, provide special cables, etc., for an additional charge. Call for prices.

ORDERING: MAIL ORDER ONLY. Prices listed are for cash. No C.O.D.'s. We sell on a Net 30 basis to Fortune 1000 companies and Universities with good credit. P.O.'s add 2%, charge cards add 3%. Az. residents add 6%. Prices subject to change, product subject to availability. Personal checks take 3 weeks to clear. 0-20% restocking fee for returned merchandise. Shipping extra - products are F.O.B. point of shipment. CP/M and MP/M are registered trademarks of Digital Research. Wordstar is a registered trademark of MicroPro International. IBM and IBM PC are registered trademarks of International Business Machines Corporation. TeleVideo® is a registered trademark of TeleVideo Systems, Inc.™ SOFTWARE: Sold only w/systems, not warranted for suitability.

PRINTERS



Gemini 10X	\$115 off
Gemini 15, 15X	Call
Delta 10's	Call
Epson	Call
Tally 160L/trac	\$584
Tally 180L/trac	\$799
Tally Spirit	\$298
Anadex	Call
IDS Prisms	Call



LETTER QUALITY

Silver Reed 500	\$409
Silver Reed 550	\$654
Sanyo PR5500	Less
Silver Reed 770	Call
NEC 7710	\$1965
NEC 2000's	Call

OKIDATA



The new Microline 92's and 93's feature 160 C.P.S. draft mode, 40 C.P.S. correspondence mode. Standard parallel, serial card add \$91.

Microline 92	\$175 off
Microline 93	\$290 off
Microline 82	\$134 off
Pacemark 235OP	Call

DTC-380Z

Replaces the Daisywriter 2000. Uses the same printwheel, ribbons, and tractor feed. Will run serial, parallel, or IEEE 488. 48K buffer standard, uses Diablo codes.

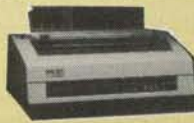

\$1044

Tiny BASIC Text	Meaning of Text	Tiny BASIC Text	Meaning of Text
430 GOTO 350	Repeat this Loop	740 T = T + 1	Math function
440 REM EXIT TO HERE		750 @ #7802 = #09	Go forward
450 Q = @ #7802 AND #20	Test for charger contact	760 R = @ #7802 AND #40	Test for tape sense
460 IF Q = 0 GOTO 800	Exit if charger sensed	770 UNTIL (R <> 0) OR (T > = 100)	Check exit conditions
470 X = #40	Turn on flashing lights	780 DELAY 100	Short wait
480 GOSUB 1100	Go turn on a bit	790 GOTO 320	Repeat this Loop
490 T = 0	Initialize	800 REM EXIT TO HERE	
500 DO	Do the following	810 GOSUB 2310	Charge maintain routine
510 T = T + 1	Math function	1000 FOR S = 1 TO T	Wait T seconds subroutine
520 @ #7802 = #09	Go forward	1005 DELAY 1000	
530 R = @ #7802 AND #40	Test for tape sense	1010 NEXT S	
540 UNTIL (R <> 0) OR (T > = 100)	Check exit conditions	1015 RETURN	
550 DELAY 100	Short wait	1100 U = @ #7801	Turn on a bit @ #7801
560 @ #7803 = #98	Initialize I/O	1105 U = U OR X	
570 CLEAR	Clear variables	1110 @ #7801 = U	
580 REM START A LOOP	Begin A Loop	1115 RETURN	
590 @ #7802 = #01	Left forward	1120 U = @ #7801	Turn off a bit @ #7801
600 X = #02	Turn on LED 1	1125 U = U AND X	
610 GOSUB 1100	Go turn on a bit	1130 @ #7801 = U	
620 R = @ #7802 AND #40	Test for tape sense	1135 RETURN	
630 IF R = 0 GOTO 670	Exit if tape sensed	2000 P = @ #7800	Bumper pressed
640 Q = @ #7802 AND #20	Test for charger contact	2010 IF P = 255 THEN P = 251	Sonar treated as bumper #1
650 IF Q = 0 GOTO 670	Exit if charger sensed	2020 V = @ (N + P)	Check experience block
660 GOTO 580	Repeat this Loop	2030 IF V <> #FF GOTO 2100	Try action
670 REM EXIT TO HERE		2040 V = RND(1,14)	Pick random action
680 Q = @ #7802 AND #20	Test for charger contact	2050 IF (V = 3) OR (V = 12) OR (V = (0 + P))	Pick another
690 IF Q = 0 GOTO 800	Exit if charger sensed	2100 @ #7802 = V	Try action
700 X = #40	Turn on flashing lights	2110 T = 2	Number of whole seconds
710 GOSUB 1100	Go turn on a bit	2120 GOSUB 1000	Go wait
720 T = 0	Initialize	2130 D = 200	Cancel sonar test
730 DO	Do the following	2140 IF (@ #7800 <> #FF) OR (D < 95) GOT	Not successful
		2150 @ (N + P) = V	Successful
		2160 CLEAR	Clear variables
		2170 GOTO 290	Back to main program
		2200 @ (0 + P) = V	Not successful
		2210 GOTO 2040	
		2310 REM START A LOOP	Begin A Loop
		2320 REM START A LOOP	Begin A Loop
		2330 Q = @ #7802 AND #20	Test for charger contact
		2340 IF Q = 0 GOTO 2560	Exit if charger sensed
		2350 P = 0	Initialize
		2360 REM START A LOOP	Begin A Loop
		2370 P = P + 1	Increment Loop count
		2380 @ #7802 = #09	Go forward
		2390 DELAY 100	Short wait
		2400 @ #7802 = 0	Stop all motion
		2410 Q = @ #7802 AND #20	Test for charger contact
		2420 IF Q = 0 GOTO 2540	Exit if charger sensed
		2430 IF P <> 5 GOTO 2520	Make a comparison
		2440 @ #7802 = #06	Reverse
		2450 DELAY 1000	Short wait
		2460 @ #7802 = #09	Go forward
		2470 T = 1	Number of whole seconds
		2480 GOSUB 1000	Go wait
		2490 DELAY 100	Milliseconds to wait
		2500 @ #7802 = 0	Stop all motion
		2510 P = 0	Initialize
		2520 REM END HERE	Fall through to here
		2530 GOTO 2360	Repeat this Loop
		2540 REM EXIT TO HERE	
		2550 GOTO 2320	Repeat this Loop
		2560 REM EXIT TO HERE	
		2570 X = #04	Turn on LED 2
		2580 GOSUB 1100	Go turn on a bit
		2590 DELAY 1000	Short wait
		2600 @ #7803 = #98	Initialize I/O
		2610 GOTO 2310	Repeat this Loop
		2620 REM EXIT TO HERE	

WATCHMAKER CNC

PERSONAL COMPUTER-CONTROLLED
LATHE WITH FULL CNC CAPABILITY

\$2500.



Compatible with your own APPLE II, IBM PC, DEC.

- Turn steel, aluminum, brass, plastic
- Create prototypes and replacement parts to perfect fit
- Make one or a thousand perfect turnings
- Update and automate your small machining operations
- Fully train new CNC operators

Precision is ± .0001". Swing over bed is 1.5", with 8" between centers. Ball bearing spindle and precision gib slides give reproducibility to .00025".

Program the lathe in conventional CNC code, with linear and circular interpolation and store up to 200 different patterns on one diskette. With any popular personal computer, you can get:

LATHE AUTOMATION FOR \$2500.

LIGHT MACHINES CORPORATION

649 East Industrial Drive, Manchester, NH 03103 (603) 625-8600

END OF PROGRAM

1000 FLOPPY DISKS

VS. THE BANK.™



Savings you can take to the bank: 200 MB only \$2,195. CORVUS is proud to introduce the BANK.

It's the most dramatic breakthrough in low cost, high capacity mass memory systems since CORVUS introduced the Winchester disk for microcomputers in 1979.

The BANK's removable tape cartridges hold up to 200 megabytes of information. That's equal to 1000 double density floppies or 10 times the capacity of the largest hard

disks commonly available for microcomputers. You can use the BANK to complement a Winchester disk. It has 19 times the capacity.

And the BANK's cartridges are removable for unlimited capacity and storage.

On-line archival back-up you can bank on. You can use the BANK as a random access archival device. If your Winchester disk fails, you can restore selected volumes without having to restore the entire

contents of the hard disk.

The BANK is the perfect solution to your back-up storage problems as a shared storage device on OMNINET™—the leading Local Area Network for microcomputers.

Call CORVUS for the name of the dealer nearest you. We're sure you'll smile... all the way to the bank.

For more information contact: CORVUS SYSTEMS, 2100 Corvus Drive, San Jose, CA 95124, 1-800-4-CORVUS.

CORVUS

THE NETWORKING COMPANY.

The BANK connects to various brands of computers using OMNINET Local Area Network TRANSPORTER™ interface cards. The BANK is currently available for the CORVUS CONCEPT™ and the IBM PC™. CORVUS, THE NETWORKING COMPANY, the BANK, OMNINET, CORVUS CONCEPT and TRANSPORTER are trademarks of CORVUS SYSTEMS, INC. IBM and IBM PC are trademarks of International Business Machines.

'Rover, Fetch a Dozen #9 Ratchets'

by Nelson Winkless

Personal robots have come a long way technically in the last few years. Advances in digital electronics have made it practical to build compact sensory, information-processing, and control systems that can ride in self-powered carts that aren't too large or heavy. The laboratory curiosities that have been rolling around research institutions and a few home workshops have become today's affordable "personal robots," loaded with potential. But potential for what?

A case has been made for using robots as household pets. They can be companions, health monitors, entertainers, communicators, and protectors, given a lot of hardware and software development that robot enthusiasts now are beginning to provide in increasing quantity. Pets are highly valued in our society, and the reasons for keeping dogs and cats around the house apply as well to keeping robots around the house. The discussion of pets is worthwhile, but let us not dwell on it here.

Our society prizes things that are specifically useful. Robots will fare well if they do useful work for people. Personal computers now do work for people, and businesses have no trouble finding excuses to buy them. Individuals have more difficulty finding excuses; games are a weak excuse, keeping personal accounts is fairly feeble, but word processing is pretty good. Robots offer even fewer practical excuses for their purchase, but their potential in the long run exceeds that of personal com-

puters.

Just as the definition of the "personal" computer remains cloudy, the definition of "personal" robot is shrouded in uncertainty. Indeed, while we have pretty well agreed on what a computer is, we have by no means agreed on what a robot is, so the definition of a personal robot is doubly obscure. Without pretending to settle matters, I've come up with some guidelines for distinguishing personal from nonpersonal robots. But first we must talk about computers.

Before personal computers came among us, we had only institutional computers. They were owned by government agencies, large businesses, and other organizations. The work produced by the institutional computer is looked upon as the work of the organization. The personal computer, however, is looked upon as the implement of an individual. That person uses the computer as if it were a pencil, a pocket calculator, or a telephone. The individual, not the organization, is responsible for the work produced by that personal instrument, even when the individual is operating in an institutional setting. There's no ceremony involved in using the personal computer, no labored allocation of resources, no meetings, no sign-offs (that is, after the initial effort to get the computer). The individual uses the machine as casually as a pad of paper and is fully responsible for what is produced.

The institutional robot is typically part

of a production system. The machine's work can be changed by changing its program, but it is used as part of a larger scheme, worked out and administered by an organization. The personal robot will be identified with an individual who is responsible for its actions, misbehavior, and good deeds. The individual will get credit and blame for its performance, as does the user of an Apple. (Am I my robot's keeper? Yes.)

Personal robots represent the convergence of two lines of technical development—automobiles (in the sense of "self-moving" systems) and computers. You might think of personal robots as mobile machines to which we are now finally adding flexible automatic guidance and control systems. You might think of robots primarily as computers that can move around. You might also think of them as artificial animals, neither vehicles nor information handlers but self-serving systems that interact with their environment in a way that enables their own survival; in essence, a new class of machine.

What practical excuse can we find for getting acquainted with personal robots? Well, let's go back to "automation."

Technologists have been working on factory automation for a long time and making good headway. The automated office began with word processors, communications equipment, personal computers, etc. Office automation has been most effective in small enterprises, where one personal

Text continued from page 125:

robot scripts, RB5X is instructed to wait for a specified period of time before going on to the next action.) If the period is shorter than one second, RCL computes a "DELAY *nnn*," where *nnn* is in milliseconds. Otherwise, it calls an integer second delay subroutine and, if necessary, compiles a DELAY for any fractional period.

This is the general model for implementing primitives of RCL. Of course, many primitives are provided to the RCL user, so the casual robot user needn't get down to that level. The next higher level of RCL primitive is exemplified by:

HONK the horn for this many seconds <1>

1 Does TURN ON HORN

2 and WAIT this many seconds <1>

3 and TURN OFF HORN

4 and END

Again, we are not attempting here to provide a complete explanation of Savvy. We're merely showing the approach to using Savvy in RCL to compile Tiny BASIC. Let us reiterate that the casual RCL user never sees

the compiled Tiny BASIC code unless by choice. Indeed, he never has to see the comparatively plain-language Savvy tasks. The whole point of RCL is to give the robot operator a simple means for telling RB5X what to do. The mechanism outlined above does that.

By way of demonstration, the 17-line RCL routine in listing 1 compiles the 262-line Tiny BASIC routine in listing 2. RCL with Savvy is new and will clearly never be "complete," but it serves its immediate purposes well, and RB Robot is developing applications programs in RCL to put RB5X through a lot of paces.

computer, such as an Apple, serves many functions: production scheduling, word processing, bookkeeping, inventory control, mailing-list management, and so forth.

In the shop or office, the personal robot can become a strange combination of uncomplaining menial and brilliant informant. Imagine a scenario along these lines: You're running a small assembly plant. Ten or 15 workers take components, assemble them into your products, package them, and ship them to customers. The business is not very complicated, but it depends upon alertness, responsiveness, quality control, and a smooth flow of production. You add a robot to the staff. Give it a name, something neutral to avoid social conflict. Call this machine "Rover."

Rover learns the layout of the shop, the schedules, the identities of other employees, the social hierarchy, the protocols (who gets out of whose way), and the rhythm of the place.

People tend to drop small components. In many cases, it's cheaper to toss out the dropped stuff rather than collect and re-sort it. Rover, however, can wander around, pick the pieces up, and put them away without any stir. This saves material, breaks in the routine, dignity, and possibly the job of an otherwise good employee who is having a spell of dropping things.

"Hey, Rover, bring me a dozen #9 ratchets." Rover can. "Rover, take this up to Norma in the front office and come right back." Rover will. "Rover, let's take inven-

tory." And at this point, the robot can do some things that people can't do. Not only should Rover be able to trail around after you, counting things, holding things, and recording information; Rover should have the complete inventory system in mind and be able to comment on discrepancies, looming shortages, and changes in rates of use. Indeed, Rover should have free access to the inventory and order information handled by the computer in the front office. Rover should know which orders are in the works, which items are back-ordered, and which are in oversupply. Rover should have, and he should be able to communicate, all of the complex detail that the shop manager cannot practically keep in mind. Also, Rover should be perfectly willing to sit up all night with the inventory chores, sorting, counting, tidying, and making burglars nervous.

"Rover, get the phone." The robot should be able to handle calls at least as well as the average answering machine, and might even select among callers. ("If Mr. XYZ calls, let me know at once.") Furthermore, Rover can carry the phone to you.

"Rover, I want to send a letter." Rover should be able to plug in the keyboard and the display for word processing and have them ready when and where you want them.

"Rover, has ABC Products ever bought a Model Six from us?" The robot can be a good database manager, offering state-of-the-art facilities in Natural Query Lan-

guage for communicating with you. Indeed, the robot can be loaded with information and manipulate it on the spot if a keyboard and display are available.

Rover becomes a useful hand around the place, learning to do whatever is appropriate at the moment and remembering how to do that same job again later. With experience, Rover grows increasingly valuable.

With the personal robots currently available, how practical is this scenario? Not very. Some of Rover's activities can be done by commercial personal robots right now. But how practical was an MITS Altair computer with octal switch input, 4K bytes of memory, cassette storage, and no BASIC? Not very. A few years of serious effort were needed to shape personal computers into generally useful devices.

The same kind of effort will make personal robots handy. We've come a long way already. The availability of a plain-language control system brings Rover-like performance closer to reality. Memory is getting cheap, speech recognition and synthesis are operating at a useful level, sensory systems can be integrated nicely, and some clever mechanical systems exist.

You may want to tell your personal robot to fetch the paper and do those entertaining things around the house that we consider suitable activity for personal robots. You may also want to tell it to knock out a day's useful work in the shop.

The robots are willing; we have to learn how to tell them what we want.

Summary

RCL and Savvy mark an improvement over Tiny BASIC coding, of course, but an improvement on Tiny BASIC alone is a modest goal. The programmer (and the robot) are still dependent on programming generated on an external computer and downloaded to the robot. Obviously, RB5X needs more brains aboard, and a card is in development that will enable programming in RCL internally in RB5X. Also, sensory input patterns can be learned by a Savvy system and associated with appropriate responses. RCL will become more comprehensive with

time and experience, and the system can be extended in many directions.

This has important implications for robotics. One intriguing thing about RCL is that it could work from the same plain-language instructions to compile programs in any language—FORTRAN, assembly language, whatever the object machine wants to hear. An enriched RCL vocabulary could control milling machines and steel mills as well as RB5X and his brethren. RCL with Savvy in its first release is powerful. It seems capable of becoming a general-purpose robot language that can keep up with the state of the art. ■

Dan Prendergast is vice-president of research and development at RB Robot Corporation, Bill Slade is operating-systems manager at Excalibur Technologies Corporation, and Nelson Winkless is president of ABQ Communications Corporation (Box 1432, Corrales, NM 87048) and coauthor of *Robotics on Your Doorstep*.

The RB5X robot is manufactured by RB Robot Corporation, Suite 310, 18301 West 10th Ave., Golden, CO 80401, (303) 279-5525.

The Savvy Programming Language is published by Excalibur Technologies Corporation, POB 26448, Albuquerque, NM 87125, (505) 242-3333.

BY THE COURT

YU DORONIN

AND JOHN

DOUGLAS

JUSTICE



PRESENTING THE NO-RISK DISK. SM

Play it again. And again. And again.

No matter how many times you play it, the TDK No-Risk Disk SM won't drop a letter. A word. Not even a bit.

We guarantee it.

And not for 1 year. Or 5 years. But with a lifetime replacement warranty for as long as you own the disk.

Our confidence is the result of almost 50 years' research and development of TDK magnetic components and recording products.

From that, we've been able to produce special surfaces and coatings that cut the effects of wear on a disk.

Which means you can store all your valuable documents, time-honored information and one-of-a-kind thoughts on a TDK disk.

And know it will not fail you.

So the next time you want to store important information, put it on TDK.

You've got nothing to lose.

 **TDK**®

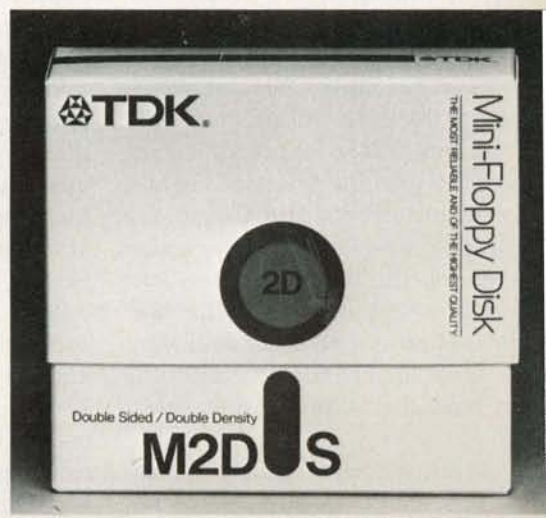

TDK offers a complete line of the most popular disks in 5¼- and 8-inch formats.

1984, the Year of the 32-bit Microprocessor

Technological evolution continues at breakneck speed with the coming of the supermicroprocessor

by **Richard Mateosian**

By the end of 1984, we'll have seen 32-bit microprocessors manufactured by Data General Corporation (DG), Digital Equipment Corporation (DEC), Hewlett-Packard (HP), Inmos, Intel, Motorola, National Semiconductor, NCR, Western Electric, and Zilog. In this article, I'll look at what 32-bit microprocessors are and what they're going to be used for. Then I'll look at certain details available about the chips.

First, let's define our terms. A 32-bit microprocessor has a full 32-bit architecture, a full 32-bit implementation, and a 32-bit data path (bus) to memory. Because this definition is terse, some explanation and examples are in order.

Architecture. What is a microprocessor's architecture? The term means different things to different people but, for this article, let's call it the interface between the programmer and the machine. Architecture defines the set of accessible registers, the memory model, the instruction set, and the addressing modes of the machines. In order to qualify as having a full 32-bit architecture, the machine must have the following features:

1. Data and address registers that are 32 bits wide.

2. An instruction set that fully supports 32-bit data types.
3. Indexes and other address modifiers used in the machine's addressing modes that have 32-bit representations.

Now, I don't mean to quibble about a few bits here and there. For example, the DEC VAX, generally acknowledged to have a 32-bit architecture, devotes the uppermost bits of addresses to special purposes; the actual address fields are smaller than 32 bits wide. Furthermore, many 32-bit architectures provide for compact forms of addressing or address modifiers using fewer than 32 bits, but these are in addition to, not instead of, the full 32-bit forms.

Full support of 32-bit data types is another deceptively simple idea. At the very least, it means that 32-bit quantities can be moved with a single instruction, and the usual arithmetic and logical operations (e.g., ADD, SHIFT, NOT) can be applied to 32-bit operands to produce 32-bit results. Problems arise with multiplication and division operations. When two 32-bit quantities are multiplied, the result may have as many as 64 significant bits. Similarly, because division is the inverse of multiplication, you

would expect, in a 32-bit architecture, to be able to divide a 64-bit quantity by a 32-bit quantity as long as the quotient and remainder could each be represented in 32 bits. One popular microprocessor, widely regarded as having a 32-bit architecture, limits multiplication to 16-bit quantities so that results can be represented in 32 bits. The same microprocessor enables division of a 32-bit quantity by a 16-bit quantity, but only if the quotient can be represented in 16 bits.

Implementation. It is easier to understand architectural anomalies such as those mentioned above in terms of implementation. The first 16-bit microprocessors (8086, Z8000, 68000) were implemented with 16-bit data paths and computational units, even though two of these microprocessors included many 32-bit architectural features. Similarly, Intel's iAPX432, which featured an innovative 32-bit architecture, was implemented with a 16-bit computational unit and 16-bit internal data paths.

Let's look at how implementation can account for the architectural restrictions I've just described. Suppose you are designing a microprocessor with a 16-bit computation unit (also known as an arithmetic and logic unit or ALU). That means that

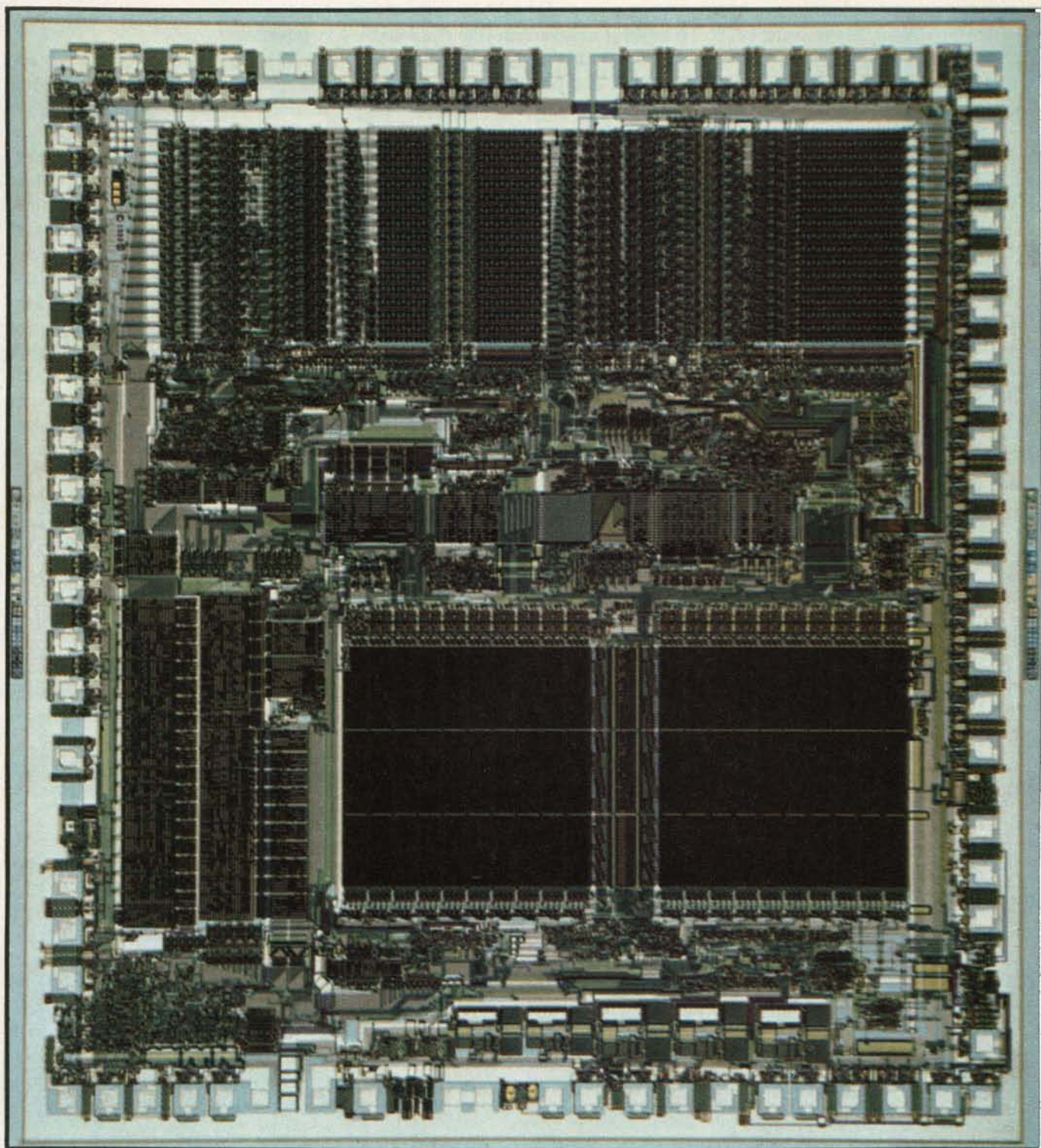

Photo 1: *The Motorola MC68010. (Photo courtesy of Motorola Inc.)*

a basic operation of the ALU will be to accept two 16-bit inputs and to produce a 32-bit product. If you want 32-bit registers and an instruction that multiplies two 32-bit quantities to obtain a 64-bit result, you're going to have to devise some sort of internal hardware "subroutine" that breaks the multiplication down into

16-bit multiplications and additions. These subroutines are an endless source of problems when you implement interrupt handling or virtual memory. They are not appreciably faster than subroutines in software that implement the same operations using basic ALU operations. Thus, you will be tempted to match the ar-

chitecture to the implementation, putting in a multiplication restriction like the one mentioned earlier. This causes little inconvenience to customers, but it gives a marketing department nightmares when it tries to convince the world that a microprocessor has a true 32-bit architecture.

Data path (bus) to memory. This is

the easy part of the definition of 32-bit microprocessor. There must be 32 (or more) I/O (input/output) lines used for the transfer of data between the central processing unit and memory. The effect of this requirement is to increase memory-bus bandwidth (the amount of data that can be transferred on the memory bus per unit of time). In simple systems (just a central processing unit and memory), this can increase performance only when the central processor can handle instructions and data faster. In more complex systems, an important benefit of increased bus bandwidth is the ability to use multiple central processing units, direct memory access (DMA) transfers, and high-speed graphics processing without degrading computational power. By using the bus substantially less than all of the time, a 32-bit microprocessor contributes to overall performance in computer-aided design (CAD) systems, engineering workstations, and even mainframe-level computers.

Data buses of the 32-bit type are a relatively new addition to the microprocessor scene. Chips like Intel's iAPX432 and National Semiconductor's NS16032 have full 32-bit architectures but 16-bit data buses. As this is being written, system designers cannot yet buy production quantities of any microprocessor with a 32-bit data path to memory.

What Are 32-bit Chips Good For?

The preceding section hints at the strengths of 32-bit microprocessors. The year 1984 will see many announcements of CAD systems and engineering workstations based on 32-bit microprocessors. General-purpose computers will appear with mainframe performance at substantially less than mainframe cost. High-end personal computers will follow. As competition and the "learning curve" of system design around 32-bit machines drive down prices, 32-bit microprocessors (and their architecturally compatible 16- and 8-bit relatives) will become the standard

for business and serious personal computing.

Aside from the performance advantages that come from higher memory-bus bandwidth and 32-bit implementation, the main benefit 32-bit microprocessors bring to computer users is architectural. Most 32-bit microprocessor architectures are designed to support high-level language programming.

Each 32-bit microprocessor addresses the issue of high-level language programming in a different way, and we'll look at the details later in the discussion of individual products. The basic support features are: large, uniform address spaces; support for virtual memory; addressing modes that support high-level languages; and instruction-set symmetry with respect to operations, operand size, and operand addressing modes.

Another benefit of the features of the new microprocessors is that they can use standard operating systems. Advances in computer science have led to the inclusion of operating-system support features within the new architectures, and the existence of "standard" operating systems like Unix has made the design of specific support features easier.

The Lineup

I want to discuss every 32-bit microprocessor that will be available or announced this year, but this involves a little guesswork. Much of this information is based on official releases, technical articles, and reliable inside information. Other parts of the story are based on rumors, used only when that's the best information available, and then only when I believe the rumors.

Here (in alphabetical order by manufacturer's name) are the 32-bit microprocessors:

- DG's Microeagle
- DEC's Micro VAX 1
- HP's Focus (company's internal name)
- Inmos' Transputer
- Intel's iAPX386
- Motorola's MC68020
- National Semiconductor's NS32032

New!

BYTEWRITER®

**DAISY WHEEL
PRINTER/TYPEWRITERS**

- Full Olivetti typewriter warranty when purchased complete



Complete BYTEWRITER using:

Olivetti Praxis 30 portable	\$495
Olivetti Praxis 35 portable	\$545
Olivetti Praxis 40 office machine	\$645
Interface only-wired and tested	\$165

The parallel interface mounts entirely internally. Interconnecting cables available for most computers.

BYTEWRITER

125 NORTHVIEW RD., ITHACA, N.Y. 14850
(607) 272-1132

Introducing the Most Powerful Business Software Ever!

TRS-80™ (Model I, II, III, or 16) • APPLE™ • IBM™ • OSBORNE™ • CP/M™ • XEROX™



The VERSABUSINESS™ Series

Each VERSABUSINESS module can be purchased and used independently, or can be linked in any combination to form a complete, coordinated business system.

VERSARECEIVABLES™ \$99.95

VERSARECEIVABLES™ is a complete menu-driven accounts receivable, invoicing, and monthly statement-generating system. It keeps track of all information related to who owes you or your company money, and can provide automatic billing for past due accounts. VERSARECEIVABLES™ prints all necessary statements, invoices, and summary reports and can be linked with VERSALEGGER II™ and VERSAINVENTORY™.

VERSAPAYABLES™ \$99.95

VERSAPAYABLES™ is designed to keep track of current and aged payables, keeping you in touch with all information regarding how much money your company owes, and to whom. VERSAPAYABLES™ maintains a complete record on each vendor, prints checks, check registers, vouchers, transaction reports, aged payables reports, vendor reports, and more. With VERSAPAYABLES™, you can even let your computer automatically select which vouchers are to be paid.

VERSAPAYROLL™ \$99.95

VERSAPAYROLL™ is a powerful and sophisticated, but easy to use payroll system that keeps track of all government-required payroll information. Complete employee records are maintained, and all necessary payroll calculations are performed automatically, with totals displayed on screen for operator approval. A payroll can be run totally, automatically, or the operator can intervene to prevent a check from being printed, or to alter information on it. If desired, totals may be posted to the VERSALEGGER II™ system.

VERSAINVENTORY™ \$99.95

VERSAINVENTORY™ is a complete inventory control system that gives you instant access to data on any item. VERSAINVENTORY™ keeps track of all information related to what items are in stock, out of stock, on backorder, etc., stores sales and pricing data, alerts you when an item falls below a preset reorder point, and allows you to enter and print invoices directly or to link with the VERSARECEIVABLES™ system. VERSAINVENTORY™ prints all needed inventory listings, reports of items below reorder point, inventory value reports, period and year-to-date sales reports, price lists, inventory checklists, etc.

VERSALEGGER II™ \$149.95

VERSALEGGER II™ is a complete accounting system that grows as your business grows. VERSALEGGER II™ can be used as a simple personal checkbook register, expanded to a small business bookkeeping system or developed into a large corporate general ledger system **without any additional software.**

- VERSALEGGER II™ gives you almost unlimited storage capacity (300 to 10,000 entries per month, depending on the system),
- stores all check and general ledger information forever,
- prints tractor-feed checks,
- handles multiple checkbooks and general ledgers,
- prints 17 customized accounting reports including check registers, balance sheets, income statements, transaction reports, account listings, etc.

VERSALEGGER II™ comes with a professionally-written 160 page manual designed for first-time users. The VERSALEGGER II™ manual will help you become quickly familiar with VERSALEGGER II™, using complete sample data files supplied on diskette and more than 50 pages of sample printouts.

SATISFACTION GUARANTEED!

Every VERSABUSINESS™ module is guaranteed to outperform all other competitive systems, and at a fraction of their cost. If you are not satisfied with any VERSABUSINESS™ module, you may return it within 30 days for a refund. Manuals for any VERSABUSINESS™ module may be purchased for \$25 each, credited toward a later purchase of that module.

To Order: Write or call Toll-free (800) 431-2818 (N.Y.S. residents call 914-425-1535)

- * add \$3 for shipping in UPS areas
- * add \$4 for C.O.D. or non-UPS areas
- * add \$5 to CANADA or MEXICO
- * add proper postage elsewhere

DEALER INQUIRIES WELCOME

All prices and specifications subject to change / Delivery subject to availability.

COMPUTRONICS

50 N. PASCACK ROAD, SPRING VALLEY, N.Y. 10977

* TRS-80 is a trademark of the Radio Shack Division of Tandy Corp. * APPLE is a trademark of Apple Corp. * IBM is a trademark of IBM Corp. * OSBORNE is a trademark of Osborne Corp. * CP/M is a trademark of Digital Research - * XEROX is a trademark of Xerox Corp.

WHY DEC AND INTEL CHOSE THE MARK WILLIAMS C-COMPILER.

DEC and INTEL wanted the best C technology available, with excellent code density, supporting the full C language and their specific operating environments—all at a competitive price.

They found it all at Mark Williams.

WHY YOU SHOULD CHOOSE THE MARK WILLIAMS C-COMPILER.

Our C-compiler supports the dominant 16-bit microcomputers—68000, PDP-11, Z8000, 8086—with a proven reliable, high-technology product. We are shipping versions of C for a large number of environments including CP/M and PC DOS. Both cross and native compilers are available.

Call us for the distributor nearest you. OEM's should contact us directly about their specific requirements.

Mark Williams Company,
1430 West Wrightwood, Chicago, Illinois 60614,
312/472-6659.



- NCR's NCR/32
- Western Electric's WE32000
- Zilog's Z80000

DG announced its Microeagle in November 1983. DEC's Micro VAX 1 was announced last October. The HP Focus (no official name or part number) is the heart of the HP-9000 computer system, but it is not and will not be available as a separate product. The Intel iAPX386 has not been announced yet, but the company is expected to do so in late 1984. Motorola has announced its MC68020; although no detailed specifications are available, samples have been promised for the middle of this year. The NCR/32 chip set, like the National Semiconductor NS32032 and its associated chips, is commercially available. Western Electric has incorporated its WE32000, formerly known as the Bellmac-32 and operational since 1981, into at least one terminal. The chip, used internally by the company and in several VAX-class minicomputers, is not available as a separate product, but Western Electric has not publicly ruled out that possibility. Zilog's Z80000 has been announced, detailed specifications are available, and samples have been slated for release this year.

In addition to these products, there is an important experimental family of microprocessors called RISC machines. (RISC is an acronym for reduced-instruction-set computer.) These 32-bit microprocessors have been developed at universities like Stanford and the University of California at Berkeley. They are not commercial products, but the ideas propelling them will profoundly influence future commercial microprocessors. The Inmos Transputer, announced in November 1983, reflects this influence.

Now let's look at these microprocessors in greater detail. Then I'll make a few comparisons.

The DG Microeagle. This is a VLSI (very large-scale integration) version of the machine whose soul Tracy Kidder described. The Microeagle chip set's central processing unit executes register-to-register operations in a 400-nanosecond cycle time and uses

two cycles for memory-to-register moves. The central processor uses a floating-point coprocessor to handle 64-bit addition in four cycles. (See the November 3, 1983 issue of *Electronics* for more information.)

The DEC Micro VAX 1. The VAX is a well-known 32-bit architecture that has been realized in two "super-mini" implementations, VAX-11/780 and VAX-11/750, and in a more modest VAX-11/730 version. The Micro VAX 1 is an implementation of the same architecture in a set of VLSI circuits, supplied on a printed circuit board like the LSI-11 implementation of the PDP-11 architecture.

A key feature of the VAX line of computers is its total upward and downward compatibility. In this Micro VAX 1, some of the "commercial" instructions have been eliminated, but traps have been provided to enable their emulation in software. The VAX architecture is well known.

The Hewlett-Packard Focus. A number of articles have been published about the process technology and design methodology of the HP

Focus, but HP deliberately avoided revealing details of the architecture. Enough is available from technical articles, however, to get the general idea.

Basically, HP set out to design a set of VLSI components that would work together to form fully integrated 32-bit multiprocessing systems. It took seven years; when HP finished, it had designed six VLSI circuits and a special mounting board that doubles as a heat sink. The six circuits are: central processor, I/O processor, memory controller, RAM (random-access read/write memory), ROM (read-only memory), and clock. Each circuit is fabricated in a 1-micron double-metal NMOS (negative-channel metal-oxide semiconductor) technology, designed to run at 18 MHz. A typical system block diagram is shown in figure 1.

The most complex of the circuits is the central processing unit, which contains about 450,000 transistors. Its 230 instructions are microcoded in 9216 38-bit words of control ROM, fetched and executed at an 18-MHz

Epson QX-10™?

Graphics?

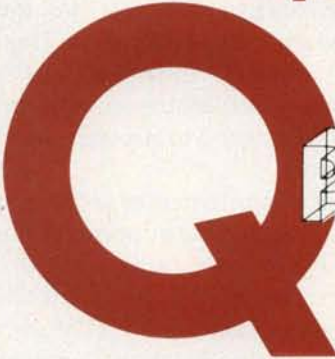

PLOTTER

GRAPHIC POWER FOR THE EPSON QX-10™

with one key . . .

■ Draw Circles
■ Squares

■ Lines
■ Axis, etc.

also zooming and panning, multiple screens,
animation and much more . . .

Q Plotter also turns your Mbasic into a high powered
graphics basic.

introductory price \$175.00

To order call toll-free 1-800-824-7888 Operator 409
For technical information or dealer nearest you
Call (602) 747-0005 or Telex 709234

Metro Software Inc.

2509 N. Campbell Ave., Suite 214, Dept. J., Tucson, Arizona 85719

QX-10 is a TM of Epson America • Mbasic is a TM of Microsoft

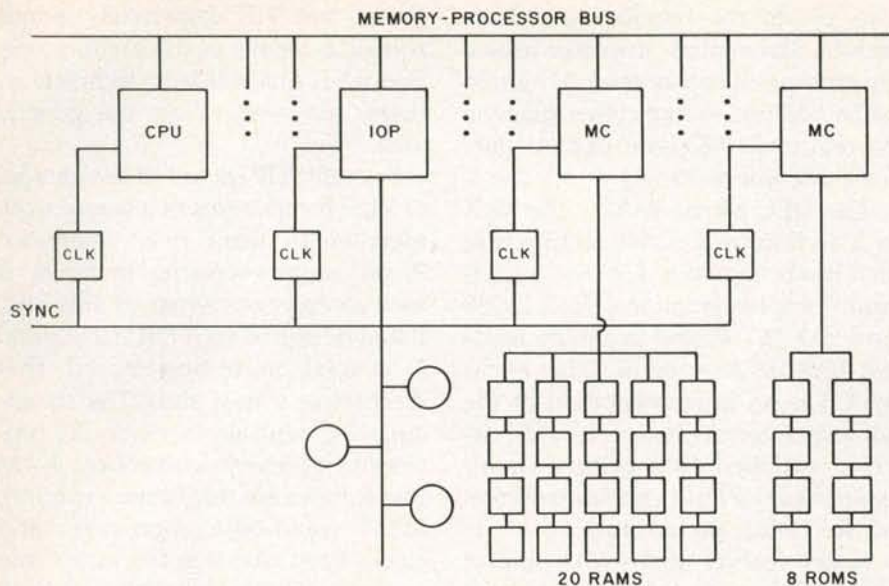

Figure 1: A block diagram of the Hewlett-Packard Focus microprocessor.

clock rate. A 38-bit microinstruction is executed every 55 nanoseconds. The central processing unit's instruction set is stack based, in the style of some Burroughs machines. Many instructions operate on the top elements of the stack, leaving the result on the stack. To optimize these instructions, the top elements of the stack are automatically kept in registers, with transfers between these registers and the stack segment of memory carried out without explicit machine instructions.

The central processor contains an extremely powerful ALU capable of executing a 32-bit register-to-register integer addition or a right or left shift of up to 31 bits in one microcycle (55 nanoseconds). Division of 64-bit operands in IEEE (Institute of Electrical and Electronics Engineers) format, the longest ALU operation, requires 16 microseconds.

The memory model for a process executing on the Focus central processing unit consists of code, stack, global data, and external data segments. Processes can have multiple data segments, which can be demand paged. Code is also demand loaded, an entire segment at a time.

HP estimates the execution speed of the Focus central processing unit to be approximately 1 MIPS (million instructions per second) on typical instruction mixes. That is, a typical instruction requires approximately 18

microcycles for its execution. Although execution and operand fetching from memory are pipelined, the central processor has no cache or TLB (translation lookaside buffer, a cache of address translations used for memory addressing). Nonetheless, the Focus central processing unit uses only about 30 percent of the 18-mega-byte/second memory-bus bandwidth, so that substantial performance improvement can be obtained with a configuration that has multiple central processing units. This is exactly what HP intended, and the instruction set of the central processor is designed to support parallel processors.

The Focus instruction set features high-level language support, including a Try/Recover facility based on stack markers. The Focus is intended to be programmed in HP's "Modular Pascal" implementation language, Modcal. Even the lowest level of the company's HPUX (HP's version of Unix) kernel is programmed in Modcal.

I'm not going into detail about the other circuits of the Focus chip set, but one example shows how these circuits work together. The central processing unit can issue up to three addresses on its multiplexed address/data bus before receiving the corresponding data from memory. The data words appear on the address/data lines at precise, predictable times, re-

quiring perfect synchronization of the activities of the central processor, memory controller, and memory circuits. In fact, 25 of the central processing unit's 83 "pins" are dedicated to control lines for communication with other Focus chip set circuits. (The remaining pins are the 32 address/data lines and the 26 lines for power, ground, and clock signals.)

The Inmos Transputer. This is a RISC-like machine scheduled for release in late 1984. The name of the chip indicates Inmos intends to make it as ubiquitous as the transistor. The Transputer will be a single-chip, 250,000-transistor device built in 2.0-micron CMOS (complementary metal-oxide semiconductor) technology. It will include processor, memory, and communications circuitry. The Transputer is designed to be used in multiprocessor systems and data-flow machines programmed in Inmos' Occam language.

The Intel iAPX386. Some of this information is based on rumors, but it's what I believe to be true about this chip:

- it's an extension of 8086 and 286 architectures
- it has 32-bit offsets in data segments
- it's implemented in CMOS technology to run at 16 MHz
- it has speeded up instructions from iAPX286
- it has an on-chip instruction cache
- it contains 270,000 transistors
- it features on-chip paging plus 286-style segmented virtual memory
- it has new instructions for vectors and bit fields
- its accompanying numeric coprocessor is much faster than the 80287
- its improved bus supports fault tolerance

The Motorola MC68020. This is the 32-bit member of the MC68000 family. Very little has appeared in print about the features of this central processing unit, which is scheduled to be sampled in 1984. Motorola personnel have talked freely at recent conferences and trade shows, and many details have been presented to current 68000 users. I'll summarize the industry scuttlebutt about the



S-100
ESTABLISHED 1977

SALES
800 - 528-3138
TECHNICAL 602-991-7870

CompuPro

A GODBOUT COMPANY

SYSTEM 816/A	\$4125
SYSTEM 816/B	\$5249
SYSTEM 816/CH*	
w/40 Mb HARD DISK	\$9369
SYSTEM 816/68K*	\$6749
SYSTEM 816/10*	CALL
THE ABOVE FULLY ASM., TESTED, & BURNED-IN	
*INCLUDES ON-SITE XEROX SERVICE	
CPU 8086 A&T	\$565
CPU 8086/87 A&T	\$789
CPU 68K W/CP/M 68K & map	
FORTH	\$790
CPU 286 A&T	\$1199
CPU 16032 A&T	\$525
RAM 16 64K STATIC, 8 OR 16, A&T	\$409
RAM 22 256K STATIC, 8 or 16, A&T	\$1313
DISK I A&T	\$375
INTERFACER 3-8 SERIAL A&T	\$525
SIX SLOT MOTHERBOARD W/TERM	\$99

MCPI

a GODBOUT Affiliate

ICB-10 an 8 Channel OPTO-
Isolated I/O w/Relays Out \$197

MORROW

MD2 W/LIBERTY TERMINAL & TALLY PRINTER	\$1599
MD3 SYSTEM AS EQUIP. ABOVE	\$1899
MD11 SYSTEM AS EQUIP. ABOVE	\$2745
W/CP/M 3.0, 128K RAM, DSDD FLPY & 11Mb H.D.	

Cromemco

SDI HI-RES COLOR GRAPHICS	\$675
PRI PRINTER INTERFACE	\$208
D+7A DIGITAL/ANALOG INTERFACE	\$251
ZPU CPU	\$335
C-10 SP PERSONAL COMPUTER	\$1495

Actrix

COMPLETE PORTABLE W/ MODEMS,
MX80 PRT. 12" MON. INCLD. CALL
2 DSDD DRV, 320K RAM, Z80,
8088 CP/M 2.2&86
MSDOS, PCDOS INSTALL & COPY
PROGRAMS + S.W.

SEATTLE
COMPUTER CPU SUPPORT \$327

MONITORS



USI Computer Products

Pi 2 12 IN. GRN HI-RES	\$142
Pi 3 12 IN. AMBER HI-RES	\$149

S-100's DUAL EXTENDER BD.	\$39
16K EPROM BD.	\$99

DIGITAL RESEARCH

MP/MII	\$315
MP/M-86	\$455
CONCURRENT CP/M	\$245
CP/M PLUS	\$245
"C" COMPILER	\$420
PASCAL MT+86	420
SPEED PROG PKG	\$175
ACCESS MNGR-86	\$280
DISPLAY MNGR-86	\$350
PL/1-86	\$525

COMPUTER INNOVATIONS 'C' COMPILER/PC-DOS	\$297
---	-------

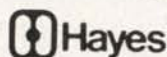

IBM-PC 1200B MODEM BOARD	\$479
--------------------------	-------



MICROBUFFER/EPSON™ CARD	
MBS-16/32K SERIAL	\$129
MBS-32K SERIAL	\$159
MBP-64K PARALLEL	\$199

MICROBUFFER IN-LINE™ STAND ALONE	
MBIS SERIAL 64K	\$259
MBIP PARALLEL 64K	\$259
MICROBUFFER II +™ 16K, APPLE II, II+ IIe	\$195

PC MATE by **TECMAR** FOR IBM-PC

1st MATE 256K, CL/CAL W/BATTERY, SERIAL, PARA, RAM DISK, SPOOLER	\$419
--	-------

5Mb CART WINCH IN PC	\$1479
GRAPHICS MASTER HI-RES RGB COLOR GRAPHICS	\$575
256K DYNAMIC MEMORY	\$349
TIME MASTER W/BATTERY BACK- UP	\$109

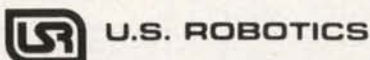

S-100 300/1200 BAUD. BD. MODEM	\$315
PASSWORD 300/1200 W/S.W.	\$369
AUTO DIAL 212A W/S.W.	\$475



SUPERSIX 128K RAM	\$800
SUPERSLAVE 6MHz, 128K	\$595
HDC-1001-5" H.D. CONTROLLER	\$450
CP/M 3.0	\$350
TURBODOS MULTI-USER	\$600

FLUKE FLUKE 77 DVO METER 0.3% DC Accuracy	\$119
--	-------

S-100 BULLETIN BOARD

SAVE 1% ON MODEM ORDERS
300-1200 BAUD 24 HR. ACCESS
FOR SUPER DEALS, FAST ORDERS
OR TECH. ASSIST, CALL
(602) 948-1387

S-100 MAINFRAMES

PARA DYNAMICS

3820S PRONTO W/SEQUENCER	\$1235
3020D 20 SLOT DESK TOP	\$679
3510D 10 SLOT, DUAL 5 1/4"	\$685
2200R DUAL 8" DRV RACK MOUNT	\$525
2300 H.D. 8" FLPY, 8" HRD DSK	\$375

INTEGRAND

800 DB2F w/ SPEC PAINT FILTERS S-100	\$497
CONNECTORS AC CBLs. TERM. M.B. 1100 D w/OAK SIDES 7 SLOTS	\$449

FLOPPY DISK DRIVES

ADD-ON DRIVE SYSTEM W/2 QUME 142 5 1/4" DSDD DRV	\$475
2 QUME 242 8" DSDD DRV. CABINET, PWR, SUP., CABLES, & FAN W/FILTER INCLD.	\$1095
842 8" DSDD	\$460
242 8" DSDD	\$445
142 5" DSDD	\$150

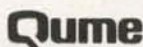

IBM has recently selected the
QUME Drive for their PC.

Tandon 100-2 5 1/4 in. DSDD \$229

PRINTERS

DAISYWRITER 2000 W/48K	\$1095
TALLEY MT 160L W/TRACTOR	\$625
EPSON MX 100	\$560
OKIDATA 93	\$950



CPZ 48000 SBC	\$895
CPS-6A 64K SLAVE 6 MHz	\$495
256KMB RAM BD.	\$895

ads ™ ACKERMAN DIGITAL PROMBLASTER W/S.W.	\$290
KLUGE KIT S-100 PROTO CARD	\$135

TRIPP LITE 400 WATT W/BATTERY GOOD FOR 1 HR.	
---	--

STAND-BY POWER SUPPLY \$450

14425 North 79th Street
Scottsdale, Arizona 85260
TELEX: 16 5025 FTCC SEC PHX

FULL DEALER SUPPORT
VISIT OUR SHOWROOM
Hrs. 9:00AM - 5:30PM M-F
Circle 312 on inquiry card.

Subject to Available Quantities
Prices Quoted Include
Cash Discounts
Shipping & Insurance Extra

68020.

The MC68020 is a 32-bit version of the widely used MC68000. It is basically upward compatible—most 68000 code can run on a 68020, but not vice versa. Because the 68000 architecture has already been presented in a series of articles by Tom Starnes (April, May, and June 1983 BYTE), I'll concentrate on the improvements.

Although most of the instruction-set changes are in the area of addressing, specific new instructions have been added for packing and unpacking of BCD (binary-coded decimal) strings, manipulation of bit fields, and 32-bit multiplication and division. Several new addressing modes have been added, and 32-bit displacements are supported.

Because the 68020 maintains the 68000 requirement that instructions be multiples of 16 bits in length and aligned on 16-bit boundaries in memory, extensions to 68000 addressing involve the addition of one or more 16-bit words to the basic instruction.

This additional space makes possible the encoding of a large number of new addressing forms. These forms include 16-bit and 32-bit displacements, elimination of the base or index register operand in addressing modes that usually require one, and an additional level of indirection, either before or after indexing.

Besides instruction-set changes, the 68020 has a number of other new features. The most important are an on-chip instruction cache, dynamic bus sizing, a coprocessor interface (to support the MC68881 floating-point coprocessor), better exception handling, virtual memory and bus fault support, and a "barrel shifter" to speed the execution of shifts, multiplication and division, bit field, and other instructions.

The 68020 will be fabricated in a new process that is about 90 percent CMOS, with NMOS technology used for critical circuits. The chip contains approximately 170,000 transistors and will be supplied at speeds of 16 and 20 MHz. Motorola estimates

that at equal clock speeds, the 68020 will be about twice as fast as a 68000 on typical programs.

The National Semiconductor NS32032. This is the 32-bit member of the NS16000 family, which consists of the NS08032, NS16032, and NS32032. The NS08032 and NS16032 are the 8-bit and 16-bit bus versions. As in the VAX line, all central processing units in the NS16000 family share the same 32-bit architecture. Except for the data bus, they also share the same internal implementation. BYTE readers had the opportunity to learn about the NS16000 family architecture in an article by Glen Leedy (April 1983, page 53), so I won't repeat that material.

The NS16000 family is distinguished by its mainframe-on-a-chip architecture, featuring virtual memory, floating-point support, and a highly regular, compactly encoded instruction set designed for high-level language support. The NS32032 is designed to work with a memory-management unit (MMU), the

THE PURCHASING AGENT 1983 favorites

We can buy any microcomputer product for you from our 288 participating wholesalers. In 1983, our clients' favorite products were:

COMPUTERS		IBM PERIPHERALS		PRINTERS	
Altos 586-10	5,650	Keytronic 5150 Keyboard	189	Okidata 92P	445
Compupro Godbout*				Tally 160L w/tractor	569
Sys. 816A RAM 21*	4,075	MODEMS		180L w/tractor	784
Sys. 816C RAM 21*	6,632	Hayes 1200	499	Toshiba P-1350	1,499
*Completely Assembled		US Robotics Password	349		
M-Drive-H	1,100	MONITORS		TERMINALS	
Disk 2, Hard Disk Contr.	500	Amdek 300 G Hi-Res	130	Qume QVT102A	542
Pragmatic 20 meg.	2,990	300 A Hi-Res	145	QVT102G	538
Pragmatic 40 meg.	4,686	NEC 1203	536	Televideo 925	715
Columbia Sys. 2-320K	2,779	Pricetron RGB w/cable	485	950	905
Sys. portable	2,390			ACCOUNTING SOFTWARE	
Corona desktop, 2-320K	2,487			CYMA, each module	750
Eagle 1620	2,999	PLOTTERS		Micro Computer	
NEC APC-H03	2,999	Houston Instr., DMP 29	1,778	Consultants, ea. mod.	450
software package	251	PRINTERS		DATABASE SOFTWARE	
H12 color graphics	618	C. Itoh F-10, 40 cps.	1,050	Condor III	437
Sage IV, w/6 meg.	5,385	Diablo 620	875	Personal Pearl	199
		650 API	1,710		
HARD DISKS		Epson FX-80	571		
Davong, 5 meg. Univ.	1,395	NEC 3510	1,365		
Tallgrass Tech. 6 meg.	1,779	7710	1,900		

CALL US FOR THE NET PRICE ON ANY OF THE 7,000 OTHER PRODUCTS WE CAN BUY FOR YOU AS YOUR PURCHASING AGENT.

Since 1980

B-84-1

THE PURCHASING AGENT, INC.
574 Weddell Drive, Suite 5
Sunnyvale, CA 94089
(408) 744-0646

COMPETITIVE EDGE

P.O. BOX 556 Order Line 800-336-1410
PLYMOUTH, MI 48170 Info & Local 313-451-0665

Authorized Sales Center For
Compupro®, Lomas, Teletek, Seattle

Systems with constant voltage on drives & circuit boards choice of Compupro enclosure 2 & Para Dyn. drive cabinet or Pronto Roll-a-Round all in one 20 slot mainframe.

COMPUPRO® 85/88, Disk 1, 1/O-4, RAM 16, (2) 8" DSDD, CP/M	\$3395.
COMPUPRO® 8086, Disk 1, 1/O-4, RAM 21 128K, 2-8" DSDD, CP/M	3995.
COMPUPRO® 68K, Disk 1, 1/O-4, RAM 21 128K, 2-8" DSDD, CP/M	3995.
TELETEK SYSTEMMASTER®, Z80A, 64K, (2) 8" DSDD Floppys, CP/M	2995.
LOMAS LIGHTING 286™ CPU, 128K RAM 67, LDP72, HAZ, 2-8" CP/M	3695.

85/88, 86, 286 & Z80 Available in Multiuser & Hard Disks

NEW MINI-MICRO SERIES SINGLE BOARD Z80 OR 80186

TELETEK SYSTEMMASTER, 2-5" 48TPI Floppys, Cabinet, CPM	1795.
TT SYSTEMMASTER, HD/CTC, 1-5" Floppy, 10MB Hard Disk, Cab	2995.
LOMAS 80186, 128K, Concurrent CP/M 2-5" Floppys, Cab	1995.
LOMAS 80186, 128K, CCP/M, 1-5" Floppy, 10MB Hard Disk	3195.

Place Order for Mini-Micro Hard Disk System in January and get a FREE Qume Amber or Green Screen QT102 Terminal

LOWEST PRICES ON COMPONENTS FROM COMPUPRO, LOMAS, TELETEK, SEATTLE

COMPUPRO Disk 1	\$327	RAM 22 A&T	\$1155	INTERFACER 4 A&T	297
CPU 68K A&T	459	RAM 21 A&T	723	INTERFACER 3 A&T	461
CPU 85/88 A&T	327	RAM 16 A&T	363	CPU 8086 A&T	495
Disk 3 A&T	525	RAM 17 A&T	329	CPU Z A&T	215
LOMAS 286	1116	RAM 67 128K	796	RAM 67 & BAT BU	875
LOMAS LDP72	220	LDP72/CPM86	399	HAZITALL	275
LOMAS 256K DRAM	636	128K DRAM	396	LIGHTNING 1 86	420
TELETEK HD/CTC	499	SYSTEMMASTER	627	10 MB 1/2 HEIGHT	795
TELETEK SBC 1	577	SBC 2	CALL	TELETEK MDRIVE	795

TERMINALS, PRINTERS

QUME QT102 Green	\$539	QT102 Amber	549	TELEVIDEO 925	699
TELEVIDEO 950	899	F10 40 CPS	1075	F10 Sheet Feed	495
dBASE II	425	SUPERCALC 2	199	DRI C for 86	225
PASCAL MT + 86	375	CB80	325	DRI CB86	375

COMPUPRO is a Godbout Company, CP/M, is a Registered Trademark of Digital Research, Supercalc is a TM of Sorcim

Instant one-button color printing.



Press here.

It's just that easy! Any time you want to print what's on your Apple's screen just hit the copy button on your Transtar 315 color printer with our PICS card installed, and it's done! No special programming, no lengthy code sequences, no need to exit your program! Just press the button and it prints!

By adding the optional PICS card to your \$599 Transtar 315 color printer, you've opened up a whole new world of easy color printing. For the first time ever, our PICS parallel interface card enables you to screendump virtually any program -- graphics, charts, games -- even copy-protected software! Specially designed only for the Apple II, II+, IIe, and Franklin computers, the Transtar 315 PICS card does the work of a parallel card and a lot more and costs only \$119.95.

At the push of a button, Transtar's innovative new 4-color diagonal ribbon will print up to 7 colors and more than 30 shades in a single pass.

The 315 is precision-built to exacting standards by Seikosha, the most experienced company of the famous Seiko group--recognized worldwide for quality and dependability. In fact, one of the nicest things about Transtar's 6-month warranty on parts and labor is that you'll probably never use it!

Innovative, inexpensive, dependable, easy: the Transtar 315. Color printing has never looked so good!

Only \$599.

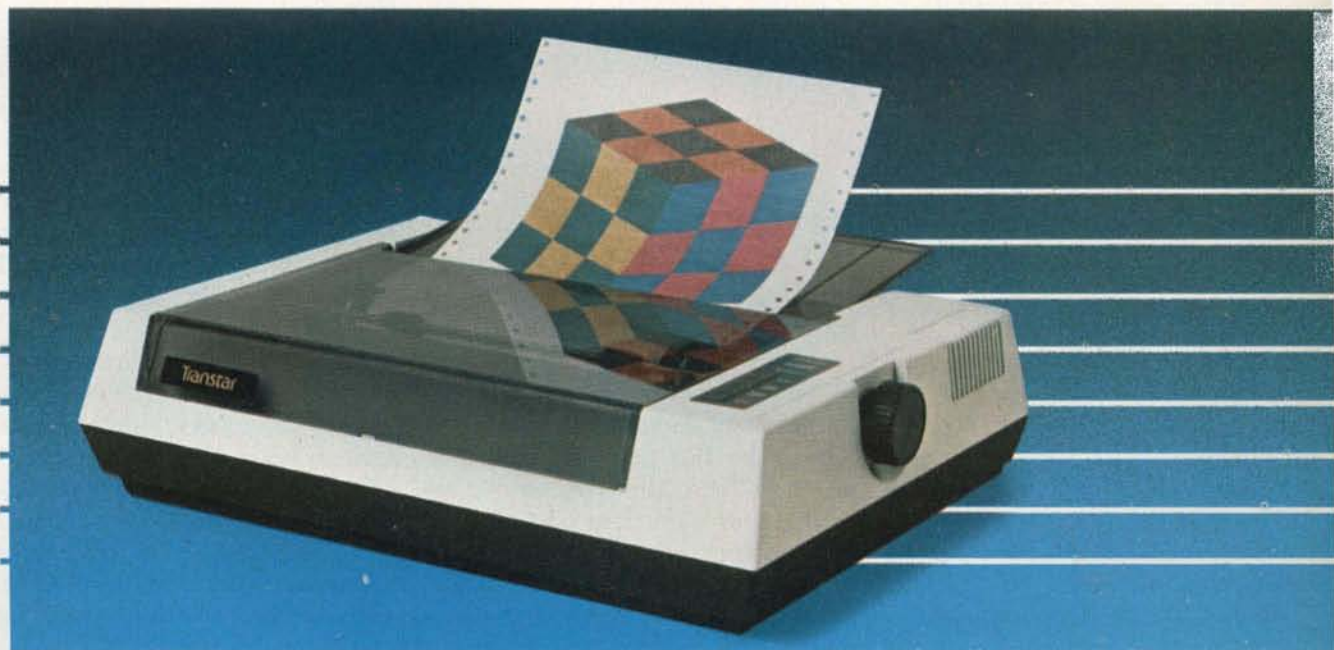

*PICS cards are currently available for Apples and Franklins.
PICS cards for other computers will be available in the future.

Transtar
A Vivitar. Computer Product

P.O. Box C-96975, Bellevue, WA 98009

Circle 362 on inquiry card.

BYTE January 1984 143

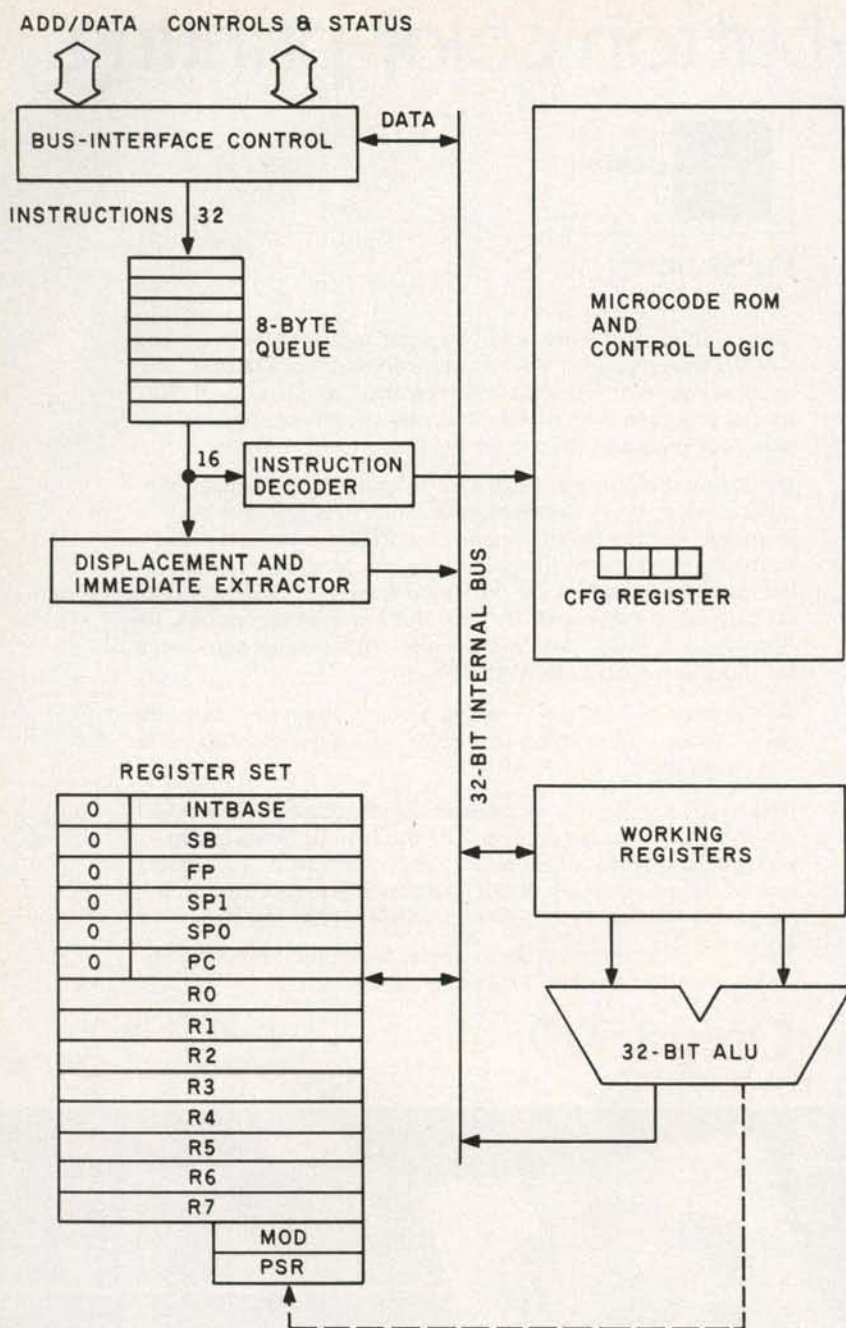

Figure 2: A block diagram of the NS32032 central processing unit from National Semiconductor.

NS16082, and a floating-point unit, the NS16081. Floating-point and memory-management control instructions are integrated into the central processor and communicate with the support chips through a slave processor protocol. This arrangement enables transparent integration of the three chips into one.

Figure 2 is a block diagram of the NS32032 central processing unit. An important feature of this chip is the 8-byte instruction prefetch queue. This small FIFO (first-in/first-out) buffer lets the central processing unit

make 32-bit aligned transfers from the instruction stream, even though NS32032 instructions vary in size and have no alignment restrictions. This 8-byte buffer provides another benefit, achieved in other central processors with a much more costly on-chip instruction cache. By letting instruction fetching proceed asynchronously from execution, instructions load as fast as necessary, up to the full bandwidth of the memory bus. Because the compactly encoded NS32032 instructions load faster than they execute even with external mem-

ory management, the central processing unit executes in-line code at full speed. In fact, in typical applications, the NS32032 central processing unit occupies less than 50 percent of the available bus bandwidth, making it suitable for complex systems containing multiple central processors, DMA transfers, and high-speed graphics.

The NS32032 is implemented in a 3.5-micron NMOS process and contains about 70,000 transistors. It runs at 10 MHz. A CMOS version and versions running at higher clock speeds are planned for 1984. The machine uses a three-stage pipeline for instruction execution: the first stage is the loader, which removes instructions from the queue; the second stage is the preprocessor, which decodes instructions; the final stage is the microcode-execution unit. Microcode executes at the rate of one microinstruction per clock cycle (100 nanoseconds).

The NCR NCR/32. This microprocessor chip set is quite different from all of the other microprocessors discussed in this article. It is designed to be externally microprogrammed to emulate other computers, principally medium-sized IBM mainframes like the System 370. The chip set consists of:

- the NCR 32-000 CPC, the central processing unit. It contains 40,000 transistors and is fabricated in a 3-micron silicide NMOS process. It runs with a 13.3-MHz clock, with internal machine cycles occupying two clock cycles (150 nanoseconds). The 16-bit microinstructions, read from a 128K-byte external storage unit, select 95-bit words from an internal ROM to control 179 operations, mostly register-to-register arithmetic and logical operations on 4-bit, 8-bit, 16-bit, 32-bit, and field data types. Microinstructions are executed in a three-stage pipeline (fetch, interpret, execute). Eight 16-bit jump registers support a rich set of conditional operations at the microcode level, and special set-up microinstructions facilitate IBM System 370 emulation.
- the NCR 32-010 ATC, the memory management unit. In addition to ad-

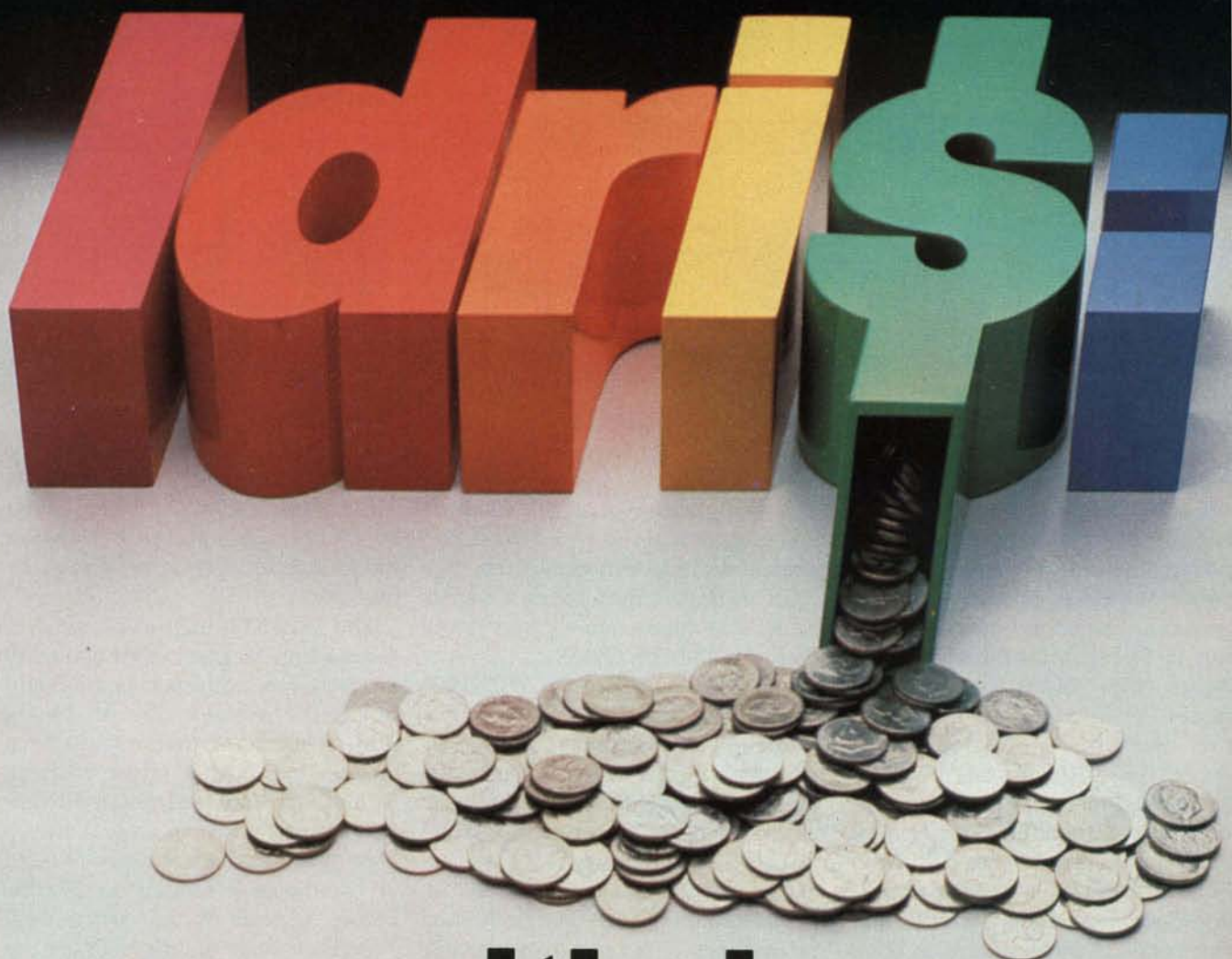

UNIX, with change.

With Idris, developers get the functionality, compatibility and portability of UNIX. And pocket the Idris difference.

- **TWICE THE NUMBER OF USERS** as UNIX on comparable hardware, because Idris is optimized for microprocessors.
- **MORE DISK SPACE FOR FILES AND PROGRAMS.** Idris occupies less than 1.5 megabytes of disk.
- **MORE TASKS RUN SIMULTANEOUSLY** because Idris requires less memory. Typically, 50 KB for the Kernel plus 50 KB for a compile. For example, you can overlap communication simultaneously with word-processing and spreadsheet analysis and Fortran compilation.
- **EASY END-USER LICENSING** provided by use of Whitesmiths' authorization seal.



- **GREATER PORTABILITY FOR YOUR APPLICATIONS.** Idris provides a common development and processing environment across processors. Supported machines include DEC PDP-11s (including Pro-350 and Micro-11), numerous Motorola 68Ks and, in first quarter 1984, the 8088 based IBM PC and DEC Rainbow.
- **MORE COST EFFECTIVE PER USER.** The \$550 end-user price is for as many users as the hardware will allow.

That's UNIX with change. To get more out of your computer, call or write to Whitesmiths, Ltd.

Whitesmiths, Ltd.

97 Lowell Road, Concord, MA 01742
(617) 369-8499 Telex 951708 SOFTWARE CNCM

Circle 378 on inquiry card.

UNIX is a trademark of Bell Laboratories; DEC, PDP-11 and Rainbow are trademarks of Digital Equipment Corporation; IBM and IBM PC are trademarks of International Business Machines Corporation; Idris is a trademark of Whitesmiths, Ltd. Distributors: Australia, Fawnray Pty. Ltd., P.O.B. 224, Hurstville, NSW2220; Japan, Advanced Data Controls Corp., Chiyoda-ku, Tokyo (03)263-0380; United Kingdom, Real Time Systems, Douglas, Isle of Man 0624833403.

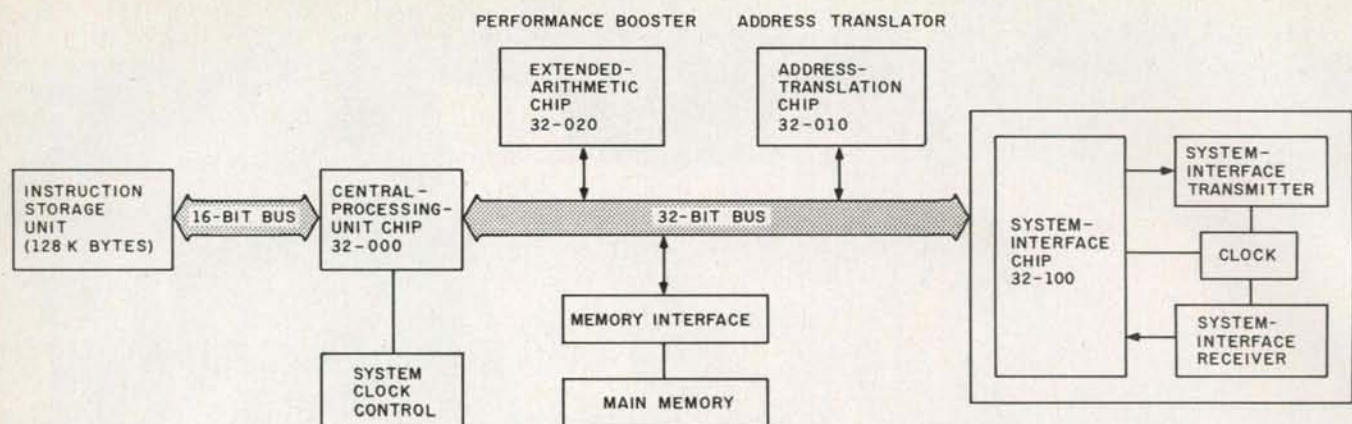

Figure 3: A configuration of the NCR/32 System.

address translation and access protection, this chip provides memory-refresh control, error-checking and correction (ECC) logic, a time-of-day register, an interval timeout interrupt, and an interrupt on writes to one specified virtual address. Sixteen translation registers support mapping of 32-bit or 24-bit virtual addresses into 24-bit physical addresses, using page sizes of 1K, 2K, or 4K bytes.

- the NCR 32-020 EAC, the "booster" chip for arithmetic operations. It supports IBM-compatible single- and double-precision binary and floating-point arithmetic, packed and unpacked decimal storage, and format conversions. A single-precision floating-point addition takes approximately 1.6 microseconds.
- the NCR 32-500 SIC, which interfaces the 24-megabyte/second pro-

cessor memory bus to slower peripherals and to other systems.

The configuration of an NCR/32 system is shown in figure 3. No benchmark data has been published, but NCR estimates performance of the NCR/32 at approximately four times that of a 10-MHz 68000.

The Western Electric WE32000. This microprocessor was designed from the start to support Unix and C. Although a great deal has been published about the process technology, electrical design, emulation techniques, and testability of the WE32000, few details are available about its architecture. The basic chip set consists of a central processing unit and an MMU, each realized in 2.5-micron "domino" CMOS and running at 8 MHz. Versions meant to run at much higher speeds have been

designed but are not officially acknowledged by Western Electric. The central processing unit contains 146,000 transistors, and the MMU contains 92,000. Figure 4 shows a block diagram of the central processing unit.

The WE32000 instruction set features a high degree of orthogonality of operation, addressing mode, and operand size selection. All binary arithmetic operations are available in two-address and three-address forms, and unary operations all have two-address forms. In general, the op code specifies the operand size, with all operands extended to 32 bits before operations are performed. When operands of different sizes are operated upon, an explicit type specification in an "expanded type" addressing mode overrides the operand size implicit in the op code.

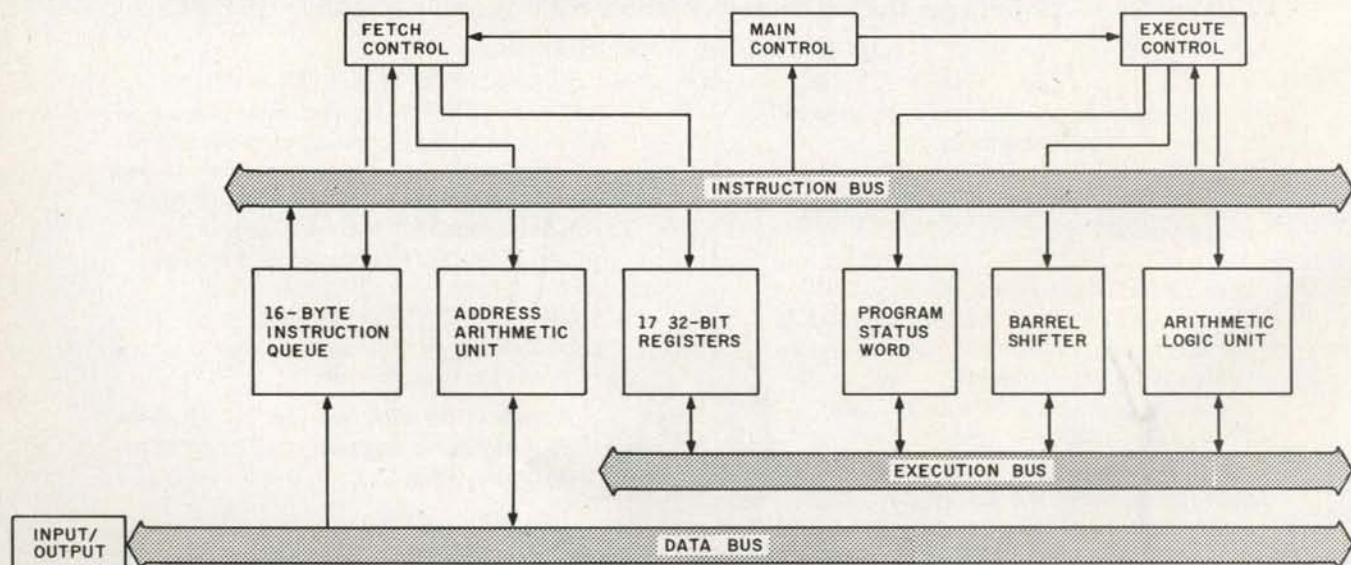

Figure 4: A block diagram of Western Electric's WE32000.

COMPUTER WAREHOUSE

CALL TOLL FREE 1-800-528-1054

QUADRAM

Quadlink	\$449
Quadboard 64K	\$249
Quadboard 256K	\$389
Quadboard II 64K	\$249
Quadboard II 256K	\$389
Microfazer (ME16) 16K	\$129
Microfazer (ME32) 32K	\$149
Microfazer (MSS16) 16K	\$149
Microfazer (MSS32) 32K	\$179

PRINTERS

C-Itch

F-10-Parallel or Serial	\$935
55 CPS Serial or Parallel	\$1319
8510 Parallel (Prowriter)	\$339
8510SP (Prowriter SP)	\$559

Computer International

Daisywriter 2000 w/48K	\$999
------------------------	-------

Comrex

CR-2	\$449
------	-------

Datasouth

DS180	\$1155
-------	--------

Diablo

620 RO	\$850
630 RO	\$1699
630 ECS/IBM	\$2075
S-11	\$ 559
P-11	\$ 559

DTC

380Z	\$1080
------	--------

Inforunner

Riteman	\$329
---------	-------

IDS

Microprism 480	\$480
Prism 80	\$1160
Prism 80 Color	\$1345
Prism 132	\$1310
Prism 132 Color	\$1500

Juki

6100	Call
------	------

Epson

All models	Call
------------	------

NEC

PC-8023A	\$385
PC-8025	\$669
3510	\$1365
3550	\$1710
7710	\$1900
2010	\$785
2015	\$785
2050	\$910

Okidata

82A	\$355
83A	\$550
84P	\$975
84S	\$1060
92	\$420
93	\$700
2350P	\$2020
2410P	\$2299

Olivetti

PRAXIS 41 (w/interface)	\$539
2300 INK JET	\$319

Panasonic

1090	\$ 299
------	--------

Qume

11/40 w/interface	\$1369
11/55 w/interface	\$1569

Silver Reed

EXP550P	\$579
EXP550S	\$ 639
EXP500	\$389

Star Micronics

Gemini-10X	Call
Gemini-15X	Call
Delta 10	Call

Tally

MT 160L w/Tractors	Call
MT 180L w/Tractors	Call
Spirit 80	Call

Toshiba

P1350 Serial or Parallel	\$1445
--------------------------	--------

SPECIAL OF THE MONTH SANYO*EPSON SYSTEMS

DUAL DRIVE SYSTEM \$1495

SANYO MBC-555 • SANYO CRT-36
HI-RES GREEN MONITOR
EPSON RX-80 WordStar • CalcStar

- Mailmerge • InfoStar • Spell Star
 - Easywriter • MS-DOS • Sanyo Basic
- Above with Sanyo CRT-70
Color Monitor \$1939

SINGLE DRIVE SYSTEM \$1175

SANYO MBC-550 • SANYO
CRT-36 HI-RES GREEN
MONITOR • EPSON RX-80

- WordStar • CalcStar • Easywriter
 - MS-DOS • Sanyo Basic
- Above with Sanyo CRT-70
Color Monitor \$1629

VIDEO TERMINALS

ADDS

A-1 Green	\$480
A-2 Green	\$490
Viewpoint 60	\$619

Altos

Smart II	Call
----------	------

Hazeltine

Esprit I	\$485
Esprit II	\$540
Esprit III	\$735

Qume

QVT 102 Green	\$535
QVT 102 Amber	\$550
QVT 103 Green	\$640
QVT 103 Amber	\$650

Televideo

910+	\$539
914	\$539
924	\$669
925	\$689
950	\$889
970	\$969

Wyse

Wyse 50	\$489
Wyse 100	\$680
Wyse 300	\$1020

Visual

Visual 50 Green	\$619
Visual 55 Green	\$709

Zenith

Z-29	\$629
------	-------

MODEMS

Hayes

Smartmodem	\$199
Smartmodem 1200	\$485
Smartmodem 1200B	\$430
Micromodem IIe	\$235

MONITORS

Amdek

Video 300	\$130
Video 300A	\$145
Color I	\$270
Color I Plus	\$275

BMC

12" Green	\$85
12" Color	\$ 210

NEC

JB 1201	\$155
JB 1260	\$115

Taxan

12" Amber	\$125
-----------	-------

Zenith

12" Green Screen	\$95
12" Amber Screen	\$120

DISKETTES

Rana

Elite 1	\$245
Elite 2	\$380
Elite 3	\$490
Controller (w/Drive only)	\$75
1000 (For Atari)	\$269

TRAK

PI-1	\$199
ATD-2	\$375

DISK DRIVES

Maxell

MD-1 (Qty. 100)	\$230
-----------------	-------

Scotch

744-0 (Qty. 100)	\$200
------------------	-------

Elephant

S/S S/D (Qty. 100)	\$155
--------------------	-------

COMPUTERS

Altos

Series 5-80-2	\$1949
5-80-10 W/MPM	\$3529
5-86-10	Call

Atari

600XL	\$149
800XL	\$249

Columbia

	Call
--	------

Corona

	Call
--	------

Eagle

PC-E	\$1775
PC-1	\$2645
PC-2	\$3075
PC-XL	\$3955
1620	\$3955
1630	\$5625
1640	\$7225

Hyperion

Single Drive System	\$2325
Dual Drive System	\$2665

NEC

PC-8201A CPU	\$ 589
PC-8206A 32K Ram	\$ 289
PC-8221A Thermal Printer	\$ 129
PC-8281A Recorder	\$ 89
PC-8201A-90 Battery Pack	\$ 15

Northstar

Advantage	\$2160
Advantage w/5MB	\$3345
Advantage w/15MB	\$4315

Pied Piper

Communicator 1	\$ 965
----------------	--------

Sanyo

MBC-550 System	\$1175
MBC-555 System	\$1495

Televideo Systems

802 H	\$4210
803	\$1815
1603	\$2150
806/20	\$4775
800 A (user station)	\$ 999
Teleport	Call

Order Line: 1-800-528-1054
Order Processing & Other Information: 602-954-6109



2222 E. Indian School Rd.
Phoenix, Arizona 85016

Store Hours: Tue-Fri 10-5:30 Saturday 9-1
Order Line Hours: Mon-Fri 10-5:30 Saturday 9-1



Prices reflect 3% to 5% cash discount. Product shipped in factory cartons with manufacturer's warranty. Please add \$8.00 per order for shipping. Prices & availability subject to change without notice. Send cashier's check or money order...all other checks will delay shipping two weeks.

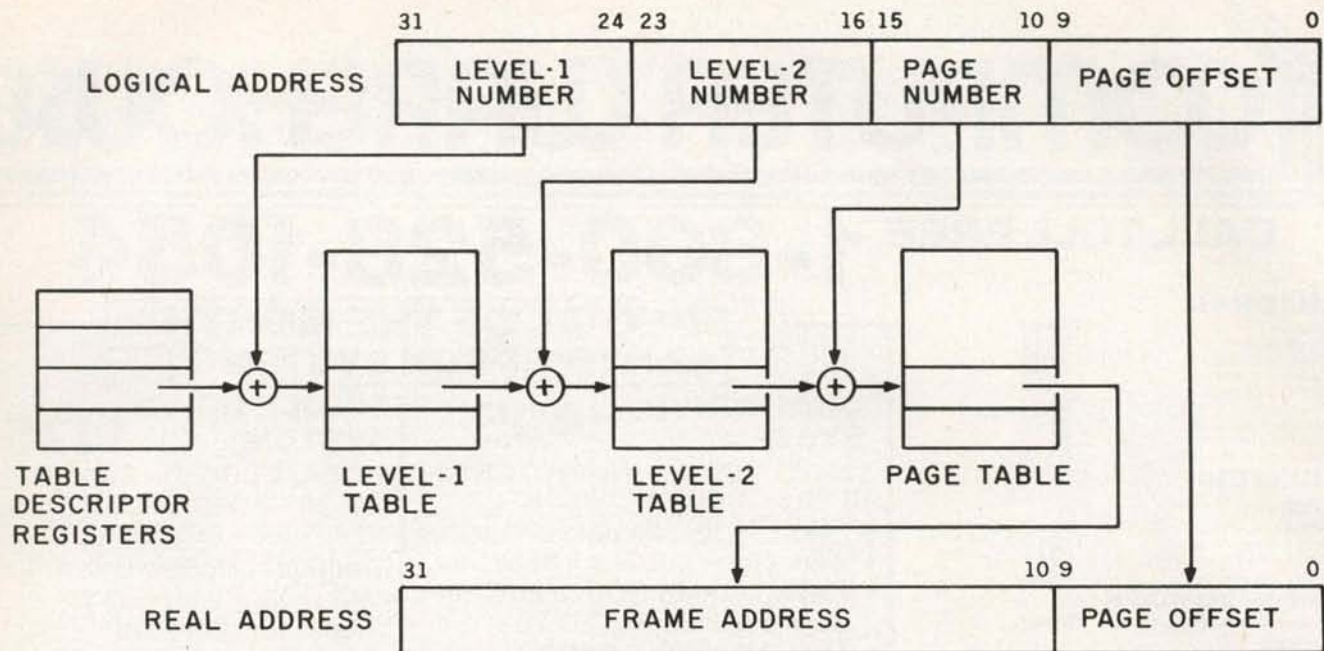

Figure 5: The Z80000 address translation scheme.

The WE32000 provides bit-field and string instructions. All strings terminate with a zero byte, as is standard for C programs. Floating-point instructions are also included in the instruction set, but these are intended to be executed by an external floating-point chip. Western Electric has not announced plans for such a chip.

Procedure linkage on the WE32000 is similar to that of the VAX. All sixteen 32-bit registers can be referred to in the machine's addressing modes. Seven of them, however, are given special functions; a program counter (PC), an interrupt stack pointer, a process control block pointer, a processor status word, a stack pointer (SP), a frame pointer (FP), and an argument pointer (AP). The PC, SP, FP, and AP play special roles in procedure linkage. In addition, the SAVE instruction, executed upon entry to a procedure, lets registers R3 through R8 be saved in a single instruction. Registers R0 through R2 are intended for passage of information between caller and callee, and they are accordingly not modified by the procedure-calling and return sequences.

The WE32000 supports multitasking operating systems like Unix. Without getting too detailed, here's the essence of multiple-task, or process, support. First, the machine sup-

ports four privilege levels and a "controlled transfer" mechanism (similar to the system call on machines with only User and Supervisor modes) for moving among them. A process, however, has only one execution stack, which makes the passing of arguments between levels quite painless. Furthermore, because the kernel is assumed to be in the address space of every process, sharing of buffers between the user and kernel routines makes copying unnecessary. Finally, the context of a process (central processor registers and address translation tables) is stored in process control blocks in memory, and special central processor instructions implement rapid switching between processes. This mechanism is also used for interrupts, which are treated like processes called unexpectedly.

The Zilog Z80000. This is the 32-bit member of the Z8000 family. An upward-compatible extension of the Z8000 architecture, it features dynamic bus sizing, sixteen 32-bit general registers, on-chip data and instruction cache (256 bytes), and on-chip memory management using memory-based tables with an automatically managed 16-entry TLB. The address-mapping scheme enables either linear addressing or several upward-compatible extensions of Z8000 segmented addressing.

Demand-paged virtual memory is supported with 1K-byte page size. Figure 5 shows the address translation method.

The machine is implemented in a 2.0-micron NMOS technology designed to enable speeds up to 25 MHz. The initial version runs at 10 MHz. Internal machine cycles take two clock cycles. Zilog estimates that with a high-performance memory configuration, typical programs will execute at the rate of one instruction every 6.8 clock cycles, resulting in an execution rate of 1.47 MIPS. Both bus size and bus timing are dynamically controllable, with accesses adhering to the Z-BUS protocols used by Zilog's Z8000 peripheral family. Nibble-mode (burst) transfers support prefetching of instructions into the cache. Like the Z8000, the Z80000 is designed for use with an external floating-point chip, which Zilog plans to make available in 1985.

Which Is the Best One?

Of course, I won't touch that question with a 10-foot pole, but further discussion of the 32-bit chips may be useful. The first interesting point is that the microprocessors fall into groups. For example, the WE32000 and the NS32032 show many similarities, and both are close to the VAX. Similarly, the MC68020 and the

RYDEX

Remote Intelligence takes your computer from the screen out to the scene.

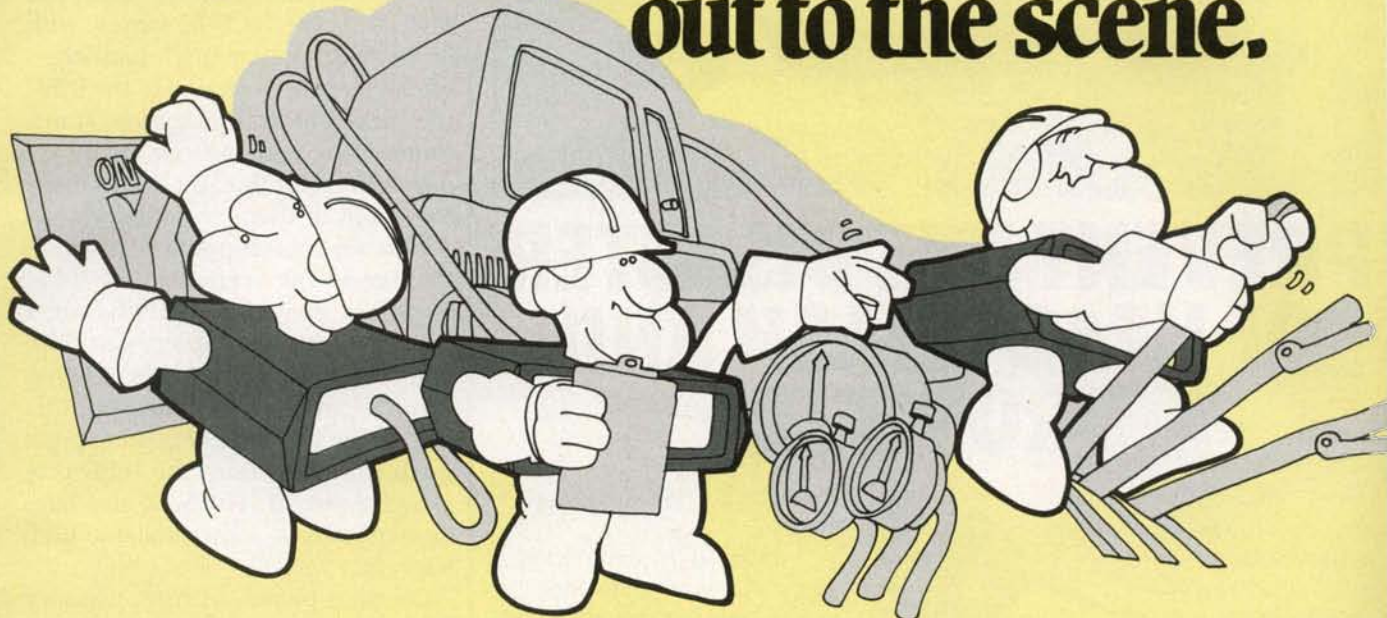

Who can blame you if you've only been using your computer as an efficient filing system. Up to now, getting it to physically do things for you, like regulate equipment or even just open the garage door, has been complex, troublesome and expensive.

Rydex has the intelligent solution!

The Rydex IC (Intelligent Controller) series transforms your PC into a powerful monitor and control tool, with capabilities ranging from relay activation to temperature monitoring, motor control and security/alarm system regulation. Control can be through

digital or analog channels, connected directly or by modem, with hundreds of IC units to a single

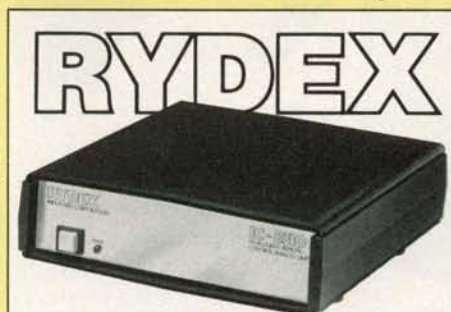

For more information on how Rydex ICs can put YOUR computer to work, call or fill in and mail coupon below to:

Rydex Industries Corporation, 200/4040 No. 3 Road, Richmond, B.C. V6X 2C2 (604) 278-6772.

NAME _____

COMPANY NAME _____

ADDRESS _____

ZIP/POSTAL _____ TEL. _____

RS 232 serial port. Modular design means you can expand easily to virtually limitless remote control capacity.

Rydex ICs require no special computer knowledge or special software to use. All commands are accessible through Basic. IC systems are not difficult to install. Complete instructions come with the unit. Or if you have an especially complex application, our technical staff will be glad to assist.

And here's the final word on Rydex ICs. Affordability. Most systems can be installed for less than \$1,000.



PREVENT THE DISASTER OF HEAD CRASH AND DROPOUT.

The war against dust and dirt never ends. So before you boot-up your equipment, and everytime you replace a cassette, disk or drive filter, be sure to use Dust-Off II; it counteracts dust, grit and lint. Otherwise you're flirting with costly dropouts, head crashes and downtime.

Dust-Off II is most effective when used with Stat-Off II. Stat-Off II neutralizes dust-holding static electricity while Dust-Off II blasts loose dust away. There's also the Dual Extender and Mini-Vac for vacuuming dust out of hard-to-reach places.

Photographic professionals have used Dust-Off brand products consistently on their delicate lenses and expensive cameras for over ten years. They know it's the safe, dry, efficient way to contaminant-free cleaning.



Cleaning not provided by liquid cleaners.

Dust-Off II's remarkable pinpoint accuracy zeros in on the precise area being dusted. And you have total control—everything from a gentle breeze for



Stat-Off II neutralizes dust-holding static electricity from media and machines.

delicate computer mechanisms to a heavy blast for grimy dirt.

Don't let contamination disrupt your computer operation. Stock up on Dust-Off II—the advanced dry cleaning system, at your local computer or office supply dealer.

Or send \$1.00 (for postage and handling) for a 3 oz. trial size and literature today.



Dust-Off II

The safe dry cleaning system

Falcon Safety Products, Inc., 1065 Bristol Road, Mountainside, NJ 07092

Z80000 are closely parallel, both being upward-compatible extensions of 16-bit central processing units designed in the PDP-11 tradition. The HP Focus, with its architectural heritage from the Burroughs line, is unlike the other chips discussed here. It's too early to know where to place the iAPX386, but it's probably closest to the Z80000 and the MC68020. The NCR/32 family, with its theme of emulation through external microcode, is related to the RISC machines, as is the Inmos Transputer. These comparisons are meant only as food for thought—don't make too much of them.

Floating-point support is an important issue. The overwhelming trend is toward execution of IEEE-format operations using a coprocessor chip. Only the HP Focus does on-chip floating-point operations. NCR/32 follows the IBM style of floating-point math, different from the IEEE proposed standard. The VAX also uses its own formats, some similar to IEEE formats.

Demand-paged virtual memory seems to be a universally accepted choice, using a separate memory-management circuit. Only Zilog and Intel use on-chip memory management; Zilog's technique evolves from the separate-chip approach, and Intel upgrades the rudimentary on-chip memory management of the 8086 and 286.

Execution speed is a tricky area, and I've been involved in enough benchmark studies to know better than to shoot from the hip here. What's needed, once all of these 32-bit microprocessors are real, is a comprehensive comparison study like the one in *EDN* magazine's issue of September 16, 1981. There is probably less than a factor of 4 between the fastest and the slowest of these microprocessors. All of the 32-bit chips are a cut above the best 16-bit microprocessors. ■

Richard Mateosian (2919 Forest Ave., Berkeley, CA 94705) is the technical marketing manager for the NS16000 family at National Semiconductor. He is the author of *Programming the Z8000*, published by Sybex in 1980, and *Inside BASIC Games*, Sybex, 1981.



GIVE YOUR CHILD THE PLATO EDGE IN ALGEBRA.

For use with the Apple II Plus and Apple IIe:

New PLATO® lessons in Elementary Algebra*

Help your child feel confident about learning algebra skills. This new PLATO series helps simplify Exponents, Polynomials, Roots and Radicals, Factoring and other Algebra components. Practice problems change at random and examples of solutions help keep kids motivated.

New PLATO lessons in Computer Concepts†

This series helps kids understand the computer and lets them practice what they learn.

Lessons include: The Computer Keyboard, Storage and Memory, Files and Editing and Databases.

Widen your child's world

Other PLATO lessons include Elementary Math, Foreign Languages, Physics-Elementary

Mechanics, Computer Literacy and #Keyboarding.

All PLATO micro courseware is available for the Apple II Plus and Apple IIe. Selected lessons are available for the TI99/4A and Atari 800.

For a free catalog

See the growing line of PLATO micro courseware at selected retail outlets. For a free catalog call toll-free: 800-233-3784. (In Calif., call 800-233-3785.)

Or write: Control Data Publishing Co., P.O. Box 261127, San Diego, CA 92126.

*Developed with Courses by Computers, Inc.

†Developed with Continuous Learning Corporation.

‡Developed with Gregg/McGraw-Hill.

Warranty available free from Control Data Publishing Co., 4455 Eastgate Mall, San Diego, CA 92121



PLATO
COMPUTER-BASED EDUCATION

GD
CONTROL DATA
PUBLISHING

Mitel Announces This

1 A CALENDAR. With a built-in time and date clock. And an alarm that flashes to remind you of key appointments. A whole year's plans can be stored. Reminders automatically move to the next day. A bar chart shows you your entire week at a glance. And all calendars can be electronically mailed or printed and carried with you.

2 A TELEPHONE. Built right into your workstation. With your own alphabetic phone directory on the screen. Automatic dialing. And redialing. Using only the initials of the person you're calling. A record of how much time is spent on each call. Hands-free conversation through a speaker phone. Two lines that can be used simultaneously. Voice and data communications at the same time. And an interface with both Mitel and other PBX's.

3 AN ELECTRONIC MAILBOX. From your Kontakt to anyone else's. Inside the company or out. Instant notification when mail arrives. Just one instruction sends a piece of mail to many people. Gather mail in your "out basket." Automatically send it later at lower long distance rates.



Introducing Mitel Kontakt™. The management workstation that fully integrates virtually every day-to-day task. Communications, time management, computing, and so much more. Plus the ability to do so many things simultaneously. Talk on the phone at the same time you're on-line with your main-

frame computer at the same time you're checking your calendar at the same time you're printing your sales forecast at the same time... Compare the Mitel Kontakt with any workstation on the market. And make sure you compare prices, too. You'll discover Kontakt gives you much, much more for your money.

Six New Machines. are it.

4 A COMPUTER TERMINAL. Send and receive information with your company's IBM™ compatible or DEC™ compatible computer. Access Dow Jones,™ The Source™ and other data banks. The telephone line and modem are built right in. Your Kontact memorizes the computer "lingo." To make data communications as simple as any other task.

5 A PERSONAL COMPUTER. Prepare a budget, forecast sales, plan the next quarter. With your ExecuCalc™ electronic spreadsheet. The answers to all the mathematical "what ifs" of your business. Access in the future to CP/M™ programs. Plus the ability to edit them with word processing. Send them to any other Kontact user. And discuss them on the telephone.

6 A WORD PROCESSOR. Whether you type with two or ten fingers. Eight function keys tell you exactly what to do. In everyday English. ExecuWrite™ is a sophisticated, full-featured, word processing package. Review and edit two files at once. Transfer text from one report to another. Integrate information created with your electronic spreadsheet.

There simply isn't
any other system
that does as much.
At any price.

For more information call
1-800-MITELSX.
In Canada call collect
1-613-592-6353.



BUILDING BETTER COMMUNICATIONS

Memory Cards: A New Concept in Personal Computing

These miniature microcomputers could become the most popular portables

by Mark Mills

One fascinating new microcomputer has neither keyboard nor power supply, and chances are that you'll soon carry one in your wallet. This type of memory card (also called a "smart card" or "chip card") is the same size and shape as a credit card and contains an embedded microcomputer. Currently being test-mar-

keted in the United States and Europe, memory cards are designed to record and play back information in a secure fashion.

Another type of memory card doesn't have an embedded microcomputer but instead has a special coating on which information can be encoded. Yet another type is not

card-shaped but resembles a fat plastic key with a nonvolatile semiconductor memory embedded in it (see photo 1). Throughout the rest of this article, "memory card" will be used to indicate all three types of implementations.

Presently, the primary application for memory cards is in the area of



Photo 1: Four memory cards incorporated into different carrier packages. The bottom three cards are active devices, containing embedded microcomputers. Note the metal contact points on their surfaces (or, the "key," the contacts are between the ridges). The top card is a passive device that uses an optical stripe for laser recording and playback.

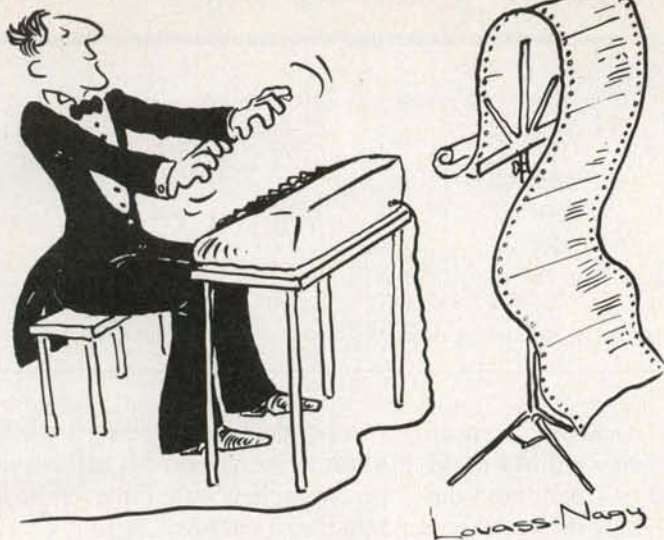

•NEW PRODUCTS•

Before Johann Sebastian Bach developed a new method of tuning, you had to change instruments practically every time you wanted to change keys. Very difficult.

Before Avocet introduced its family of cross-assemblers, developing micro-processor software was much the same. You needed a separate development system for practically every type of processor. Very difficult and very expensive.

But with Avocet's cross-assemblers, a single computer can develop software for virtually any microprocessor! Does that put us in a league with Bach? You decide.

The Well-Tempered Cross-Assembler

Development Tools That Work

Avocet cross-assemblers are fast, reliable and user-proven in over 3 years of actual use. Ask NASA, IBM, XEROX or the hundreds of other organizations that use them. Every time you see a new microprocessor-based product, there's a good chance it was developed with Avocet cross-assemblers.

Avocet cross-assemblers are easy to use. They run on any computer with CP/M* and process assembly language for the most popular microprocessor families.

5 1/4" disk formats available at no extra cost include Osborne, Xerox, H-P, IBM PC, Kaypro, North Star, Zenith, Televideo, Otrona, DEC.

Turn Your Computer Into A Complete Development System

Of course, there's more. Avocet has the tools you need from start to finish to enter, assemble and test your software and finally cast it in EPROM:

Text Editor VEDIT -- full-screen text editor by CompuView. Makes source code entry a snap. Full-screen text editing, plus TECO-like macro facility for repetitive tasks. Pre-configured for over 40 terminals and personal computers as well as in user-configurable form.

CP/M-80 version \$150
 CP/M-86 or MDOS version \$195
 (when ordered with any Avocet product)

EPROM Programmer -- Model 7128 EPROM Programmer by GTek programs most EPROMS without the need for personality modules. Self-contained power supply ... accepts ASCII commands and data from any computer through RS 232 serial interface. Cross-assembler hex object files can be down-loaded directly. Commands include verify and read, as well as partial programming.

PROM types supported: 2508, 2758, 2516, 2716, 2532, 2732, 2732A, 27C32, MCM8766, 2564, 2764, 27C64, 27128, 8748, 8741, 8749, 8742, 8751, 8755, plus Seeq and Xicor EEPROMS.

Avocet Cross-assembler	Target Microprocessor	CP/M-80 Version	•CP/M-86 IBM PC, MSDOS** Versions•
•XASMZ80	Z-80	\$200.00 each	\$250.00 each
•XASM85	8085		
XASM05	6805		
XASM09	6809		
XASM18	1802		
XASM48	8048/8041		
XASM51	8051		
XASM65	6502		
XASM68	6800/01		
XASMZ8	Z8		
XASMF8	F8/3870		
XASM400	COP400		\$300.00 each
XASM75	NEC 7500		
Coming soon: XASM68K...68000		\$500.00	

(Upgrade kits will be available for new PROM types as they are introduced.)

Programmer \$389

Options include:

- Software Driver Package --
- enhanced features, no installation
- required.
- CP/M-80 Version \$ 75
- IBM PC Version \$ 95
- RS 232 Cable \$ 30
- 8748 family socket adaptor ... \$ 98
- 8751 family socket adaptor ... \$174
- 8755 family socket adaptor ... \$135

- **G7228 Programmer by GTek** -- baud
- to 2400 ... superfast, adaptive programming algorithms ... programs 2764 in one
- minute.

• Programmer \$499

- Ask us about Gang and PAL programmers.

- **HEXTRAN Universal HEX File Converter** -- Converts to and from Intel, Motorola, MOS Technology, Mostek, RCA, Fairchild, Tektronix, Texas Instruments and Binary formats.

• Converter, each version \$250

Call Us

If you're thinking about development systems, call us for some straight talk. If we don't have what you need, we'll help you find out who does. If you like, we'll even talk about Bach.

CALL TOLL FREE 1-800-448-8500
 (In the U.S. except Alaska and Hawaii)

VISA and Mastercard accepted. All popular disc formats now available -- please specify. Prices do not include shipping and handling -- call for exact quotes. OEM INQUIRIES INVITED.

*Trademark of Digital Research **Trademark of Microsoft



AVOCET SYSTEMS INC.™

DEPT. 184-B
 804 SOUTH STATE STREET
 DOVER, DELAWARE 19901
 302-734-0151 TELEX 467210

electronic funds transfer (EFT). France has several trial programs underway to demonstrate "electronic money" using memory cards. For example, videotex users may purchase goods and services in their homes using memory cards. In Italy, a semiconductor firm is manufacturing prototype memory cards for pay telephones. You buy a memory card with a "preloaded" amount of money, and, with each phone call, an amount is deducted from the memory card's balance. When the amount reaches zero, the card is discarded. (See the text box below.)

Other proposed uses for memory cards include personal identification (using physiological traits), driver's licenses, ski-lift tickets, passports, data recorders for pacemakers, hotel door keys, input devices for computer-controlled equipment, and extended memory for computers.

Memory-Card Technology

Memory cards are implemented using three types of technologies: monochip memory cards, multichip memory cards, and optical-stripe memory cards. A monochip memory card has only one integrated circuit (IC), which includes a single-chip computer that holds a maximum of about 4000 bits of information in programmable read-only memory (PROM). This PROM is used to

	Bits	Characters (bytes)	Reusable memory
Optical stripe	16M	2M	no
PROM	128K	16K	no
EEROM	64K	8K	yes
EPROM	128K	16K	no
Magnetic stripe	1.7K	212	yes

Table 1: A comparison of the storage capacities of all the types of memory cards.

record and play back the "transactions" of the memory card. A PROM-based card could be considered disposable because once its memory is full, the memory cannot record new transactions. To overcome this drawback, manufacturers are now investigating the use of electrically erasable read-only memory (EEROM). Although this technology eliminates the "use until full" problem, it may increase problems related to card security and integrity.

A memory card with more than one IC is called a multichip card. The multichip card is more versatile because it has a memory capacity of approximately 16,000 bits of information and does not require the high degree of IC customization the monochip card does. With the improvement of packaging techniques and IC technology, multichip cards with large memory capacity will become commonplace.

An optical-stripe memory card has a special surface similar to the coating on a videodisk rather than embedded integrated circuitry. A single optical stripe the size of the magnetic stripe on a credit card can hold 16 million bits of information; a similar size magnetic stripe on a typical credit card holds only about 1700 bits of information. Table 1 provides a comparison of storage densities for memory cards.

A memory card that incorporates a microcomputer is known as an *active* memory card. This type of card has some degree of internal intelligence that enables it to make decisions about its interactions with the outside world. These decisions can range from the security of its stored information to initiating the proper sequence of steps required to enable a transaction to be processed. Regardless of the nature of the interaction, the active memory card

It's in the Cards

Approximately five years ago, the French Telecomms Administration initiated a cohesive research and development program from which memory cards and other related products have evolved. Memory cards were originally designed to exploit integrated-circuit technology in a credit-card-shaped package for electronic funds transfer (EFT). This technology is being developed to replace check writing as a method of payment. With the astronomical number of checks written annually, it is not hard to see why a less labor-intensive method of payment is being developed. Presently, several test sites in the United States and France are studying this concept in conjunction with videotex systems.

Memory cards are also being evaluated

in lieu of money for pay telephones. Advantages to using telephone memory cards include no coins to collect from coin boxes, less vandalism (because no money is kept in the telephone itself), and instant collection of payment for services. Current problems these test markets must resolve are the matter of contact reliability between the memory card and the transaction terminal and the integrity of memory-card security systems. These issues, as well as that of public acceptance, must be resolved before a full-scale memory-card application for EFT can be implemented. It will probably be several years before memory cards are widely in use.

At present, there are no in-place systems for memory cards in the U.S. However, the

U.S. Department of Agriculture plans to soon choose a contractor for a demonstration of a memory-card system that could replace the paper coupons in the food-stamp program. The cards would be issued with the equivalent amount of money in memory, thereby eliminating the paper, paperwork, printing, and handling of stamps for the approximately 8 million households in the food-stamp program.

Another area in which memory cards are being used is to augment or replace "dog tags" currently used in the military. The memory card could not only keep the traditional name, rank, and serial number data but also store a soldier's training history, medical records, and so on.

Our new Color/Scribe™ printer:

*fully compatible with the IBM Personal Computer
and color monitor when using the emulation disk
supplied with each printer.*

**If you think it takes guts
to announce a color printer
in a Black & White ad,
wait until you hear our Radio spots.**

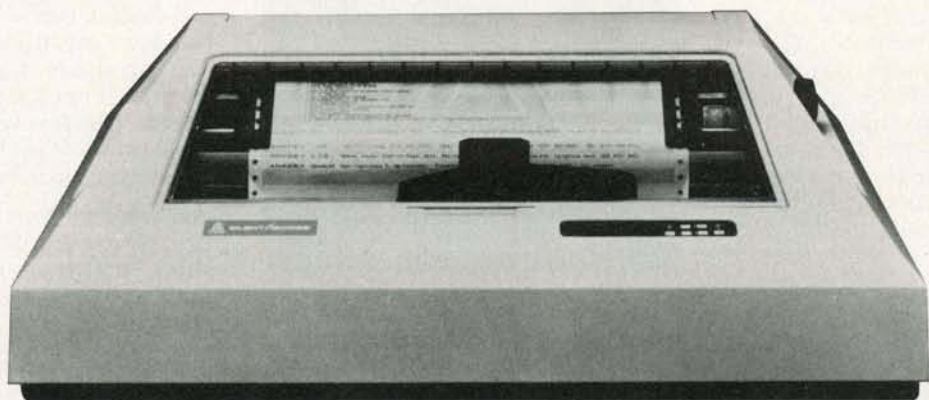

After years of building single-color printers, we would be the first to admit that color printers aren't for everyone.

But for those of you who insist on a full-color printer, here's the one you should insist on: Our Color/Scribe DP-9725B.

Because Color/Scribe's rich, saturated colors and razor-sharp resolution lets you take full advantage of your computer's color graphics. With it, you can punch up your presentations and breathe new life into your reports.

And since Color/Scribe is based on the "Bulletproof" design of our Silent/Scribe™ series, you get quiet, field-proven reliability that's becoming the industry standard.

Don't need color all the time? Fine. In the single-color mode, Color/Scribe runs circles around most other printers with its Draft, Enhanced and Dual-Pass Correspondence

Modes at speeds up to 240 Characters-per-Second.

So, with Color/Scribe you can have color when you need it, and high-performance black & white at no extra cost... sort of like getting three printers.

Color/Scribe. If you simply must have a full-color printer, have one of the best.

Have one of ours.

**Call (800) 4 ANADEX
In California 800-792-9992**

 **Anadex**
© Copyright 1983, Anadex, Inc.

MADE IN
USA
FOR THE WORLD

**The more you know printers,
the more you'll like Anadex.**

ANADEX, INC. • 1001 Flynn Road • Camarillo, California 93010 • Telephone: (805) 987-9660 • TWX 910-494-2761
U.S. Sales Offices: Irvine, California (714) 557-0457 • Schiller Park, Illinois (312) 671-1717 • Wakefield, Massachusetts (617) 245-9160
Hauppauge, New York, Phone: (516) 435-0222 • Atlanta, Georgia, Phone (404) 255-8006 • Austin, Texas, Phone: (512) 327-5250
ANADEX, LTD. • Weaver House, Station Road • Hook, Basingstoke, Hants RG27 9JY, England • Tel: Hook (025672) 3401 • Telex: 858762 ANADEX G
ANADEX GmbH • Behringstrasse 5 • 8752 Mainaschaff • W. Germany • Tel: 011-49-06021-7225 • Telex: 4188347

Now available
for the IBM PC/XT™

Statpro™

The most comprehensive statistics and graphics ever developed for and sophisticated database workstation the personal computer.

Years of research, development, and field testing have resulted in the most extensive statistics and graphics database program specifically designed for the personal computing environment. STATPRO™ provides the data analysis capabilities and flexibility previously available only on a large computer. Researchers, business professionals, and other data analysts will welcome the breadth yet simplicity of this program! STATPRO requires no previous computer experience, no special command language. Single keystrokes access all of the data manipulation, statistics, and graphics power of STATPRO.

STATPRO allows easy access to its extensive numerical data capabilities.

The strength of STATPRO is found in the functions of its user friendly, menu-driven database. You can easily learn to enter and edit, manipulate, transform, and print out data. STATPRO's searching capabilities allow these functions to be performed on all your data or a user defined subset of your data.

Statistics Modules Menu

- A) DESCRIPTION
- B) REGRESSION
- C) ANOVA
- D) TIME SERIES
- E) MULTIVAR

(ESC) Exit to Master Menu

Choice - []

Transformations and over 400 conversions are available. You can place the results of these transformations into the same field or any other field in STATPRO's database.

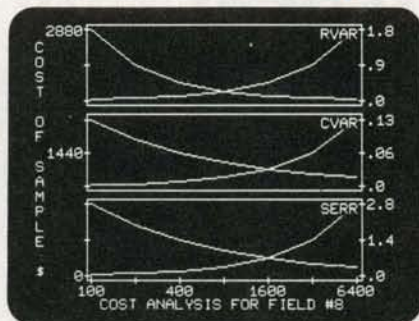

STATPRO offers a comprehensive collection of statistical procedures.

The statistics component of STATPRO contains a multitude of procedures, grouped into the following modules:

Descriptive: Contingency analysis, cross tabulation, normality tests; descriptive, comparative, range and non-parametric statistics.

Regression: Linear, non-linear, stepwise, and multiple regressions; residual analysis and statistical matrices.

Analysis of Variance: Single and nested classifications, two and three way equal and unequal sample size and non-parametric ANOVA.

Time Series: Moving averages, multi-stage least squares, fitted polynomials and trig functions, additive and multiply forecasting.

Multivariate: Principal components, factor, orthogonal factor, oblique factor, pair-weighted cluster, discriminant function, multiple contingency, and canonical correlation analysis.

STATPRO provides graphic representation of your data in minutes.

STATPRO graphics plot all the results of your STATPRO statistical analyses including scatter, triangle regression, and box plots; pie-

charts, histograms, and dendrograms. Further, with STATPRO you can custom edit with any of four character sets from the keyboard. You can also edit using paddles, joystick or special graphics commands. Mix text with data fields. Place multiple plots on each screen. Define your axis limits.

You can save your graphics on a disk for a multiple color "slide show" presentation, or print them out through a variety of compatible printers.

STATPRO documentation wraps up the package.

Although STATPRO software is essentially self-documenting, complete print documentation is provided. This includes a walk-through Introductory Tutorial, a Menu Chart, and a comprehensive User's Guide for each STATPRO component.

STATPRO currently runs on all versions of the Apple® II, Apple ///, and IBM® Personal Computers.

To find out more about **Statpro: The Statistics and Graphics Database Workstation**, contact your local dealer, or

Call us toll-free at

800-322-2208

In Massachusetts call (617) 423-0420.

You can also call us toll-free for information on corporate purchase through our National Account Program.



**Wadsworth Electronic
Publishing Company**

Statler Office Building
20 Park Plaza, Boston, MA 02116

STATPRO is a trademark of Wadsworth Electronic Publishing Company. Apple is a registered trademark of Apple Computer, Inc. IBM is a registered trademark of International Business Machines, Corp.

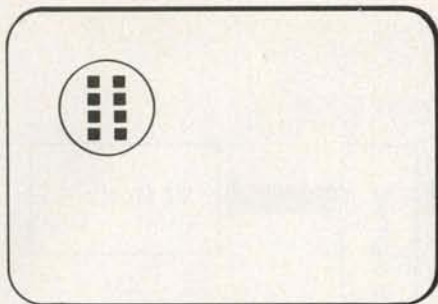

Figure 1: A typical arrangement of the contact points of an active memory card. Relatively few (six to eight) contacts are needed because the data is transmitted serially. See the Flonic security card in photo 1.

plays a direct part in its own destiny.

On the other hand, a *passive* memory card (e.g., an optical-stripe card) has no active intelligence and depends entirely on the outside world for interaction. A passive card is not unprotected, however, because this type of device can dedicate a portion of its larger memory-storage capacity to identification data of its owner. For instance, its card reader might require a match with a digitized picture, fingerprint, or voiceprint to confirm identification; an ample amount of storage capacity would be left over for transactions. Data-encryption schemes further increase the security of passive cards.

The design of the card reader or transaction terminal depends on whether the memory card is active or passive. In the case of an active card, a transaction terminal would need only I/O (input/output) devices and a power supply because the memory card already contains a microcomputer (see photo 2).

By contrast, the optical-stripe card requires some type of sophisticated laser-based data-transfer system to decipher the small dots encoded on the card's surface.

Memory-Card Architecture

The active monochip memory-card architecture typically contains a single microcomputer embedded in a package the size and shape of a credit card. The microcomputer is connected to the outside world via contact points on the memory card's surface. Very few contact points are necessary because only power and

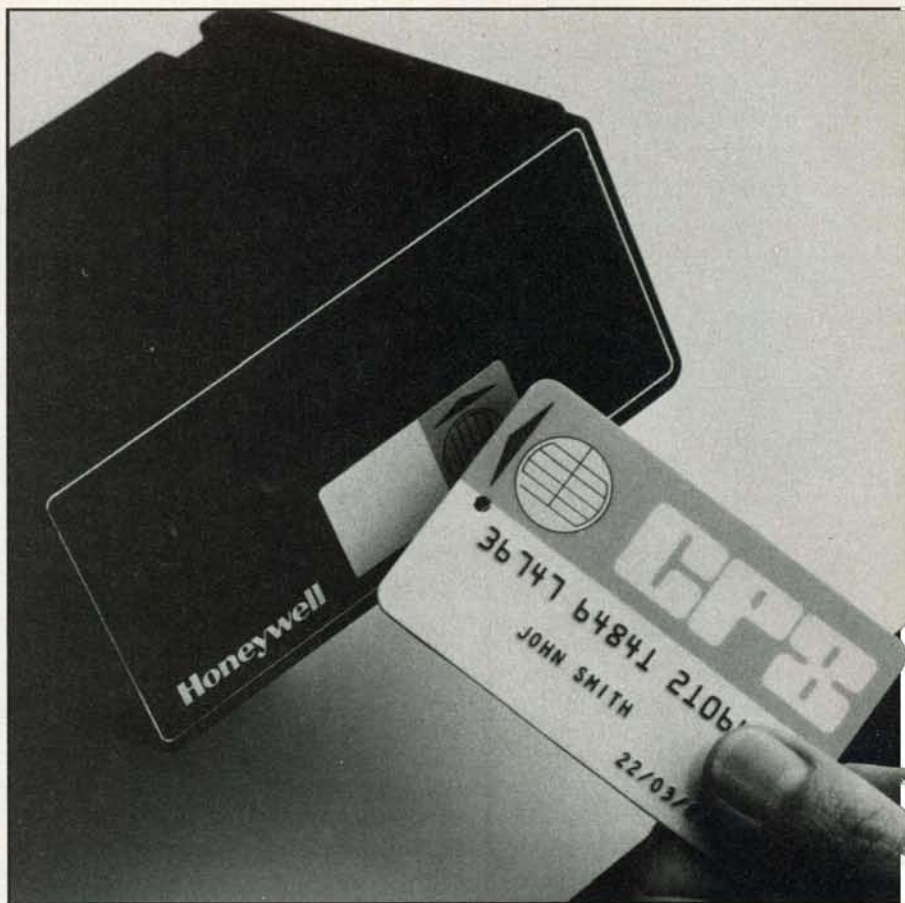

Photo 2: A transaction terminal (or card reader) for an active memory card.

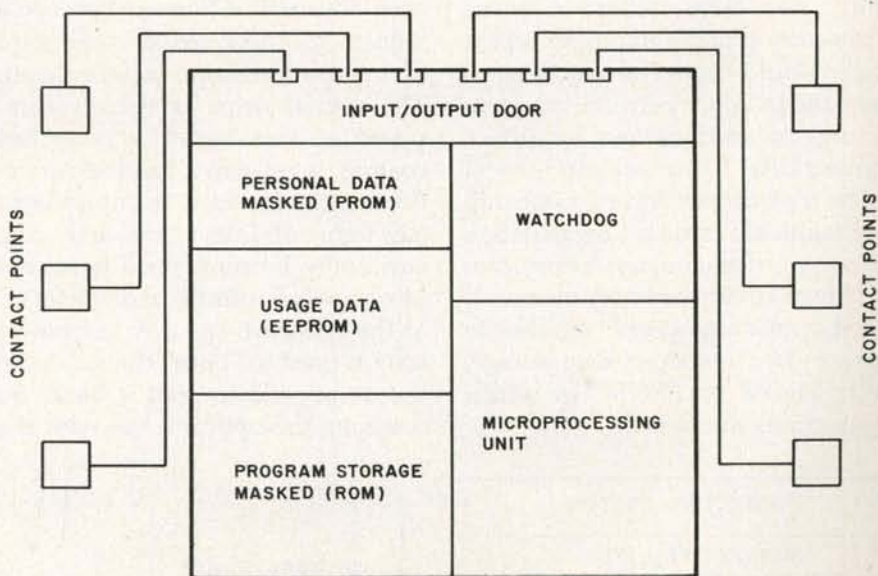

Figure 2: The system architecture of a monochip-based memory card.

data pass between the memory card and the transaction terminal. Figure 1 shows the basic physical layout of a monochip memory card. Figure 2 shows the general architecture of a monochip memory card.

The architecture of multichip mem-

ory cards is basically similar to that of monochip cards except that large memory capacities are possible and each subsystem can be a separate IC. Figure 3 shows a multichip memory and architecture.

Data is typically transferred by an

TO CONTACTS ON SURFACE
OF MEMORY CARD

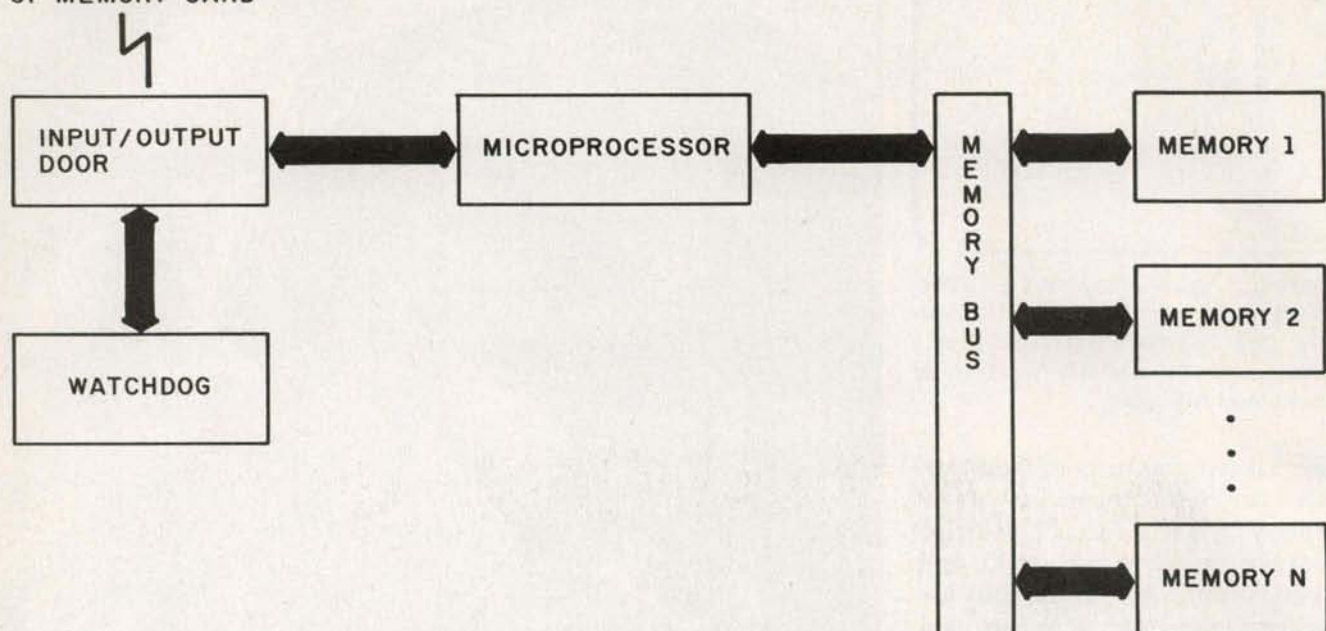

Figure 3: The system architecture of a multichip memory card. Each block represents a separate integrated circuit.

I/O door. This doorway is similar to a universal asynchronous receiver/transmitter (UART) and is monitored by a *watchdog*—the “security officer” of the memory card. The function of the watchdog is to make certain that the I/O transactions are valid. For example, successive attempts to initiate a transaction using improper access codes would cause the watchdog to close the I/O door permanently, rendering the card useless for future transactions.

The memory section of monochip and multichip cards is a combination of four types of memory: factory-programmed ROM (read-only memory), RAM (random-access read/write memory) for temporary data storage, and EEROM or PROM, in which transactions are stored.

The architecture of the optical-stripe memory card is relatively straightforward. A special material, used in the manufacture of videodisks, is placed on the back of a standard credit-card-shaped carrier. At a glance, the average person may not even notice the difference between a regular magnetic-stripe credit card and an optical-stripe memory card. The special stripe is actually composed of four layers: a protective coating, a reflective layer, a nonreflective layer, and a substrate layer (see figure 4). Data is encoded on its surface by burning small holes approximately 5 microns in diameter into the reflective layer. A low-power laser is used to “burn” the data onto the stripe and to read it back. By scanning the optical stripe with the

laser, a bit stream of data is produced. Figure 5 shows what happens when a laser scans the optical stripe.

Memory-Card Terminals

Because transaction terminals are necessary for a complete memory-card system, a brief discussion will help to understand how the whole system works.

A transaction terminal is a communication station used to transfer information into and out of memory cards. Basically, transaction terminals consist of two parts: a display with an attached keypad and a memory-card interface. The display and keypad could be a standard serial terminal. The memory-card interface “customizes” the transaction terminal for a particular type of memory card. There are two types of interfaces: one for optical-stripe memory cards and one for monochip and multichip memory cards.

The terminal interface for an optical-stripe memory card contains a computer-controlled laser data-transfer scanner. This scanner knows how to interpret or write dots on the memory card into meaningful data. Because this type of adapter needs a computer and a laser to read the memory card, it would be more expensive to manufacture than the

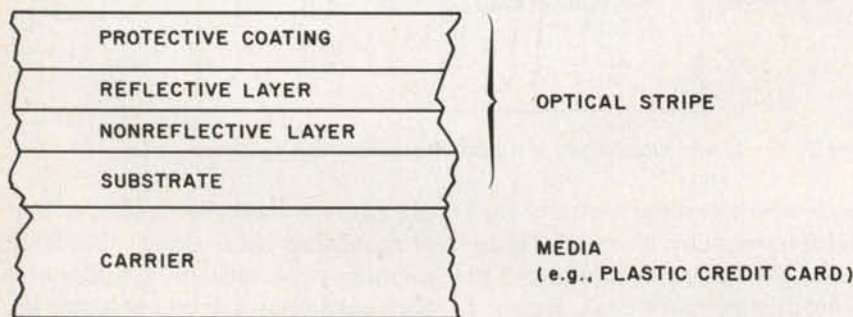

Figure 4: The physical layout of an optical-stripe memory card. The material on its surface is similar to that used on laser videodisks. A laser is used to read and write the transaction information.

APPLE®

Compatible

IBM-PC

Compatible

S-100

Compatible

• CROMEMCO •

Introducing the C-10MP Package. This new system couples the popular C-10 hardware and software developed by Cromemco with the most popular software offered by MicroPro.

Word Star — Info Star — Calc Star — Mail Merge
List Price \$2195 Our Low Price \$1975
— Other Cromemco Systems from
Mini Micro Mart —

C-10 Super Pack\$1599
CS-1 with Z-80A, 64KZ, 2DS/DD 5 1/4 Drives 3389
CS-1 with DPU, 256KZ, 2DS/DD 5 1/4 Drives 4239
CS-1HD with DPU, 256KZ, 21MB hard disc 6789

We also carry the entire Cromemco line of S-100 board level products and software
Cromix\$499 CDOS\$79

• EAGLE PC •

Simply, a better PC! 128k RAM (expandable to 512 on the main CPU board), DS/DD 320k disc drives, serial ports, 1 parallel port, MS-DOS, Eagle Calc and Eagle writer included.

The EAGLE SPIRIT portable w/10 MB hard disk is now available.

• COLUMBIA VP PORTABLE •

Featuring IBM-PC compatibility teamed with the most comprehensive software package in the industry. Includes 128k RAM, 2 5 1/4, 320k drives, and a 9 inch 80x25 display.

• SANYO MBC550 •

Not only is the Sanyo MBC550 priced less than one-third that of a comparably equipped IBM-PC. It is also less expensive than most 8 bit computer packages. Includes a 160k drive, 128k RAM, M5-DOS, Word Star and Calc Star.

• MORROW DESIGNS •

Micro Decision w/terminal & software
MD2 — 2 drivesCall
MD3 — 2 DD drivesCall
MD11 — 1 floppy & 10 MB Hard discCall

• ZENITH Z-100 •

ZF-100-21\$2399
ZF-110-222889
ZF-120-222959

• PRINTERS •

Epson
RX80 399 FX80Call
RX80F/TCall FX100 739

Okidata
82A 399 92499
83A 689 93749

Star Micronics
Gemini 10X299 Stx-80179
Gemini 15499 New DeltaCall

Diablo
620 998 630R-1551849

NEC
35101599 77101999
3530Call 7730Call
3550Call 7750Call

Qume
11/401410 11/551599

Silver Reed
Exp 550 699 Exp 500 499

We also carry Alphacom, Anadex C.I.TOH, Daisywriter, IDS, Mannesman-Tally, Smith-Corona, Texas Instruments, and Transtar printers. We have cables, printwheels, ribbons, diskettes, surge protectors, and other accessories for your system, in stock at outstanding prices.

• TERMINALS •

Televideo
910\$499 Esprit Systems
914619 Esprit II549
924739 Esprit III669
925749 Esprit III (color)Call
950945 Exec 10/102Call
9701099 Exec 10/25Call

Wyse Lear Seagler
WY-50Call ADM3A535
WY-100845 ADM11589
WY-2001095 ADM22595
WY-300Call ADM36999
Zenith Z-29 \$699 ZT-10 \$429 ZT11 \$499

• MONITORS •

Amdek Zenith
300G139 123 12 in. Gr.118
300A159 122 12 in. Amber145
Color I299 131 Med. Res. RGB319
Color II449 135 High Res. RGB 549
Color III385

• IBM-PC BOARDS •

Amdek MAI Graphics Board\$499.00
AST Research I/O Plus\$139.00
AST Research 3270 Bisyng EmulatorCall
Baby Blue CP/M Board499.00
CCS 132 Column Super Vision Board680.00
Plantronics Color Plus Board419.00
Quadram Quadboard 64K285.00
Quadram Quadlink Board549.00
64K RAM Chip kits65.00
Microsoft 256K RAM board445.00
Microsoft 64K System board275.00
Tecmar 1st MATE board295.00
Tecmar Graphics Master boardCall

• S-100 BOARDS •

Advanced Digital Super 6/6mhz Board\$759.00
Advanced Digital CP/M 3.0350.00
CompuPro CPU-Z 6mhz 2-80249.00
CompuPro CPU-8085/88359.00

We also carry S-100 boards from California Computers Systems, Dual Systems, Memory Merchants, North Star, Scion, Systems Group and many more.

• DISC DRIVES •

Rana Elite I w/controller (Apple II)\$359.00
Rana Elite II w/controller (Apple II)529.00
Rana Elite III w/controller (Apple II)649.00
Rana 1000 (for Atari)359.00
Tandon TM100-2 DrivesCall
Tandon TM-55-2 1/2 Height DrivesCall
Shugart 8" SS Drives350.00
Shugart 8" DS Drives450.00
Corvus 6MB Hard Disc1869.00
Corvus Mirror Back-up639.00

• MODEMS •

D.C. Hayes Novation
Smartmodem 300 Call D-Cat155.00
Smartmodem J-Cat110.00
1200529.00 Apple Cat II279.00
Smartmodem 103 Smartcat199.00
1200B499.00 212 Smartcat429.00
Signalman Mk II .79.00 212 AutocatCall
U.S. Robotics
Password359.00



MasterCard and Visa Accepted



Separate specialized sales staff for

Mini Micro Mart, Inc.

943 W. Genesee St. Box 2991 Syracuse, N.Y. 13220

(315) 422-4467 TWX-710-541-0431

Personal
Computer
Systems
P.O. Box 3125
Syracuse, N.Y. 13222

(315) 478-6800

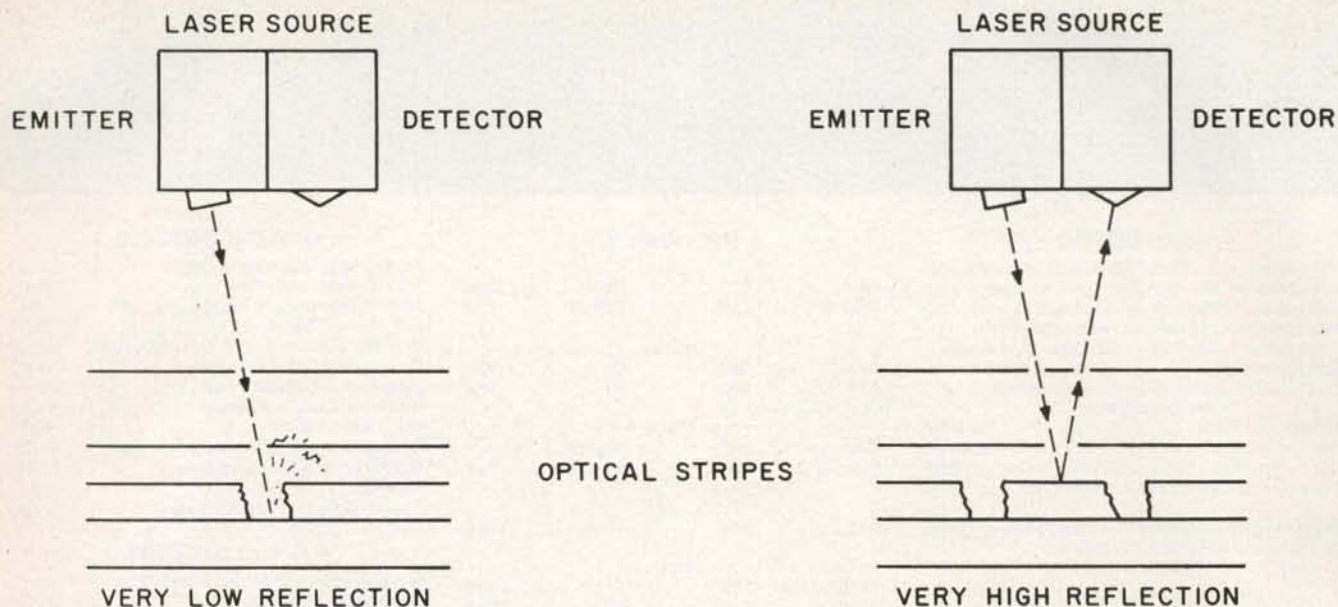

Figure 5: The process of reading data encoded on an optical stripe. On the left, the laser beam encounters a hole written in the reflective layer so no light reaches the detector. On the right, the beam is reflected to the detector from an undisturbed section of the reflective layer.

interface for monochip and multichip memory cards.

A terminal interface for monochip and multichip memory cards is no more than a small housing with a mechanical device to connect the memory card to the terminal's contact points. These points provide power to the memory card and serial communications capability to the display and keypad. Information can be exchanged as long as the transaction terminal adapter is connected to the memory card.

Memory-Card Packaging

By definition, memory cards must

be small enough to be carried conveniently. The most common package for memory cards resembles a credit card. However, there are possible drawbacks to incorporating electronic circuitry within a 30/1000-inch thickness of plastic. Manufacturing the plastic card liberates corrosive gases that can affect integrated circuits. Furthermore, producing such a package is difficult using conventional semiconductor fabrication techniques.

Fortunately, a process known as tape-automated bonding (TAB) solves most of these problems. It's currently used to manufacture such items as

electronic watches and very thin pocket calculators. TAB originated in the U.S. in 1969 and uses a flexible printed-circuit carrier tape, which looks like 35mm movie film, to which an IC is bonded and tested (see photo 3).

Memory-Card System Costs

Card costs will depend on two factors: the technology used and the volume of production. In high volume, optical-stripe cards should cost about 50¢ each, monochip cards about \$4.50 each, and multichip cards about \$8 each. In low-volume production, these prices would be significantly higher (see table 2).

The cost of the transaction terminal must be considered in addition to the cost of the distribution and manufacture of the memory card. A simple transaction terminal for active memory cards may be priced as low as \$250, whereas a transaction terminal for passive memory cards will cost at least \$1500. These costs are significant because anyone wishing to use a memory card will need a reading device.

Security

It stands to reason that the more you need to protect the information on your memory card, the more valuable (or private) the information is.

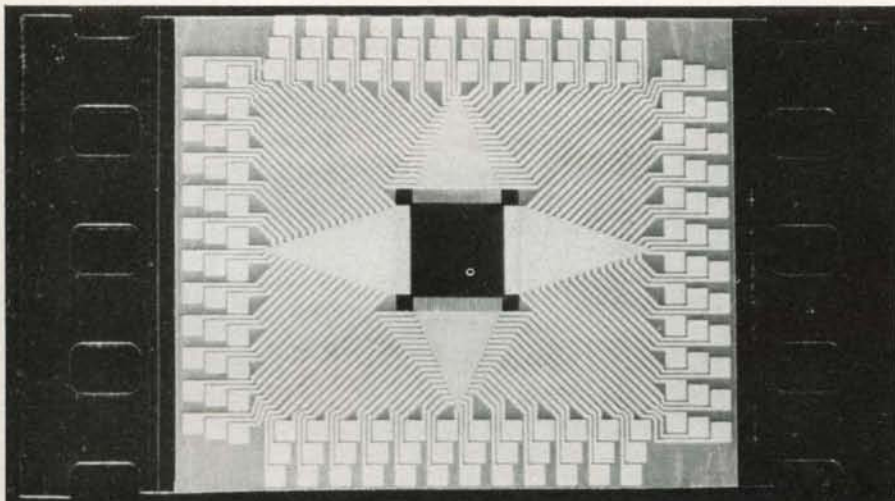

Photo 3: An integrated circuit bonded to a carrier tape or TAB (tape-automated bonding). This process is used to fabricate thin electronic devices such as calculators and memory cards.



LAST NIGHT, COMPU SERVE TURNED THIS COMPUTER INTO A TRAVEL AGENT FOR JENNIE, A STOCK ANALYST FOR RALPH, AND NOW, IT'S SENDING HERBIE TO ANOTHER GALAXY.

NO MATTER WHICH COMPUTER YOU OWN, WE'LL HELP YOU GET THE MOST OUT OF IT.

If you've got places to go, CompuServe can save you time and money getting there. Just access the Official Airline Guide Electronic Edition—for current flight schedules and fares. Make reservations through our on-line travel service. Even charter a yacht through "Worldwide Exchange."

If your money's in the market, CompuServe offers a wealth of

prestigious financial data bases. Access Value Line, or Standard and Poor's. Get the latest information on 40,000 stocks, bonds or commodities. Then, consult experts like IDS or Heinold Commodities. All on line with CompuServe.

Or if, like Herbie, intergalactic gamesmanship is your thing, enjoy the best in fantasy, adventure, and space games. Like MegaWars, the ultimate computer conflict.

To get all this and more, you'll

need a computer, a modem and CompuServe. CompuServe connects with almost any personal computer, terminal, or communicating word processor. To receive an illustrated guide to CompuServe and learn how you can subscribe, contact or call:

CompuServe

Consumer Information Service, P. O. Box 20212
5000 Arlington Centre Blvd., Columbus, OH 43220

800-848-8199

In Ohio call 614-457-0802.

An H&R Block Company

Type of memory card	Low volume	High volume	Memory capacity in characters (bytes)	Cost per character
Monochip	\$16.00	\$4.50	4K	3.9¢
Multichip	50.00	8.00	16K	3.05¢
Optical stripe	4.00	.50	2M	.0002¢
Magnetic stripe	3.00	.60	212	13.6¢
Optical/magnetic dual stripe	8.00	1.10	2M	.0004¢

Table 2: A comparison of card costs at low- and high-volume production, and the cost per character stored for the various memory-card technologies.

For instance, a memory card that contains information regarding your bank accounts would warrant more protection than a memory card used as a ski-lift token. Security of information is a matter of personal judgment depending on how "private" that information is to the individual "owning" it. Most card systems in use today (e.g., paper and magnetic-stripe cards) offer little or no privacy, whereas memory cards would offer several avenues for privacy and for protection of sensitive information.

Memory-card security is achieved by limiting the number of people who have access to the information stored on the card. Furthermore, granting someone access to information on the memory card should not mean he has permission to update, modify, or add information to the memory card. To protect information on the card, data encryption is used. The "key" to the code is jointly held by the card and the owner. However, just knowing the key should not constitute ownership; positive identification of the rightful owner is undoubtedly a requirement for a secure memory-card system. Finally, the memory card must keep a list of people who attempt to query or change information on the card.

Personal identification is possible using any of four different methods. Identification based on possession of an object (a card, for example) is not a positive means of identification because an object might be lost or stolen. Identification based on what a person knows (number or password) is not much better because it, too, can be lost or stolen. This method is currently employed by automatic tellers using magnetic-

stripe cards. An automatic-teller card can be used by anyone if he knows the personal identification number that goes with the card. Both of these methods are easy to implement and inexpensive to produce.

The next two methods provide a much better means of positive identification. The first is based on some unchangeable biological feature, such as a fingerprint, voiceprint, or elec-

Positive identification of the rightful owner is required for a secure memory-card system.

trocardiogram pattern, that would provide virtually perfect identification. Its largest drawback is the expense of implementing the devices. The second method involves a learned trait or habit; the sound of a person's footsteps or a signature are distinctive learned traits. Learned traits are unique enough to be *almost* forge-proof and have the additional advantage of being generally inexpensive to measure. With these positive-identification techniques you can audit all accesses and attempted accesses to a memory card and identify those who made the requests.

Memory cards suffer from the same type of external threats as do credit cards—illegal use of a valid card, modification of a valid card, and production of counterfeit cards. These three threats are compared for both memory cards and current magnetic-stripe credit cards in tables 3a and 3b. Although the probability of

misuse and potential loss is comparable, the countermeasures available to protect memory cards make them preferable to magnetic-stripe cards.

Proponents of the technology are claiming that the memory card is unconditionally secure, but there is no solid evidence to support this claim. Experts in the field of security, cryptography, and microelectronics doubt these claims because of the rapid increase of computer crime in the past few years. Memory-card systems are more secure than the current magnetic-stripe technology, but their level of security in field-usable systems has yet to be determined. Currently there are field tests underway in the United States and in France that may prove to some degree the security of memory cards. However, the ultimate test of memory-card systems comes when they have been released on a very large scale. None of the existing field tests will be able to answer the question of security absolutely.

The Human Factor

The importance of human factors in computer applications is receiving increased attention, which is well deserved because most computer systems have not been designed with the user in mind. They have been designed instead from the standpoint of ease of implementation for the design engineers. Because memory cards are small portable computing devices, it is important that the proper human factors be considered in order to ensure the acceptance of memory cards in particular applications.

Nearly all the applications of memory cards involve financial institutions, which are moving over from standard credit cards. Their greatest

WAIT REDUCTION MADE EASY.

You know how hard it is to wait for the printer to finish before using the computer again. It's wasteful! Counter productive!

The solution: simply install Microbuffer™ printer buffer into the system, in seconds. And you can print and process simultaneously.

With one swift command, all printing data is dumped to the Microbuffer—it handles the printer and frees the computer for other functions.

Presto! Instant wait reduction.

Microbuffer II and II+ for the Apple II, II+, and IIE computers.

Microbuffer II comes in either a serial or a parallel version with 16K or 32K of RAM. Microbuffer II+, available with 16K, 32K or 64K, has both serial and parallel capabilities, so you can control two different printers at once. The Microbuffer II+ has on board high resolution graphics routines for 37 popular printers, and all include expanded graphics capabilities and text formatting in addition to the inherent benefit of letting you use your computer while your printer is working.

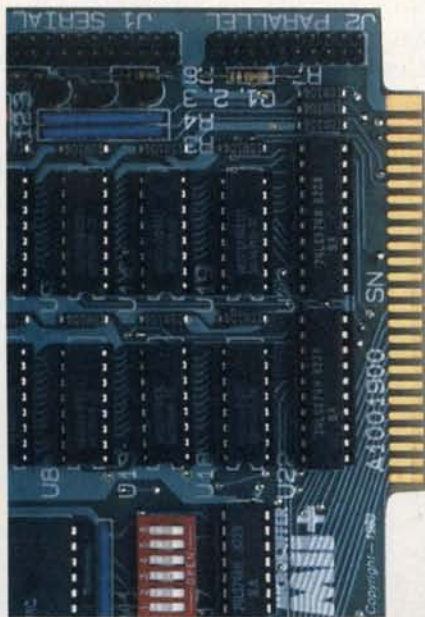

Microbuffer In-line for virtually any computer/printer combination.

These are stand-alone units that install In-line between virtually any computer and printer.

Besides printer buffering, the In-line serial interface (MBIS) can be used to efficiently transmit data from the computer to almost any device using a serial RS-232C interface. The parallel Microbuffer In-line (MBIP) is built exclusively for parallel interfacing, and works exceptionally well in virtually any parallel computer and any parallel printer.

Each of the stand-alone models have controls for making multiple copies (up to 255). With the pause control, printing may be halted at any point and continued later—it will pick up right where it left off. Even while you are printing copies of a document, additional files can be sent to the buffer and they will be processed in turn. Both

come with either 32K or 64K of RAM, and are easily upgradable up to 256K for processing greater amounts of data.

Microbuffer/E for Epson printers.

Fully compatible with Epson MX, FX, RX, and IBM-PC series printers, these easy-to-install boards simply plug inside the printer.

For parallel interfaces, the Microbuffer models MBP-16K and MBP-64K are available.

For serial interfacing, Microbuffer models MBS-8K and MBS-32/64K are available. The MBS-8K supports both hardware and software (X-ON/X-OFF) handshaking; the MBS-32/64K supports three handshaking configurations (hardware, software X-ON/X-OFF and ETX/ACK).

SO WHAT ARE YOU WAITING FOR?



PRACTICAL PERIPHERALS

31245 La Baya Drive
Westlake Village, CA 91362 USA
(213) 991-8200 • TWX 910-336-5431

© 1983 PRACTICAL PERIPHERALS

(3a)

	Probability	Potential loss	Countermeasures	Skill level required
Illegal use of a valid card	high	moderate	moderate to poor	none
Modification of a valid card	moderate to high	serious	poor	medium
Production of counterfeit cards	high	enormous	poor to none	medium to low

(3b)

	Probability	Potential loss	Countermeasures	Skill level required
Illegal use of a valid card	high	moderate	good	low
Modification of a valid card	medium to low	serious	moderate to poor	high
Production of counterfeit cards	low	enormous	poor to none	high

Table 3: Probable abuses of a magnetic-stripe card (3a) compared with the same factors for a memory card (3b).

motivation for shifting to memory cards is to minimize fraud, theft, and misuse of credit cards.

Conventional credit cards have several advantages that have put them into widespread use today. They are easy to use, they don't require any special knowledge by the user, and they are cheap to manufacture (and therefore are generally provided for free). Their biggest fault is that they are very difficult to track if stolen. Another major disadvantage to credit cards is that they are easily counterfeited. Memory cards, on the other hand, can provide all of the advantageous features of a credit card while reducing, or eliminating, these disadvantages. The memory card could also provide a unified method of interaction with a financial institution, such as a bank; the memory card could serve as a credit card, a savings passbook, a checkbook, and an automatic-teller access card all in one. Other information could be carried as well: information on outstanding retirement accounts, auto loans, and savings bonds.

In order for this type of memory card to be readily accepted by new users, the card and the system must be as functional as the system they replace and should offer additional features (e.g., updated interest reporting for passbook savings accounts).

The memory card itself must have certain physical characteristics in order to be acceptable to a large

group of users. It must be small, lightweight, and durable. Also, it should utilize a surface or shape that would let you identify the front, back, right, and left side of the card so it could be used in poor light or by a person who is visually impaired.

Memory cards can provide all of the advantages of a credit card, while reducing or eliminating the disadvantages.

Attention should be paid to the user's access to information within the memory card. This would require a small, portable terminal analogous to the calculators carried in some checkbook cases. A similar read-only device for active memory cards could be made by modifying such a calculator.

Nonfinancial Applications

Two examples of nonfinancial applications are memory-card software packages and memory cards used for on-board diagnostics of a personal computer.

Like any other machine, personal computers can need repair. Unlike other machines, computers cleverly disguise their problems, making them difficult to troubleshoot and

repair. It would be beneficial to have an on-board "tattletale" memory card that could monitor the computer's operation so as to enable rapid detection and correction of problems. This device could keep track of such things as memory faults, bus errors, power-line surges, system glitches, and air temperature and relative humidity inside the computer chassis. The memory card might also perform a type of logic-analyzer function.

A diagnostic card could decrease maintenance costs because it could periodically be removed from the personal computer and its information displayed to determine the number of memory faults that had occurred, or the number of times the critical temperature was reached inside the chassis, thus signaling the necessity of maintenance. Therefore, memory cards for on-board diagnostics could decrease the life cycle costs because repairs would be easier to isolate and fix. Only the memory card would have to be taken to the appropriate service department for playback and inspection to diagnose the problem. This could save the owner of a personal computer a great deal of time, effort, and money.

Figure 6 shows a memory card used as a diagnostician. The "panic" button could be activated by the user if a potential problem is suspected. The button would alert the memory card to a situation in which an error may occur. The memory card could

CHAMELEON

by SEEQUA

\$1995 Complete

The IBM[®] Compatible Computer

BOTH WORLDS OF PROCESSING

Using a unique dual processor technology, the Chameleon by SEEQUA is both IBM-PC compatible and CP/M-80™ compatible providing the largest software support available.

TWICE THE MEMORY

128K bytes RAM are standard, internally expandable to 256K. And 320K formatted disk storage is included.

SOFTWARE INCLUDED

Your computer is delivered with SEEQUA's MS-DOS, compatible with the IBM

standard 16 bit PC-DOS operating system. It includes Perfect Writer for word processing and Perfect Calc for financial analysis. And it has MBasic to let you write your own routines. Chameleon comes standard with 640 x 200 resolution black and white graphics and 320 x 200 resolution color graphics.

EXPANDABLE

Chameleon has both serial and parallel ports standard. You can add an additional serial port or the IEEE-488 port. You can even use IBM PC compatible add-on boards in our optional expansion interface package.

FITS IN YOUR ENVIRONMENT

Chameleon is at home in your office. But its compact packaging makes it easy to carry elsewhere.

To learn more about Chameleon's power, call us at 800-638-6066. We'll put you in touch with our closest dealer.



SEEQUA
COMPUTER
CORPORATION

8305 Telegraph Road
Odenton, MD 21113
(301) 672-3600 or
(800) 638-6066

The following are registered trademarks:
CP/M-80 — Digital Research Inc.
MS-DOS — Microsoft®
PC-DOS — IBM
Perfect Writer — Perfect Software
Perfect Calc — Perfect Software
MBasic — Microsoft®
IBM — International Business Machines



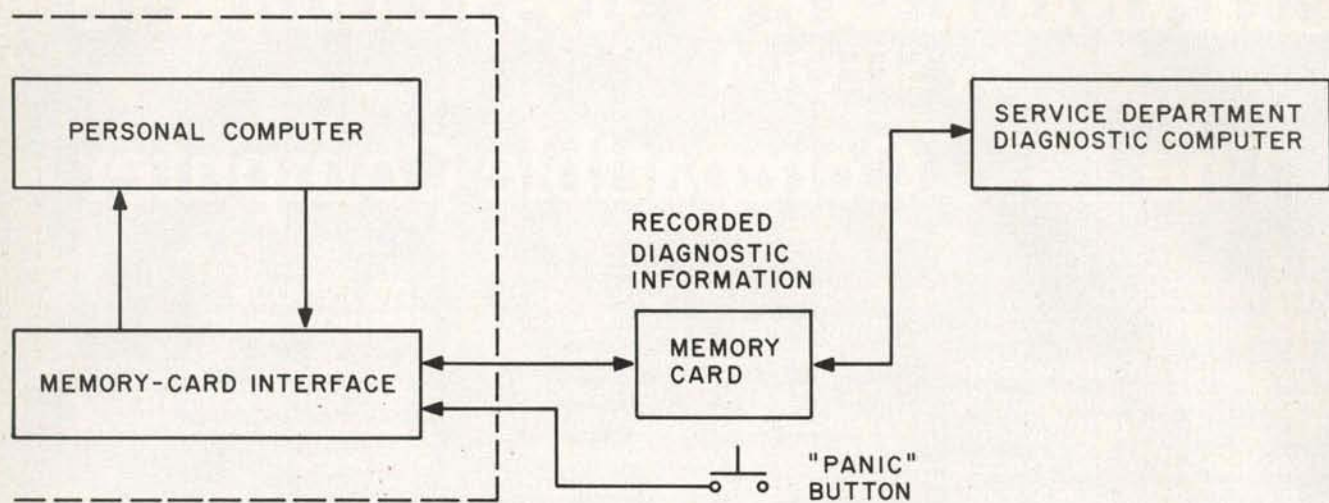

Figure 6: A block diagram of an active memory card used as an on-board diagnostics device within a microcomputer.

then record all the various logic and physical states of the system. This type of diagnostic capability will become more useful, and almost a necessity, as personal computers become more complex.

Eliminating Disks and Pirates

Distribution of personal-computer software has its problems, most of which fall into two main categories: media reliability and piracy. Almost all personal-computer software is distributed on floppy disks, a magnetic recording medium. The data-transfer head reads and writes information as the disk revolves. The data-transfer head must make physical contact with the floppy disk in order to work properly. This contact causes friction that eventually wears out the floppy disk. Dirt, dust, oily fingerprints, and other types of contamination can accelerate this deterioration. Because memory cards have no moving parts, they are very resistant to the contaminants that can ruin a floppy disk. Therefore, memory cards are a more reliable distribution medium than floppy disks.

Memory cards also offer protection against software piracy. Currently, a personal-computer user needs to keep several copies of a program on separate disks to ensure a working copy in case of an operator error or

media failure. Because copies are easy and necessary for legitimate users to make, they are also easy for illegitimate users to copy. This is a major problem in the industry today and one that can be easily combated with memory cards, which cannot be erased by the user or be easily damaged.

Memory cards are more reliable than floppy disks and offer protection against software piracy.

Chip-based memory cards can store approximately 5 percent of the information of a single-sided, single-density 5¼-inch floppy disk (8K bytes versus 160K bytes). Technological advances may help to overcome this drawback.

Alternately, a multiple-card reader could be constructed for virtually the same cost as a floppy-disk drive (approximately \$400). A card reader would enable many programs to be on line simultaneously with improved access time and enhanced reliability.

Chip-based memory cards are not the only type of memory cards that can be used to store information. Optical-stripe memory cards can

store about 4 million bytes per card. This lets a large program or a multitude of smaller programs be stored on the memory card, which greatly increases the applications for personal computers. By using an optical-stripe memory card, books, dictionaries, thesauruses, encyclopedias, and reference books could be bought in machine-readable form inexpensively. Imagine a spelling checker based on a 4-million-byte memory card. A reader for an optical-stripe memory card would be more expensive than one based on chip technology, but if manufactured in large quantities, its cost would probably range from \$400 to \$800. The reader would be about the same size as the current 5¼-inch floppy-disk drive.

Although the technology is yet in its infancy, memory cards may eventually be used by the majority of the population. Applications include security, financial tasks, data storage, and diagnostic capabilities for personal computers. As yet, it is not clear whether active or passive cards will prevail, but memory cards will be part of your life very soon. ■

Mark Mills is facility manager of the Microcomputer Application and Technology Center at Battelle Columbus Laboratories in Columbus, Ohio. He can be contacted at 3118 Essington Dr., Dublin, OH 43017.

THE WY300 TERMINAL GREAT COLOR FOR UNDER \$1000



IF COLOR IS A LUXURY YOU THINK YOU CAN'T AFFORD, THINK ABOUT OUR WY300—the smart color terminal as low as \$975.*

*Quantity 100

The WY300's high-resolution 8-color display adds vivid relief to any text editing or data entry task, without adding significantly to the price you'd pay for monochrome.

Ergonomically designed with a swivel and tilt CRT and a detachable keyboard, the compact WY300 fits into the workplace as comfortably as it does into your budget.

On top of that, the WY300 gives you a host of features like a soft downloadable



character generator; extensive alphanumeric and line drawing symbols; and compatibility with most standard,

monochrome oriented, off-the-shelf software.

Best of all, the WY300 is plug compatible with our monochromatic WY100's and most ASCII terminals. So, using color is as easy as it is inexpensive.

Need more information? Call or write us today. We'd like to convince you our smart color terminal is your wisest buy.

WYSE

Circle 384 on inquiry card.

Make the Wyse Decision.

WYSE TECHNOLOGY 3040 N. First St., San Jose, CA 95134, 408/946-3075, TLX 910-338-2251, Outside CA call toll-free, 800/421-1058, in So. CA 213/340-2013.

Undo.Windows

New Microsoft® Word. It makes your IBM Personal Computer think it's better than a \$10,000 word processor.

With Microsoft Word, what you see on the screen is what you get on the paper. So it's easy to spot mistakes.

Boldface, underline, and *italics* look like this, not this: ^Bboldface^B, ^Sunderline^S, ^Iitalics^I.

And, when you make changes, paragraphs are automatically reformatted. Flush right, flush left, centered or justified. It even gives you several columns on a page, like a newspaper.

Word forgives and doesn't forget.

There's an "uh-oh" command called Undo. Make a mistake? Or just want to experiment? Hit Undo.



Mouse. Finally.

Word undoes your last change and remembers things the way they were.

Word does windows. Up to eight, to be exact. So you can transfer or edit between eight different documents. Or between eight different pieces of the same document.

Word travels fast.

Word has a Mouse, a handy little critter that lets you move copy, select commands and edit faster than you can say "cheese."



Word also lets you create your own style sheets, so you can standardize your documents, memos, files and letters.

It's not surprising that Microsoft has a way with Word. We designed the MS™-DOS operating system that tells the IBM® PC how to think. And we pioneered the first microcomputer BASIC, the language spoken by nine out of ten micros worldwide.

For a few final words, call 1-800-426-9400 (in Washington State call 206-828-8088) for a free Word brochure and the name of your nearest Microsoft dealer.

MICROSOFT
The High Performance Software

Computer-aided Design

Significant CAD power is coming for desktop microcomputers

by Rik Jadrnicek

Computer-aided design (CAD), drawing and designing with the aid of a computer, promises to change our lives dramatically. Not so long ago, we stumbled into air-conditioned computer centers with boxes of keypunch cards and a desire to "see" what would happen. Now all that power sits on our desktops, and as a result pencils, erasers, and perhaps even paper face the prospect of obsolescence.

Today, word processors conquer mountains of text, electronic spreadsheets master number manipulation, and business graphics translate the results into charts, graphs, and slide shows worth a thousand words. And the increasing number of electronic pictures in turn creates the need for a graphics editor—a picture processor similar to a word processor. That way, we can create and edit graphics images, cutting and pasting our way through letters, numbers, and pictures.

The age of computer graphics is finally here. A hardware/software configuration exists for everything from painting illustrations with a color brush to designing and automating the production of a pipe valve. Software tools can manipulate both two-dimensional and three-dimensional images, tools that enable us to create geometric models worth a thousand pictures.

But increased capability and falling prices raise serious questions. What hardware and software do you need? What is available? How do you compare packages? What do the terms mean? Whom do you contact? Should you wait to buy? Unfortunately, the pattern is far too familiar.

This article charts a path through the jungle of hardware and software considerations you face when choosing a CAD package. In it I focus on some of the software and hardware available for your desktop computer.

What Is Computer-aided Design?

Computer-aided design has many potential applications, among them graphics design, illustration, flowcharts, block diagrams, forms design, mapping, printed-circuit board/electrical design, space planning, architectural design, mechanical drafting, and product design. A discussion of solids modeling with shading, animation, and image synthesis on microcomputers is a little premature, but several powerful wire-frame-type three-dimensional modeling packages are available along with some exciting painting software (see photos 1 and 2).

Computer-aided engineering (CAE) ties together such diverse interests as pictures (schematics, assembly and maintenance drawings), cost analyses, structural analyses, production

process plans, material specifications, tool design, and quality control. During this process, CAD graphics interface with a variety of analysis packages through compatible data files.

Computer-aided manufacturing (CAM) uses CAD and CAE criteria to produce a product such as a valve, a tool, or another item. Soon we'll be able to design, analyze, document, and organize the actual manufacture of a product from the original drawing. Both CAE and CAM operations are in their infancy on desktop micros.

With CAD, you draw or edit by entering data through a keyboard or a variety of input devices such as digitizers, mice, light pens, touch pens, trackballs, and image digitizers. The graphics software records the drawing within a world coordinate system and saves its database description. You edit the database and view the results on a monitor, which sends the image you create to a variety of hard-copy output devices including printers and plotters. You can network the database and send it out via modem or create an interface with such programs as Bill of Materials, Stress Analysis, or a variety of CAE/CAM applications.

What Is Available?

Historically, computer graphics started with the early Teletype and

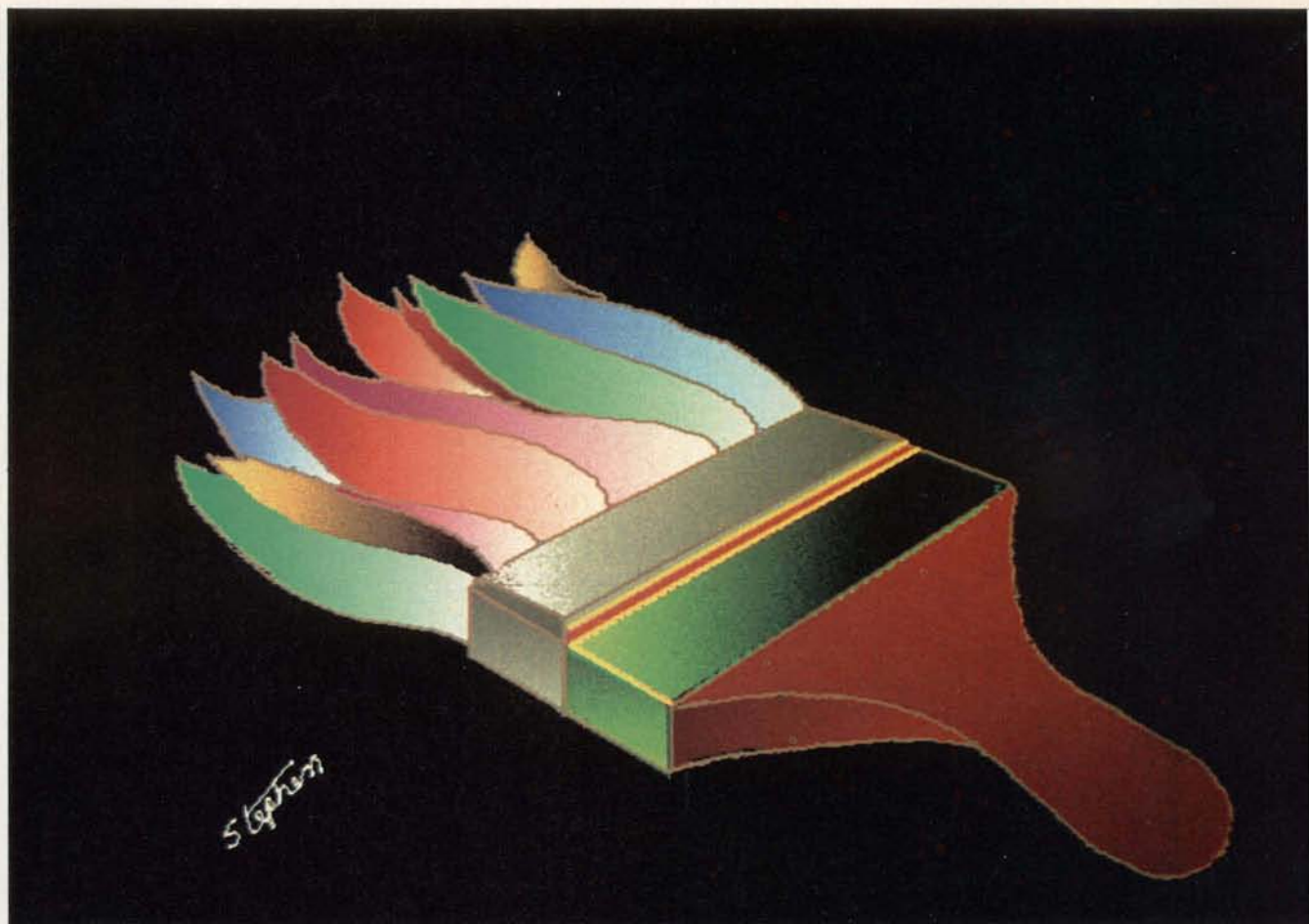

Photo 1: A paintbrush drawn with the pixel-based Easel painting software.

line-printer hard-copy devices of the 1940s. Computer-driven CRTs (cathode-ray tubes) began to display output in the early 1950s. In 1962, Ivan E. Southerland, a young Ph.D. from MIT, formally described a computer system that enabled users to draw. Significant developments in output-device technology and software in the 1970s have made Southerland's dream economically feasible. Currently, more than a dozen software developers are well along the path to creating significant CAD power for desktop computers. These are not expensive dedicated systems or bundled hardware and software configurations that are device dependent; they run on stock microcomputers with few exceptions.

Hardware Requirements

The costs of the hardware and software necessary to configure a CAD system run from \$5000 for a very fundamental floppy-disk system up to

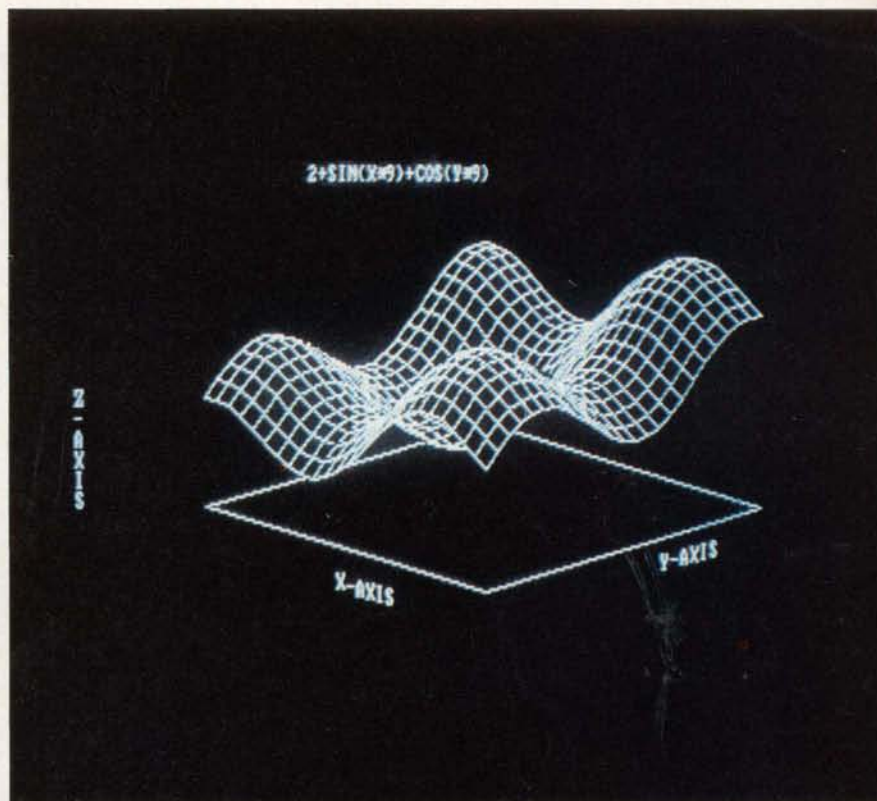

Photo 2: A sample three-dimensional video image produced by Energraphics software.

Processor Support	PC-Draw	CADdraft	Benchmark	Vector Sketch	Drawing Processor	CADplan	AutoCAD	VersaCAD
IBM PC	•	•	•	•	•	•	•	•
IBM PC XT	•	•	•	•	•	•	•	•
Columbia	•	•	•	•	•	•	•	•
Compaq	•	•	•	•	•	•	•	•
Corona				•	12/83		•	•
Eagle PC	•	•	•	•	•	•	•	6/84
Eagle 1630					•		12/83	
TI PC							•	
NEC APC			•		1/84		•	
Zenith Z-100					1/84		•	
Compupro							•	
Televideo							12/83	
Victor 9000		•	•		1/84	•	•	
Digital Microsystems							•	
DEC Rainbow			1/84				12/83	
DEC 350								6/84
Apple II								•
CP/M					•		•	
HP-200 Series								•
Price	\$250	\$495	\$595	\$900	\$995	\$1295	\$1000/ \$1500	\$1995

Table 1: A comparison of computers.

• = existing feature
date = expected release date

Input Devices	PC-Draw	CADdraft	Benchmark	Vector Sketch	Drawing Processor	CADplan	AutoCAD	VersaCAD
Sunflex Touch Pen							•	
Sunflex Touch Pad		•				•	•	
Light Pen	•							
Joystick								•
Houston Instrument Hipad		•	1/84		•	•	•	•
Hitachi Tiger Tablet							•	4/84
GTCO		•		•	•	•		•
Summagraphics			1/84		•		•	•
Kurta			•					4/84
Mouse Systems Mouse		•				•	•	
USI Optomouse							•	

Table 2: A comparison of input devices.

• = existing feature
date = expected release date

\$50,000 for a dual 68000-based microprocessor with a 20-megabyte hard disk and 1 megabyte of RAM (random-access read/write memory). The latter system is capable of very good two-dimensional and three-dimensional commercial animation graphics.

Ideally, the CAD software you choose will support a variety of computers (table 1), input devices (table 2), graphics processors, and output devices (table 3).

Computers

A wide variety of desktop micro-

computers can be configured for computer graphics work. This added capability usually doesn't interfere with the word processor, the spreadsheet, or any other software in your library.

These computers fall into four general categories:

1. Atari, Apple, and other computers with proprietary operating systems using the 6502 microprocessor chip. Accelerator boards provide 8088 and 68000 chips for some of these.
2. S-100, STD, Multibus, and other

systems like the Victor 9000 using the Z80 or 8086, 8087, and/or 8088 microprocessors.

3. IBM PC XT and the growing number of PC look-alikes using the 8086/8088 microprocessor and optionally the 8087 numerical data coprocessor.
4. Unix systems using the Motorola 68000 microprocessor.

The Intel 8088 microprocessor is faster and more powerful than the Z80 but less powerful than the Motorola 68000. Some systems, such as the Victor 9000, come from the fac-

Now 60 MHz or 100 MHz Tek quality is just a free phone call away!

**New lower price!
100 MHz 2235
now just \$1650.**



Tek has expanded its best-selling 2200 scope line up to 100 MHz. And brought it all as close as your phone. Tek's revolutionary, reduced-component architecture brings unprecedented quality, reliability and affordability to the 60 MHz 2213 and 2215, and now, the 100 MHz 2235.

All three of these lightweight (13.5 lb.) scopes feature 2 mV/div vertical sensitivity and 5 ns/div sweep speeds, plus a complete trigger system for stable triggering on digital, analog or video waveforms.

Scopes with a comprehensive 3-year warranty*... probes...and expert advice. One free call gets it all! You can order, or obtain literature, through the Tek National

	2213	2215	2235
Bandwidth	60 MHz	60 MHz	100 MHz
No. of Channels	2	2	2 + Trigger View
Alternate Sweep	—	Yes	Yes
Vert/Trig B/W Limit	—	—	Yes—20 MHz
Single Sweep	—	—	Yes
Accuracy: Vert/Horz	3%	3%	2%
Delay Jitter	1:5,000	1:10,000	1:20,000
Trigger'g Sensitivity	0.4 div at 2 MHz	0.4 div at 2 MHz	0.3 div at 10 MHz
Input R-C	1M Ω -30pf	1M Ω -30pf	1M Ω -20pf
Variable Holdoff	4:1	4:1	10:1
Price	\$1200†	\$1450†	\$1950† Now \$1650†

Marketing Center. Technical personnel, expert in scope applications, will answer your questions and expedite delivery. Direct orders include operating and service manuals, two 10X probes, 15-day return policy, and worldwide service back-up.

**Order toll free:
1-800-426-2200,
Extension 111.**

In Oregon call collect:
(503) 627-9000, Ext. 111.

†Price FO B. Beaverton, OR.
*3-year warranty includes CRT and applies to 2000 family oscilloscopes purchased after 1/1/83.
Scopes are UL Listed, CSA and VDE approved.

Tektronix
COMMITTED TO EXCELLENCE

Circle 350 on inquiry card.

Output Devices	PC-Draw	CADdraft	Benchmark	Vector Sketch	Drawing Processor	CADplan	AutoCAD	VersaCAD
Graphics Boards								
IBM Graphics Board-Color	•	•	•	•	•	•	•	•
IBM Graphics Board-B&W Single-Screen Version	•	•				•	•	6/84
Hercules					•		•	2/84
Scion		12/83		1/84		12/83	12/83	
Techmar	3/84						12/83	2/84
Control Systems Artist		12/83				12/83		2/84
Color + Plantronics	3/84	•	1/84			•		•
Vectrix 384							•	
Pen Plotters								
Houston Instrument:								
DMP-7					•		•	•
DMP-8					•		•	•
DMP-29	•	•			•	•	•	•
DMP-40	1/84	•	•	•	•	•	•	•
DMP-41	3/84	•		•	•	•	•	•
DMP-42	3/84	•		•	•	•	•	•
Hewlett-Packard:								
HP-7470A	•	•		•	•	•	•	•
HP-7580	•	12/83		•	•	12/83	•	•
HP-7585	•	12/83		•	•	12/83	•	•
IBM XY749	1/84	•		•		•		
IBM XY750	1/84	•		•		•		
Calcomp		•				•	11/83	
Sweet-P			•				•	4/84
Strobe 100				•			•	
Strobe 8-pen				•			•	
Graphics Printers								
Epson MX-80	•	•	•	•		•	•	2/84
Epson MX-100	•	•	•	•		•	•	2/84
Epson FX-80/100	•	•	•	•		•	•	2/84
Citoh 1550	•							
IBM Graphics	•	•	•			•	•	2/84
Okidata 84/92	•							
Okidata 93	•							
NEC 8023	•		•					
NEC PI	•		•					
Mannesmann Tally	•		•		•			
Gemini-10/15	•							
IDS Prism	•							
Versatec		1/84				1/84		

Table 3: A comparison of output devices.

• = existing feature
date = expected release date

tory equipped with full graphics capability. They are the easiest to configure and generally the least costly. If you do need to configure a system for graphics capability, in a price/performance evaluation the IBM PC and its look-alikes come out on top, followed by selected S-100 systems (see photos 3 and 4).

Input Devices

Although you can use the keyboard as a primary input device, a

specialized device is much easier and more efficient.

With manual drafting methods and a conventional drawing board, you physically draw a line from one point to another. You do the same thing with a digitizer or digitizing tablet (electronic drawing board), but rather than use a pencil or pen you use a *puck*, cursor device, or stylus. You can trace a library of drawing parts you have created over the years for use in assembling your current drawings. You can also work with drawings

created manually by your co-workers.

Touch pens and light pens enter data points directly onto the monitor screen—if you don't mind holding your hand in the air—but they don't trace manually created drawings.

Similar to digitizing tablets but without the expense or the accuracy, mice keep your hand in a restful position on a table or grid plate. Trackballs, which use a revolving ball like some video games, video-camera input, and even joysticks are available. It's a good idea to combine the key-

Let the **ANGEL** do the waiting

It has been said that 30% of micro-computer users will eventually purchase a buffer. For business users, a buffer pays for itself in the time and money it saves the user not waiting for the print-out. The more you use your printer the more you need a buffer.

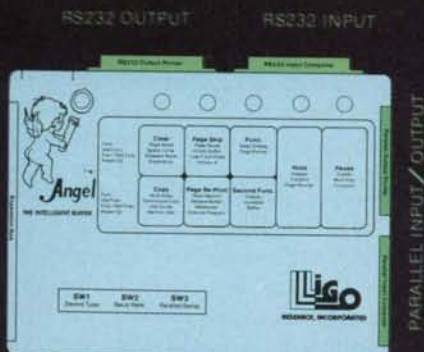

ANGEL HAS ALL INTERFACES

ANGEL. The Intelligent Buffer is the perfect mate for your system. It has both RS232 Serial and Centronics Parallel Interface, and can convert from serial to parallel and parallel to serial. It is truly a universal buffer that is compatible with most microcomputer systems. This versatility means when you upgrade your system you can use the same ANGEL.

ANGEL passes data to the printer exactly as received from the computer and is independent of software — including graphics. The ANGEL also features an innovative page mode which carefully monitors the page break data during printing. Under the page mode you can reprint the last page, jammed pages, do page skip as well as page pause for single-sheet feeding.

ANGEL is an intelligent buffer with 12 additional functions that may be activated when you need them; pause, hold, copy, clear, self-test, page reprint, page skip, page pause, multi-copy, continuous copy, space compression, hex dump, etc.

ANGEL comes with 64K bytes of memory, ample for most applications. Additionally, you may activate the space compression mode which in many cases extends the buffer capacity to more than 128K.

ANGEL is designed for all types of users — even those without technical background. All switches, including baud rate selection and parallel / serial configurations are externally accessible. Installation is a matter of connecting cables, setting up DIP switches and power-on. Ligo Research makes available standard cables/adaptors for most popular computer/printers. Connection diagrams are also provided for users who want to make their own cables.



With such a good product available now, why wait for your printer to catch up? You can order the ANGEL from your dealer or call direct to 1-800-323-3304. TODAY!



396 E. 159th St., Harvey, IL 60426 • 1-800-323-3304, 1-312-331-8797 • Telex: 910 257-0850 LIGORSCH, HARV
In Canada: Computer Age, Ltd., P.O. Box 730, Nobleton, Ontario, LOG 1N0 • 1-416-859-0370

Ligo
RESEARCH, INCORPORATED

Circle 215 on inquiry card.

Software Features to Look For

On-line Status

On-screen status items, such as layer number, grid status, lines of type, the cursor's x-y coordinate position, and various interactive prompts, are helpful. The ability to get information about your drawing or entities within it is also helpful. For example, if you want to know the size of your coordinate system, the exact location of a particular item, or the default status of various program parameters, the on-line status feature gives you access to this information.

Menus

While it is cumbersome and frustrating in the long run to choose program functions from an A, B, C type of menu, command menus that you point to on the screen are a desirable feature. In addition, if you have the freedom to design your own menu, you can develop a custom application using only those selections that apply to your drawing needs. For example, you may want to use only 10 of the 40 menu commands and organize them conveniently for your own frequency of use. The program may let you put predefined shapes (icons) in the menu for easy selection and placement in your drawings.

Macros and Command Files

Macros and command files are groups of program instructions and other data-entry items that can be executed with a single keyboard sequence. For example, if it takes you five steps to merge a disk file into your current drawing, you can place the necessary instructions in a macro/command file and execute it with a single command. You can even place these macros as selections on your menu.

Further custom flexibility exists if the software lets you stop during macro execution and issue a prompt for data entry. For example, you can develop a menu item that creates a shape; goes to a particular location; enters text mode; sets the font, size, and direction; and prompts you to enter the text string. The more powerful the macro capability, the more you can develop custom or turnkey applications.

Ideally, you can enter the program and execute the first command by making one entry at the A > prompt. This allows you to enter the program from a batch file, draw for a while, perform some other macro functions, exit cleanly, and then reenter

the original batch file. Turnkey CAD, CAE, and CAM operations then become feasible.

Grid

The world coordinate system and the coordinate system you define within it break down into grid points that serve as reference points while you are drawing. Look for the ability to specify the distance between grid points and to choose a different scale for the x and y axes. You don't want the grid points to become part of the database or to appear on the printer or the plotter. Ideally, they turn inverse when they appear in a solid fill.

When you activate grid lock or grid snap, another desirable feature, the data points you enter "snap" to the nearest grid point no matter where you enter them. This permits a degree of error when entering data points. Notice in the figure opposite how the actual figure (solid line) differs from the digitized line (dotted). This is especially helpful when you are trying to align different drawing layers, close irregular shapes, or enter data points quickly and accurately.

The ability to vary the distance between grid points becomes important with grid lock/snap. It allows you to change the coarseness of your drawing resolution as you fine-tune. You can, for example, zoom in on one square inch, snap to the nearest hundredth-inch for detail drawing, then zoom back out, snapping to the nearest quarter-inch.

With the incremental snap feature, your cursor stops only on grid points or resolution points as it moves across the screen.

Aspect Ratio

If "what you see is what you get" is important to you, make sure the program corrects for the aspect ratio of your display devices. Aspect ratio is a design engineering term that refers to the ratio of display width to height. For example, a 320 by 200 monitor presents a circle as an ellipse and a square as a rectangle unless the software makes the right adjustments. This is quite important if proportion matters during data entry or if you are using the display for a final presentation.

Data Entry

Shapes, blocks, groups, components, and dictionary items. These

are all different names for similar drawing elements. You want to be able to create drawing elements, store them in a parts library, and merge them into your current drawing, rescaling and rotating them as desired. The ability to automate repetitive drawing tasks is one of the more important features of a CAD program. For example, if you are an architect and want to call one of a variety of drainage systems into a foundation/site plan, you can retrieve the right one from your drawing library on disk rather than redraw it from scratch.

Tablet or tracing mode. This can be extremely important for merging existing manual drawings into your library. Look for the ability to enter a drawing that is larger than the surface of your input device. For example, you may want to enter a 24- by 36-inch drawing you did 10 years ago through your 11- by 11-inch digitizer tablet and make it part of your drawing library on disk.

Keyboard entry. The ability to enter data from both a keyboard and an optional input device is desirable. Positioning the cursor, entering relative or absolute coordinates, and keying formulas that result in appropriate curves are all important. Absolute coordinate entry is essential.

Freehand draw or sketch mode. Drawing from vector point to vector point and snapping to grid points has its advantages, but so does sketching a freeform line. Different programs handle this capability quite differently. Sometimes the sketched line becomes one database item; other times the software stores it as a user-defined collection of data points. If this capability is important to you, look at the method of updating the database, the amount of storage used, and the flexibility available for manipulating your sketches.

Drawing primitives. Become familiar with the primitives (lines, arcs, circles, rectangles, etc.) and attributes (line type, width, color, etc.) available in a particular program. Also check the number of ways you can define an object. For example, you may want to define a circle as a center and radius, two points determining a diameter or three points on the circumference.

Many other primitive capabilities are shown on the accompanying tables. They include cross-hatching or filling an area (with or without user-definable patterns), fillets and Bezier curves (see glossary on page 208), and built-in math calculations.

GRID Snap/Lock

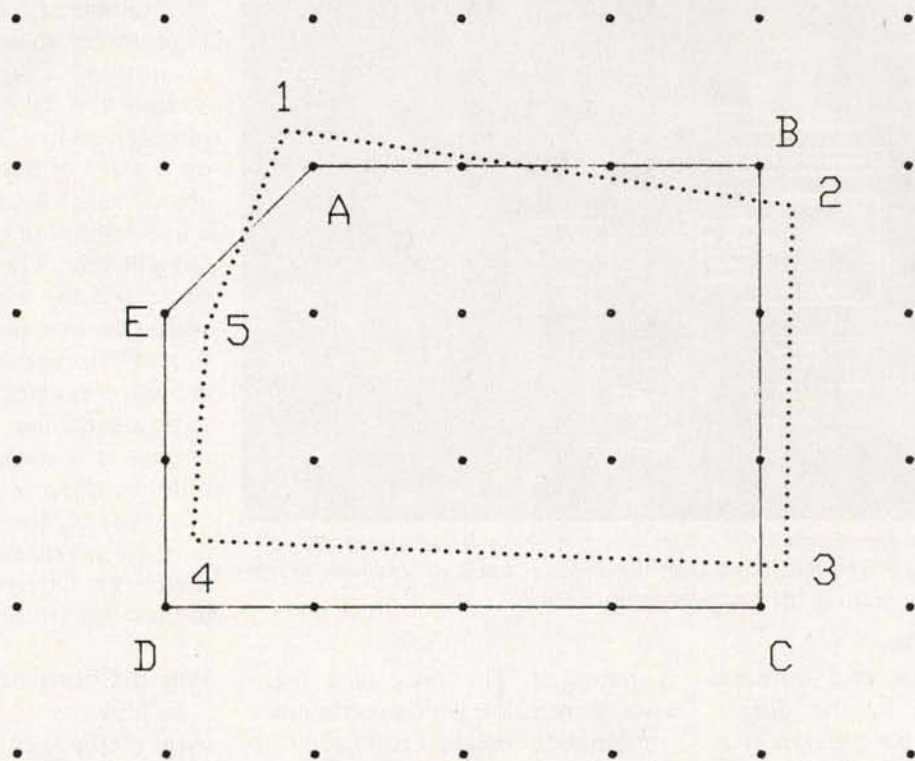

Grid snap permits the perfect alignment of data points by forcing them to snap to predefined grid points. Note the solid-line shape you create even when you enter points in the dotted-line shape. This becomes important when registering one layer of a drawing with another.

If you need autodimensioning, be sure it suits your needs. Some things to look for are angular, radial, and autostacking features and the ability to customize dimension elements.

The primitive features available in CAD software vary widely. The more flexibility you have to customize the primitives, the happier you will be in the long run.

Layers. If the CAD software provides multiple layers, your drawing power magnifies. Layers are like pieces of tracing paper stacked one on top of the other that you turn on and off individually for display and hard-copy output. For example, if you are designing a house, you can develop a site plan on layer one, a foundation plan on layer two, a floor plan on layer three, an electrical plan on layer four, a plumbing plan on layer five, and a roof plan on layer six. This enables you to see the overall house with all its details integrated while you have the freedom to see and draw each individual plan independently. If you turn off all the layers except the electrical plan, you can send that plan to a hard-copy device. If you turn on the floor plan, you

can conveniently work on your electrical drawing against the appropriate background.

Rubber banding. A visual aid when drawing, the line stretches like a rubber band while you pull it to the next data point. Rubber banding helps in trying to conceptualize the drawing process.

Editing Features

The ease and power of the editing capability are important considerations with CAD software. You must be able to manipulate the images you create while rescaling, rotating, and moving them around. This allows you to correct mistakes and freely modify your drawings.

If, in the example of the house plan, you previously completed a drawing of a house in a completely different scale from the site plan, the ability to load the old house plan and merge it with the new site plan while rescaling it and rotating it for proper sun exposure would be extremely helpful.

Partial delete. A feature quite often absent in lower-priced CAD systems is the ability to delete part of a previously drawn

image without having to erase and reconstruct the whole thing. For example, if you break a house wall and put in a window, you change the number of entities and data points updating the database. This feature, which is quite important in editing drawings, allows you tremendous flexibility. Without it, you need to preplan, resulting in a rigid drawing lacking in spontaneity.

Windowing. This is the process of defining an area you wish to manipulate by setting up two opposite corners of a rectangle that contains it. For example, you can window an area in order to delete, move, copy, save, or zoom in on it. With the rubber-banding feature, the window dynamically expands and contracts after you define one corner, so you can shape the window and see the area defined.

Others

The list continues (tables 5, 6, and 7), but you can readily see that CAD is very powerful. The best test is an actual test; take a drawing in, try out the software, and make sure the features you need are there.

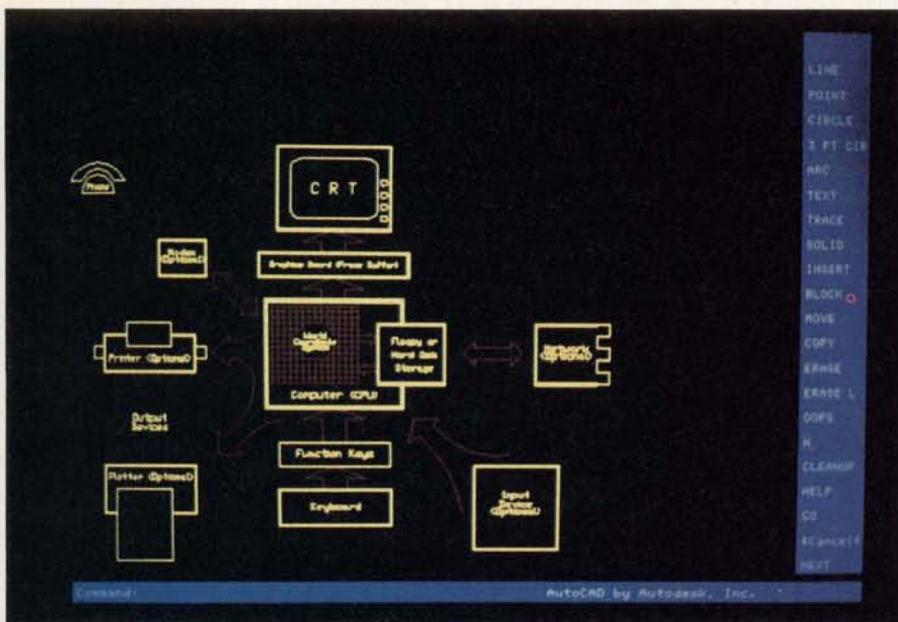

Photo 3: The hardware elements of a CAD system drawn using vector-based AutoCAD software and displayed by a 640 by 400 Vectrix Graphics processor and high-resolution Vectrix color monitor. Note that much of the configuration is optional.

Text continued from page 176:

board, function keys, and an input device determined by the design work you do. Look for software that supports a variety of input devices in case your preferences change.

Output Devices

If you desire a copy of your work, you will be using a hard-copy device. Choose CAD software that gives you output options—the more the better. A mature program supports a variety of devices that output drawings to dot-matrix printers, ink-jet printers, pen plotters, electrostatic plotters, or microfilm recorders.

For applications requiring accurate representation of colors and high-quality hard copy, such as painting packages, you can photograph the monitor. A variety of photographic and video interfaces are available.

Graphics Processors

The graphics processor and the graphics monitor determine the quality of the video-display image you view during editing. The processor translates the database image in RAM for display on the monitor. If either of these devices has poor resolution, the image is less than representative.

The area of video feedback during CAD work needs improvement and

is getting it. The price of a high-resolution color processor/monitor combination dropped from \$5000 to less than \$2500 in one year. Many high-resolution graphics processor boards now available (Scion, Conographics, Techmar) are reasonably priced. Very high quality color graphics monitors range between \$1500 and \$10,000 at this time, but prices are approaching the economic means of the desktop computer user.

Drawing Resolution

The concept of resolution is impor-

tant to understand if you wish to become aware of current and future trends in computer-aided design. The number of dots or elements used to represent an image determines its resolution. Consider drawing a straight line. Take a pencil and begin placing dots in a line from left to right on a piece of paper. Make the dots about 1/4 inch apart. You are creating a low-resolution representation of a straight line. The finer your pencil point and the more dots you place within the line, the higher the resolution of your drawing is. If you place enough dots along the line, it appears to be a solid line. The same concept applies to circles, solids, text, and other shapes.

In general, the higher the resolution, the smoother and more accurate the image. Obviously, you want the highest resolution possible.

World Coordinate System

Each piece of CAD software has its own method of mapping a coordinate system, usually called the world coordinate system.

In a pixel-based system, the software maps out a coordinate system in RAM relative to the number of pixels available within the graphics processor/monitor. Each pixel becomes a coordinate point within the world coordinate system. You represent an image by the lit or unlit status of each pixel location (data point) in the image database. This method is com-



Photo 4: One example of a CAD system, an IBM PC with a Houston Instrument Hipad 11 by 11 digitizer and DMP-40 plotter.

PURE POWER CONTROL CENTER

Introducing a powerful new link for
your computer system:
The Power Directors
from Computer Accessories.



Power Directors incorporate UL approved TranZorb™ semiconductor technology and exceed the 1983 IEEE-587 Guide for surge voltages in low voltage AC power circuits. So you can protect your computer system from line surges and noise, giving it the pure power it needs. Voltage spikes are stopped in less than a nanosecond, EMI/RFI line noise is filtered out, and current overloads are prevented. Now your system can be truly integrated with

central power control like the Model P12 shown above. Instead of a haphazard maze of power lines and extension cords, each component plugs into the fully shielded Power Director. You can turn on each component individually, or power up the entire system with a single switch.

Look for the full line of Power Directors wherever personal computers are sold. TranZorb is a product of General Semiconductor Industries of Tempe, Arizona.

ca
computer
accessories

Computer Accessories Corporation, 7696 Formula Place, San Diego, CA 92121 (619) 695-3773

System Specs	PC-Draw	CADdraft	Benchmark	Vector Sketch	Drawing Processor	CADplan	AutoCAD	VersaCAD
Color output	•	•	1/84	1/84		•	•	•
Program load-time to draw	27 sec	36 sec	10 sec	28 sec	14 sec	45 sec	33 sec	81 sec
Minimum RAM required	128K	320K	256K	256K	256K	320K	256K	64/128K
Maximum addressable RAM	192K	320K	640K			640K	640K	128K
Disk I/O frequency	Med	Med	Med	Med	Med	Med	Med	High
Drawing entity bound	•	•		•		•		•
Drawing RAM bound	•	•		•	•	•		•
Drawing disk bound	•	•		•	•	•	•	•
Copy/multiuse protection	Disk	RS-232		PROM		RS-232		Key/Card
Configuration utility		*	•			*	*	•
Z80 support							•	
8086 support	•						•	
8087 support		•	6/84	11/83	•	•	•	•
8088 support	•	•	•	•	•	•	•	•
80000 series support							•	
Machine/assembly	•	•	•		•	•	•	
BASIC	•	•				•		
C		•	•			•		
Pascal					•			•
FORTRAN				•				
World grid resolution	1280 by 400	65,000 by 65,000	65,000 by 65,000	0.002	1×10^{15} by 1×10^{15}	65,000 by 65,000	1×10^{15} by 1×10^{15}	1×10^{15} by 1×10^{15}
Floating-point					•		•	•
Integer	•	•	•	•		•		•
Vector base	•	•		•	•	•	•	•
Maximum vertices/entities	1400	5000		5000	10,000 pts. 8000 lines	65,000		50,000
Drawing file type	ASCII	ASCII	ASCII	ASCII	Pascal DIF	ASCII	Binary ASCII	Pascal ASCII
Alternate file type			DIF					
Autocorrect for aspect ratio of graphics monitor			•		•		•	•
Intelligent plot utility		•			•	•	*	•

Table 4: A comparison of system specifications.

• = existing feature
 * = outstanding feature
 date = expected release date

mon in painting software where you paint shapes by lighting up pixels within a fixed matrix. For hard copy, you dump the image pixel by pixel to an output device.

In a vector-based system, the size of the world coordinate system doesn't necessarily correspond to the processor/monitor resolution. If the software uses integer mathematics, the coordinate system may consist of approximately 65,000 by 65,000 data points. With floating-point math, the software may generate a world coordinate system with limits of 1×10^{15} by 1×10^{15} data points.

The number of data points the CAD software makes available within the world coordinate system determines the degree of resolution it can achieve. The more there are, the greater the potential for detail, and,

in general, the slower and more memory-hungry the program (see table 4).

To set the scale for your drawing, you map out your own user-defined coordinate system or grid on the software world coordinate system. Say, for example, that you want to map out an area of 24 by 36 database units corresponding to a D-size sheet of architectural drafting paper. You want each database unit to be one inch, and you want to be able to break that down into divisions of 0.001 inch. Once you define your coordinate system, the system develops a database to record location and other attributes ascribed to the data points. In a vector-based system, a data point could be the center of a circle and the beginning of a line segment on layer 5 in the color green. The circle might

be a predefined shape (or primitive) defined by a center point and a radius of 2 database units rather than a circle of data points.

Physical Resolution

To record an image electronically, you enter it into the world coordinate system through a keyboard, digitizer, mouse, or light/touch pen. To manipulate the image, you display it on an output device such as a monitor. If you want to produce a hard copy, you send the database to printers and plotters. Each of these I/O (input/output) devices has its own resolution (called physical resolution) independent of that of the coordinate system or the image.

Differences in Resolution

In figure 1, see how the same circle

Text continued on page 190

ENTER ... THE FUTURE!



Introductory offer

\$49.95

**THIS IS THE PASCAL COMPILER
EVERYBODY'S BEEN WAITING FOR...
EVERYBODY EXCEPT THE COMPETITION!**

Extended Pascal for your IBM PC, APPLE CP/M, MS DOS, CP/M 86, CCP/M 86 or CP/M 80 computer features:

- Full screen interactive editor providing a complete menu driven program development environment.
- 11 significant digits in floating point arithmetic.
- Built-in transcendental functions.
- Dynamic strings with full set of string handling features.
- Program chaining with common variables.
- Random access data files.
- Full support of operating system facilities.
- And much more.

ORDER YOUR COPY OF TURBO PASCAL TODAY TO TAKE ADVANTAGE OF OUR INTRODUCTORY SPECIAL.

For Visa and MasterCard orders call toll free
1-800-227-2400 X 968

IN CA: 1-800-772-2666 X 968
(lines open 24 hrs. a day, 7 days a week)

Dealer & Distributor Inquiries welcome.

	Turbo Pascal	IBM Pascal	Pascal MT+
PRICE	49.95	300.00	595.00
Compile & Link speed	1 second!!!!	97 seconds	90 seconds
Execution speed	2.2 seconds	9 seconds	3 seconds
Disk Space 16 bit 8 bit	33K w editor! 28K w editor!	300K + editor Not Available	225K + editor 168K + editor
8 and 16 bit	YES	NO	YES
built-in editor	YES	NO	NO
Generate object code	YES	YES	YES
One pass native code compiler	YES	NO	NO
Locates RunTime errors directly in source code	YES	NO	NO

Benchmark data based on EightQueens in "Algorithms + Data Structures - Programs" by N. Wirth, run on an IBM PC.
Turbo Pascal is a trademark of Borland International. MT+ is a trademark of MT MicroSystems. IBM is a trademark of International Business Machines.

LEARN TO WRITE A SPREADSHEET

Our Introductory offer includes MICROCALC, a spreadsheet written in Turbo Pascal. It will be on your disk, and ready to run. And we've included the source code to show you exactly how a spreadsheet is written! (Introductory offer expires March 1, 1984)

Turbo Pascal includes a 250 page bound manual with extensive explanations and many illustrative examples.

Turbo Pascal \$49.95 + \$5.00 shipping per copy.

Check _____ Money Order _____
VISA _____ MasterCard _____

Card #: _____
Exp date: _____ Shipped UPS

BORLAND INTERNATIONAL

Borland International
4807 Scotts Valley Drive
Scotts Valley, California 95066

My system is: 8 bit _____ 16 bit _____

Operating system: CP/M 80 _____

CP/M 86 _____ MS DOS _____ PC DOS _____

Computer: _____ Disk Format: _____

Please be sure model number and format are correct.

NAME: _____

ADDRESS: _____

CITY/STATE/ZIP: _____

TELEPHONE: _____

California residents add 6 1/2% sales tax. Outside North America add \$15.00. Checks must be on a U.S. bank, and in U.S. dollars. Sorry, no C.O.D.

CAD Software Surveyed

Two-dimensional Software

AutoCAD

Autodesk Inc.
150 Shoreline Hwy., Bldg. B
Mill Valley, CA 94941
(415) 331-0356

AutoCAD is a powerful program capable of drawing anything from simple flowcharts to large, complex architectural drawings. Its strong points include a rich set of primitive commands, floating-point accuracy, little limitation on drawing size, good memory management, excellent peripheral support, and good editing features, including partial deletion of drawing elements. By means of user-definable menus, macros, and command files, AutoCAD can be customized without programming knowledge (a very powerful feature). A drawback, however, is that zooming, panning, and editing become slower as your drawing grows larger. This is typical for floating-point packages. If possible, use the faster 8087 numerical coprocessor with this program. You can zoom in from a view of the solar system to a desktop in a San Francisco office, but if you have a large number of elements in your drawing, the process may be slow. Aggressively updated and waiting only for a faster processor environment to complement its accuracy, AutoCAD has tremendous potential.

Benchmark

Metasoft Corporation
6509 West Frye Rd., Suite 12
Chandler, AZ 85224
(602) 961-0003
(800) 621-1908

A surprisingly capable CAD package, Benchmark uses macro command files to add flexibility, get around the limited number of standard features, and allow program customization. Written in machine and C languages, the program loads in a fast 13 seconds and executes commands just as quickly. Documentation is sparse, but the on-screen user interface is well designed and well written. Peripheral support is limited, however; Benchmark needs to support input devices other than the

keyboard. More a graphics editor than a CAD system designed for detailed drawing, this program even contains business-graphics primitives. Keep an eye on Benchmark; it has a lot of potential.

CADplan CADdraft

Personal CAD Systems Inc.
15425 Los Gatos Blvd.
Los Gatos, CA 95030
(408) 356-3183

A fast and friendly program with a lot of potential, CADplan's rich primitive features coupled with powerful editing features make it well worth considering. This is the only package reviewed that contains a user-definable database-extraction provision, allowing you to create written reports based on elements you place in your drawing. Its powerful configuration module supports a variety of peripherals. On the negative side, CADplan's integer math limits drawing size and resolution. Therefore, make sure this package handles the detail you require. Also, digitizer input is slow, and the system doesn't remap the device when you zoom in for more detail, i.e., you draw in a smaller area on the digitizer. Aggressively updated, CADplan is sure to become a popular entry-level package.

A scaled-down version of CADplan designed as a beginning package, CADdraft is rich in primitive and editing features and serves as an excellent introduction to CAD. Although the drawing size is limited, it may not hamper basic day-to-day drawing applications. Be sure the drawing resolution can provide the detail you desire since it is based on integer math. This program is fast, easy to use, aggressively updated, and supports a variety of peripherals. CADdraft is a good first step in CAD, especially if the more advanced CADplan suits your future needs.

Drawing Processor

BG Graphics Systems Inc.
824 Stetson Ave.
Kent, WA 98031
(206) 852-2736

Written in Pascal, Drawing Processor provides rich primitive features with a special curve-fitting provision not found elsewhere. This powerful program has strong editing features, sophisticated manipulation of predefined shapes, and floating-point precision. This precise but somewhat slow program requires an 8087 coprocessor chip. A well-illustrated manual describes how to map out an area on the digitizer and customize it for data entry. The program requires two monitors to run in some cases and doesn't support color yet. It needs to support a few more peripherals and provide more dimensioning and layered data-entry power. Drawing Processor is likely to be a top contender among CAD programs for micros.

PC-Draw

Micrografx
1701 North Greenville, Suite 703
Richardson, TX 75081
(214) 234-1769

PC-Draw provides a surprising amount of graphics editing power in an inexpensive package. You can create symbols, place them in a menu within the graphics editor, then pick these elements and place them within the drawing area. You can create and edit images from complex block diagrams to simple architectural drawings in color or black and white. Currently, the program supports only light-pen and keyboard entry input with a variety of output devices. Well documented, but not a full CAD system, PC-Draw provides the basic tools for a variety of drawing needs.

Vector Sketch

GTCO Tablet
GTCO Corporation
1055 First St.
Rockville, MD 20850
(301) 279-9550

Written in FORTRAN, Vector Sketch provides some powerful CAD capabilities. A certain number of data points spill out each second as you draw in sketch mode. Line types, commands from an on-screen menu, and creation of a symbol library are available. The program limits the number

of data points you can enter and the size of drawing you can create. When zooming into the drawing for more detail, however, it doesn't remap the digitizer. This means that a quarter-inch move on the digitizer can send the cursor completely across the screen, making detailed drawing difficult. While it currently supports a limited number of peripherals, Vector Sketch is being updated.

VersaCAD

CADapple

T & W Systems Inc.
7372 Prince Dr., Suite 106
Huntington Beach, CA 92647
(714) 847-9960

VersaCAD and CADapple are different versions of a powerful floating-point program written in Pascal. The ability to overflow your drawing to disk eliminates the threat of being RAM bound. In fact, since Pascal limits the RAM used, the program is constantly accessing the disk, making a hard-disk system preferable. It can automatically set up the balance of available RAM as a RAM disk. Rich primitives, including a Bezier curve-fitting provision, strong editing features, the ability to save views, a screen-dump provision, and partial deletion of drawing entities make this program powerful. Floating-point precision results in slower execution even with an 8087 coprocessor. The program can require two monitors and supports a variety of peripherals. With an optional three-dimensional interface now available and tremendous potential, VersaCAD/CADapple promises to become a popular package for micros.

Three-dimensional Software

The potential of three-dimensional software becomes desirable the more you work with CAD. Think how much time you could save by drawing house plans and then taking a three-dimensional look at the results from the neighbors' second-story window. Certainly, we anxiously await economical and usable three-dimensional CAD on desktop micros.

Many three-dimensional programs are available, but they are expensive. Several

vendors have systems ranging from \$15,000 to \$40,000 and are considering introducing device-independent programs for micros.

Currently, a variety of interesting, inexpensive, and aggressively updated packages provide limited two-dimensional capability along with three-dimensional modeling features. Some of these follow.

Energraphics/PC

Enertronics Research
150 North Meramec, Suite 207
St. Louis, MO 63105
(314) 725-5566
(800) 325-0174

Chock full of features for less than \$300, Energraphics includes business graphics, two-dimensional drawing with shapes libraries, and three-dimensional drawing with formula surface generation. It needs digitizer input. With excellent, well-illustrated documentation including its own software and many tools, this is an excellent entry-level package for learning about CAD.

MCS Software

3-D Space Tablet

Micro Control Systems Inc.
143 Tunnel Rd.
Vernon, CT 06066
(203) 872-0602

MCS is a three-dimensional modeling package complete with a special digitizer for three-dimensional data entry. You can digitize a small three-dimensional stick figure and then rotate, edit, and rescale it on the monitor. This package also allows two-dimensional digitizer input that you can then transform into a three-dimensional image with a high degree of accuracy.

3Design

3Design
POB C-56789
4710 University Way NE, Suite 1512
Seattle, WA 98105
(206) 525-7820
(800) 392-9210

Available for less than \$300, 3Design is

a three-dimensional stick-modeling package that constructs images as a collection of polygons and includes hidden-line removal and colored surface shading. Aggressively updated, this is an excellent entry-level package.

Painting

Painting software refers to pixel-based programs oriented toward graphics artists and illustrators, including the manipulation of images from a video camera. You can paint pictures on the monitor with a keyboard or digitizer. These packages will get more publicity as higher-resolution graphics processors and monitors become more economical. Descriptions of two programs follow.

Easel

Time Arts Inc.
4425 Cavedale Rd.
Glen Ellen, CA 95442
(707) 996-4856

A phenomenal package, Easel lets you paint on the monitor with a digitizer using different brush widths and even airbrush simulation. A palette of colors appears on the screen ready to touch and paint. Although most of the package is written in FORTH, many machine-language primitives are available. You will hear more about Easel.

4 Point

International Microcomputer
Software Inc.
633 5th Ave.
San Rafael, CA 94901
(415) 454-7101

With 4 Point, you can paint pictures on the screen and manipulate them, making copies of parts, changing background colors, and even switching images between buffers to create simple animation. You can turn off all status prompts to photograph the monitor image, or you can output your drawing to a plotter. Although you can use a mouse for data entry, this package needs more input devices to create more detailed and accurate drawings. Keep an eye on 4 Point.

Looking For Hardware And Software Bargains?

ComputerFest/USA is the high-energy, no-frills computer show where you can really get into it—lots of action and great deals.

This is the show where manufacturers and commercial vendors sell discounted personal computing hardware and software. And, individuals sell their used equipment and software at incredibly low prices.

At ComputerFest/USA, you'll find great bargains on everything from complete systems to integrated circuits, diskettes to disk drives, furniture, consumer electronics, business/recreation/application software, supplies, books, magazines, and more!

BUYER INFORMATION:

Technical Professionals: This is the show for engineers, programmers, technicians and other hardware and software professionals who know what they're looking for.

Non-Technical Buyers: ComputerFest/USA is also an opportunity for the non-technical buyer to purchase new and used equipment at mail order prices! And, there's a Free Consulting Booth at the show, so you can get technical questions answered before you buy.

SELLER INFORMATION:

Selling Booths: \$225

("Contract Booths" are also available for *individuals selling items acquired for their own personal use*. \$45)

To request a selling package, call toll-free: (800) 872-3378 or call (415) 327-7810

ComputerFest/USA is coming to your area. During January, February and March of 1984, ComputerFest/USA will be in the following cities:

<u>Date</u>	<u>Area</u>	<u>Location</u>
JANUARY		
28th	Northern California	SC County Fairgrounds 344 Tully Road San Jose, California
FEBRUARY		
4th	Detroit	Michigan State Fair 1120 W. State Fair Ave., Detroit, Michigan
4th	Dallas/Ft. Worth	State Fair of Texas Dallas, Texas
11th	NorthEastern United States (Boston Area)	Exhibition Hall 50 Foster Street, Worcester, Massachusetts
25th	NorthWestern United States (Seattle/Tacoma)	Western Washington Fair Highways 512 & 161, Puyallup, Washington
25th	Chicago/Milwaukee	Grayslake County Fairgrounds Highways 45 & 120, Grayslake, Illinois
MARCH		
10th	SouthEastern United States (Atlanta)	Marriott Hotel Courtland & International, Atlanta, Georgia
10th	Southern California	Orange County Fairgrounds 88 Fair Drive, Costa Mesa, California

TO BE ANNOUNCED:

Minneapolis, MN Washington, DC Houston, TX

This is COMPUTERFEST/USA!

■ Auctions □ Dancing Girls □ Door Prizes □ Free Consulting □ Consignment Table
■ Printers □ CRT's □ Portables □ Terminals □ Furniture □ Test Equipment □ Books □ Magazines □ Miscellaneous
Components □ Consumer Electronics □ EPROMs and Programmers □ ICs □ Robots □ Modems □ Hard and Floppy Disk
Drives □ Enclosures □ Keyboards □ Synthesizers □ A-D Converters □ Add-on PC Cards □ Buffers □ Cables □ Mainframes □
Connectors □ Computer Paper □ Ribbons □ MULTIBUS Boards □ Power Supplies □ Catalogs □ Games □ Computer Cases □
Extender Boards □ Real-time Clocks □ Joy Sticks □ Diskettes □ Video Games □ Video Equipment □ Communications □
Educational Software □ Expansion Memory □ Disks □ Interface Boards □ And More
■ Apple □ IBM □ MicroSoft □ S-100 □ CP/M† □ Cromemco □ Morrow □ Kaypro □ Osborne □ Corona □ Commodore □
TRS-80‡ □ TI □ Epson □ Zenith □ Shugart □ Altair □ Zentec □ Imjai □ Atari □ Centronics □ Processor Tech □ Diablo □
TeleVideo □ Oki-Data □ USI □ Peachtree □ VisiCorp □ Ashton Tate □ Heath □ And Many More

†CP/M is a trademark of Digital Research, Inc. ‡TRS-80 is a trademark of Tandy Corporation

Circle 99 on inquiry card.





COMPUTERFEST
 ★★★★★U*S*A★★★★★

John Craig
 Producer of ComputerFest/USA
 The founding publisher of Info-World, founding editor of Kilobaud Microcomputing, co-editor of the first computer hobbyist newsletter in 1974 and the former editor of Creative Computing.



ComputerFest/USA, 140 University Avenue, Suite 16, Palo Alto, CA 94301

\$1⁰⁰ Discount

\$1⁰⁰ Discount

ONE DOLLAR

Show Hours
10-6:00

Tickets on Sale
at 9 am

DISCOUNT COUPON
 Admission only \$5.00 with this coupon

COMPUTERFEST
 ★★★★★U*S*A★★★★★

\$1⁰⁰ Discount

140 Univeristy Avenue, Suite 16, Palo Alto, CA 94301

\$1⁰⁰ Discount

Please send more information on
ComputerFest/USA

I'm a: Buyer Seller

Name _____

(Company) _____

Address _____

City _____

State _____ Zip _____

Phone _____

Other CAD Software Packages

Business Graphics

BPS Business Graphics

Business & Professional
Software Inc.
143 Binney St.
Cambridge, MA 02142
(617) 491-3377
(800) DIAL BPS

Chart-Master

Decision Resources
25 Sylvan Rd. S
Westport, CT 06880
(203) 222-1974

Cheetah

Centec
11260 Roger Bacon Dr.
Reston, VA 22090
(703) 471-6300

Executive Briefing System

Lotus Development
Corporation
161 First St.
Cambridge, MA 02142
(617) 492-7171

Flexigraf

Computer Associates
International Inc.
125 Jericho Turnpike
Jericho, NY 11753
(516) 645-3003

Graftalk

Redding Group Inc.
609 Main St.
Ridgefield, CT 06877
(203) 431-4661

Graphwriter

Cypher Smartware
121 Second St.
San Francisco, CA 94105
(415) 974-5297
(800) SMARTWARE

SAS/Graph

SAS Institute Inc.
Box 8000, SAS Circle
Cary, NC 27511
(919) 467-8000

Tellagraf

Disspla
ISSCO Graphics
10505 Sorrento Valley Rd.
San Diego, CA 92121
(619) 452-0170

CAD

CADcal

CADcal Products Inc.
9311 Eton Ave.
Chatsworth, CA 91311
(213) 700-7888

Cascade 12.5 Designer

Cascade Graphics
Development
1000 South Grand Ave.
Santa Ana, CA 92705
(714) 558-3316

Design Graphix

Engineering Systems
Corporation
POB 80318
Baton Rouge, LA 70898
(504) 769-2226

MGI

Microcomputer Graphics Inc.
POB 10819
Marina Del Rey, CA
90295
(213) 822-5258

Summadraft

Summagraphics Corporation
35 Brentwood Ave.
Fairfield, CT 06430
(203) 384-1344

CAD Circuit Routing

Dasoft

Dasoft Design Systems Inc.
2550 Ninth St., Suite 113
Berkeley, CA 94710
(415) 486-0822

Futurenet Dash-1

Futurenet
21018 Osborne St.
Canoga Park, CA 91304
(213) 700-0691

CAE

Images-2D

Celestial Software Inc.
125 University Ave.
Berkeley, CA 94710
(415) 841-7175

Tutsim

Applied i
200 California Ave., Suite 214
Palo Alto, CA 94306
(415) 325-4800

Graphics Utilities

Digiware

Panelfill
Mapware
Computer Mathware
POB 1327
Princeton, NJ 08542
(609) 924-6582

Grafmaker

DI-3000
Precision Visuals Inc.
6260 Lookout Rd.
Boulder, CO 80301
(303) 530-9000

Painting

Creative Graphics

Accupipe Corporation
222 West Lancaster Ave.
Paoli, PA 19301
(215) 296-7340

Painting, Business Graphics, Graphics Utility

PC Business Graphics

Autograf
Data Digitizing System
C-J Sales
One First St.
Los Altos, CA 94022
(415) 941-6892

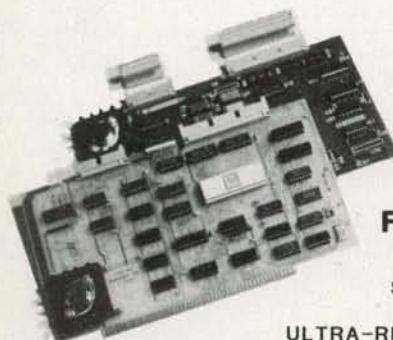

ULTRA-RES™ GRAPHICS

IEEE-696 S-100

IBM-PC

- 1 X 512 X 512 \$495

- 1 X 512 X 512 \$495

- 3 X 512 X 512 \$1250

- 1 X 1024 X 1024 \$995

- 1 X 1024 X 1024 \$995

- CONSOLE EMULATOR \$50
- 2D DRAFTING SOFTWARE \$200
- PLOT 10 \$150

FEATURES

Software drivers, Hardware zoom, Programmable Display Resolution, Windowing, Multi-Controller Capability, NEC UPD7220 Graphic Controller

Starting Prices

ULTRA-RES Trademark CSD Inc.
IBM-PC Trademark IBM

C.S.D. Incorporated
P.O. BOX 253 Sudbury, MA 01776
(617) 443-2750

THE COLUMBIA IBM-PC COMPATIBLES. THEY REWARD TWO BUSINESS VIRTUES: FORESIGHT AND CUNNING.



Trust your instincts.

While others rushed out to buy an IBM[®]PC, you waited and watched. You knew prices would come down and software would get better.

Now we have a reward for your patience: the Columbia family of IBM-PC compatible computers. It's a choice of systems and software no one else can match.

The Columbia line includes the VP Portable which lets you work anywhere, any time. There's also the MPC, our desktop model, available in dual floppy disk or 10MB hard disk drive. Compatible with each other and the IBM-PC, as well.

Foresight led you to our IBM-PC compatibility.

We start you with more operating systems than IBM, even more than other IBM-PC compatibles (MS-DOS[®] and CP/M[®]86). Which means you have immediate access to all the latest business and financial software.

Free software that's a steal.

Thousands of dollars worth of free software come with every Columbia computer. Columbia Tutor gives you a fast, comfortable start. Perfect Software[™] covers your word processing, spreadsheeting, and filing needs. Fast Graphs[®] turns facts and figures into graphs and charts. And asynchronous communications lets you share information with other computers.

For your sense of self, we give you Home Accountant Plus[™], games, and two programming languages so you'll feel like an eleven year old genius.

Responsive service. Above and beyond.

175 local Bell & Howell service centers stand ready to maintain your Columbia computer at a moment's notice.

Prices start at \$2995. The phone call is free.

Now, while you're feeling shrewd, call toll free for the Columbia dealer nearest you. Then, see for yourself how the Columbia Compatibles can reward your business virtues.

800-638-7866

COLUMBIA

DATA PRODUCTS, INC.

Columbia Data Products, Inc.

9150 Rumsey Road, Columbia, MD 21045

(301) 992-3400, TWX 710-862-1891.

Trademarks: IBM—International Business Machines Corp.; MS-DOS—Microsoft, Inc.; CP/M-86—Digital Research, Inc.; Perfect Software—Perfect Software, Inc.; Fast Graphs—Innovative Software; Home Accountant Plus—Continental Software Company.
Software on screens not included.

Circle 67 on inquiry card.

BYTE January 1984 189

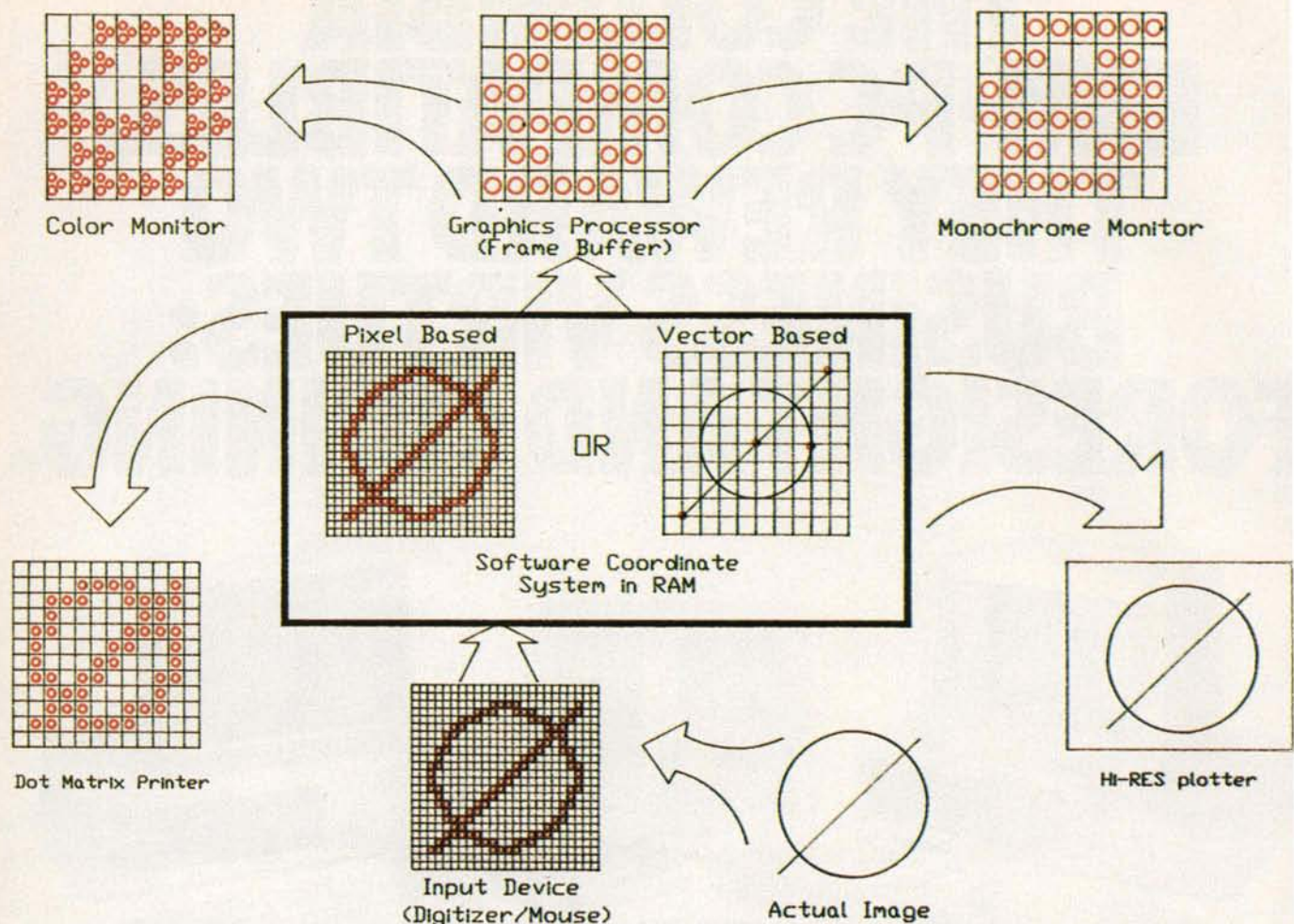

Figure 1: Even when the monitor represents the drawing poorly, you can record an accurate database and produce a very high resolution hard copy.

Text continued from page 182:

and line appear when represented by a variety of coordinate systems. Each system has a different number of data points to represent the image. Fewer data points provide lower resolution and cruder representation, resulting in jagged lines called *stair-stepping* or *aliasing*.

Consider an input device capable of recording data points with a resolution of 0.001 inch and a coordinate system capable of 1000 data points per inch.

If you map the coordinate system created by the CAD software to the available pixels on the graphics monitor (see figure 2), an input resolution of 0.001 inch is too detailed for a world coordinate system of 320 by 200 pixels or even 2400 by 2400. This resolution is adequate, however, for a painting program where you either take a photograph of the monitor or do a pixel-by-pixel dump onto a hard-copy device.



Figure 2: An image of the Golden Gate Bridge drawn with the 4 Point painting package and plotted on a Sweet-P plotter. Note the series of short lines that represents the image on a pixel-based system.

Be confident because your PowerType Daisywheel correspondence becomes you.

When you can't personally be there, only the clearest typed correspondence should be your substitute. With a PowerType Daisywheel printer your documents look highly professional. And so do you!

PowerType. It's "typewriter friendly." Using a simple drop-in ribbon cassette, it bi-directionally types executive quality correspondence at 18 cps with a print wheel that holds 96 flawless characters.

Designed for personal or business applications, PowerType's carriage accepts paper that ranges

from letter to legal size, from fanfold to roll to cut sheet. You can set right and left margins, vertical and horizontal tabs.

Plus, of course, PowerType has both serial and parallel interfaces to enable it to connect to just about any personal or business computer.

So the next time you're going face to face through the mail, rely on PowerType. It will help you make a professional impression. And that's always very becoming.

star
MICRONICS INC.

THE POWER BEHIND THE PRINTED WORD.

Computer Peripherals Division

P.O. Box 612186, Dallas Ft. Worth Airport, TX 75261 (214) 456-0052



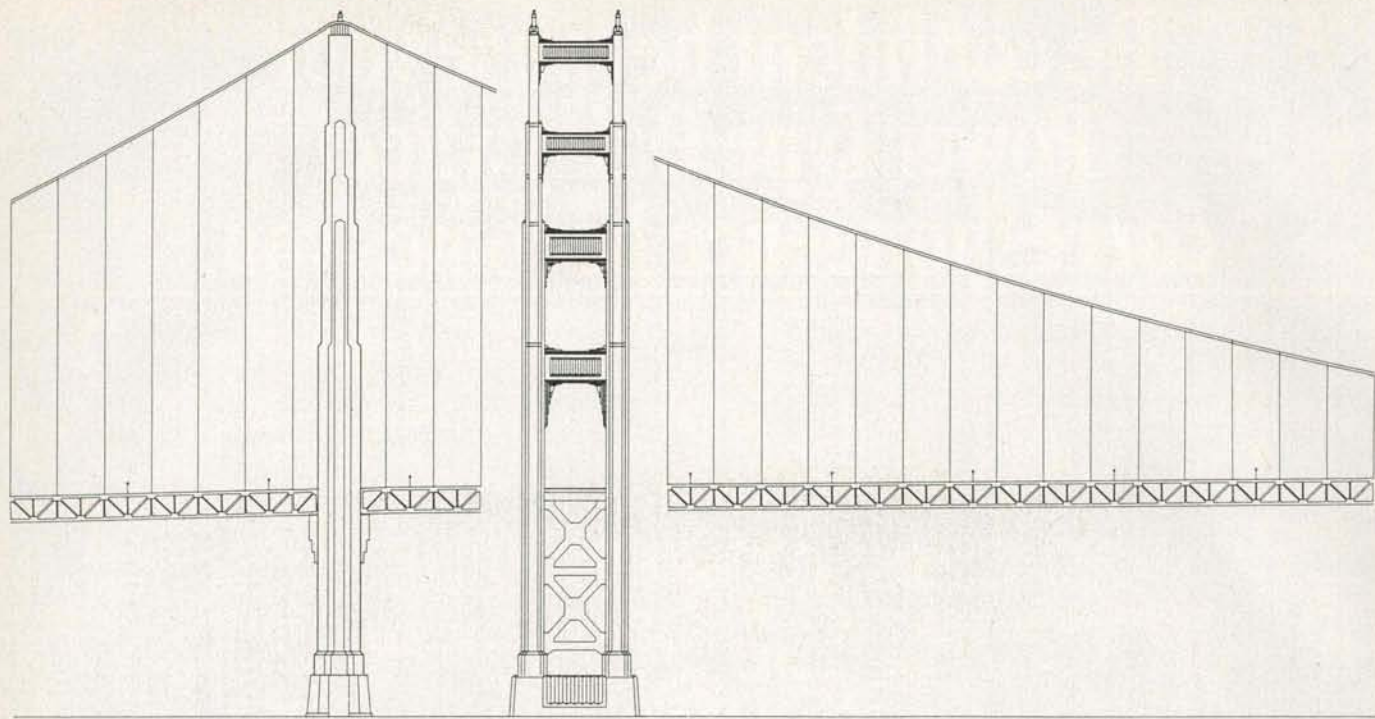

Figure 3: An image of the Golden Gate Bridge drawn with high-resolution, floating-point, vector-based AutoCAD software and plotted on a high-resolution Houston Instrument DMP-42 plotter.

In an integer-based program with a world coordinate system of 65,000 by 65,000 data points and a scale of 1000 data points per inch, you create a 65- by 65-inch coordinate system to an accuracy of 0.001 inch. The input resolution matches that of the software coordinate system.

With a floating-point-based program (see figure 3), a potential resolution of 1×10^{15} by 1×10^{15} data points more than accommodates the capability of the 0.001-inch input device. Zooming and viewing allow you to take advantage of this difference.

Although the software database accurately records the image received from the input device in these last two examples, when you send the image through the graphics processor and onto the monitor, the results are often less than satisfactory. The physical resolution of the display device has nowhere near the resolution capability of either the input or software world coordinate systems. The software records the image accurately, but the best available video representation is not all that good.

Now consider an output device, such as a plotter, with a physical resolution of 0.002 inch (determined by

the step size of its motor). An output resolution of 0.001 inch provides an image whose jaggedness is barely perceptible. On the other hand, if the database resolution is less than the plotter's, a circle looks like a many-sided polygon. If it is intelligent enough to draw a circle using a center and a radius, the plotter defines the resolution of the circle. With the pixel-based system, however, each pixel shows on the plotter as a line or dot, and the resolution is as crude as the one on the monitor.

A floating-point system permits a decimal rescale of virtually any proportion, while an integer-based system often permits rescaling the database image only in fractions of the database unit, such as $\frac{1}{8}$, $\frac{1}{4}$, or $\frac{1}{2}$. This potential limitation is a problem only if it hinders the drawing task at hand.

Zooming, Panning, Windows, and Views

Zooming in and out (see figure 4) fills the monitor screen with various views of the world coordinate system, both near and far—a very desirable software feature.

Zooming in creates a window that fills the monitor screen with a close-

up of part of your drawing. The drawing resolution is coarser because an image that normally occupies $\frac{1}{10}$ of the screen now occupies $\frac{1}{2}$ of it with the same number of data points. The scale of the monitor image is different, but the world coordinate and grid systems remain the same. You can add more detail, and the input device appears capable of a higher resolution.

In an integer-based system where the input resolution matches the software coordinate system's resolution, if you zoom in on a 1- by 1-inch portion of the drawing, the resolution is 1000 by 1000 data points. There is no point in zooming in any further because you have already used the maximum resolution available.

To give you an idea of the magnification possible in a floating-point coordinate system with 1×10^{15} by 1×10^{15} resolution, you can zoom in from a view of a football field to an 8½- by 11-inch sheet of paper on the 50-yard line, read the writing on it, and then zoom further inside one of the letters on the page to do some detailed drawing.

Zooming out is the reverse of zooming in. After you zoom in on an area to do some detailed drawing,



The Computer Book Club®

"The ONLY Book Club for Microcomputerists!"

Superior Performance! Practical Price!

More programs, projects, ways to use your micro for home, hobby, education, and business!

Select 6 Books for Only \$2⁹⁵ (worth up to \$135.70)

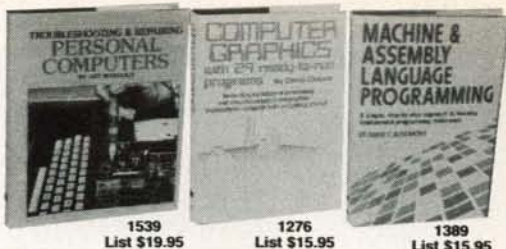

1539
List \$19.95

1276
List \$15.95

1389
List \$15.95

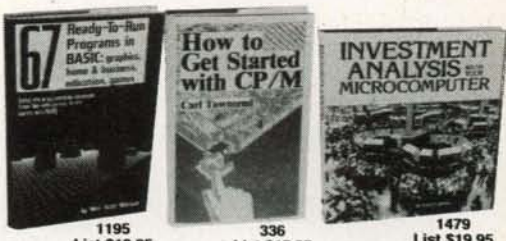

1195
List \$13.95

336
List \$15.95

1479
List \$19.95

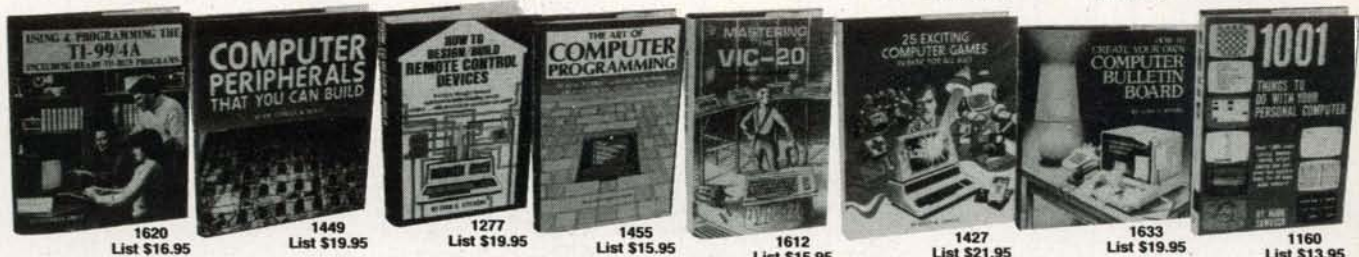

1620
List \$16.95

1449
List \$19.95

1277
List \$19.95

1455
List \$15.95

1612
List \$15.95

1427
List \$21.95

1633
List \$19.95

1160
List \$13.95



1478
List \$19.95

1369
List \$21.95

1540
List \$22.95

1183
List \$14.95

1506
List \$13.95

1228
List \$14.95

1453
List \$16.95

1428
List \$17.95



1421
List \$21.95

1466
List \$17.95

1637
List \$26.95

1062
List \$14.95

1295
List \$16.95

1394
List \$15.95

Free guide to BASIC Statements & Commands



Plus FREE For Joining →

7 very good reasons to join The Computer Book Club®

- **Big Savings.** Save 20% to 75% on books sure to increase your computer know-how
- **No-Risk Guarantee.** All books returnable within 10 days without obligation at Club expense
- **Club News Bulletin.** All about current selections—mains, alternates, extra—plus bonus offers. Comes 13 times a year with hundreds of up-to-the-minute titles you can pick from
- **"Automatic Order."** Do nothing, and the Main selection will be shipped automatically! But . . . if you want an Alternate selection—or no books at all—we'll follow the instructions you give on the reply form provided with every News Bulletin.
- **Bonus Books.** Immediately get a Dividend Certificate with every book purchased and qualify for big discounts of 60% to 80%
- **Extra Bonuses.** Take advantage of added-value promotions, plus special discounts on software, games, and more
- **Exceptional Quality.** All books are first-rate publisher's editions selected by our Editorial Board and filled with useful, up-to-the-minute information

Circle 346 on inquiry card.

The Computer Book Club®

P.O. Box 80 Blue Ridge Summit, PA 17214

Please accept my membership in The Computer Book Club® and send the 6 volumes circled below, plus my FREE copy of *BASIC Statements, Commands and Functions*, billing me \$2.95 plus shipping and handling charges. If not satisfied, I may return the books within ten days without obligation and have my membership canceled. I agree to purchase 3 or more books at reduced Club prices (plus shipping/handling) during the next 12 months, and may resign any time thereafter.

336 1062 1160 1183 1195 1228 1276 1277 1295
1369 1389 1394 1421 1427 1428 1449 1453 1455 1466
1478 1479 1506 1539 1540 1612 1620 1633 1637

Name _____
 Phone _____
 Address _____
 City _____
 State _____ Zip _____

Valid for new members only. (Orders outside U.S. or Canada must be prepaid in International Money Orders in U.S. dollars. Canada must remit in U.S. dollars.) This order subject to acceptance by The Computer Book Club® BY-184

ZOOMING

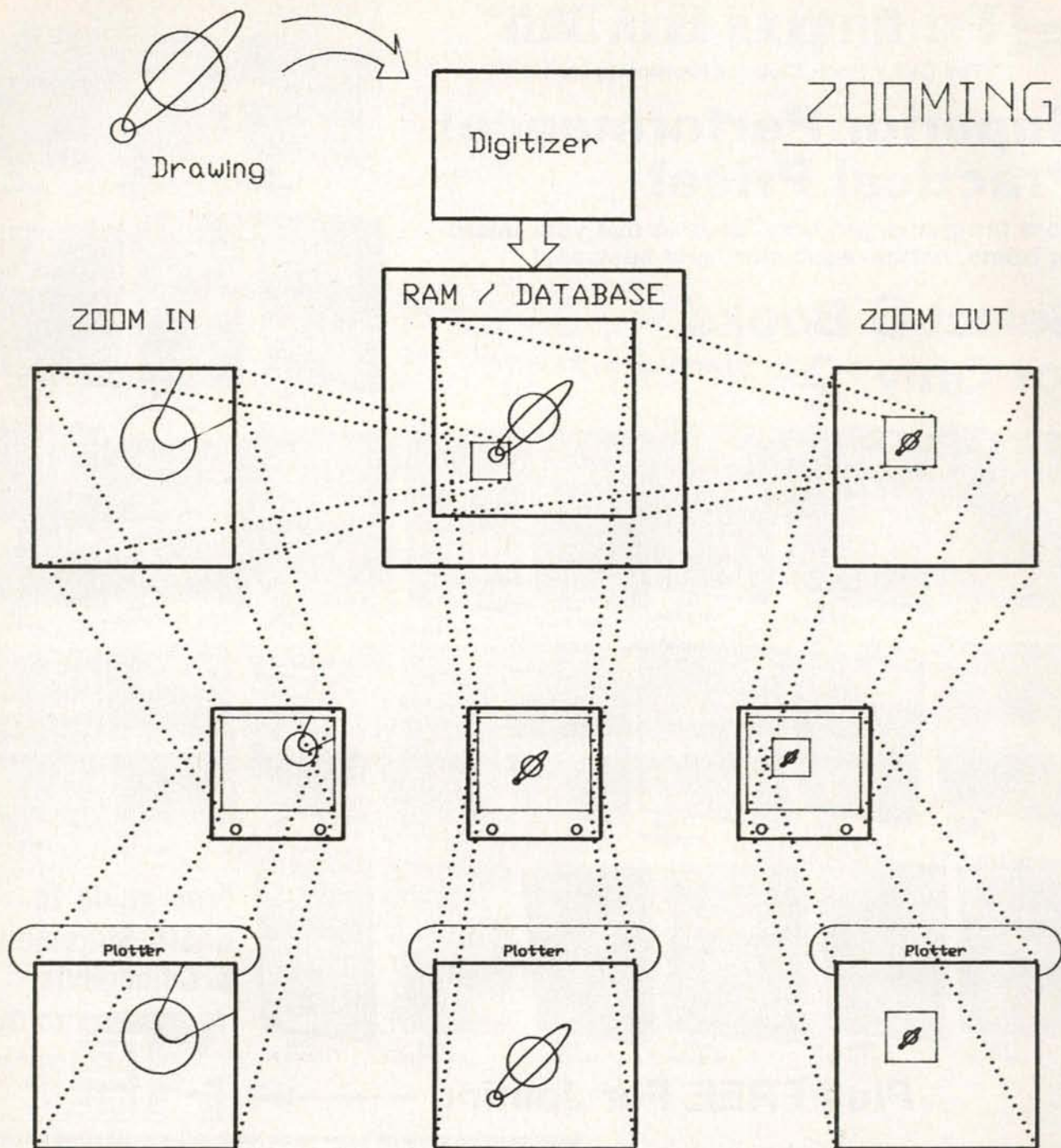

Figure 4: Zooming, enlarging small parts of an image, changes the scale of the drawing in relation to the monitor.

you zoom out to see the entire drawing again. With some software, you save these zooms, windows, or views to disk and call them back at any time.

Panning scrolls the zoomed-in window over the world coordinate system—wandering around the drawing. When you are doing detail work, it is easier to move to a new area than to zoom out and back in again.

How RAM and Disk Storage Are Used

The way a program utilizes RAM and disk storage is important. Figure 5 shows a block diagram of the interplay between RAM and storage.

Typically, the CAD software loads only the necessary program code into RAM, leaving Help files and a number of program overlays on disk until needed. These overhead items

determine the workspace left to manipulate the world coordinate system and the resulting database. In general, the less RAM you have, the more overlays and disk I/O you need. In a CP/M system with 64K bytes, many overlays are needed to run such a large and powerful program.

What determines the maximum size of your drawing? A drawing is "RAM bound" if its size or the num-

Text continued on page 198

SWIG[©]

SOFTWARE WRITERS INTERNATIONAL GUILD

THE LARGEST PAID MEMBERSHIP PROGRAMMERS GUILD -
OVER 5,000 MEMBERS WORLDWIDE!!

SCHEDULED SWIG ACTIVITIES & MEMBERSHIP BENEFITS

- (1) \$10,000 PROGRAMMING CONTEST (Members only)
- (2) NATIONAL COMPUTER WEEK (May 11-May 20, 1984)
- (3) ANNUAL CONFERENCE AND SOFTWARE AWARDS CEREMONY (During National Computer Week)
- (4) CONSULTANT REGISTRY (With computer store referral system for customized software)
- (5) JOB PLACEMENT SERVICE (Free to individual members, fixed maximum fee to companies)
- (6) FREE SEMINARS & MEETINGS LOCALLY
- (7) SOFTWARE LIBRARY LENDING & EXCHANGE SERVICE (Professional quality assemblers, utilities, games, etc.)
- (8) SOFTWARE LOCATION SERVICE (For companies & individuals-if it exists, **SWIG** will find it. If not, see #9)
- (9) SOFTWARE DEVELOPMENT SERVICE (From novice to scientist, **SWIG** members can work on any project-from applications to games to R&D)
- (10) LEGAL SERVICE
- (11) AGENT (**SWIG** can represent you in sales to software publishers)
- (12) 24 HOUR - 7 DAY BULLETIN BOARD SYSTEM (BBS) ACCESSIBLE BY COMPUTER FREE
- (13) AND MORE!!!!

MEMBERSHIP APPLICATION FOR SOFTWARE WRITERS INTERNATIONAL GUILD

NAME _____

ADDRESS _____

CITY _____ STATE _____ ZIP _____

PHONE # () _____

• CLASSIFICATION:

- NOVICE BEGINNER TO ADVANCED
 ADVANCED WITH ON THE JOB EXPERIENCE RESEARCH/SCIENTIST

• WHAT EQUIPMENT DO YOU HAVE EXPERIENCE WITH &/OR ACCESS TO &/OR PLAN TO BUY?

- MAINFRAME MINI MICRO DESIGN/R&D
BRAND NAME(S): IBM XEROX APPLE TI
 COMMODORE RADIO SHACK ATARI OSBORNE
 TIMEX/SINCLAIR NORTH STAR HEWLETT PACKARD
 OTHER _____

• AREAS OF INTEREST:

- DATA PROCESSING BUSINESS APPLICATIONS GRAPHICS
 LEGAL VOICE MEDICAL APPLIANCE (HOME) CONTROL
 ROBOTICS GAMES MUSIC R&D OTHER _____

• MEMBERSHIP ACTIVITIES AND SERVICES OF INTEREST:

READ THE LIST ON THE LEFT AND CIRCLE THE NUMBERS BELOW THAT APPLY.

1 2 3 4 5 6 7 8 9 10 11 12

- I HAVE ENCLOSED \$20 ANNUAL MEMBERSHIP FEE CK MO
(MAKE CHECK PAYABLE TO: **SWIG**)

RETURN TO: **SWIG**
P.O. BOX 87
STONY POINT, NEW YORK 10980
(914) 354-5585

SWIG © SOFTWARE WRITERS INTERNATIONAL GUILD

Your troubles There's a *NewWord*

With word processing, you expect to become more efficient. But instead of producing letters and reports effortlessly, your word processing program frustrates you with its complicated manuals and ponderous operating procedures.

Your troubles are over. There's a new word for productivity—*NewWord*.

NewWord is remarkably advanced

NewWord is exceptionally powerful and versatile. It provides all the advanced editing and formatting capabilities that you need to quickly and easily create, correct and revise all your writings. *NewWord* not only does *more* than other word processing designs—it does each task faster, with fewer operations.

The proof of *NewWord's* powerful performance is in the printout. With *NewWord* you can deliver perfect documents every time.

NewWord's versatility includes *merge print*, which allows you to produce customized form letters and reports by combining standard and individualized text. Information stored on one disk or file can be transferred automatically to another, perhaps merged with financial reports and graphics. Using *NewWord*, you can merge mailing lists into form letters and print mailing labels.

You'd expect such an advanced feature only on the most expensive word processors, but merge print is built in *NewWord*.

NewWord retails for \$249.00—or about a third of the cost of the industry's leading word processing program and its merge print option.

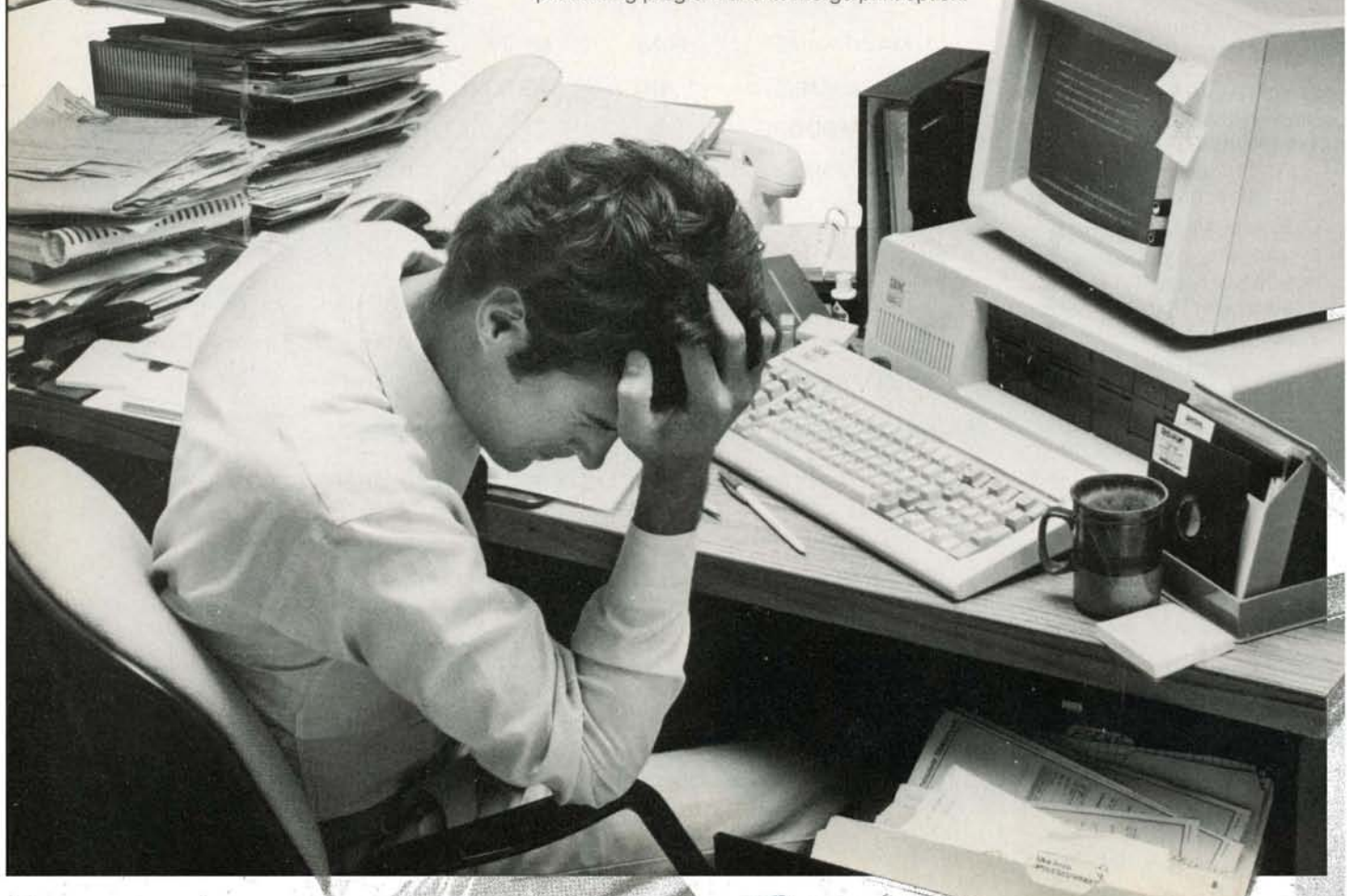
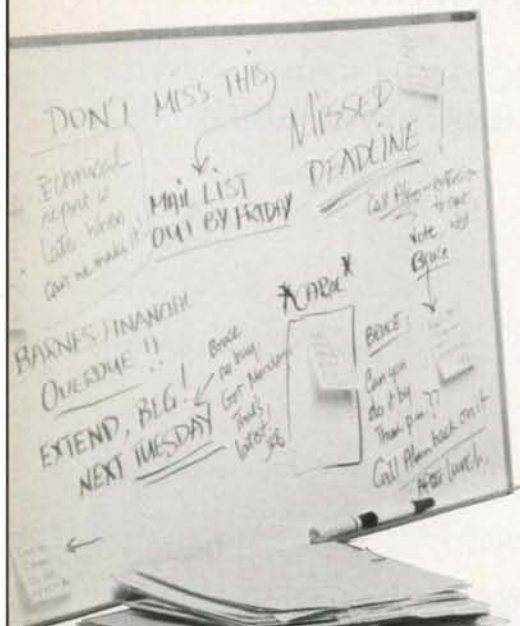

are over for efficiency

NewWord makes you productive right away

You can put **NewWord** to work immediately, without feeling awkward or confused. Anyone with WordStar® experience won't even have to read **NewWord's** manuals. WordStar® text files work with **NewWord**. Start writing, using the same commands as WordStar®. **NewWord's** high-powered performance and versatility will be immediately apparent.

New users will appreciate the highly readable manual and optional **novice NewWord**—a simplified, teach-yourself version featuring immediately useful functions. After **novice NewWord** you can begin to use **NewWord's** more advanced features without any trouble because **novice** teaches you how to use **NewWord**.

NewWord makes paperwork easy

Editing is easy and straightforward with **NewWord**. Single keystrokes perform primary functions, such as to insert, delete and move characters, words and sentences. **NewWord** obeys your instructions instantly, making corrections and revisions easy—like using the convenient "unerase" command when you change your mind. Or finding a specific page in the document.

Using **NewWord**, even large blocks of text are moved and repositioned easily, and just as quickly copied or deleted. With the Search-and-Replace function, words and phrases such as mis-spelling and titles can be changed throughout the document with a single command.

As you write, **NewWord** automatically arranges text to your preferred format. When you edit, **NewWord** reformats your document. You see on the screen exactly what you'll get on paper—including print options like boldfacing, underlining, etc.

You'll be pleased by how much less effort it takes to produce perfect, professional-looking documents—even for a first time user!

NewWord sets new performance standards

The best performance features of the most popular word processors have been refined, enhanced and improved in **NewWord**.

NewWord executes much faster because there are no overlays except the printer driver. System operations no longer slow down on your personal computer. Processing is uncomplicated, and rapid.

"Save and resume" command doesn't move the cursor to the beginning of the file, eliminating another frustration typical of the other program. "Living" ruler

lines automatically change margins and tab stops for you as you move around the document.

In non-document mode, indentation is automatic at your command and the file can invoke a specific tab size—examples of features that are useful with structured programming languages.

These are just some of **NewWord's** powers. Yet it's easier to use than the most sophisticated program available.

NewWord is simple to learn, easy to use

Select from a multiple choice "MENU" of functions, and interactive onscreen prompts lead you every step of the way. If you have a problem, **NewWord's** extensive "HELP" screens assist you—in plain English.

There are no complicated codes and command sequences to learn or memorize. Menus make **NewWord** the effortless, versatile writing tool you've been looking for.

When you get **NewWord**, you can count on getting to work right away. An installation guide sets you up in minutes. A tutorial starts you right into producing documents. And the

NewWord Encyclopedia serves for handy reference.

Discover the NewWord in word processing

NewWord helps you improve paperwork efficiency, serving your every business/personal word processing need.

Discover how easy it is to take powerful and versatile word processing for granted. Your productivity will convince you. Discover **NewWord**.

LIMITED TIME SPECIAL OFFER

Send us your word processing software and \$100.00 and we'll send you **NewWord**. Call us today, toll-free

800-832-2244

(In California, call 800-732-2311)

Before sending us your software, call to:

- confirm availability for your computer, terminal configuration and printer
- receive a return authorization number from us
- obtain shipping address for your trade-in software. (Send with your check, plus \$4.50 for shipping via UPS Surface. California residents add 6% or 6½% sales tax.)

This introductory offer expires **January 31, 1984**. Offer is limited to nationally advertised word processing software programs operable on user's presently owned computer. **NewWord** is available without trade-in for \$249.00

**Initial availability limited to selected CP/M-80 computers. Versions for additional CP/M-80 computers and IBM-PC, and compatibles available soon. Call to confirm availability for your computer, terminal, configuration, and printer.*



ROCKY MOUNTAIN SOFTWARE SYSTEMS
Business Microcomputers and Software

1280-C NEWELL AVENUE, SUITE 1001 • WALNUT CREEK, CALIFORNIA 94596 • (415) 680-8378

Specifications subject to change without notice. Some printing and display features may not be available in all configurations, subject to printer and terminal capabilities. WordStar is a registered trademark of MicroPro International, Inc. • CP/M is a registered trademark of Digital Research, Inc. • NewWord and NewStar are trademarks of NewStar, Inc.

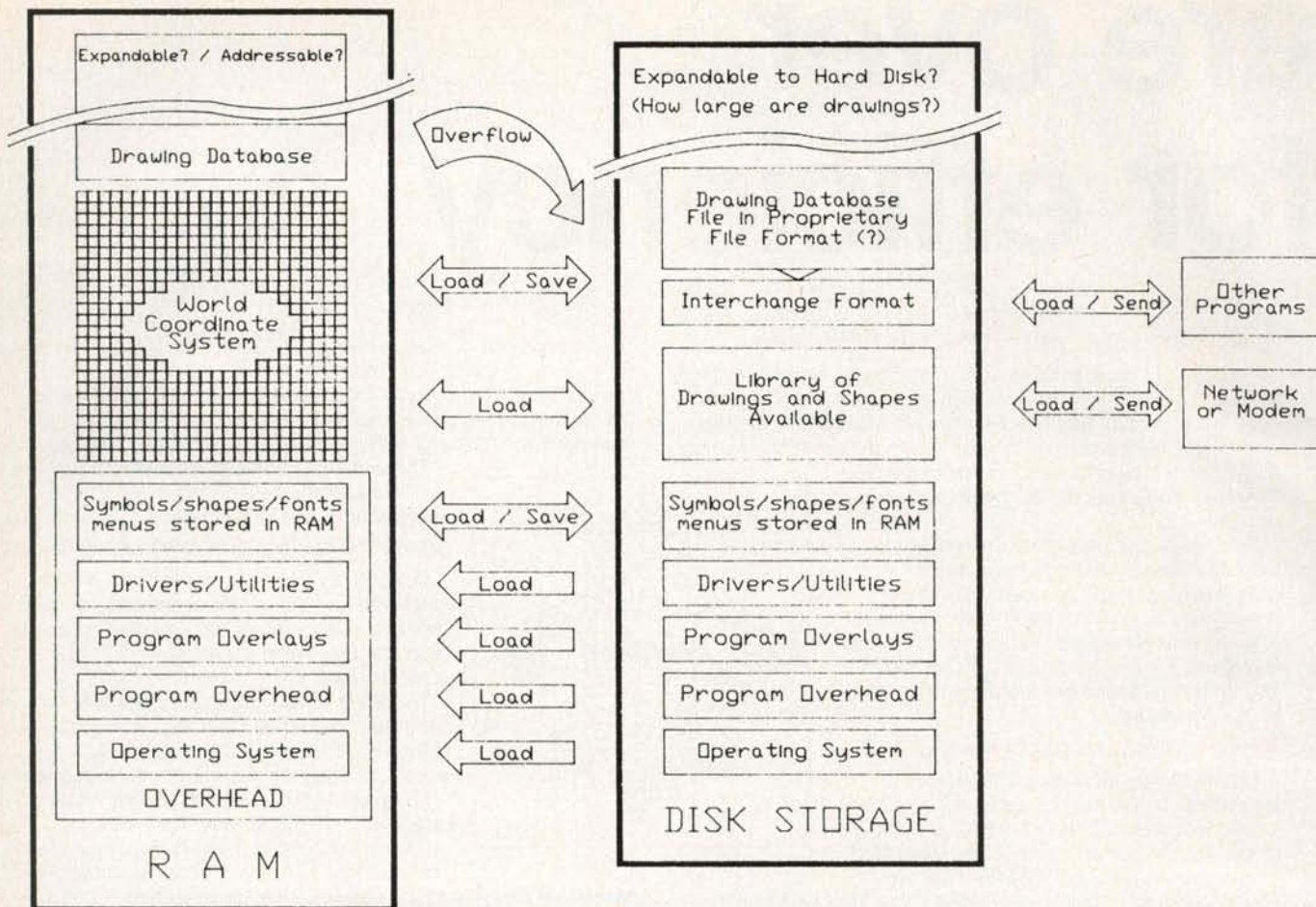

Figure 5: The interplay between RAM and disk storage.

Text continued from page 194:

ber of drawing entities you can place in it are limited by the RAM available or addressable. Some software packages (e.g., a pixel-based painting package) have a fixed coordinate system mapped out. Some software and hardware limit the amount of available RAM or determine the maximum amount of addressable RAM. Expandability and addressability are important features to consider.

When the size of your drawing reaches the hardware or software capacity, the system should give you a warning message rather than kick you out to the A> prompt. At the very least, you want an opportunity to save your work. Some software overflows the drawing database to disk (called paging), the same as a good word processor does. This allows your drawing to exceed the capacity of RAM.

If the software limits your drawing to a certain number of drawing elements, you are "element bound." For example, you might be limited to

3000 data points, vectors, vertices, or polygons or to 10,000 shapes, components, blocks, groups, or dictionary items.

If the software limits your drawing by the amount of disk storage available, you are "disk bound."

As attractive as a software package is, you must match the requirements of your typical drawings with these CAD limitations.

A truly powerful CAD configuration is capable of paging, uses a large number of drawing elements, and includes a large amount of hard-disk storage to minimize the risk of being disk bound. If you anticipate a significant amount of disk I/O, consider a hard-disk system. If your time is valuable and you expect to use your system a lot, make sure it is big enough to meet your drawing needs in terms of speed and capacity.

A Buyer's Guide

The list of features described in the table comparisons (tables 5, 6, and 7)

is food for thought but is certainly not complete. When you go to buy your CAD package, ask pertinent questions and expect answers. At the very least, you will be referred to a more informed individual. This way, you begin the journey to a wise decision. Many vendors and program developers give demonstrations. Attend some if possible. If you can't take the time for all this, hire a good consultant. Here are some questions and features to consider.

The vendor's update policy is extremely important. This industry is changing so rapidly that products are in a constant state of evolution. How will the vendor notify you of program improvements or revisions? If you're a licensed owner, do you receive a newsletter or revision/update notification? Check it out.

What training or support does the vendor offer? Do you get support through an "800" number? Is the software portable? If you want to use your drawings on a variety of com-

Text continued on page 202

X-NET™ Local Area Network Broadens The Horizons Of All IBM PC's



Breakthrough! X-NET and the industry's leading accounting package have been linked to broaden the capabilities of all IBM PC's.

Here are the benefits of this breakthrough and what they mean to you.

1. READY ACCESS TO ALL

INFORMATION. With X-NET, any computer can get information from any other computer on the network. This means more than one operator can be entering orders, invoicing, changing inventory...all at the same time! But where security is needed, you can keep any file private while still within the network.

2. YOU CAN START SMALL... Even if you have as few as two PC's, you'll have a system that is easily expandable and will grow with your company.

3. ...OR GET BIGGER. X-NET grows as you grow, and networks up to 255 PC's, and best of all, expansion is so simple, you can do it yourself.

4. SUPERIOR ACCOUNTING

SOFTWARE. X-NET's software includes Accounts Receivable, General Ledger, Accounts Payable, Order Entry, Inventory Control and Payroll. You can still use your Spread Sheet and Word Processing software, but now much more effectively because your computer power is tied together.

5. ELECTRONIC MAIL. Send, receive and record inter-office communications without ever leaving your desk or interrupting an important business meeting.

6. AFFORDABILITY. X-NET is truly affordable to any company doing computing on any level. And the software is priced comparably to what others are charging for no-growth single-user software.

7. NO COSTLY CENTRAL FILE SERVER.

X-NET eliminates the need of having an expensive computer to act as a Central File Server, something other networks require.

8. SHARE YOUR PERIPHERALS. No longer does each of your computers need its own set of peripherals. Any computer on X-NET is linked to your printers, plotters, disk-drives, etc. A huge money-saver!

Get the best of both worlds. The X-NET Local Area Network with superior software packages, and XCOMP's other hardware accessories. Call your local dealer or XCOMP today.

*X-NET also operates on IBM PC compatibles.



XCOMP, Inc.
3554 Ruffin Road South
San Diego, CA 92123-2502
619-573-0077
TELEX: 182786

IBM is a registered trademark of International Business Machines Corporation.
X-NET is a trademark of XCOMP, INC.

© 1983 XCOMP, INC.

Circle 385 on inquiry card.

Primitive Features	PC-Draw	CADdraft	Benchmark	Vector Sketch	Drawing Processor	CADplan	AutoCAD	VersaCAD
Keyboard Data Entry								
All entries	•	•			•	•	•	•
Coordinate entry		•			•	•	•	•
Absolute coordinates		•			•	•	•	•
Relative coordinates		•				•	•	•
Polar coordinates							•	•
Color	12/83	•	1/84	1/84		•	•	•
Freehand draw	•	•	•	•		•	*	
Lines	•	•	•	•	•	•	•	•
Line types		•	•	•	•	•	•	•
Line weights/widths		•	•	•	•	•	•	•
Rubber-band lines		•	•	•	•	•	•	•
Arcs (2 pt. and center)		•	•	•	•	•	•	•
Arcs (3 pts.)		•	•	•	•	•	•	•
Arcs (angle specification)		•	•			•	•	•
Arc line weight		•				•		
Circle (radius and center)	•	•	•	•	•	•	•	•
Circle (diameter)			•				•	•
Circle (3 pts.)		•			•	•	•	•
Circle line weight		•				•		
Ellipse			•		•			•
Bezier curves			cubic spline					*
Curve smoothing			1/84		*			•
Fillets							•	•
Fill irregular shape	•	•	•		11/84	•	•	•
Fill w/color	•	•	•		11/84	•	•	•
Crosshatch					11/84		*	•
Fill/hatch user-definable			•		11/84		•	•
Fill/hatch part of database	•		•		11/84		•	•
Text	•	•	•	•	•	•	•	•
Fonts supplied	•		•				•	•
Fonts user-definable	•		•		3/84		•	•
Height scaling	•		1/84			•	•	•
Width scaling	•		1/84			•	•	•
Weight	•						•	•
Rotation	•	•	1/84		•	•	•	•
Left justification	•	•	•	•	•	•	•	•
Right justification					1/84	•	•	4/84
Center justification					1/84	•	•	4/84
Word-processor mode	•		1/84			•	•	3/84

Table 5: A comparison of primitive features.

• = existing feature
 * = outstanding feature
 date = expected release date

BYTE COVERS

The prints shown at left are beautiful Collector Edition Byte Covers, strictly limited to 750 prints each, and signed and numbered by the artist, Robert Tinney. Each print is 18 in. x 22 in., and is accompanied by its own Certificate of Authenticity. To order, use the coupon below. Visa and MasterCard orders may call 1-504-272-7266.

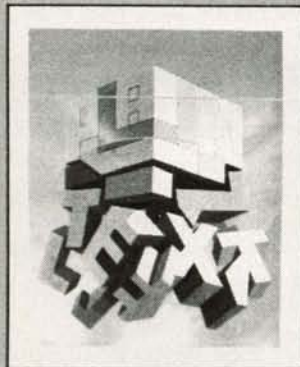

Through the Trap Door
 March 1979—\$35

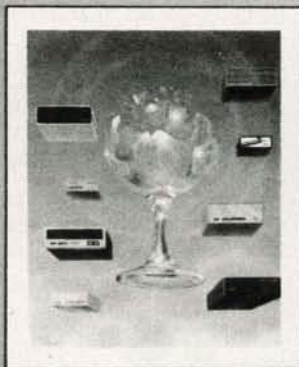

Breaking the Sound Barrier
 September 1977—\$35

Please send _____ **Through the** Visa MasterCard
Trap Door prints (\$35). Card No. _____
Breaking the Sound Barrier Expires: _____
 prints (\$35), or _____ sets of both prints Name: _____
 (\$55). I have included \$3 per order shipping Address: _____
 and handling (\$8 overseas). City: _____
 I have enclosed check or money order State: _____ Zip: _____

Robert Tinney Graphics • 1864 N. Pamela Dr. • Baton Rouge, LA 70815

FREE dBASE II™ SALESMAN

At **SoftwareBanc Dealer Services**, we'll do anything to help you sell dBASE II™. We even tried sending the country's leading dBASE II™ authority, **Adam B. Green**, to all of our dealers. After the first time, Adam wouldn't agree to being shipped UPS again, even after we offered to punch holes in the carton.

Instead, we videotaped him explaining dBASE II™, and interviewing George Tate, Wayne Ratliff, and Fox & Geller.

Make us your dBASE II™ distributor and we'll send you a free copy of this innovative videotape, as well as the bestselling *dBASE II™ User's Guide*. We can also help increase your dBASE II™ profits with our full line of add-on products and **"Mix & Match" pricing**.

Meanwhile, we'll work on sending you the real thing. Do you think putting lettuce on the bottom of the carton would help?



Location courtesy of Tech Computer Store, Cambridge, Massachusetts

SoftwareBanc Dealer Services

661 Massachusetts Avenue, Arlington, Massachusetts 02174

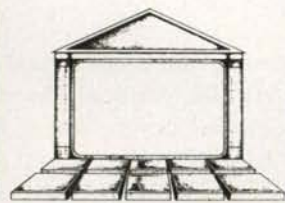

Hours: Mon-Fri, 9AM-8PM EST; Sat, 9AM-5PM EST
To order call: **(800) 451-2502** or **(617) 641-1241** in Massachusetts.
For technical support call: **(617) 641-1235**.
Call us today and join the thousands of smart dealers who enjoy great prices, unbeatable technical support, and fast deliveries.

Editing Features	PC-Draw	CADdraft	Benchmark	Vector Sketch	Drawing Processor	CADplan	AutoCAD	VersaCAD
Edit Control								
Cursor style change					•	•	•	•
Coordinate dial	•	•		•		•	•	•
Status on screen	•	•		•		•	•	•
Status of item		•				•	•	•
Status report		•				•	•	•
Pan	•	•	•			•	•	•
Zoom by scaling		•		•	•	•	•	•
Zoom by window		•	•		•	•	•	•
Refresh (raster redraw)	•	•	•	•	•	•	•	•
Move item	•	•	•	•	•	•	•	•
Move group of items	•	•	•		•	•	•	•
Move by window		•			•	•	•	•
Move between layers		•	•			•	•	•
Move and rotate	•	•	1/84		•	•	•	•
Move and scale	•		•		•	•	•	•
Copy item/group of items	•	•	•	•	•	•	•	•
Copy from disk		•	•	•	•	•	•	•
Copy by window		•					•	•
Copy window to disk			•				•	*
Copy between layers			•					
Copy and rotate	•	•	•		•	•	•	•
Copy and scale	•		•		•	•		
Identify an item		•	•			•	•	•
Erase item/group of items	•	•	•	•	•	•	•	•
Erase by window	•	•	•		•	•	•	•
Erase a layer		•	•			•	•	•
Erase a shape	•	•	•	•	•	•	•	•
Erase previous/beyond previous		•	•	•	•	•	•	•
Restore last				•			•	•
Restore beyond last				•				•
Partial Delete of:								
Lines		•				•	*	•
Arcs							*	•
Circles							*	•
Ellipses								•
Solids								•
Rubber-banding windows						•	•	•
Naming of items							•	•
Shapes/groups/blocks	•	•	•	•	•	•	•	•
Multiple colors/ multiple layers	•	•				•		•
Explode							•	•
Nesting	•						•	•
Save to disk	•	•	•	•	•	•	•	•
Drawing libraries on disk	•	•	•	•	•	•	•	•
Merge with current drawing		•		•	•	•	•	•
Merge exploded							•	•
Merge and rotate/scale							•	•
Modify base point						•	•	•
Directory of disk files while in drawing editor	•	•		•		•	•	•

Table 6: A comparison of editing features.

• = existing feature
 * = outstanding feature
 date = expected release date

Text continued from page 198:

puters, the software needs to support them. If someone borrows your plotter and you want to attach a different one, is the software flexible enough to reconfigure on the fly?

Is the software language used by the package upwardly mobile? Does it have a file-structure option other than the drawing file format? In other words, can you communicate with

other programs, or are you locked into this particular vendor? Do you receive a detailed description of the drawing file structure?

Good documentation helps in

computers wholesale

315-472-3055

Box 150 Brewerton, N.Y. 13029

Reader Service # 106

We pay UPS shipping charges on prepaid orders.

-TERMINALS-

ESPRIT	
Esprit.....	\$469
Esprit II.....	499
Esprit III.....	649
LEAR SEIGLER	
ADM 3A.....	529
ADM II.....	539
ADM 36.....	979
QUME	
102.....	549
102A (Amber).....	569
108.....	715
TELEVIDEO	
910.....	439
914.....	579
924.....	695
925.....	699
950.....	865
970.....	929
TEXAS INSTRUMENTS	
TI 703 Printing Terminal.....	Call
TI 707 Print Term. w/modem.....	Call
WYSE	
50.....	Call
300 (Color).....	Call
ZENITH	
Z-29.....	649
ZT-10.....	399
ZT-11.....	459
-MODEMS-	
HAYES	
Micro Modem 100.....	269
Micro Modem II.....	239
Smartmodem 300.....	199
Smartmodem 1200.....	498
Smartmodem 1200B.....	Call
NOVATION	
D-Cat.....	149
J-Cat.....	105
Apple Cat II.....	259
103 Smart Cat.....	179
103/212 Smart Cat.....	399
212 Auto Cat.....	549
Access 1-2-3.....	449
SIGNALMAN	
Mk I..... \$ 79	Mk VII..... \$109
Mk III..... 99	Mk II..... 79
Mk V..... 89	Mk VI..... Call
U.S. ROBOTICS	
Auto Dial 212A.....	439
Password.....	339

-SYSTEMS-

ALTOS			
ACS-8000-10.....	\$5889		
ACS-8000-12.....	6995		
ACS-8000-14.....	8789		
Series 5-5D.....	3990		
Series 5-15D.....	2199		
580-10.....	3995		
586-10.....	5995		
586-40.....	8795		
MTU-4.....	2395		
Altos II Terminal.....	849		
COLUMBIA			
VP Portable.....	Call		
MPC.....	Call		
MPC w/Hard Disk.....	Call		
CROMEMCO			
C-10 Super Pak.....	1429		
C10MP w/MicroPro software.....	1819		
CS-1.....	3195		
CS-2.....	3755		
CS-3.....	5595		
64 FDC.....	475		
TUART.....	255		
EAGLE			
II E Series	PC Series		
II E-1	II E-2	PC-E	PC-1
II E-3	II E-4	PC-2	PC-XL
1600 Series	SPiRiT		
1620	1630	Portable	
-Call us today for the best prices-			
INTERTEC.....		CALL	
MORROW			
Micro Decision			
MD-2 w/2 drives & software.....	929		
MD-3 w/DS drives & software.....	1199		
MD-11 w/HD & software.....	1949		
NEC			
PC-8201.....	Call		
PC-8801A Computer.....	Call		
PC-8831A Dual 5 1/4" disk drive.....	Call		
NORTHSTAR			
Advantage 2Q.....	Call		
Advantage 1Q HD5.....	Call		
HD 18 Mb. hard disk.....	3879		
SANYO			
MBC 1100.....	\$1399		
MBC 1200.....	1599		
MBC 4000.....	Call		
MBC 550.....	Call		
TELEVIDEO			
TS-803.....	1989		
Portable.....	Call		
ZENITH			
ZF-100-21.....	2319		
ZF-120-22.....	2869		
ZF-120-32.....	4479		

-PRINTERS-

ANADEX	
DP-9501.....	\$1099
DP-9620.....	1199
DP-9625.....	1299
DP-6500.....	2399
WP-6000.....	2159
CENTRONICS	
730-1 Parallel.....	199
739-3 Serial.....	449
COEX 80 FT parallel.....	239
C.ITOH	
Prowriter 8510A Par.....	369
Prowriter 8510A Ser.....	569
Prowriter II Par.....	669
Prowriter II Ser.....	739
DIABLO	
620 RO 25 CPS.....	919
630 RO 40 CPS.....	1769
EPSON	
RX-80.....	Call
RX-80FT.....	Call
FX-80.....	Call
FX-100.....	Call
GEMINI	
10X.....	295
15X.....	435
MANNESMAN TALLEY	
MT-160 I.....	529
MT-160 L.....	599
MT-180 L.....	859
SPiRiT.....	Call
NEC NEW NEC 2000	
3510..... \$1445	3530..... \$1490
3550..... 1845	7710..... 1949
7715..... 1949	8023..... 399
OKIDATA	
ML-82A.....	299
ML-83A.....	569
ML-92 Par.....	449
ML-92 Ser.....	529
ML-93 Par.....	709
Pacemark 2350.....	Call
Pacemark 2410.....	Call
PANASONIC	
KX-P1090.....	319
QUME	
Sprint 11/40.....	1299
Sprint 11/55.....	1499
SILVER REED	
EXP 500 Par.....	459
EXP 550 Par.....	659
EXP 550 Ser.....	689
TEXAS INSTRUMENTS	
TI 810 Basic.....	1199
TI 810LQ.....	1919
TI 850 Par.....	499
TI 855.....	Call

-MONITORS-

AMDEK	
Color I.....	\$275
Color I+.....	319
Color II (RGB).....	399
Color III (RGB).....	349
300 G (12" green).....	135
300 A (12" amber).....	145
310 A (IBM PC).....	169
BMC	
15 MHZ (12" green).....	79
NEC	
JB-1260 (12" amber).....	109
JB-1201 (12" green).....	135
JC-1212 (12" color).....	339
JC-1203 (12" RGB).....	549
PANASONIC	
12" Green Monochrome.....	169
12" Amber Monochrome.....	179
13" RGB.....	389
TEXAN	
KG 12N (12" gr.).....	129
RGB Vision I (12" color).....	299
ZENITH	
Z-122 (12" green).....	109
Z-123 (12" amber).....	139
Z-131 (13" color + gr.).....	299
Z-135 (RGB).....	519

-HARD DISKS-

CORVUS	
Model 6.....	1869
Model 11.....	2549
Model 20.....	3399
Omnet 6.....	1695
Omnet 11.....	2375
Omnet 20.....	3225
Mirror Back-up.....	670

-DISKETTES-

3M/ Scotch	
5 1/4".....	\$21.95
(Single Sided, Double Density)	
5 1/4".....	\$30.95
(Double Sided, Double Density)	

If you can't find what you need listed here, just call for the best prices on the items you require.

N.Y. residents, add appropriate sales tax. We accept VISA and Master Card. Personal and company checks, allow 2 weeks to clear. C.O.D.'s require a 25% deposit. All prices and offers may be withdrawn without notice.

Advertised prices reflect a cash discount on prepaid orders only. Most items are in stock for immediate delivery in factory sealed cartons with full factory warranties.

Miscellaneous Features	PC-Draw	CADdraft	Benchmark	Vector Sketch	Drawing Processor	CADplan	AutoCAD	VersaCAD
Math Calculations								
Distance		•	1/84		•	•	•	•
Area			1/84		•	•	•	•
Area—irregular			1/84		•		•	•
Volume						•		
Angle			•		•			•
Feet and inches		•			•	•	•	•
Dimensioning								
Autodimensioning			1/84			•	•	•
Angular dimensioning						•		•
Associative dimensioning						•		
Miscellaneous								
Grid/user-definable grid	•	•	•	•	•	•	•	•
Different x and y scales		•	•			•		•
Grid snap	•	•	•	•	•	•	•	•
Multiple definitions	•	•	•	•	•	•	•	•
Auto change with rescale/zoom							•	
Tolerance/incremental snap	•	•		•	•	•	•	•
Layers		•	•			•	•	•
Mixed color on one layer		•	•			•	•	•
Define attributes of layer						•		•
Move between layers		•	•			•	•	•
Regenerate only active layers			•					•
Plot only active layers		•	•			•	•	•
Save only active layers			•					•
Rectangular arrays						•	•	•
Radial arrays							•	•
Menu on screen in editor	•	•		•		•	•	12/84
Menu on input device			•		•	•	•	12/83
Menu user-definable	•		•		•	•	•	4/84
Command (macro) files in menu							•	6/84
Other command file use			•			•	•	•
Symbols on digitizer					•		•	•
Symbols (icons) on screen	*							
CAE utilities			•		•	•	•	
CAM utilities								•
Three-dimensional interface								•

Table 7: A comparison of miscellaneous features.

• = existing feature
 * = outstanding feature
 date = expected release date

mensely in taking you through the learning process. You want a well-organized manual, a good table of contents, a setup and hardware configuration section, a strong tutorial section, a full discussion of features with examples, a quick reference section, a section on error messages, a good index, and a glossary of terms. It is important to have a manual with illustrations from the CAD program itself.

Look for sample drawings or an interactive tutorial on disk and Help files accessible without having to leave the drawing editor. See that

prompts are helpful and don't stand in the way of your drawing. It is convenient to have a directory of the files

The cost of hardware is falling, while quality and capability are on the increase.

on the disk available from within the graphics editor as well.

Summary

I hope this whets your appetite for

graphics. Graphics image processing offers an electronic frontier every bit as exciting to explore as it once was to migrate west to mine for gold.

CAD software is becoming more powerful and reasonably priced. The cost of hardware is falling dramatically, while quality and capability are on the increase. More power and capability are coming, but is all the work we do now translatable into the future?

It is difficult to draw conclusions about whether one software package is better than another. That decision is largely determined by your per-

GenTech

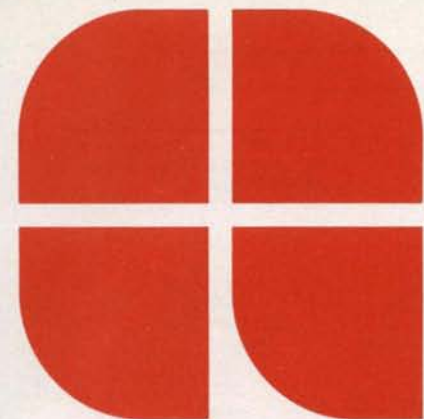

NEW YEAR SPECIALS

LOTUS 123	\$Call
Transtar 315 Color Printer	\$489
64K RAM for IBM	\$55
Smartmodem 300	\$205
CABLES	
4FT PARALLEL	\$35
4FT SERIAL	\$40
Microsoft Premium pack	\$489
NEC Spinwriters ALL Models	\$Call
OTRONA ATTACHE	\$2595
BASIS 108 128K CP/M 3.0	\$1999
PROWRITER I	\$389
PROWRITER II	\$659
EPSON FX-100	\$725
RANA ELITE I	\$245
RANA ELITE II	\$380
RANA 1000 (FOR ATARI)	\$309
BUFFERED GRAPPLER	
16K	\$179
32K	\$199
64K	\$239
MULTIPLAN IBM, Apple II/IIe	\$169
IBM PC DSDD Drive	
TANDON DRIVE	\$239
RANA	\$299
QUENTIN	\$275
FOURTH DIMENSION	\$275

CUSTOMER SERVICE & TECH. SUPPORT

401-273-2420

ORDERS ONLY

800-843-4302

150 Broadway, Suite 2212, N.Y. NY 10038

Money Order, Cashier Ck. Add 3% MC/VISA Charge
 Add 2% on COD Orders. Minimum Shipping Charge \$5
 APO Orders Add 10%. Add 5% for Net Terms.
 All Returned Non Defective Merchandise are Subject to
 20% Restocking Charge.



Circle 168 on inquiry card.

COMPUTERS

FRANKLIN	
ACE 1000 w/color	\$799
ACE PRO PLUS Systems, ACE 1000	
w/color, ACE 10 Drive, 80-Column Card,	
ACE Writer II, ACE Calc, Monitor, Data	
Perfect, Personal Financier	\$Call
ACE 1200 (128K, Dual Processor,	
1 Drive, 80-Col. CBASIC,	
CP/M & DOS.	\$Call
ACE Office Management System	
ACE 1200 w/2 Drives, I/O Card,	
WordStar, MailMerge, ACE Calc.	\$Call



COLUMBIA	
128K Ram, Dual DSDD (640K) Drives,	
Fully IBM Compatible	
w/Superpack	\$Call
128K RAM, 10 MB Hard disk	
w/Superpack	\$3950
Portable VP w/Superpack	\$Call

COMPUPRO	\$Call
ALTOS 586 SERIES/8000 SERIES	\$Call
CORONA PC (Hard or Floppy)	\$Call
Portable PC	\$Call

EAGLE	
PC-2 128K RAM w/2 Drives	
(640K)	\$Call
PC-XL 128K RAM 1 Floppy,	
10 MB Hard	\$Call

KAYPRO CO-POWER BOARD	
IBM Compatible 128K DR 256K	
w/MS-DOS & CP/M 86	\$Call

MORROW DESIGNS	
MD2 64K, 2 DSDD Drives, WordStar,	
LogiCalc, Correct-It, Personal Pearl	
MD3 64K, 2 DSDD Drives, Above	
Software PLUS QUEST Accounting	
Package	\$Call
MD11 128K, 400K DR, 2 Serial,	
1 Parallel.	\$Call
DECISION Series D200, D210, D220	
Multi User Decision Series	\$Call
PIED PIPER	\$995
SANYO MBC 550	\$Call

PLOTTERS

AMDEK Amplot	\$Call
COMREX Comscribe	\$Call
SWEET-P Plotter	\$Call
MANNESMANN Pixy-3	\$Call

BAUSCH & LOMB	
DMP 40	\$879
DMP 29 (8 COLOR 11 x 17 PAPER)	\$1995
DMP 41 (SINGLE PEN 22 x 17 INCH)	\$2599

FOR APPLE II/IIe, Franklin Ace

Fourth Dimension Super Drive	\$219
80-Col. w/64K (Ile Only)	\$189
16K RAM	\$49
ALS CP/M Card	\$299
ALS Dispatcher	\$89
MicroSoft SoftCard	\$239
Grappler +	\$119
Graphitti	\$95
Pkaso card	\$129
IS Pipeline	\$Call
Microtek Duplicing GX	\$99
Microtek Duplicing 16(16K)	\$169
EPD Surge Protectors	\$Call

FOR IBM PC

AST RESEARCH INC.	
MEGA PLUS	
64K w/Serial & Clock/Cal	\$279
128K \$379, 192K \$449, 256K \$489	

64K w/Ser. Par & Clock	\$399
128K \$459, 192K \$579, 256K \$599	
MEGA PAK 256K Module	\$289

SIX PACK PLUS

COMBO PLUS	
64K w/Serial & Parallel	\$279
128K \$369, 192K \$419, 256K \$499	

I/O PLUS	
Serial \$39, Parallel \$39, Game port \$39	\$129

QUADRAM	
QUARBOARD	
64K	\$279
256K	\$419

512+ EXPANSION BOARD	
Quad 512+(64K)	\$239
Quad 512+(256K)	\$399
Quad 512+(512K)	\$639
QUADLINK	\$489

MICROFAZER	
P/P (Parallel/Parallel)	
8K \$125, 64K \$199, 128K \$309	
256K \$589, 512K \$899	
S/P, P/S, S/S	
8K \$145, 16K \$165, 32K \$195, 64K \$229	
9V Power Supply	\$16.99

HARD DISK



COMREX	
COMFILER 10 MB FOR QX-10	\$1995

CORVUS		DAVONG (Internal)	
6 MB	\$1695	5 MB	\$Call
10 MB	\$2350	10 MB	\$1650
20 MB	\$3150	20 MB	\$2495

XCOMP		QCS	
10 MB	\$1795	10 MB	\$Call
16 MB	\$1995	Tall Grass	\$Call

DOT MATRIX PRINTERS



EPSON	
RX-80	\$299
RX-80 F/T	\$Call
MX-100	\$599
FX-80	\$569

STAR MICRONICS	
GEMINI 10X	\$299
GEMINI 15/15X	\$Call
OKIDATA	
MICROLINE 92	\$449
MICROLINE 93	\$729
MICROLINE 84 P	\$979

MANNESMANN TALLY	
MT180L (160 CPS)	\$615
MT180L (15" Carriage)	\$875

INFO RUNNER RITEMAN	\$Call
TOSHIBA P1350	\$Call

LETTER-QUALITY PRINTERS



C-ITOH	
F-10 STARWRITER	\$1169
F-10 PRINTMASTER	\$1589

COMREX	
COMRITER I (P or S)	\$639
COMRITER II Parallel	\$479
COMRITER II Ser (5K)	\$509

DAISYWRITER	
2000 EXP (48K BUFFER)	\$1019
JUKI (18 CPS 15")	\$529
NEC SPINWRITER	\$Call
QUME SPRINT 11/40	\$1349
SILVER REED	
EXP 550P	\$639
EXP 500P	\$439
EXP 550S	\$679
EXP 500S	\$499
TRANSTAR T315, T120, T130 & T140	\$Call

MONITORS



AMDEK	
300G	\$Call
COLOR I	\$Call
COMREX color, green, amber	\$Call
PRINCETON GRAPHICS HX-12	\$409
QUADSCREEN	\$Call
TAXAN	
RGB VISION I	\$279
WITH APPLE II+ CABLE & INTERFACE	\$345
RGB INTERFACE for Apple IIe	\$Call
RGB VISION III	\$519
KG 12N-UY (12" amber)	\$135
USI PI-1 (9" green)	\$79

TERMINALS



Freedom 100 (11 FTN Key green)	\$409
Visual 50 Detachable KYBD	\$509
Televideo 910+	\$509
Televideo 925	\$739
Televideo 950	\$949

MODEMS

ANCHOR	
MARK I (300 baud), MARK XII (IBM)	\$Call
HAYES	
MICROMODEM II	\$275
SMARTMODEM (1200 BAUD)	\$509
SMARTMODEM 1200B for IBM	\$439
SMARTCOM II (TERMINAL PROG)	\$69

NOVATION	
ACCESS 1-2-3	\$Call
CAT 300 BAUD Acoustic	\$149
D-CAT 300 BAUD Direct	\$155
J-CAT 300	\$109
APPLE CAT II	\$269
212 APPLE CAT II	\$579
103 SMART CAT	\$179
103/212 SMART CAT	\$419

SSM	
300 BAUD MODEM CARD	\$239
1200 BAUD MODEM CARD	\$529
TRANSEND 1/2/3	\$69/\$109/\$209

US ROBOTICS	
PASSWORD	\$Call
VEN-TEL	\$Call

DISKETTES

3M DSDD Diskette	\$26
3M DSDD Diskette	\$Call
DYSAN DSDD	\$37
DYSAN DSDD	\$Call
Verbatim DSDD	\$25
Verbatim DSDD	\$30

sonal preference and application. Take the time to make sure the software/hardware configuration you purchase is, or will be, equal to your drawing needs (see figure 6). Above all, ask the right questions and get satisfactory answers. ■

Rik Jadrnicek is president of Micro Flow (POB 1147, Mill Valley, CA 94942), a microcomputer consulting firm. When he isn't writing or playing with micros, Rik likes sailing and traveling.

For Further Information

Newsletters

The Anderson Report

Anderson Publishing Company
4505 East Industrial St., Suite 2J
Simi Valley, CA 93063
(805) 581-1184 Published monthly

CAD/CAM Alert

The Management Roundtable Inc.
822 Boylston St.
Chestnut Hill, MA 02167
Published monthly

The S. Klein Newsletter on Computer Graphics

Technology & Business Communications Inc.
POB 89, 730 Boston Post Rd.
Sudbury, MA 01776
(617) 443-4671 Published twice monthly

Directories

1983 Publications Catalog

IEEE Computer Society
Administrative Offices
POB 639
Silver Spring, MD 20901
Source of books on graphics

The S. Klein Directory of Computer Graphics Suppliers

Technology & Business Communications Inc.
POB 392, 730 Boston Post Rd.
Sudbury, MA 01776
Hardware, software, systems, and services

Periodicals

Computer Design

119 Russell St.
Littleton, MA 01460

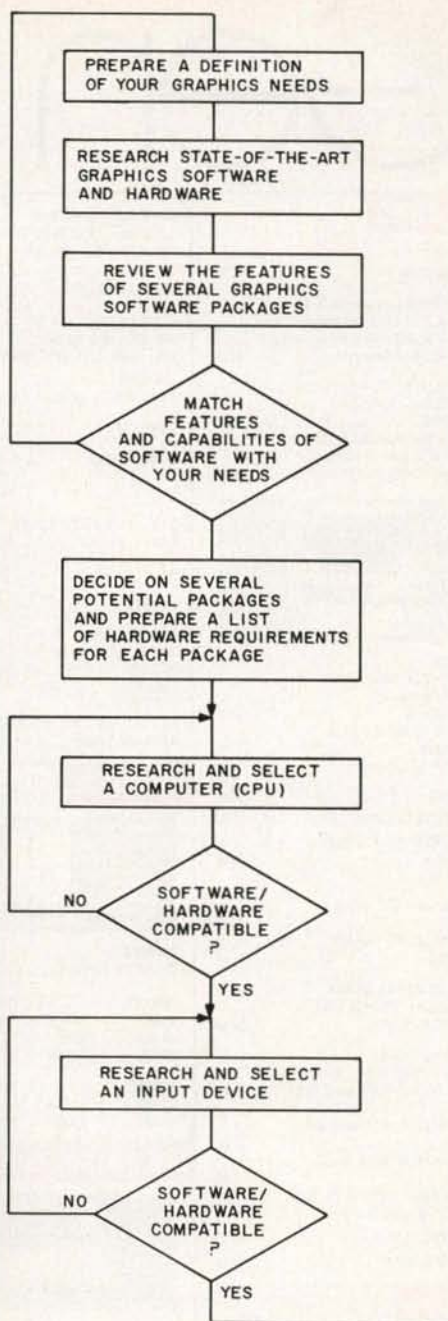

Figure 6: How to buy a CAD system.

Computer Graphics and Applications

IEEE Computer Society
10662 Los Vaqueros Circle
Los Alamitos, CA 90720
(714) 821-8380

Computer Graphics World

Computer Graphics World
Publishing Company Inc.
POB 122
Tulsa, OK 74101
(800) 331-5959

Cray Channels

Cray Research Inc.
POB 154
Minneapolis, MN 55440
(612) 333-5889

Digital Design

Morgan-Grampian Publishing Company
1050 Commonwealth Ave.
Boston, MA 02215

Electronic Imaging

Berkshire Common
Pittsfield, MA 01201

Release Your Potential



With the p-System™ from

For: IBM PC & XT CORONA COLUMBIA EAGLE COMPAQ COLBY DOT HYPERION

Do you feel stifled by your operating system? The p-System from NCI will release you. It is the complete program development environment for the IBM Personal Computer and compatibles. This is the fast p-System with the special p-machine emulator developed by NCI.

The p-System from NCI gives you everything you need in one system at far less than the cost to add similar utilities to any other OS. It includes a powerful screen editor, a multi-function file manager and RAMdisk support for fast access to files. Dynamic memory allocation lets you create programs larger than 64K and a print buffer frees your

computer to perform other tasks while printing.

This operating system is stable, friendly and easy to use. Command options are presented on a menu requiring only a single keystroke. The 8087 Numeric Coprocessor Support allows extremely fast floating point calculations and the asynchronous I/O lets you use serial printer and communications routines.

With the p-System you can choose either UCSD Pascal, Fortran 77 or Basic as your programming language. NCI also offers hard disk support for the IBM XT, Corona, Columbia, Corvus, Tallgrass, Davong, Genie 5+5, QCS, Datamac,

Microdisk and Santa Clara. Corvus OMNINET support can easily be added as well as memory cards from AST Research and Tall Tree Systems, the Colorplus card and the Hercules graphics card.

When you buy the p-System from NCI you get technical support and complete documentation.

For full details call or write:

Network Consulting Inc.
Discovery Park,
Suite 110 - 3700 Gilmore Way
Burnaby, B.C. Canada V5G 4M1
(604) 430-3466

SPEED. PORTABILITY. RELIABILITY.

IBM Personal Computer and IBM Personal Computer XT are trade marks of International Business Machines Corporation. The p-System™ is a trade mark of Softech Microsystems, Inc. UCSD Pascal is a trade mark of the Regents of the University of California. OMNINET is a trade mark of Corvus Systems Inc. 5+5 is a trade mark of Genie Computer Corporation. Colorplus is a trade mark of Frederick Electronics.

Glossary of CAD Terms

absolute coordinates: the location of a point in terms of x , y , or z distance from the predefined origin.

absolute vector: a line segment with an endpoint expressed in x , y , and z coordinates.

aliasing: the stairstep effect on a raster display lacking the resolution to reproduce diagonals or circles as smooth images.

antialiasing: the software adjustment of raster-pixel addressing to make diagonal or curved lines appear smooth and continuous.

aspect ratio: a design engineering term meaning the ratio of display width to display height.

associative dimensioning: updating dimensions of individual CAD/CAM display elements as display dimensions change.

attribute: any characteristic of a display item (color, line style, character font) or associated descriptor (style, shape, tolerance, part type or number).

beam-penetration CRT: this produces color by varying the electron-beam penetration of a multilayer phosphor display surface.

Bezier curve: a method of curve fitting (smoothing) by manipulating two line segments and the curves that are tangent to their surfaces.

bit map: the digital representation of an image in which bits are mapped to pixels. In color graphics, a different bit map is used for each red, green, and blue value.

bit plane: hardware used as a storage medium for a bit map.

CAD: computer-aided design, drawing with the aid of your computer.

CAE: computer-aided engineering, an interface with mathematical analysis and drawing capability.

CAI: computer-aided instruction, using computers for individual and classroom instruction.

CAM: computer-aided manufacturing, automated production.

clipping, windowing, and viewing: the process of setting graphics-display boundaries.

composite color: color information encoded in a single video signal.

computer animation: the use of computer graphics to simulate or generate images for motion pictures.

control dial: a graphics input device that produces a continuous range of display values.

coordinates: a number of x , y , and z units that give the location of a point in a coordinate system.

cross hairs: the cursor or two intersecting perpendicular lines on display to indicate coordinate location.

device coordinate system: the coordinate system and axis length recognized by the display device.

device-independent CAD: CAD software capable of running on more than one type of computer or input/output device.

digitize: to register a visual image or real object in a format that can be processed by the computer; data is read into the system with a puck, cursor pad, or stylus.

dimensioning: setting measurements on a CAD/CAM display; placement of dimension lines and arrowheads; calculation and placement of dimension distances.

display: a collection of graphics elements visible on the monitor.

dot matrix: a pattern of dots in a two-dimensional array.

dot-matrix plotter: a hard-copy device that reproduces the display as a pattern of dots.

dragging: leading an item, such as a user-defined cursor, across the display with a graphics input device.

draw: to generate a visible vector by moving a pen or by illuminating pixels between the current position and an endpoint specified in coordinates (absolute draw) or in displacements (relative draw).

echo: a graphics display, such as a text string or cursor, that provides visual feedback to the operator.

electroacoustic tablet: a data tablet with a writing surface of magnetostrictive material capable of tracking a stylus.

electrostatic plotter: a raster hard-copy device that produces images on paper sensitized to electrostatic charges.

endpoint: the end of a line segment expressed in terms of x , y , and z coordinates.

fill: solid coloring or shading of display surface made by a pattern of line segments.

fillet: a design engineering term meaning the concave transition surface between two otherwise intersecting surfaces.

flatbed plotter: a plotter with a flat display surface that you move across, up, down, and diagonally, with the plotting head.

frame buffer: local raster memory that stores the bit patterns mapped to pixels.

function key: the key on a function pad that triggers a programmable operation such as rotation or scaling.

geometric model: quantitative representation of a two- or three-dimensional object created by referring to the Cartesian coordinate grid.

grid: uniformly spaced intersecting lines in two or three dimensions, which provide addresses for graphics objects.

hatching: filling an area of the display surface with a regular pattern of line segments.

icon: a graphics symbol representing a menu item.

image digitizer: a video camera with an electron-beam scanner that senses light and transforms it into a video signal.

imaging: computer processing of graphics data to produce a display.

incremental plotter: a hard-copy output device that repeats a display at discrete intervals.

incremental vector: a repeated vector defined by a regularly increased or decreased component and an absolute component.

ink-jet plotter: a hard-copy plotter that uses electrostatics first to atomize ink, then to place droplets on the plotting medium.

joystick: a graphics input device that positions a cursor, locator, or pick or initiates a program change with a control lever.

laser plotter: this plotter uses a laser to produce images on photographic film in raster or vector format.

layer: logical two-dimensional CAD/CAM data divisions that can be viewed individually or as overlays.

light pen: the graphics input device used as a pick to identify a detectable display element.

line style or type: a primitive attribute that defines a line as solid or dashed and gives the dash pattern and terminators.

line width or weight: this primitive attribute defines a line's thickness.

mapping: transforming an image from one coordinate system to another.

matrix: an array of x , y , and z coefficients for calculating a geometric transformation.

mirror: to create the reverse image of a display item.

mouse: a hand-held input device used to position the cursor on the display surface.

numerical control: computer instructions that automate machine and drafting tools.

origin: the zero intersection of x , y , and z axes from which all points are calculated.

orthographic projection: graphics representation of a three-dimensional object lacking the perspective suggested by the convergence of parallel lines. It permits only vertical and horizontal line segments in a two-dimensional drawing.

overlay: the plane of a graphics display that can be superimposed on another plane.

paging: overflowing the drawing database to disk.

painting: a raster design technique based on illuminating pixels on a graphics display device.

pan: movement across the x and y grid.

parallax: apparent image translation from its initial location to the point indicated by a light pen.

perspective projection: simulation of depth and distance by representing parallel lines merging at a vanishing point.

pixel: the minimum raster display element represented as a point with a specified color or intensity level.

pixel replication: scaling by increasing the number of pixels excited, but without the increased detail of true magnification.

plotter: a computer-controlled pen device that produces a hard copy of the display on paper or an electrostatic surface.

polar coordinates: location of a point in terms of the distance and angle from another point.

polygon fill: coloring or cross-hatching of a closed, multisided, program-defined surface.

primitive: the basic display element: point, segment, alphanumeric character, or marker.

primitive attribute: a visual characteristic of an output primitive, such as character size, line style, or blink rate.

puck: a hand-held device with cross hairs used to input coordinate data.

RGB color: a color described in terms of its red, green, and blue intensity levels.

RS-232: this serial interface permits linkage of a host computer and graphics terminal(s) or other peripherals over long distances.

raster: a rectangular pixel matrix permitting dynamic color displays.

raster display: a CRT display generated by an electron beam that illuminates.

raster plotter: this plotter reproduces displays in dot-matrix patterns.

relative coordinates: location of a point relative to another data point.

relative draw: movement of the electron beam in terms of x, y, and z distances for the purpose of drawing a visible vector on the display surface.

relative move: electron-beam movement in terms of x, y, and z distances without leaving a visible trace on the display.

relative vector: a vector with an endpoint specified in terms of the distance from the current position rather than in terms of absolute x, y, and z coordinates.

rotate: to transform a display or display item by revolving it around a specified axis or center point.

rubber banding: attaching the cursor to

a fixed display point with a line that appears to stretch and contract like a rubber band as you move the cursor.

SIGGRAPH: Special Interest Group on Computer Graphics.

scale: a size change made by multiplying or dividing the coordinate dimensions.

scale factor: the value by which you divide or multiply the display dimensions in a scaling operation.

screen coordinate system: the coordinate system of the display device; normally, the address limits of the axis length it recognizes.

scrolling: moving text strings or graphics vertically.

stairstepping: jagged raster representation of diagonals or curves; corrected by antialiasing.

static attribute: an unchangeable display characteristic of the input device.

tablet: a data tablet or digitizer; a graphics input device that generates coordinate data from visual data input through a puck or stylus.

touch-sensitive display: a display surface that receives data through physical contact.

trace: a line of the graphics display.

trackball: this mounted rotatable ball controls the position of the cursor and produces coordinate data.

transformation: geometric alteration of a graphics display, such as scaling, translation, or rotation.

translate: to shift a display item across the display surface to a new location.

turnkey: a computer system sold complete and ready to use for a specific application; requires no additional hardware modification or planning.

viewport: the specified window on the display surface that marks the limits of a display.

virtual coordinate system: coordinate system created by mapping a portion of the world coordinate system to the space available on your device.

virtual space: space referenced with the coordinates defined by the application.

window: a specified rectangular area of virtual space shown on the display.

window clipping: blanking line segments at window boundaries.

wire frame: a three-dimensional image displayed as a series of line segments outlining its surface.

world coordinate system: a device-independent coordinate system used to define display objects.

zoom: to scale a display or display item so it is magnified or reduced on the screen.

GPIB ↔ PC



IEEE-488

High Speed Interfaces
for Personal Computers

IBM PC™

IBM PC Compatibles

RAINBOW 100™

Zenith Z-100™

TI professional

Language Support—BASIC,
C, FORTRAN, Pascal, Assembly

Operating Systems—PC DOS,
MS-DOS, CPM 86/80, Z DOS, UNIX

Software Compatible with our
family of IEEE-488 Interfaces
for VAX, PDP-11, LSI-11, S-100
BUS, STD BUS, SBX, and
Multibus computers.



NATIONAL INSTRUMENTS

The Leader in IEEE-488
Computer Interfaces

12109 Technology Blvd.
Austin, Texas • 78727

800/531-5066 • 512/250-9119

Rainbow™ is a trademark of Digital Equipment Corp.
IBM PC™ is a trademark of International Business Machines.

The Choice of

SAVE THIS AD IT IS YOUR CATALOG AND CHANGES MONTHLY

HARDWARE For The APPLE II+ / IIe

APPLE IIe 128K, 80 COLUMN \$1,295

APPLE IIe STARTER SYS. BY APPLE (Sys. A) Disk II with controller \$1,650

APPLE IIe STARTER SYSTEM BY CONROY-LA POINTE (SYSTEM B) 128K and 80 column 1 Micro-Soft Drive with controller Flier, Utility and Apple DOS 3.3 Diskette Zenith 12" Green Monitor RF Modulator (for color TV) Game Paddles Game w/ color graphics and sound 20 Blank Diskettes \$1,650



LIMITED WARRANTY: is 100% Parts & Labor for 90 days by us

DISK DRIVES

* CENTRAL PT. Flier, Utility & Apple DOS \$ 20 \$ 15

μ-SCI A2 143K Disk Drive \$ 479 \$ 230
A2 Controller Card \$ 100 \$ 79
MICRO-SCI *A40 160K Drive \$ 449 \$ 299
*A70 286K Drive \$ 599 \$ 299
A40 A70 Controller \$ 100 \$ 79

SUPER 5 ALPS A40, Bell Drive, 163K \$ 299 \$ 199
TEAC T40, Direct Drive, 163K \$ 349 \$ 229
TEAC T80, Double Sided, 326K \$ 449 \$ 329
Controller Card \$ 110 \$ 59

Rana Elite 1, 163K, 40 TK \$ 379 \$ 249
Elite 2, 326K, 80 TK \$ 649 \$ 399
Elite 3, 652K, 160 TK \$ 849 \$ 499
Elite Controller \$ 145 \$ 84

VISTA DiskPak V1200, 6MB Backup Sys \$1549 \$1049

OVERSTOCK SPECIALS

WHILE THEY LAST

* Axlon, 320K RAM Disk System (+ or e) \$1000 \$650
* CCS, Serial Interface 7710A (Set/Baud) \$ 150 \$ 99
* ComX, 16K RAM Card, 1Yr. Wty. for II+ \$ 179 \$ 39
* Microsoft, 16K RAM Card for II+ \$ 100 \$ 69
* Silicon Valley, Word Handler \$ 250 \$ 39
* List Handler \$ 90 \$ 35
* Videz, Videoterm, 80 column card for II+ \$ 345 \$ 229

RAM EXPANSION

* ComX, for IIe, 80 col - 64K Adder Card \$ 295 \$145
* ComX, RAM Card, 1Yr. Wty. (II+ / 16K \$ 179 \$ 39
* ALS, ADDRAM (II+) 16K \$ 100 \$ 59
* Microsoft, RAMCARD (II+) 16K \$ 100 \$ 69
* Saturn Systems, RAM Card (II+) 32K \$ 249 \$169
* RAM Card (II+) 64K \$ 425 \$299
* RAM Card (II+) 128K \$ 599 \$399
* Axlon RAM Disk System (+ or e) 320K \$1000 \$650

VIDEO CARDS

* ALS, Smarterm II (+ or e) \$ 179 \$139
ComX, 80 col - 64K Adder (IIe) \$ 295 \$145
Videz, Videoterm 80 col. (+ or e) \$ 345 \$229
* UltraTerm (+ or e) \$ 379 \$279
* Soft Video Switch (II+) \$ 35 \$ 25
* Enhancer II (II+) \$ 149 \$ 99
* Function Strip (II+) \$ 79 \$ 59
We Have Full Videx Line. Call. Up to 35% off.

Vista, Vision 80 \$ 289 \$199

MISCELLANEOUS

ALS, The CP/M Card V3.0 (+ or e) \$ 399 \$299
Z-Card (+ or e) \$ 169 \$129
Color II (+ or e) \$ 179 \$139
* ASTAR, RF Modulator, to use TV \$ 35 \$ 25
* CCS, Serial Interface 7710A \$ 150 \$ 99
* Eastside, Wild Card (copier, + or e) \$ 140 \$ 99
Wild Card Plus \$ 190 \$139
Kensington, System Saver \$ 90 \$ 65
* Key Tronic, KE200 keyboard (II+) \$ 298 \$219
* Koala, Graphics Pad \$ 125 \$ 89
Kraft, Joystick (Ap II+) \$ 65 \$ 39
* Paddle (Ap II+) \$ 50 \$ 29
* M&R, Sup R Plan (+ or e) \$ 50 \$ 39
* Microsoft, Z80 Softcard (+ or e) \$ 345 \$235
Z80 Softcard Plus (+ or e) \$ 645 \$459
Softcard Premium Card (II+) \$ 695 \$495
Softcard Premium Pack (IIe) \$ 495 \$395
* Micro Tek, Dumping 64, Buffer \$ 349 \$269
* Orange Micro, Grappier Plus (e or +) \$ 175 \$119
16K Buffer Board for Grappier + Bufferd Grappier - , 16K \$ 245 \$179
* Paymar, Lower Case Chip (II+) \$ 50 \$ 39
* PCPI, Appli-Card, 14 features 6Mhz 128K Memory Expand Board \$ 375 \$275
* RH Electronics, Super Fan II \$ 75 \$ 59
* Saturn Systems, Accelerator II \$ 599 \$449
* Transcend, SSM, AIOII, Serial Para I/F \$ 225 \$169
* TG Products, Game Paddles (II+) \$ 40 \$ 29
Joystick (II+) \$ 60 \$ 45

SAVE THIS AD IT IS YOUR CATALOG AND CHANGES MONTHLY SOFTWARE for APPLE II+ / IIe

BUSINESS

Applied Soft Tech., VersaForm \$ 389 \$259
Artsci, MagicWindow II NEW \$ 150 \$ 99
* Magic Combo (Wind, Mail & Words) \$ 225 \$149
* Ashton-Tate, dBase II (Req CP/M 80) \$ 700 \$385
Financial Planner (Req CP/M 80) \$ 700 \$395
Friday (Requires CP/M 80) \$ 295 \$199
BPI Systems, GL, AR, AP, PR or INV, each \$ 395 \$295
Broderbund, Bank Street Writer \$ 70 \$ 47
Continental, GL, AR, AP or PR ea \$ 250 \$165
Home Accountant \$ 75 \$ 49
FCM \$ 100 \$ 69
Dow Jones, Market Analyzer \$ 350 \$275
Market Manager \$ 300 \$235
Market Microscope \$ 700 \$525
Fox & Geller, QuicKcode (for dBase II) \$ 295 \$185
dGraph (for dBase II) \$ 295 \$185
dUtility (for dBase II) \$ 99 \$ 66
Hayden, Pie Writer (Specty 80 col. board) \$ 150 \$ 99
Howard Soft, Real Estate Analyzer II \$ 195 \$129
Tax Preparer \$ 225 \$149
LJK, Letter Perfect w/ Mail Merge \$ 150 \$ 99
Micro Craft, (requires Z80 CP/M-Card) \$ 995 \$469
Verdict or Billkeeper \$ 180 \$119
Micro Pro, (all req Z80-CP/M Card) \$ 495 \$325
* WordStar w/ AppliCard & CP/M SPECIAL \$ 495 \$239
WordStar + Training Manual SPECIAL \$ 250 \$129
MailMerge™ SPECIAL \$ 250 \$129
SpellStar SPECIAL \$ 250 \$129
* WordStar Professional 4 Pak SPECIAL \$ 895 \$429
Microsoft, Multi-Plan (CP/M or Apple DOS) \$ 275 \$175
Financial Multitool (CP/M or DOS) \$ 100 \$ 75
Budget Multitool (CP/M or DOS) \$ 150 \$115
* Osborne, C.P. Soft, (Disk and Book) (Stat, Bus, & Math) \$ 100 \$ 49
Some Common Basic Programs (75 each) \$ 100 \$ 49
Practical Basic Programs (40 each) \$ 100 \$ 49
Peachtree, Requires CP/M & MBasic, 40 columns. Series 40 GL & AR & AP, all 3 \$ 595 \$365
Series 9 Text & Spell & Mail, all 3 \$ 595 \$395
Perfect, Perfect Writer \$ 495 \$149
Perfect Speller \$ 295 \$ 99
Perfect Writer/Speller 2 Pak \$ 695 \$199
Perfect File \$ 595 \$259
Quark, Word Juggler (IIe) \$ 239 \$179
Leachlock (IIe) (use w/ Juggler) \$ 149 \$ 99
Sensible, Sens. Speller, Speller 80 Col. Bnd. \$ 125 \$ 85
Sierra-On-Line, ScreenWriter Professional \$ 200 \$135
ScreenWriter II \$ 130 \$ 89
The Dictionary NEW \$ 100 \$ 69
General Manager II NEW \$ 230 \$155
* Silicon Valley, Word Handler \$ 250 \$ 39
List Handler \$ 90 \$ 35
Software Publishing, PFS: File (specify + or e) PFS: Report \$ 125 \$ 84
PFS: Graph \$ 125 \$ 84
Stoneware, DB Master Version 4.0 \$ 350 \$ 229
DB Utility for II \$ 99 \$ 69

BUSINESS

System Plus, GL, A.P. & A.R. 3 Pak \$ 995 \$ 555
Videz, Appliwriter II preboot disk \$ 20 \$ 15
Visacalc 80 col. preboot disk \$ 50 \$ 30
* VisiCorp Personal Software. Visicalc 3.3 \$ 250 \$ 169
Visicalc Enhanced (IIe) NEW \$ 250 \$ 179
VisiFile or VisiDex, each \$ 250 \$ 179

UTILITY & SYSTEM

Beagle, Apple Mechanic \$ 30 \$ 22
Double-Take \$ 35 \$ 25
Typesettes (Req. Ap. Mechanic) \$ 20 \$ 15
DOCS Boss or Utility City, each \$ 30 \$ 22
Tip Disk #1 \$ 20 \$ 15
Printo DOSS \$ 30 \$ 20
Alpha Plot \$ 40 \$ 27
Central Plot, Flier, DOS 3.3 and Utility \$ 20 \$ 15
Copy II Plus (bit copier) \$ 40 \$ 30
* Einstein, Compiler, for AppiSoft BASIC \$ 129 \$ 85
Epson, Graphics Dump \$ 15 \$ 9
Hayes, Terminal Program \$ 100 \$ 65
* Insoft, GrafFORTH by Paul Lutus \$ 75 \$ 59
Microsoft, A.L.D.S. \$ 125 \$ 75
Cobol 80 \$ 750 \$ 559
Fortran 80 \$ 195 \$ 149
COMPLETE LINE IN STOCK
* Omega, Locksmith (bit copier) \$ 100 \$ 75
Penguin, Comp. Graphs, Sys. NEW \$ 70 \$ 53
Graphics Magician NEW \$ 60 \$ 41
Phoenix, Zoom Graph \$ 40 \$ 34
Quality, Bag of Tricks NEW \$ 40 \$ 29

HOME & EDUCATIONAL

Beagle Bros., Beagle Bag \$ 30 \$ 22
Broderbund, Chipster \$ 35 \$ 26
Arcade Machine \$ 60 \$ 40
Lode Runner \$ 35 \$ 25
Apple Panic \$ 30 \$ 21
BudgeCo, Pinball Constr. Set \$ 40 \$ 27
* Continental, Home Accountant Database, Aztec or Zaxxon, each \$ 75 \$ 49
Edu-Ware, (Large Inventory) Call Call
Einstein, Memory Trainer \$ 90 \$ 70
Hayden, Sargon II (Chess) \$ 35 \$ 29
Infocom, Zork I, II, or III, or Starcross, each \$ 40 \$ 27
Koala, Full line in stock, CALL Call
Learning Co., (Large Inventory) Call Call
Lightning, Masterkey \$ 40 \$ 27
Micro Labs, Minis 2049er \$ 40 \$ 27
Sierra-On-Line, Ultima II \$ 60 \$ 40
Spin-Tech, Wizardry \$ 50 \$ 39
Sprockler, Kindercomp \$ 30 \$ 20
Sub Logic, Flight Simulation or Pinball, ea. \$ 35 \$ 25
Terraplan, Logo \$ 150 \$ 99

OTHER BRANDS AND PROGRAMS IN STOCK. CALL.

8" CP/M-80 SOFTWARE

MUCH MORE IN STOCK LIST OUR PRICE PRICE
ASHTON-TATE, dBase II \$ 700 \$ 385
Financial Planning Lang. \$ 700 \$ 439
Friday \$ 295 \$ 249
BLUE CHIP, Millionaire \$ 70 \$ 43
DIGITAL RES., CBASIC \$ 150 \$ 99
CBASIC Compiler (CB80) \$ 500 \$ 339
Pascal MT \$ 350 \$ 239
CIS COBOL \$ 850 \$ 575
PL I \$ 550 \$ 375
C Compiler \$ 350 \$ 250
FOX & GELLER, QuicK Code \$ 295 \$ 185
dUtil \$ 99 \$ 62
dGraph \$ 295 \$ 185
INFOCOM, Starcross, Zork I, II or III, each \$ 50 \$ 34
Deadline or Planefair, each \$ 60 \$ 40
MICROCRRAFT, Verdict or Billkeeper, each \$ 995 \$ 495
MICROPRO, WordStar \$ 495 \$ 239
MailMerge™ \$ 250 \$ 129
WordStar Prof., 4 Pak \$ 895 \$ 429
MICROSOFT, Multiplan \$ 275 \$ 195
COBOL-80 Compiler SPECIAL \$ 750 \$ 350

PLOTTERS

BAUSCH & LOMB, HOUSTON DMP-40, 1 ptn \$ 725 \$1895
DMP-29, 8 ptn \$ 895 \$2250
DMP-41 \$ 749 \$ 599
Amplot II, 10" x 14", Para \$1299 \$ 999
HP12C \$ 120 \$ 99
HP11C \$ 90 \$ 75
41C Calculator \$ 195 \$ 149
41CV Calculator w/ 2.2K Mem. \$ 275 \$ 219
Call on accessories and software.

for the ATARI RANA 1000 Drive, 320K \$ 449 \$ 369
KOALA, Graphics Pad \$ 100 \$ 75

DISKETTES

BROWN DISC LIST OUR PRICE PRICE
10 each, Pulse I, DS DD, 48TPI \$ 45 \$ 32
10 each, Pulse II, DS DD, 96TPI \$ 60 \$ 45
CDC 100 each, SS, SD, 35T (Apple, Atari) \$ 450 \$ 169
10 each, SS, SD, 35T (Apple, Atari) \$ 45 \$ 18
100 each, SS, DD, 48T (Apple, IBM) \$ 550 \$ 179
10 each, SS, DD, 48T (Apple, IBM) \$ 55 \$ 19
100 each, DS, DD, 48T, (IBM, H.P.) \$ 750 \$ 295
10 each, DS, DD, 48T (IBM, H.P.) \$ 75 \$ 35
DYSAN, 10 each, SS, SD (Apple, etc.) \$ 69 \$ 39
10 each, DS, DD 48T (IBM, H.P., etc.) \$ 89 \$ 49
MAXELL, 10 each, MD-1, SS, DD \$ 55 \$ 29
10 each, MD2-D, DS, DD \$ 75 \$ 39
MEMOREX 10 each, SS, DD, Type A (Apple, Atari) \$ 45 \$ 23
10 each, DS, DD, Type B (IBM, H.P.) \$ 60 \$ 35
100 each, SS, SD, 35 Track (Apple, Atari) \$ 415 \$ 185
VERBATIM, 10 each, MD25-01, SS, SD \$ 49 \$ 25
10 each, MD34, DS, DD \$ 84 \$ 45
GENERIK™ DISKETTES - AS LOW AS \$1 100 each SS, SD, 35 Track (Apple, Atari) \$ 415 \$ 185
100 each SS, SD, 35 Track (Apple, Atari) \$ 415 \$ 185
100 each DS, DD, 40 Track (IBM, H.P.) \$ 625 \$ 170
1000 each DS, DD, 40 Track (IBM, H.P.) \$6250 \$1400
W/ jackets, no labels, top quality 90 day limited warranty by us.

GENERIK™ DISKETTES

SS SD \$1.00 Each
DS DD \$1.40 Each
CDC SS SD \$1.69 Each
Minimum order quantities apply. See above money back guarantee in by COMX Corporation not us.

© 1983 by COMX Corporation

MODEMS AND ACCESSORIES

ANCHOR, Signalram MK I Modem (RS232) \$ 99 \$ 75
Mark XII \$ 399 \$ 269
HAYES, IBM-PC Smartmodem 1200 B \$ 599 \$ 439
IBM-PC Smartcom II Software \$ 119 \$ 89
Stack Chronograph (RS-232) \$ 249 \$ 189
Stack Smartmodem 300 (RS-232) \$ 299 \$ 225
Smartmodem 1200 (RS-232) \$ 699 \$ 535
Micromodem 100 (S-100 bus) \$ 389 \$ 275
Microdemon II (for the Apple II) \$ 379 \$ 275
Apple Terminal Program \$ 100 \$ 65
IBM-PC to Modem Cable \$ 39 \$ 29
NOVATION, All below req RS-232
Appletalk II Modem, 300 BAUD \$ 389 \$ 269
212 Apple Cat, 1200 BAUD \$ 725 \$ 559
PC-Cat with Crossstalk \$ 595 \$ 419
Cat \$ 189 \$ 139
D-Cat \$ 199 \$ 159
J-Cat \$ 149 \$ 104
212 Auto Cat \$ 695 \$ 579
Smart Cat 103/212 \$ 595 \$ 415
SSM, Transcend I for Apple II Data Comm. \$ 89 \$ 69
ModemCard for the Apple II \$ 299 \$ 259
Transcend 1200 (110/300/1200) \$ 695 \$ 559

SOFTWARE, SEE APPLE OR IBM UTILITY SOFTWARE SECTIONS

MONITORS AND ACCESSORIES

* AMDEK, 12" Green, #300G \$ 200 \$ 135
* 12" Amber, #300A \$ 210 \$ 148
* 12" Amber, #310A for IBM-PC \$ 230 \$ 159
* 13" Color II, Composite \$ 379 \$ 289
* 13" Color II, RGB, Hi Res \$ 529 \$ 439
DMV, Color II or III to Apple III/F \$ 199 \$ 175
NEC, 12" Green, Model JB2011A \$ 249 \$ 159
12" Color, Composite, JC1215M \$ 400 \$ 299
12" Color, RGB, IBM Model JC 1203 \$ 699 \$ 569
* PRINCETON, RGB Hi Res, HX-12 \$ 795 \$ 499
QUADRAM, Quadchrome 12" RGB Color \$ 795 \$ 499
Quadscreen 17", 968 x 512 \$1995 \$1595
SANYO, 12" Green, Model DMB112CX \$ 260 \$ 199
ZENITH, 12" Green, Model ZVM123 NEW! \$ 200 \$ 115

PRINTERS AND ACCESSORIES

DOT MATRIX PRINTERS: LIST OUR PRICE PRICE
EPSON MX80F.T, 80 CPS, w/GratTrax + \$ 745 \$ 455
FX80, CPS Call
MX100F.T, 80 CPS, w/GratTrax + \$ 995 \$ 629
FX100, CPS Call
Apple II Graphics Dump Program \$ 15 \$ 0
LEADING EDGE, Gonila Banana \$ 250 \$ 202
OKIDATA, 82A, 80 col., 120 cps, Para. \$ 549 \$ 420
83A, 132 col., 120 cps, Para. \$ 899 \$ 605
92, 160 CPS, 80 Col., Para. \$ 699 \$ 502
90, 160 CPS, 136 Col., Para. \$1249 \$ 969
2350P, Pacemaker, 350 cps, Para. \$2995 \$2300
2410P, Pacemaker, 350 cps, Para. \$2995 \$2300
ORANGE MICRO, Grappier™, for Apple \$ 165 \$ 119
PRACTICAL, Microbuffer In-Line 94K, Para. \$ 349 \$ 239
Microbuffer In-Line 94K, Serial \$ 349 \$ 239
* STAR MICROS, Gemini 10" X 12cps, 2.3K \$ 499 \$ 260
Gemini 15" X, 120cps, 2.3K Call Call
IBM-PC to Epson or Star Micronics Cable \$ 60 \$ 35
Apple IIe and Cable for Epson or Gemini \$ 95 \$ 62
LETTER QUALITY - DAISY WHEEL PRINTERS: JUKI 6100, 17cps, 80 Col., Parallel \$ 700 \$ 570
EXP550S, 18 cps, 3 pitch \$ 895 \$ 615
EXP550S, 18 cps, 3 pitch \$ 995 \$ 659
Tractor Feed for EXP 550 \$ 160 \$ 121
* TTX, 13 cps, Para. & Ser. Pn. Ribbon \$ 649 \$ 450
SUPPLIES: Tractor Feed Paper, Fridens, Daisy Wheels.

CORVUS

5 Meg \$2095 \$1695
11 Meg \$2750 \$2255
Drives Without Interfaces 20 Meg \$3750 \$3095
IBM-PC Interface Manual, S.W. & Cable Kit \$ 300 \$ 220
IBM-PC Intern Transporter Pack of 4 \$1695 \$1455
Apple Interfaces, Manual, S.W. & Cable Kit \$ 300 \$ 220
Other Interfaces, Omn-Net, Constellation, Mirror, CALL.

* MEANS A BEST BUY AD #986

ORDERING INFORMATION AND TERMS: All Mail: P.O. Box 23086, Portland, OR 97223. Include telephone number. All items usually in stock. Cashiers Checks, Money Orders, Fortune 1000 Checks and Government Checks, we immediately honor. Personal or other Company Checks allow 20 days to clear. No. C.O.D. Prices reflect a 3% cash discount so ADD 3% to above prices for VISA or MC. For U.S. Mainland, add 3% for shipping, insurance and handling (SI&H) by UPS with \$5 minimum for SI&H. UPS ground is standard so add 3% more for UPS Bulk with \$10 minimum for SI&H. Add 12% total for SI&H for US Postal, APO or FPO with \$15 minimum for SI&H. For Hawaii, Alaska and Canada, UPS is in some areas only, all others are Postal so call, w/te, or specify Postal. Foreign orders except Canada for SI&H add 18% or \$25 minimum for SI&H except for imports add 30% or \$50 minimum for SI&H. Prices subject to change and type errors, so call to verify. All goods are new, include warranty and are guaranteed to work. Due to our low prices, ALL SALES ARE FINAL. Call before returning goods for repair or replacement. Orders received with insufficient SI&H charges will be refunded. ORDER DESK HOURS: 9 A.M. to 6 P.M. PST, Monday through Friday and 10 A.M. to 4 P.M. EST, 6 A.M. here on 9 A.M. in New York.
OUR REFERENCES: We have been in computers and electronics since 1958, a computer dealer since 1978 and in computer mail order since 1980. Banks: 1st Interstate Bank, (503) 643-4678. We belong to the Chamber of Commerce (503) 644-0123, Better Business Bureau and Direct Marketing Association, or call Dun and Bradstreet if you are a subscriber. Fasttrak™ and Generik™ are trademarks of ComX Corporation. WordStar, MailMerge, StarIndex, InfoStar, are trademarks of MicroPro.

CASH & CARRY OUTLETS: Over-the-counter sales only. Open Monday through Saturday 10:30 until 5:00.
PORTLAND, OREGON, 11507-D S.W. Pacific Hwy. Terrace Shopping Center, Tigard. On 99W between 217 and I-5. Call 245-1020.
SEATTLE, WASH., 3540 128th Ave. SE, Bellevue, WA 98006. Tele: 641-4736, in Leehammer's Plaza near Factoria Square. SE of Hwy. 405 & 90 and to SE-38th & Richards.

Professionals™

DEALERS
WE BUY
EXCESS
INVENTORIES

Circle 73 for IBM Peripherals. Circle 74 for Apple. Circle 75 for all others.

LOW PRICES TO PROFESSIONALS WHO KNOW WHAT THEY WANT AND KNOW HOW TO USE IT!

THE IBM-PC SUPPLY CENTER



IBM is a trademark of IBM Corporation.

256K
IBM-PC

System Includes
Two 320K Disk Drives by CDC
90 Day Warranty By Us
Call For Details And
Configurations

	LIST PRICE	OUR PRICE
MEMORY CHIP KITS Add-on to your memory cards or mother board. 100% tested. With 90 day warranty.		
★ 64K Kit, 200NS, 9 chips, 4164	\$ 150	\$ 45
16K Kit, 200NS, 9 chips, 4116 (for PC-1 motherboard)	\$ 50	\$ 16
AMDEK 4-IN-1 Multiple Board, Color Graphics, Mono, 128K	\$ 599	\$ 519
AST Comboplus, 64K S-P-C	\$ 395	\$ 279
Comboplus, 256K, S-P-C	\$ 695	\$ 475
MegaPlus II, 64K, 2-S-P-C	\$ 495	\$ 345
MegaPlus II, 256K, 2-S-P-C	\$ 795	\$ 495
256K MegaPlus II Expander	\$ 395	\$ 295
SixPakPlus, 64K, S-P-C	\$ 395	\$ 295
SixPakPlus, 256K, S-P-C	\$ 695	\$ 495
SixPakPlus, 384K, S-P-C	\$ 895	\$ 595
IO Plus II, 2S-P-C/G	\$ 315	\$ 195
PCnet™, LAN Kit	\$1490	\$1290

CCS SuperVision, monochrome board Z-Plus 64, fast Z80B, 64K para port	\$ 850	\$ 680
	\$ 875	\$ 695
★ ComX 256K RAM Card with Fastrak™ RAM disk emulator and spooler software.	\$ 695	\$ 256
CURTIS PC Pedestal™ for Display	\$ 80	\$ 65
3 to 9 foot keyboard cable	\$ 50	\$ 35
Vertical CPU "System Stand"	\$ 25	\$ 19
Monochrome Ext. Cable Pair	\$ 40	\$ 30
HERCULES Monochrome Board	\$ 499	\$ 379
Key Tronic KB5150, Std. keyboard	\$ 269	\$ 199
Koala Koala Pad™ Programmer's Guide	\$ 150	\$ 109
	\$ 15	\$ 12
MAYNARD (6) Card, MFC	\$ 89	\$ 79
Modules for above card	Call	
SandStar, no RAM card	\$ 199	\$ 169
SandStar, 256K Card	\$ 499	\$ 395

	LIST PRICE	OUR PRICE
MICROSOFT RAMCard 256K	\$ 550	\$ 385
SystemCard 256K	\$ 395	\$ 275
SystemCard 64K	\$ 625	\$ 435
Mouse	\$ 195	\$ 145
MOUSE SYSTEMS , PC Mouse w/software	\$ 295	\$ 195
ORCHID PCnet™, LOCAL AREA NET Monochrome Graphics Card	\$1490	\$1190
	\$ 499	\$ 379
PLANTRONICS ColorQuad, 16 color brd. w/Para Port	\$ 475	\$ 379
QUADRAM		
★ Quadlink, Apple II Emulator	\$ 680	\$ 485
Quadboard, no RAM, expandable to 256K	\$ 295	\$ 215
Quadboard 64K, expandable to 256K	\$ 395	\$ 279
★ Quadboard 256K, 6 function	\$ 595	\$ 395
Quadboard II, no RAM, expand to 256K	\$ 395	\$ 279
Quadboard II, 64K, expandable to 256K	\$ 395	\$ 279
Quadboard II, 256K, 6 function	\$ 595	\$ 395
Quad 512 + 64K plus serial port	\$ 325	\$ 265
Quad 512 + 256K plus serial port	\$ 550	\$ 420
Quad 512 + 512K plus serial port	\$ 895	\$ 625
Quadcolor I board, 16 colors	\$ 295	\$ 225
Quadcolor II board, use with Quadcolor I	\$ 275	\$ 209
Quadscreen, 12" RGB Monitor	\$ 795	\$ 499
Quadscreen, 17", 968 x 512 Monitor	\$1995	\$1595
Microfazer, w/Copy, P.P. 8K, #MP8 w/P.S.	\$ 189	\$ 129
Microfazer, w/Copy, P.P. 64K, #MP64 w/P.S.	\$ 319	\$ 219
Microfazer, w/Copy, P.P. 128K, #MP128 w/P.S.	\$ 465	\$ 295
Microfazer, Snap-on, 8K, P.P.		
Epson, #ME8, w/P.S.	\$ 179	\$ 145
Microfazer, Snap-on, 64K, P.P.		
Epson, #ME64, w/P.S.	\$ 319	\$ 235
All Microfazers are expandable. (w/copy to 512K) (Snap-on to 64K)		
Tecmar 1st MATE, 64K	\$ 389	\$ 295
1st MATE, 256K	\$ 589	\$ 439
Graphics Master	Call	
TG PRODUCTS Joystick	\$ 65	\$ 49
WICO, IBM-PC Mouse	\$ 100	\$ 69



\$45

64K CHIP-KIT

9 Each \$164, 200 ns. MEMORY EXPANSION
90 Day Warranty by us.

\$256

256K RAM BOARD

Fully Compatible. 2 Year Limited Warranty by ComX.
With Fastrak RAM Disk Emulator and Spooler Software.
Works on DOS 1.1 or 2.0.

★ Means a BEST buy.
AD #986

for the IBM-PC DRIVES AND ACCESSORIES

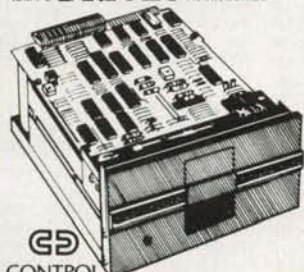

DATA OR Tandon
320K/360K DS DD DISK DRIVES

With Detailed Installation Instructions
60 Day Warranty by Factory Authorized Distributor

Same as now installed by IBM. **\$229** \$239 For One.
\$199
HALF HEIGHT

MAYNARD
Floppy Drive Control Brd. for up to 4 drives \$ 195 \$ 165
same with Parallel Port \$ 275 \$ 205

RANA 2.5 Meg 5" Drive System (Jan) \$1550 \$1195
Call

QUADISK 6 Meg, Removable \$2295 \$1795
CALL ON AVAILABILITY
12 Meg, Fixed \$2250 \$1750
20 Meg, Fixed \$2650 \$2050
27 Meg, Fixed \$2895 \$2295
72 Meg, Fixed \$6500 \$4950

VISTA IBM-PC XT 6MB Backup for Hard Disk, V1200 \$1549 \$1049

SOFTWARE for the IBM-PC or XT

BUSINESS		
	LIST PRICE	OUR PRICE
ASHTON-TATE		
★ dBase II, requires PC-DOS & 128K	\$ 700	\$ 385
dBase II User's Guide	\$ 30	\$ 20
Everyman's DB Primer (Book)	\$ 15	\$ 12
The Financial Planner	\$ 700	\$ 395
Friday	\$ 295	\$ 199
APPLIED SOFT. TECH. Versatorm	\$ 389	\$ 265
★ CONTINENTAL , Home Accountant + FCM Filing, Cataloging, Mailing	\$ 150	\$ 89
Property Management	\$ 225	\$ 89
	\$ 495	\$ 329
DATAMOST Write-On (Word Processor)	\$ 130	\$ 89
DOW JONES , Market Analyzer	\$ 350	\$ 279
Market Manager	\$ 300	\$ 239
Market Microscope	\$ 700	\$ 525
EAGLE SOFTWARE , Money Decisions	\$ 150	\$ 129
★ EINSTEIN , Writer	NEW! \$ 300	\$ 199
Memory Trainer	NEW! \$ 80	\$ 55
Speller	NEW! \$ 150	\$ 95
Mailer	NEW! \$ 80	\$ 55
Letter Scenes	NEW! \$ 300	\$ 195
FOX & GELLER , Quikcode (MSDOS) dGraph (MSDOS)	\$ 295	\$ 179
dLil for IBM PC DOS	\$ 99	\$ 59
HAYDEN , IBM Pie Writer	\$ 200	\$ 135
Pie Speller	\$ 100	\$ 69
HOWARD SOFT , Real Estate Analyzer II	\$ 250	\$ 189
INFOR. UNLIMITED , EasyWriter II (WP)	\$ 350	\$ 259
EasySpeller II	\$ 225	\$ 149
EasyFiler (a DBMS)	\$ 400	\$ 299
Inventory Control	\$ 595	\$ 395
★ INSOFT , Data Design (easy to use DBMS)	\$ 225	\$ 169
Data Base Made Easy (Book)	\$ 17	\$ 12
LIFETIME , Vokewriter	\$ 285	\$ 195
★ LOTUS 1-2-3	\$ 495	\$ 329
MICROCRAFT , Venditor or Billkeeper, each	\$ 995	\$ 469
MICRO LAB Miner 2049	\$ 40	\$ 29
MICROPRO WordStar™	\$ 495	\$ 239
Mail Merge™	\$ 250	\$ 129
SpellStar™	\$ 250	\$ 129
★ WordStar Professional, 4 Pak	\$ 895	\$ 429
StarIndex™	\$ 195	\$ 109
InfoStar™	\$ 495	\$ 259
Report Star™	\$ 350	\$ 199
Datalink™	\$ 295	\$ 195
StarBurst™	\$ 195	\$ 115
★ MICROSOFT , Multiplan	\$ 275	\$ 175
Word	\$ 375	\$ 275
Word with Mouse	\$ 475	\$ 339
Financial Statement	\$ 100	\$ 69
Budget	\$ 150	\$ 109

BUSINESS		
	LIST PRICE	OUR PRICE
MONOGRAM , Dollars & Sense	\$ 185	\$ 110
NORTH AMERICAN BUS , The Answer	\$ 250	\$ 169
★ OSBORNE/COMX , Book & Business, Statistics & Math Programs on (DS-DD Disks)		
Some Common Basic Prog. (70 each)	\$ 100	\$ 69
Practical Basic Programs (40 each)	\$ 100	\$ 69
PBL CORPORATION , Personal Investor	\$ 145	\$ 94
PEACHTREE , Peach Pak 3 (DL, AR & AP)	\$ 595	\$ 239
Peach Test 5000	\$ 395	\$ 239
PEARLSOFT , Personal Pearl (DBMS & MIS)	\$ 295	\$ 195
★ PERFECT , Perfect Writer™	\$ 389	\$ 149
Perfect Speller™ or Perfect Calc™, each	\$ 295	\$ 99
Writer + Speller, 2 Pak	\$ 695	\$ 199
Perfect Filer™	\$ 595	\$ 199
SOFTWARE ARTS , TK1 Solver	\$ 299	\$ 219
SOFTWARE PUBLISHING , PFS:File	\$ 140	\$ 94
PFS:Report	\$ 125	\$ 84
PFS:Write	NEW! \$ 140	\$ 95
PFS:Graph	NEW! \$ 140	\$ 95
SORCIM , SuperCalc II	\$ 295	\$ 195
SuperWriter	\$ 295	\$ 199
SSI/SATELLITE , WordPerfect	\$ 495	\$ 375
Personal WordPerfect	\$ 195	\$ 149
STC/SOFTEC , The Creator	\$ 300	\$ 195
STONEWALL , D.B. Master (a DBMS)	\$ 595	\$ 396
SYNAPSE , File Manager	\$ 100	\$ 67
SYNAPSE , Data Reporter	\$ 250	\$ 169
T/MAKER , T/Maker III	\$ 275	\$ 169
VISICORP , VisiCalc 256K or Visidex, each	\$ 250	\$ 179
VisiFile or VisiSchedule	\$ 300	\$ 219
Desktop Plan I	\$ 300	\$ 219
VisiWord with VisiSpell (128K)	\$ 375	\$ 269

UTILITY & SYSTEM

1983 CL SOFTWARE AWARD:
"Copy II PC by Central Point Software is still the best software buy of 1983 and 1984. It will copy more copy protected software and faster than any other backup system. Unlike other copiers it makes an exact duplicate of your original and it does 100% verification of copy. Documentation is excellent."

★ **CENTRAL POINT**, Copy II PC Backup \$ 40 \$ 35
★ **COMX**, Fastrak™, RAM Disk emulator and printer spooler program. Works on any PC DOS version or RAM Card. Menu Driven. NEW! \$ 100 \$ 59

UTILITY & SYSTEM		
	LIST PRICE	OUR PRICE
DIGITAL RESEARCH		
Concurrent CP M-86™	\$ 350	\$ 225
CBASIC 86™	\$ 200	\$ 135
CP M-86™	\$ 60	\$ 40
Pascal/MT™ (CP M-86)	\$ 400	\$ 159
Pascal/MT™ (MSDOS)	\$ 600	\$ 399
PL11 (MSDOS)	\$ 750	\$ 499
Access Manager (MSDOS)	\$ 400	\$ 179
Display Manager (MSDOS)	\$ 500	\$ 339
SpeedProg. Pkg. (CP M-86)	\$ 200	\$ 135
CIS COBOL-86	\$ 850	\$ 525
DR LOGO-86	\$ 150	\$ 90
CBASIC Compiler (86 or MSDOS, each)	\$ 600	\$ 365
HAYES , Smartcom II (Data Comm.)	\$ 119	\$ 89
MICROCOM , Microterminal (Data Comm.)	\$ 100	\$ 65
MICROSOFT , Crosstalk XVI (Hayes & IBM)	\$ 195	\$ 129
MICROSOFT , multiMail™	\$ 300	\$ 225
Business BASIC Compiler	\$ 350	\$ 255
Pascal Compiler	\$ 350	\$ 255
C Compiler	\$ 350	\$ 225
BASIC Compiler	\$ 395	\$ 285
Fortran Compiler	\$ 350	\$ 255
COBOL Compiler	\$ 750	\$ 559
BASIC Interpreter	\$ 350	\$ 255
NORTON , Norton Utilities, 14 programs	\$ 80	\$ 65

HOME & EDUCATIONAL		
	LIST PRICE	OUR PRICE
EPYX Auto. Sim., Temple of Apshpa	\$ 40	\$ 29
Of Barons	\$ 100	\$ 75
★ ARMONK , Executive Suite	\$ 40	\$ 27
BLUE CHIP , Millionaire or Tycoon, each	\$ 60	\$ 59
BPI SYSTEMS , Business Accounting	\$ 195	\$ 139
★ BRODERBUND , Apple Pane (Color)	\$ 30	\$ 19
COMPREHENSIVE , PC Tutor (DOS 1.1)	\$ 60	\$ 40
CONTINENTAL , Home Accountant -	\$ 150	\$ 89
DATAMOST , Pig Pen or Space Strike, ea	\$ 30	\$ 22
DAVIDSON , The Speed Reader II	\$ 75	\$ 49
INFOCOM , Deadline	\$ 50	\$ 33
Zork for Zork II or Zork III, ea.	\$ 40	\$ 27
★ INSOFT , Word Tru or Quattro, each NEW!	\$ 35	\$ 29
MICRO LAB , Miner 2049	\$ 40	\$ 29
MICROSOFT , Flight Simulator	\$ 50	\$ 33
MONOGRAM , Dollars & Sense	\$ 165	\$ 110
PBL CORP. , Personal Investor	\$ 145	\$ 95
SPINNAKER , Snopser Troops (1 or 2)	\$ 45	\$ 35
Story Machine or Face Maker	\$ 35	\$ 24
STRATEGIC , The Warp Factor	\$ 40	\$ 30
SUBLOGIC , Might Mason Pinball	\$ 40	\$ 27

THE WORLD'S LARGEST COMPUTER MAIL ORDER FIRM
CONROY-LA POINTE™



SHOWROOMS AT: PORTLAND, OR. or SEATTLE, WA. BOTH OPEN M-SAT 10-5
ALL MAIL: P.O. BOX 23068, Portland, Or. 97223

Formerly
Computer Exchange™

NATIONAL ORDER DESK **TOLL FREE (800) 547-1289**
Order Desk Hours: 6AM to 6PM PST
Oregon TOLL FREE (800) 451-5151
Portland: 245-6200
Hot Line For Information On Your Order (503) 245-1030

BHART-NEVADA (800) 845-5555

CALIFORNIA RESIDENTS: NOW YOU CAN CALL US ON INTERSTATE TOLL-FREE LINE

ORDERS ONLY

PC-COMPATIBILITY FOR YOUR ... KAYPRO, OSBORNE, XEROX, ZORBA

8088 Co-Processor board installs in a few minutes. MS-DOS & CP/M-86 incl., reads/writes PC diskettes. RAM doubles as RAM DISC.

128K Board LIST \$749 ONLY \$495
 256K Board LIST \$999 ONLY \$695

PC-COMPATIBLE BOARDS

PASOCOM 64K, 1S+1P, Clock ONLY \$279
 AST Mega-Plus w/RAM Superdrive \$ CALL
 AST PC-NET \$ CALL

SPECIAL BUY: BMC 80/20 by Okidata



This hottest-selling computer in Japan can now be yours at an unbelievably low price!!! Computer with built-in printer, direct-address graphics, optional light-pen; (incl. CP/M, BASIC, WordStar, SpellStar, MailMerge, CalcStar)

Monochrome LIST \$1995 \$1699
 Color LIST \$2995 Only \$2349

MicroDecision II, Hard Disk

LIST \$2795 \$ CALL
 Intertec Superbrain QD \$2145
 Pied Piper Portable \$989

LASER 3000



APPLE compatibility, fully legal. BASIC in ROM, hi-res. color. (560 x 192), 4 channel sound, parallel interface, 40/80 column, 8 function keys, cassette input opt. Floppy run APPLE software. LIST \$699 \$ CALL

16-BIT COMPUTERS COLUMBIA 1600 BEST BUY:

\$3000 plus Free Software
 Nationwide Service by Bell & Howell.

LIST \$3495 \$ CALL
 Columbia 1600-4 10 MB Winchester LIST \$5095 \$ CALL
 MP/M-86 Multi-user operating system \$595
 Columbia VP Portable LIST \$2995 \$ CALL

NOW YOU CAN LEASE A COLUMBIA 1600-1 FOR ONLY \$83/MO!

CORONA-PC: Exceptional high-res. LIST \$2995 \$ CALL
 EAGLE Spirit XL—128K, Hard Disk LIST \$4795 \$ CALL
 ZENITH Z-100 (Hard Disk Optional) \$ CALL
 FREE Lotus 1-2-3 \$ CALL
 SANYO MBC-550 & 555 1st IBM-Compatible under \$1000

NEC-APC: 8086 8" Floppies, Hard Disk Option
 SPECIAL OFFER: CP/M-86 WordStar, SpellStar, MailMerge, SuperCalc, dBASE-II. Millionaire game included FREE.

HO Monochrome LIST \$3448 \$2749
 HO3 Color LIST \$4198 \$3249

TERMINALS

Hazeltine ESPRIT II \$539
 Hazeltine ESPRIT III \$619
 QUME QVT-108 \$729
 WYSE 100 \$ CALL
 WYSE 50 \$ CALL

MONITORS

Dynax 12" Amber \$135
 Taxan RGB-1 \$315
 Taxan RGB-III hi-res. \$514
 Zenith RGB hi-res. \$524
 Princeton PGS hi-res. \$495
 NEC 1203 RGB \$610

NEC PC-8201

Another Immediate hit!
 Weighs only 38 lbs. yet has integral 40 char. x 8 line display, 32K ROM + 16K RAM. Interfaces printers, bar-code reader, cassette & Floppies.
 List \$799 \$629

SHARP PC-5000

Revolutionary Portable Computer
 LIST ... \$1995
 \$ CALL

NEC SPECIAL

NEC PC-8800 SYSTEM: 2 Floppies, monitor, graphics. \$1799

PRINTERS

Mannesman-Talley MT-160L: HOT SELLER! \$559
 MT-180L NEW up to 264 columns \$779
 GEMINI-10X List \$499 ONLY \$ CALL!!!
 GEMINI 15X List \$649 \$ CALL
 Gemini Delta 10, 160 CPS \$ CALL
 Epson FX-80 \$CALL Epson RX-80 \$ CALL
 Okidata 92 \$439

Daisy-Wheel Printers:
 DAISYWRITER 2000, 48K buffer \$1095
 TRANSTAR 130, emulates Diablo \$679
 BROTHER HR-25 \$ CALL
 DYNAX HR-15, best buy LIST \$599 \$449
 DYNAX KEYBOARD \$189
 QUME SPRINT II \$ CALL
 JUKI 6100 low cost/hi perfor LIST \$699 \$489
 Silver-Reed EXP 550 \$ CALL
 Mannesmann-Tally Sprint LIST \$399 \$339

MODEMS

Hayes Smartmodem w/SmartCom \$484
 SmartCom II \$779
 Hayes 1200 B (F/IBM-PC) \$449
 Signalman MK12 Auto Send/Rec. 300/1200 BEST BUY \$299

SPECIAL!

DYMAC ClipStrip. Only UL-Approved Surge Protector. Protect your Investment!
 LIST \$149 ONLY \$109

FLOPPY DISKETTES

First quality, individual envelopes, original factory boxes of 10. 5 1/4 diskettes have reinforced hubs. LIFETIME WARRANTY!

DISKETTE TYPE	NASHUA		SCOTCH 3-M	
	LIST	SPECIAL	LIST	SPECIAL
5 1/4" s.s., s.d.	\$3.55	\$1.49	-----	-----
5 1/4" s.s., d.d.	4.10	1.84	4.20	1.99
5 1/4" d.s., d.d.	4.90	2.15	6.00	2.99
8" s.d., s.d.	4.00	1.84	-----	-----
8" s.s., d.d.	5.25	2.25	5.55	2.79
8" d.s., d.d.	6.50	2.69	7.10	3.49

Minimum Order 5 boxes. Prices above reflect 5% cash discount. Credit cards or purchase orders (approved organizations ONLY) add 5%.

SOFTWARE

Compare our Prices ... Like our Service and Support they are superior beyond comparison.

WORDSTAR PROPAK (W/S SpellStar, MailMerge, Starindex) ... \$479
 FRIDAY \$169
 BOTTOM LINE STRATEGIST \$299
 PFS:FILE \$89
 CONDOR III w/ReportWriter \$299

WORD PROCESSING	LIST	YOUR PRICE	TRAINING	
			ATS - All	75
Benchmark (Metasoft)	499	354	UTILITIES	
Final Word (Unicom)	300	228	Disk Doctor (Supersoft)	100
Footnote (Dig. Mkt.)	125	85	Fancy Font (SoftCraft)	180
PeachPak (Peachtree)	500	330	Menu Master (Borland)	195
Perfect Writer/Speller	695	286	Smak Key	89
Punct. & Style (Oasis)	125	90	Super Sort (MicroPro)	250
Spellbinder (Lexsoft)	495	264	Supervyz (Epic)	90
Superwriter (Sorcim)	295	195		
The Word Plus (Oasis)	150	105	LANGUAGES	
WordStar (MicroPro)	495	259	Basic Compiler (Microsoft)	395
			Basic Interpreter 80	350
			Business Basic Compiler	600
			CBASIC II (D/R)	150
			CBASIC 86 (D/R)	200
			C Compiler (MicroSoft)	500
			COBOL (D/R)	500
			Cobol Compiler (MicroSoft)	750
			Fortran 80 Compiler	500
			Level II Cobol (D/R)	1600
			Macro Assembler	200
			Pascal MT/MT+86	500
			PL/I (D/R)	500
			RM/Cobol full devel. sys	500

SPREAD SHEET/FINANCIAL PLANNING		RECREATIONAL	
MultiPlan (Microsoft)	275	190	infocom for ALL formats (including hard to 600)
Multi-Tool Budget	150	103	Kaypro, Morrow, Xerox, Osborne DD, etc.]
Multi-Tool Financial St.	100	72	Zork
ProfitPlan (Chang Labs)	195	140	Deadline, Starcross,
CalcStar (MicroPro)	145	95	Planetfall, Witness,
SuperCalc II (Sorcim)	295	194	Suspended
VisiCalc (VisiCorp)	250	199	
VisiTrend (VisiCorp)	300	238	DATA COMMUNICATIONS
SuperCalc III		\$CALL	Crosstalk (Microstuff)
			Move-It (Woolf)
			Smartcom II (Hayes)
			FOR RECOMMENDATIONS ON APPLICATIONS:
			SOFTWARE (Cyma, MBA, Star, Peachtree,
			Artificial Intelligence, etc.)
			Complete selection at comparable savings.
			\$ CALL

TELEX ORDERS: Hardware under \$1,000 and all Software (Please Telex re larger hardware items only if you are eligible for U.S. Export License). TELEX 472-0127 Attn: EMD

Bank Reference: 1st Interstate Bank, Sunset Eastern Branch, Las Vegas, NV 89114

BHART-NEVADA

Mon. Fri. 7:00 AM - 5:30 PM PST
 (800) 845-5555
 INFORMATION LINE: (702) 451-3305
 ORDER STATUS: (702) 451-1361
 P.O. BOX 50029, HENDERSON, NV 89016



TERMS: Prices in this ad apply to prepaid orders only, reflect 5% cash discount off our regular price. Fortune 1000 companies, Universities and Government only. 30-day net based on our regular (non-cash) price. This ad supersedes all prior offers. Prices subject to change. Absolutely no return on used or damaged items. Software returnable ONLY in UNOPENED original wrapping. 15 DAY EXCHANGE PRIVILEGE, subject to 15% restocking. Add 3% for Handling, Shipping & Insurance (\$3.95 minimum). Nevada residents add 5.75% tax. Circle 43 on Inquiry card. APPLE is trademark of Apple Computer Inc. IBM is trademark of International Business Machines. Ltd.

NEW! NATIONAL LEASING! • NEW! NATIONAL LEASING! • NEW! NATIONAL LEASING! • NEW! NATIONAL LEASING! • NEW! NATIONAL LEASING!

Speech Recognition: An Idea Whose Time Is Coming

Some theoretical and practical aspects of this emerging technology

by **George M. White**

Someday machines that recognize speech will be commonplace. People will talk to computers, typewriters, toys, TV sets, household appliances, automobile controls, door locks, and wristwatches. Each of these speech-recognition applications is currently being explored; some early forms are already on the market, while other forms are proving to be beyond our current capabilities. In this article, I'll examine some of the theory and market prospects for this exciting and elusive technology.

Having our lives filled with machines that obey verbal commands can transform our views of machines. Mechanical devices can take on a subtle lifelike quality when given the ability to respond to speech. This lifelike quality is further amplified when coupled with the machine intelligence that emanates from personal computers, arcade games, robotics, and household automation systems. We continue to be fascinated by the evolution of such intelligent products, and we probably could not reverse this trend, even as visionaries warn that we'll lose our freedom to new mechanical life forms.

Automatic speech recognition is generally considered to be the most difficult and complex problem in the

field of voice processing. Voice synthesis, compression, analysis, encryption, and transmission are all more narrowly defined, and all contribute to the solution of the speech-recognition problem. Some of the world's largest companies (AT&T, IBM, Exxon), the U.S. Department of Defense, and several universities have been developing speech-recognition technology for years without the hoped-for degree of success. But despite difficulties, steady progress is being made.

In the past 10 years, at least a dozen start-up companies have been founded explicitly to develop and market speech-recognition products. Although several have gone out of business, about a dozen companies plan to be in the market with new products in 1984.

Philosophical Issues

The specter of Big Brother may not be of concern in Western society today, but the evolution of distributed intelligence among machines with speech-recognition capability certainly provides the technical base for monitoring our activities. In fact, the U.S. National Security Agency has developed what may be the world's most advanced speech-recognition

algorithms. This system spots keywords in intercepted verbal transmissions from "unfriendly" nations. Currently, it is not likely that such techniques would be used for domestic surveillance. But speech technologists as well as the public must be aware of the potential loss of privacy.

Speech recognition is not a typical engineering problem. It is a scientific Gordian knot. It draws on LSI (large-scale integration) and VLSI (very large-scale integration) chip design, signal processing, acoustic-phonetics, natural-language theory, linguistics, mathematics of stochastic (probability) processes, and computer science techniques. Because of its multidisciplinary nature and because many competent minds have pondered the problem for years, we should not expect a breakthrough in speech-recognition capability. Progress will be made, but it will be evolutionary, not revolutionary. Naive enthusiasm from novices in the field sometimes leads to proclamations that dramatic progress is imminent. Such views fail to consider the interdependence of disciplines required to produce a commercially viable product.

Nearly 15 years ago, a number of

companies and engineering organizations predicted near-term success in speech recognition. This prompted a prominent scientific leader, John Pierce, to say that automatic speech recognition was the domain of "untrustworthy engineers" (see reference 8) and that we would not have speech recognition until we had true artificial intelligence (AI).

Pierce based his critique on the observation that normal speech contains many words that are acoustically ambiguous, and it is only through contextual information and knowledge of linguistic constraints that we are able to remove the ambiguity. Because only humans have demonstrated sufficient understanding of the language constructs of spoken sentences to use them in a way that is unambiguous, Pierce's conclusion that fluent speech recognition requires human-like intelligence is understandable.

Today we do have elemental speech-recognition systems that recognize short utterances. However, this does not nullify Pierce's argument; it is a matter of the type of speech to be recognized. When fluent conversational speech is involved, a "model of the domain of discourse" must be employed, and the recognition process is called "understanding." This is, by definition, in the domain of AI. Recognition of short utterances using only template pattern-matching techniques is, in current vernacular, "pattern recognition," not "understanding."

In a broader sense, even the simplest forms of speech recognition are a part of AI, and AI is spread out in the technologies that make up modern society. The maturation of speech recognition and AI has not been by intellectual tour de force but by a broad-based industrial/technical evolution. Key events in this evolution include the appearance of the mass market for home computers, VLSI, mass-production techniques, and, perhaps, even Pac-Man. Although these are not usually thought of in the same context as machine intelligence and speech recognition, they play a significant role in the

development of such capabilities, and they cannot be ignored by forecasters and planners who hope to tell us what products will materialize in the next few years.

Success is slowly materializing. Today we have adequate machine intelligence to achieve elemental automatic speech recognition (ASR), but we are a long way from conversational speech understanding.

Definition of Terms

Automatic speech recognition means different things in different contexts. Speech-recognition products have been on the market for nearly 15 years for isolated utterances. "Isolated utterances" refers to words or short phrases spoken with pauses between them. "Continuous speech" refers to normal speech without pauses between in-

Automatic speech recognition is the most difficult step in the voice-processing field.

dividual words. ASR systems differ vastly in technical content, depending on the type of speech input expected.

For isolated-utterance input, a variety of signal-processing algorithms and classification schemes have been applied with success. In general, the more care and control exercised on speech input, the greater the number of algorithms that work, because there is greater redundancy in the acoustic input. To reduce costs, some speech-recognition device manufacturers specify that speech input is expected to be carefully enunciated, isolated utterances, in a noise-free environment, from a limited vocabulary, and from a "known" talker. A known talker is one whose voice characteristics have been previously analyzed and recorded. Of the many techniques employed, few have achieved a useful trade-off in cost versus resilience to imperfect speech input.

The technology required for transcription of general conversational

speech far exceeds our current capabilities. Cost-effective, voice-controlled typewriters that accept normal speech will almost certainly not be on the market this decade.

The striking difference in technical content in speech-recognition systems has to do with contextual properties of speech that at first seem paradoxical. For example, typically 20 to 30 percent of the words from tape-recorded conversations cannot be understood when the words are played back individually in random order even though every word was perfectly understood in the original conversation (see reference 9). Thus, a word pronounced in conversation does not really carry the information we normally think it does. The information is spread out over several words rather than being encoded in individual phonemes (a member of the set of smallest units of speech), syllables, or words. The critical information needed to interpret a spoken word is not found in the word itself perhaps 30 percent of the time.

The information required to recognize a word in the context of normal speech floats on the "ether" of an entire phrase or sentence. Until we have intelligent machines that successfully extract semantic, syntactic, prosodic (stress), and perhaps pragmatic information from acoustic waveforms, we will not have conversational speech recognition by machines. It is safe to assume that this will not occur for several more decades. But there are other forms of speech that are easier for machines to recognize.

Carefully pronounced isolated-word utterances contain all the information needed for a machine to correctly recognize them without resorting to AI techniques. The technical barriers are more computational than theoretical, and, in fact, the more carefully pronounced the word, the less the computational power required. For a careful, cooperative talker in a low-noise environment, the computational power of the microprocessors in many personal computers is sufficient. But more computational power is required for multiple talkers, telephone input, larger vocabularies, word spotting, or

connected speech recognition.

For example, speaker-independent recognition over telephone lines is difficult because telephones distort speech spectra in a variety of ways. The voices of unknown talkers will probably have a variety of different spectral shapes for the same speech sound. Techniques for solving these technical problems are known, but they are expensive: Verbex, a subsidiary of Exxon, has offered commercial equipment containing special-purpose, high-speed computers that sell for more than \$65,000 to recognize digits and a few command words over dial-up telephones for arbitrary talkers.

The Cost Barrier

Widespread use of Verbex-type speech-recognition systems awaits dramatic cost reductions. In fact, the single greatest problem facing the entire field is the high cost of robust recognition capability.

Significant cost reductions can be achieved in at least four ways: through large-volume manufacturing

(economies of scale), faster computers, advances in LSI and custom LSI, and algorithm enhancements. Activities of many leading firms can be characterized by their relative emphasis on these approaches. These firms will be covered in more detail later.

Only low-cost systems can currently reap the benefits of large-volume manufacturing; they can exploit the installed base of telephones, personal computers, and toys. Milton Bradley has pioneered a computer peripheral compatible with the TI-99/4A home computer that allows you to play games using oral commands. Interstate Electronics has developed a single-chip recognizer that could become widely used in a mass-produced vehicle, e.g., a toy. Verbex has developed a bit-slice machine architecture to carry out signal processing and pattern matching in its speech systems. Nippon Electric, Interstate Electronics, Threshold Technology, and Votan have developed special LSI chips for speech recognition. Several others, including Intel,

Harris, American Micro Systems, and General Instruments, have developed general voice-processing chips. Every firm in ASR has emphasis on algorithms, but Dragon Systems of West Newton, Massachusetts, stands out for extraordinary achievement and focus on algorithms.

Algorithms Cut Costs

Algorithm improvements aimed specifically at cost reduction typically involve search strategies to reduce the number of paths that must be searched in decision networks. This results in an apparent increase in the execution speed of the computer. Execution-speed enhancements may be obtained not only by efficient search strategies but also by "precomputing" relationship networks that might otherwise require random, or "exhaustive," search techniques.

Dragon Systems has made progress in reducing computation through algorithm improvements. Dragon's speech-recognition system executes on an Apple computer and

From Computer Plus to YOU...

PLUS after PLUS after PLUS



Model 100 BK 1679
Model 100 24K 1835



Color Computer II 16K 5185
w/16K Ext. Basic 5245



Model IV 16K 1849
Model IV 64K
2 Disk & RS232 51699



DMP120 1395
DMP200 1520



CoCo Drive D 1329
CoCo Drive I 1235



DWP210 1629

BIG SAVINGS ON A FULL COMPLEMENT OF RADIO SHACK COMPUTER PRODUCTS

COMPUTERS		PRINTERS		DISK DRIVES	
Color Computer		Silver Reed EXP500 D.W.	425	Model III-4 Drive 2	289
64K ext. basic	5305	Silver Reed EXP550 D.W.	645	Model III-4 Drive 3	259
Model 4 Portable		Daisy Wheel II	1745	Primary Hard Disk M12	2689
64K 2 Drives	1525	DWP4110	1159	Primary Hard Disk M18	1799
Pocket Computer 2	165	DWP210	629	ETC.	
Pocket Computer 3	89	CGP115	159	CCR-81 Recorder	52
Pocket Computer 4	59	CGP220 Ink Jet	545	Cassette Tapes (10 Pk)	9.95
Model 12 64K 1 Drive	2699	DMP100	315	16K Ram Chips	25
Model 12 64K 2 Drive	3375	DMP420	735	64K Ram Chips	75
Model 168 1Dr. 256K	4249	DMP500	1219	Model 4 64K Upgrade Kit	140
Model 168 2Dr. 256K	4915	DMP2100	1589	M100 Bar Code Reader	89
MODEMS		Germini 10X	315	Printer Buffer	135
Hayes Smartmodem II	235	Delta-10	515	Printer Stand	25
Hayes Smartmodem 1200	565	Germini 15X	399	Printer Cables	
Novation Smartcat 1200	459	Prowriter	375	Printer Ribbons	
Novation J-Cat	125	Prowriter II	649	Printer Paper	
R.S. AC-3	129	Okidata	CALL	Dual Covers	
R.S. Modem I	89	Epson	CALL	Computer Books	
R.S. Modem II	160	DISK DRIVES		R.S. software 10% off list	
		Model III-4 Drive 0	515	Send for complete listing	
		Model III-4 Drive 1	195	of brand name software.	

CALL TOLL FREE
1-800-343-8124

- LOWEST POSSIBLE PRICES
- BEST POSSIBLE WARRANTY
- KNOWLEDGEABLE SALES STAFF
- TIMELY DELIVERY
- SHIPPING CONVENIENCE

computer plus
P.O. Box 1094
480 King Street
Littleton, MA 01460
SINCE 1973
IN MASSACHUSETTS CALL (617) 486-3193

COMING SOON TO A DEALER NEAR YOU!

CONTROL/NET

(A TRUE STORY)



"A BRILLIANT DEBUT PERFORMANCE"

STARRING—The Control/Net as itself (1 to 10 users, 12.7 MB hard disk (20 & 40 MB OPT.) TurboDOS™ driven, S-100 bus)

CO-STARRING—Select Wordprocessing™, SuperCalc™ & Tabsoft™ 7 module accounting package.

SPECIAL GUEST ... YOU (the Businessperson) in one week of training near Orlando, Florida (home of Walt Disney World & EPCOT center)

All of this for only \$58. per week!

SUPPORTING ROLE played by General Electric's Nationwide optional service contract.



707 NICOLET AVE., WINTER PARK, FLORIDA 32789 (305) 628-3850

TurboDOS is a trademark of Software 2000. SuperCalc is a trademark of Sorcim, Inc. Select is a trademark of Select Information

achieves recognition accuracies comparable to those executing on \$15,000 machines without Dragon algorithms. The Dragon system basically consists of an 8-bit A/D (analog-to-digital) converter board and software.

How Speech Recognizers Work

Automatic speech recognizers are composed of sound *analyzers* followed by word *classifiers*. Sound analyzers may be nothing more than microphones followed by A/D converters (as in the Dragon system). More likely, the sound analyzer also performs bandpass filtering before A/D conversion. Most successful recognizers use bandpass filtering as the first step in analyzing an utterance. The most elementary and widely used approach to utterance classification is to form a two-dimensional matrix of the utterance with time along one axis and frequency energy content along the other. Reference matrices, which are generated for each word during talker training, are compared to the matrix of unknown utterances. The comparison is typically achieved by computing the distance (e.g., the sum of the square of the differences) between corresponding matrix elements in reference and unknown matrices for all elements in the matrices.

Dynamic Programming

There is an alternative to the matrix-comparison technique of classifying utterances known as "dynamic programming." Dynamic programming has been known to be superior for about 10 years. But consumer-oriented commercial systems avoid dynamic programming partially because of the large associated computational requirements and partially from lack of understanding of the algorithm.

Dynamic programming offers not only superior isolated-utterance recognition, but it also opens up the possibility of continuous-speech recognition. It has been more successful in continuous-speech recognition than any other algorithm, and it is used in the world's only commercial continuous-speech recogni-

tion systems.

The dynamic programming process computes many more combinations of time alignments between reference and unknown utterances than the static-matrix match just mentioned. In fact, its straightforward application increases the computation burden by a factor of 100. However, efficient search-path pruning algorithms can potentially (on the average) reduce the computational burden to the level required for matrix comparison. Recent cost reductions in commercial continuous-speech systems have cut costs by factors of two to five, and these cost savings are due directly to improved search strategies for dynamic programming.

One of the first steps in classifying an utterance is to convert it to a string of "phone units" (elementary sound units). This can be achieved by sampling the speech at a constant rate, e.g., 100 times a second. Alternatively, the speech is segmented into syllable-sized units by monitoring changes in energy or spectral content.

The problem with these approaches is that the number of time intervals or number of syllable segments usually varies from utterance to utterance. Talkers do not reliably reproduce segment durations or pronounce all the syllables in words. (Even if words were pronounced reliably, speech systems could not reliably segment the speech without simultaneously classifying the segment.) Therefore, the problem of variability in number of segments is inherent, and any successful classification scheme must deal with this variability. Dynamic programming provides an approach to handling this variability.

For example, suppose that the utterance "six" is segmented by a scheme that produces six segments: "ssiixs." Furthermore, suppose the correct reference template is "sxiixss." Dynamic programming determines how to "time-align" the segments of reference and the unknown utterances.

The first step is to measure the speech sound similarity between all segments in the unknown and all



Flip the pages. You see PC modem cards with fewer features advertised for as much as \$599. Up until now that's how much it cost to make a modem capable of transmitting at 1200 characters per second (1200 baud). It does not take a computer to figure out the savings on phone line charges when you communicate four times faster than the 30 character per second modems (300 baud). Now you can have the solution to your communication needs at an affordable price.

SEE HOW THEY WORK

You can imagine how precise the components have to be to convert tones over a phone line into 120 characters every second. Precision equates to cost. With the advent of the market in personal computers the economies of scale drove the costs of manufacture down but did not effect the precision required. The technology used is called "analog filtering" is the process of sending (modulating) and receiving (demodulating) tones with perfect pitch. A lot of adjusting, noise suppression and a little magic is required. Real expensive. Some use lots of chips and filters (known as discrete components). The latest rage is LSI (Large Scale Integration) technology. Which is the same old analog stuff condensed onto fewer chips.

ADVANTAGE #1

Digital Signal processing

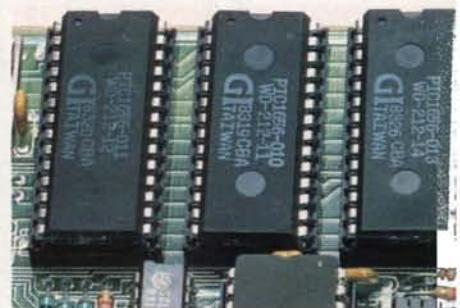

A NEW IDEA

We took a different approach. Through the use of four microprocessors the tones are chopped up digitally and measured millions of times per second, eliminating the need for analog circuitry. Two microprocessors do the modulating, two the demodulating. The chips are programmed to emulate the 103 (30 characters per second) or 212 (120 characters per second) standards and determine the correct speed automatically. It's a proven technology that provides outstanding performance. Best of all, it's inexpensive and reliable.

\$299 212A

**1200 Baud,
Auto-Dial,
Modem for IBM PC**

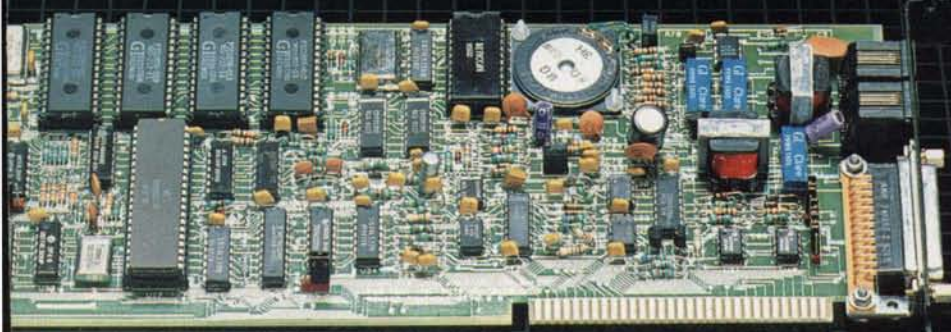

PC 212A/1200:

A GENUINE BREAKTHROUGH

NO CORNERS CUT

We included every feature you would want in a modem card. It's FCC registered for direct connection to your modular phone jack with the cord which is included. There is a separate modular jack for your telephone or you can listen through the onboard speaker. The autodialer works on rotary lines, tone lines, or a combination of both, and will pause for use with Sprint or MCI. It will work in originate or auto-answer modes. A separate microprocessor, a Z8, controls all the functions.

ADVANTAGE #2

Optional external serial port connector

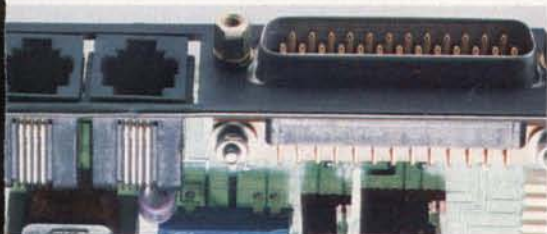

AN ASYNCHRONOUS ADVANTAGE

The modem board is addressed in the software as COM1 or COM2 and we have a handy little option you ought to consider. If you would like to use the asynchronous communications port when your modem is not in use, we will add a connector and the necessary circuitry for just \$20. This saves you the hundred bucks or so you would spend for another async card and saves a valuable slot. It can be configured as COM1 or COM2 and works just like IBM's does.

THIN IS IN

It plugs into your IBM PC or XT and occupies any one slot since it is just 1/2 of an inch thick. This is made possible by using a special speaker which is just 1/8" tall. Competing brands either use a conventional cone type speaker, or they just skip the speaker altogether. Some modems also have large transformers which allow rob valuable space.

ADVANTAGE #3

Just one slot in PC or XT

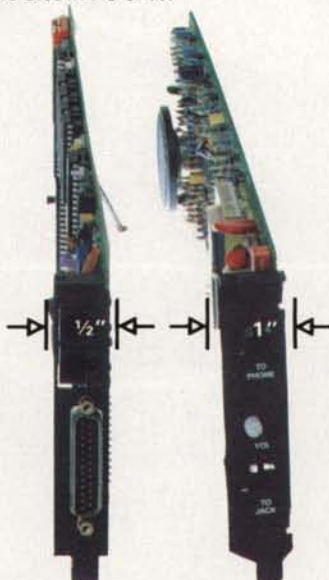

LET'S TALK SOFTWARE

Our modem is 100% compatible with the Hayes software commands so you can use any of the popular communications packages like IBM's Asynchronous Communications Support, CrossTalk, Transend, or PC Modem. We go one better than the competition. We include PC-TALK III. PC WORLD magazine referred to it as "the benchmark that other PC communications packages are measured against." It stores phone numbers, handles setting the modems characteristics, saves to disk files, transmits from disk files, even binary files. You can program up to forty keys to have things like passwords and log-on information be entered when you hit them. And to make sure data is sent and received accurately, the XMODEM protocol detects errors caused by poor line quality and automatically retransmits the data.

WHY BUY FROM US

Because besides having the best product on the market, we stand behind it and you. You get factory direct technical support after the sale. If at any time during the one year warranty period your modem should

require service, we will fix or replace it within 48 hours. Notice also there are no hidden charges in our price. Nothing extra for credit cards or COD charges. We even pay UPS shipping. If you still are not convinced, and are ready to buy another brand of modem, ask them if they will take our acid test.

THE ACID TEST

Qubie' gives you a 30 day satisfaction guarantee on your modem. If you are not completely satisfied we will refund the entire amount of your purchase including the postage to return it. If you can, get anyone selling one of our competitor's products to give you the same guarantee. Buy any modem you like and return the one you don't like. We know which one you will keep.

ORDER TODAY

It's easy to order by mail or by phone.

BY PHONE: Call us and one of our sales staff can answer any questions you have and take your order. Have your Visa or Mastercard number handy when you call.

(805) 987-9741

BY MAIL: We need your name and street address, daytime phone number, how many modems you want, and whether your computer has single or double sided drives.

VISA & MASTERCARD



\$299 includes: PC 212A/1200 auto-dial modem card, PC-TALK III software, cord to connect to modular phone jack, and manual. 1 year limited warranty.

Optional: Connector and circuitry to use serial port for another serial device \$25.

SHIPMENT

We pay UPS surface charges. UPS 2 day air service add \$5 extra. Credit card or bank check orders shipped next day. (Personal checks take 18 days to clear)

QUBIE'

4809 Calle Alto Camarillo, CA 93010

Circle 301 on inquiry card.

Introducing the Freedom 200. No other VDT gives you more, for less.

For only \$745, the Freedom 200 gives you more user-relevant functions and optimized ergonomic features than any other standard VDT.

You get 106 keys, clustered for maximum user efficiency.

Plus 10 user-programmable non-volatile function keys (256 bytes worth) for a host of applications.

Plus 11 cursor control keys, including tab by word for easy editing.

Plus flexible non-volatile set-up modes, full page or status line, to easily configure your terminal exactly the way you want it.

Plus user-definable smooth scrolling regions, with selectable scroll rates.

Plus split-screen capability.

Plus 128 ASCII characters, with 86 extended graphic characters for forms creation.

Plus non-embedded attributes (visual and data entry).

Plus double-high/double-wide characters.

Plus programmable answerback message for enhanced security.

Plus programmable time out, to prolong the life of your screen.

Plus easy serviceability, and space for add-on boards.

Plus two-page standard memory in emulation modes and one-page memory in native mode, with additional memory optional.

Plus 8 foreign character sets.

Plus TeleVideo 950 and Lear Siegler ADM 31 emulation.

Plus more.

To find out more, contact your local Liberty dealer or distributor.

Or call Liberty direct.

(415) 543-7000.

No other VDT gives you more, for less.

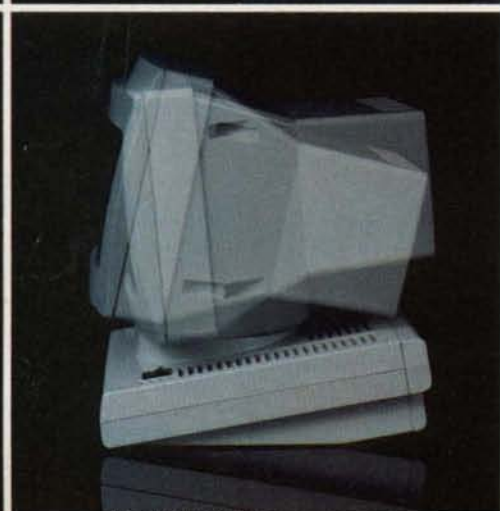
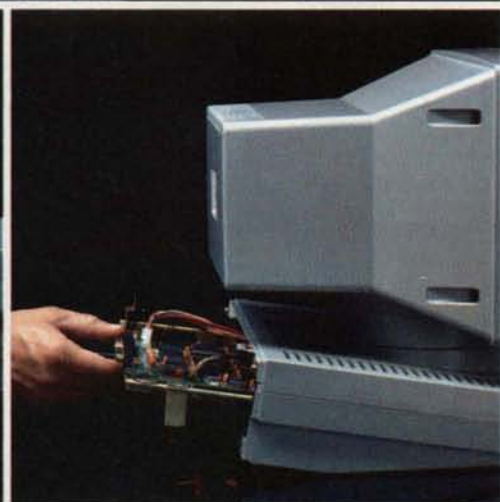

 **LIBERTY**

© Liberty Electronics 1984.

Circle 221 on inquiry card.

7 s	1	1	5	5	6	0
6 s	1	1	5	5	6	0
5 x	4	5	4	4	0	4
4 x	5	6	0	1	5	5
3 i	5	6	0	1	5	5
2 s	1	1	5	6	4	1
1 s	1	1	5	6	4	1

s s i i x s
UNKNOWN
1 2 3 4 5 6

Figure 1: A speech-sound similarity matrix, $Q(i,j)$, containing scores for comparing sounds in reference and unknown utterances.

7 s	17	16	20	20	15	3
6 s	16	16	15	15	9	3
5 x	15	16	10	10	3	7
4 x	11	12	6	6	3	7
3 i	7	8	2	3	8	13
2 s	2	2	7	13	17	17
1 s	1	2	7	13	17	18

s s i i x s
UNKNOWN
1 2 3 4 5 6

Figure 2: A dynamic programming matrix, $S(i,j)$, containing the accumulated scores beginning at $S(1,1)$ and ending at $S(i,j)$. The lines connecting matrix entries show the optimal path linking segments in unknown and reference.



Figure 3: The time alignment of unknown and reference utterances.

segments in the reference utterance. The results are entered into a speech-sound similarity matrix shown in figure 1.

The problem can now be restated as follows: what is the path from the lower left-hand corner to the upper right-hand corner that produces the lowest value? The allowable paths can be constructed from horizontal, vertical, or diagonal moves. The dynamic programming solution is to evaluate $S(7,6)$, where

$$S(i,j) = Q(i,j) + \text{MIN} [S(i-1,j), S(i,j-1), S(i-1,j-1)]$$

Note that to evaluate $S(7,6)$, other values of S must be computed first. So we begin with $S(1,1) = Q(1,1)$; and then $S(1,2) = Q(1,2) + S(1,1)$; $S(1,3) = Q(1,3) + S(1,2)$; etc., until the first row of an $S(i,j)$ matrix is computed. Then we move to the second row,

$S(2,1) = Q(2,1) + S(1,1)$. The previous computations were simple because there was only one way to move from $S(1,1)$. But now, for the first time, $S(i,j)$ location can be reached from more than one precursor, namely $S(2,2)$ can be reached from $S(1,1)$ or $S(2,1)$ or $S(1,2)$. Therefore,

$$S(2,2) = Q(2,2) + \text{MIN} [S(1,1), S(1,2), S(2,1)]$$

In this example, $S(2,2) = 2$. The completed matrix is shown in figure 2. Note that the overall score for the match is 3, $[S(7,6) = 3]$. The optimal time alignment is shown by the lines in figure 2. The lines are put in as a final step, backtracking from $S(7,6)$ to $S(1,1)$.

The time alignment indicated by the lines is illustrated in figure 3.

This same approach can be used in "word spotting." In this application, the beginnings and endings of words are unknown. The matrices $Q(i,j)$ and $S(i,j)$ become longer, as long as an entire sentence. The top row of the matrix $S(i,j)$ is monitored for a dip in scores. If a dip occurs, the word has been "spotted," or identified. Note that in figure 2 the scores along the top row are high until the last two entries $[S(7,6)]$ are reached. If the matrix were extended to the right (because there were other words rather than silence), then the scores for the top row would become large again. Yet the matrix would reveal that "six" had been spotted because the scores would have dipped briefly from an average of approximately 18 to 3.

Dynamic programming and related mathematical optimization techniques are of exceptional significance to automatic speech recognition. More than any other single intellectual tool, it has enabled speech classifiers to progress beyond short simple words to handle longer words, phrases, and sentences. Dynamic programming was independently developed with minor variations in at least three different fields: operations research, communications theory, and in mathematics as a first-order Markov process (see references 2, 3, and 12). None of

these original formulations was for speech applications.

What's Available Now?

Table 1 shows the product names and identifies the manufacturers of products on the market in 1983 that are expected to be available in 1984. Note that these products are not intended for consumers but, rather, for industrial applications. The industrial applications are typically "hands-busy" activities involving inspections usually associated with quality control (for example, on an assembly line or in a laboratory in conjunction with entering data gathered using microscopes). The variety of applications is extraordinary, although the number of applications appears small. Other examples include flight-training simulators for entering a limited set of command words, baggage/parcel sorting, voice control of machine tooling, and home-appliance control by personal computers. They have occasionally been used for educational applications.

Connected speech recognition is essential for some applications such as zip-code reading for parcel sorting by the United States Postal Service. Note that there are only three manufacturers of continuous speech systems.

It appears that the exciting new developments to watch in 1984 will come from Nippon Electric Corporation (NEC), Dragon Systems, Voice Control Systems, Interstate Electronics, and possibly Asulab. NEC is exciting for two reasons: first, the company has an extraordinarily good continuous-speech recognition system for vocabularies of up to 120 words for users who have trained the system (around \$2000); and second, NEC's lower-performance three-chip set will soon be available, recognizing 128 words of isolated utterances for talkers who have trained the system (estimated at \$35 per chip set in large quantities). This chip set, available on an OEM (original equipment manufacturer) basis to American manufacturers, should make speech-recognition technology widely available for isolated utterances.

Dragon Systems has developed al-

THE FORTH SOURCE™

MVP-FORTH

Stable - Transportable - Public Domain - Tools
 You need two primary features in a software development package... a stable operating system and the ability to move programs easily and quickly to a variety of computers. MVP-FORTH gives you both these features and many extras. This public domain product includes an editor, FORTH assembler, tools, utilities and the vocabulary for the best selling book "Starting FORTH". The Programmer's Kit provides a complete FORTH for a number of computers. Other MVP-FORTH products will simplify the development of your applications.

MVP Books - A Series

- Volume 1, All about FORTH** by Haydon, MVP-FORTH glossary with cross references to fig-FORTH, Starting FORTH and FORTH-79 Standard. 2nd Ed. \$25
- Volume 2, MVP-FORTH Assembly Source Code.** Includes CP/M®, IBM-PC®, and APPLE® listing for kernel \$20
- Volume 3, Floating Point Glossary** by Springer \$10
- Volume 4, Expert System** with source code by Park \$25
- Volume 5, File Management System** with interrupt security by Moreton \$25

MVP-FORTH Software - A Transportable FORTH

- MVP-FORTH Programmer's Kit** including disk, documentation, Volumes 1 & 2 of MVP-FORTH Series (All About FORTH, 2nd Ed. & Assembly Source Code), and Starting FORTH. Specify CP/M, CP/M 86, CP/M+, APPLE, IBM PC, MS-DOS, Osborne, Kaypro, H89/Z89, Z100, TI-PC, MicroDecisions, Northstar, Compupro, Cromenco \$150

- MVP-FORTH Cross Compiler** for CP/M Programmer's Kit. Can also generate headerless code for ROM or target CPU \$300
- MVP-FORTH Meta Compiler** for CP/M Programmer's kit. Use for applications on CP/M based computer. Includes public domain source \$150
- MVP-FORTH Fast Floating Point** Includes 9511 math chip on board with disks, documentation and enhanced virtual MVP-FORTH for Apple II and Iie. \$450
- MVP-FORTH Programming Aids** for CP/M, IBM or APPLE Programmer's Kit. Extremely useful tool for decompiling, callfinding, and translating. \$150
- MVP-FORTH** by ECS for IBM-PC or ATARI®. Standalone with screen editor. License required. \$100
- MVP-FORTH** by ECS for IBM-PC or ATARI. With color animation, multitasking sound, utilities, and license. \$175
- MVP-FORTH Professional Application Development System (PADS)** for IBM-PC, or APPLE. A three level integrated system with complete documentation. Complete system \$400
- MVP-FORTH Expert System** for development of knowledge-based programs for Apple, IBM, or CP/M. \$80
- MVP-FORTH File Management System (FMS)** with interrupt security for IBM, Victor 9000, or CP/M \$200

FORTH DISKS

FORTH with editor, assembler, and manual.

- APPLE** by MM \$100
- APPLE** by Kuntze \$90
- ATARI®** valFORTH \$60
- CP/M®** by MM \$100
- HP-85** by Lange \$90
- HP-75** by Cassidy \$150
- IBM-PC®** by LM \$100
- NOVA** by CCI 8" DS/DD \$150
- Z80** by LM \$50
- 8086/88** by LM \$100
- VIC FORTH** by HES, VIC20 cartridge \$50
- C64** by HES Commodore 64 cartridge \$60

Enhanced FORTH with: F-Floating Point, G-Graphics, T-Tutorial, S-Stand Alone, M-Math Chip Support, MT-Multi-Tasking, X-Other Extras, 79-FORTH-79.

- APPLE** by MM, F, G, & 79 \$140
- ATARI** by PNS, F, G, & X \$90
- CP/M** by MM, F & 79 \$140
- Apple, GraFORTH** by I \$75
- Multi-Tasking FORTH** by SL, CP/M, X & 79 \$395
- TRS-80/II or III** by MMS, F, X, & 79 \$130
- Timex** by FD, tape G, X, & 79 \$45
- Victor 9000** by DE, G, X \$150
- Extensions** for LM Specify IBM, Z80, or 8086
 - Software Floating Point \$100
 - 8087 Support (IBM-PC or 8086) \$100
 - 9511 Support (Z80 or 8086) \$100
 - Color Graphics (IBM-PC) \$100
 - Data Base Management \$200 Requires LM FORTH disk.

fig-FORTH Programming Aids for decompiling, callfinding, and translating. CP/M, IBM-PC, Z80, or Apple \$150

CROSS COMPILERS Allow extending, modifying and compiling for speed and memory savings, can also produce ROMable code. *Requires FORTH disk.

- CP/M \$300
- 8086 \$300
- Northstar® \$300
- IBM• \$300
- Z80• \$300
- Apple II/II+ \$300

FORTH COMPUTER

- Jupiter Ace** \$150
 - 16K RAM Pack \$50
 - 48K RAM Pack \$125

Key to vendors:

- | | |
|-----------------------------|-----------------------------------|
| CCI Capstone Computing Inc. | MM MicroMotion |
| DE Dai-E Systems | MMS Miller Microcomputer Services |
| FD Forth Dimension | NS Nautilus Systems |
| I Insoft | PNS Pink Noise Studio |
| LM Laboratory Microsystems | SL Shaw Labs |

Ordering Information: Check, Money Order (payable to MOUNTAIN VIEW PRESS, INC.), VISA, MasterCard, American Express. COD's \$5 extra. Minimum order \$15. No billing or unpaid PO's. California residents add sales tax. Shipping costs in US included in price. Foreign orders, pay in US funds on US bank, include for handling

FORTH MANUALS, GUIDES & DOCUMENTS

- ALL ABOUT FORTH** by Haydon. See above. \$25
- FORTH Encyclopedia** by Derick & Baker. Programmer's manual to fig-FORTH with FORTH-79 references. Flow charted, 2nd Ed. \$25
- Understanding FORTH** by Reymann \$3
- FORTH Fundamentals, Vol. I** by McCabe \$16
- FORTH Fundamentals, Vol. II** by McCabe \$13
- Beginning FORTH** by Chirlian \$17
- FORTH Encyclopedia Pocket Guide** \$7
- And So FORTH** by Huang, A college level text. \$25
- FORTH Programming** by Scanlon \$17
- FORTH on the ATARI** by E. Floegel \$8
- Starting FORTH** by Brodie. Best instructional manual available. (soft cover) \$18
- Starting FORTH** (hard cover) \$23
- 68000 fig-Forth** with assembler \$25
- Installation Manual for fig-FORTH,** \$15
- 1980 FORML Proc.** \$25
- 1981 FORML Proc 2 Vol** \$40
- 1982 FORML Proc.** \$25
- 1981 Rochester FORTH Proc.** \$25
- 1982 Rochester FORTH Proc.** \$25
- 1983 Rochester FORTH Proc.** \$25
- A FORTH Primer** \$25
- Threaded Interpretive Languages** \$23
- META-FORTH** by Cassidy \$30
- Systems Guide to fig-FORTH** \$25
- Invitation to FORTH** \$20
- PDP-11 User Man.** \$20
- FORTH-83 Standard** \$15
- FORTH-79 Standard** \$15
- FORTH-79 Standard Conversion** \$10
- Tiny Pascal fig-FORTH** \$10
- NOVA fig-FORTH** by CCI Source Listing \$15
- NOVA** by CCI User's Manual includes editor, assembler, and utilities \$25
- Jupiter ACE Manual** by Vickers \$15

Source Listings of fig-FORTH, for specific CPU's and computers. The Installation Manual is required for implementation. Each \$15

- | | | | |
|--------------------------------|----------------------------------|-------------------------------|--|
| <input type="checkbox"/> 1802 | <input type="checkbox"/> 6502 | <input type="checkbox"/> 6800 | <input type="checkbox"/> AlphaMicro |
| <input type="checkbox"/> 8080 | <input type="checkbox"/> 8086/88 | <input type="checkbox"/> 9900 | <input type="checkbox"/> APPLE II |
| <input type="checkbox"/> PACE | <input type="checkbox"/> 6809 | <input type="checkbox"/> NOVA | <input type="checkbox"/> PDP-11/LSI-11 |
| <input type="checkbox"/> 68000 | <input type="checkbox"/> Eclipse | <input type="checkbox"/> VAX | <input type="checkbox"/> Z80 |

and shipping by Air: \$5 for each item under \$25, \$10 for each item between \$25 and \$99 and \$20 for each item over \$100. All prices and products subject to change or withdrawal without notice. Single system and/or single user license agreement required on some products. **DEALER & AUTHOR INQUIRIES INVITED**

MOUNTAIN VIEW PRESS, INC.

PO BOX 4656

MOUNTAIN VIEW, CA 94040

(415) 961-4103

Manufacturer	Product	Approximate Price	Speech Type	Speaker Independence	Approximate* Vocabulary Size
Dragon	Mark II	\$500	Isolated word	Yes	32-300
Scott Instruments	Shadow/VET	\$1000	Isolated word	No	80
Interstate	VRT 300	\$1100	Isolated word	No	80
Nippon Electric Corporation (NEC)	SR 100	\$2000	Continuous speech	No	120
Votan	V 5000-A	\$6000	Isolated word	No	256
Interstate	VRT 101/3/11	\$5000	Isolated word	No	80
NEC	DP 200	\$15,000	Continuous speech	No	150
Verbex	3000	\$20,000	Continuous speech	No	120
NEC	SR 1000	\$60,000 (variable)	Isolated word	Yes	20

Table 1: The commercial speech-recognition products suitable for industrial use. Note that continuous speech and speaker independence correlate with higher cost. The prices and vocabulary sizes of systems are rounded to fall into general groupings.

gorithms that it is prepared to license. The company's work represents a breakthrough in algorithm development, which has major implications for the entire field. These algorithms could enable the world's most cost-effective speech-recognition devices to be developed. They have demonstrated performance superior to systems costing over \$15,000.

Voice Control Systems (VCS) has developed a time-domain, low-cost (requiring an 8-bit microprocessor such as a 6502), speaker-independent recognition scheme that it is licensing for a modest fee. This system is potentially less expensive than those of NEC or Dragon, but its vocabulary is limited to only 10 to 20 words at a time. On the other hand, the speaker independence of the VCS system makes it much more appealing as a consumer product, which ultimately may open possibilities for cost reduction and development of additional applications.

Finally, Asulab, of Neuchatel, Switzerland, is developing a wrist-watch speech-recognition device. This will be an extraordinary technological achievement as well as an interesting consumer device. The system will be speaker-dependent (that is, it must be trained before use) and is capable of recognizing only 15 words spoken in isolation. It will be used to set the time, alarm, stopwatch function, and other standard timepiece operations.

Interstate Electronics Corporation, the oldest and probably one of the most successful speech-recognition companies in the United States, has produced a speech-recognition chip that enables speaker-independent isolated utterances suitable for consumer products, including toys. After an initial tooling charge, quantities of 100,000 or more cost \$5.50 per chip. This system enjoys an 85 to 90 percent accuracy level and is capable of recognizing a 16-word vocabulary.

Summary

Automatic speech recognition is an old idea that has fascinated researchers for a quarter of a century and frustrated attempts at commercialization for 15 years. During these years, important progress has been made in pattern matching through dynamic programming, in cost reduction through LSI (and VLSI) chips, and in voice processing through signal-processing theory and VLSI. Commercial potential is finally becoming realizable.

The concept of talking to machines instead of keystroking input has considerable appeal to the buying public. Market forces will prevail, and, I believe, speech-recognition products will literally invade our lives within a decade or two. In the near term we will see speech-recognition peripherals for computers, later as consumer novelties (such as voice-controlled watch/calculators), and eventually as telephone controller/

DATA TRANSFER PROBLEMS?

Your Simple Solution is **REFORMATTER**® Diskette Conversion Software



- Avoids serial communication protocols.
- Needs only one system to transfer data.
- Converts source code and data files.
- Allows 2-way transfer.
- Quick, reliable, and inexpensive.

VERSIONS

Runs On	Reads/Writes
CP/M	↔ IBM 3740
CP/M	↔ DEC RT-11
CP/M-86*	↔ IBM 3740
CROMIX	↔ DEC RT-11
DEC RT-11*	↔ CP/M
MS-DOS*	↔ IBM 3740
TRSDOS II	↔ CP/M
TRSDOS II	↔ DEC RT-11

PRICE: \$249 *\$350

Requires 8" floppy drive.

(415) 324-9114 TWX: 910-370-7457

467 Hamilton Avenue, Suite 2, Palo Alto, Calif. 94301



An Epson Printer Did This

with help from

The Fancy Font™ System

Letter Quality

Say goodbye to correspondence quality and hello to *Fancy Font's* high-resolution, proportionally spaced letter quality. *Fancy Font* provides fonts in sizes from 8 to 40 points; styles include Roman, Bold, Italic, Script, Old English, and more. All this on low-cost Epson (MX, RX, FX) and Gemini 10X printers. *Fancy Font* is a software package for CP/M and IBM PC compatible systems; no special hardware or installation is required.

Create Your Own Characters

You can use over 30 font sets in the *Fancy Font* package and furthermore, can create any new characters or logos you like, up to 1 inch by 1 inch. A database of over 1500 characters is included that makes it possible to print foreign languages and mathematical notations.

Font Style Samples

small medium **large** Bold Italic
 Sans Serif Script Old English

$$A = \int_0^a \sqrt{a^2 - x^2} dx$$

Φ Ψ Ω Β € 6 Д Ж ± ÷ ≠ ≤ ≥ ♂ @ § Ω ○ ● # † ‡

Numerous Applications

Fancy Font customers, numbering in the thousands, are constantly discovering new applications.

- Business and personal letters
- Custom forms, invoices, labels, signs
- Foreign Languages
- Mathematical Notation, Greek
- Super- and Sub-scripts
- View Graphs
- Custom Letterheads
- Resumes
- Articles for publication
- Newsletters, brochures
- Complete manuals
- Advertisements
- Invitations, place cards

InfoWorld
Software Report Card

Fancy Font

	Poor	Fair	Good	Excellent
Performance	<input type="checkbox"/>	<input type="checkbox"/>	<input checked="" type="checkbox"/>	<input type="checkbox"/>
Documentation	<input type="checkbox"/>	<input type="checkbox"/>	<input type="checkbox"/>	<input checked="" type="checkbox"/>
Ease of Use	<input type="checkbox"/>	<input type="checkbox"/>	<input checked="" type="checkbox"/>	<input type="checkbox"/>
Error Handling	<input type="checkbox"/>	<input type="checkbox"/>	<input type="checkbox"/>	<input checked="" type="checkbox"/>

Copyright, 1983 by Popular Computing, Inc., a subsidiary of CW Communications, Inc. Reprinted from InfoWorld, 6/2/83

(This ad was printed on an Epson MX-80 printer. Call for an actual sample.)

Highlight: **IBM and CP/M order now - (213) 821-8476 - M/C Visa**

"The quality of print is excellent, and the variety of type styles and sizes is even better."

Pat McKeague, InfoWorld, 5/2/83

SoftCraft, Inc., 8726 S. Sepulveda Bl. #1641, LA, CA 90045
 phone: (213) 821-8476

Fancy Font System \$180.00
 Fancy Font Demo Disk \$ 10.00¹

California Residents add 6.5% sales tax
 Outside US add \$10 (only \$2 for demo) postage

Diskette Format:
 8" CP/M Epson QX10 Osborne Kaypro
 IBM PC² Victor 9000² Apple CP/M³

¹ \$7.50 applicable towards purchase of Fancy Font
² PC/DOS/MSDOS systems require 128K memory
³ Fully transparent 8-bit printer interface required

dialers and voice-actuated typewriters. In the broader sense, speech recognition is part of the general evolution of machine intelligence. It depends on the same fundamental technology as AI and provides the link that will bring us closer to our bright new machines. ■

References

1. Baker, J. K. "Stochastic Modeling for Automatic Speech Understanding." *Speech Recognition*. New York: Academic Press, 1975.
2. Baum, L. E., T. Petrie, G. Soules, and N. A. Weiss. "A Maximization Technique Occurring in the Statistical Analysis of Probabilistic Functions of a Markov Chain." *Annals of Mathematical Statistics* 41, number 1 (1970), pages 164-171.
3. Bellman, R. E. *Dynamic Programming*. Princeton, NJ: Princeton University Press, 1975.
4. Bridle, J. S., and M. D. Brown. "An Experimental Automatic Word-Recognition System: Interim Report." *Joint Speech Research Unit* (1974) number 1003 (unpublished).
5. Bridle, J. S., M. D. Brown, and R. M. Chamberlain. "An Algorithm for Connected Word Recognition." *Proceedings of the IEEE International Conference on Acoustics, Speech and Signal Processing*, May 1982.
6. Jelinek, E., L. R. Bahl, and R. L. Mercer. "Design of a Linguistic Statistical Decoder for the Recognition of Continuous Speech." *IEEE Transactions in Information Theory* IT-21, (1975), pages 250-256.
7. Loweree, B., and D. R. Reddy. "The Harpy Speech Recognition System." *Trends in Speech Recognition*. Englewood Cliffs, NJ: Prentice-Hall, 1980.
8. Pierce, J. R. "Whither Speech Recognition?" *Journal of the Acoustical Society of America*, volume 46, (1969), pages 1049-1051.
9. Pollack, I., and J. M. Pickett. "The Intelligibility of Excerpts from Conventional Speech." *Language and Speech*, volume 6, (1963), pages 165-171.
10. Sakoe, H., and S. Chiba. "A Dynamic-Programming Approach to Continuous Speech Recognition." *Proceedings of IEEE Symposium on Speech Recognition*, April 1974, pages 101-104.
11. Velichko, V. M., and N. G. Zagoryko. "Automatic Recognition of 200 Words." *International Journal of Man-Machine Studies*, (1970), volume 2, pages 223, 235.
12. Viterbi, A. J. "Evo Bound for Convolutional Codes and an Asymptotically Optimum Decoding Algorithm." *IEEE Transaction on Information Theory*, volume IT-13, (April 1967), pages 260-269.

George M. White is Chief Technical Officer of Koala Technologies Corporation (3100 Patrick Henry Dr., Santa Clara, CA 95050) and holds a Ph.D. in chemical physics. When he's not sitting in front of a microcomputer, he enjoys soccer and swimming.

**ANNOUNCING
THE BIGGEST
NEWS SINCE
HARDWARE
AND
SOFTWARE...**

HELPWARE™

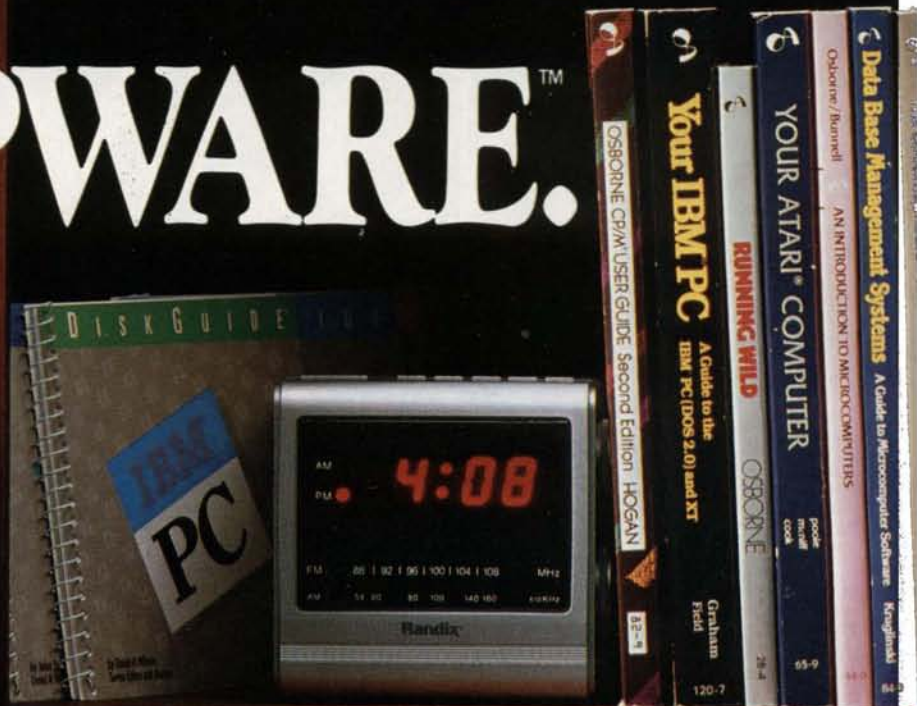

HELPWARE™



HELPWARE™ Helps You Put It All Together.

What makes HELPWARE™ different than other computer-related books? Clear, concise writing. Careful editing. And our commitment to publishing only those books that help you get the job done. Faster. Easier. More productively.

Buy Your Micro A Page At A Time.

Before you invest your hard-earned money in hardware or software, invest in HELPWARE.

Read about the product you want to purchase and then decide if it's right for you. Then, after you've made your purchase, choose the HELPWARE user guide, programming or technical reference and assembly language guide that will help you get the most out of your computer.

If You Love The Book, Wait Till You See The Screenplay.

Each book we publish, including our handy DiskGuide™ Series of compact computer



reference guides, clearly explains its subject matter so that you'll be able to solve your problem quickly and easily, regardless of your level of experience.

Before You Sign On The Dotted Line, Cut Ours.

To get your copy of our full line catalog, just cut out the coupon and send it to us, or call us **TOLL-FREE** at: **800-227-2895**, in California, **800-772-4077**. You'll see page after page of worthwhile titles. Each one tested and

re-tested to make sure that it meets our high standards. After all, if they were just books, they wouldn't be **HELPWARE**.

Osborne McGraw-Hill

TURN TO US FOR HELPWARE.

TM — **HELPWARE** and **DISKGUIDE** are Trademarks of Osborne/McGraw-Hill.

Circle 276 on inquiry card.

I'd like a **HELPWARE** catalog. Dept. H1

Name _____

Street _____

City _____

State _____ Zip _____

Mail to: Osborne/McGraw-Hill
2600 Tenth Street
Berkeley, CA 94710



Using Natural-Language Systems on Personal Computers

Your computer may speak English in 1984

by Jane Eisenberg and Jeffrey Hill

In boardrooms, managers' offices, secretarial pools, and hallways of corporate America, the role of computer technology is being reexamined. With the advent of personal computers, people no longer stand in awe of the machines or accept that the high priests of data processing must always intercede in the everyday use of the technology by knowledge workers.

A common refrain in these enclaves is, "Will computers ever understand English?" Indeed, the promise of the "computer revolution" seems to hinge on the machine's ability to speak the language of people, not the reverse. In George Orwell's *1984*, if you remember, the computer-controlled apparatus of Big Brother had mastered the skill; in fact, it understood everyday conversation all too well.

The little-understood field of Artificial Intelligence (AI) may be the key to the eventual scaling of the human-computer communication hurdle. AI researchers avow that natural-language query systems are an economically approachable reality in the year ahead.

In the following pages, we'll discuss some of the ways in which natural-language query systems will change the way that people and per-

sonal computers interact.

What Is a Natural-Language System?

Imagine yourself in the middle of trying to hang a picture. You're standing on a ladder and want your assistant to hand you a hammer. But instead of simply being able to ask for the hammer, you have to stop, get off the ladder, write a small program, debug it, and then run it in order to get the hammer.

Sound ridiculous? Yes, but that's exactly what most people face when they need to get information from computers. To make matters worse, most people don't know the "foreign" language of computers.

In fact, we humans take for granted our unique capability to communicate with each other in a common language. The languages people speak are called *natural languages*. A natural-language (NL) system is one that allows a person to interact with a computer by using the same language he uses to interact with another person. Such a system deals with the richness of English as people use it—along with all its ambiguities—and forgives the typical ungrammatical English that most people use in everyday communication. The NL system must handle

commonplace events such as misplaced modifiers, dangling participles, and sentence fragments.

The most obvious advantage of a natural-language system is that people do not have to be trained in a programming language to use a computer. Given the large potential number of users of information and the relatively small number of people who know formal systems, this is of key importance. There is another often overlooked advantage—it can be much easier to express a request in natural language than in a formal language. For example, figure 1 shows the same request phrased in both natural English and in the syntax of an "English-like" program command language. At a glance, it is easy to see how much simpler the English query is to understand, but what surprises many people is the discovery that the English query is shorter than the corresponding formal query.

The underlying reason for this conciseness is that a natural-language system does much more than simply understand the syntax of the language. The system derives much of its usefulness from its understanding of the semantics of natural language. The NL system maps the concepts expressed in words onto underlying concepts that computers can deal

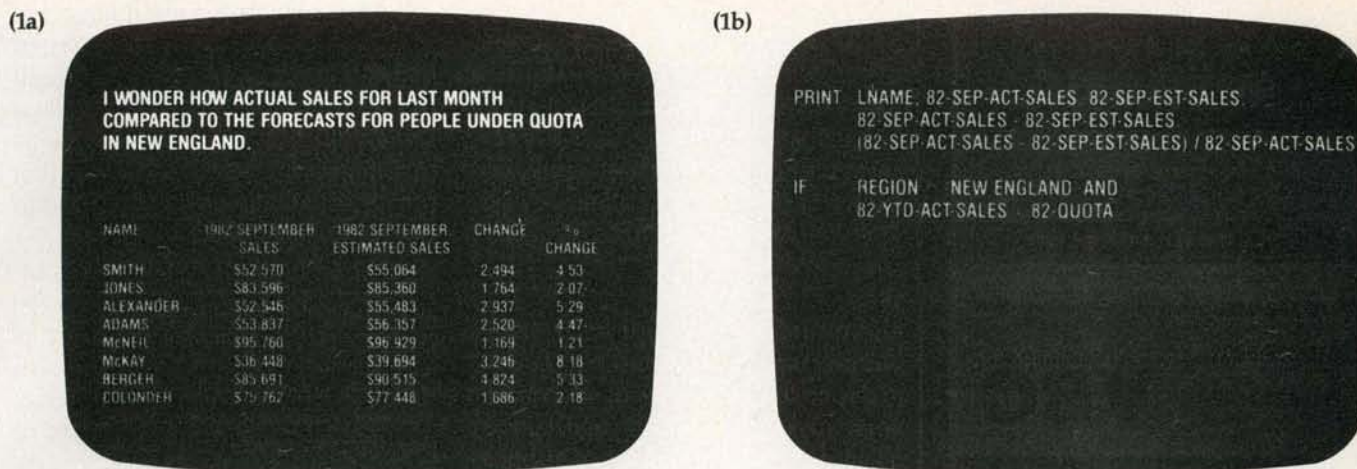

Figure 1: A comparison of English (a) and "English-like" (b) queries.

with. In later examples, we will see many instances in which the ability of the system to map high-level concepts gives the natural-language system a considerable edge over any formal system.

We'll look briefly at the history of natural-language processing to see how it developed from a research area into a practical, mainframe database query tool. Then we'll examine how natural-language processing fits into the personal computer environment and compare its use with other methods of communicating with computers.

The History of Natural-Language Processing

Natural-language systems evolved from research into Artificial Intelligence, whose goal is to understand human intelligence well enough to produce machines that exhibit intelligent behavior. Understanding natural language was one of the earliest areas of AI research, since it was clearly a unique example of human intelligence.

The first AI work on natural language was in the area of machine translation (MT), using (then) new methods of syntax analysis, developed for understanding computer languages (as in context-free grammars, where language components are defined independent of the context in which they are used. These grammars use recursive definitions, i.e., an <unsigned integer> is defined as a <digit>, or as an

<unsigned integer> followed by a <digit>). It was quickly apparent that these "syntactic" based systems were not up to the job. The anecdotal climax of this early machine-translation effort was a system that translated the English sentence "The spirit is willing but the flesh is weak" into a Russian sentence whose literal reading was "The vodka is strong but the meat is rotten."

Since understanding natural languages depends upon better ways of representing semantic information, research switched from the MT effort to "question-answering systems." These systems use a knowledge database to understand and answer questions posed in English. One of the earliest such systems was the Baseball program (reference 4), which contained a database of statistics for one major league season. This research phase culminated in the early 1970s with two prototype systems, both based on the notion of "procedural semantics," in which the meaning of words and concepts is broken down into tasks and subtasks. The Lunar system of Woods (reference 5) could respond to English questions about the data analysis of the Apollo XI moon-rock samples (see figure 2). Winograd's SHRDLU system (reference 3) interpreted English sentences to control the movements of a simulated one-arm robot (see figure 3). Both of these systems contained extremely sophisticated theories of language. Both systems could parse more sentences

than they could understand, but in their limited application domains they were quite impressive.

Clearly, more research into semantic representation was required to produce systems capable of understanding the range of English that people routinely use. Most of the research work in AI today is concerned with finding better representation schemes for knowledge. (For a more detailed history of natural-language processing research, see reference 2.) However, a great deal had been learned about the structure of natural languages (particularly English) and about ways for representing and applying the semantics of a limited domain. But was there a practical use for such systems? Woods's work with the Lunar system clearly suggested database query as a promising area. But three problems had to be solved to make this technology commercially viable:

1. *Robustness.* These systems were

```

How many breccias contain olivine?

What are they?

Do any samples have greater than 13 percent aluminum?

What are those samples?

List K/RB ratios for breccias.
  
```

Figure 2: Sample questions interpreted by Woods's Lunar system.

Pick up a big red block.
OK.

Grasp the pyramid.
I DON'T UNDERSTAND WHICH PYRAMID YOU MEAN.

Find a block which is taller than the one you are holding and put it into the box.
BY "IT," I ASSUME YOU MEAN THE BLOCK WHICH IS TALLER THAN THE ONE I AM HOLDING.

What does the box contain?
THE BLUE PYRAMID AND THE BLUE BLOCK.

What is the pyramid supported by?
THE BOX.

How many blocks are not in the box?
FOUR OF THEM.

Figure 3: A sample dialogue with Winograd's SHRDLU system.

very sensitive to small errors in typing and grammar. A commercial version needs to forgive minor user mistakes.

2. *Environment.* The natural-language research systems were largely written in LISP, the common language of the AI research community. The "databases" used were home-brew systems developed especially for the natural-language system that used them. To be commercially viable, natural-language database query systems would need to run on standard commercial hardware, in a standard language, and take advantage of the technology developed in commercial database-management systems (DBMSs).
3. *Portability.* The most serious problem of the research systems was the "customization" cost. To adapt one of these systems to a new database typically takes a man-year of effort by an experienced AI researcher.

In 1975, Artificial Intelligence Corporation began work to produce a commercially viable natural-language database query system by concentrating on solving these problems. AIC's product, Intellect, is a robust, portable natural-language system that runs on IBM mainframe computers (see the text box on page 230 for a description of Intellect). It interfaces to most of the popular mainframe DBMSs. Intellect was the first successful commercialization of AI technology.

Use on Mainframes

The most widespread use of natural-language systems today is to provide the ability to query the contents of a database in free-form English. The first generation of commercial natural-language systems required mainframe computers with large amounts of storage and processing power. In addition, the development and refinement of natural-language parsing techniques required a substantial investment in both time and resources, which meant a relatively high price tag (\$50,000 to \$100,000). However, most major minicomputer vendors are pursuing the addition of a natural-language query facility to their product lines either through internal development efforts or via cooperative marketing agreements with the companies who have already developed this technology.

Database query is a good application for natural-language processing. First, let's define what we mean by the term database query. In order to understand a query, the system must

- 1) identify specific items of data to retrieve
- 2) identify criteria for selecting a desired subset of all records in all files
- 3) determine the analytical and display processes required to manipulate the data
- 4) invoke the required retrieval, analytic, and display processes in the sequence necessary to answer the question

The technology of natural-language parsing currently works best when the dialogue is limited to a small world view. Database query is unique among natural-language applications in that it quite naturally fits this constraint—the dialogue is limited to the contents of the database.

Knowledge workers need information. A major obstacle to the acceptance of end-user computing has been the unwillingness of the non-computerist to learn the necessary commands to make effective use of the computer as a resource. Studies of user information needs spurred development of systems whose medium of communication is the highest level end-user language, natural English. Systems offering anything less than comprehension of native English require excessive training of end users, training that is wasted unless the end users work on the system frequently.

Additionally, end users have little or no knowledge about the form in which the information is stored. Even worse, the user's conceptual view of the information has no mapping to the physical or logical format of the data. Users are interested in data access from a high level of abstraction. This means they want the ability to retrieve information in a form immediately useful to them. This often includes

1) *Data summaries:*

"What were the total commissions paid in the Western sales region last month?"

"Rank our product lines in terms of profitability."

2) *Implied calculations such as averages and percentages:*

"What is the average salary in the Accounting Department?"

"Give me the percentage of total sales in each region."

3) *Aggregation of data over time:*

"How did our sales in January compare to our sales in March?"

The flexibility of an English query system makes it possible to phrase questions in many different ways.

800-451-2502

or 617-641-1241 in Mass.
617-641-1235 for
Technical
Support

SoftwareBanc

661 Massachusetts Avenue
Arlington, MA 02174

Banc On Us!

WHAT IS SOFTWAREBANC?

Over the last two years, SoftwareBanc has provided the nation's most complete package of dBASE II™ products and services. Our **dBASE II™ User's Guide** and Seminars have introduced more than 60,000 people to dBASE II™. Even expert dBASE II™ users can benefit from our **Advanced User's Guide** and quality add-on products. When it comes to dBASE II™, SoftwareBanc is the source you should banc on.

BOOKS



dBASE II™ User's Guide by Adam B. Green. Join the 55,000 people who have made this the standard text on dBASE II™. \$29.00 - FREE with dBASE II™



Advanced dBASE II™ User's Guide by Adam B. Green. This collection of previously unpublished tips and techniques is the perfect companion to the dBASE II™ User's Guide. \$29.00



Report Writing in dBASE II™ by SoftwareBanc Technical Services. Everything you always wanted to know about dBASE II's™ Report Writer. \$11.95

SOFTWARE WITH TECHNICAL SUPPORT

Data Base

dBASE II™ with
free dBASE II™
User's Guide \$439
ABSTAT \$359
DBPlus \$125
dGRAPH \$199
dNAMES \$109
FRIDAY! \$199
Quickcode \$199

Word Processing

WordStar \$269
SpellStar \$149
MailMerge \$149
StarIndex \$149
Volkswriter \$129

Spreadsheets

1-2-3 with free
1-2-3 Trans \$399
Supercalc 2 \$199
Multiplan \$219

Our low software prices include unlimited, free technical support by our staff of software experts. You can trust us to be there for technical problems, tips or application advice.

ORDERING

To order, please call (800) 451-2502 or (617) 641-1241 in Mass. Hours are 9 AM - 8 PM E.S.T. Monday-Friday and 9 AM - 5 PM E.S.T. on Saturday.

Payment may be made by: MasterCard, VISA, check, C.O.D., money order. Mass. Residents add 5% sales tax. Add \$5 for S&H. Prices subject to change without notice. TM-Manufacturer's Trademark. Dealer Inquiries Invited. Ask about our Discount Savings Plan.

VIDEO

dBASE II™ Fundamentals on Video Tape

Written and Narrated by Adam B. Green.

This professionally produced, three hour video tape will help any viewer to create and manage dBASE II™ data files. Now you can have a SoftwareBanc Seminar in your home or office.

\$295.00 (VHS or Betamax formats).

\$50 savings with dBASE II™.

SEMINARS

dBASE II™ and 1-2-3™ SoftwareBanc Seminars

Taught by Adam B. Green.

Over 5,000 people have attended SoftwareBanc Seminars around the country. Our custom video presentation system will help you "Teach Your Computer Who's Boss."

- dBASE II™ Fundamentals
- dBASE II™ Programming
- Advanced dBASE II™
- Problem Solving With 1-2-3™

Schedule

Washington, D.C.

Jan. 9, 10, 11, 13
\$175/Day

Orlando

Feb. 6, 7, 8, 10
\$175/Day

Chicago

Mar. 12, 13,
14, 15
\$200/Day

CLIP & MAIL

Return to:
SoftwareBanc

661 Massachusetts Avenue, Arlington, MA 02174

Send me a free catalogue.

Have a representative call me.

Name _____

Company _____

Address _____

City/State/Zip _____

Phone Number _____

Computer/Disk Format: _____

Mainframe Versions of Intellect

The current versions of Intellect run on IBM mainframe computers—the 370, 4300, and 30xx series as well as compatible machines made by Amdahl, National Semiconductor, IPL, and others.

These processors range from the IBM 4321, which is a 0.2 million-instructions-per-second (MIPS) machine to the 3084, which runs at 20 MIPS.

Intellect runs under all three of IBM's mainframe operating systems—VM/CMS, DOS/VSE, and MVS. The Intellect system interfaces to most popular mainframe database management systems, including IDMS, ADABAS, SQL, and VSAM.

Artificial Intelligence Corporation also offers DEAM, its own indexed retrieval system.

The mainframe Intellect system is writ-

ten primarily in PL/I, with a few routines (less than 10 percent) coded in IBM assembly language.

Depending on the operating system and DBMS interfaces, the Intellect load module is between 600K and 900K bytes. Virtual memory required by each user is approximately 200K bytes.

A license to run Intellect on an IBM mainframe costs \$69,500. An optional interface to IBM's PGF graphics package (which allows the user to ask in English for pie charts, bar charts, etc.) costs \$15,000.

These fees include one-year maintenance, documentation, training courses at AIC, and applications consulting.

AIC sells Intellect directly, with its own sales force, and through OEM and joint

marketing arrangements with other companies (IBM, Cullinet). There are approximately 150 mainframe installations of the system, most of them in Fortune 1000 companies.

Porting Intellect to the personal computer environment has produced no major problems to this stage of the project. There are some differences between Digital Research's PL/I compiler and the IBM mainframe PL/I compiler, but these incompatibilities are overcome by clever coding.

The fact that hardware capability is not an issue in adapting Intellect to personal computers is a testament to the blurring of the lines separating mainframes, minis, and micros.

Some of these may be wordy, while others can be quite concise. In almost all cases, however, it is possible to be more concise in English than with a formal command language. In addition, some English query systems allow references to previous questions using implied pronouns. For example,

"List the first and last names of the secretaries to our New York City office."

"How many are married?"

Users can vary the selection criteria of a previous question very easily and succinctly:

"Who are the salespeople over quota in the Eastern region?"

"Western region?"

A simple English dialogue gracefully resolves ambiguities and spelling errors. If an ambiguity is detected, the system requests the user to clarify his intent. The user may be asked to clarify a word that may have multiple meanings in the database (such as New York), to correct a spelling error, or to enter a new definition or conceptual relationship into the system's vocabulary.

These examples show how high-level concepts expressed in natural language can evoke a very complex series of operations in response to a simple question.

A system that can use conversational English to retrieve, analyze, and present information in a useful form will provide knowledge workers and middle- to upper-level managers with tools they desperately need and can use immediately.

Most large companies purchase a number of different application tools from different vendors. Many firms organize these software tools into an internal Information Center. This facility can provide a greater level of analysis, consultation, and support to end users.

A benefit of natural-language query systems is their ability to perform the function of "traffic cop" or integrator. It is highly desirable to have the natural-language interface be the only interface visible to the end user. Users can then issue a single request to have data selected, analyzed, and displayed. They do not have to learn the various command structures and intricacies of separate DBMS, graphics, or display packages. Users request work in ways they are used to.

The natural-language interface overcomes the two traditional problems preventing the information

center from being a completely useful facility for the end user. First, each application package or software tool uses its own specific language. Second, these components are usually independent of one another, allowing no communication or control of data transfer among them.

Some NL systems also provide selection, summarization, and analytic capabilities beyond those available in the DBMS. Multiple passes over the data can perform such arithmetic operations as sorting and totaling by category, ranking, obtaining averages, performing comparisons, and formatting the information for output in a report or graph.

In fact, in many companies the natural-language system is becoming the "hub" of the Information Center. In these cases, end users can access many tools, including graphics packages, analysis and modeling systems, application programs, report writers, and DBMSs. The following types of requests are possible:

"Give me a pie chart of our 1983 sales in New England broken down by state."

"Print a report sorted by department of the average salary, number of employees, and the average departmental salary in-

Four Answers To Your S-100, Multi-User Problems.

Intercontinental Micro Systems makes everything you need for S-100 bus multi-user systems, networks or single user systems.

At a price that won't break your budget.

Quite simply, our single board computers, slaves, 256K memories and personality boards let you build a system *now*, not later. The hardware works, the software works,

and the prices are what you'd expect from a company that uses the most advanced design, software and production techniques to keep costs down.

What you won't expect is the almost awesome sophistication of Intercontinental Micro System's products.

So stop messing around with multiple sourc-

ing, hardware integration problems and software nightmares. Come to Intercontinental Micro and get it all — price, performance and delivery.

Read the specs, then call, write or circle the bingo number below. We'd be glad to send more information and help solve your S-100, multi-user system problems.

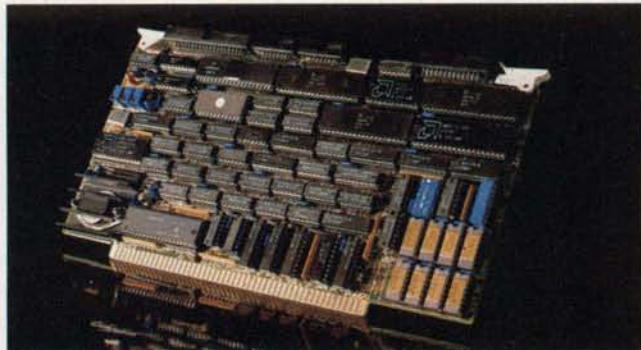

1 CPZ-48000 SINGLE BOARD COMPUTER.

- IEEE 696.1/D2 S-100 compliance.
- Z80A™ 4MHz Operation.
- Floppy disk controller (FDC). Single or double sided. Single or double density. 8" or 5 1/4".
- Two synchronous or asynchronous serial I/O channels (SIO).
- Two parallel I/O channels (PIO).
- Four channel DMA controller.
- 64K on board RAM.
- Memory management unit (MMU). Addresses up to 16 megabytes of system memory.
- Eight Vectored priority interrupts.
- Provisions for 2K or 4K onboard EPROM.
- Software selectable baud rates.
- IBM Bisync, HDLC, SDLC and other protocols.
- CP/M™, MP/M™ and TurboDOS™ operating systems available.
- Turbo-Disk™ implementation included.

2 CPX-MX SLAVES.

- IEEE 696.1/D2 S-100 compliance.
- Compatible with CPZ-48000 SBCP any Z-80A based CPU with extended address capability or 16 bit based CPUs complying with IEEE 696.1/D2 bus specification.
- Z-80B™ 6MHz (CPS-6X) or Z80A 4MHz (CPS-4X) operation.
- Two synchronous (CPS-MS) or asynchronous (CPS-MA) serial I/O ports.
- TurboDOS™ & CP/NET™ compatible.
- Master confiscation of slave memory for diagnostic purposes.
- Two parallel I/O ports; eight data bits + 2 handshake lines per port.
- 64 Kbytes of onboard dynamic RAM.
- Master/slave memory-to-memory transfers under DMA control @ 571 Kbyte/sec transfer rate when used with CPZ-48000 SBCP.
- Software selectable baud rates.
- Usable as an intelligent I/O processor in single user system.

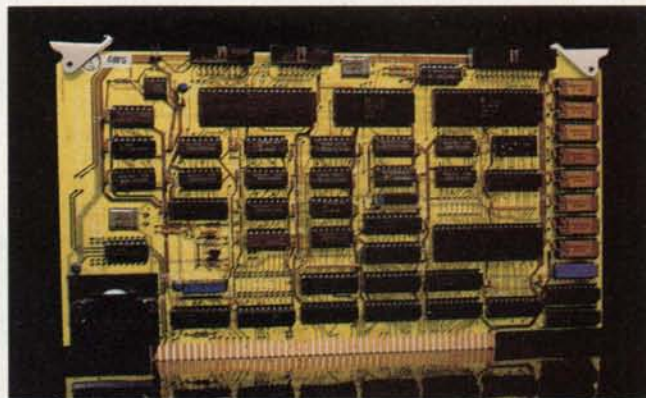

3 256KMB-100 256K MEMORY.

- IEEE S-100 bus, spec 696.1/D2 compliance. The 256KMB-100 is compatible with most IEEE S-100 board products now on the market.
- Linear addressable to 2 megabytes.
- 225 nano-second access time, maximum, 160 nano-seconds, typical.
- 295 nano-second read-write time, minimum.
- Bank selectable 16K increments.
- I/O port address bank selection.
- Configures for phantom deselection.
- Parity error detection, visual and/or interrupts.
- Bank selection compatible with CROMIX™, CP/M2.2™, MP/M™, Alpha Micro, and other major systems.

4 PERSONALITY BOARDS.

- Centronics printer.
- 8 inch floppy disk.
- 5 1/4 inch floppy disk.
- RS232 serial communications.
- Synchronous/asynchronous modem.
- Priam smart/smart E hard disk.
- Long distance serial communication (2000 ft @ 9600 baud).
- Shugart Associates Systems Interface (SASI).
- Clock/calendar.
- Konan David, Jr.™ hard disk.
- Archive tape drive.

Circle 193 on inquiry card

4015 Leaverton Court
Anaheim, CA 92807
(714) 630-0964
Telex: 678401-TAB-IRIN



Z80A & Z80B are trademarks of ZILOG Corp. • CP/M, MP/M & CP/NET are trademarks of Digital Research Corp. • TurboDOS is a trademark of Software 2000 Inc. CROMIX is a trademark of CROMEMCO Corp. • DAVID JR. is a trademark of KONAN Corp.

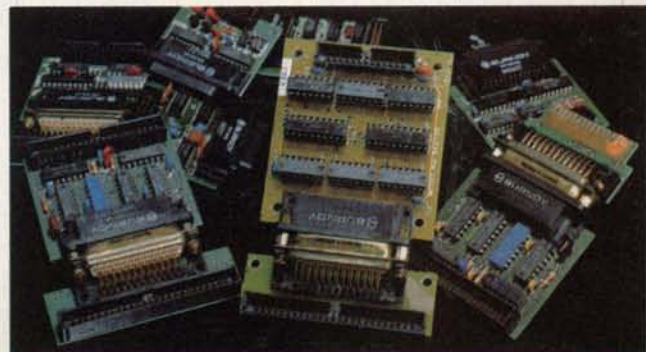

OMNIFAX®

The facsimile for people with small spaces, modest budgets and great expectations.

Never before have so many sophisticated features been condensed into less than three square feet of lightweight desktop facsimile.

Our new Omnifax G39 digital facsimile delivers documents in seconds without mail delays or the cost of couriers. Best of all, it requires a minimum of operator time and performs

most functions automatically.

Sold and serviced by Telautograph's own facsimile experts nationwide and Canada. For brochure or demonstration, call toll free, ask for operator 553,

800-824-7888



Omnifax is a registered trademark of Telautograph Corp.

crease in 1982."

Because the NL query system acts as the supervisor, the underlying work of scheduling and dispatching tasks becomes invisible to the end user. This has both advantages and disadvantages. On the positive side, users can become more productive because they share the ability to issue very powerful commands with far fewer keystrokes. The learning curve is greatly shortened, and users find that the computer is a far more accessible tool.

A drawback may be an overly simplistic view of the amount of work necessary to answer a seemingly simple query. Frequently, questions that appear easy and "cheap" to answer are not, while queries that appear complex are in fact "cheap" in terms of machine resources. This is more likely to be a serious problem in the multiuser mainframe environment, with extremely large databases on line, than with a single-user microcomputer system.

Use on Personal Computers

With the rapidly expanding hardware capabilities of the personal computer, it is now possible to transport natural-language processing technology to the current generation of machines. Increased memory capacity and Winchester-disk technology combined with more sophisticated operating systems such as MS-DOS, Concurrent CP/M, and Unix make the application of this technology commercially viable.

What better fit could there be for the increased accessibility and user friendliness of a natural-language system than in the domain of the personal computer? Some people believe the direct-manipulation metaphor, as exemplified by popular spreadsheet programs such as 1-2-3 and Visicalc, is the best human interface. Others believe that the mouse and window technology of Lisa, Visi On, and Quarterdeck Software's DesQ is the wave of the future. Everyone agrees that integration of applications and tools within a common operating environment (with compatible file structures to facilitate

Treat your personal computer to famous Diablo letter-quality printing.



Apple II
IBM Personal Computer
Radio Shack TRS-80
Commodore IEEE 488
Centronics "Parallel"
RS232C "Serial"

Diablo 630 API
(all-purpose interface)

MTI has the new Diablo 630 API ready for you.

Don't settle for less: up to 40 cps, your choice of over 200 metalized or plastic printwheels, in MTI's opinion the best letter-quality printer on the market today. And at MTI's best price.

Whether you rent, buy or lease our equipment, you'll find MTI is the one source for all the terminals, peripherals, systems, applications expertise and service you'll ever need. At good prices. Call us today.

New York: 516/621-6200, 212/767-0677, 518/449-5959
Outside N.Y.S.: 800/645-6530
New Jersey: 201/227-5552
Ohio: 216/464-6688

"QED" Discounts
VISA & MasterCard



Diablo® Authorized
Distributor

Applications Specialists & Distributors, New York, New Jersey and Ohio.
DEC, Intel, Lear Siegler, Texas Instruments, Dataproducts, Diablo, 3Com,
Hazeltine, Racal-Vadic, Digital Engineering, MICOM, Cipher, U.S. Design,
Protocol Computers, MicroPro, Microsoft, Polygon and Select.

The CONCEPT AVT

Because VT100 users deserve more than just VT100 compatibility.



NEW! AND THERE'S EVEN MORE IN THE NEW CONCEPT AVT +

- New ergonomic features including ultra-low profile keyboard with adjustable height
- VT100-style numeric pad for DEC software compatibility
- Increased functionality, including four LEDs, volume control, more function keys
- Same low price

THE CONCEPT DISPLAY TERMINAL

VT100 compatibility is one thing, but eight pages of memory, programmable function keys, windowing, multiple computer capabilities, ANSI standard conformance...and VT100 compatibility is something else. Only from Human Designed Systems.

A good news/great news story from Human Designed Systems.

First the good news. The *concept* AVT display terminal gives you everything you need in an 80/132-column ANSI/VT100-compatible display terminal. And at a very competitive price.

Now the great news. The *concept* AVT display terminal provides an exciting, new set of capabilities that lets you do much more. Without changing the price.

It starts with ANSI standard conformance, DEC software compatibility, and 80/132-column capability, and extends that even further by offering eight pages of display memory to relieve the interactive user of the need to generate unnecessary hardcopy printouts and to provide the application developer with a powerful tool for applications requiring multiple formats and storage of large volumes of text; by enabling users to permanently configure a terminal for their needs or applications; by providing functionality

\$1295*

designed to improve the effectiveness of slow-speed applications; by enabling users to create true windows within display memory; by providing programmable function keys which transmit data and/or execute terminal commands; by providing up to three additional communications ports for connection to other peripherals and computers; by providing flexible user networking functionality for use in a wide range of different applications, including multiple computer connections; and by doing much more.

VT100 compatibility and ANSI standard conformance. Add it to the *concept* display terminal's 132-column performance, in ASCII or APL/ASCII models, with multiple computer capabilities, windowing, programmable function keys, multiple pages of memory, and much more, and you can see why Human Designed Systems has given terminals a new meaning...and that means true economy.

human designed systems, inc.

3440 Market Street, Philadelphia, PA 19104
215-382-5000 Circle 186 on inquiry card.

*Quantity one. DEC and VT are trademarks of Digital Equipment Corporation.

Human Designed Systems. We're redefining terminal performance.

Atlanta — (404) 391-9763; Boston — (617) 329-3510; Chicago — (312) 825-2960; Dallas — (214) 437-1888; Delaware — Infocon: (302) 239-2942; Denver — (303) 469-1953; Hawaii — Gray Associates: (808) 261-3751; Houston — (713) 952-1403; Los Angeles — (213) 410-9454; Northern New Jersey — Infocon: (201) 624-1372; New York City Area — Infocon: (212) 689-8833; New York State — Naco Electronics: Rochester: (716) 223-4490; Syracuse: (315) 699-2651; San Francisco — (415) 692-4184; Washington, DC — International Systems Marketing: (301) 279-5775; Argentina — Itron SA: (01) 774-9369; Australia — Computer Clarity Pty. Ltd.: (02) 241 3385; I. O. Peripherals Pty. Limited: (02) 427 3555; Belgium — BELCOMP: 091 25 22 88; Canada — CAIL Systems: Toronto: (416) 362-1063; Denmark — ADCOM Data Aps: 1-19 44 66; Finland — Modulsystem OY: 0-6926511; France — Walton: (1) 226.06.90; Singapore — DTS Singapore: (65) 33-88-566; Switzerland — Mitek ag: 01 461 22 52; United Kingdom — Shandell Systems Ltd.: 02407-2027; Venezuela — H. Blohm SA: 2 541.21.22; West Germany — COMKO Computersystemges. mbH: 0221-48 30 51. DISTRIBUTORSHIP INQUIRIES INVITED.

data transfer) will become standard. Does natural-language processing technology have a place in relation to these other models?

Natural-language processing will be a complementary, rather than a competitive, component of future personal computer environments. The direct manipulation and mouse/window metaphors are best suited to performing many tasks and will retain a place as the method for performing tasks such as financial planning, data manipulation, and data maintenance. However, it is also true that the power of natural language makes it the method of choice for operations such as database query, analysis, and display.

The trend toward software integration is becoming prevalent in the personal computer industry. Various strategies for achieving integration include

- 1) the easy transfer of program control and data between applications such as in Lotus's 1-2-3
- 2) the extension of this concept into

a consistent operating environment such as Lisa or Visi On

- 3) the development of families of generic products from a single manufacturer, such as the Perfect series, the Easy series, etc.—these may have a common command structure across applications
- 4) the ability to integrate standard, off-the-shelf software products into an operating shell or environment such as Quarterdeck's DesQ

All of these approaches have benefits and drawbacks. Trade-offs must be made in flexibility, functionality, or compatibility. Specific trade-offs include a lack of choice—the application you want may not be available in the environment you've chosen; a higher price—the applications you need may be more expensive because they work in a special environment; and an inability to use software you currently own because it doesn't work in a particular environment.

A natural-language interface can enhance any of these models. English can exist as a layer under an operat-

ing shell to perform supervisory tasks. It can act as an integrator as well as a supervisor to facilitate communication and data transfer among different software products. It can act as the simple, easy-to-use human interface for people who want access to information without needing or wanting to become familiar with the underlying components.

As a result of the power of the English language to concisely express complex commands, a natural-language front-end can greatly simplify the amount and complexity of keystrokes or "mouse picks" necessary to perform an identical operation with non-English commands.

For example, consider a database consisting of a file with information on the Fortune 500 companies for 1981. Each record consists of the following fields:

Company Name	1981 Assets
City	1981 Income
State	1981 Equity
Industry	Number of Employees

SATISFY YOUR DRIVES!

70 MAIN/FRAMES & DISK ENCLOSURES FROM \$100

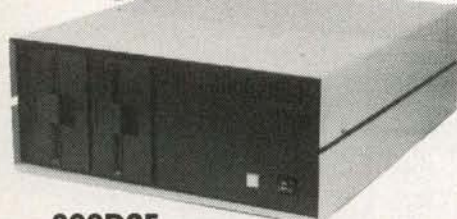

800D2F
5" Floppy Main/Frame
(10 cards) **\$392**

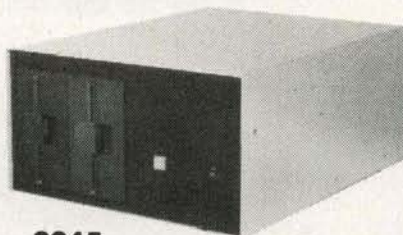

2215
5" Floppy Winchester
Main/Frame (7 cards)

\$380

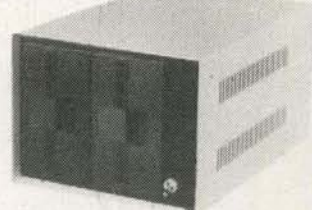

2905
5" Disk Enclosure **\$100**



Write or call for our brochure which includes our application note: "Making micros, better than any ol' box computer"

NEGRAND

8620 Roosevelt Ave./Visalia, CA 93291
209/651-1203

We accept BankAmericard/Visa and MasterCard

INTRODUCING
THE ONLY S100 BUS 16 BIT
SINGLE BOARD COMPUTER!

LOMAS DATA PRODUCTS PRESENTS:

THUNDER 186

THUNDER 186 provides the earth shaking performance you have come to expect from LOMAS DATA PRODUCTS, now in a full 16 bit single board computer. THUNDER 186 utilizes a highly integrated 80186 microprocessor from Intel to bring all the features required of an S100 bus computer system together on a single height IEEE-696 board.

The Thunder 186 features:

- 8 Mhz 80186 micro-processor (10 Mhz 8086 performance).
- Floppy disk controller, controls both 5 1/4" and 8" disk drives simultaneously.
- Two RS232 serial ports with full handshaking.
- One parallel printer port.
- Either 128K bytes or 256K bytes of no waitstate dynamic RAM with parity.
- Full IEEE-696 (S100) bus compliance.

THUNDER 186 is the only single board 16 bit computer that requires no additional boards to complete a functional system. THUNDER 186 is fully supported by our full line of operating systems: MS-DOS**, CP/M-86*, MP/M-86*, and CONCURRENT CP/M-86*, which are all available immediately. Thunder 186 includes CONCURRENT CP/M-86 in the low introductory price.

128K Byte version \$1250.00
256K Byte version \$1595.00

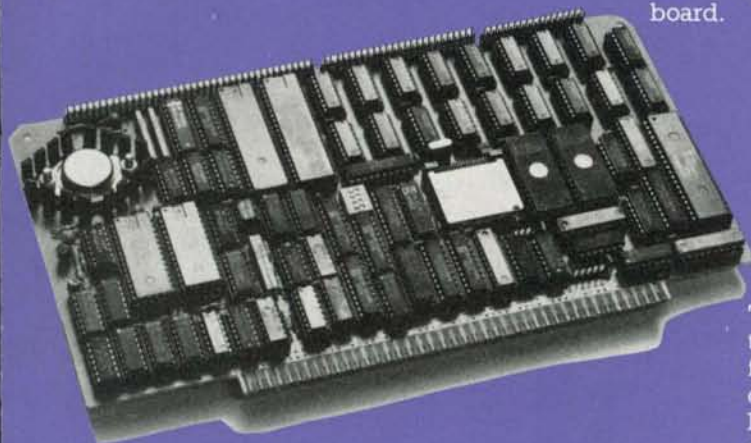

LIGHTNING 286

When we introduced our Lightning One*** in January of 1982 it was the fastest CPU board on the S100 BUS available. Now our Lightning 286 replaces the Lightning One as the fastest board on the S100 BUS. We have incorporated the Intel 80286 microprocessor on a CPU board that again brings new levels of performance to micro-computers. The 80286 is capable of supporting up to 16 megabytes of physical memory and up to 1 Gigabyte of virtual address space when utilized in virtual address mode. In real address mode, the 80286 is compatible with the vast library of 8086/88 programs already written. We have the three major operating systems available immediately on our Lightning 286, no need to wait for third party support to take advantage of this exciting new processor.

The LIGHTNING 286 features:

- Up to 64 Kbytes of onboard EPROM
- 9 Vectored interrupts expandable to 65 levels
- Full compliance with IEEE 696
- Multi-layer board for low-noise reliable operation

In addition to these features, a high speed memory bus expansion port has been included

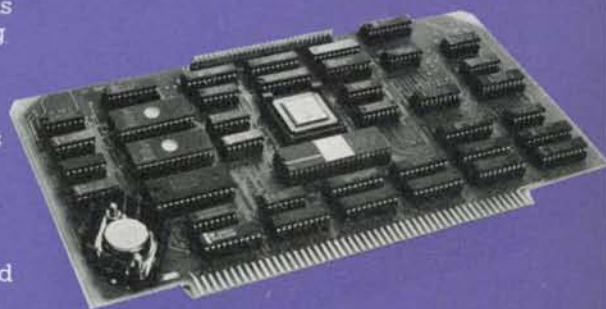

that will allow extension of the memory with a high speed dynamic memory board. The use of the companion memory board will allow use of an 8 Mhz 80286 without memory wait states. The board will contain 1 Mbyte of memory, and will allow cost efficient expansion of 80286 memory space.

Price \$1395.00

If your application requires 16-bit computing power and versatility, call Lomas Data Products today.

Dealer inquiries invited.

LOMAS DATA PRODUCTS, INC. □ 66 Hopkinton Road, Westboro, MA 01581 □ Tel: (617) 366-6434

LDP

*CP/M-86 and CONCURRENT CP/M-86 are trademarks of Digital Research. **MS-DOS is trademark of Microsoft. ***Lightning One is trademark of Lomas Data Products, Inc.

DIAMOND DELIVERS!

Supercalc 3 \$239
 Multiplan \$159
 Quadlink \$489
 Volkswriter Dlx \$179

dBase II \$259
 Infostar \$245
 Wordstar \$269
 Multitool Word \$379

	LIST	OUR PRICE		LIST	OUR PRICE
Micropro*			Lifetree*		
MAILMERGE	\$250	\$135	VOLKSWRITER	\$250	\$169
SPELLSTAR	\$250	\$135	Visicorp*	\$375	\$269
WORDSTAR/MAILMERGE	\$645	\$339	VISICALC IV	\$300	\$199
STARBURST	\$195	\$ 99	VISIWORD	\$300	\$205
SUPERSORT II	\$195	\$ 99	VISIFILE	\$300	\$205
			VISITREND/PLOT		
Sorcim*			VISISCHEDULE		
SUPERCALC	\$195	\$129	Condor*	\$650	\$399
SUPERCALC 2	\$295	\$169	CONDOR 20-3	\$425	\$299
SUPERWRITER	\$295	\$169	Supersoft*	\$500	\$359
Ashton-Tate*			FORTRAN		
dBASE-II	\$700	Scall	C COMPILER		
FRIDAY	\$295	\$199	Digital Research*	\$350	\$259
			CONCURRENT CP/M 86	\$400	\$269
Fox & Geller*			PASCAL MT+ 86	\$200	\$145
QUICKCODE	\$295	\$ 59	C BASIC 86	\$200	\$215
dUTL	\$ 99	\$199	SPP	\$300	\$279
dGRAPH	\$295	\$199	ACCESS MANAGER	\$400	\$ 99
			DISPLAY MANAGER	\$150	\$359
Lexisoft*			C BASIC	\$500	\$ 44
SPELLBINDER	\$495	\$239	CB 80	\$ 60	
Microsoft*			CP/M 86		
SOFTCARD	\$345	\$249	Softword Systems*	\$495	\$325
MOUSE	\$195	\$139	MULTIMATE		
MULTITool WORD	\$495	\$ 69	Quadram*	\$295	\$225
W/MOUSE	\$100	\$109	QUADCOLOR	\$395	\$279
MULTITool FINANCIAL	\$150	\$249	64K EXPANDABLE BOARD	\$595	\$425
MULTITool BUDGET	\$350	\$249	256K		
PASCAL	\$350	\$349	Hercules*	\$499	\$355
FORTRAN	\$500	\$269	GRAPHICS CARD		
C COMPILER	\$350	\$289	Ast*	\$395	\$269
BASIC 80	\$395	\$409	6 PAK PLUS-64K		Scall
BASIC COMPILER	\$645	\$459	ALL OTHER BOARDS		
SOFTCARD PLUS	\$695	\$339	Hayes*		
PREMIUM SYSTEM	\$495		SMARTMODEM 1200	\$699	\$499
PREMIUM SOFTCARD IIE			SMARTMODEM 1200B	\$599	\$429
Information Unlimited*					
EASYWRITER II	\$350	\$199			
EASYSPELLER II	\$225	\$129			
ACCOUNTING SERIES	\$595	Scall			

At Diamond Software we offer the best selling business application software for your IBM PC, CP/M or Apple Computer at the lowest possible prices. And we maintain a complete technical department to assist you before, during and after your system purchase. Not only that, we offer same day shipment on most items and we accept Visa, Mastercard and also American Express. We'll even pay the shipping charges if you send us a money order, cashiers, company or personal check. Purchase orders are gladly accepted from qualified organizations and we welcome dealer inquiries. Call Diamond today, you'll be glad you did.

TO ORDER CALL TOLL-FREE 1-800-227-0545



Diamond Software Supply 484 Lake Park Ave., Suite 123 • Oakland, CA 94610

For price quotes, information, or in California call 1-415-893-7676. We credit your order for the call. Technical Department (415) 893-7678. International Telex 338139 (attn. 149)

Support, Service and Price.

Shipping/Handling UPS surface \$3.00 plus an additional \$3.00 per item for UPS Blue. C.O.D. orders add \$4.00. For personal check allow 2 weeks for delivery.

Of these fields, the state, industry, and 1981 income are indexed.

Let's compare the command sequences necessary to perform database retrieval and analysis with dBase II vs. the natural-language query system, Intellect.

In order to find the companies located in California with sales over \$10 million, dBase II requires that we type

```
LIST ALL COMPANY, STATE,
SALES81, FOR STATE='CA'
.AND. SALES81 > 1000000
```

With English query, it is possible to type

"List the companies in California with sales over 10,000,000."

or

"CA with sales over 10,000,000."

(This question can be phrased several ways to obtain the correct answer. Note, too, that the inflection of the word "companies" to "company" is implicit in English but must be the exact field name in dBase II.)

The advantage of natural language is most apparent when further selection criteria or substitutions are desired. For example, if you want to add the selection criterion of companies employing over 10,000 people to the previous question, with dBase II you must reenter the complete query with the new selection criterion:

```
LIST ALL COMPANY, STATE,
SALES81, FOR STATE='CA'
.AND. SALES81 > 1000000
.AND. EMPLOY81 > 10000
```

With English, we can type

"Also over 10,000 employees."

To substitute Illinois for California, the entire query would need to be re-typed with "STATE='IL' in dBase II. With English, we can type "in Illinois" or "in IL."

The natural-language system can

further summarize the data—ranking, averaging, and doing comparisons as well as producing pie charts, bar graphs, and histograms. It can also format the data for output to a report or graphics package. These examples demonstrate that natural-language technology has a place in the personal computer market.

What is required to make this current level of mainframe performance available to today's microcomputers? Before the advent of 16-bit systems with increased memory, hard disks, and faster microprocessors, the most serious problem was simply one of size. However, computers such as IBM's PC XT and Apple's Lisa clear-

The advantage of natural language is most apparent when further selection criteria or substitutions are designed.

ly have the horsepower to run large, complex programs. In fact, the amount of computation available to a personal computer user may exceed the share of resources available to a timesharing user on a large mainframe.

The most serious issue with making natural-language query systems available to personal computer users is the same issue that concerns any effort to make mainframe technology available—the necessity to make the entire system usable by a person who is not a data-processing professional. In the mainframe arena, there is often a clear distinction between the people who have a need to query the information base and those responsible for creating and maintaining it. While there will certainly be cases in which personal computer users want to query data prepared by some other person or group, a common case will be the one in which a single individual is the user of the information and the database designer, data-entry clerk, and system programmer. In order to allow this "jack of all trades" to easily define, create, main-

tain, and query databases in natural languages, one approach is being taken by Symantec, a company founded by Gary Hendrix from the Stanford Research Institute. In this system, all the functions a user desires are part of the natural-language system itself. This approach is somewhat analogous to the 1-2-3 system, in which all functions are provided under a single umbrella.

Another approach is being taken by AIC in its development of a personal computer version of Intellect. This approach involves interfacing on the input side with popular personal computer database systems such as dBase II. On the output side, Intellect will allow data to be displayed by already existing personal computer graphics packages and even by a spreadsheet package such as Visicalc, Multiplan, or 1-2-3. This approach enables users to preserve their existing investment (of both dollars and time) and permits use of the "best" technique for getting the job done. Data may be retrieved and summarized by Intellect and then presented to a spreadsheet for further manipulation.

A problem with this approach is integrating the database system's definition of a concept (such as a field or a value) with that of the natural-language system. On the mainframe side, this job has traditionally been done by support personnel in the DP group. On the personal computer side, the user will have to perform this integration.

Let's say, for example, that we have a database of all the personnel in a small company. The data includes name, job, age, salary, address, department, date hired, and so on. We assume that the system has access to all the information in the database (such as the name of each field and its contents). When the user first sits down with the system, he might type

"List the earnings of everyone in the shipping department."

Since the system knows only the names of the fields in the database system, it would not know the word

**Heart of TEXAS
COMPUTER SYSTEMS**

TRS-80

Model IV Portable: CALL
Model 12 & 16 at discount: CALL
TCS Model 12 with 2 drives: \$2995
Model 12/16 Accessories/discount.
TCS Model IV, 64K, 2 Drive w/RS-232
\$1499 (40 track) \$1699 (80 track)

The New TRS-2000: CALL
(IBM Compatible)
We carry the full TRS-80 line. Call for our discount prices

DISK EXPANSION

	M-III	M-IV
1 Controller, Pwr.Sup. Hdw., Instruct.	\$249	\$320
2 Kit 1, plus 1/40-trk.Tandon Dr.	\$429	\$470
3 Kit 1, plus 2/40-trk. Tandon Dr.	\$598	\$640
3a Kit 3 w/2 80 trk.drives (dual sided 40s)	\$698	\$720

Model IV needs 64K to operate. For 64K Kit, CALL.

Tandon

Quality disk drives—O.E. brand on IBM Available bare and in cabinets.
TM50-1 SS Slimline: \$145
TM50-2 DS Slimline (IBM): \$209
TM100-1: \$159 CALL US IF YOU FIND LOWER PRICES!
TM100-2: CALL

CORVUS

25% OFF LIST PRICE!

OMNINET- A high speed multi-user network that connects several computers for instant communication up to 4,000 feet away.

Save over \$1,000 on a 20 mg. Corvus Hard Disk system for IBM PC and other computers.
5mg. \$1649 10mg. \$2279 20mg. \$3049

DAVONG Systems, Inc.

Single user or networking hard disk system for IBM & Apple. Lowest prices anywhere. **Priced from \$1375.** 10, 15, 21, 32 mg. & cartridge tape backup—CALL.

Star PRINTERS

Fast, dependable, versatile, low price.
Gemini 10X 9in., 120cps, Friction/Tractor
Gemini 15X 15in., 120cps, Friction/Tractor
Delta 10 10in., 160cps, Friction Tractor
Delta 15
PowerType Daisywheel
Call for our low, low prices!

DISKETTES \$1.50 ea.

CompuDisk, top quality mini floppy diskettes from \$1.50 complete with hub rings, protective envelopes, write protect tabs, and adhesive labels. SSDD, DSDD, boxed or in bulk. Money back guarantee. **100% Certified Error Free. CALL!**

**Heart of TEXAS
COMPUTER SYSTEMS**

P.O. Box 1327 Arlington, TX 76004
Toll Free 1-800-433-5184
Texas 1-817-274-5625

VISA, MC, cashier's check, money order. No tax out of state. Texans add 5%. Prices subject to change.

SPECTACULAR OFFERS

wabash

6 YEAR WARRANTY

M11	5 1/4"	SINGLE SIDE SINGLE DENSITY	1.49*
M13	5 1/4"	SINGLE SIDE DOUBLE DENSITY	1.89*
M14	5 1/4"	DOUBLE SIDE DOUBLE DENSITY	2.79*
M16	5 1/4"	DOUBLE SIDE QUAD DENSITY	4.19*
F111	8"	SINGLE SIDE SINGLE DENSITY	1.89*
F1312	8"	SINGLE SIDE DOUBLE DENSITY	2.39*
F144	8"	DOUBLE SIDE DOUBLE DENSITY	2.99*

maxell

LIFETIME WARRANTY

MD1	5 1/4"	SINGLE SIDE DOUBLE DENSITY	2.09*
FD1-128	8"	SINGLE SIDE DOUBLE DENSITY	3.60*

BASF

2 YEAR WARRANTY

54968 5 1/4" ss,dd 1.79*

53428 8" ss,dd 1.89*

BASF

LIFETIME WARRANTY

54974 5 1/4" ss,dd 2.19*

54998 8" ss,dd 2.29*

TDK

LIFETIME WARRANTY

2501 5 1/4" ss,dd 2.39*

2801 8" ss,dd 3.90*

SENTINEL

LIFETIME WARRANTY

5S-11 5 1/4" ss,dd 1.59*

8S-11 8" ss,dd 2.14*

WE ALSO STOCK AT FANTASTIC LOW PRICES

Memorex

FLOPPY

3M

DYSAN

ULTRA

MANIFEST

Floppies, Tape, Data Cartridges, Data Cassette, and Disk Packs

* QUANTITY 100. SMALLER QUANTITIES ADD 5%

DISK DRIVE HEAD CLEANING KITS

5 1/4" 15.95

C-10 CASSETTES

Get 8 cassettes,
and Cassette/8
Library
Album 8.00

SNAP-IT POWER CENTER

Turn one outlet into six!
Power Surge Control
RFI Filtration
15 Amp Circuit Breaker 59.95

LIBRARY CASES

8" Kas-sette/10 2.99
5 1/2" Mini Kas-sette/10 2.49

BOOK VALUES

FULL SELECTION,
DISCOUNT PRICES

on hundreds of
titles published by
ALFRED, HAYDEN,
DILITHIUM, SAMS,
TAB, McGRAW HILL
and many others.

SOFTWARE

AT FANTASTIC PRICES

SAVE 25% OR MORE
on thousands of soft-
ware packages for all
systems, including
Business, Language,
Engineering, Games,
Graphics, Utility, and
many more.

* Written purchase orders accepted from government agencies and well rated firms for net 30 day billing. * International orders accepted with a 15.00 surcharge for handling, plus shipping charges. * C.O.D. requires a 10% deposit. * We accept Visa, MasterCard, Money Orders, and Certified checks. * Checks require bank clearances. * All shipments F.O.B. San Diego. * Minimum shipping and handling 2.00, minimum order 10.00. * California residents add 6% sales tax. Prices and terms subject to change without notice. * All sales subject to availability, acceptance, and verification. * All sales are final. * Satisfaction guaranteed or full refund.

We also offer printer ribbons, printwheels, type elements, equipment covers, power consoles, paper supplies, storage and filing equipment, furniture and many other accessories for word and data processing systems. Write for our free catalog.

Orders Only
800-854-1555Information
619-268-3537Modern Hotline (Anytime)
619-268-4488
Exclusive Monthly Specials

ABC

DATA PRODUCTS

ITT TELEX 4992217
8888 CLAIREMONT MESA BLVD
SAN DIEGO, CALIFORNIA 92123

"earnings."

The system must give the user a choice as to what the unknown word "earnings" means. It could simply be a misspelling of some word the system knows. Or, as in this case, the user intends the word as a synonym for the already known word "salary." If the user were to type "List all the executives," the correct definition of "executive" might be anyone who has the title of president, vice-president, or director.

The system "learns" the vocabulary of the user over time. This is, of course, the most basic form of learning ("learning by being told") and is, in fact, how people acquire much of their knowledge.

The personal computer version of Intellect—which will be written in PL/I, as is the mainframe version—is currently under development. The product will be ready for shipment in 1984. An IBM PC with 512K bytes of memory and a hard disk will be the minimum initial target machine.

Business people are the target users of a PC version of Intellect. They require access to information stored in both mainframe and microcomputer databases. They also need timely and flexible analysis and display capabilities. A concurrent or multitasking operating-system environment will best provide this flexibility. The use of windows and pointing devices (mice) may also contribute to this environment. Users need the ability to search a database while concurrently examining a spreadsheet or printing a report.

It is planned that the initial version of Intellect will integrate English query with several popular commercial microcomputer and mainframe DBMS packages and provide output to popular graphics and spreadsheet programs for further data analysis and manipulation. In most cases, AIC intends to integrate its natural-language technology with existing applications software rather than develop a proprietary line of applications. In some cases, AIC may choose to enhance a capability of an existing product rather than, or in addition to, interfacing with a third-party package.

Intellect allows the end user to dynamically and interactively enhance the vocabulary and concepts available to Intellect. It will permit users to create and populate a new database or use data definitions previously defined in a DBMS or file manager. A future goal of the product is to allow all user customization and fluency enhancements to be performed interactively. Another planned enhancement is to allow users to dynamically modify as well as query data.

Summary

We have seen examples of the current level of natural-language technology in the mainframe world and examined its place in the personal computer environment. This technology will not replace the "direct manipulation" paradigm but rather complement it, giving the user a choice of the best tool to accomplish a particular task. Given the power of today's personal computers, it is only a matter of time before several natural-language systems will be available. ■

References

- Harris, L. R. "A Model for Adaptive Problem Solving Applied to Natural-Language Acquisition." TR 72-133. Cornell University: Department of Computer Science, 1972.
- Hendrix, Gary, and Earl Sacerdoti. "Natural-Language Processing: The Field in Perspective." BYTE, September 1981, pages 304-352.
- Winograd, T. *Understanding Natural Language*. New York: Academic Press, 1972.
- Wolf, A. K., C. S. Chomsky, and B. F. Green. "The Baseball Program: An Automatic Question-Answer." TR 306. Lexington, MA: Lincoln Laboratory, 1963.
- Woods, W. A., R. M. Kaplan, and B. Nash-Webber. "The Lunar Sciences Natural-Language Information System: Final Report." BBN Report 2378. Cambridge, MA: Bolt Beranek and Newman Inc., 1972.

Jane Eisenberg is product director at Artificial Intelligence Corporation (100 Fifth Ave., Waltham, MA 02254). She received a B.S. from Cornell University and an M.S. in molecular biology from Boston College.

Jeff Hill is director of research and development at Artificial Intelligence Corporation. He received B.S.E.E. and M.S.E.E. degrees from MIT, where he was involved in natural-language research at MIT's Artificial Intelligence Laboratory.

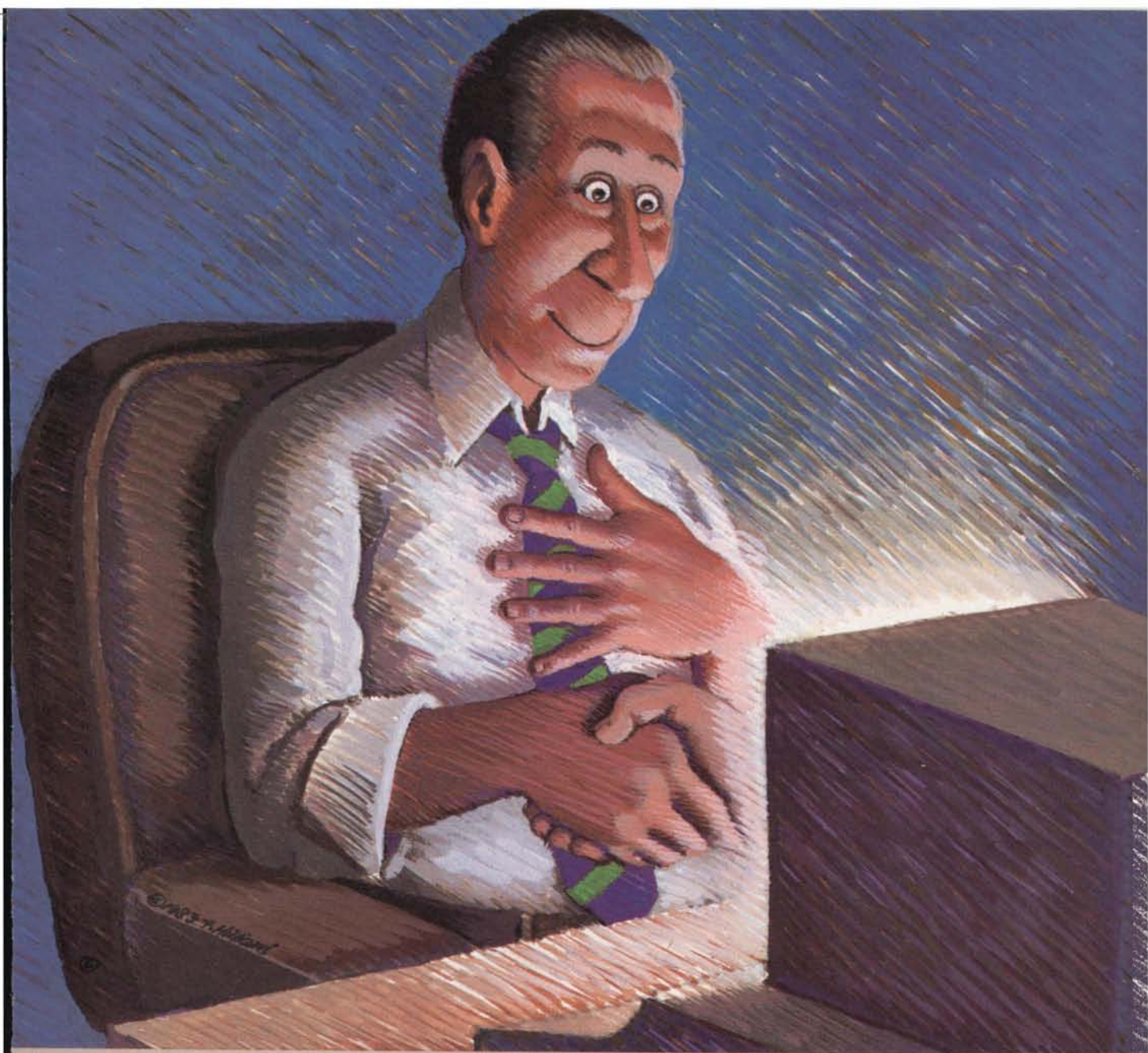

Encounter REVELATION

For \$950, Revelation Software by Cosmos will give your PC capabilities that no microcomputer has ever had before. Through a versatile, high performance Relational Data Base Management System developed by Cosmos, Revelation will give your microcomputer all the power and sophistication of a minicomputer.

Revelation features a data base with variable-length fields and records, (up to 64K), and unlimited files and accounts. File size is

limited only by disk size.

Also featured: A powerful, hybrid programming language.

A fourth generation applications and program generator
Our programs write programs!

Communications functions that give your PC the power to utilize applications, programs, and data from thousands of existing mainframe and minicomputers.

8087 math chip support

Revelation co-exists with MS/DOS™ or PC/DOS™ 1.0, 1.1,

2.0 versions, and is compatible with the IBM PC™ XT™ COMPAQ™, Corona™ Columbia Multi-Personal® and the Eagle 1600™. It's also compatible with minicomputers utilizing the PICK Operating System™. Minimum configuration requires 320K memory and 8087 math chip.

MS/DOS™ of Microsoft Corp. IBM PC Registered TM of International Business Machines Corp. COMPAQ™ of COMPAQ Computer Corp. PICK Operating System™ of

PICK SYSTEMS. Eagle 1600™ of Eagle Computers. Corona PC™ of Corona Data Systems. Columbia Multi-Personal™ of Columbia Data Products Inc.

COSMOS

P. O. Box AH, Morton, WA 98356

Circle 116 on inquiry card.

Telephone 1-800-422-2511
Inside Washington 206-496-5974.

Others say, "The Sky's the Limit."
We go one step beyond.

Add up to 256K of memory
in 64K increments to your
IBM PC or XT

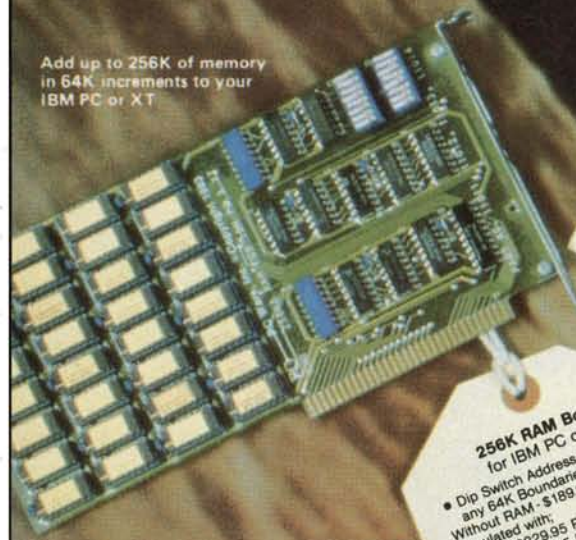

256K RAM Board
for IBM PC or XT

- Dip Switch Address Selectable on any 64K Boundaries
- Without RAM - \$189.95 Part No. 11010
- Populated with:
 - 64K \$229.95 Part No. 11011
 - 128K \$269.95 Part No. 11012
 - 192K \$309.95 Part No. 11013
 - 256K \$349.95 Part No. 11014

This board maintains the time and date for your IBM PC or XT so you don't have to enter it when you turn the computer on. Features snap in battery holder. Battery and software included.



CLOCK CALENDAR
for IBM PC or XT

- DOS compatible
- Comes with software driver
- Will fit in any slot including the small slot in back corner
- 3 yr. Lithium battery backup

Part No. 21050 \$74.95

Connect any parallel device such as a printer to your IBM PC or XT.

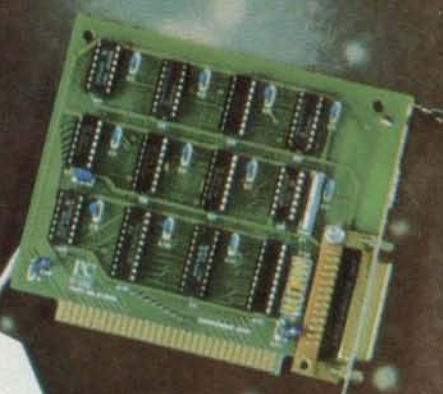

PARALLEL PRINTER ADAPTOR
for IBM PC or XT

- Fully IBM Compatible
- May be used as a general purpose I/O port
- 12 buffered TTL Latched outputs
- 5 buffered TTL inputs
- Fully software programmable
- Software controlled interrupts
- Reset of target peripheral/device with system
- Industry standard D-shell connector for I/O

Part No. 21020 \$89.95



SERIAL COMMUNICATIONS ADAPTOR
for IBM PC or XT

- Fully IBM compatible
- Asynchronous EIA RS-232C I/O mapping (Jumper)
- Fully software programmable transmit, receive, error, line status and data set interrupts
- Diagnostic capability to provide logback functions for transmit/receive and input/output signals (or equivalent)
- Powerful Intel INS8250 UART
- Supports full or half duplex
- Simple DCE/DTE configuration header
- Crystal controlled baud rates, software programmable from 50 to 19200 including 134.5
- Programmable control register
- Parity, overrun, and framing error checks
- Data is double-buffered
- External receiver clock input available
- Modem control functions supported (e.g. CTS, RTS, DTR, RI and carrier detect)
- False-start bit detection
- Line-break generation and detection (Jumper)
- Choice of 4 handshake signals
- DSR* and/or CTS* hardware override (Jumper)

Part No. 21010 \$94.95

Connect any serial device such as a printer, modem, plotter, mouse, terminal, etc. to your IBM PC or XT.

PC
PERSONAL COMPUTER
WARE

PC Ware, Inc.
Dept. 2
4883 Tonino Dr.
San Jose, CA 95136
(408) 978-8626

TO ORDER

In USA shipping paid by us for orders pre-paid. We accept C.O.D. orders (U.S. only). For VISA or MASTERCARD shipping charges will be added. CA residents add 6.5% for tax. Outside USA add 15% for shipping and handling. Payment must be in U.S. funds. Dealer inquiries invited. One year warranty.



WHEN YOU'RE READY OUR PC PLUS KIT WILL BE WAITING



10mb Internal Upgrade

When you're ready to boost your storage capacity from 640K to 10mb without boosting power and without eating up desk-top space, our internal **PC PLUS** will be just a phone call away.

Waiting to give you all the capacity of the *XT at a price that saves you hundreds of dollars compared to the cost of trading up.

The **DSS PC PLUS** kit uses a half-height 10mb Winchester disk drive that gives you all the benefits of Winchester technology — increased data integrity,

faster access — without taxing the power supply. It also includes a Winchester disk controller that is IBM formatted.

The **DSS PC PLUS** kit presents the storage solution you need now. What are your data storage needs? At **DSS**, we do much more than sell components. We create solutions.

The **DSS PC PLUS** kit includes:

- 10mb half-height disk drive
- **DSS** Controller
- Full height front bezel
- Mounting hardware
- Cables

Features and Benefits

- Increased capacity
- Increased access time
- Upgradeability
- No additional power requirements
- Enhanced cooling
- One board controller solution
- Operates with 1.25 MS-DOS through 2.0 MS-DOS
- Internal upgrade
- 1 10mb half-height Winchester = 31 floppy's
- Increased data integrity

Retail price: \$2250
from the dealer nearest you

DSS

2907 N. 55th St., No. 5 Boulder, Colorado 80301 303/449-7587 Toll Free: 800-851-PLUS
Data Storage Solutions, Inc.

*XT is a registered IBM trademark

Portables—1984 and Beyond

Idea-Processing Software and Portable Computers

The new wave of computers demands new software

by David Winer and Peter Winer

Imagine you've arrived at a business appointment 10 minutes early. Instead of killing time flipping through a magazine, you reach into your briefcase and pull out a portable computer. You turn the power on and move the cursor through an outline of the points you want to cover in the meeting.

After a small reorganization (you wanted to discuss the project schedule after discussing personnel requirements), you move the cursor down to the financial-projections section and press the key marked Spreadsheet. Instantly, a small window opens up on the screen, and you try a few calculations and decide that your assumptions make sense. Turning the power off, you spend the next five minutes browsing through a magazine.

In 1977, Alan Kay (then at Xerox's Palo Alto Research Center and now chief scientist at Atari) speculated about the design and use of portable computers. It was just speculation then, but now, in 1984, it's real—people are buying and using portable computers that are very much like the "Dynabook" that Kay described.

1984 is the year that the personal computer leaps off your desktop and into your briefcase, your knapsack, or your shopping bag. Before facing the wide-open future of software for portable computers, let's look at the history of portable computing.

A Short History

The first portable computers existed before personal desktop computers, before Wordstar and Visicalc and even CP/M. Texas Instruments' Silent 700 terminal, with a built-in modem, a full keyboard, and a thermal printer, was portable, even though it weighed almost 50 pounds. It had a handle on it; you were *supposed* to carry it around with you. In 1973, some people actually did, risking sore arms and back. The convenience of carrying around computer power was worth some discomfort.

Then came the personal computers, desktop machines made by Apple, Commodore, Radio Shack, then IBM, and so on. By 1981, some even had handles (e.g., Osborne and Kaypro). This meant you could carry "transportable" desktop-computer

power somewhat less painfully (the Compaq Portable Computer, introduced in 1982, weighs only 28 pounds).

Transportables aren't fully portable. Like old tabletop radios, they're too heavy to be carried conveniently, and they must be plugged into a wall socket. Transportables haven't begotten new types of software; they come bundled with the usual desktop software (word processors, spreadsheets, database packages) and the usual software support structures (CP/M on the low end, spelling checkers and program generators on the high end). So much software comes bundled with the transportables that the market for software specific to them has never developed substantially. Even Compaq, which bundles only the operating-system software and a disk-based version of BASIC, has little software built specifically to exploit its transportability.

This trend is not surprising. The manufacturers of transportables spend a lot of advertising dollars to portray their machines as nothing more, nothing less, than transportable clones of the desktop machines

they are emulating. This is an effective short-term strategy, but in the long term it has caused software manufacturers to ignore the special communications capabilities that many transportable units have.

In 1983, the first useful portable computer, the Radio Shack Model 100, was introduced. Manufactured in Japan by Kyocera and marketed in the U.S. by Tandy, the Model 100 has caught on in a spectacular manner and points the way toward truly convenient portable computing.

A Successful Design

Why was the Model 100 such a breakthrough? Basically, there are three reasons: its screen, its keyboard, and its software. Before the Model 100, portables typically had much smaller liquid-crystal display (LCD) screens. The Epson HX-20 with its 4-line by 20-column display can't compare with the 8-line by 40-column display of the Model 100. For most people a 4 by 20 display isn't big enough. An 8 by 40 screen is barely adequate, but on the Model 100 it is workable. The smaller screens on other computers fail to meet the requirements of effective personal computing.

The keyboard on the Model 100 uses the standard QWERTY layout and has eight function keys, four arrow keys, and several dedicated function keys. You can touch-type on this keyboard; the full-size keys have a solid feel.

The system software of the Model 100 is stored in ROM (read-only memory). Turning on the machine automatically takes you into the top level of this software. From there, you can move a cursor over a menu of files, which can be BASIC programs or text files. You can edit a text file, run a BASIC program, or search a text file in several ways. Terminal software is included, enabling file transfers over the built-in modem, serial port or parallel port, and remote access to computer networks and bulletin boards.

Although significant, the Model 100 is just a transition product. An effective portable of the future will have a full 25 by 80 screen, more memory,

a 16-bit processor, and software that is better adapted for portability. The year 1984 is when such a portable, weighing less than 10 pounds, will appear on the market. How will such a computer fit into our lives?

Applications

Clearly, as the Model 100 illustrates, software for portable computers is different from software for desktop computers. The companies behind the machine invented a new style of portable computer—one intended to assist in a broad range of applications including BASIC programming, text editing, appointment scheduling, name and address lookup, and communications.

Let's consider the problem of designing software for the ideal portable, one with sufficient memory (say 256K bytes) a faster processor (8086 or 68000), a larger screen (25 by 80), and maybe even a disk drive.

Although significant, the Model 100 is just a transition product.

How would software for this portable be designed?

Before implementing the first prototype, any good software designer will sit down and pose a few crucial questions dealing with the "who, what, why, and where" of the software product.

Who will be using the software? How much experience do they have with personal computers? How old are they? Are they male or female? How much education do they have? How much money do they make?

What will they do with the software? Should the software be targeted at a particular task?

Why are they using the computer instead of paper and pencil?

Where will the computer be used? Now that we're designing software for portable computers, we have to consider "laptop," "bedtop," "beachtop," "coffee-tabletop," and "floortop" use.

To be effective, the software for a portable computer has to be adaptable to a variety of situations, there-

fore it has to accommodate a variety of information structures. Stand-alone software that's simple enough to be used on the run must also be capable of producing sophisticated results. It must be simple, with small reference cards instead of extensive users manuals. The best portable software will appeal to the same broad market in which Atari and Coleco video-game machines sold in 1981. Simplicity will be one of the most significant factors in the success of portable software.

Our informal interviews with users of the Model 100 have yielded some clues to the who, what, why, and where of portable software.

Today, the primary users of portable computers are people who also use desktop computers. Therefore, a highly valued feature is the ability to upload and download information between the portable unit and the desktop unit. But eventually, just as portable radios and portable cassette players created their own markets, portable computers will appeal to people who aren't currently using desktop computers.

Most Model 100 owners use the machine for fact gathering, notetaking, simple calculating, organizing, and thinking, with little or no BASIC programming. (Many said they use the BASIC interpreter as a calculator, for computing ratios or summing numbers.) Our interviews indicated that the text editor is the program used most often; name/address lookup and scheduling are the programs used least often. There was not much demand expressed for full-blown word-processing, and spreadsheet capability was considered important only by "spreadsheet people." The need for a relational database package (such as dBASE II and PFS) was expressed by consultants with extensive bases of information to draw from.

Most users said they enjoy the convenience of a portable computer. Portables are also used to fill small gaps of time, time that would otherwise be wasted. There seems to be no limit on where a Model 100 is used: airplanes, podiums, parties, waiting rooms, restaurants, and hotel rooms.

A Design for Portable Software

Now we have a feel for the who, what, why, and where of portable computing. After talking with users of the current technology, we're ready to embark on some speculation about the future of portable software.

Will conventional database managers be the best operating software on portables? Probably not. Database-managing packages require that organization be preplanned, that all manipulation of structure take place before any information is entered. Database products such as dBASE II and PFS require that each fact or idea fit into a given layout or "template." The implementation of this type of database, no matter how user-friendly, can serve effectively only for applications such as accounting, mass scheduling, and mailing lists, in which the format of all information can be determined in advance.

More appropriate for the user of a portable computer is a database system that accommodates flexible organization and reorganization of concepts, ideas, or outlines and is not

limited to records, fields, and files. A system should let a small section be reorganized without affecting material in other sections of the database.

Using such an "idea-processing" software package is the opposite of production-oriented software or "productivity software." Word processors, a prime example of production-oriented software, take finished presentations and turn them into attractive printed documents. Taken to the limit in a desktop environment, word processing incorporates graphics and typesetting capabilities—advanced features, yes, but the wrong set of features for idea processing. The right features for idea processing are "soft" concepts such as outlining, structural editing, and easy manipulation of displayed information.

Idea-processing software supports brainstorming, fact compilation, organizing, and reorganizing. Idea processors exist in the noncomputer world; for example, notebooks, index cards, blackboards, and appointment

books are all idea-processing tools, much as a typewriter is a noncomputer word processor.

Good idea-processing software supports the belief that the world is a chaotic, disorderly, rapidly changing information structure, not a predictable table of rows and columns. With an idea processor you can easily add new facts and ideas and then painlessly reorganize the rest of your model to reflect the change. Idea processing does not exclude the need for word processing; it's useful to have a link between a portable idea processor and a desktop word processor.

Dimensions of the Portable Industry

We've mentioned two portable machines, the Radio Shack Model 100 and our hypothetical 16-bit, 256K-byte, 10-pound "ideal machine." But there are many other machines that qualify as truly portable: the Gavilan, Convergent Technologies' Workslate, GRID Systems' Compass, Sharp's PC-5000, as well as others that are just being introduced. (See Septem-

Our Specialty: 68000, 6809 CPU, graphic, database, communication, export

Come visit us in our New York City Showroom *IBM COMPATIBLE

PRINTER	
MICRO-PRISM	110 cps, 84x84, graphic... 459
EPSON	RS-232/parallel, pin & friction
BANANA	FX-80, FX-100, RX-80... CALL
OKIDATA	50 cps... 205
	ML 84 parallel... 960
	92 parallel... 470
	93 parallel... 730
PRISM 132	200 cps, 132 col... 1,100
TOSHIBA	160 cps max 24-wire head... excellent letterquality... 1,576
GEMINI	Delta 10... 525
DIABLO	P11 100 cps, 80 col... 488
	P38 400 cps, 132 col... 1,795
Letter Quality	
NEC	2050 20 cps for IBM... 975
	3550 35 cps for IBM... 1,835
	7710 55 cps for serial... 2,150
DYNAX	HR25 23 cps parallel... 799
	DX15 13 cps... 475
COMREX	Comwriter II... 499
C.ITOH	F-10 40 cps Excellent... 1,150
DIABLO	630 API w/interface... 1,899
QUME	11+ 40 cps... 1,350
	50 cps... 1,595

TERMINAL/MONITOR	
ZENITH	Z-29 smart terminal. BEST PRICE
ZVM 135	*RGB color/green monitor... 495
ZVM 123	*green monitor... 119
HAZELTINE	Esprit II... 560
	Esprit III... 625
WYSE	50... 585
VISUAL	55... 725
102	VT-100/VT-102 compatible... 895
graphic	emulate Tektronic 4010/4014
OPTION	... 695
QUME	102... 520
	103 132 col... 890
	108 A amber... 750

COMPUTER	
COLUMBIA	*128K RAM, two floppies, monitor keyboard, softwares
CORONA	*128K RAM, two drives, 640x325 graphic, monitor, MSDOS, PC TUTOR MultiMate word processing, BASIC
CROMEMCO	*C-10 64K RAM, monitor, Z-80 CPU keyboard, software
DEC	64K RAM, Z-80 & 8088 CPU, monitor
RAINBOW	keyboard, CP/M86-80
EPSON	256K RAM, monitor, keyboard, two floppies
QX-10	RX-80 printer, CP/M Valdocs, Peachtree 5000 pak
EAGLE	*128K RAM, two floppies, software

FOR IBM PC

PLANTRONICS colorplus 16 color with graphic software & parallel port LNW I/O & RAM module

POWERFUL 68000 CPU	
Cromemco	256K RAM 68000 & Z80... 4,396
CS1D2E	two 5 1/4" floppies
DUAL	68000 CPU, 80MB SMD hard disk intelligent I/O, UNIX, Database
WICAT	1 to 12 users, 68000 CPU, 256K to 4.5MB RAM, 10MB to 474MB hard disk, graphic

PORTABLE ON-THE-GO

Columbia, Corona, Televideo Teleporta Software and other equipment... CALL

PLOTTER/DIGITIZER	
HOUSTON INSTRUMENT	DMP 29... 1,795
	DMP 40... 795
	DMP 41, DMP 42... CALL
	HIPAD digitizer... 725
AMDEK	XY plotter 1 pen... 665
	6 pens... 1,095
MT PLOTTER	PIXY-3 3 pens... 650

MODEMS	
HAYES	Smartmodem 300/1200 bps... 520
	Micromodem II w/software... 270
NOVATION	Smartmodem 300/1200 bps... 455
LEXICON	300 bps acoustic coupler... 145
USR	Password 1200/300... 375

MITSUBISHI	
8" DS,DD Qume & Shugart compatible	
M2394-63	bare drive... 390
M2396	slimline bare drive... 410
Cabinet for dual 8" full size... 250	
Cabinet for dual 8" slimline... 200	
Cable	... 50 Manual... 25
BASF Disk drive 5 1/4" SS,DD include cabinet, power supply and cable at 50% OFF ONLY \$95.00 (limited qty)	

SALES

Prices subject to change. American Express, Visa/Mastercard add 3%. F.O.B. point of shipment. 20% restocking fee for returned merchandise. Personal checks take 3 weeks to clear. COD on certified check only. N.Y. residents add sales tax. Manufacturers' warranty only. International customers, please confirm price before order. Accept P.O. from Fortune 500, schools and gov't.

Computer Channel
21-55 44th Road
Long Island City, NY 11101

TELEX:
429418
CSTNY

For information CALL (212) 937-6363
To order CALL 1-800-331-3343

Computer Channel

We make C easy...



and work!

Eco-C compiler...we've got it all.

Whether you're a seasoned professional or just getting started in C, the Ecosoft C compiler has everything you'll ever need.

COMPLETENESS:

Our Eco-C compiler is a complete implementation of C and supports all operators and data types (including long, float and double).

EFFICIENCY:

The compiler generates extremely efficient Z80 code using Zilog's mnemonics. On the benchmarks tested, typically we finished either first or second using substantially less generated code.

PORTABILITY:

The Eco-C library contains over 100 functions that are UNIX V7 compatible, and includes a complete transcendental package. Programs developed with the Eco-C compiler can be moved to virtually any system with little or no change.

EASE OF USE:

The Eco-C compiler includes Microsoft's MACRO 80 assembler, linker, library manager and supporting documentation. The assembler (M80) generates industry-standard REL file output. The linker (L80) is fast and uses only the functions you request in the program. Program development is a snap.

The user's manual is clear, concise and full of useful information. For those of you just getting started with C, we also include a copy of the **C Programming Guide** (Que). This B. Dalton Best Seller has been adopted by a number of leading universities around the country and is included with each compiler. The book is designed to help you learn C from the ground up. We ought to know...we wrote the book.

We've made the compiler easy to work with for the professional and beginner alike. Most error messages, for example, tell you in English (not just a number) the line number and character position of the error, what was expected and a page reference to the **Guide** to consult for help if you need it.

PRICE:

We saved the best for last; we've cut the price by \$100.00. Now you can buy the Eco-C compiler for only \$250.00 (MACRO 80 and the book alone are worth \$218.00!). Shop around and we think you agree that the Eco-C compiler is the best value available.

The Eco-C compiler requires a Z80 CPU, CP/M, 54K of free memory and about 240K of disk space (one or two drives). An IBM-PC version will be available in the first quarter of 84. To order your Eco-C compiler, call or write.



Ecosoft Inc.
P.O. Box 68602
Indianapolis, IN 46268
(317) 255-6476



TRADEMARKS:
Eco-C (Ecosoft), MACRO 80 (Microsoft), CP/M (Digital Research)

ber 1983 BYTE, pages 36-44, for a comparative list of portables.)

The trend is upward. The newer machines have lower prices and higher performance, screens and memories are larger, and 16-bit processors are more common. When the market for portables matures two or three years from now, what will a portable computer look like? We guess that there will be three "levels" of portability, each defined in terms of price, capability, and bulk.

Machines at the lowest level will cost about \$250 and will use technology similar to that of the Model 100 with a minimum-sized screen, a full keyboard, and no disk drive. It will run a refined version of the Model 100 software (no BASIC, better idea-processing software, less emphasis on specific applications such as an address book and scheduler).

The middle-level machine will cost about \$1500 and will provide the functionality of our mythical 256K-byte portable, but it will not have a disk drive. The unit will run ROM-based software, will be compatible with the standard desktop operating systems, and will interface to standard desktop computers as a keyboard. The operating software on this portable will offer sophisticated and easy access to the desktop's printer, typesetter, hard disk, and networking capabilities. Applications software will be up- and downloaded with a single keystroke. A large number of portable-specific applications will be available, including more powerful idea-processing software. It will connect to RS-232C devices and phone lines. Watch for radio communications, an interface to the developing cellular radio network. Because the middle-level portable will not have a disk drive, the bulk of the unit will be only slightly larger than the \$250 machine.

The high-level machine will have more memory, a disk drive, perhaps a small printer, and will sell for \$2500 to \$5000. It will have all the capabilities of the middle-level machine, but it will also weigh more (as much as 25 pounds) and thus be less portable. There will be a smaller market for this machine; it will be aimed at those

people who need to carry an entire computer system with them (e.g., consultants with large databases).

Future Developments

How big will the portable-computer industry be, and what impact will it have on society? We believe that the machines at the lowest level will sell in the same mass-market numbers as Atari and Coleco game machines did in 1982. The industry that will serve this huge base of people using portables will be very broad. Users will need software, hardware, and means of hooking into phone and cable networks. They'll need services such as electronic mail and bulletin boards, training, and maintenance—many of the same services that current users of desktop computers need but in larger numbers and with more emphasis on communications and convenience. Certainly, having computers that travel increases the number of places that can be tied into a computer network.

Will portables finally force the development of a national computer resource for mail and messages or a standard for high-level communications? We think so, but it may take as long as five years for such sophistication to develop in the market. Currently, users of the Model 100 and other portables are communicating through networks such as The Source and CompuServe. Yet, because of the current price and performance of these services, we don't expect portable-computer users to turn these networks into mass-market consumables.

A new breed of software will be needed for desktops and mainframes. The bigger machines will have to monitor telephones and respond to commands when you dial in using a portable computer. Bulletin-board software will evolve into an efficient way to access desktop and mainframe resources from remote locations. ■

David Winer is president of Living Videotext Inc. (Suite 232, 1000 Elwell Court, Palo Alto, CA 94303). Peter Winer is a software consultant based in Brighton, MA.

SUPER SIX™

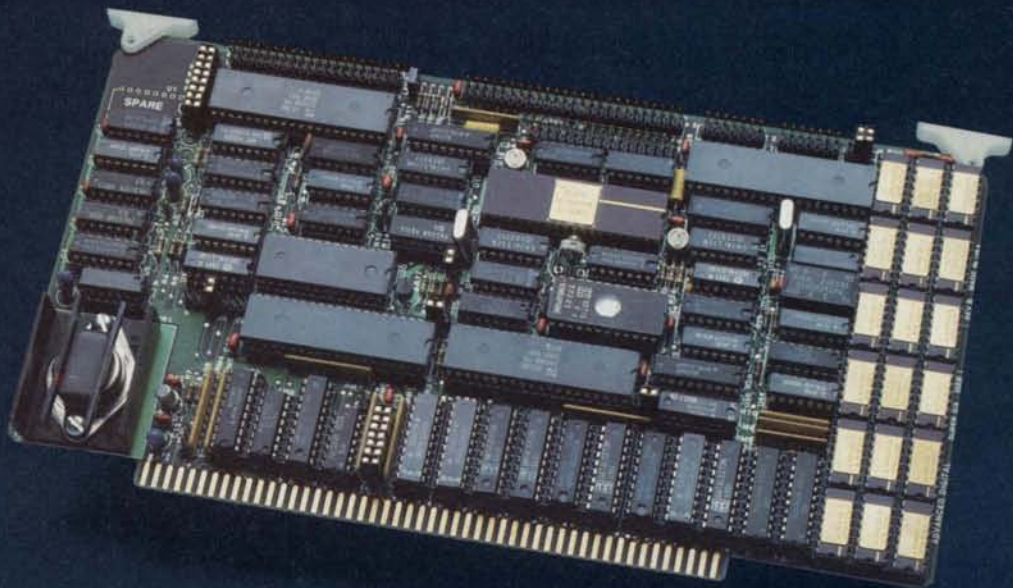

SUPER SIX, THE FIRST 6MHz S-100 SINGLE BOARD COMPUTER TO SUPPORT BANKED CP/M™ 3.0

SUPER SIX FEATURES:

- 128 KB of Bank — selectable RAM
- 6 MHz, Z-80B CPU
- DMA Controller
- 6 MHz, Z-80B DART (2 Serial RS-232 Ports)
- 6 MHz, Z-80B PIO (2 Parallel Ports)
- 6 MHz, Z-80B CTC (Clock Timer)
- Double/Single Density Floppy Disk Controller — Supports 8" and 5-1/4" Drives Simultaneously
- 2/4 KB of Monitor EPROM
- S-100, IEEE 696 Compatible

*CP/M is a trademark of Digital Research Corp. TurboDOS is a trademark of Software 2000 Inc. SUPER SIX and SUPER SLAVE are trademarks of Advanced Digital Corp.



SUPER SIX & CP/M™ 3.0 A PERFECT MATCH

Advanced Digital has found the perfect match to its powerful, high-speed SUPER SIX single board computer. It's Digital Research's new CP/M 3.0. Because of SUPER SIX's 128 KB of RAM, it is the only S-100 board to support CP/M 3.0 in the banked mode; or run CP/M 2.2 with 64 KB of extra buffer.

SUPER SIX & TurboDOS™ ANOTHER PERFECT MATCH

When you combine the TurboDOS multi-user operating system with the 6 MHz SUPER SIX, you'll find your system running 1-1/2 times faster than



before. Add the 4 MHz or 6 MHz SUPER SLAVE™ processor board(s) and you will have the fastest multi-user, multi-processor system available today.

See the SUPER SIX at your quality computer dealer or contact:



5432 Production Dr.,
Huntington Beach, CA 92649
Phone: (714) 891-4004
Telex: 678401 TAB IRIN

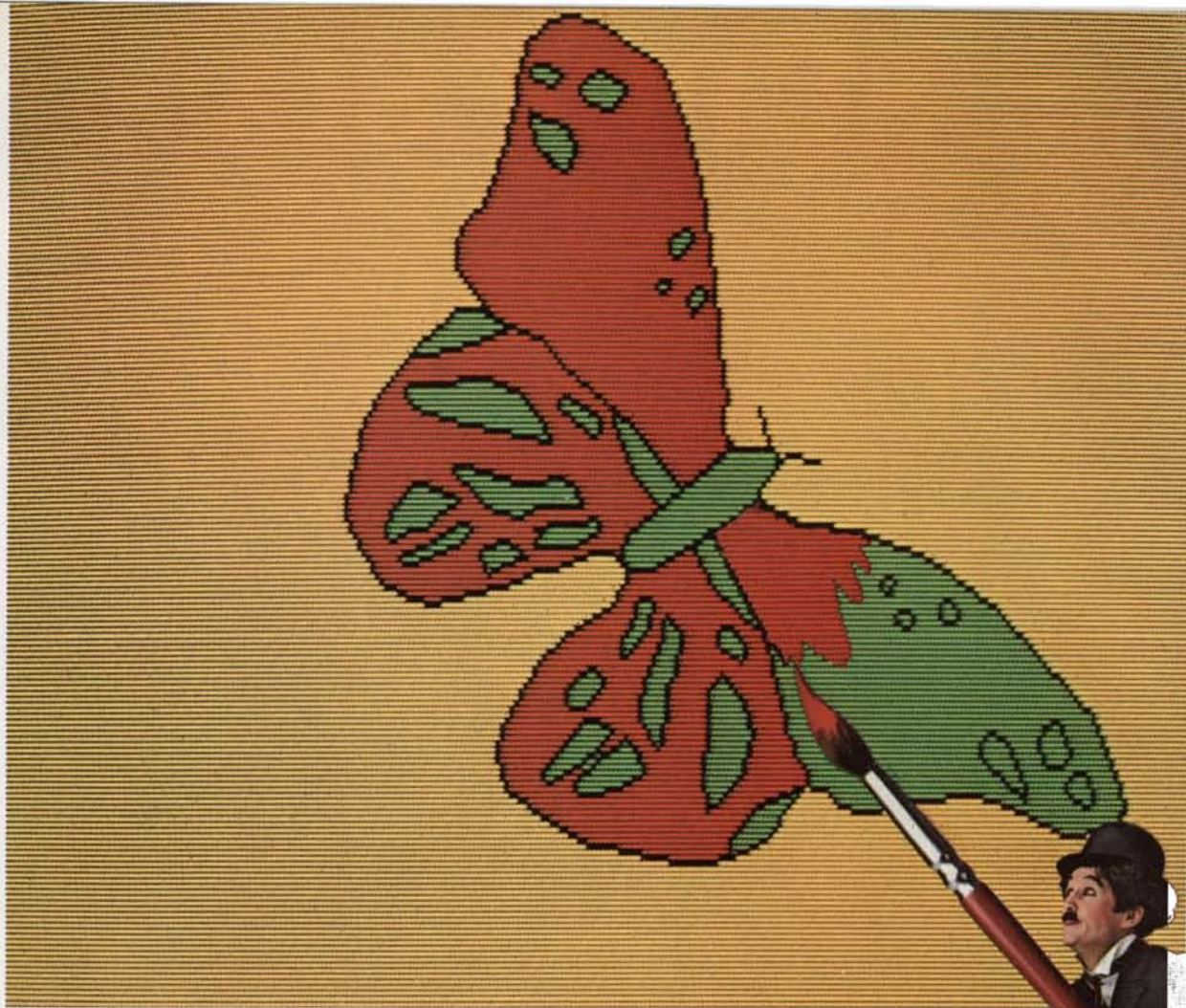

The Chaplin character licensed by Bubbles, Inc., S.A.

Draw attention to yourself.

(Write a program for the IBM Personal Computer.)

Let your imagination take wing.
Think charts. Graphs. Shapes. Images.

Use originality, creativity and color in programs that entertain. Educate. Organize. Analyze. And programs that get down to business.

Maybe you've written software like that. Or perhaps you're thinking about it.

If so, consider this.

You could draw attention to yourself by writing programs *for* the IBM Personal Computer *on* the IBM Personal Computer. Because all our advanced features (see the box at right) make it faster and easier to do so.

Enhanced BASIC already in ROM, for example, has graphics commands already built in.

And if you write a program using our Advanced BASIC, you'll find the DRAW command particularly appealing. It's virtually a separate graphics language *within* a larger language.

Put your visual together with both the characters and symbols in ROM for a simultaneous, text-and-graphics mix.

Have musical accompaniment as well.

It's easy, because BASIC controls the built-in speaker with a single command.

Utilize the ten, programmable function keys. Try F3 to paint. F4 for lines. F5 for circles. Or F6 for boxes.



The IBM Personal Computer A tool for modern times

For more information on where to buy the IBM Personal Computer, call 800-447-4700. In Alaska or Hawaii, 800-447-0890.
†UCSD p-System is a trademark of the Regents of the University of California. CP/M-86 is a trademark of Digital Research, Inc.

IBM PERSONAL COMPUTER SPECIFICATIONS

User Memory

64K-640K bytes
16-bit, 8088

Auxiliary Memory

2 optional internal
diskette drives, 5¼"
160KB/180KB or
320KB/360KB
per diskette

Keyboard

83 keys, 6 ft. cord
attaches to
system unit
10 function keys
10-key numeric pad

Diagnostics

Power-on self testing
Parity checking

Display Screens

Color or monochrome
High-resolution
80 characters x 25 lines
Upper and lower case

Operating Systems

DOS, UCSD p-System,
CP/M-86†

Languages

BASIC, Pascal, FORTRAN,
MACRO Assembler,
COBOL

Printer

All-points-addressable
graphics capability
Bidirectional
80 characters/second
18 character styles
9 x 9 character matrix

Permanent Memory

(ROM) 40K bytes

Color/Graphics

Text mode:
16 colors
256 characters and
symbols in ROM

Graphics mode:
4-color resolution:
320h x 200v

Black & white resolution:
640h x 200v

Simultaneous graphics &
text capability

Communications

RS-232-C interface
SDLC, Asynchronous,
Bisynchronous protocols
Up to 9600 bits per second

Remember that these function keys make your program more "friendly" to the user and, therefore, more appealing to us.

In fact, if you're interested in licensing your software, we could be interested in publishing it.

We could also be interested even if it runs on *another* computer. If we select your software, we'll ask you to adapt it to our system.

So if you think your software is close to picture perfect, consider sending it in.

For information on how to submit your completed program, write:
IBM Personal Computer,
External Submissions, Dept. 765 PC,
Armonk, New York 10504. **IBM**®

SUMO-TESTED

WOULD YOU BELIEVE 3 OUT OF 4 SUMO WRESTLERS RECOMMEND CASES BY COMPUTER-MATE?

Neither do we. But, it wouldn't surprise us. Because our cases are built with brute strength, able to take a tough beating from even the mightiest challengers.

Stop wrestling with your computer equipment. With our cases you have ease of transportation plus maximum protection for all your components. Standard cases available for IBM, DEC, Apple, TI plus many others. Custom built cases are also available to help protect almost any configuration of sensitive equipment.

For loss prevention, each case has a 3" x 5" personal identification frame and individual serial number with toll free number. And like all Computer-Mate products, each case is pre-screened for excellence and backed with a 100% unconditional guarantee.



Chances are your computer equipment will never undergo a heavy beating with a Sumo wrestler, but with protection from Cases by Computer-MateTM the odds are 3 to 1 your equipment would win.

For order/information contact:

Computer-Mate, Inc.

1006 Hampshire Lane, Richardson, Texas 75080
Dallas (214) 669-9370 • Texas Residents (800) 442-4006
Out of State (800) 527-3643. Dealer inquiries welcome.

Beyond the Application Program

A Different Approach to Integrated Software

Element managers that implement objects such as spreadsheet tables and text paragraphs may supplant the traditional concept of the application program

by John Banning

To bring the benefits of personal computers to professionals who travel widely, portable computers must have a basic set of facilities for data storage, data manipulation, and data transmission. These facilities include a word processor, a spreadsheet, a personal database, and a combination terminal-emulator and file-transfer system.

Since travelers lack luggage space for reference manuals, software in portable computers must be easy to learn how to use and, perhaps more important, easy to remember how to use. This requires a user interface that is visual—one that lets the user see what is going on—and one that is consistent across all applications. Moreover, the consistent user interface must let the user create documents that include data from two or more different applications.

This article describes what we at Gavilan Computer Corporation believe is an innovative approach to integrating software for portable computers in order to achieve high functionality and ease of use. Our software has antecedents in the object-oriented software developed at the Xerox Palo Alto Research Center and described in the August 1981 issue of BYTE. After orienting you in the out-

ward appearance and fundamental terms of our software and discussing our development tools, I will discuss the structure of our software, which actually puts the user interface in charge of the computer, and the integrated application facilities, which are provided through "elements" and "element managers" rather than different application programs, each with its own unique kind of document with its own unique structure.

Software in portable computers must be easy to learn how to use and easy to remember how to use.

The element-manager approach lets users have different kinds of objects, such as paragraphs and spreadsheet tables, in the same document, and lets the objects retain their normal behavior and functionality. For example, a spreadsheet table appearing in a letter can still recalculate if a value used in one of its formulas is changed.

Orientation

Gavilan's approach to building easy-to-understand software is based

on objects whose state the user can observe directly (because that state is displayed on the screen). The user manipulates these objects with a small, uniform set of operations. In addition, these objects are based on things that are familiar to most users: file drawers, file folders, documents, paragraphs, and so forth.

Photo 1 shows an image of what is called the desktop as displayed on the portable computer's screen. On it are a file drawer and a number of documents, each tagged with an image (called an icon) that suggests a kind of object (the front of a file drawer or two overlapped pages of a document). These images on the desktop represent objects that are open and thus accessible to a user. This view can always be brought up by pressing the Desk Top button on the control area on the front of the computer (figure 1).

Also visible (near the center of the photo 1 screen) is a small arrow. By moving your finger over the touch pad on the front of the unit (the blank area in the middle of the control area shown in figure 1), you can move this arrow around, pointing it at things on the screen. This is the key that ties together the visual nature of the interface (the ability to

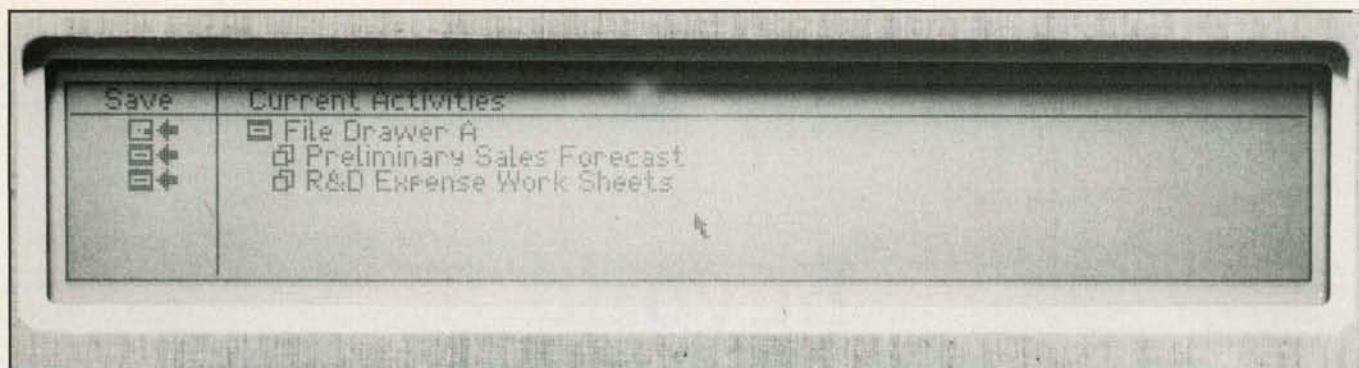

Photo 1: The Gavilan computer's desktop image.

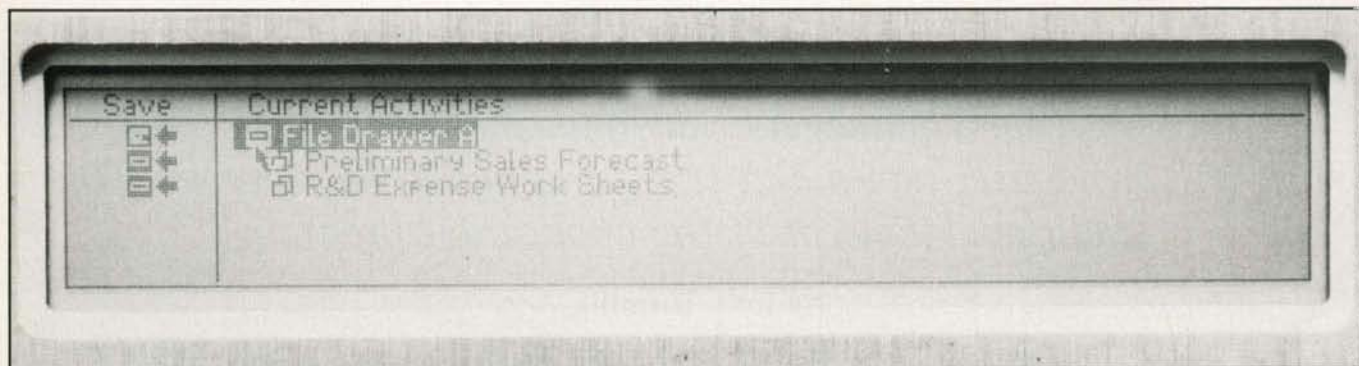

Photo 2: A display illustrating the selection of file drawer A.

view documents directly) with the manipulation of objects. Instead of remembering object and command names and typing them into the computer, you point to an object and an operation.

You can point to the desktop icon of one of the open objects (photo 2), and then, by pressing the Select button (see figure 1), indicate that you would like to examine the contents of that object.

If this "on-screen button" operation is performed to select the photo 2 file drawer, what you might see is shown in photo 3: the file-drawer contents, which consist of file folders and documents arranged in outline form. Again the pictorial icons suggest the

kind of object you are looking at. As with the desktop, the contents of a document can be viewed by pointing to the document icon and pressing the Select button.

But you can also select data that is displayed in the file drawer (the names of the documents and file folders) by pointing at a document name and pressing the Select button. Having selected part of an object, you can perform any number of editing operations on it such as typing into it or (by pressing the appropriate button) deleting, moving, or copying it. By pressing the figure 1 Menu button, a whole list of on-screen buttons for various standard operations can be called up (photo 4) and then

selected. The operations available here are exactly the same ones that would be used to edit or otherwise manipulate a paragraph or a spreadsheet.

As with the desktop, by pointing to a document's viewing icon and pressing the Select button, you can look at the contents of a document. Photo 5, for example, shows text arranged in a paragraph, followed by the cells of a spreadsheet table. Again, by pointing to a particular object, you can select data in that object and do an operation on it.

Note that by selecting data in the paragraph, you begin interacting (through the human-interface software) with the word-processing ap-

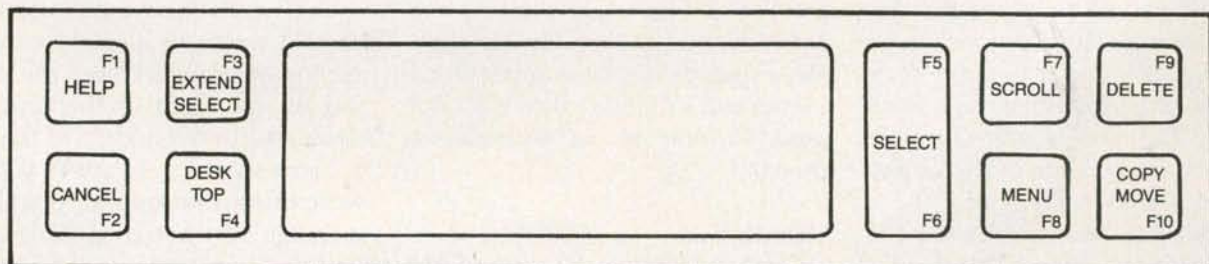

Figure 1: The Gavilan computer's control area.

Introducing a sensible solution to the problems of dBASE II.™

	dBASE II	The Sensible Solution
Records Per File	65,535	999,999
Maximum Record Size	1,024 bytes	1,536 bytes
Fields Per Record	32	384
Key Fields Per File	7	10
Number of Files Simultaneously Accessible	2	10
Number of Screens Per Program	Limited by system memory	Limited only by system storage
Data Dictionary	No	Yes

We don't mean to debase dBASE II, but if you're looking for a data base manager that's long on features, dBASE II can come up a little short.

For instance, a single dBASE II record can only contain 32 fields. And when you need to share information between one file and another, you can only access two at a time.

So, as good as dBASE II is, its limitations can quickly paint you into an electronic corner.

And that's why we created *The Sensible Solution*.

Finally A sensational relational.

Along with all the usual things you expect from a data base manager, *The Sensible Solution* lets you handle the kind of tough assignments that dBASE II can't:

You can design data files with more than 300 variables. You can create reports using 10 different files at once. You can even set up file locking for multi-user computers.

Ready to get down to business.

A data base manager without ready-to-run application programs is hardly worth the disk it's copied on.

So, along with *The Sensible Solution*, you can also add *The Sensible Solution Bookkeeper*™ or *Sensible Management*™, our complete one-entry accounting and management system.

They're both affordable. Business-tested. And supplied with source code so you can make your own modifications.

A sensible trial offer.

When you purchase *The Sensible Solution*, we'll send along a special trial disk that lets you create forms and enter a limited number of records. If, after 30 days, you're not satisfied, just return the unopened master system disk for a full refund.

So why not take us up on our trial offer? You've got nothing to lose.

Except the problems of dBASE II.

The Sensible Solution™

To order, write or call: O'Hanlon Computer Systems, 11058 Main Street, Bellevue, WA 98004 USA, Phone (206) 454-2261. Prices: *The Sensible Solution*—\$695, *Sensible Solution Bookkeeper*—\$495, *Sensible Management*—\$895. In Washington, add 7.9% state tax. VISA, Mastercard and dealer inquiries welcome.

dBASE II is a registered trademark of Ashton-Tate. Sensible Solution, Sensible Solution Bookkeeper and Sensible Solution Management are trademarks of O'Hanlon Computer Systems, Inc.

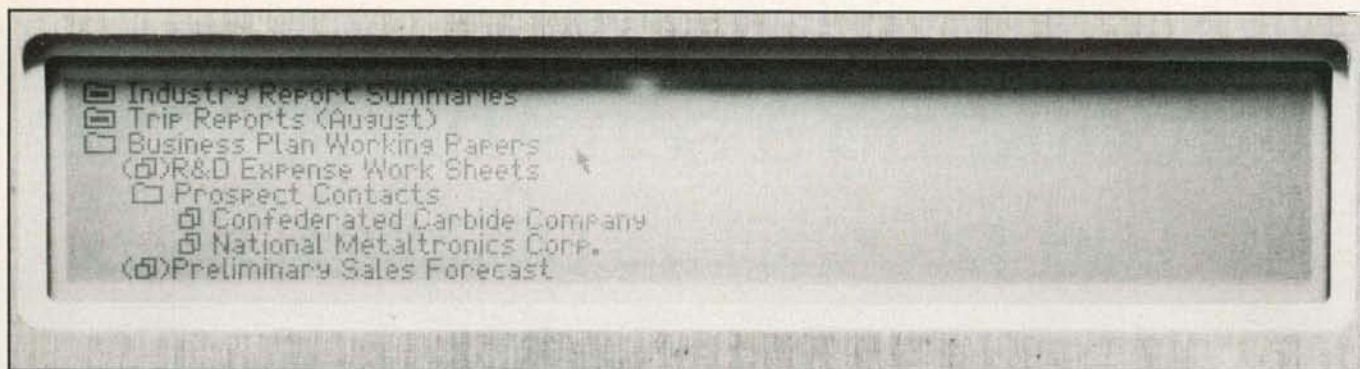

Photo 3: The file-drawer contents.

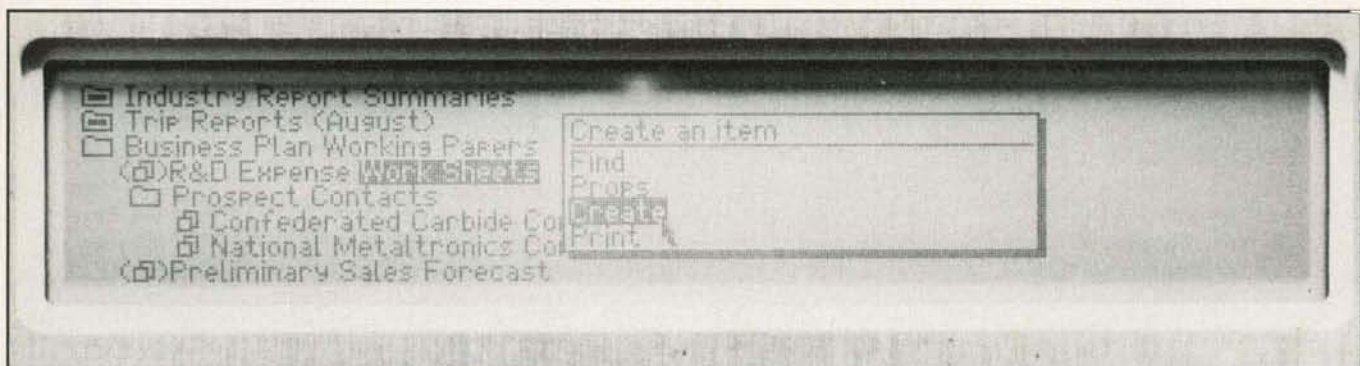

Photo 4: Pressing the menu button brings a list of on-screen buttons onto the photo 3 screen.

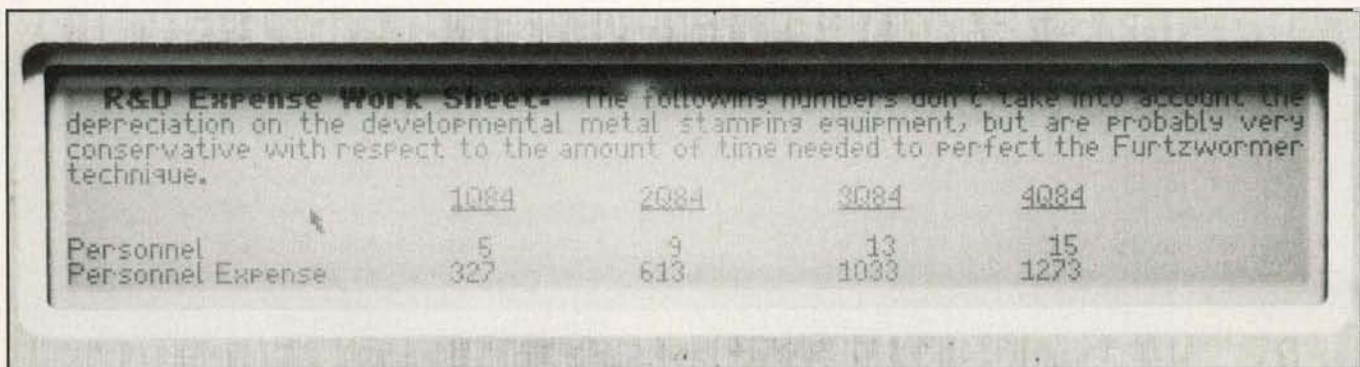

Photo 5: Document contents.

plication. If you were to move the arrow down to the spreadsheet and select data there, you would be interacting with the spreadsheet application. Thus, the idea of a program as something the user has to understand and deal with has been replaced with objects that users view and directly manipulate by following a few simple rules.

One of the standard operations that can be performed on an object is the Properties command (photo 6), which lets you view or set some property of an object. Selecting this command for a paragraph (photo 7)

shows that you can set character properties, general paragraph properties, or properties controlling the printing of paragraphs. By selecting character properties (photo 8), you get a form that can be filled in to set such features as boldface or italics. Thus, the property mechanism offers a uniform way of handling various properties of different kinds of objects, helping to keep the number of operations in the system small.

Structure

Figure 2 shows the overall structure of the software that Gavilan has built

to implement this visual, object-oriented approach.

This software is written in Interpac, a proprietary language. Thus, the bottom level of the software, which provides the environment for the rest of the software, is the interpreter for the Interpac language.

The operating system is designed not only to handle specialized aspects of portable computing (e.g., power and battery control), but also to provide the fundamental services necessary to build an object-oriented software system. These include a multi-tasking monitor (to support multiple

Microsoft languages connect your software to more 16-bit systems.

The largest market for 16-bit software. Over 95% of all 16-bit microcomputers run Microsoft® operating systems, languages, or both. That means your programs written in Microsoft languages find their market in the largest installed base of 16-bit systems. The IBM® PC, and systems from Wang, Zenith, DEC, Victor, Altos, Texas Instruments and Radio Shack, to name just a few. And, if you're working with Microsoft operating systems and languages, you'll find that it's far easier to transport software between systems.

A full range of languages. The versatile MS-BASIC interpreter and the fast MS-BASIC compiler, Microsoft Business BASIC and MS-COBOL for business use. MS-FORTRAN for scientific and engineering applications. Microsoft C, a complete C, that provides a productive alternative to assembly language. And MS-Pascal, a high-level language compiler specifically designed for microprocessor system software implementation. All these languages are compatible with ANSI or ISO standards.

A total programming environment. Compatible languages. Operating systems. Utilities. Plus complete support. All the tools you need to write software that sells.

Leadership in micros.

Microsoft wrote the first BASIC for the

first production microcomputer. Since then, we've added a full range of 8-bit and 16-bit languages, plus the MS™-DOS and XENIX™ operating systems. What's more, we are constantly enhancing both languages and operating systems. And we make those enhancements available to our customers. That means Microsoft programming languages are state-of-the-art programming tools. Tools that allow your applications programs to reach more systems. More effectively.

More information? See your Microsoft dealer for complete information on Microsoft's 16-bit languages and operating systems. Or, write for our booklet, "The Microsoft Language Family." A family of tools that give your programs access to the largest installed base of 16-bit systems.

BETTER TOOLS FOR MICROCOMPUTERS

MICROSOFT™

MICROSOFT CORPORATION
10700 NORTHUP WAY
BELLEVUE, WASHINGTON 98004



Microsoft is a registered trademark, and MS, XENIX and the Microsoft logo are trademarks of Microsoft Corporation.

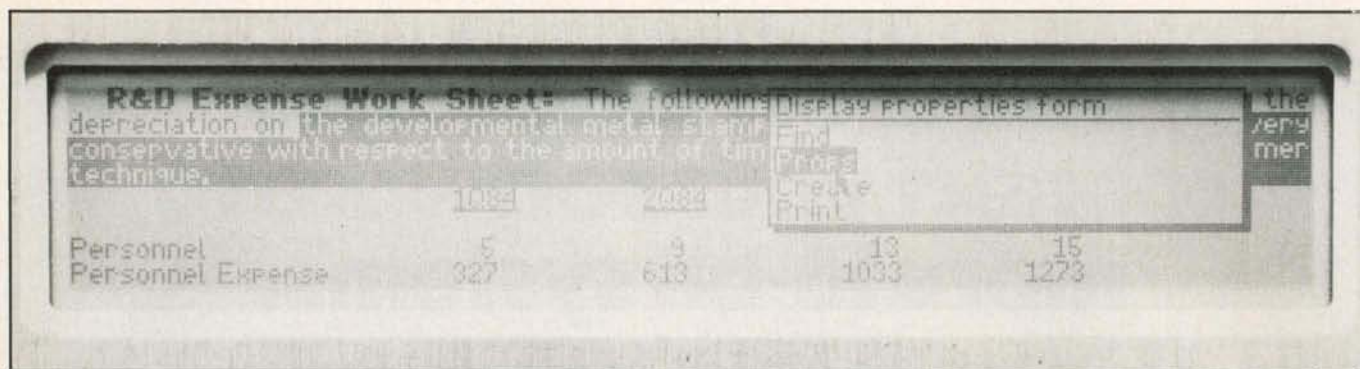

Photo 6: Selection of the Properties command.

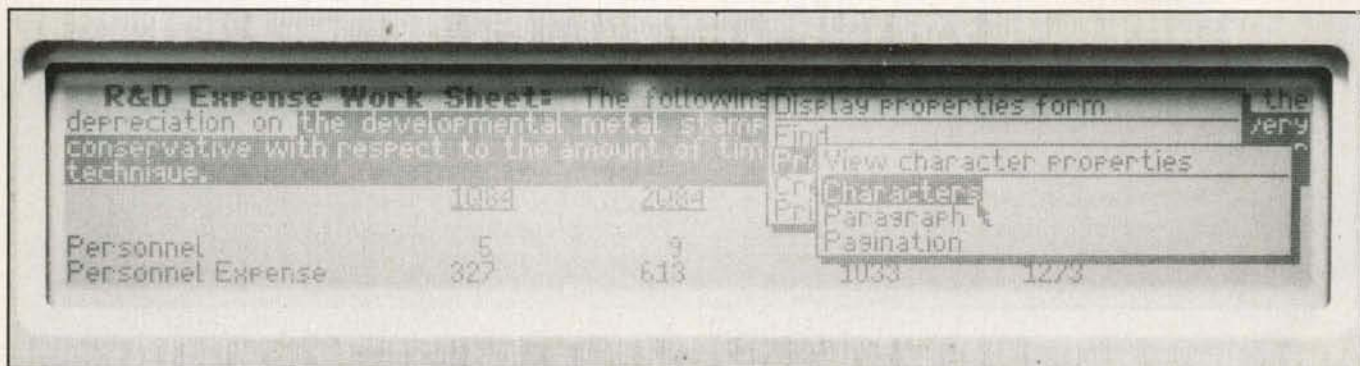

Photo 7: On-screen buttons allowing selection of character, paragraph, or pagination properties.

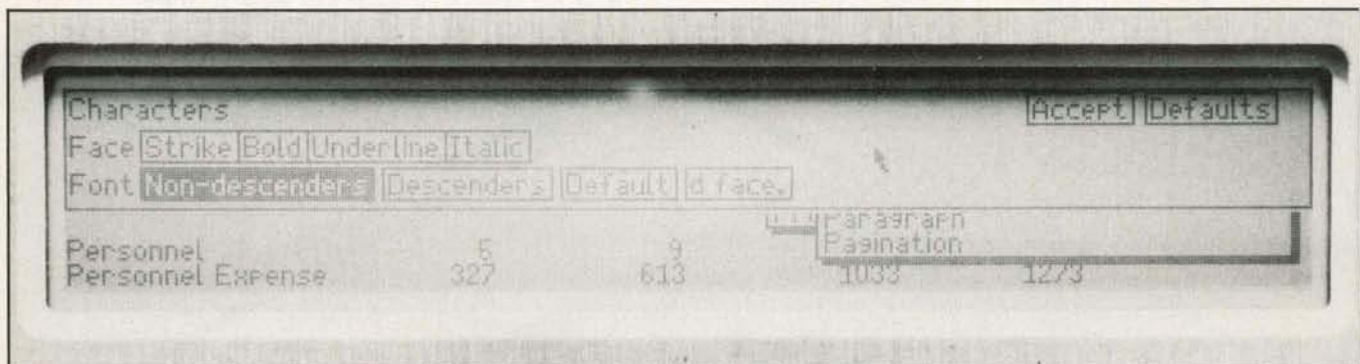

Photo 8: Selectable character properties.

documents to be open on the desktop at one time) and block-structured access to the disk and main memory.

Holding the objects that a user views and manipulates is the job of the data-structuring software. It provides object-oriented data structures that are built on the blocks of the operating system's disk and memory services.

The human-interface software handles all interaction with the end user and thus has primary responsibility for creating the visual access to the objects held by the data-structur-

ing software and the commands that work on them. The element managers shown next to the data-structuring software in figure 2 are the main kind of application facility in this object-oriented system.

The development of this software has all been done on Bell Laboratories' Unix operating system using a number of compiling and debugging tools.

Tools

Interpac, the language Gavilan's software is written in, is based on the

FORTH language. The choice of FORTH was dictated by a number of considerations. First, it was important to have compact code, as the task before us was to generate a very sophisticated piece of software that must run in a limited amount of memory. At the same time, it was important to sustain a high level of execution performance so that adequate response to the end user could be provided.

FORTH is ideally suited to these conflicting goals, as its interpreted form can be made compact, and the

Now NRI takes you inside the new TRS-80 Model 4 microcomputer with disk drive to train you at home as the new breed of computer specialist!

NRI teams up with Radio Shack advanced technology to teach you how to use, program and service state-of-the-art microcomputers...

It's no longer enough to be just a programmer or a technician. With microcomputers moving into the fabric of our lives (over 1 million of the TRS-80™ alone have been sold), interdisciplinary skills are demanded. And NRI can prepare you with the first course of its kind, covering the complete world of the microcomputer.

Learn At Home In Your Spare Time

With NRI training, the programmer gains practical knowledge of hardware, enabling him to design simpler, more effective programs. And, with advanced programming skills, the technician can test and debug systems



quickly and easily.

Only NRI gives you both kinds of training with the convenience of learning at home. No classroom pressures, no night school, no gasoline wasted. You learn at your convenience, at your own pace. Yet you're always backed by the NRI staff and your instructor, answering questions and giving you guidance.

TRS-80 Model 4 Plus Disk Drive To Learn On and Keep

NRI gives you hands-on training on the latest model in the most popular line of Radio Shack microcomputers: the TRS-80 Model 4.

You not only learn to program your Model 4, you learn all about it... how circuits interact... interface with other systems... gain a real insight into its nature. Under NRI's expert guidance, you even install a disk drive, verifying its operation at each step.

You also work with a professional 4-function digital multimeter and the NRI Discovery Lab,[®] performing over 60 separate experiments.

The powerful, versatile TRS-80 Model 4 microcomputer disk drive and other equipment you train with are yours to use and keep!

Same Training Available With Color Computer

NRI offers you the opportunity to train with the TRS-80 Color Computer as an alternative to the Model 4. The same technique for getting inside is enhanced by using the new NRI-developed Computer Access Card. Only NRI offers you a choice to fit your specific training needs.

The Catalog is Free. The Training is Priceless.

Get all the details on this exciting course in NRI's free, 104 page catalog. It shows all equipment, lesson outlines, and facts on other electronics courses such as Electronic Design, Industrial Electronics, Video/Audio Servicing... 12 different career opportunities in all. Keep up with the latest technology as you learn on the latest model of the world's most popular computer. If card has been used, write to:



NRI Schools
McGraw-Hill Continuing
Education Center
3939 Wisconsin Avenue
Washington, DC 20016

We'll give you tomorrow.



Now training includes either the TRS-80 Model 4 Microcomputer with Disk Drive or TRS-80 Color Computer with Computer Access Card; professional LCD multimeter; the NRI Discovery Lab; and hundreds of demonstrations and experiments.

(TRS-80 is a trademark of the Radio Shack division of Tandy Corp.)

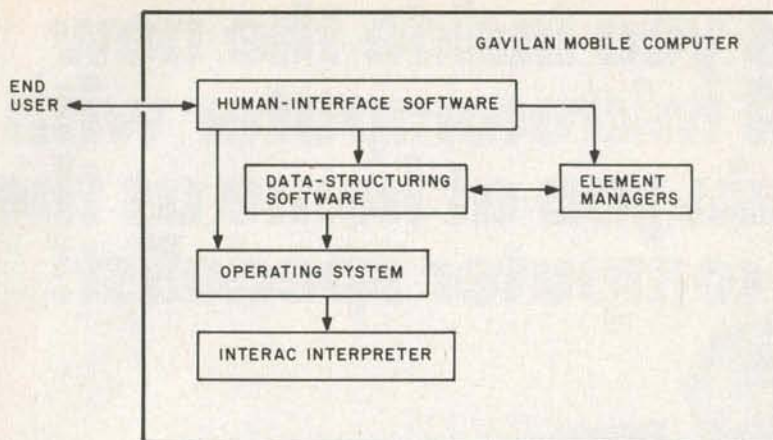

Figure 2: The structure of the Gavilan computer's software, showing the main software components and their relation to one another.

structure of the language gives the programmer sufficient control to generate efficient code. FORTH also accommodates the insertion of assembly-language routines in those cases where performance analysis indicates that assembly language will provide substantial improvements.

Another important quality that Interpac has inherited from FORTH is the way it encourages the structuring of software in layers of abstraction. Each layer of FORTH "words" ("procedures" in conventional terms) is built on the lower layer and provides a more sophisticated level of abstraction to the next layer. This structure is particularly natural in that all operations in FORTH access their arguments in the same way regardless of whether they are part of or built on top of the base language.

FORTH in its pure form has some drawbacks that needed to be corrected. The combined interactive interpreter and compiler of classic FORTH has been replaced by an Interpac compiler that runs under Unix. This Interpac compiler generates much tighter code than that of standard FORTH, using techniques such as single-byte encoding of Interpac words and constant values.

In addition, a number of changes to the language were made to promote good software-engineering practice. Declaration of Pascal-like data structures was introduced to allow intelligible data-structure descriptions. Declaration of parameters on FORTH words was added to pro-

vide better documentation and allow for automatic type checking. Stack marking and local variables were added to allow more complex words to be created in a straightforward manner. A module structure was introduced to express modular decomposition and the attendant hiding of data structures and implementation details.

Along with the Interpac language and its compiler, a number of other tools were created. A remote debugger allows us to download programs from the Unix system to a target Gavilan unit and do symbolic debugging from the Unix system with a minimal impact on the target environment. This debugger also forms the basis for a performance monitor that tells us how much time is spent in each Interpac word and a test-coverage monitor that tells us what code has not been exercised by a particular test.

A message-compression utility allows us to compress by a factor of four the English (or French or German, etc.) text files used in error messages, menus, and the help facility.

Third-party software developers have a similar set of tools available to them. The difference is that they run under MS/DOS on the Gavilan unit or the IBM PC or XT and use the C programming language rather than Interpac.

System Software

The operating system manages and

controls the basic resources of the system, including not only device drivers for the computer's I/O devices, but also control of power to the peripherals and processor.

Because peripherals can be added on to the unit and applications capsules plugged into the unit, the operating system provides services for locating a particular device or application. These services include a logical I/O system that routes commands from the rest of the software and interrupts from the hardware to the appropriate device driver. (Device drivers are typically contained in the peripheral that they control, and the operating system provides a general way of accessing them.)

Two functions of the operating system contribute significantly to the particular goals of the rest of the portable computer's software. The first of these is the management of the microprocessor tasks by way of multiple tasks synchronized through semaphores. This approach allows multiple activities to proceed simultaneously in the system and provides the basis for having multiple documents open on the on-screen desktop—just as you might have on a real desk. It also provides an elegant mechanism for power control: whenever the process dispatcher cannot find any tasks that are ready to run, it saves the processor's state and turns the power off (power is automatically restored by the next interrupt).

The second way in which the operating system supports the user's view of the portable computer is through the block manager, which manages secondary storage to devices such as floppy disks. The block manager provides a uniform view of blocks, whether they are on the floppy disk or in main memory. It manages the whole process of deciding which blocks should be in memory and which should be returned to secondary storage. It also provides a transaction facility that is the basis of the system's Undo command.

Data-Structuring Software

The data-structuring software (whose structure is shown in figure

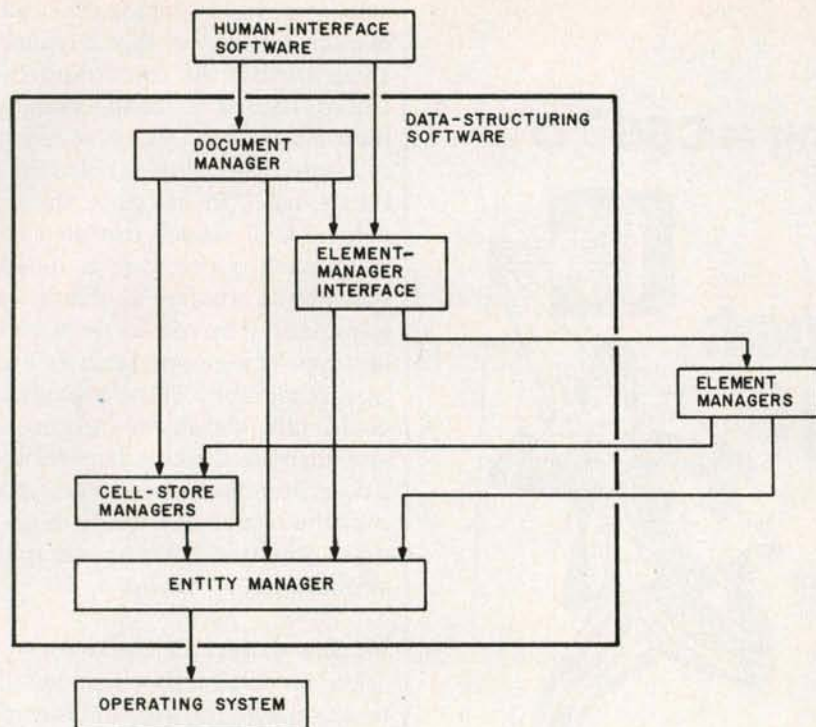

Figure 3: Details of the data-structuring software, which provides storage for and access to documents.

3) provides storage for and access to documents. It is built upon the block manager, which provides raw data storage and creates the structures that hold the state of objects. Three principal kinds of objects are supported at this level: documents, elements, and cell stores.

A document can exist on its own on a disk (or in a file drawer, as it is called) and roughly corresponds to what is called a document in the real world: a memo, a paper, a report, etc. A document is made up of a sequence of elements, each of which has a type and corresponds to something like a paragraph, section head, spreadsheet table, form, etc. A document may also contain a number of cell stores.

All documents have the same structure. There can be different types of documents, but these are distinguished principally by the kinds of elements contained in them. For instance, the file drawer, which provides the directory of the contents of a disk, is a special kind of document that can contain only file-folder and document-reference elements.

The second kind of object, an element, has two parts: the storage that

holds its state, and a program called an element manager. The state of an object is held in a record-like structure provided by the lowest level of the data-structuring software: the entity manager. One important piece of information kept by the entity manager is the type of the element.

Each type of element (e.g., paragraph, table, etc.) has associated with it an element manager. This element manager implements a standard set of operations that can be performed on an element, such as displaying the element, handling a selection in the element, typing into the element, copying information out of the element, etc. These operations are invoked by the human interface in response to user actions. The element manager performs those parts of the uniform set of user operations that are peculiar to a particular element.

The element-manager interface maps the calls invoking a common operation for an element to the element manager associated with it using the element-type code stored by the entity manager for the element.

The third kind of object supported by the data-structuring software, the

SERIAL PORT EXPANDER AND MORE



BTA's MODEL 524 MULTIPORT CONTROLLER is a code activated one to four serial port expander — but that's not all since it has separate and independent UARTS, buffers and handshaking each port can operate with a different configuration, i.e. different baud rates, stop bits, etc. These features also permit two or more devices to communicate with the 524 simultaneously.

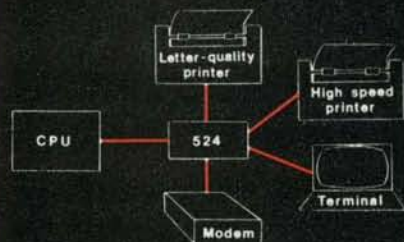

Full duplex with EIA RS-232 protocol

Baud rates up to 19,200

Expansion to 16 ports by cascading

Peripheral ports may be configured by user software

One year warranty



• **MODEL 524** \$249.00

• **MODEL 524A** \$279.00
same as model 524 except has 256 byte rx/tx buffers per port

• **MODEL 524 D** \$269.00
same as model 524, plus continuous polling of each peripheral device for data transfer requests. The device is automatically connected when its 'turn comes up'. ON, BUSY and OFF messages are sent to the peripheral device.

• Other models available — Contact us or your dealer for additional information.



BAY TECHNICAL ASSOCIATES, inc.

HIGHWAY 603, P.O. BOX 387
BAY ST. LOUIS, MISSISSIPPI 39520
(801)467-8231

Our new Optimizing = C86™ C Compiler controls Charlie...

Like a Puppet on a String!

Take control of Charlie with
our new Optimizing = C86™
C Compiler...now available for
the IBM PC-DOS and the
MS-DOS operating systems.
Take the upper hand with:



- Significantly faster and tighter code
- Standard object module format, linkable with the MS-DOS linker
- Compile time switch for big machine addressing (Programs can be as large as the memory you can afford!)
- Compile time switch to produce in-line 8087 code. (We still provide our floating point package, too!)
- Significant performance increases for our I/O library
- MS-DOS version 2.00 I/O library
- Many additional library functions
- Expanded manual with numerous examples
- Librarian for maintenance of MS/DOS libraries
- Optional assembly source output (It's not NECESSARY to produce assembly source, but it CAN be assembled using MASM!)

Pull Charlie's strings with our new Optimizing = C86™ C Compiler. See your local dealer or call Computer Innovations for information and to order the C86 Compiler Diskette and Manual...still only \$395.00!



Computer Innovations
10 Mechanic Street
Suite J-504
Red Bank, N.J. 07701
(201) 530-0995

**"They Say It All...
We Do It All!"**

Visa and MasterCard accepted.

C86 is a trademark of Computer Innovations, Inc. CPM-86 and MPM-86 are trademarks of Digital Research. MS-DOS is a trademark of Microsoft. PC-DOS is a trademark of International Business Machines.

cell store, holds values that can be displayed by elements and maintains some method of computing those values. Thus, a spreadsheet-table element displays the values of cells in a cell store. The cell store holds the formulas used to calculate the cell's values. Cell values can also come from such sources as a database query or an arbitrary application program, and they can be displayed by any type of element, such as a form or a paragraph. Thus, a paragraph could talk about the results of a spreadsheet, directly displaying cell values from that spreadsheet, or display the results of a query in an address database, thus handling such applications as mail-merging.

Human-Interface Software

The human interface handles all interaction with the user and is responsible for displaying objects and effecting those manipulations on objects that the user requests. The structure of the human-interface software can be viewed in two ways.

The first (figure 4) shows the tasks that run the human-interface software. The highest-priority task is that associated with the desktop view, and this task controls which human interface task has access to the input devices and display. Each of the open documents or file drawers in the system has a task associated with it. When such a task has access to the input devices and display, the user can view and manipulate the associated document and its elements. At any time, the user may press the Desk Top button, activating the desktop task, which takes over the input device and display and which may, at the user's request, cause another task to get the input device and display.

Figure 5 shows the other way of viewing the human-interface software: by its program structure. Each human-interface task executes the program shown in this figure. At the lowest level are the input and display routines that give access to these devices and cause a human-interface task to block if it is not allowed to access the devices when it tries.

Above this are various utility rou-

Why buy a **VISUAL 102** instead of a DEC VT102?

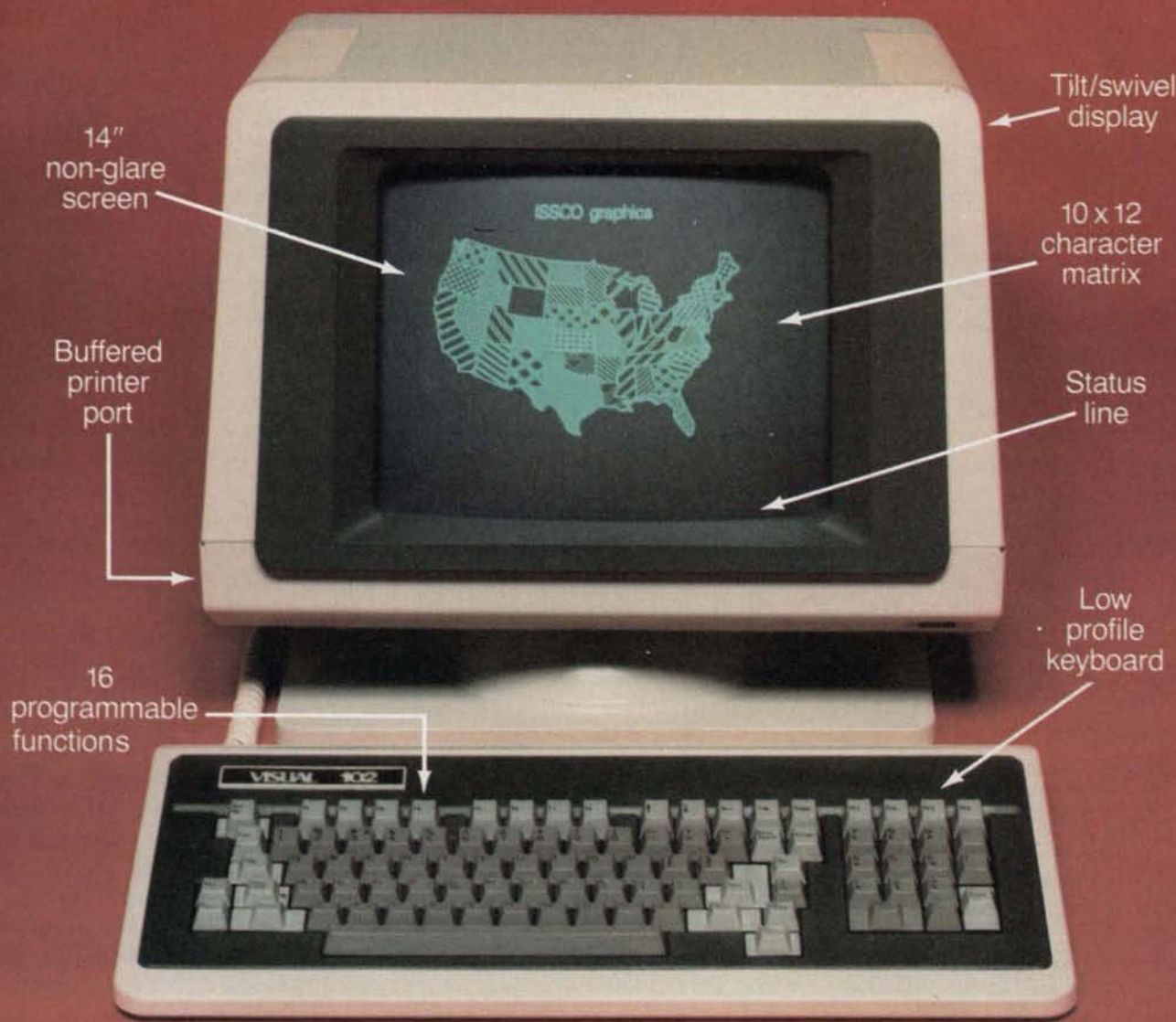

Plus...graphics now or graphics later.

The new **VISUAL 102** gives full DEC VT102[®] performance and more features at a much lower price. Plus, when you need it, a Graphics Option card turns the VISUAL 102 into a 768 x 293 resolution graphics terminal emulating the Tektronix[®] 4010/4014. Just insert the card and immediately you have high resolution graphics compatible with a variety of available software packages.

VISUAL 102. The low cost, DEC VT102 compatible terminal that lets you graph now or graph later.

The UL listed VISUAL 102 exceeds FCC Class A requirements and U.S. Government standards for X-ray emissions.

VISUAL See for yourself

Visual Technology Incorporated
540 Main Street, Tewksbury, MA 01876
Telephone (617) 851-5000. Telex 951-539

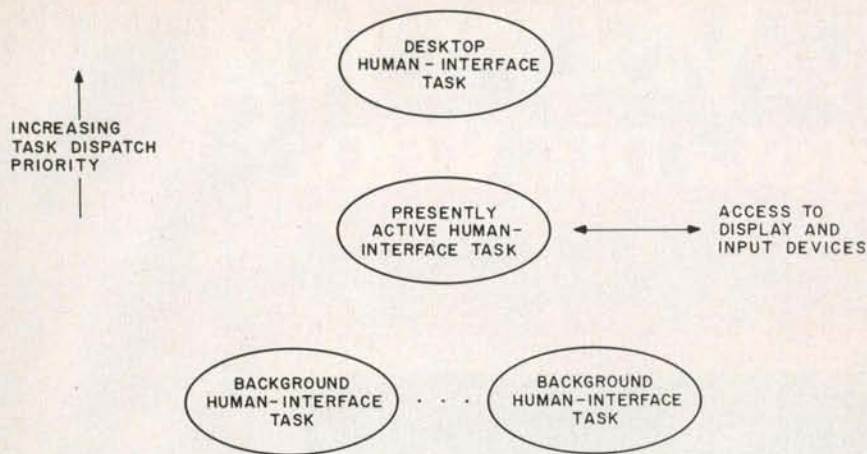

Figure 4: The structure of the tasks that run the human interface.

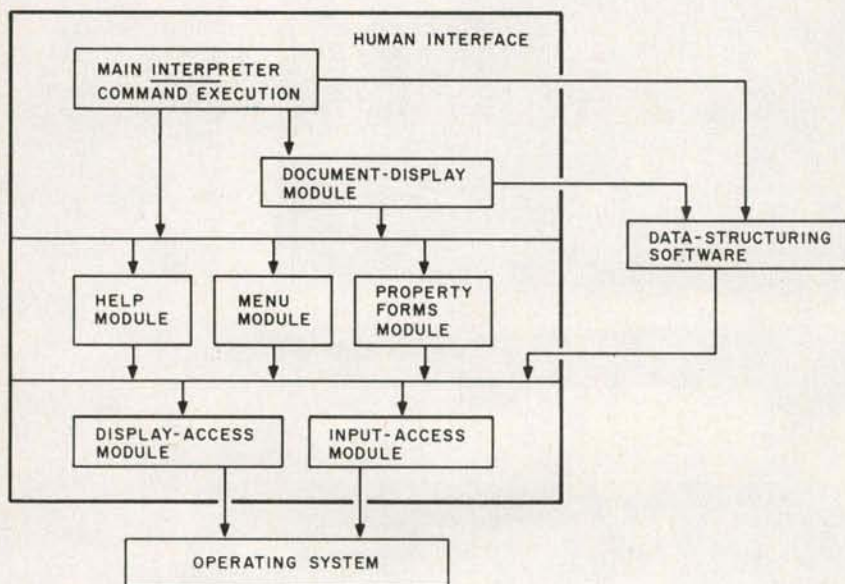

Figure 5: The components and structure of the human-interface software.

tines for displaying menus of operations and property forms. Also here is the Help module, which is called on to provide help whenever the user presses the Help button. This module gathers information from its environment and answers any of a set of questions that the user can select, such as "where am I?" "what just happened?" or "what can I do next?"

Next is the document-display module, which has primary responsibility for causing a document and its elements to be displayed. It figures out which elements in a document are to be displayed on what parts of the screen and calls the appropriate entry points in the element managers

to cause the elements to be displayed there. This module also remembers what parts of what elements have been selected and handles all movement of the viewing window on a document.

The top part of the human-interface code is the main interpreter, which actually reads the user's actions on the touch pad and keyboard and performs the appropriate action. Note that according to this organization, the central human-interface software is always in control and that the application element managers are only invoked when the human-interface software deems it appropriate. This not only means that common code is concentrated in the human-

interface software, it also ensures a uniformity of response, as the user is always dealing with the human interface.

Application Software

There are basically three ways in which an application can fit into the Gavilan portable computer's software system. The first is as an element manager, and most of Gavilan's applications use this mechanism to interact with the user. Often such applications also involve a cell store.

The second way is as a more conventional application program. In this case the application code is associated with a human-interface task, but it replaces the main interpreter and the document-display module. Although it must still follow the human-interface conventions as to when it has access to the keyboard and display, it has a great deal more freedom about how it interacts with the user. Gavilan's communication and terminal-emulation application is one that follows this style.

The third application style is to interact with the user through a form. In this case the application is associated with a human-interface task that displays a document with form elements in it. The user interacts with the form element manager through the main interpreter of the human interface, viewing and filling out the form. At various times, the user can activate buttons on the form, invoking the applications program. Through a cell store associated with the form, the application can read values from the blanks in the form and write values to other blanks in the form. Thus, a life-insurance application could use a form to gather data about a potential client and then use another form to display net worth and other financial results for the client.

In all cases, the application code can access conventional files held by the data-structuring software, retrieving, updating, and displaying data from these files. ■

John Banning is vice-president of software engineering for Gavilan Computer Corporation (240 Hacienda Ave., Campbell, CA 95008).

...SORRY CHARLIE
FOR LEAVING
YOU OUT!



**FOR \$1995 FEATURES
INCLUDE:**

16 Bit CPU
With 128K RAM Memory
Expandable to 256K,
Two 320KB Slimline
Disk Drives,
Floppy Disk Controller,
Monochrome Monitor and
Adapter, Parallel and
Serial I/O's.

**BEST OF ALL!
TEN DAYS FREE TRIAL
ALL YOU PAY IS
SHIPPING!
Suggested List \$2395**

**CALL OR WRITE
FOR MORE DETAILS
OR SEND \$1995 + TO:
TAVA CORPORATION
16861 Armstrong,
Irvine, California 92714
714/261-0200**

**Headquarters/Telex: 181667
Answer Back COMPDSHACK IF**

**IBM® COMPATIBILITY
FOR \$1995** A Special Introductory Offer ††

TAVA PC
**THE SMART COMPUTER USER
WANTS REAL VALUE WITH
IBM COMPATIBILITY!**

Circle 348 on inquiry card

THE TAVA PC. The ultimate Personal Computer. It gives you IBM PC® Compatibility at a fraction of the cost. Choosing a personal computer is a difficult decision. But, when your decision is a TAVA PC, it's not hard at all! The TAVA PC runs under DOS 1.1, 2.0, CP/M86®, and p-System®. You can choose from a large library of all the most popular IBM PC software products such as dBaseII®, Lotus 1-2-3®, Visicalc® and thousands more.

CP/M86 is a registered trademark of Digital Research, Inc.
UCSDp is a registered trademark of Softech Microsystems
dBASE II is a registered trademark of ASHTON-TATE, Inc.

IBM PC is a registered trademark of IBM Corp.
Visicalc is a registered trademark of Visicalc



©TAVA CORPORATION 1983 †California residents add 6% sales tax. †Offer ends February 29, 1984
††Allow two to six weeks delivery. LOTUS 1-2-3 is a registered trademark of Lotus Development

How HP business graphic



Enhance your reputation for being more professional, persuasive, credible and effective than your competition with the new HP 7475A Business Professional's Plotter.

Make a first impression that lasts

The vital importance of graphics to today's business professional cannot be overstated. In survey after survey, statistics prove graphics can help you spot trends and relationships quickly, analyze data accurately, and communicate your ideas with more

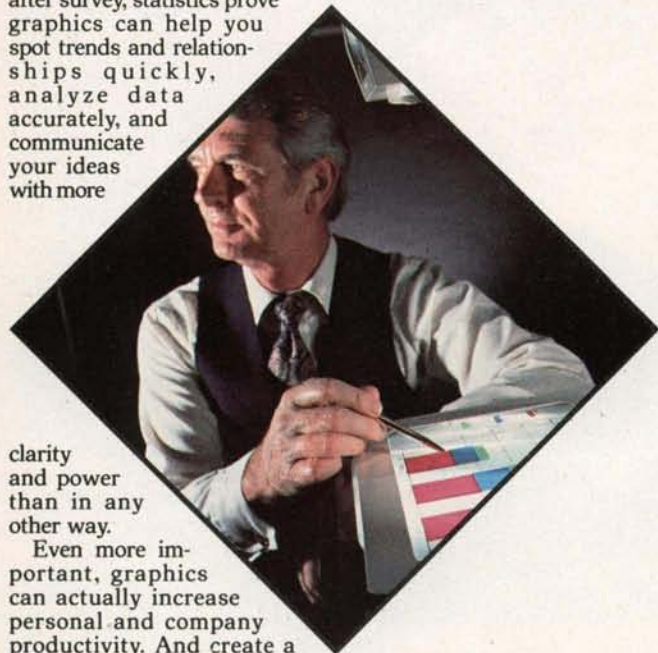

clarity and power than in any other way.

Even more important, graphics can actually increase personal and company productivity. And create a first impression of quality and professionalism that lasts and lasts.

Graphics: the end to meetings that go nowhere

In a fascinating research project conducted by The University of Pennsylvania, 123 MBA candidates were involved in a study designed to test the effectiveness of business graphics in meeting situations. The results were startling. In the group where visual aids were used:

- **Meetings were shorter:** The study showed a 28% reduction in meeting length when transparencies were used.
- **Group consensus was faster:** Agreement was reached by 79% of the group using transparencies, compared with only 8% among the control group using no visual aids.
- **The decision process was accelerated:** 64% of study participants said they made their business decisions *immediately after the visual presentation*. When overheads were not used, the control group said they delayed decision-making until *some time after the group*

discussion following the presentation.

• Presenters with visual aids were perceived as being more professional, persuasive, credible and effective than those not using visual aids.

Now, with the new HP 7475A Business Professional's Plotter, your meetings can have immediate and productive results like these.

How the quality look of HP graphics can help

The way you present your information can be equally as important as the actual information you're presenting. And that's where the new HP 7475A Business Professional's Plotter lets your professionalism shine through.

Standards unsurpassed in the plotter business

The technical standards of the HP 7475A have no equal for producing quality graphics. With a resolution of one-thousandth-of-an-inch, curved lines are smooth, not jagged, and straight lines are consistently straight. Its exceptional repeatability (the ability of a pen to return *precisely* to a given point) assures that intersecting lines and circular shapes will meet *exactly*. The result is *high-quality* charts and graphs you'll be proud to present.

Why 6 pens when experts say 4 will do?

Graphics industry experts maintain that good graphics contain four colors per chart. But Hewlett-Packard goes the experts two better by providing a six-pen carousel, so you can store and use pens of different widths—thick pens for bold headings and thin pens for details. And with six pens, you won't have to waste valuable time changing them. That's important when "the boss wants to see your presentation in twenty minutes!"

With the HP 7475A, you also get automatic pen capping to prevent pens from drying out between uses, and special "pen damping" (gently lowering the pen to the paper or transparency) to increase pen life and ensure better line quality... use after use after use. You also get a rainbow of 10 colors to choose from, in two line widths.



Your choice: 2 paper sizes and today's most popular graphics software packages

While most professional business applications will be satisfied with standard 8½ x 11" paper or transparencies, the HP 7475A adds the

can be the key to your success.



capability of plotting on larger 11 x 17" media, too. The larger plots are especially well-suited for time lines, PERT charts, schematics and engineering drawings.

Best of all, you don't have to be a programmer to produce quality graphics on the HP 7475A. It's supported by a variety of professional graphics software packages for both HP and non-HP desktop and personal computers.

Naturally, speaking of software compatibility leads us to hardware compatibility...

Compatible with almost any personal computer in the marketplace today

With two interfaces available, the HP 7475A quickly "makes friends" with most models of today's most popular personal computers, including IBM® Apple™ Compaq™ Osborne® and Commodore™ --as well as a host of HP computers.

The cost? Surprisingly affordable

The new HP 7475A Business Professional's Plotter is an amazingly affordable \$1895. When you consider that a typical fee for a single five-color transparency from a graphics service is \$50—and that the same transparency can be prepared for about \$1 in materials on the HP 7475A—the return on your investment is almost immediate.

Another choice: HP's low-cost, high performance Personal Computer Plotter

For the "business on a budget," you may also want a look at our 2-pen Personal Computer Plotter, the 7470A. Its low cost (only \$1095) is as remarkable as the quality of its plots. With many of the same features as the new HP 7475A, the HP 7470A plots on a single paper size (8½ x 11"). It stores and caps two pens,

and you can easily change the pens yourself for multi-color plotting. Best of all, the HP 7470A 2-pen plotter lets you turn your personal computer into a personal graphics workstation for only \$1095.

Send for your FREE "Better Presentations Package" today!

For a FREE sample plot, overhead transparency, and more details, mail the coupon below today. We'll also enclose a list of software packages you can use with the HP 7475A or HP 7470A.

For the name of your nearest Hewlett-Packard dealer call toll-free 800-547-3400.

1101303

 **HEWLETT
PACKARD**

YES! I'm ready to gain a reputation for being more professional, persuasive, credible and effective than my competition. Please send me your FREE "Better Presentations Package," so I can learn more about the new HP 7475A Business Professional's Plotter and the HP 7470A Personal Computer Plotter. I understand I will receive this valuable package without cost or obligation.

Name _____ Title _____

Company _____

Address _____

City/State & Zip _____

Phone Number (____) _____

My computer is _____

Send to: Hewlett-Packard
16399 W. Bernardo Drive, San Diego, CA 92127
Attn: Marketing Communications 11303 BT1

SPECIAL
California Computer's expandable single board micro featuring a Z80 CPU 64K 1 parallel, 2 serial ports-2 DSD 8" floppys (2 meg) included Perfectwriter, Calc, Speller, Filer-Calcstar \$2650.

SPECIAL
U.S. Robotics - Pass-word 1200 Baud-Autodial. Virtually compatible with every Micro - 1 year warranty \$379.

ONLY AT MICROHOUSE
Use our exclusive microcharge to finance all of your purchases. Call us!

FINANCIAL

Supercalc	\$119
Supercalc II	164
Visicalc	165
Visicalc Advanced	299
Visitrend/Plot	218
Desktop Plan	218
Visischedule	189
Multiplan	99
Calcestar	49
Home Accountant—Apple	395
Planstar	189
Scratchpad	259
Bottom Line Strategist	Call
Lotus	Call

WORD PROCESSING

Wordstar	\$269
Wordstar/Mailmerge	349
Wordstar/Mailmerge/Spellstar	444
Star Index	119
Final Word	185
Superwriter	169
Spellguard	119
Spellstar	139
Volkwriter	149
Multitool Word	269
Mailmerge	139
Visiword	269
Perfectwriter	239

IBM HARDWARE

Tandon 100-2	\$ 259
CCS 132 Columns	699
Quadboard 64K	295
Quadboard 256K	439
Quadcolor I	235
Microsoft Mouse	159
Datamac 19 Meg Int	2099

DATA BASE

dBase II	\$429
dBase II/dUtil	489
dUtil	68
Quickcode	199
Tim III	269
Datastar	169
Infostar	279
Alpha Data Base Manager II	209

COMMUNICATIONS

US Autodial	\$479
Password	379
Autolink 300	179
Hayes 1200 Baud	544
Hayes Smartmodem	219
Micromodem II	299
Hayes Chronograph	199
Cross Talk	117

PRINTERS

Prowriter Parallel	\$ 399
Prowriter Serial	594
F-10	1259
Ribbons	Call
Grappler	125

PRINTER BUFFERS

16K Microfazer P-P	\$149
256K Microfazer P-P	649

SPECIAL

Prices on Maxell Disks lifetime warranty
MD1 \$28.95 MD2 \$40.95
FD1 \$39.50 FD2 \$46.50
in boxes of 10 each.

LANGUAGES

BASIC 80 Compiler	\$279
BASIC 80 Interpreter	249
MACRO 80	145
FORTRAN 80	269
COBOL 80	545
muLISP/muSTAR	144
muMATH/muSIMP	179
C Compiler	189
PASCAL Compiler	249
Digital PLI	439
Digital ADA	489
Supersoft FORTH	219
Supersoft LISP	219
RATFOR	129
	79

We accept purchase orders VISA, MasterCard, American Express, COD's

800 523-9511
in Pennsylvania
1-215-868-8219

Box 499 Dept 100
Bethlehem, PA 18016

FULL SERVICE AND SELECTION

MICROHOUSE

Prices subject to change without notice.

Reviewer's Notebook

by Rich Malloy

The Chameleon Plus

Last month I mentioned that Seequa Computer Corporation of Annapolis, Maryland, was going to send us a revised version of its low-priced Chameleon. The first unit the company sent us had some difficulty with its serial port and its parallel printer port. In addition, its documentation was somewhat lacking.

This month, I am pleased to report that Seequa has delivered on its promise. We recently received a Chameleon Plus that seems to be in almost perfect working order. The parallel printer port works without a flaw, as does the serial port. And the documentation for the MS-DOS operating system seems as complete as that for any other computer. There are still a few very minor rough edges (we still haven't received MBASIC or the CP/M-80 operating system yet), but this machine looks pretty good.

Note, however, that the Chameleon Plus is not the \$1995 system I mentioned last month. The \$1995 system has only single-sided disk drives (160K bytes each) and 128K bytes of memory. In contrast, the Chameleon Plus has the more useful double-sided drives (320K bytes each) and 256K bytes of memory. It also costs more—\$900 more, to be exact, for a total of \$2895. That puts it in the same league with other portable IBM clones from Corona and Columbia and even the slightly higher-priced Compaq. The ace up Seequa's sleeve, however, is its CP/M-80 compatibility, and the real value of the Chameleon will depend on how well the company supports that capability. Look for a detailed review of this machine soon.

On the Printer Scene

As anyone who has been watching

the printer market has probably observed, a number of trends appear to be developing. For example, several good quality daisy-wheel printers have been introduced at fairly reasonable prices, and some are even sprouting keyboards. Not to be outdone, more and more electronic typewriters are coming out with computer interfaces. Meanwhile, dot-matrix printers with increasingly high resolution are appearing. A few of these machines have come our way recently.

Comrex, which is part of the Epson family, has been selling daisy-wheel printers for some time, seemingly in competition with the tremendously successful dot-matrix printers made by its parent company. Comrex's latest offer, called the CR-II Comriter, is a variation of the Brother HR-15 printer, and at \$599 for a parallel version (\$649 for serial), it's a good buy.

The CR-II prints at about 13 characters per second (cps), which seems common for low-cost daisy wheels. It can print at a pitch of either 10, 12, or 15 characters per inch or do proportional spacing, but the proportional spacing requires a special daisy wheel. I've been using the CR-II with letterhead paper and it's been giving me some very nice-looking documents. My only real complaint is that its page-feed mechanism is a bit awkward.

In the dot-matrix category, Mannesmann Tally of Kent, Washington, a division of the giant Mannesmann conglomerate in West Germany, has been quietly producing high-quality printers for some time now. Lately, it has begun producing printers at more reasonable prices.

The latest printer from Mannesmann Tally is called the Spirit-80. About the same size as the Epson MX-80 and priced at \$399, the

Spirit-80 seems to be a good product for the home market.

The Spirit has one of the best character fonts I've seen on a low-cost dot-matrix printer, thanks to a Mylar ribbon and the use of square print hammers. All of the dots actually connect with each other. It prints at 80 cps. And the choice of pitch is similar to that of the early Epson MX-80: 9, 10, and 17.8 characters per inch.

The TI 855 printer from Texas Instruments is the latest in a line of TI printers. This new dot-matrix printer offers incredibly high resolution at a fairly reasonable price (\$935 for friction feed, \$995 for tractor feed). In letter-quality mode, each character is composed of an 18- by 32-pixel grid. These characters are almost indistinguishable from typewritten ones. As for speed, the TI 855 prints at 35 cps in letter-quality mode and 150 cps in draft mode.

Perhaps the most interesting feature of the TI 855 is that the character-font generator routines are stored in removable cartridges. These cartridges can be interchanged just like daisy wheels, and three cartridges can be connected at one time. You can switch from regular Courier type to italic type and even to Orator type at the push of a button.

One of the nice little things about the TI 855 is that you don't have to turn the printer off line before you press the page-feed button, which spares you a lot of button pressing.

The TI 855 seems to be a solidly built printer. We've been using it to print out our voluminous manuscripts, and it's been working very well. I only wish we had some graphics software that could take advantage of its high resolution. Maybe next month. ■

Rich Malloy is BYTE's product-review editor.

The Zenith Z-100

This system offers the best of the 8-bit and 16-bit worlds

by Ken Skier

After haunting computer stores and attending computer shows for more than a year, I despaired of ever finding a system that would meet my requirements. What were my requirements? I just wanted the best of both worlds. I needed an 8-bit CP/M system to run the editor and cross-assembler I use in software development, yet I didn't want to lock myself into an 8-bit environment. With all the new software coming out for the IBM PC and its work-alikes, I wanted to be able to run those applications as well. And although I had no immediate need for graphics software, I wanted a system that would support graphics displays because . . . well, just because they're so pretty.

And graphics were what first drew my attention to the Zenith Z-100. I was trudging down yet another aisle at last fall's Northeast Computer Show, hoping that this one might be the last, when an absolutely stunning display of color graphics stopped me in my tracks. "What's this?" I asked the man. "This" was the new computer from Zenith Data Systems, the Z-100. It had just the kind of split personality I was looking for: an 8-bit side consisting of an 8085 running CP/M and a 16-bit side consisting of an 8088 supporting MS-DOS (known as Z-DOS when it runs on the Z-100). Here was one system that seemed to offer me the best of both worlds. And to put the icing on the cake, its color graphics clearly outclassed the IBM PC's.

So I bought it. And I've used it far more than 40 hours a week for the last eight months. After that kind of road test, I can report that I am still impressed by the machine. Let's see why.

Physical Aspects

The Z-100 comes in two basic configurations: the Low-Profile unit and the All-in-One. The All-in-One (photo 1) features a built-in monochrome CRT (cathode-ray tube). The Low-Profile unit lacks a display, but it's only 7 inches high and designed to serve as a base for an external monitor. Both units provide signals for an external RGB (red, green, blue) or monochrome video

monitor.

Both units are 19½ inches on a side. The All-in-One is 13½ inches high; the Low-Profile unit, true to its name, stands only 7½ inches tall. Each has room internally for two 5¼-inch floppy-disk drives or for one floppy-disk and one Winchester drive, and each can support one or two external 8-inch drives as well.

Z-100 is enclosed in a "durable earthtone-color cabinet" that has proved quite resistant to smudges and fingermarks. The optional 8-inch floppy-disk system comes in a cabinet of the same color. It would look at home in any business or professional setting.

The Display

The Z-100's text display (photos 2 and 3) consists of 25 rows of 80 characters, each formed from a 5 by 9 dot matrix. The characters are crisp and clean, and the letters g, j, q, and y have true descenders.

Under ZBASIC, text can be displayed in any of eight colors, and all selected colors may be visible on the screen at the same time. By exchanging the foreground and background colors, you can display text in reverse video. Furthermore, ZBASIC gives you control of each pixel on the screen, so you can underline any text or move words and numbers up and down to create superscripted and subscripted text. These display attributes, however, are up to the programmer; they are not built into the operating system.

The Z-100's graphics capability (photo 4) is impressive: 225 rows of 640 pixels. If color memory has been installed, you can assign any of eight colors to any pixel. (An RGB monitor is necessary to do justice to the Z-100's color graphics capability; with a monochrome monitor, you will see only eight levels of gray.) Text and graphics can be displayed on the screen at the same time.

The display is bit-mapped as three planes of color: one 64K-byte plane each for red, green, and blue. Although ZBASIC includes powerful graphics commands and statements, the assembly-language programmer may choose to access the screen directly by reading and



Photo 1: The Zenith Z-100. This version features a monochrome monitor in All-in-One style. In another configuration, the Low-Profile style, the monitor is in a separate enclosure and the disk drives are arranged horizontally above the keyboard. An RGB color monitor is available for both styles. Note that the keyboard has an IBM Selectric-style key layout, with a numeric keypad on the right and a row of function keys along the top.

writing the appropriate bytes in memory.

The Keyboard

The keyboard is one of the great strengths of the Z-100. It consists of a standard typewriter keyboard bordered on both sides by such frequently used keys as Control, Help, and Delete, and topped by a row of 13 programmable function keys. To the right is a keypad of numeric and cursor keys. There are 95 keys in all.

The keyboard has the feel of a Selectric typewriter or dedicated word processor. The keys are nicely sculpted, travel about an eighth of an inch, and bottom out positively. They are also extremely reliable. I am not a gentle typist. (In my last job, I had to have my dedicated word-processing keyboard replaced every few months.) Yet the Z-100 has stood up now under eight months of my hammer-handed typing and never missed a key.

The typewriter keyboard itself has an absolutely conventional, Selectric-style layout. The Shift keys are where you would expect them to be, as are the Tab and Return keys. The Tab key is properly oversized, and the Return key is oversized and shaped like a backward "L"—a great big target that you can't miss, no matter how fast or wild you type.

The 13 programmable function keys in the top row can be assigned any function quite readily in ZBASIC (a version of Microsoft BASIC almost identical to IBM's BASICA). A special Help key can be used by programmers to make their programs self-documenting, but not all applications programs take advantage of this key. Those that do, of course, are much easier to use than those that don't. Someday . . . ah, someday every computer will have a Help key, and every program will take advantage of it.

All keys repeat automatically if held down. The nor-

mal repeat rate is 11 characters per second, but by holding down the Fast Repeat key, you can make any key repeat at 28 characters per second. I find this feature tremendously convenient, especially when I want to space halfway across the screen or enter a row of asterisks into a program.

Like many dedicated word processors, the Z-100 clicks to acknowledge each keystroke. I like getting this confirmation, but if you find it distracting, you can type an escape sequence (described in the Z-100's excellent documentation) to suppress the key-click.

Part of the numeric keypad is a dedicated cursor pad. Its layout is usable but less than ideal. If the cursor keys were laid out in a diamond pattern, they would be easier to use. They would also take up more space, but I would willingly sacrifice the numeric pad for a diamond-shaped cursor pad. Or Zenith could make the Z-100 a little wider, to make space for a diamond-shaped cursor pad and a numeric pad.

Disk Drives

As I mentioned before, the Z-100 has room internally for two 5¼-inch floppy-disk drives or for one 5¼-inch and one Winchester drive; it can also support one or two external 8-inch drives.

The 5¼-inch floppy-disk drives hold 320K bytes of data (formatted) and are compatible with the IBM PC's drives. Thus, you can create a file on a Z-100 (running Z-DOS) and save it on a floppy disk, then carry that disk over to an IBM PC (running PC-DOS) and access that file. (However, although Z-100 disks are compatible with IBM PC disks, that doesn't mean that you can save a program on one machine and run it on the other. More on that later.)

My main concern in dealing with any disk drive is its

The Display

The Z-100's text display consists of 25 rows of 80 characters, each formed from a 5 x 9 dot matrix. The characters are crisp and clean, and the letters g, j, q, and y have true descenders.

Under ZBASIC, text can be displayed in any of 8 colors, and all selected colors may be visible on the screen at the same time. By exchanging the foreground and background colors, you may display text in reverse video. Furthermore, ZBASIC gives you control of each pixel on the screen, so you can underline any text, or move words and numbers up and down to create superscripted and subscripted text. These display attributes, however, are up to the programmer; they are not built into the operating system.

The Z-100's graphics capability is impressive: 225 rows of 640 pixels. If color memory has been installed, you can assign any of eight colors to any pixel. (An RGB monitor is necessary to do justice to the Z-100's color graphics capability; with a monochrome monitor, you will see only eight levels of grey.) Text and graphics may be displayed on the screen at the same time.

The display is bit-mapped as three planes of color: one 64K plane each for red, green, and blue. Although ZBASIC includes powerful graphics commands and statements, the assembly-language programmer may choose to access the screen

Photo 2: An example of text on the Z-100's monochrome display.

reliability. The 5¼-inch floppy-disk drives on the Z-100 have proved themselves reliable beyond my wildest expectations. In the first six months of very heavy use, the drives performed flawlessly. (I even had disks survive power outages—with no loss of data!) However, I did encounter some disk errors when I persisted in using the Z-100 during periods of extremely hot, muggy weather. (Installing an air conditioner and cleaning the heads solved that problem.)

Unfortunately, 8-bit CP/M software is hard to come by in the Z-100 5¼-inch format. I've resorted to buying it on 8-inch disks and having my dealer transfer files from

be displayed in any of 8 colors, you may display text u control of each pixel on words and numbers up and do d text. These display attr not built into the operatin

Photo 3: A close-up of text on the Z-100's monochrome display.

the 8-inch disk to a Z-100 floppy disk. Or, if you have access to a Kaypro, you can use it to transfer files from many common 5¼-inch formats to the Z-100 format. (Of course, if the Kaypro can do it, why can't the Z-100? If the Z-100 could read assorted 5¼-inch formats, I'd have a much easier time acquiring software. How about it, Zenith?)

The optional 8-inch disk system includes one drive (\$1599) or two drives (\$2299) and stores 1.25 megabytes on each disk. The advantages of this system include—obviously—much more data storage on line as well as faster disk access and the ability to buy software in the

At a Glance

Name

Zenith Z-100

Manufacturer

Zenith Data Systems Inc.
1000 Milwaukee Ave.
Glenview, IL 60025

Components

Size: 19.5 by 19 by 7.5 inches
Processors: 8085, 8-bit, 5 MHz; 8088, 16-bit, 5 MHz
Memory: 128K bytes system memory (expandable to 768K), plus three 64K-byte planes of screen memory; all parity-checked

Display

Text: 25 rows of 80 characters, 5 by 9 dot matrix ("soft" character set, dynamically redefinable)
Graphics: 225 rows by 640 dots; 8 colors
Output: RGB and monochrome video

Keyboard

95 keys, including 13 user-programmable function keys and an 18-key numeric and cursor pad
Repeat rate: 11 characters/second; with Fast Repeat key: 28 characters/second

Mass Storage

Two internal 5¼-inch floppy-disk drives, double-sided, 320K, IBM PC-compatible; controller supports two external 8-inch drives as well; optional 11-megabyte Winchester may replace one of the internal drives

I/O

Two EIA RS-232C serial interface ports, software-configurable for 110 to 38,400 bps; one 8-bit Centronics-compatible parallel port (output only)

Expansion

Bus provides five IEEE-696 (S-100) slots; disk controller occupies one

Software

None included; CP/M-85 and Z-DOS (MS-DOS) are available, as are 8-bit MBASIC, 16-bit ZBASIC, 1-2-3, Microplan, Wordstar, Peachtext 5000, and other programs

Options

The Z-100 is available with 0, 1, or 2 built-in 5¼-inch drives; with or without a built-in monochrome monitor; assembled and tested (as the Z-100) or in kit form (as the Heathkit H-100). Software package of Z-DOS, CP/M-85, ZBASIC, and MBASIC available for \$300

Documentation

278-page *User's Manual*. Two ring-bound manuals accompany each of the following software products: Z-DOS, ZBASIC, CP/M-85, MBASIC, and Multiplan

Price

Prices range from \$2199 for the HS-100-31 (kit with one drive, 192K RAM, monochrome graphics) to \$3499 for the ZF-110-22 (assembled unit with two drives, 128K RAM, color graphics) to \$5599 for the ZW-120-32 (assembled unit with one floppy-disk drive and one Winchester, 192K RAM, monochrome graphics, built-in nonglare green CRT)



For users of Apple, IBM, TRS/80, Atari, Commodore, Texas Instruments, and other brand name computers:

Here's the easiest way to buy quality diskettes at discount prices

Now you can get error-free double density diskettes by IBM, Control Data, Maxell and Verbatim delivered to your door. For some of the lowest prices around.

You save because we ship huge volumes of magnetic media in boxes of 10.

To order, use this form.

For even faster service, call toll-free.

1-(800)-FLOPPYS or

1-(800)-521-5700

Michigan • 1-800-482-4770

Canada • 1-800-265-4824

Alaska/Hawaii • 1-800-821-9029

ALL MAJOR CREDIT CARDS ACCEPTED

Shipping & handling F.O.B. Southfield
Transaction Storage Systems Inc., Southfield, MI



EXPECT A MIRACLE

Circle 361 on inquiry card.

Size	IBM Qty.	Verbatim Qty.	Control Data Qty.	maxell Qty.
5-1/4" SS	23.90	23.90	19.90	28.90
5-1/4" DS	34.90	34.90	29.90	41.90
8" SS	24.90	—	28.00	—
8" DS	39.90	—	29.90	—
Sub Totals	\$ _____	\$ _____	\$ _____	\$ _____

Name _____ Title _____
 Company _____
 Address _____
 City _____ State _____ Zip _____
 AMEX MASTERCARD VISA
 Card # _____ Exp. Date _____
 Shipping and handling 1-6 boxes add \$4.00 per order
 7 or more add \$6.00 per order.
 Clip and mail today to: Transaction Storage Systems, Inc.,
 22255 Greenfield Road, Southfield, MI 48075
 B1/84



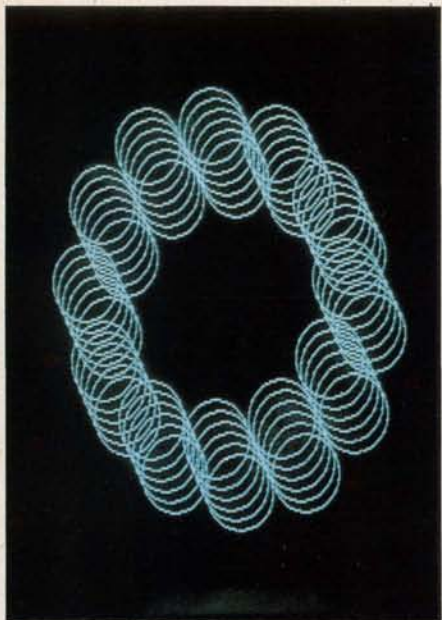

Photo 4: An example of graphics on the Z-100's monochrome display.

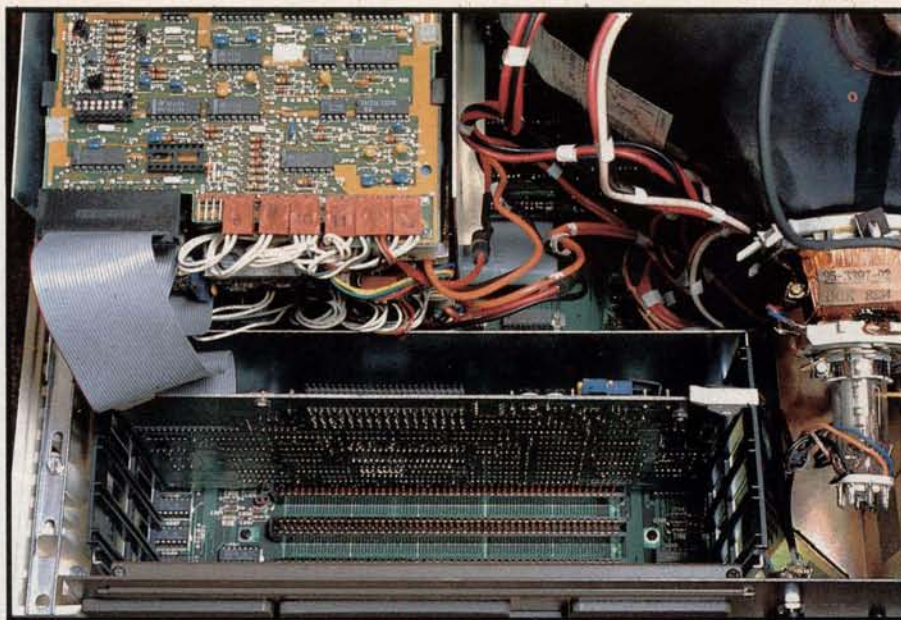

Photo 5: Inside the Z-100. The S-100 bus sits behind the disk drives and disk-drive controller (upper left) and the display (upper right). Access to this bus is very simple. The top cover of the machine can be easily removed, without unfastening any screws.

8-inch format.

The optional Winchester drive (about \$2400) provides 11 megabytes on line, which may be transferred to or from the Z-100 at 5 megabytes per second—an order of magnitude faster than the 5¼-inch floppy-disk drives can manage. That's invaluable if you have a large amount of data, or many programs, on line. Still, you must back up that hard disk eventually, and doing so onto 5¼-inch floppy disks will take some time, since you might need 30 or more disks to complete the operation. Nevertheless, one can hardly fault Zenith for offering a hard disk with so much capacity.

Microprocessors

The Z-100 is a dual-processor system. Its 8-bit 8085 lets it run CP/M-85 applications, and its 16-bit 8088 lets it run MS-DOS. Both processors run at 5 MHz.

Note that, although both processors are present, you cannot use them simultaneously, and I am not aware of any applications that transfer control from one processor to another. Thus, in any given work session, the Z-100 is either an 8-bit system or a 16-bit system.

How do you tell the Z-100 which processor to use? Just turn it on and insert the appropriate system disk. If you insert a CP/M-85 disk, the Z-100 will configure itself as an 8-bit, CP/M system. Or cold-start it with a Z-DOS disk, and the Z-100 will configure itself as a 16-bit, MS-DOS system.

Memory

The Z-100 is available with as little as 128K bytes of RAM or as much as 768K, all parity-checked. The main circuit board can accommodate 192K bytes of RAM; additional memory requires memory cards, which plug into the S-100 bus (photo 5).

(With all this RAM on hand, you might want to use some of it as a RAM disk—or, in the 8-bit environment, you might want to access memory beyond 64K through the use of bank-switching. If so, you'll have to look to third-party software developers, since the software supplied by Zenith provides neither RAM-disk capability nor bank-switching.)

In addition to the system RAM just described, the Z-100 contains 64K to 192K bytes of video RAM. Monochrome graphics needs only 64K, whereas color graphics requires 192K: three planes of 64K each, to provide information for the red, green, and blue signals. A Z-100 with only monochrome graphics can be upgraded to color by the addition of 128K bytes of RAM (a \$290 option).

Interfaces

The Z-100 comes with two serial ports, a parallel printer port, a light-pen interface, and outputs to drive RGB and composite video monitors. Sockets for all of these interfaces are on the back of the Z-100 (photo 6), making it easy to have a very neat installation, with all cables out of sight.

The serial ports conform to the EIA (Electronic Industries Association) RS-232C standard. One is wired as DTE (data terminal equipment) and the other as DCE (data communications equipment). Thus, one or the other should be suitable for cabling to almost any RS-232C device.

By running a program called *Configur*, you may set each serial port to any desired data rate, from 110 to 38,400 bits per second. *Configur* also lets you designate odd, even, or no parity; handshaking protocol, if any; and handshaking pin, if any. *Configur* is totally menu-driven and extremely easy to use—it even draws a picture on the screen, showing the back of the Z-100, with

MOST ACCOUNTING SOFTWARE TURNS WORK STATIONS INTO BATTLE STATIONS.

When you have Champion Accounting Software, your personnel can leave the combat zone. Because Champion™ gives you the performance you need, without a fight.

Champion is written in dBASE II™* on one convenient disk. And its features make conventional accounting software obsolete.

PERFORMANCE YOU CAN SEE.

Other software dealers will tell you what they *think* their product will do. Only Champion dealers will *show* you how the software performs:

- Help function provides users with clear, concise, on-line answers to questions about Champion.

- Unparalleled recovery program automatically puts the user's books back in balance in the event of a crash.
- Real time updating. All files are simultaneously updated when data is entered.

PRAISED BY EXPERTS.

"It performs extremely well... If you are looking for a good, competitively priced, fully integrated accounting package... take a close look at this one."

Amanda Hixson
INFOWORLD, 9/83

"...users will find this to be a very comprehensive software package with several attractive features that make it superior to its competition."

Carl Heinz, CPA
INTERFACE AGE, 8/83

For more about Champion performance, see the Champion dealer nearest you. And get the accounting software system that lets you work in peace.

*Champion is a registered trademark of Champion Software Corporation.
**dBASE II is a registered trademark of Ashton-Tate.

Champion Software Corporation
Formerly:
Data Base Research Corporation
66 South Van Gordon, Suite 155
Lakewood, CO 80228, (303) 987-2588

CHAMPION

BUSINESS ACCOUNTING SOFTWARE

Dealer inquiries, Circle 497
All others, Circle 498



NOW AVAILABLE FOR IBM P.C.
CALL (303) 987-2588 FOR A FREE DEMONSTRATION

Users Love PRINTEK Performance

They love the way PRINTEK printers go about doing everything that needs printing. From data processing, to graphics, to executive letter quality correspondence. Day after day. With all the features needed to make your printer performance as good as your computer's.

- ♥ **Three models to choose from.** One for every requirement, every budget—Models 910, 920, 930.
- ♥ **Dual speeds**—up to 80 cps for correspondence and 340 cps for data processing and drafts. Bidirectional/Logic Seeking.
- ♥ **Multiple character sizes**—to fit every need. With true descenders for easier reading and proportional spacing for better appearance. Resident and downloadable fonts.
- ♥ **Multilingual**—to serve computers around the world. With 96 ASCII characters and up to 8 standard languages.
- ♥ **Dual density graphics**—144x144 dots per inch for detail, 72x72 for speed—in raster format with true data compression. Dot addressable.
- ♥ **Versatile paper handling**—up to 6 copies on 2½"-16" paper. For everything from labels to really big spread sheets (227 cols.)
- ♥ **User lover**—quiet (less than 60 dBA), easy-change cartridge ribbon, front panel controls and status indicators, self-diagnostics, easy interfacing, and ready-anywhere multi-voltage power supply.

You, too, can become a PRINTEK lover. Call for the name of your nearest sales representative.

Printek, Inc., Benton Harbor, MI 49022
616/925-3200 TWX 810-270-3112

1-800-368-4636

printek 
best thing next to your computer



Photo 6: Part of the back panel of the Z-100. Along the bottom are two serial connectors (both male and female), a parallel printer port and a light-pen connector. On the upper right is a brightness control for the internal display, just above a connector for an RGB monitor. Note the wealth of cut-outs for optional connectors.

an arrow pointing out the DB-25 connector for the port you've selected. The only way it could be more user friendly is if it had hands coming out of the screen to plug in your cable for you.

I have connected my Z-100 to a variety of computers, printers, and other RS-232C devices, both for input and for output, and have always found the interfacing to be quick and easy. Would that RS-232C communication could always be established so readily.

The Z-100 also features a Centronics-compatible parallel port, making it a simple matter to connect the Z-100 to any parallel-interface printer, plotter, or similar device.

A light-pen port is available, but Zenith does not yet provide a light pen to go with it.

Signals are available for both RGB and composite video monitors. You can drive both types of monitors at once, but both will show the same picture; you can't show one picture on one monitor and a different picture on the other.

If you need more I/O (input/output) than this, you can always plug in an S-100 card to provide the number and type of ports you need.

Software

The Z-100 runs 8-bit CP/M and 16-bit MS-DOS—probably the two most popular operating systems for today's personal computers. A powerful version of Microsoft BASIC is available for each operating system: MBASIC for CP/M, and ZBASIC for MS-DOS.

ZBASIC is almost identical to BASICA, the most powerful version of BASIC available for the IBM PC. They seem to differ only in some of the graphics statements. ZBASIC offers greater resolution and more colors than BASICA, but BASICA offers several screen "pages," whereas ZBASIC offers only one.

I prefer ZBASIC. With BASICA, you must decide at the outset whether you want a high-resolution, monochrome display, or a low-resolution, four-color display. With the Z-100, that decision is unnecessary. All text and

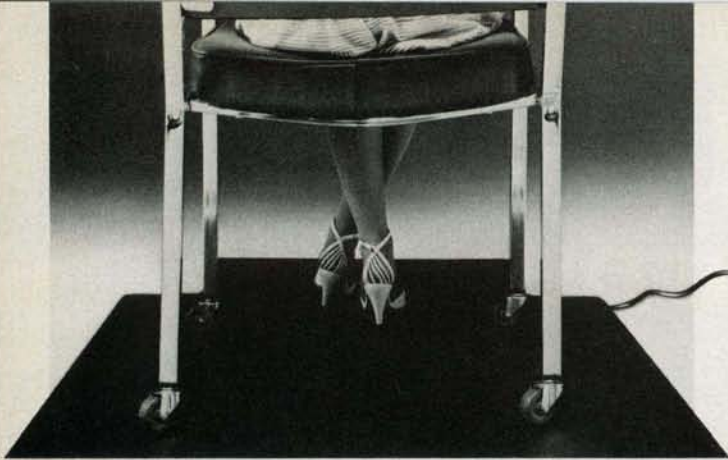

YOU CAN'T FIGHT STATIC SITTING DOWN.

Static electricity exists everywhere in an office environment—it's not just confined to a few square feet around a CRT. And when you consider that someone casually walking past a terminal can generate enough charges to trigger a major malfunction, it's clear that a small anti-static mat is hopelessly ineffective in protecting sensitive computers.

The solution is Staticide®. Unlike bulky mats, which can be unwelcome in a smartly-decorated office setting, Staticide provides an invisible barrier against static—a shield that remains in effect for up to six months with a single application. And while mats can cost hundreds, a quart of Staticide is only a few dollars. What's more, now you could wipe out static and dust attraction on CRT screens and keyboards with new Staticide® Wipes™.

Staticide from ACL. When you compare it against anti-static mats, the results will floor you.

Staticide
by ACL Incorporated



1960 East Devon Ave.
Elk Grove Village, IL 60007
(312) 981-9212, TELEX: 4330251

Circle 10 on inquiry card.



We offer no static
to our customers.

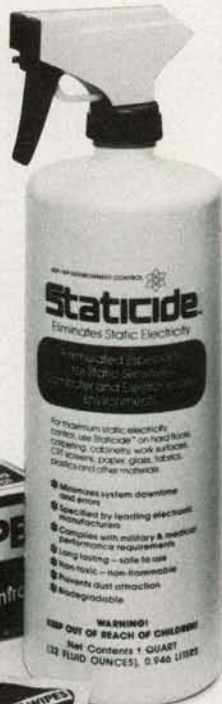

graphics are displayed in high-resolution mode. There is no need to issue a SCREEN statement to configure the screen; you may PRINT, DRAW, PAINT, or create a LINE in any of eight colors at any time.

With the exception of the graphics and certain parameters used in opening RS-232C ports, BASICA and ZBASIC seem to be identical. Almost any program written in BASIC for the PC should run on the Z-100, with little or no modification. (Of course, if it uses PEEKS, POKES, CALLS, and USR functions, all bets are off.) Nonetheless, you cannot simply take a disk that has an IBM PC BASIC program, insert it into a Z-100, and run it. It won't work, and when you list the program, it won't look right. Why not?

The answer has to do with the way each version of BASIC tokenizes a BASIC program. (A token is a byte used by the BASIC interpreter to represent a keyword. Tokenizing a BASIC program makes it take up much less space in memory or on disk.) A program in memory is always tokenized.

When you save a program on disk, it is normally saved in tokenized form. But BASICA and ZBASIC use different tokens to represent the same keywords. For example, BASICA might use the token \$8A to represent the keyword PRINT, while ZBASIC might use the token \$A2 to represent the same keyword. If you save a BASICA program in tokenized form and then load it into the Z-100, ZBASIC will interpret it as a different program. Every PRINT statement, for example, might be interpreted as a GOTO. No wonder the program won't run.

Fortunately, there is a simple solution. To transfer an IBM PC program to the Z-100, first save it in ASCII (American National Standard Code for Information Interchange) format. (A program saved in ASCII format has all keywords spelled out; they are not represented by tokens.) To save a program in ASCII format, use the optional argument [,A] like this:

```
SAVE "PROGRAM.BAS",A
```

Now you can take the disk over to a Z-100 and load the program. ZBASIC will interpret every PRINT statement as a PRINT statement and will correctly interpret all other keywords as well. Then if the program doesn't run immediately, it should be a relatively simple matter to modify it to make it run.

What about applications programs? Some of the most popular applications for the IBM PC are already available for the Z-100: 1-2-3, Multiplan, Wordstar, and Peachtext 5000, to name a few. And as new products are announced for the PC, their developers often state the intention of bringing out a version for the Z-100. However, the Z-100 is not totally PC-compatible, so don't expect any arbitrary PC application to run on the Z-100 right out of the box. Some will, some won't. That's probably the most frustrating thing about the Z-100. I think it's a better machine than the PC, but sometimes I just wish it were a PC, so I wouldn't have to wonder about its ability to run PC applications.

PIECE OF MIND

CompuPro's System 816.

The fastest, most cooperative computer you can buy.

OEMs and systems integrators are busy people. Too busy to waste time with an uncooperative computer system. That's why every System 816 from CompuPro is built to work long and hard without a whine or a whimper.

More Dependable.

With ten years of pioneering successes built into it, the System 816 is backed by the industry's longest warranty coverage. Depending on your needs, our warranties range from 12 to 36 months. Most other computer manufacturers expect you to be satisfied with 90 days, which typically covers parts only.

You can also depend on complete hardware and software support, flexible configurations and upgrades, and system training.

More Powerful.

The System 816 squeezes more performance out of the IEEE-696/S-100 bus than any other system you can buy. A choice of CPUs—and up to 4 Mbytes of our exclusive M-Drive/H™ RAM disk—give multiple workstations all the speed and power they can ask for. Standard RAM memory is expandable to one megabyte or more.

Disk storage capacity ranges up to 4.8 Mbytes on floppy drives and as much as 320 Mbytes per controller on hard disk.

CompuPro®

A GODBOUT COMPANY

3506 Breakwater Court, Hayward, CA 94545

CP/M and CP/M-86 are registered trademarks and CP/M-68K, MP/M-86, Concurrent CP/M-86 and FORTRAN 77 are trademarks of Digital Research Inc. CP/M 8-16 and MP/M 8-16 are compound trademarks of Digital Research Inc. and CompuPro.

For dealer locations, see page 389

More Versatile.

All family members share a common modular architecture. So it's a simple matter to upgrade or reconfigure any of them to keep up with your needs. All the while maintaining complete software compatibility up and down the line.

And the S-100 bus allows you the flexibility to plug in any compatible board to add graphics capabilities or boards for your own unique applications.

You also get your choice of operating environments, including CP/M®, CP/M-86®, Concurrent CP/M-86™, MP/M-86™ and CP/M-68K™, and our own CP/M®8-16™ and MP/M™8-16™.

At the programming level, the

System 816 family supports Pascal, C, FORTH, BASIC, COBOL, PL/1, FORTRAN 77™ and more.

More Information.

Your customer's satisfaction is important to both of us, so don't get stuck with a system that's more of a hindrance than a help. Send in the coupon and find out what peace of mind is all about.

For business, scientific and industrial computing solutions, call (415) 786-0909 ext. 506 for the location of our dealers worldwide, or the Full Service CompuPro System Center nearest you.

- Send me your free System 816 brochure.
 Send me the name of my nearest Full Service CompuPro System Center or dealer.

NAME _____
TITLE _____
ADDRESS _____
CITY _____ STATE _____ ZIP _____

Mail to: CompuPro, Attn: Sales Dept.
3506 Breakwater Court, Hayward, CA 94545

Prices and specifications subject to change without notice.
System 816 front panel design shown is available from Full Service CompuPro System Centers only.

©1983 COMPUPRO

Circle 83 on inquiry card.

BYTE January 1984 27

IT'S SIMPLE.
CALL & SAVE MONEY!

* 1-800-841-0860 *

TELEMARKETING COMPUTERS AND
EQUIPMENT TO SAVE YOU MONEY

SINCE 1978

**TRS-80
COMPUTERS**

• PURE RADIO SHACK EQUIPMENT •

UP
TO **20** %
AND
MORE
DISCOUNT

*** CALL FOR PRICES ***
ON COMPLETE LINE

PRINTERS AND EQUIPMENT

EPSON
OKIDATA

SICM SMITH
CORONA

RB ROBOT

C
A
L
L

Star
MICROBICS-INC

C. Itoh

Hayes

Novation

CALL

Commodore

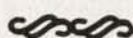

WE SELL IBM P.C. COMPATIBLES

Since 1978

- PIONEER IN DIRECT TO CONSUMER SALES OF MICRO COMPUTERS AND ELECTRONICS
- NAME BRAND PRODUCTS
- LARGE INVENTORIES
- NEXT DAY SHIPMENT ON MOST PRODUCTS

FREE UPON REQUEST

- DISCOUNT PRICE LIST AND INFORMATION KIT
- COPY OF MFR'S WARRANTY
- PRICES AND PRODUCTS ARE SUBJECT TO CHANGE WITHOUT NOTICE



Micro Management
Systems, Inc.

2803 Thomasville Road East
Cairo, Georgia 31728
(912) 377-7120 #1

Documentation

The documentation provided with the Z-100 is complete and easy to use. It is also voluminous. Printed on 8½- by 11-inch card stock and bound in a vinyl-clad 3-ring binder, each manual outweighs a typical lap computer—and a complete system may well include 10 manuals. (The Z-100 itself comes with a 278-page *User's Manual*, and each software product comes with one or two volumes of ring-bound documentation.) If you get a Z-100 with two operating systems, two versions of BASIC, and Multiplan (a standard software bundle), you'll need a bookshelf just for your system's manuals. And a strong bookshelf, at that.

The *User's Manual* includes many pictures identifying the parts of the system and step-by-step instructions showing the novice how to get the system up and running. The CP/M guide is the best-organized book I have come across on how to use CP/M. Every manual features a table of contents and an index: both are complete and detailed.

Technical Support

When I needed information that I couldn't find in the manuals, I called Zenith's Software Consultation Group. Their performance was excellent. Even when my questions were extremely technical, they managed to give me prompt and accurate answers. Their phone number is printed on the inside of each manual. (No, it's not an 800 number—but the quality of support available at that number is worth far more than the price of the call. Without it, some of my most important applications would never have run on the Z-100.)

Conclusions

The Z-100 is a powerful and reliable system that runs both CP/M and MS-DOS. In many ways it is IBM PC-compatible, but it is not a PC clone and cannot run all PC software. On the other hand, its keyboard and graphics are clearly superior to the PC's.

The Z-100 features sufficient I/O for most applications, and further I/O can be provided via its S-100 bus. Its documentation is excellent and backed up by professional technical support. Quality control in the hardware, software, and documentation is superb. The system delivers exactly what you expect and offers no unpleasant surprises.

How could it be improved? A diamond-shaped cursor pad would help. So would the ability for CP/M-85 to read and write a variety of 5¼-inch disk formats. And although Z-DOS has a utility that can read CP/M files, it can't write them. So I'd like to see a Z-DOS utility that can copy Z-DOS data and text files to CP/M disks.

The bottom line? If you want a well-designed, well-built, well-documented system that runs the best of 8-bit and 16-bit worlds, consider the Zenith Z-100. ■

Ken Skier (28 Fairlawn Lane, Lexington, MA 02173) is an author and software developer whose credits include the *Skiwriter* word processor, now distributed with the Epson Notebook computer.

THE MOST OUTSTANDING MULTIPROCESSOR, MULTIUSER ORCHESTRA.

PERFORMING ARTS of COMPUTER SCIENCE



We are the Performance Leader.

Our Duet Product (MCM*80 and DCM*80), installed in thousands of multi-processor multi-user systems as well as in single user systems worldwide, certifies our field-proven performance. Our state-of-the-art products, first and best, have been soundly accepted by the various institutes, from the government to the universities, and utilized by the various applications, from office automation to control automation. Our product superiority is recognized for the following reasons.

Identical Master/Slave SBC (Single Board Computer) architecture results in a prime advantage, never letting the entire system down. Not only that, the master/slave status is programmable, so it is truly possible to build redundancy in a multiprocessor system.

Unlimited Expandability differentiates our products from other multiprocessor based systems which are bound to the networking limitation. Our TURBODOS implementation on multiple networks, which connect multiple multiprocessor systems, matches the capacity of a mainframe, thus surpassing the mini computers.

Low Cost Local Area Networking has always been a subject but never a solution. Our approach to the LAN of SBCs, with integrated LAN con-

CP/M is a trademark of Digital Research, Inc.
TURBODOS is a trademark of Software 2000, Inc.

trol thru the high speed and reliable IPC (Inter-Processor Channel), provides an ultimate low cost solution for each computing station in a network.

Superior S-100 board Products are the key to superior system products. We now provide two prominent single board computers: MCM*80, based on Z80 (4 MHz, 6 MHz, or 8 MHz) processor family, and MCM*186 based on 80186 (8 MHz) processor. There are two disk controller products, DCM*80 and DCM*80 II. DCM*80 is the first disk controller to integrate the floppy disk controller and the SASI (ANSI SCSI) hard disk host adapter in one board. DCM*80 II is DCM*80 plus 8K Track Buffer with on-board DMA for high performance.



Our RAM*80 is the first memory board which has quad-mode capability. It works not only as an 8-bit and 16-bit memory board, but also as a memory disk board.

LINK*80 is an intelligent I/O board designed for high performance foreground processing capability with on board processor (Z80 A) and memory buffer.



JC SYSTEM

469 Valley Way
Milpitas, CA 95035
408/945-0318 TWX 910-381-7041

JC Systems products are available worldwide thru 60 dealer bases which are growing continually. All of our products are serviced factory-direct or by our dealers. We maintain highly confidential technical support, both in the hardware and software products, CP/M and TURBODOS.

Circle 197 on inquiry card.

INTRODUCING A SPINWRITER FOR EVERYONE WHO THOUGHT THEY COULDN'T AFFORD A SPINWRITER.



The newest
Spinwriter prints at
200 words per minute.

Spinwriter 2000 gives you famous Spinwriter features, quality and reliability for a new low price.

\$1,095

Our new
Spinwriter® 2000
retails for only \$1095.

And prints at 200 words per minute.

Even though the Spinwriter 2000 Series costs less, they are nothing less than true Spinwriters. The 2000 offers the same superior quality and reliability as the rest of the family.

So if low-volume, letter-quality printing is what you need, the Spinwriter 2000 is letter-perfect for you. And your budget.

Now, for about the same price as an ordinary printer, you can have a letter-quality Spinwriter.

Spinwriter is the letter-quality printer preferred by more PC owners.

The Spinwriter name is one of the legends of the computer industry. That's why NEC Information Systems is the number one supplier of letter-quality printers to PC users.

In fact many famous personal computer makers recommend the Spinwriter, not only for letter-quality printing, but because it can bring out the full capabilities of their system.

SPINWRITER IS A REGISTERED TRADEMARK OF NEC CORPORATION.

Spinwriter has capabilities you can't get on other printers.

Spinwriter's unique "thimble" print head gives you impeccable printing.

You can choose from over 60 different

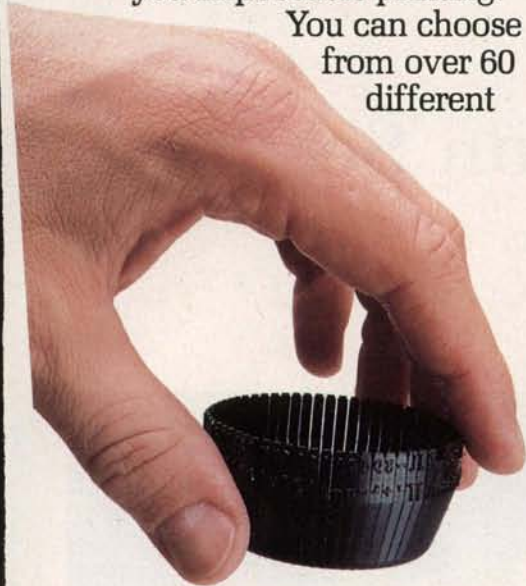

Our unique "thimble" print head holds up to 128 characters, enough for any special need.

type faces with up to 128 characters. And even have two type faces, or scientific and arithmetic symbols on the same thimble.

The 2000 also lets you change forms handlers quickly and easily. Seven NEC-built forms handlers give a

custom look to all of your forms-oriented applications. Which means you can shift from word processing to billing, shipping or inventory control in moments.

Want to send an original letter to a few hundred customers? Our sheetfeeder mechanism handles printing on your letterhead and second page or envelope.

Other Spinwriter advantages include continuous forms handlers that take paper up to 16 inches wide, variable size forms and multi-part forms.

Every Spinwriter is built to work as hard as you do.

Spinwriters have long been known for their reliability. Five years without a failure is not unusual. Which is twice as good as any other printer.

That's not to say that someday you won't need a little service. Not only will you find it nearby, you'll find it fast. NEC-trained experts can repair

Now offices with limited budgets don't have to settle for less of a printer.

The 2000 plugs directly into your PC's printer port.



a Spinwriter in less than 20 minutes.

For the Spinwriter distributor nearest you, call 1-800-343-4418 (in Massachusetts call 617-264-8635). And find out why more and more PC users are saying "NEC and me."

**NEC
AND
ME**

NEC Information Systems, Inc.

1414 Massachusetts Ave.
Boxborough, MA 01719

Circle 265 on inquiry card.

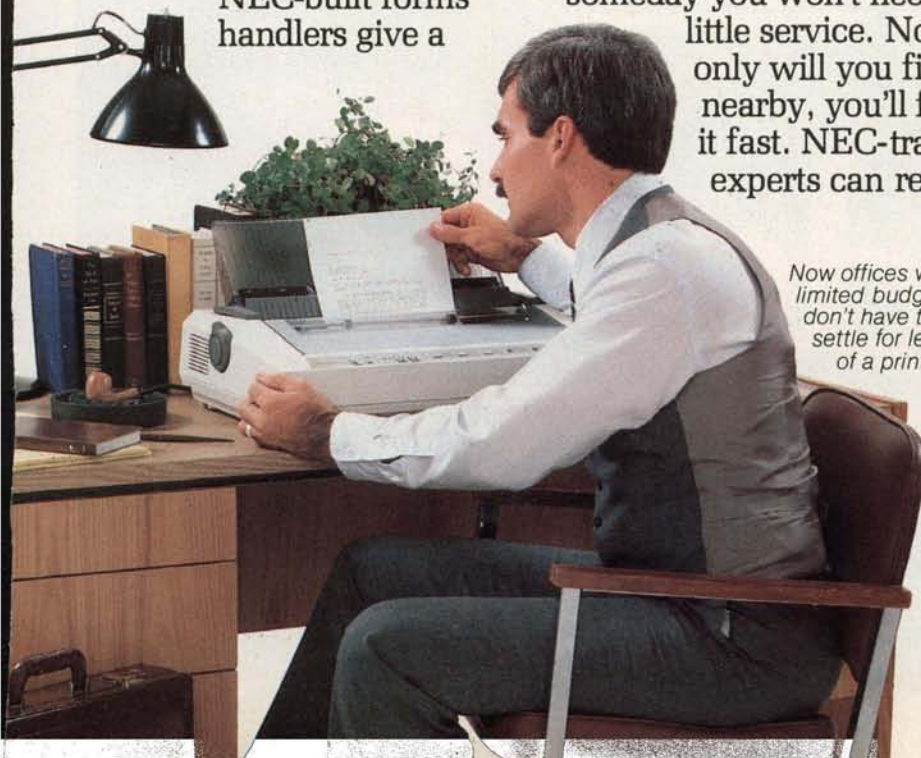

Pinball Construction Set

*Build your own pinball game on
an Apple II, Atari 400/800/1200, or Commodore 64*

by Elaine Holden

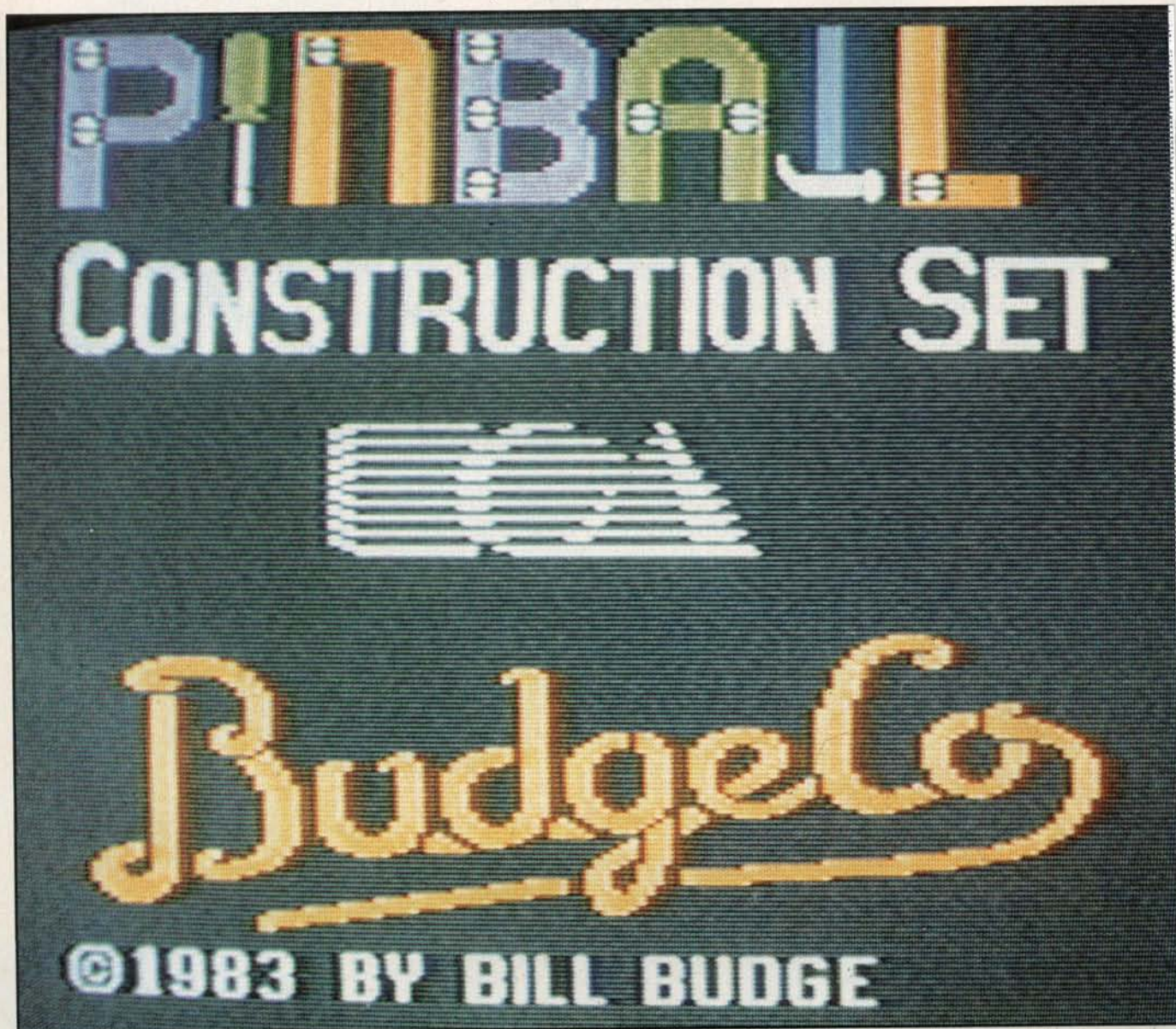

Photo 1: The title picture for the Pinball Construction Set. This is an example of the type of graphics a player can create. Note that this software was originally published by Budge Company but is now also available from Electronic Arts.



Photo 2: *Astro Blast*, one of the demo games that come with the system and are ready to play.

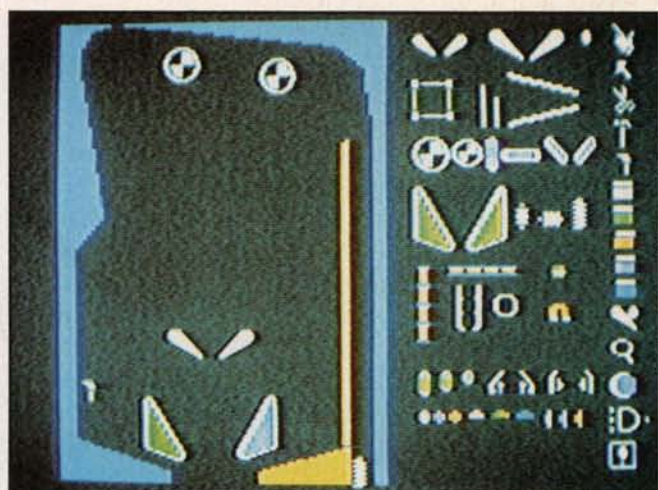

Photo 3: A pinball game being constructed. Note the menu of game parts on the right half of the screen and the column of icons along the right edge of the screen.

Attention, pinball wizards! As you well know, those big arcade machines with flashing lights and ringing bells have long been a fascination to those of us wishing to exhibit skill, dexterity, and some evidence of a mis-spent childhood. Now, thanks to the Pinball Construction Set from Electronic Arts (photo 1), not only can you play pinball in the comfort of your own home, you can also design your own pinball game. Other pinball-simulation games have been available for some time now, but this is one of the first games that lets you build other games.

If you need a game fix immediately after purchase, you can just boot the disk and play one of the five demonstration pinball games available (see photo 2). They are set up for as many as four players, so you can play alone or with friends. After this initial introduction, and once rational thinking has returned, you can reach for the user's guide and discover how much more exciting this construction set can be.

Building a Dream Game

One of my fantasies as a pinball player has always been to build my own game—one to suit my mood. At times I want the toughest challenge going, but once in a while I like a real pushover, and sometimes I even like an honest game. The variety of my requirements is endless, but, until now, the variety of available pinball games was not.

With the Pinball Construction Set, I can make any game I want, save all my quarters, and exercise my creativity at the same time. This game enables a complete novice to put together a worthwhile beginning game, gain experience, and later devise a devilishly tough, highly competitive game.

Just as in any construction kit, all parts are provided. Each piece of the pinball game is represented by a picture. These pieces can be placed anywhere on the empty pinball board (photo 3). All parts are activated and dragged onto the board by a movable hand symbol. This

symbol, as well as everything else in the game, is controlled by the joystick.

The Hand is one of a number of icons (pictures) that represent the various functions the program can perform. For example, you work with an icon that looks like a disk to save or load a game. These icons make it easy for a beginner to use the program.

If you want a different shape for a game board, the Arrow, Scissors, and Hammer icons can create and change solid shapes. These are very powerful commands because you can change not only basic shapes within the game's parameters but also the actual shape of the board. (Traditional arcade pinball games, of course, do not offer this option, and I've become bored with the same rectangular shape.) My favorite game creation so far has a pentagonal shape with lots of bumpers and few flippers.

Lest you imagine that the various shapes and games must remain the same color, take heart. A Paintbrush icon instantly changes the color of the game border or the shapes within. (For small shapes there is even a Magnifier icon). If you have a particularly nasty streak, when constructing a game for friends, you can paint over a bumper or other pinball part. It will still be there, you understand, it just won't be visible. To carry this trick one step further, you can paint in what looks like a bumper or paddle, and when the ball falls through the fake part, watch your opponent's face drop.

I also enjoyed personalizing my game with fancy decorations and a nifty title. For this I used the Magnifier icon (photo 4). It takes a little time and patience to perfect this icon's uses. Seeing a part of the screen magnified seven times its usual size takes some getting used to. Persistence is rewarded, however, by some really fine designs and lettering.

I had everything I needed for the perfect pinball game at this point—or so I thought. Then I turned the page of my manual and found the World icon. This feature gives four scales which change the conditions of the ball.

Gravity determines the weight of the ball; Speed governs how fast the ball moves; Kick is the strength of the bumpers; and Elasticity reflects how much bounce is wanted in the game.

The last icon worthy of note is the And gate. An And gate in computer science is a switch arrangement that permits an electrical flow only if all switches in the gate are on. The And gate in the Pinball Construction Set, functioning along the same principle, lets you record a bonus only if all the targets you have hooked together have been hit and turned on. Pretty fancy stuff. This icon also lets you change score values and sound. You can even have the beloved sounds of bells and whistles right at home.

Something for Everyone

I found this to be an incredibly complete kit. Bill Budge, the creator of this package, has a marvelous sense of programming. From the standpoint of an instructor of computer programming, I can only say, "Wow! I wish I wrote that." From the basic concept to the refined details, this is indeed a classy game.

The crowning feature of the Pinball Construction Set is its simplicity. A novice or young child can play a demo game to learn pinball basics. Nevertheless, for adult or child, it needn't remain just a game. Players can exercise creativity with color, shape, sound, relativity of weight and speed, and detail, all with this one program. As expertise increases so does the quality of the games created. Moving at the individual's pace, this non-

At a Glance

Name

Pinball Construction Set

Type

Software to play and/or construct a variety of pinball simulation games

Publisher

Electronic Arts
2755 Campus Dr.
San Mateo, CA 94403
(415) 571-7171

Price

\$40

Format

5¼-inch floppy disk in Apple II, Atari 400/800/1200 or Commodore 64 formats

Documentation

13-page users guide

Computer Needed

Apple II, Atari 400/800/1200, or Commodore 64; joystick required

Audience

Ages 10 and up; pinball lovers, game players, creative people, and teachers of gifted and talented children



Photo 4: An example of how the Magnifier icon is used. The figure on the right is a seven-times magnification of the apple in the upper-right corner of the game board.

threatening program records work done and provides for easy correction and alteration.

Despite this simplicity, sophisticated adult players will also be impressed with the game. It can be difficult enough for even the most advanced player because of the challenge and endless variety of modifications, refinements, and degrees of difficulty available. I predict that this program will be a continuing favorite in many personal game libraries.

I should note that you can also use this program to make gifts for gaming friends. Pinball games of your own creation can be put on blank disks and given away. You can design each game with the recipient in mind, and since up to 128 parts can be on the board at once, hardcore pinball players should remain fascinated for a long time.

Conclusions

It's really hard to find anything wrong with this game. The concept is well designed and executed. The instructions needed to begin the game are minimal, and game playing is immediate and, in the case of novices, instructional. Experienced players can gain valuable tips from the more difficult samples such as DEMO4 and DEMO5 (which illustrate some common obstacles such as a corner of the game where a ball could get stuck).

Creativity is encouraged. At the same time, players are not threatened or intimidated by either the screen display or the user's guide. Rather, they are gently encouraged and aided. This is valuable for children and inexperienced players and computer users.

I certainly feel that the Pinball Construction Set is valuable both as a learning and creating tool and as a truly entertaining game. ■

Elaine Holden is the supervisor of reading and language arts for the Merrimack, New Hampshire, School District. She can be reached at 22 Elm Street, Peterborough, NH 03458.

SemiDisk™ and SemiSpool:™ SURE-FIRE WAIT-REDUCTION!

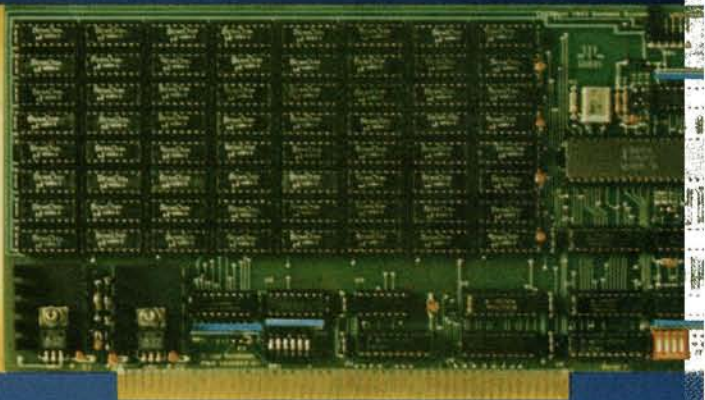

512Kbyte SemiDisk™ I \$1095

Time was, you thought you couldn't afford a SemiDisk. Now, you can't afford to be without one.

	<u>256K</u>	<u>512K</u>	<u>1Mbyte</u>
SemiDisk I, S-100	\$895	\$1095	\$1795
IBM PC		\$1095	\$1795
TRS-80 Model II		\$1095	\$1795
SemiDisk II, S-100		\$1395	\$2095
Battery Backup Unit	\$150		

Time was, you had to wait for your disk drives. The SemiDisk changed all that, giving you large, extremely fast disk emulators specifically designed for your computer. Much faster than floppies or hard disks, SemiDisk squeezes the last drop of performance out of your computer.

Time was, disk emulators were afraid of the dark. When your computer was turned off, or a power outage occurred, all your valuable data was lost. But the SemiDisk changed all that. Now, the optional Battery Backup Unit helps take the worry out of power interruptions. It keeps the SemiDisk powered for up to 5 hours during a power failure.

Time was, you had to wait until your printer finished printing to use your computer. That's changed, too. Now, the SemiSpool print buffer in our Version 5.0 software, running under CP/M 2.2, frees your computer for other tasks while your data is printing. With a capacity up to the size of the SemiDisk itself, you could implement an 8 Mbyte spooler!

But one thing hasn't changed. That's our continuing commitment to supply the fastest, highest density, easiest to use, most compatible, and most cost-effective disk emulators in the world.

SemiDisk.
It's the disk the others *still* are trying to copy.

SemiDisk Systems, Inc.

P.O. Box GG Beaverton, OR 97075 (503) 642-3100

Call 503-646-5510 for CBBS*/NW, a SemiDisk-equipped computer bulletin board. 300/1200 BAUD
SemiDisk trademark of SemiDisk Systems, Inc. Copyright © 1983 SemiDisk Systems, Inc. CP/M Trademark Digital Research.



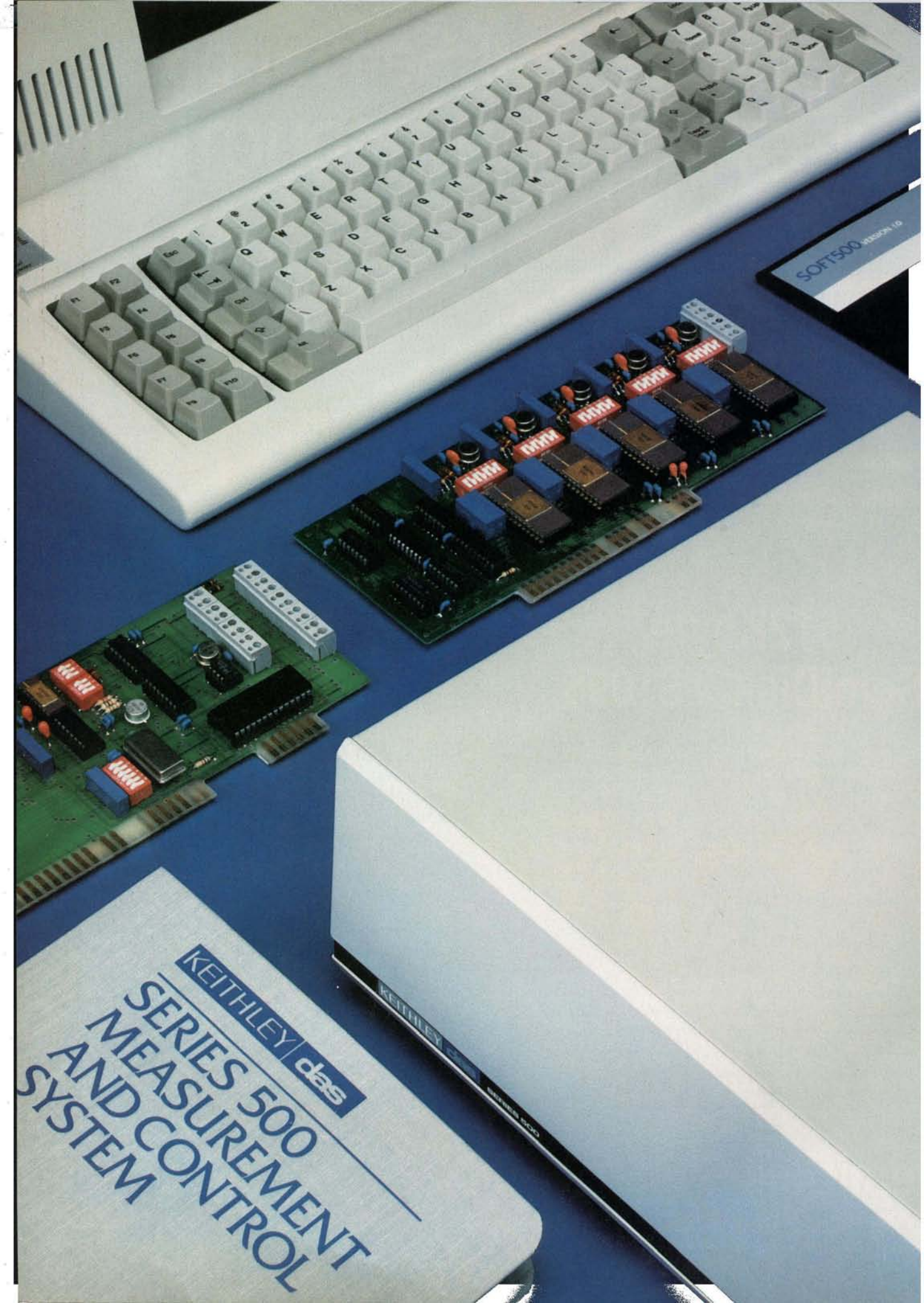

SOFT500 485001 10

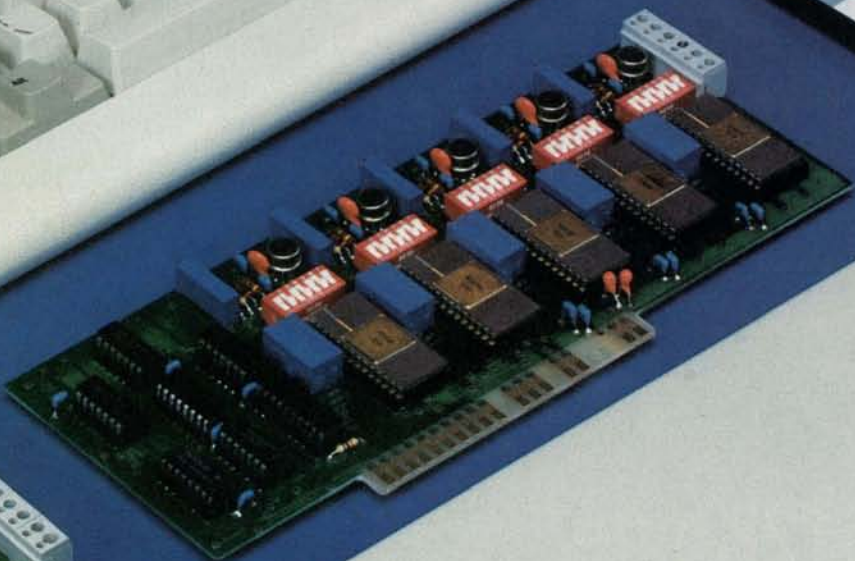
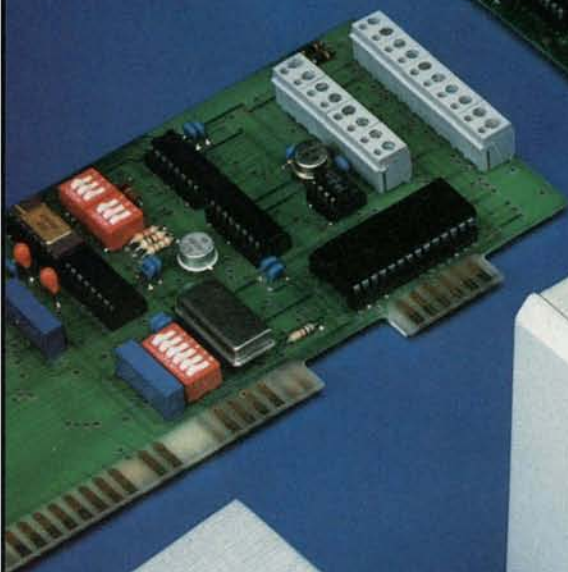

KEITHLEY | das
SERIES 500
MEASUREMENT
AND CONTROL
SYSTEM

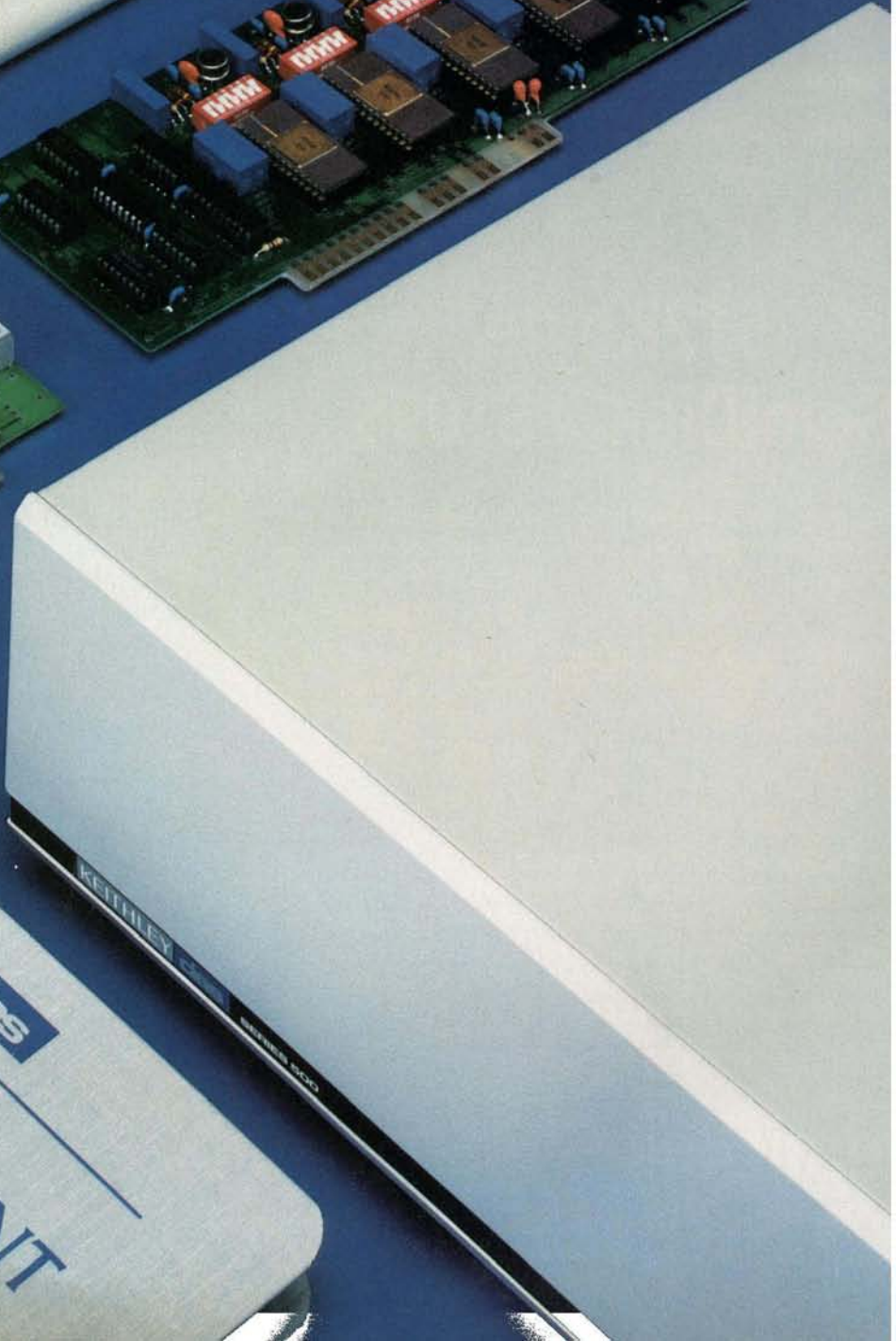

DON'T WASTE YOUR MONEY ON A WORKSTATION DATA ACQUISITION SYSTEM.

As you conduct your search for the ideal data acquisition system, we think you'll find a number of capable systems, all from fine makers.

But we also think you'll find this: there is really only one system likely to meet, and perhaps exceed, your own personal standards for accuracy, flexibility, performance and power. And do so for a bottom line investment that is truly easy to justify.

That system is the Keithley DAS Series 500 for the IBM PC and Apple II families of microcomputers.

To begin with, even a basic Series 500 configuration, like the one shown in the chart, comes out of its carton with enough power and capacity for most lab and test bench applications. So you needn't trade up to more expensive options to get basic capabilities.

And because the Series 500 is completely modular, you can start out with just the capacity you need. Then choose from our comprehensive library of plug-in function cards to instantly reconfigure your system for the most demanding applications—with up to 272 channels of discrete analog input, 50 channels of analog output, 160 channels of digital I/O, and AC/DC device control. With direct transducer connection and signal conditioning for each individual channel.

It's also the only system equipped with Soft500, the integrated measurement and control software that proves once and for all that easy doesn't have to mean simple.

Soft500 gives first time users the accessibility and friendliness they need to get excellent results the first time out. Yet it also provides experienced users with the depth and extended facilities needed for complex applications. Including unique features such as foreground/background architecture, powerful screen graphics and statistical analyses. Plus, automatic conversion of binary data to familiar engineering units.

In all, you'll find the features you need to make the Series 500 increasingly productive through years of new and more demanding applications.

	Keithley DAS Series 500	ISAAC 91A	ISAAC 2000	MACSYM 200	HP 3497A
System Base	\$4300 ⁽¹⁾	\$3950	\$4100	\$3660	\$2990
Analog Input					
16 Channels	Yes	Yes	+ \$850	+ \$362 ⁽²⁾	+ \$2104 ⁽³⁾
Instrumentation Amplifier	Yes	+ \$700	+ \$700	Yes	Yes
± 0.035% Absolute System Accuracy	Yes	+ \$1100 ⁽⁴⁾	+ \$1100 ⁽⁴⁾	No	Yes ⁽⁵⁾
30 kHz Sampling	Yes ⁽⁶⁾	No	Yes ⁽⁷⁾	Yes	No
High Speed Programmable Ranges	Yes	No	No	Yes	No
Other I/O					
5 12-Bit Voltage Outputs	Yes	+ \$187 ⁽⁸⁾	+ \$937 ⁽⁹⁾	+ \$937 ⁽⁹⁾	+ \$2500 ⁽¹⁰⁾
16 Digital Inputs	Yes	Yes	+ \$175 ⁽¹¹⁾	+ \$330	+ \$530
16 Digital Outputs	Yes	Yes	+ \$175 ⁽¹¹⁾	+ \$350	+ \$710
4 120VAC Outputs	Yes	No	No	+ \$638 ⁽¹²⁾	+ \$265 ⁽¹³⁾
System Features					
Programmable Timers	Yes	Yes	Yes	Yes	+ \$555
Realtime Clock	Yes	Yes	No	Yes	Yes
Power Supply	Yes	+ \$350	Yes	Yes	Yes
Software System					
Data Acquisition BASIC	Yes	Yes	Yes	Yes	No
Foreground/Background	Yes	No	Yes ⁽¹⁴⁾	Yes ⁽¹⁴⁾	No
Data Analysis	Yes	No	No	No	No
Realtime Graphing	Yes	Yes	Yes	Yes	No
Engineering Units	Yes	No	No	No	No
Package Price	\$4300	\$6287	\$8037	\$6277	\$9654

1. System 520. 2. 16 channels of \$725 32 channel card. 3. \$1640 A/D card plus 16 channels of \$580 20 channel card. 4. ± 0.003% accuracy @ 200 Hz. 5. ± 0.006% accuracy @ 40 Hz. 6. Apple system 27 kHz, IBM system 31.4 kHz. 7. 200 kHz option available + \$3825. 8. 1 channel from \$750 4 channel card. 9. 5 channels from \$750 4 channel card. 10. 5 channels from \$1000 2 channel card. 11. 16 channels of \$350 32 channel card. 12. Price based on 16 channel rack @ \$550 plus 4 AC output relays @ \$22. 13. Four channels of \$525 8 channel card. 14. Or other multi-tasking structure.

Naturally, we'd like to suggest the Series 500 as the wisest choice in workstation data acquisition. But we also believe that as you compare and examine the facts, the Series 500 will eventually suggest itself.

For complete information on the Keithley DAS Series 500 workstation data acquisition system, call us toll-free at 1-800-552-1115. In Massachusetts call (617) 423-7691. Or write to us at Keithley DAS, 349 Congress Street, Boston, Massachusetts 02210.

SERIES 500

KEITHLEY *das*

A JOINT VENTURE IN WORKSTATION DATA ACQUISITION

Information contained in the comparison chart is correct to the best of our knowledge as of October 1, 1983; however, Keithley DAS assumes no liability for its accuracy. IBM PC is a registered trademark of International Business Machines Corporation. Apple II is a registered trademark of Apple Computer, Inc. ISAAC is a registered trademark of Cyborg Corporation. MACSYM is a registered trademark of Analog Devices, Inc. HP is a registered trademark of Hewlett-Packard, Inc. © 1983 by Keithley DAS, Boston, Massachusetts

The TRS-80 Model 16B with Xenix

by Steve Barry and Randy Jacobson

The Radio Shack TRS-80 Model 16B is surprising in at least two ways: first, it appeared later than the company's announcements would have indicated, and second, it has an industry-standard multiuser operating system—Microsoft's Xenix, a derivative of Bell Laboratories' Unix version 7. The Model 16B's Xenix capability is remarkable in that it represents the first use of an outside supplier's operating system in Radio Shack's history. This event is of even more interest because Xenix is to be supplied for several other popular microcomputers.

In this review we'll first present an overview of the 16B's hardware and capabilities, and, because the hardware's effectiveness depends on its ability to run Xenix, we'll also cover that operating system's major features.

The TRS-80 Model 16B is a blend of the old and the new. It is based on a dual-processor architecture (Motorola 68000 and Zilog Z80), and it runs as either a single-user or a multiuser computer. The machine is particularly significant because it has most of the hardware features available on other machines in the \$5000 to \$16,000 price bracket, and it has the support of an industry powerhouse behind it. Although not innovative in concept, the 16B is more than just a solid high-end engine for Radio Shack's software. The computer performs well for its class of machine and is likely to be a major focus of software houses trying to take advantage of Radio Shack's marketing clout and Xenix program portability. The 16B is compatible with an extensive line of Radio Shack peripheral hardware, and there is also

a strong indication that the Model 16B will be a central element in Radio Shack's announced but unmarketed local-area-network (LAN) strategy. Indeed, with its LAN-capability option, the system could become the backbone of an expandable, low-cost, office-wide, multimodel, shared-computer resource.

Background

Starting about a year ago, rumors of Radio Shack's new high-end machine piqued the curiosity of many enthusiasts. The computer was supposed to be a powerful yet inexpensive multiuser machine that employed a proprietary operating system said to be incompatible with the software available on widely distributed multiuser operating systems such as MP/M. When the machine failed to materialize, rumors said its delay was due to myriad hardware and software problems.

In spite of its uncertain beginnings, the Radio Shack TRS-80 Model 16B has hit that all important and all too narrow marketing "window," defined by public acceptance of a combination of price, performance, and features. Once such a window is filled by a few machines, other manufacturers find it difficult to penetrate the market. The target market for this machine is the small business that requires a one-source supplier of multiuser turnkey hardware, software, and service for core business applications. However, the 16B can also serve as a small Unix and Xenix development environment.



Photo 1: The TRS-80 Model 16B standard system.



Photo 2: The 86-key detachable keyboard of the 16B.

System Summary

The Model 16B (photo 1) runs a large library of single-user software. Moreover, it has multiuser capabilities, and significant multiuser software has become available early in the machine's life (see the At a Glance box).

A minimum three-user system consists of the console with 384K bytes of memory, one 1.25-megabyte 8-inch floppy-disk drive, an 11.6-megabyte hard-disk drive, two user terminals, a printer, and software. The system console has a detached 86-key keyboard (photo 2). The keytops are textured to avoid glare. The standard alphabet, number, and symbol keys and the numeric keypad keys are black with white legends. Other keys—including Shift, Tab, Break, Backspace, eight function keys, and the cursor keys—are white with black legends. A bump is placed on the numeric pad's 5 key to aid manual orientation for touch-typing. Cursor keys are arranged (awkwardly, in our opinion) in a vertical column on the left border of the numeric pad. Keytops are slightly longer vertically than horizontally and have dual-spring action so that the touch is heavier at the bottom of the key travel, but there is no other auditory or tactile feedback for key-switch closure. We felt that the keyboard touch was vague, and this prevented rapid typing during our limited use of the machine. Function keys surround the upper and right side of the numeric keypad. Control keys (such as Return, Tab, Enter, and Shift) that are either the same size or even larger at the base than the character keys have the same raised striking area as an alphanumeric key. Two important symbols for Unix users and programmers can be produced only by pressing Control and another key simultaneously. These symbols are | (for the pipe feature) and \, used primarily in C-language programming.

The system is housed in a large but attractive integrated enclosure containing a seven-slot system card cage, the floppy-disk drive, the console video display (a 12-inch-

Editor's Note: Since this article was written, Radio Shack has announced a new standard configuration for the Model 16B: a 256K-byte system with one 8-inch floppy-disk drive and a built-in 15-megabyte hard-disk drive for \$6999.

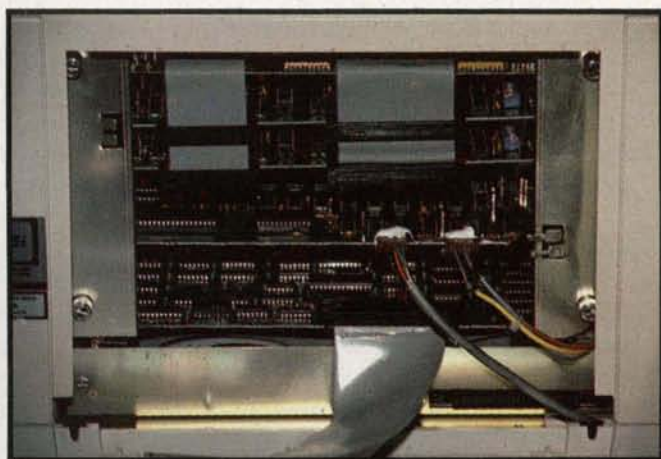

Photo 3: The Model 16B's card cage.

At a Glance

Name

TRS-80 Model 16B Computer

Manufacturer

Radio Shack Division
Tandy Corporation
1300 One Tandy Center
Fort. Worth, TX 76102

Size

14 by 21¼ by 23½ inches

Weight

Approximately 50 pounds

Components

Processors: Motorola 68000 running at 6 MHz, Z80A running at 4 MHz
Memory: Z80A with 64K bytes; M68000 with 256K bytes minimum, 768K bytes maximum (128K-byte memory-expansion board is \$699, 128K-byte add-on-chip kit is \$299)
Display: 24 lines by 80 columns, green phosphor, brightness and contrast controls, upper- and lowercase characters, 32 symbol graphics characters
Keyboard: Detached 86-key stepped keyboard with 6-foot coiled cord; keytops are textured to avoid glare
Data Storage: One 8-inch double-sided double-density 1¼-megabyte floppy-disk drive installed in the console
Expansion: Seven-slot card cage; three slots are free in a 512K-byte system with a 12-megabyte hard-disk drive

Operating Systems

TRSDOS-11/16 (single user), TRSDOS-12 (single user), TRS-Xenix (multiuser)

Documentation

TRS-80 Model 16B Operator's Manual, 100 pages; TRSDOS-11 Reference Manual, 326 pages; TRS-Xenix Operations Guide, 161 pages; TRS-80 Model 16B Owner's Manual (actually the TRSDOS-16 Operating System Manual), 256 pages; Twelve-megabyte Hard Disk Owner's Manual, 50 pages; BASIC Reference Manual (TRSDOS with BASIC interpreter), 235 pages; Assembler-16 Manual, 353 pages

Software Available

TRS-Xenix multiuser software: General Ledger (\$599); Payroll (\$699); Accounts Receivable (\$599); Accounts Payable (\$599); Order Entry/Inventory Control System (\$599); Sales Analysis (\$399); Job Costing (\$199); Multiplan spreadsheet (\$349); COBOL Development System (\$699); BASIC interpreter (\$299); and TRS-Xenix Development System with C language, electronic mail, text processing, and Xenix utilities and Assembler-16 (\$750). The Model 16B also uses Model 11 and Model 12 software in the Model 11 compatibility mode (single user)

Optional Features

Second internal 8-inch floppy-disk drive (\$799); one (\$1299) or two (\$2098) external floppy-disk drives; 11.6-megabyte primary hard-disk drive (\$3495); 12-megabyte secondary hard-disk drives (three maximum, \$2495 each); graphics video adapter board (monochrome 640- by 240-pixel resolution, \$499); DT-1 data terminals (two maximum, \$699 each)

Prices

256K bytes, one floppy-disk drive: \$4999
256K bytes, two floppy-disk drives: \$5798
384K bytes, one floppy-disk drive, one 11.6-megabyte hard-disk drive: \$9995
512K bytes, one floppy-disk drive, one 11.6-megabyte hard-disk drive (minimum recommended Xenix configuration): \$10,294

diagonal green-phosphor tube without antireflection treatment), the Motorola 68000 processor board, a memory board, and the hard-disk interface. This configuration costs in the neighborhood of \$16,000, complete with a top-of-the-line Radio Shack letter-quality printer and a complement of multiuser accounting and core business-applications programs. Moderate-resolution (640-by 240-pixel) monochrome-video-graphics hardware is an option for the console terminal but is not yet supported by Xenix software.

Software

The optional single-user software library includes all TRS-80 Model II and 12 programs (nearly 50 from Radio Shack), each targeted at a broad base of business and professional users. The optional multiuser software library is, at this writing, confined to program-development software (available at additional cost; see *At a Glance*), "big four" accounting packages (General Ledger, Accounts Payable, Accounts Receivable, Payroll), and Microsoft's Multiplan advanced spreadsheet. Other software includes an order-entry/inventory-control system, sales analysis, and small-contractor job-costing programs. COBOL and BASIC languages are sold separately, as is the TRS-Xenix development system, which includes many utilities, the C language, Unix-style communications, Unix-style text processing (*not* word processing in the usual sense), and Unix's basic electronic-mail facilities.

Hardware

The TRS-80 Model 16B has two serial RS-232C ports, a parallel printer port, and a space on the connector panel reserved for the Datapoint/Radio Shack Arcnet LAN interface. In its current configuration, then, the system can handle only three users: two working on dumb terminals, such as Radio Shack's model DT-1, and a third working on the system console. The system card cage has space for seven cards. The maximum RAM (random-access read/write memory) allowable currently is 768K bytes, which is obtained using the M68000 microprocessor's on-board memory and two 256K-byte cards. The 64K bytes of Z80 memory are on a separate card below the card cage (photo 3) in the base of the system unit. The M68000 memory cards are connected to the processor board by two card-edge ribbon cables in a bus configuration, in addition to their interface to the motherboard. One card slot is used for the hard-disk interface, and another is used for the console terminal electronics. Two slots are unused in the configuration we tested. Recent rumors suggest that Radio Shack is planning to announce a six-port terminal multiplexer board, along with a 15-megabyte hard-disk drive. The multiplexer and an Arcnet board would fill the card cage and, according to our system-performance evaluations, provide enough interfaces to cause severe response delays for a full load of users. It is possible that this machine could support only two to four users in a program-development environment, if our previous experience with similar hard-

ware applies to this machine. In fact, with only 384 bytes of memory (one advertised "complete" configuration), Xenix may even be noticeably slow with three users. However, the three-user configuration with 512 or 784K bytes of memory is clearly supported and seems to make the most sense in terms of the speed of the operating system and the memory-segmentation scheme that is implemented.

Local-Area Networking

For larger groups of users, the Arcnet board might be used to interconnect clusters of three users per Model 16B (i.e., a distributed-star network). As a user, you would have access to the 16B to which your terminal is connected and would also have read and/or write access to programs and data for which you have authorization on other 16Bs connected to the network. Typically, in other Unix systems (although there is no official indication that Radio Shack will go this way), networking means you run a program at your terminal that lets you log onto the desired remote system via the physical network facilities. You may then do work on the remote system or transport programs and data back to the system to which your terminal is directly connected. You must have a user account on each networked Unix system that you want to use. Thus, you may have several accounts on several different machines in the office, and it is possible that none of the accounts would have all of the up-to-date information you desire to use in a particular work session. This network architecture itself promotes redundant storage of data on several systems. The software for this type of network access is standard Unix fare: `uucp` is the Unix-to-Unix copy program (used for file transport and intersystem mail), and `cu` is the call-Unix program (used to establish a logical user connection over a preexisting physical connection between systems). The `cu` program lets you log onto the desired system as though your terminal were directly connected to that system. The `cu` program also allows file transport back to your actual host system. Xenix appears to have the standard Unix networking described above. This is good, but things can get much better.

In contrast, consider two alternative network architectures. The first (and by far the nicest to work on) is the virtual system. In this system, you would typically have your own powerful personal computer (e.g., a 16B) interconnected with other users' 16Bs by a local-area network (e.g., Arcnet). A program called the Network Manager would run on each active system as an invisible background task. All requests for files (i.e., programs, data, or directories) that cannot be satisfied on your system are referred to the Network Manager. The Network Manager then queries all other active systems on the network for the desired item and transports the item to your computer for execution, if that item is a program. If the item is not a program, an access link is created via the network, if you have the correct authorization. You never see all of this activity: you either get access to the file or receive an error message describing why access was

denied (file not found, file found on another file system to which access was not granted, etc.). This type of network reduces data redundancy and, more important, provides you with a transparent network-wide access interface. The Model 16B could be hooked up to this type of network if Radio Shack, Datapoint, or Microsoft creates the right network software.

In the second alternative, the 16B's Arcnet hardware could be used in a simple star network where a central network "server" consists (usually) of a central processor and disk system. Each user workstation would be a Model 16B computer having either no mass-storage system or only a floppy-disk drive. The central server is used for all fast bulk storage and may also be used to route data from one user's workstation or file system to that of another user. It is easy to make this sort of network operate like a virtual system, but such a network is usually slower and is vulnerable to faults in the server. Program execution on each of the workstations might also be slower due to the need to retrieve program or data segments from the central server's disk. The advantages of this type of local-area network are that it is low in cost, it can minimize data storage redundancy, it provides a single integrated and coordinated file system, and, finally, it has relatively good compute performance for processes that are entirely memory resident. Whatever Radio Shack decides to do with the LAN facilities it has in store for us, you can bet that it will be proprietary and will promote the sale of other Radio Shack computer products.

Xenix on the Model 16B

The Xenix implementation on the 16B is an enhancement of Unix version 7 with the addition of several extensions from the University of California, Berkeley, and from Unix System III. (For more information on the Unix operating system, see David Fiedler's three-part article, "The Unix Tutorial," appearing in the August, September, and October 1983 BYTES. See also the several theme articles in the October 1983 issue on Unix.) The system comes in two pieces. The basic multiuser Xenix operating system and a pretty good collection of utilities comes with the purchase of a Model 16B. The Xenix Development System adds numerous utilities and C, the language in which Unix is written. C is being touted in the industry as the only way to write truly portable fast-executing code. Let it be known, however, that not all versions of C are created equal. Unfortunately, despite a clear definition of what C is and what it's supposed to do by Kernighan and Ritchie in *The C Programming Language* (reference 1), several nonstandard C compilers are available on the market today. Worse, some compilers have subtle differences in their implementations that hinder true portability—code that runs well in some environments gets sick in others. The TRS-Microsoft implementation appears to be reliable and standard. The Xenix Development System adds many useful utilities and commands including the Unix electronic-mail facilities and Unix communications. Xenix is, in comparison

EXPOTEK

24 Hour Xmas Hot Line

1-800-528-8960

Guaranteed Low Prices

PRICES ARE CONTINUALLY CHANGING IN THIS FAST GROWING MARKET. WE PURCHASE IN HIGH VOLUME TO INSURE YOU OF THE LOWEST POSSIBLE PRICE. OUR ADVERTISING IS PREPARED AT LEAST ONE MONTH IN ADVANCE, SO CHECK FOR OUR CURRENT LOW PRICE.

- HIGH VOLUME SALES INSURE LOWEST POSSIBLE PRICE
- WE DO NOT "ADD ON" TO SHIPPING COSTS
- CODs ACCEPTED
- WE SHIP FROM STOCK
- WE GUARANTEE OUR PRODUCTS

PORTABLE COMPUTER CASE IBM, APPLE, FRANKLIN, TRS 80, ETC.

All metal construction designed for low RFI emissions replaces stock case. Unit folds to compact size enclosing keyboard and drives (up to three!). When set on desk and opened, keyboard folds to convenient typing height.

IBM CALL SAVES

AST, Hercules, Microsoft, Maynard, Persyst, Profitsystems, Quadram, STB, Talltree

for the IBM

TANDON 100-2DD	\$225
QUADRAMCARDS	CALL
16K RAM CHIPS SET OF 9	\$1490
64K MEM/UPGRADE	\$55
SOFTWARE	CALL

COMPUTERS

ALTOS

580-10	\$3500
586-10	\$5498
586-14	\$7680
8600-12	\$8399

ATARI SAVE \$ CALL NORTHSTAR

W/15MB	\$4310
--------	-------	--------

TELEVIDEO

802	\$2515
802H	\$4449
803	\$1769
1603	CALL

TERMINALS

ADDS

VIEWPOINT A1	\$485
VIEWPOINT A2	\$550

HAZELTINE

ESPRIT I	\$498
ESPRIT II	\$540

TELEVIDEO

910	\$555
925	\$699
950	\$865
970	\$975

DISKDRIVES

FOR APPLE		
MICOR SCI A2	\$235
RANA ELITE I	\$260
RANA ELITE III	\$249
FOR ATARI		
RANA 1000	\$375

PRINTERS

CITOH

F1040	\$1090
F1055	\$1499
1550P	\$599
8510P	\$345

SILVEREED SAVE \$ CALL DATASOUTH

DS120	\$595
DS180	\$1155

DIABLO

620	\$875
630RO	\$1699

NEC

3510	\$1365
3550	\$1705
7710	\$1900
8023	\$399

OKIDATA SAVE \$ CALL MONITORS

AMDEK

300 GREEN	\$129
300 AMBER	\$145
310 AMBER (IBM)	\$199
COLOR I	\$275

BMC

GREEN	\$88
COLOR	\$299

APPLECARDS

16K RAM	\$69
Z80	\$235
VIDEX 80 COLUMN	\$199
VIEWMAX 80	\$175
MICROSOFT PREM. PK	485

DISKETTES

ELEPHANT SS/SD	\$18.00 BX
SCOTCH SS/DD	\$22.00 BX
DYSAN SS/SD	\$33.00 BX

TWX 910-950-1194

CUSTOMER SERVICE (602) 863-0759

10439 N. CAVE CREEK RD., #111, PHOENIX, AZ 85020

How a fireman and a broken leg made software simple.



What does a fireman know about designing software? Nothing. Usually.

Meet Dennis Jarvis, a firefighter from Southern California. About five years ago he broke his leg in a fire-related accident and was confined to the house for about six months. To keep him occupied, Dennis' wife bought him a computer.

Dennis had never used a computer before. But he proved to be a natural.

Dennis was soon writing his own programs. And Basic Accounting from Firefighter was born.

It was brilliant.

And so simple, you don't have to know anything about accounting theory to use it.

But don't get the wrong idea. Just because it's simple, doesn't mean it's not smart, too.

Basic Accounting from Firefighter has so many more features and capabilities than the best selling accounting package, there's no room to list them in this ad. You'll just have to ask your dealer to show you.

Dennis? He returned to the Fire Department soon after his leg healed, but remains the spearhead of Firefighter Software.

In fact, in his never-ending efforts to make Firefighter the most personal, most supported software, Dennis has set up a telephone hotline to answer your questions and provide consultation. That's just Dennis' way of insuring Firefighter remains superior, always simpler yet smarter.

Hotline: 1-800-641-0814

California Hotline: (213) 991-8200

FIREFIGHTER.

SIMPLER, SMARTER SOFTWARE.



31245 La Baya Drive, Westlake Village, CA 91362

to other manufacturer's offerings, a fairly complete implementation of Unix (minus the languages that come standard with real Unix) at a moderate cost. However, it is possible that Unix System V will be released to end users at a low cost and so offer significant competition to Xenix.

Xenix and Unix System Calls

The most widely distributed and used version of Unix today is version 7. Microsoft Xenix is a derivative of this version with some enhancements and is available as a single or multiuser environment. Like Unix, Xenix requires a good deal of memory (at least 256K bytes for a one-user system) and a lot of hard-disk space (we think that a 10-megabyte disk with an average access time of 95 milliseconds is the minimum practical). Both systems work better with more memory and with faster, bigger disks. Xenix supports all of the version 7 standard system calls (what a program uses to talk with the operating system), plus some extensions that improve multiuser access to the system's resources. The standard system calls (similar to CP/M's BDOS, or basic disk operating system, calls) are shown with brief explanations in table 1. The most notable extensions to Unix are in the kernel; they affect file access and signaling between tasks (called processes in Unix). Unix and Xenix are structured much like an onion; at the center is the kernel, the basic code that makes it all go. Successive layers of code add utilities, features, languages, and the user interface—called the shell. The kernel has the task of making the link between the Unix standard environment and the nitty-gritty of the machine on which the operating system is running. Thus, standard system calls can be issued from programs, and their translation into action on a particular machine is handled by the kernel. This is the key to why Unix is a highly portable system. You only have to rewrite the kernel and a few device drivers to transport the whole system to another machine, using a standard C compiler and an assembler available on the target machine. One of the primary concerns in using Unix in a commercial multiuser environment is how to achieve orderly and centrally-controlled access to disk data at the individual record level. Standard Unix does not support the types of access-permission control and concurrency control (file and record locking) required by business programs. This is one of the first areas addressed by Xenix enhancements to standard Unix.

File Access Control

The Xenix extension routine `locking` locks or unlocks a specific number of bytes in a file. The process that issues the lock command has read/write access to these bytes and may allow read-only access to other processes. The parameters `mode` and `size` control these actions. If the region being locked is already locked by another process, the locking routine requesting access can wait for the entire region to be unlocked or can return with an error code. A Unix/Xenix standard specification for this routine is shown here:

Now your computer can say anything and say it well. Introducing the Votrax Personal Speech System.

Quite articulate.

The unlimited vocabulary Votrax Personal Speech System is the most sophisticated, low cost voice synthesizer available today. Its highly articulate text-to-speech translator lets your computer properly pronounce conversational words at least 95% of the time.

For all those unusual words and proper names, you can define an exception word table and store your own translations. And remember, the entirely self-contained Votrax PS System gets your computer talking without using any valuable computer memory.

Built-in versatility.

Much more than just a voice output device, the Votrax PS System lets you mix either speech and sound effects or speech and music. A programmable master clock and 255 programmable frequencies give you unmatched control of speech and sound effects.

The Votrax PS System offers user expandable ROM for custom applications, user downloadable software capability and sound effects subroutines for easy user programming. Its programmable speech rate provides more natural rhythm, while 16 programmable amplitude levels give you greater control of word emphasis.

Actual size: 12.2" x 4.5" x 2.6"

Friendly to humans.

Designed to look like a printer to your computer, the Votrax PS System is extremely easy to use. It can be used in tandem with your printer without an additional interface card. Both serial and parallel ports come standard, allowing you to connect the Votrax PS System to virtually any computer. Speech, music and sound effects are only a PRINT statement away.

“Listen here”

What to say after “Hello”.

Businesses will appreciate spoken data transmission, narration of graphic displays and unmanned, oral product demonstrations. Spoken verification of data input will make computers much easier for the blind to use. School children can receive comprehensive

Votrax®

The Votrax Personal Speech System is covered by a limited warranty.

Write Votrax for a free copy.

500 Stephenson Highway, Troy, MI 48084

computer instruction with voice textbooks as well as spoken drills and testing. And then, late at night, you can make those adventure games explode.

A quick list.

- Highly articulate Votrax text-to-speech translator.
- 255 programmable frequencies for speech/sound effects.
- 16 amplitude levels.
- Simultaneous speech and sound effects or speech and music.
- 8 octave, 3 note music synthesis.
- Serial and parallel interface standard
- User programmable master clock
 - User defined exception word table.
- User programmable speech rate, amplitude and inflection.
- User expandable ROM for custom applications.
 - User downloadable software capability.
- 3,500 character input buffer: subdivisible for a printer buffer.
- Internal speaker and external speaker jack.
- Real time clock and 8 user defined alarms.
- Oral power up and error prompting
- X-on/X-off and RTS-CTS handshaking
- Programmable Baud settings (75-9600)
- Interrupt driven Z-80 microprocessor.
- Parallel/Serial interconnect modes.
- Proper number string translation: the number “154” is pronounced “one hundred fifty four”.

To order, see your local computer retailer or call toll-free

1-800-521-1350

Michigan residents, please call (313) 588-0341. MasterCard, VISA or personal check accepted. The price is \$395 plus \$4 for delivery. Educational discount available. Add sales tax in Michigan and California.

© VOTRAX 1988

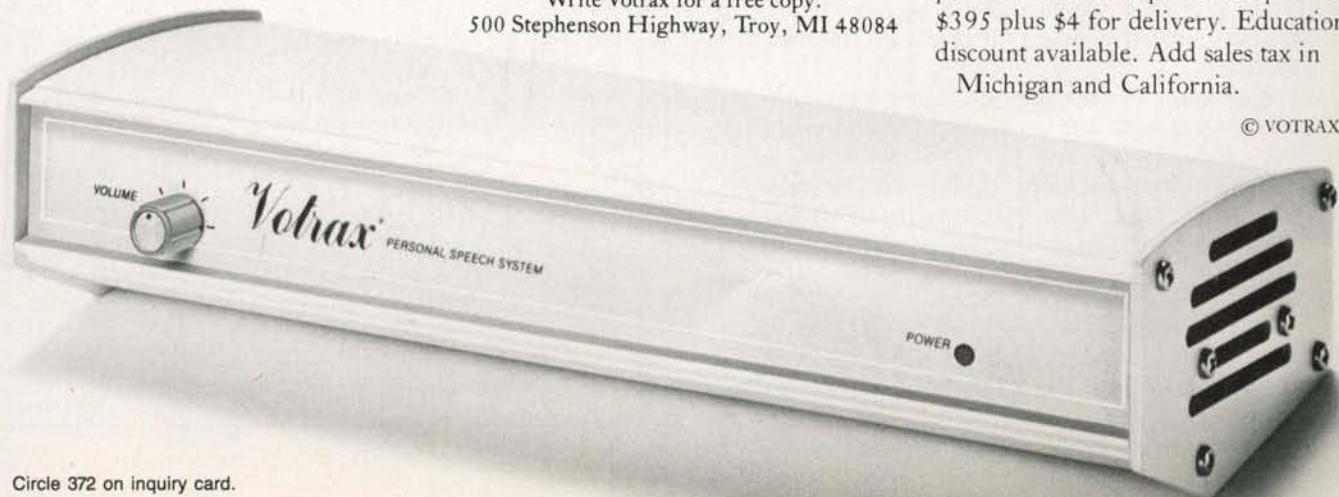

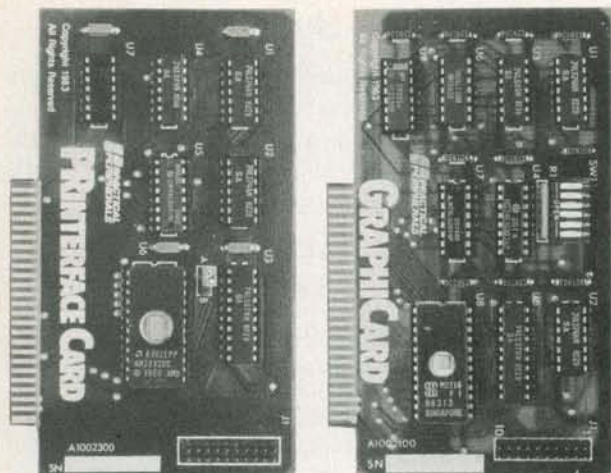

\$75*

\$99*

RIGHT FACE. RIGHT PRICE.

At \$75 and \$99 respectively, PRINTERFACE™ and GRAPHICARD™ are the right parallel interface products for your Apple II, II+, IIe or Apple** compatible system.

But don't be fooled by those low prices. High performance features and high reliability make them the right choice for serious printing requirements.

PRINTERFACE, for example, offers 27 easy commands that let you format text, send controls to the printer. You can even dump 80-column text screen from your Apple IIe.

GRAPHICARD gives you all that, plus graphics capabilities for 37 of the most popular printers. Eight additional commands permit a variety of graphics, screen dumps, including side-by-side, top-to-bottom, double size, inverse, emphasized, rotated and mixed text and graphics. For Apple II owners, the GRAPHICARD will give 80-column screen dumps from the Videx™ 80-column board.

By the way, if you buy PRINTERFACE and decide later that graphics would be nice, there's an easy-to-install upgrade kit that'll do the trick just fine.

Both cards clearly give you more for your money. And both are warranted for five years. That's right, **five years.**

So drop into your local dealer and ask about PRINTERFACE and GRAPHICARD today. Two more practical products from Practical Peripherals.



31245 La Baya Drive, Westlake Village, CA 91362
(213) 991-8200 • TWX 910-336-5431

*Suggested retail price.

**Apple is a registered trademark of Apple Computer, Inc.

locking (files, mode, size)

int files;

int mode;

long size;

We'll describe some of the notation as we go along, but a complete specification of the C language is contained in Kernighan and Ritchie's book on C. All Unix and Xenix documentation uses headers such as this one to specify exactly what a routine's calling sequence is.

access	determine accessibility of file
acct	turn accounting on or off
alarm	schedule signal after specified time
brk	change core allocation
chdir	change working directory
chmod	change mode of file
chown	change owner and group of a file
chroot	change the root directory
close	close a file
creat	create a new file
dup	duplicate an open file descriptor
exec	execute a file
exit	terminate process
fork	create a new process
getgid	get group identity
getpid	get process identity
getuid	get user identity
indir	indirect system call
ioctl	control device
kill	send signal to a process
link	link to a file
lock	lock a process in primary memory
lseek	move read/write pointer
mknod	make a directory or a special file
mount	mount a file system
nice	set program priority
open	open file for reading and writing
pause	stop until signal
pipe	create an interprocess channel
profil	execution time profile
ptrace	process trace
read	read from file
setuid	set user identity
setgid	set group identity
signal	catch or ignore signals
stat	get file status
stime	set time
sync	update super block
time	get date and time
times	get process times
umask	set file creation mode mask
umount	remove a file system
unlink	remove directory entry
utime	set file times
wait	wait for process to terminate
write	write on a file

Table 1: Standard Xenix system calls.



PANTHER



UNLEASH THE POWER

Having been in the microcomputing industry for 10 years, VR Data Corporation has earned its reputation for microcomputing excellence. For over a year we have been making solid deliveries of the PANTHER establishing ourselves as THE SOURCE for proven, premium quality Winchester Disk Subsystems. The PANTHER satisfies the most demanding mass storage needs with capacities of up to 30 megabytes or more.

Utilizing 5 1/4" Winchester disk drive technology, and microprocessor based error correcting controller boards, the PANTHER continues to be the #1 choice of discerning professionals. Available with one or two drives in one enclosure, the PANTHER can support many combinations of fixed and removable drives.

Now VR Data Corporation proudly introduces the newest member in the Panther family of Winchester Disk Drives, the "CUB". The CUB is a sub-mini Winchester Disk Subsystem, representing the latest in innovative technologies. With advances such as 100mm thin film plated media with embedded digital servo, and switch mode power, the CUB placed VR Data well out ahead of the pack. Available in single (master) and dual (master/slave) drive configurations, the CUB provides the user with capacities up to 10 megabytes of fixed or removable storage media.

The CUB's sleek low profile design totally eliminates that overcrowded work area problem and adds a professional appearance to your system. The CUB removable media drives are ideal for 5 megabyte on-line storage as well as 5 megabyte backup for your fixed media drives. Adapter modules are available for the most popular microcomputers. The PANTHER family of drives are available at quality Computer Stores everywhere. If your dealer does not yet carry PANTHER Drives from VR Data, tell them the future has arrived.

VRdata

777 Henderson Blvd. • Folcroft, PA 19032 • (215) 461-5300

Circle 373 on inquiry card.

Note that the notation is terse and assumes that you understand both the nuances of the C language and how C was used to implement the function.

The parameter `files` is the file description (i.e., the unique identifier) of the file to be locked. Variables are shown in C-language-type declaration statements as either integer (`int`) or long integer (`long`).

Binary semaphores are implemented in Xenix as a special file type having a length of 0. Each semaphore has a name (`sem_name`) and a mode that specifies permissions. A program creates the semaphore as follows:

```
int creatsem (sem_name, mode)
char *sem_name; /* a character pointer */
int mode;
```

Execution of the integer function `creatsem` causes the semaphore to be reset and a unique semaphore identification number to be returned. Other processes can then open the semaphore with a routine `open_sem`, but access is granted only if the calling process has been given permission by the creating process. The routine `wait_sem` suspends the calling process until that process is signalled by the routine `sigsem`. More than one process may wait for a given semaphore to be set. A first-in-first-out (FIFO) queue is maintained by the system for each semaphore. A program that reads a shared file issues `sigsem` when it is done with the file. The `sigsem` call awakens the next process on the FIFO stack that is

waiting to use the file. The routine `nbwaitsem` checks to see if the queue for a particular semaphore number is empty.

Thus, the semaphore routines provide the tools with which programmers can construct a binary signaling system between processes. The system is totally maintained by the programmer. A high degree of skill is required to use these facilities. But some such facilities are essential to the implementation of any multiuser application program on a system where one action must be completed before the initiation of the next.

Xenix also provides several convenience routines such as a "check" routine, `rdchk`, which looks to see whether there is any data to be read on an input stream. Programmers can use the routine to avoid annoying "hangs" or inactive input streams. The routine `shutdn` does all of the housekeeping necessary to shut down the Xenix system in an orderly fashion, including flushing all buffers to disk and halting the central processing unit. The consequences of a disorderly shutdown, caused by a power outage or an inadvertent flick of the power switch on the disk or the processor, are quite uncomfortable. Data and even whole files and file systems can be lost without the possibility of resurrection (unless you really know what you are doing). To reduce the impact of such incidents, Xenix also supplies a tool that allows some of the worst effects of a damaged file system to be fixed. File-system-repair programs can replace the root file system's "super block" by passing a new super block in still

GTEK INC. DEVELOPMENT HARDWARE/SOFTWARE

HIGH PERFORMANCE/ COST RATIO

(601) 467-8048

EPROM PROGRAMMER

Compatible w/all Rs 232 serial interface port * Auto select baud rate * With or without handshaking * Bidirectional Xon/Xoff and CTS/DTR supported * Read pin compatible ROMS * No personality modules * Intel, Motorola, MCS86, Hex formats * Split facility for 16 bit data paths * Read, program, formatted list commands * Interrupt driven, program and verify real time white sending data * Program single byte, block, or whole EPROM * Intelligent diagnostics discern bad and erasable EPROM * Verify erasure and compare commands * Busy light * Complete w/Textool zero insertion force socket and integral 120 VAC power (240 VAC/50Hz available)

DR Utility Package allows communication with 7128, 7228, and 7956 programmers from the CP/M command line. Source Code is provided. PGX utility package allows the same thing, but will also allow you to specify a range of addresses to send to the programmer. Verify, set the Eprom type.

MODEL 7316 PAL PROGRAMMER
Programs all series 20 PALS. Software included for compiling PAL source codes.

Software Available for CPM,¹ ISIS,² TRSDOS,³ MSDOS.⁴

1. TM of Digital Research Corp.
2. TM of Intel Corp.
3. TM of Tandy Corp.
4. TM of Microsoft.

Post Office Box 289
Waveland, Mississippi 39576
[601]-467-8048

\$799 stand alone MODEL 7956

MODEL 7956 GANG PROGRAMMER
Intelligent algorithm. Stand alone, copies eight EPROMS at a time. With RS-232 option \$999.

\$499 MODEL 7316

\$1195 MODEL 7324

MODEL 7324 PAL PROGRAMMER
Programs all series 20 & 24 PALS. Operates stand alone or via RS232.

\$499 MODEL 7228

MODEL 7228 EPROM PROGRAMMER
All features of Model 7128 plus Auto Select Baud, super fast adaptive programming algorithms, low profile aluminum enclosure. Programs 2764 in one minute!

\$389 MODEL 7128

MODEL 7128 EPROM PROGRAMMER Programs and Read:

NMOS	NMOS	CMOS	EEPROM	MPU'S
2508	2758	27C16	5213	8748
2516	2716	27C32	5213H	8748E
2632	2732	C6716	X2816	8749E
2564	2732A	27C54	48016	8741
68766	2764		12816A	8742E
68764	27128			8741E
8755	27256			8751
5133				

- Model 7128-L1,L2,L2A \$209
- Model 7128-24 \$289
- DR8 or DR5 \$ 30
- DR8PGX or DR5PGX \$ 75
- Cross Assemblers \$209
- XASM (for MSDOS) \$250
- U/V Eraser DE-4 \$ 78
- RS232 Cables \$ 30
- 8751 adapter \$174
- 8755 adapter \$135
- 48 Family adapter \$ 96

... and so respectively. Supply a two-digit
station of the hours, minutes and seconds for H, M and
seconds. When the line specified corresponds to the
line, strike a key and TDR sets the current date and
is continues.

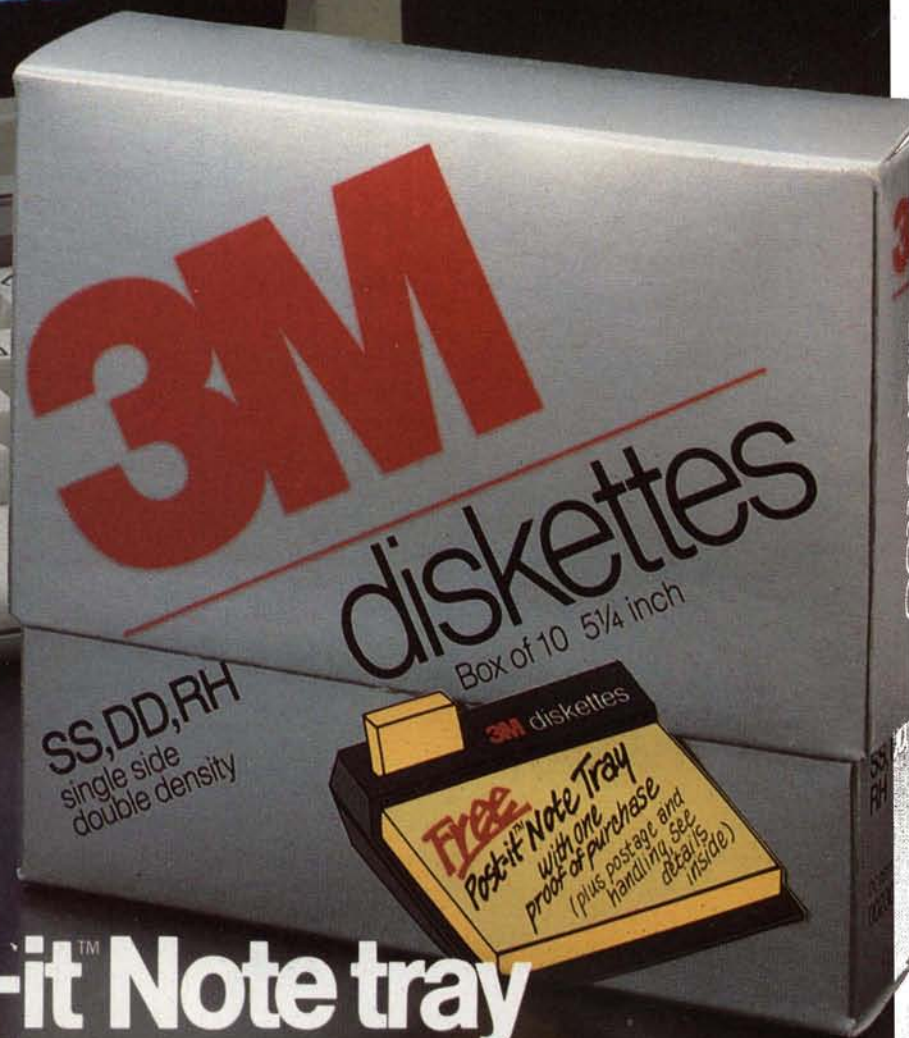

Free Post-it Note tray from 3M diskettes.

We'll give you a 3M Post-it[™] Note tray and a sample pack of Post-it Notes — a \$4.98 value. Absolutely free! Just buy any specially marked box of 3M diskettes and send in the proof of purchase — with 75¢ for postage and handling. Complete details inside specially marked diskette boxes.

One 3M value deserves another.
3M diskettes have long been noteworthy for their unparalleled reliability. A reputation based

on over 30 years experience in manufacturing high quality computer media. Now we're giving you one more good reason to use high quality 3M diskettes.



So buy a specially marked box of 3M diskettes. And send for your free Post-it tray and notes today! Look in the Yellow Pages under computer supplies and parts for the 3M distributor nearest you. In Canada, write 3M Canada, Inc., London, Ontario. If it's worth remembering, it's worth 3M data recording products.

3M hears you...

Circle 356 on inquiry card.





Current Specials

IN STOCK NOW

IBM-PC

\$2995

Two 320 drives, 128k RAM, color graphics/monochrome card, monochrome monitor.

Call for prices on KayPro, Superbrain, Northstar, & other brands.

PRINTERS

Tally 160L \$659
Okidata 92 \$449
IDS Prism 132 \$1209
Gorilla Banana \$229
Gemini 10X \$329

MONITORS

AMDEK 300A \$159
AMDEK Green \$149
Zenith ZVM 121 \$95
Zenith ZVM 123 \$129
BMC Green \$89

MODEMS

Hayes Smartmodem \$219
Hayes 300/1200 \$509
Hayes 1200B \$439
Anchor Mark VIII \$349
Anchor VI Internal IBM \$192

All other brands at similar savings

GEMINI 15 printer, 100 cps, 15" carriage **\$359**

KOALA PAD

APPLE \$99
IBM \$109

ZENITH 122 Amber Monitor
800 Lines

\$129

SANYO 555 Computer
w/Wordstar, Spellstar, Infostar
CALL

HERCULES GRAPHICS
Card for IBM PC

\$359

HERE'S WHAT OUR CUSTOMERS SAY ... "full service attention at mail order prices. Informed, helpful, responsive." *Wes Gilbert, DATA I/O*

PACIFIC COMPUTERS

13240 Northrup Wy #4 - Bellevue, WA 98005

ORDERS ONLY
1-800-531-3133
Information
206-641-7233

Prices reflect 3% cash discount • Bankcards • Sorry no COD • FOB Bellevue

All items currently in stock



Exporting Services

We Are Buyer's Agent for Overseas Dealers and Distributors

- Lowest prices, immediate quotations, prompt delivery.
- Access to all major hardware and software manufacturers.
- All professional services provided: Licensing, Export Documentation, and Follow-through.

24-Hour Response as Close as Your Telex
TELEX 470851

American Buying and Export Services
1036 Country Club Drive, Moraga, CA 94556
(415) 376-7600

a structure that contains all of the header declarations for the super block of the file system to be repaired.

The Unix File System

The Unix file system is a hierarchical, or tree, structure. Microsoft has implemented the same general structure in a recent rewrite of its operating system for the IBM Personal Computer, PC-DOS version 2.0. The root directory, /, is where everything starts. Within / are kept data files, files that contain programs, and files that are directories of other files. It also contains a directory called /usr, which contains all of the user directories. Let's suppose that a user named Randy has, as his home directory, the file called randy. Randy writes a program called hello. To run that program it is only necessary to type the name of the program. What you type can be the whole name (/usr/randy/hello) or an abbreviation, depending on where you are—that is, what your current directory is. If you type `cd /usr/randy`, your current directory is randy and you can just type hello to execute the program. If your current directory is /usr, you must type randy/hello.

Files and file systems are held together with a glue made of pointers. Files reside in any blank space available on a disk. If the first space available is too small, the file is written partly in that space and partly in the next free space. Pointers keep track of what is where. Because directories are nothing but files, it is possible that a single bad pointer can lose hundreds or thousands of other files.

Additional problems can occur in relation to another feature of the operating system: to enhance performance writes to disk are not necessarily done when requested by the user or calling program. This is because Unix I/O is heavily buffered in memory. When some event calls for a write, the write occurs to the buffer and the system decides whether it is time to flush the buffer to the disk. Every 30 seconds or so a housekeeping process (called a daemon) comes along and flushes the buffers so that the disk doesn't get too far out of synchronization. No surprisingly, this daemon is called sync. Sometimes, due to a power fault, a bad memory location, or some other event, the disk and the memory buffers are left unsynchronized as the system crashes. Even the best-run and best-maintained Unix system will encounter an occasional crash or partial crash. The result is usually a somewhat damaged file system. It is up to the person responsible for system maintenance to repair the damage.

System Maintenance

Unix version 7 supports programs used for file-system maintenance, backup, and system accounting. Xenix has made a number of extensions to the system to make maintenance easier. File systems can be repaired using `dcheck`, `icheck`, `ncheck`, and `clri`. These utilities give the system maintainer a high degree of flexibility, but to be used effectively they also require a high degree of knowledge about the file system. Xenix includes a Unix System III utility `fsck` (file system check) to help simplify repairs to the file system.

Turn Your FLOPPIES Into FLIPPES

5 1/4" FLIP



aligned, accurate,
safe way to make
index-hole cutouts.



DOUBLES YOUR DISKETTE MEMORY IN SECONDS!

The self-aligning Write-Enable Punch has a special Deep-Grooved and "Case-Hardened" Steel Punch for making a clean write-enable cutout. Just insert into diskette and punch. Flip-it will pay for itself immediately — because every diskette you own or will buy is now like owning or buying two. Order yours today.

- a) 5 1/4" FLIP-IT: for all 5 1/4" computers incl. IBM, Osborne, Atari, Radio Shack, Commodore, Kaypro, Franklin & more only
- b) 8" FLIP-IT: for 8" computers incl. IBM, Altos, Radio Shack, DEC, DG, & more only
- c) Labels: (self-sticking, 100 ea.)
- d) Write Protect/Enable: (5 1/4" or 8") (100 ea.)
- e) Hub-Reinforcing Kit: (positioning-tool & 5 1/4" disks: \$10.99 8" disks: \$12.99)
- f) Hub-Reinforcer Rings: (50 rings ea. for opening) 5 1/4" disks: \$5.85 8" disks: \$6.95
- g) Disk Sleeves: (lint free, 10 ea.) 5 1/4" disks: \$2.55 8" disks: \$3.55

Add \$2.50 for shpg and hdg. (AK, HI, Canada=add \$5, Int'l orders add USD10) — Mass. res. add 5% tax

Tel: (617) 527-FLIP

Circle 475 on inquiry card.

Flip-It

P.O. Box 201, Newton Hlds., MA 02161

Telex: 4991009 CHTRI

copyright 1983 D/Punch Corp.

We acknowledge all trademarks

Program	Unix Version 7	Xenix	TRSDOS
log in accounting	ac	ac*	
turn on system accounting		accton*	
prompt for correct time		asktime*	
clear i-node	clri	clri*	
directory consistency	dcheck	dcheck*	
turn off terminals		disable	
incremental system dump	dump	dump	
directory of dump tape		dumpdir	
turn on terminals		enable	
file system consistency		fsck	
quickly halt system		haltsys	
storage consistency	icheck	icheck*	
test RAM			memtest
make a file system	mkfs	mkfs	format
make a special file	mknod	mknod	
add login ID to system		mkuser	
mount file system	mount	mount	
name for i-numbers	ncheck	ncheck*	
incremental system restore	restor	restor	
remove user from system		rmuser	
system accounting	sa	sa*	
print and set dump dates		sddate*	
gracefully halt system		shutdown	
become super user	su	su	
update super block	sync	sync	
back up script		sysadminn	backup
tape archiver	tar, tp	tar	
dismount file system	umount	umount	

*Available with the optional Radio Shack Development System.

Table 2: Unix version 7 maintenance programs.

Backup is a key to the integrity of Unix systems. Invariably, even with expert use of the file-maintenance utilities, files are lost due either to user error or to system error (user error is far more likely). The only effective remedy is a current backup of the file that was lost. Xenix supplies a menu-driven procedure (actually a shell script) called `sysadmin` to help users maintain an adequate backup of the system, and `sddate` is used to maintain a backup history for the system.

Normal system maintenance includes authorizing new users, deleting unneeded user accounts, establishing a logical connection between new hardware (e.g., terminals) and the system, and starting and stopping the system. Xenix has made many of these chores easier. The programs `mkuser` and `rmuser` establish (make) a user account and remove one in a far easier way than Unix, where the manager must edit the `/etc/passwd` file. In Unix version 7 the terminals were enabled and disabled by editing the `/etc/tty` file. In Xenix the programs `enable` and `disable` simplify this process. The program `shutdown` is used to warn other users that the manager intends to shut the system down. The `haltsys` program accomplishes the shutdown quickly.

Table 2 is a brief description of the maintenance programs available in Unix version 7, Xenix, and, for com-

2000 letters per hour via your personal computer



delivered in 48 hours or sooner
at 26¢ a piece.

Whether it's credit and collection applications, announcements to your customers, or sales promotions for new services, our MAIL-COM software turns your personal computer into a one-button mailing house of enormous power. All you need is a modem, a personal computer, and our MAIL-COM software.

Our software allows you to link up with the U.S. Postal Service's new ECOM System. After receiving your letters via modem, the Postal Service will then print, stuff, seal and deliver the letters usually by the next day and guaranteed within 48 hours.

MAIL-COM is a complete, interactive package supporting all ECOM formats. Available now for the IBM PC (\$195.00), CP/M (\$195.00) and the Alpha Micro (\$495.00).

To order, call or write.

Digisoft
Computers

1501 Third Avenue
New York, NY 10028
(212) 734-3875

UNIX

and MS-DOS, and VMS too!

UniPress can meet your software needs, for a range of hardware, including VAX, MC68000, and IBM-PC.

UniPress, your UNIX source.

PACKAGING: VAX/VMS and UNIX, MC68000/UNIX on Sun, Masscomp, Apollo, Tandy 16, Apple Lisa, Sritek Board for IBM PC, Dual, Plexus, Callan, and Cyb. Perq and Perkin Elmer, too. Source code, as well as binary. Maintenance available. Inquire regarding other hardware.

UniPress Software

UNIX SOFTWARE

Priced from

- Full UniPlus+ UNIX for Apple LISA \$ 495
- EMACS—Multi-window text editor (Gosling version) 395
- LEX—Powerful word processor 500
- PHACT—Isam file manager 250
- /RDB—Relational database tools 250
- MENU SYSTEM—Menu generation 495
- UniCalc—Powerful spreadsheet 350
- MIMIX—CP/M emulator 495
- C cross compiler—to 8086 and 68000 (includes assembler, linker, etc.) 8000

MS-DOS SOFTWARE

- Software tools—Unix-like facilities add power to MS-DOS: includes ed, grep, sort, diff, cat, etc. 200
- PHACT—Isam file manager 250
- C compiler—Full C language 395
- Coherent—Unix-like operating system for IBM-PC XT 500

VMS SOFTWARE

- EMACS—Multi-window text editor (Gosling version) 2500

OEM and dealer inquiries invited. Quantity terms available.

Call or write for more information.

UniPress Software, Inc.

1164 Raritan Avenue, Highland Park, NJ 08904
201-985-8000 Toll Free: 800-222-0550 (outside NJ)
Telex: 709418

Mastercard and Visa

Overseas distribution available through
Lifeboat Associates—Japan

Unix is a trademark of Bell Laboratories.
VMS is a trademark of Digital Equipment Corp.
MS-DOS is a trademark of Microsoft.
UniCalc is a trademark of Lattice, Inc.

parison, TRSDOS (an operating system that we perceive to be similar in scope—if not in structure or detail—to most of the common single-user operating systems in the microcomputer market today). Entries in tables 2 through 15 marked with an asterisk (*) in the Xenix column are available with the optional Development System from Radio Shack or Microsoft. Entries in tables 3 through 15 marked with the † symbol are from the Berkeley implementation of Unix.

Program Development

Unix version 7 supports the program-development environment with a standard set of languages (included in the operating system package): f77 (FORTRAN 77), RATFOR (Rational FORTRAN preprocessor), a rudimentary BASIC interpreter, and, of course, C, as well as a host of useful utilities such as an assembler, a debugger, and library management. Table 3a shows the program support utilities available in several operating systems. Table 3b lists the programming languages, utilities, and related programs available in Unix and Xenix. Note that language software for Xenix is available only in the Development System or as a separate package. The `arvc` utility converts an archive from PDP-11 format (most of Unix was originally developed on PDP-11s) to one suitable for the Motorola M68000. Another utility, `ctags`, is used with `vi`, a full-screen (visual) editor of considerable power and complicated syntax, to edit programs using more than one source file. With `ranlib` you can convert an archive to a randomized library that can be used with the link editor—a program that takes the output of compilers or assemblers (i.e., object programs) and puts them together to form a single runnable program (thus, a “fix” in one program module requires only short recompilation and linkage editing to have the program running again). The Berkeley extensions `mkstr`, `strings`, and `xstr` minimize the storage space required for strings used in C programs.

Unix/Xenix Text Processing

The Unix community has spawned a number of editors and text processing systems. Xenix makes many of the text processors and two editors available to users. The Unix line-oriented editor `ed` is easier to use on a printing terminal than on a screen, but it is simple and quick and, for short texts, very effective. The `vi` editor has a manual nearly an inch thick and is a very powerful screen-oriented character editor. Each of these editors can be used to prepare text that can be subsequently processed by one of the formatting programs. Note that what you see is *not* what you get in the system. The text-processing formatters such as `nroff`, `troff`, and `neqn` provide tremendous flexibility and handle chores such as typesetting, mathematical equations, tables, and reference sections. The problem is that this is a multistep process. You place formatting commands into the text during text editing. To see the effect of these commands, you submit them to the proper formatter and print the result. You then proof the output, noting typographical errors, editorial changes, and format goofs. Back to the

\$\$ "LOWEST PRICES" \$\$



SMITH CORONA LETTER QUALITY PRINTERS

SMITH CORONA TPII	\$ 444
TPI STOCK SALE ONLY 7 LEFT	375
TELETEX TTX-1014 S & P	506
STARWRITER 40 cps S or P	1112
PRINTMASTER 55 cps S or P	1436
NEC 3510 33-cps SERIAL	1409

DOT MATRIX PRINTERS

GORILLA BANANA Graphics	221
PANASONIC KX-P1090 Fr&Tr	
Emulates FX-80	321
STAR MICRONICS GEMINI	
10X 120cps dot graphics	307
15X 120 cps like MX-100	484
OKIDATA	
82A Serial & Parallel 120cps	CALL
84 Parallel 15" Fr&Tr 200cps	CALL
92 Parallel 10"Fr&Pin 160cps	CALL
C. ITOH	
PROWRITER 8510 10"Par 120cps	404
8600 Near Letter Quality Par	1031
IDS MICROPRISM	510
EPSON FX-80	595

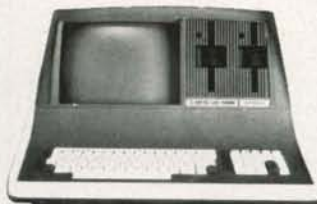

SUPERBRAIN

SUPERBRAIN II

DOUBLE DENSITY	\$1970
QUAD DENSITY	2376
SUPER DENSITY	2684
COMPUSTARS FOR NETWORKING	CALL
Prices too low to advertise	
SYSTEMS GROUP Multi-User	
SYSTEM 2966 w/17Mb Tape Backup	
8" Floppy+19Mb Hard Disk	\$7434
RADIO SHACK TRS-80 SAVE!	CALL

AMERICAN SQUARE COMPUTERS is organizing a World Wide Association of Computer Dealers. Open a Store or Start Work Out of Your Home! We Charge NO FRANCHISE FEE! (Our Competitors charge a FRANCHISE FEE of \$15,000.00 to \$45,000.00.) Be a Winner! Let US help YOU get started MAKING MONEY by HELPING PEOPLE to put COMPUTERS to WORK. Write or Phone Today.

Which Computers are Best FREE

Insured Shipping at Low Rates.

ADVANCED DIGITAL

ADVANCED DIGITAL 6MHz COMPUTER
SINGLE BOARD Z80B RS232 S-100 128K
with DISK CONTROLLER for 5"or8"
SUPER SIX (Includes PSNET/1) \$ 555
SUPER SLAVE=Z80B+PSNET/I+128K 491
SUPER STAR has 5Mb removableHD 4460
CPM 3 350
TURBODOS MULTI USER 518

ALTOS COMPUTERS

ALTOS S-100 COMPUTERS	
580-2 3-User 2 5 1/4"	\$2111
580-10 3-User Hard Disk	3806
580-20 3-User 20Mb	4562
8000-14 with 208K RAM	8340
586-10 16-bit 12Mb Hard Disk	5807
586-30 16-bit 30Mb Hard Disk	7176

TRAXX 5 1/4" ADD ON DRIVES

TRAXX 5 1/4" ADD ON DRIVES	
Bare drive SSDD	\$ 222
SSDD w/cabinet & power supply	322



TELEVIDEO

TERMINALS

TELEVIDEO 910 Emulates	\$ 419
TELEVIDEO 910+ Smart	538
TELEVIDEO 914 NEW Detach Kbd	506
TELEVIDEO 924 NEW Non-volatile	614
TELEVIDEO 925 Detach keybrd	674
TELEVIDEO 950 Prog funct keys	863
TELEVIDEO 970 VT-100 compat	935
ADDS Viewpoint 3A+ Emulates	442
ADDS Viewpoint G Graphics	1371
ADDS Viewpoint 60G Graphics	1511
ADDS Color Terminal NEW!	998
Zenith Z-29 Z19&VT100 compat	655
Zenith ZT-1 Terminal+modem	483
Visual 50 Ergonomic	653
Visual 55 New! Enhanced #50	734
Visual 102 80/132 columns	890
V102 Graphics option for 102	653
Visual 300 ANSI&VT100 compat.	842
Visual 330 VT52&Haz1500 comp.	842
Visual 500 Graphics 14"screen	1970
Visual 550 Graphics,Buffered	2138

MONITORS

ZENITH	
ZVM-122 Amber Phosphor	\$ 117
ZVM-123 Green Phosphor	134
ZVM-131 Composite Color	322
ZVM-RGB-135 Color Monitor	491
USI 12" Amber 20 MHz	\$ 149

NEC	
JB1205M 12" Amber Phosphor	\$ 190
JC1215 12" Color w/Audio	312

AMDEK	
AMDEK 13" COLOR I Demo,1 left	257

GRAPHICS & COLOR GRAPHICS

VECTRIX
VX 128 8 colors 322x560 Pix. \$1795
VX 384 16.8 million colors 3595
VXM Hi Res. 13" RGB Monitor 1221

MICROANGELO
MA 512 512x480 Monochrome \$ 674
MA 520 512x480 + Screen Pak2 890

COMPUTERS

COMPUPRO
Compupro computers come as main-frame, boards, and drives, and you must set the switches.

816A Computer 8085/8088 128K	\$4106
816B Computer 8085/8088 256K	5180
816C 8085/8088 512K 3 users	6613
816D 10 MHz 8086 512K	10194
816-08 CPUZ 208K Oasis	CALL
816-016 10 MHz 8086 512K	CALL
816-68K 8 MHz 68000 256K	6471

SEATTLE Pure 16 bit computer is the fastest microcomputer by actual test!

S-100, 128K Static Ram, 8 MHz
8086 18-slot Mainframe, 3 serial & 1 parallel ports.
Gazelle II Avail. Nov/Dec CALL
Hard Disk Gazelle II CALL

TARBELL with 2-8" disk drives

TARBELL REBEL S-100 64K Z80B 6MHz	
REBEL 2 2 5 1/4" Flpy=800K	\$2479
REBEL 5 1/4" Floppy + 5Mb HD	3009
REBEL 5 1/4" Floppy +10Mb HD	3139
REBEL 5 1/4" Floppy +16Mb HD	3268
TARBELL EMPIRE S-100 64K 2 8"Drvs	
EMPIRE I Single sided	\$3304
EMPIRE II Double sided	3775

MEDICAL SOFTWARE

MICROMED or MICRODENT	\$1656
STARDOC for OASIS SYSTEMS	350



NORTH STAR ADVANTAGE

NORTH STAR ADVANTAGE 8 BIT	8/16
Work Station	\$1996 \$2329
2 Floppies 360K ea.	2298 2631
5 Mb Hard + 360K Floppy	3432 3765
15 Mb Hard+ 360K Floppy	4566 4899

NORTH STAR HORIZON

	1 User	Multi
2 Floppies 360K ea	\$2775	N/A
5 Mb Hard & Floppy	3833	\$6948
15 Mb Hard +Floppy	4595	7147
18 Mb Hard +Floppy	6101	8647
CALIFORNIA COMPUTER SYSTEMS		
CALSTAR 2 8" Drvs 2.5Mb 128K	\$2295	
2210-01 ONLY 4 LEFT IN STOCK	615	



Micro Decision II

MICRO DECISION
"A DEAL YOU CAN'T REFUSE"

64K RAM Z80 4MHz 2 serial ports
1 parallel port 2 5 1/4" drives.
Free Software: CPM 2.2, MicroSo
Basic, BaZic, WordStar, LogiCa
spreadsheet, Correct-it spelli
checker, Personal Pearl data ba
ON
MD2 2 Single sided drives \$ 9
MD2 + MDT50 Terminal 12
MD2 + MDT50 + MP100 Printer 17
MD3 Business Computer: Featurin
Free Software above + Free QUEST
BOOKKEEPER SYSTEM FANTASTIC BUY!
MD3 2 Double sided drives \$11
MD3 + MDT50 Terminal 14
MD3 + MDT50 + MP100 Printer 19
MD11 has 10Mb HARD DISK+1DSDD (1)
and 128K RAM and CPM 3+ \$16
ABOVE PACKAGES INCLUDE ALL CABLE

DECISION I

SingleUser=FREE CPM, MicroSoft Basic
S-100, IEEE 696, 14-slot, 4 MHz Z8
Realtime clock, Interrupts, 3 Serial
& 1 parallel port, 64K RAM expandab
to 1 Megabyte
D100
D120 = D100 + DSDD 5 1/4" + 10Mb \$17
+Wordstar, Correct-It, LogiCalc
BaZic, Personal Pearl, and Quest
Bookkeeper Software 35
MultiUser = Hardware & Software at
D120 w/256K RAM & Memory Protect
+ Micronix Operating System runs
16 programs simultaneously!
D200 w/10 Mb DMA Hard Disk 38
D210 w/16 Mb DMA Hard Disk 42
D220 = D210 w/512K RAM & 6 Serial
2 Parallel ports. A 6-user system
can be upgraded for 15 users. 52

MORROW DISK DRIVES

Complete systems include S-100 con-
troller, power supply, cabinet, & fan.
CPM & Basic 80
Add Drives include power supply, cabi-
net & fan.

	System	Driv
5 1/4" Win.	10Mb	\$1572
5 1/4" Win.	15Mb	1713
8"Winchester	10Mb	2625
8"Winchester	20Mb	3187
MORROW 8" FLOPPY DISK DRIVES w/Drvs		
One 1 sided	\$ 870	\$ 57
One 2 sided	1081	86
Two 1 sided	1418	101
Two 2 sided	1839	143

APPLE, IBM OR MORROW, WHICH IS BEST? FREE BROCHURE!

Call for latest prices & availability

Factory Guarantees

We Beat Prices

AMERICAN



COMPUTERS

919-889-4577

4167 Kivett Dr.

Jamestown N.C. 27282

919-883-1105

Circle 24 on inquiry card.

MRS/OS Source Code

THE Z-80 OPERATING SYSTEM

- Runs CP/M 2.2.* and CDOS* application programs
- Contains 55 OS function calls
- Direct and Standard console I/O
- Standard console I/O includes numerical formatting and I/O steering
- User defined "CNTRL C" function
- Sequential and Random disk file access
- Provides Standard file management functions plus Direct Disk Access
- 12 system utility functions include PATCH AND BATCH
- Requires 32K Z-80 computer with editor and assembler
- Directory utility provides directory error checking, statistics, and alphanumeric ordering
- "HELP" menus throughout

FULLY COMMENTED SOURCE CODE included in 250 page manual

Source code also provided on **8" SSSD disk** or **5 1/4" SSSD disk** (please specify)

ONLY \$59.95 COMPLETE

(includes shipping & handling)
Mass. orders include 5% sales tax



16 Bowman Lane
Westboro, MA 01581
(617) 366-8969
Phone orders welcome

CP/M is a registered trademark of Digital Research Corp.
CDOS is a registered trademark of Cromemco Corp.



Continuous CHECKS

for Desk-Top Computers
as low as **\$29.95**

for 250 checks printed with your name and bank information

- Statements, invoices, other forms compatible with software from over 300 sources.
- Or program to NEBS standard forms yourself.
- Quality products in small quantities shipped direct to you. Fast service, low prices, money-back guarantee.

FREE one-stop catalog of computer forms, stationery, supplies and accessories.

Write or phone for your copy Today.

TOLL FREE 1 + 800-325-1117

(Mass. residents 1 + 800-448-4688)

G5A84.3

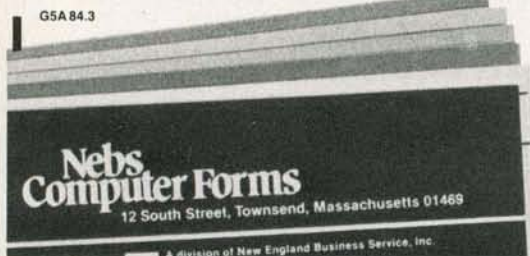

A division of New England Business Service, Inc.

CODE 11006

(3a)

Program	Unix			
	Version 7	Xenix	TRSDOS	CP/M
debugger	adb	adb*	debug	ddt, save
archive/library manager	ar	ar*		
convert archive format		arcv*		
assembler	as	as*		asm
create a tags file		ctags*†		
link editor	ld	ld*		load
ordering for library	lorder	lorder*		
maintain program group	make	make*		
message file from C		mkstr*†		
print name list	nm	nm*		
octal dump	od	od*	list	dump
display profile data	prof	prof*		
size of an object file	size	size*		stat
remove object file parts	strip	strip*		
time a command	time	time*		
randomize library		ranlib*		
extract objects strings		strings*†		
extract C strings		xstr*†		

*Available with the optional Radio Shack Development System.
†From the Berkeley implementation of Unix.

(3b)

Program	Unix	
	Version 7	Xenix
BASIC interpreter	bas	
unlimited precision	bc	bc*
C program beautifier	cb	cb*
C compiler	cc	cc*
desk calculator	dc	dc*
FORTRAN 77 compiler	f77	
lexical analyzer generator	lex	lex*
C program verifier	lint	lint*
macro processor	m4	m4*
rational FORTRAN dialect	ratfor	ratfor*
structure FORTRAN	struct	struct*
parser generator	yacc	yacc*

*Available with the optional Radio Shack Development System.

Table 3: Support utilities of four operating systems (3a) and languages and utilities available for Unix and Xenix (3b).

editor. The typos and changes are easy, but figuring out how to get the formatting just right is a matter of considerable effort for those of us who haven't had the foresight to get a Ph.D. in nroff. Table 4 shows what text utilities are available in Unix and Xenix.

File Processing

File processing was an area of considerable concern to the Unix system designers. An efficient program-development environment requires all sorts of neat ways to get at things, to see if one thing is the same as another or to sort things into some reasonable order. Xenix provides the complete Unix version 7 file-processing set and extends the set by a considerable margin. Table 5 shows the file-processing capabilities of Unix, Xenix, TRSDOS,

Become a dBASE II[®] expert without cracking a book.



dBASE II is, quite simply, the best-selling database management system (DBMS) made for any computer, ever. And with over 150,000 users so far, it's become the standard for managing data with a microcomputer.

Jump into dBASE II, disk-first.

The best way to learn to use dBASE II is to use dBASE II. Our on-disk tutorial is a hands-on interactive learning system that will get you up to speed on dBASE II, quickly and easily. Then you can use your new-found knowledge to create a full business information system that does exactly what you need done. A system that will handle today's problems, yet grow with you.



dBEST deal in town.

When you buy dBASE II, you'll be getting the most advanced information management tool available for your micro for only \$700 (suggested retail price). At the same time, you'll be getting the most advanced teaching tool (the dBASE II On-Disk Tutorial) for free.

For the name of your nearest dBASE II dealer, contact Ashton-Tate, 10150 West Jefferson Boulevard, Culver City, CA 90230, (800) 437-4329, ext. 212. In the U.K., call (0908) 568866.

ASHTON-TATE

dBASE II is a registered trademark of Ashton-Tate.
© Ashton-Tate 1983

Here's just a taste of our great prices.

DISKETTES

3M
S.S.D.DEN 40 TRK, 10, 16 SECTORS \$ 22.00
D.S.D.DEN 40 TRK, 10, 16 SECTORS... 34.50

VERBATIM DATALIFE
MD 525-01, 10, 16... \$ 24.50
MD 550-01, 10, 16... 42.50

PRINTERS

C-ITOH F-10 40 CPS P/S... \$ 1250.00
C-ITOH F-10 55 CPS P/S... 1590.00
C-ITOH PROWRITER PARALLEL... 399.00
C-ITOH PROWRITER SERIAL... 550.00
EPSON GRAFTRAX PLUS... 60.00
IDS 480 MICROPRISM... 459.00
RIBBONS FOR MX-80... 8.95
RIBBONS FOR MX-100... 24.00
SOUNDTRAP for 80 column printers... 99.00

MODEMS

HAYES MICROMODEM II/e... \$ 256.00
HAYES SMART MODEM (300 Baud)... 208.50
HAYES SMART MODEM (1200 Baud)... 528.00
NOVATION APPLE-CAT (300 Baud)... 310.00

MONITORS

AMDEK COLOR II INTERFACE IIe... \$ 149.00
AMDEK RGB COLOR II... 465.00
AMDEK RGB INTERFACE... 145.00
AMDEK 300A... 159.00
AMDEK 310A IBM AMBER... 179.00
BMC GREEN MONITOR... 92.00
NEC 12" GREEN MONITOR... 158.00
TAXAN 12" AMBER... 145.00
USI AMBER 9"... 155.00
USI AMBER 12"... 165.00
ZENITH AMBER... 129.00

APPLE SOFTWARE

APPLE MECHANIC... \$ 23.00
APPLESOFT WORKSHOP... 37.45
BANK STREET WRITER... 49.98
BEAGLE BAG... 23.00
DOSS BOSS... 18.50
DOUBLE TAKE... 24.95
FIREFIGHTER... CALL
FORMAT II ENHANCED... 132.50
MICROTYPE II, Hayden... 24.35
PFS: GRAPH... 89.95
PFS: (NEW) PERSONAL FILING SYSTEM... 85.00
PFS: REPORT... 79.00
TIP DESK #1... 15.59
UTILITY CITY... 23.00

APPLE II/IIIe HARDWARE

ALS 6 MHZ CP/M w/64K/C-BASIC... \$ 319.00
KRAFT JOYSTICK... 48.94
MICROSOFT CP/M/80 col/64K RAM... 342.50
MICROSOFT Z-80 SOFTCARD... 229.00
QUENTIN APPLEIMATE... 238.00
RANA CONTROLLER... 104.00
SUPERFAN II... 62.00
SUPERFAN II W/ZENER... 84.50
SUPER FIVE HALF HEIGHT DRIVE... 269.00
VIDEX 80x24 VIDEO CARD... 229.00
ULTRATERM... 293.00
7710A ASYNCHRON. SER... 135.00

GREAT APPLE GAMES

FLIGHT SIMULATOR (NEW)... 34.50
LEGACY OF LLYLGAMYN... 32.35
LODE RUNNER... 27.25
WIZARDRY... 37.95
ZORK I, II, III... 28.00

IBM® HARDWARE

APPARAT CRANBO II w/64K... \$ 364.00
HERCULES GRAPHICS CARD... 399.00
KEYTRONICS KEYBOARD... 215.00
KOALA PAD... 99.00
KRAFT JOYSTICK... 52.69
LATTICE C COMPILER... 369.00
MICROSOFT FLIGHT SIMULATOR... 38.95
MICROSOFT 64K... 278.00
PLANTRONICS COLOR+ w/Draftsman... 475.00
QUADBOARD 64K... 308.00
QUADLINK... 550.00
Tandon TM100-2 Double head 40 trk... 235.00
TEAC HALF HEIGHT D.S. Disk Drives... 279.00
TECHMAR GRAPHICS MASTER... 587.00
T/G JOYSTICK... 47.95
T/G TRACKBALL... 47.95
USI MULTIDISPLAY... 499.00
64K MEMORY UPGRADE... 80.00

IBM® SOFTWARE

CONCURRENT CP/M 86... \$ 315.00
CP/M 86 DIGITAL... 54.00
d BASE II... 409.00
EASYWRITER II... 185.00
HOME ACCOUNTANT+... 105.00
JFORMAT... 29.00
LOTUS 1,2,3... 369.00
MICROSOFT FORTRAN... 257.00
MICROSOFT WORD W/MOUSE... 387.50
MONTE CARLO Multifunction Card 64K... 345.00
MULTIMATE... 324.50
PFS: FILE... 97.50
PFS: GRAPH... 97.50
PFS: REPORT... 97.50
PFS: WRITE... 107.00
PIE WRITER... 115.00
PROKEY... 58.50
VOLKSWRITER... 125.00
WORDSTAR... 279.50
WIZARDRY... 47.76

MISCELLANEOUS

FLIP & FILE DISKETTE STORAGE... \$ 19.95
6 1/4" BIB Diskette Cleaner w/solution... 8.95

To order or for information call

In Los Angeles:

(213) 706-0333 *

Alpha Byte

COMPUTER PRODUCTS

31304 VIA COLINAS
WESTLAKE VILLAGE, CA 91362

*For all your computer product needs, come visit us at our new California store.

Satisfaction Assurance — Your satisfaction is assured by our 30 day guarantee on all hardware products we sell. All manufacturers' warranties are honored by manufacturers. Dead-on-arrival software will be replaced free during the first 20 days, however, no refunds or exchanges on software. Proof of purchase required. All returns must be authorized in advance.

and CP/M. The copy utility is a handy extension that copies groups of files, whereas cp does so only with some fairly arcane manipulation. A Berkeley enhancement called more displays files a screenful at a time. Members of the grep family, including look, are used

Program	Unix Version 7	Xenix
simple text formatter	roff	
text typesetting	troff	troff*
text formatter	nroff	nroff*
typeset mathematics	eqn	eqn*
format mathematics	neqn	neqn*
format nroff/troff	tbl	tbl*
format references	refer	refer*
insert references		lookbib*
simulate typesetter	tc	tc*
greek letters print	greek	
reverse line feeds	col	col*
remove format constructs	deroff	deroff*
check eqn usage	checkeq	checkeq*
prepare for statistics		prep*
format output		sp*

*Available with the optional Radio Shack Development System.

Table 4: Unix and Xenix text utilities.

Program	Unix Version 7	Xenix	TRSDOS	CP/M
pattern processing	awk	awk		
append file to file	cat	cat	append	
catenate and print	cat	cat		type
compare two files	cmp	cmp*		
choose common lines	comm	comm*		
copy groups of files		copy	move	
copy	cp	cp	copy	pip
convert and copy a file	dd	dd		
differences in two files	diff	diff		
differences in three files		diff3*		
full expression search		egrep*		
string search		fgrep		
limited expression search	grep	grep		
print beginning of file		head*t		
relational database join	join	join*		
find lines in sorted list	look	look*		
browse file		more†		
print page headings	pr	pr		
reverse lines		rev*		
stream editor	sed	sed		
sort or merge files	sort	sort		
split file	split	split*		
checksum of file	sum	sum*		
print end of file	tail	tail		
translate characters	tr	tr*		
topological sort	tsort	tsort*		
duplicate lines	uniq	uniq*		
word count	wc	wc*		

*Available with the optional Radio Shack Development System.

†From the Berkeley implementation of Unix.

Table 5: File-processing capabilities of four operating systems.

up to
384k

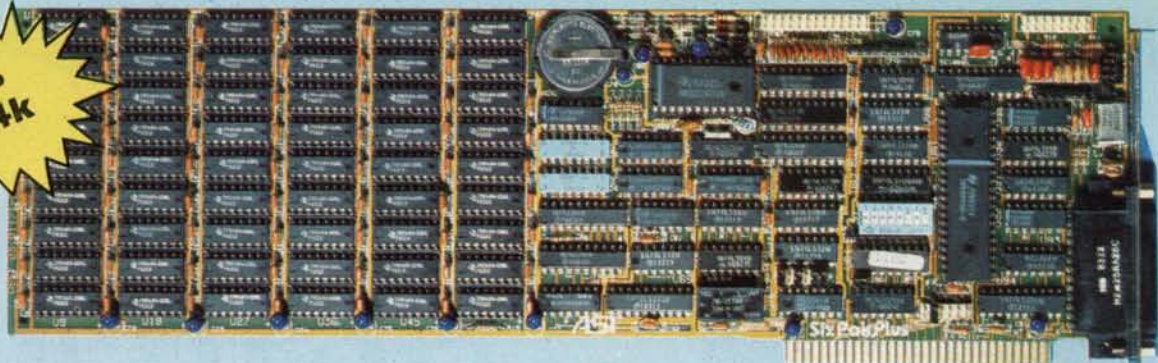

Thirsty for a 384k Multifunction Board? Try a SixPakPlus™

Since the introduction of DOS 2.0, the capabilities of the PC have been increased with the ability to address up to 640k of memory. With the current PC having 256k available on the computer motherboard, you need another 384k to reach 640k. Great you say, but multi-function boards only have room for 256k on them. Well look again, because now you can get the new SixPakPlus™ with up to 384k of memory, clock/calendar, asynchronous (RS232C serial) port, printer port, SuperDrive™ electronic disk emulation, and SuperSpooler™ printer spooling. There is even an optional game port. And if you already have enough memory for your present needs, you can still get on the bandwagon by buying it without any memory. When your needs for memory grow, the sockets are ready for you to install six banks of 64k parity checked memory.

With the SixPakPlus™ from AST Research you get the most advanced multifunction board available from the industry leader in IBM PC enhancements.

You get a clock/calendar powered by a clip-on battery which does not require factory service to replace. It automatically loads the correct time and date when you turn on your computer. The serial port can be configured as COM1 or COM2, and has jumpers for simplifying wiring of cables. The printer port uses all the same signals as IBM's — you can even use the IBM diagnostics on it. The optional game port uses any IBM compatible joystick.

The board is backed up with a one-year warranty on parts and labor and the Qubie™ satisfaction guarantee. If for any reason you are not satisfied with the performance of your board within 30 days of purchase, you may return it for a full refund, including the postage to return it. And if your board should need warranty service we do the repairs in 48 hours or we replace your board with a new one. That's the level of service that has made us the largest dealer in the world for AST Research products.

NOW
AVAILABLE
WITH
GAMEPAK™



MegaPlus II & I/O-Plus II The Ultimate Expansion for IBM PC or XT

The AST Research MegaPlus II™ has three functions standard. Parity checked and fully socketed memory up to 256k in 64k increments, clock/calendar with battery back-up for automatic loading of time and date when the computer is turned on, and asynchronous communication port (RS232C serial) which can be used as COM1 or COM2, (DTE for a printer, or DCE for a modem). Also included is SuperDrive™ "electronic disk" software. This program builds "disk drives" in memory which access your programs at the speed of RAM. You get SuperSpooler™, print spooling software. It operates your printer while you continue to work with your computer.

Options include a 100% IBM compatible parallel printer port (can be configured as LPT1, or LPT2), and a second RS232C asynchronous port (COM1 or COM2). Three MegaPak™ options can plug onto your MegaPlus II "piggyback" style to give you an additional 128k or 256k of memory, or a game port.

Circle 302 on inquiry card.

I/O-Plus II™, is the answer for those who don't need additional memory but would like all those other multi-function board features. The I/O-Plus II™ comes standard with a clip-on battery powered clock/calendar, an asynchronous communication port (RS232C serial), SuperDrive™ electronic disk, and SuperSpooler™ print spooling software.

Optional is a second asynchronous port (DTE, or DCE), a parallel printer adapter, and the best game paddle adapter on the market. It is an IBM standard game port, but it can also use Apple compatible paddles and joysticks. Options are all socketed so they may be added later should the need arise.

Both boards come with a one year factory warranty and the Qubie™ satisfaction guarantee. If for any reason you are not satisfied with the performance of your board within thirty days of purchase, you may return it for a full refund, including the postage to return it.

TO ORDER BY MAIL INCLUDE:

- complete description of products requested
- daytime phone number
- California residents add 6% sales tax
- check or credit card number with expiration date. (personal checks take 18 days to clear)



TO ORDER BY PHONE:

In California (805) 987-9741
Outside California TOLL FREE (800) 821-4479

PRICES:

I/O-Plus 2™ with Clock/calendar, serial (asynchronous) port, SuperDrive™ and SuperSpooler™ - \$119

MegaPlus II™ no memory, with clock, serial, and software - \$229

SixPakPlus™ no memory, with clock, serial port, printer port, and software - \$229

Each 64k of memory installed and tested on MegaPlus, SixPakPlus or alone \$55

Parallel Printer Port \$35

Second Asynchronous Port \$35

Game Adapter (I/O or SixPakPlus) \$35

MegaPak™ with 256k of Memory \$299

128k of Memory \$199

GamePak for MegaPlusII \$40

ConnectAll Cable Bracket \$19

Cable to Parallel Printer \$35

Cable to Modem or Serial Printer \$25

Diagnostics Program \$10

SUPERWRITER by Sorcim \$179

SUPERCALC by Sorcim \$159

dBASE II by Ashton-Tate \$409

Word Processing Keyboard \$229

Keyboard/Superwriter Package \$399

SHIPMENT

Normal shipment is day after receipt of order. We pay UPS surface charges on all items except keyboards. For keyboards add \$5 for surface, \$10 for 2 day air. All COD shipments add \$3 handling.

QUANTITY PURCHASES?

If your corporation, institution, or users group has needs for quantities of boards, call us for details on our quantity purchase program.

QUBIE'

4809 Calle Alto, Camarillo, CA 93010

Tempo House
15 Falcon Road, London, SW11, UK



CRAFTSMEN OF THE NEW TECHNOLOGY.
BEST PRICES WITH QUALITY SUPPORT* ON SOFTWARE & HARDWARE.

ORYX SYSTEMS

QUALITY DISCOUNTS

APPLE/ FRANKLIN

ASHTON-TATE	
d-Base II	\$ 399
ASPEN SOFTWARE	
Grammatik	\$ 60
Proofreader	42
BEAGLE BROS.	
Apple Mechanic	\$ 22
DOS Boss	17
Utility City	22
BRODERBUND	
Bank Street Writer	\$ 49
General Ledger w/AP	305
Payroll	275
CDEX	
Visicalc Training	\$ 45
CHARLES MANN	
Class Scheduling	\$ 299
CONTINENTAL SOFTWARE	
Home Accountant	\$ 49
DOW JONES	
Market Analyzer	\$ 245
Market Manager	219
Microscope	569
HOWARD SOFTWARE	
Tax Preparer	\$ Call
LINK SYSTEMS	
Datafax	\$ Call
Datalink	79

Complete Graphics/ Apple Tablet	86
SIERRA DESIGN	
Homeward	\$ Call
SOFTTECH	
Basic Compilers' Runtime	\$ 169
Softteach	94
UCSD P-system Set	469
SOFTWARE PUBLISHING	
PFS: File	\$ 79
PFS: Graph	79
PFS: Report	79
SUPERSOFT	
Basic Tutor	\$ 79
Fortran	299
SYSTEMS PLUS (Z80 req.)	
Landlord	\$ 375
VISICORP	
Visicalc (II or IIE)	\$ 179
Visischedule	225

CP/M SOFTWARE

COMPUVIEW	
*V-Edit 8080 Z80, IBM/PC	\$ 130
*V-Edit CP/M 86, MS DOS	160
DIGITAL RESEARCH	
*Pascal MT + W/SPP	\$ 389

LOGO CORNER

Krell Logo	\$ 75
------------------	-------

MICROPRO		MAC	85
Wordstar (Special) (w/CP/M Card, 7 col. & 64K)	\$ 375	ZSID (Z80) Debugger	90
Infostar (Includes CP/M, 70 col., 64K)	375	CP/M 2.2	180
Pro Pak (WS/MM/SS/Index)	425	C Basic 2	110
MICROSOFT		PL/1-80	375
Cobol-80	\$ 499	C Basic Compiler (CB-80)	299
Fortran-80	145	Access or Display Mgr. C Language/compiler	299
TASC Compiler	125	Concurrent CP/M 2.0	260
A.L.D.S.	95	All 8" - 86 Version of Above	225
Multiplan (DOS)	169		\$ Call
OMEGA		INFOCOM	
Locksmith	\$ 69	*Deadline	\$ 49
PEACHTREE (CP/M)		*Starcross	39
Peachpak 40 G/L + A/R + A/P (Special)	\$ 237	*Suspended	39
Series 40 G/L, A/R, A/P ea.	195	*Zork, I, II, III (each)	39
Series 9	279	Planet Fall	49
Peachcalc	279	LEXISOFT	
Telecommunications	279	*Spellbinder	\$ 239
PENGUIN SOFTWARE		MARK OF THE UNICORN	
Complete Graphics	\$ 53	*Final Word	\$ 209
Graphics Magician	45	MICROPRO	
		*WordStar	\$ Call
		*InfoStar	\$ Call
		*Pro-Pack (WS/MM/SS Index)	\$ Call
		All others	\$ Call

d-BASE II CORNER

Ashton-Tate	
d-Base II	\$ Call
Bottom Line Strategist	269
FPL	475
Friday	199
Human Soft	
d-Base Plus	\$ 89
Fox & Geller	
Quick Code	\$ 199
D Util	60
Software Banc	
d-Base II User's Guide: w/ d-Base II Purchase	\$ 15
w/o d-Base Purchase	20
Anderson-Bell	
Abstat	\$ 349
Tylog Systems	
d-Base Window	\$ 199

*All above available on PC-DOS

MICROSOFT

Basic 80	\$ 239
Basic Compiler	249
Fortran 80	330
Cobol 80	449
Macro 80	130
MuMath/MuSimp	185
MuLisp/MuStar	142
*Multiplan	175

PICKLES & TROUT

CP/M for TRS-II	\$ 180
-----------------------	--------

PRO/TEM SOFTWARE

*Footnote	\$ 105
-----------------	--------

REVASCO

Z80 Disassembler	\$ 85
------------------------	-------

SORCIM

*Supercalc III	\$ Call
Superwriter (w/Speller & Mailer)	\$ 179



PEACHTREE CORNER

* PeachPak 4 (GL, AP, AR)	\$ 237
* General Ledger / Accounts Payable / Accounts Receivable / Sales Invoicing / Inventory Control / PeachPay Payroll	Each 399
* PeachText	160
* PeachText w/ Random House Thesaurus	195
* Spelling Proofreader	95
* PeachCalc	90
* Job Cost System	399
* Client Posting & Accounting	399
* Graphics Language	275
* Business Graphic System	199

MICROSTUF

* Crosstalk	\$ 115
-------------------	--------

NORTHWEST ANALYTICAL

* Statpak	\$ 365
-----------------	--------

OASIS

The Word Plus	\$ 120
Punctuation and Style	99

ORGANIC SOFTWARE

* Datebook	\$ 229
* Milestone	229

SELECT

Select Word Processor	\$ 356
--------------------------------	--------

STAR SOFTWARE SYSTEMS

* Legal Time, Billing	845
* Property Mgmt.	845
* Acc'l Partner	299

SUPERSOFT

* Diagnostic II	\$ 89
Disk Doctor	74

Formats Available*

All prices below are for 8" standard. Other formats are available. Some formats subject to "Download" fee and require minimum 2 weeks for delivery. Please inquire.

*Fortran 4	299
Basic-8086	225
C Cross Assembler	400
*ScratchPad	199
T MAKER III	220

IBM/PC

Please see CP/M listing. All products with a * in front are also made for PC/DOS and are priced the same unless otherwise specified.

ALPHA SOFTWARE

Data Base Mgr. II	\$ 195
Mailing List	72
Executive Pkg.	105
Type Faces	87
Question	35
Apple-IBM Connection	130

CENTRAL POINT

Copy II PC	\$ 36
------------------	-------

CONDOR III

w/Training	\$ 445
------------------	--------

CONTINENTAL

Home Accountant	\$ 95
-----------------------	-------

DIGITAL RESEARCH

Concurrent CP/M 86	\$ 225
CP/M-86	40
Cobol 86	499
Pascal MT + 86 (MS DOS)	375
SPP 86	130
SID 86	113
C Basic 86	135
Pascal PC/DOS	385
DR Logo	109

DOW JONES

Market Analyzer	\$ 245
Market Manager	219

ECO-SOFT

Microstat	\$ 230
-----------------	--------

FINANCIER

Tax Series	105
Personal	\$ 119

GRAPHIC SOFTWARE

Super Chartman II	\$ 299
Super Chartman IV	199
Both (above)	350

LEXISOFT

SpellBinder	\$ 259
-------------------	--------

LIFETREE

Volkswriter	\$ 135
-------------------	--------

LOTUS 123

.....	\$ Call
-------	---------

PEACHTREE

Please see listing under CP/M. PeachText 5000	\$ 237
---	--------

SUPERSOFT	
C Compiler - 8086	\$ 350
Star Edit	180
Disk Edit	75
Basic Compiler	225
Fortran IV PC/DOS	
or 8086	299
8087 Support	40
Diagnostics II	89
Scratch Pad	199

SYSTEMS PLUS	
Landlord (prop mgmt) \$	375
Runtime Basic	
(req'd for above)	45

... and many more!

APPLE/ FRANKLIN BOARDS

ALS CP/M Card	\$ 299
ALS Smarterm	249
ALS Z-Card II	142
ABT Keyboard	99
Axlion Ramdisk 128K	299
Bit 3 Dual Comm-plus	209
CCS 7710 Asynch Serial	119
Central Point Alaska	119
East Side Wild Card	110
Microsoft 16K Ramcard	69
Microsoft Softcard	235
Microsoft Softcard +	429
Microsoft Premium	
Softcard (IIE)	395
Microtek Printer I/F	75
Microtek Dumping-16	195
Microtek Dumping-GX	119
Mourtain A-D/D-A	279
Mountain Music	
System w/Software	299
PCP 4 MHz Appli-	
Card + 88 Card	599
PCP 88 Card 16 Bit	
+ 64K	475
Prometheus Versacard	159
Prometheus Graphitti	
Card	99
SSM ASIO Serial I/F	
w/cable	129
SSM AIO-2 Serial/	
Parallel	179
Street Echo II Speech	
Synthesizer I/F	129
Tymac Parallel I/F	
w/cable	79
Videx Display	
Enhancer	99
Videx Display	
Enhancer II	99
Videx Func. Strip	59
Videx Videoterm	
VT-600	235
Videx Ultraterm	299
Wesper 16K Ram Card	69

IBM/PC BOARDS

AST RESEARCH	
ComboPlus 64K Clock/	
Calendar, Serial &	
Parallel, I/F, Expand-	
able to 256K	\$ 279
MegaPlus 64K, Clock/	
Calendar, Serial Port,	
Expandable to 512K	
w/Megapak	269

Extra ports available	
for Megaplus and I/O	
Plus II includes Game,	
Parallel & Serial	40
Megapak 256K upgrade	
for Megaplus	\$ Call
I/O Plus II Clock/Calen-	
dar and Serial Port	115
LNW Products	\$ Call

MAYNARD ELECTRONICS	
Floppy Drive	
Controller	\$ 155
Floppy Drive Control-	
ler w/Parallel Port	209
w/Serial Port	249
Sandstar Mem. Card	
- 3 modules cap.	194
Sandstar Multifunction	
Card - 6 modules cap.	93
Sandstar Modules	\$ Call

QUADRAM	
Quadboard 64K, Clock/	
Calendar, Serial &	
Parallel Ports,	
Software	\$ 279

Microfazer Stack Printer	
Buffer (expandable to 512K)	
► Parallel/Parallel 8K	145
► Parallel/Parallel 64K	188
► Serial/Parallel 8K	170
► Serial/Serial 8K	170
Quadlink 64K Memory,	
Game Port allows	
Apple Software to	
to an IBM/PC	\$ Call

TECMAR Products	\$ Call
XEDEX/MICROLOG	
Baby Blue	\$ 475

TALL TREE	
512K JRAM Mem.	
Board	\$ 699

DISPLAY CARD CORNER

Hercules Graphics Board	\$ 369
Orchid Monochrome Graphic Adapter	360
Plantronics Colorplus	389
USI Display Card (color/monochrome)	\$ Call
Amdex MAI Card	\$ Call
Tecmar Graphic Master	\$ Call

MONITORS

Amdex Video 300A	
Amber	\$ 159
Amdex RGB	425
NEC 12" Hi-Res Green	187
Sanjo 12" Hi-Res	
Green	199
USI Hi-Res 12" Amber	160
NEC JB-1260 Green	119
PGS RGB Color	\$ Call
NEC JC-1203 RGB	560

Panasonic	
Monitors	\$ Call
Quadram	
Quadchrome	\$ Call
Taxan 12" Amber	139
Taxan 12" Green	132
Taxan 12" Med. RGB	323
Taxan 12" High RGB	512
Taxan RGB	
Cable for PC	17
Sony Profeel	
12/19/25"	\$ Call

TELECOMMUNICATIONS CORNER

*** SPECIAL ***

Hayes Smartmodem 12000/Hayes Smartcom II Software	
AST I/O Plus II Clock Calendar and Serial Port	\$ 689
Above w/Smartmodem 300	399
Hayes Smartmodem 1200 & Smartcom II Software	575

MODEMS

Novation	
Apple-Cat II	\$ 269
Hayes Micromodem II	259
Anchor Mark I	84
Anchor Mark VII	129
Hayes	
Smartmodem 300	\$ 205
Hayes	
Smartmodem 1200	495
Hayes Chronograph	189
Novation 212	
Auto-Cat	579
US Robotics Auto-	
Dial (full auto	
answer 300/1200)	459
US Robotics Auto-	
Link (auto answer	
300/1200)	379
US Robotics Password	
300/1200	395

DISK DRIVES

Teac Half-Hgt	\$ 259
Superfave Half-Hgt	
(App)	9
Panasonic Half-Hgt	
Tandon TM-55-2	\$ 275
Tandon TM-100-2	239
Davong DSI-501 Hard \$	Call
Davong DSI-512 Hard \$	Call
Davong DSI-519 Hard \$	Call
Corona 5 MB Hard	1,395
Corona 10 MB Hard	1,795
CDC 1800	270
Corvus	\$ Call
Tall Grass	\$ Call
Vista Solo 143K	\$ 259
Vista Solo & Controller	329

PRINTERS

C. Itoh Startwriter F10	\$ 1,149
C. Itoh Prowriter 8510	379

DISKETTES

3M 5" DS, DD, Box	\$
BASF 5" DS, DD, Box	\$
Maxell 5" DS, DD,	
MD2, Box	
Verbatim 5"	
DS, DD, Box	
Ultra Magnetics 5"	
DS, DD, Bonus Box	
(12 Diskettes)	\$

PLOTTERS

Enter P100 Sweet P	
Apple/Franklin,	
IBM/PC	\$ 59
Strobe M100 Plotter	
w/ I/F Apple/Franklin	
Strobe M100 Plotter	
(RS 232)	\$ 53
Panasonic Digital	
Plotter	\$ Ca

MISC.

Chalk Board	\$ Ca
Kaala Technologies	
Graphic Tablet	\$ 9
Symtec Light Pen	
IBM/PC	14
Symtec Light Pen	
Apple/Franklin	20
TG Joystick IBM/PC	
4	6
TG Joystick	
Apple/Franklin	4
Versa VersaWriter	
Tablet IBM/PC,	
Apple/Franklin	23
Wico Analog Joystick	
5	5
Wico Apple Adapter	
1	1
Wico IBM/PC I/F Card	
5	5
Keytronic Keyboard	
IBM/PC	20
Keytronic Keyboard	
Apple/Franklin	24
Curtis PC Products	
\$	\$ Ca
Electronic Protection	
Series	\$ Ca

CP/M is a registered trademark of Digital Research. IBM and the IBM logo are registered trademarks of International Business Machines. Apple and the Apple logo are registered trademarks of the Apple Computer Company. Franklin and the Franklin logo are trademarks of the Franklin Computer Company.

Please:

- Wisconsin residents add 5% for sales tax.
- Add \$3.50 for shipping per software and light items. For multiple and other items, call.
- Foreign — add 15% handling & shipping for prepayment. (Int'l money order.)
- Prices are subject to change without notice.
- All items subject to availability.

Store prices are strictly retail.

ORYX SYSTEMS, INC.

425 First St. • P.O. Box 1961
Wausau, WI 54401

For technical information and
in Wisconsin: 715-848-1374

Int'l Telex: 260181
ORYX SYS WAU

We welcome:

- COD (Add \$2.00 per shipment. Cash or certified check required.)
- Visa, MasterCard & American Express. (Add 4%.)
- Checks. (Allow 1-2 weeks for clearing.)

Working Hours:

Mon. - Thurs. 8:30 - 5:30 • Fri. 8:30 - 6:30
Sat. 10:00 - 2:00 • Central Time

ORDER TOLL FREE OUTSIDE WISCONSIN 1-800-826-1589



Program	Unix Version 7	Xenix	TRSDOS	CP/M
repeat last command		!(csh)	again	
execute command at time	at	at*		
execute on log-in	.profile	.profile	auto	
create shell script	ed	ed	build	ed
schedule programs	cron	cron		
shell with C-like syntax		csh†		
echo arguments	echo	echo		
evaluate expression	expr	expr		
return false		false		
fix last command line			fc	
get string from input		gets*		
signal process	kill	kill		
run command with priority	nice	nice*		
run immune to hangups	nohup	nohup*		
return a random number		random*		
read line from terminal	read	read		
execute a shell script	sh	sh	do	submit
suspend for interval	sleep	sleep		
return true		true		
duplicate output	tee	tee*	dual	
condition command	test	test		
shell with TRSDOS syntax		tsh		
wait for completion	wait	wait		
output unit end of pipe		yes		

*Available with the optional Radio Shack Development System.

†From the Berkeley implementation of Unix.

Table 6: Program-control interface facilities available on four operating systems.

search files for patterns or words, and `cmp`, `diff`, and `diff3` are file-content comparison programs.

Xenix Shells

The program control interface for Unix systems is implemented by a shell program. This shell is the outermost skin of the operating system onion. Xenix has three shells available. You are assigned a shell when your user account is created on the system. Changing shells is a simple matter. It is possible, but not easy, to write a whole new shell and use it instead of one of the shells provided. An easier matter is to write "shell scripts" within either the standard Bourne shell or the Berkeley C-shell. Shell scripts can help make user environments that are much easier for unsophisticated users than the standard environments. Menu interfaces, for example, can be implemented without excessive difficulty. Radio Shack has also provided `tsh`, which implements an emulation of the TRSDOS environment and its commands (such as `dir`) for users familiar with that interface and unwilling to tackle the standard Unix fare. Table 6 is a comparison of the program-control interface facilities available on Unix, Xenix, TRSDOS, and CP/M.

Communication

Unix has supported intersystems communication for some time and as a standard part of the system. Xenix has expanded the complement of communications pro-

Program	Unix Version 7	Xenix	TRSDOS
reminder service	calendar	calendar*	
call up Xenix (terminal emulation)	cu	cu*	terminal
send or receive mail	mail	mail*	
permit or deny messages	mesg	mesg*	
write to user	write	write*	
Unix-to-Unix copy (file transfer)	uucp	uucp*	host
uucp log summary		uulog*	
Unix-to-Unix execution		uux*	
write to all users	wall	wall	

*Available with the optional Radio Shack Development System.

Table 7: Communication utilities. Note that Unix supports both communications among users on one system and communications among separate systems.

grams available. Of particular note is `uux`, a program that lets you specify separate systems for program input, execution, and output. Naturally, these systems must be linked by auto-dial modems or by a local-area network. Table 7 is a comparison of utilities available within Unix version 7, Xenix, and TRSDOS.

File-Access Control

Unix files have sophisticated access controls. Each named file has an owner who, in turn, belongs to a group. The file has a set of access permissions and is marked with the date created and the date last modified.

Changing shells is a simple matter: it is possible to write a whole new shell and use it instead of one of the shells provided.

The utilities `mv` (move a file—the same as renaming it), `chown` (change owner), `chmod` (change mode—the same as changing access attributes), `chgrp` (change file group), `settime`, and `touch` are all used to change these access attributes. A directory is a special file that has special attributes and that contains references to other files. Thus, several of the listings in table 8 are directory-control functions. The utility `ln` (link) allows a file to appear in more than one directory under different names. Table 8 presents a comparison of Unix, Xenix, TRSDOS, and CP/M on file-access control.

Terminal Handling

Unix provides an easy method for handling nearly any terminal in a way that is (usually) transparent to users and their application programs. Settings include speed (data rate), parity, echo (i.e., full or half duplex), the characters to use for backspace and kill, and the end-of-file characters. The Berkeley enhancement `tset` uses the terminal-capabilities database `/etc/termcap` to set terminal modes. Note that in Xenix, it is impossible to set terminal



The best career move you can make is to the keyboard of your personal computer.

It's free. It's confidential.

Today's technical career market changes fast.

But now there's a way to keep up with it. This new key to career opportunity is your personal computer. And the cost is nothing but a phone call.

Just call CLEO. That stands for Computer Listings of Employment Opportunities.

CLEO responds to your commands. You specify what job categories, companies, or geographic locations interest you. CLEO calls up the appropriate ads right on your screen. At every step, you're guided by explicit online instructions.

Daily updates keep CLEO job listings current. You can even apply for positions right from your

own terminal. For a detailed job search, or just an idea of what's available, CLEO is waiting for your call today. With today's opportunities.

CLEO access: (415) 482-1550 • (408) 294-2000 • (213) 618-8800 • (714) 476-8800 • (619) 224-8800
300 BAUD, full duplex, standard ASCII code.
Access assistance: (213) 618-1525

CLEO

Computer Listings of Employment Opportunities

Recruitment advertisers—call (213) 618-0200 collect to find out how you can place your ad on CLEO.

An electronic publishing activity of The Copley Press, Inc.

Program	Unix			
	Version 7	Xenix	TRSDOS	CP/M
change working directory	cd	cd		
change file group	chgrp	chgrp		
change file owner	chown	chown		
change file mode	chmod	chmod	atrib	stat
find files	find	find*		
make a link	ln	ln		
make a directory	mkdir	mkdir		
move files, directories	mv	mv	rename	ren
remove files	rm	rm	kill,purge	era
remove directories	rmdir	rmdir		
change file dates		settime*		
change modified date		touch*		

*Available with the optional Radio Shack Development System.

Table 8: File-access control functions of four operating systems.

Program	Unix			TRSDOS
	Version 7	Xenix		
set key click				click
clear screen				cls
set terminal options	stty	stty		setcom
set terminal tabs	tabs	tabs*		
set terminal modes		tset†		

*Available with the optional Radio Shack Development System.

†From the Berkeley implementation of Unix.

Table 9: Terminal commands.

Program	Unix			
	Version 7	Xenix	TRSDOS	CP/M
line editor	ed	ed		ed
encode/decode	crypt	crypt*		
permuted index	ptx	ptx*		
find spelling errors	spell	spell*		
non-English spelling	typo			
screen editor		vi*†		

*Available with the optional Radio Shack Development System.

†From the Berkeley implementation of Unix.

Table 10: Text-manipulation facilities of four operating systems.

Program	Unix			CP/M
	Version 7	Xenix		
sign on	login	login		
log in to a new group	newgrp	newgrp		
change log-in password	passwd	passwd		user

Table 11: Access-protection facilities.

tab stops unless you purchase the optional Development System. See table 9 for terminal commands.

Much program development time is spent in an editor. A good editor makes program development much easier and much less error-prone. Note, however, that an editor is not a word processor. The vi editor is a very powerful screen-oriented editor that comes from the Berkeley Computer Science Labs. It relies on the termcap file to tell it how to make magic things happen, even with comparatively dumb terminals. This editor takes considerable effort to learn, but once you know it well, it allows very fast text manipulation. Table 10 compares editing text-manipulation facilities on four operating systems.

System Access

Unix was conceived as a timesharing system. Accordingly, the access-protection facilities on Unix and Xenix are far better developed than on either of the single-user operating systems shown in table 11. Users have a password that may be changed by use of the passwd command. Files are protected by user (the file owner) and by group. A user may belong to more than one group. As a safety measure, on some systems repeated unsuccessful attempts to log into a Unix system may trigger a software disable of the terminal port being accessed.

Unix has for some time had standard support for limited line and curve drawing on a number of different graphic devices. Although not very comprehensive and not nearly as user-friendly as some current commercial packages, simple graphics can be done on a basic Unix or Xenix system. Table 12 shows the three routines generally available (in the Development System for Xenix).

Unix/Xenix has a general-purpose printer spooler that works on whatever has been set up as the system's printer. In contrast, TRSDOS has several explicit and useful individual commands. These are shown in table 13.

Program	Unix	
	Version 7	Xenix
draw a graph	graph	graph*
interpolate smooth curve	spline	spline*
graphics filters	plot	plot*

*Available with the optional Radio Shack Development System.

Table 12: Unix and Xenix graphics routines.

Program	Unix			TRSDOS
	Version 7	Xenix		
line-printer spooler	lpr	lpr		print
print current screen				screen
controls spooler				spool
set to top of form				t

Table 13: Printer-handling commands.

Calculator Decision-Making Sourcebook

Whether your field or profession, your calculator can help you use the power of statistics and mathematics in making better decisions. Easy programmability gives you fast answers to repetitive problems.

SECOND EDITION
revised and expanded
\$6.95

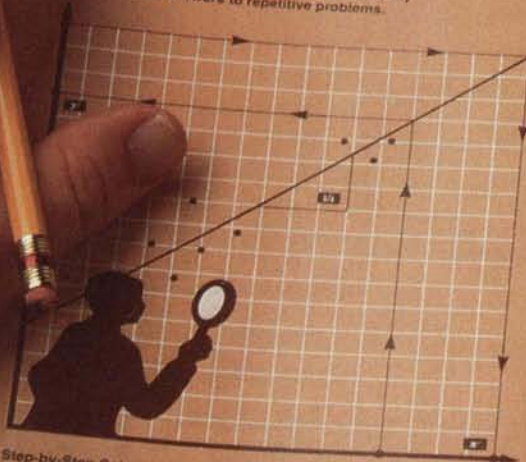

- Step-by-Step Solutions:
- Unit Conversions
 - Mathematics with Integral Evaluation
 - Forecasting Trends
 - Analyzing Relationships in Data
 - Verifying Quality & Performance
 - Scientific Applications

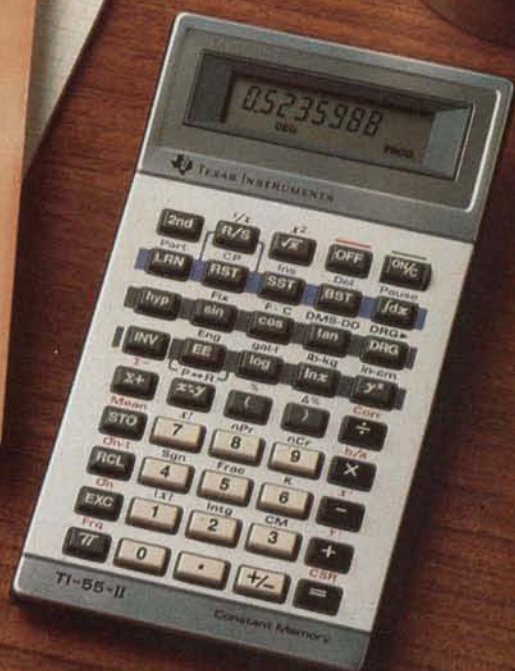

How the TI-55-II makes short work of long problems.

Whenever you can solve complex problems quickly and accurately, you're ahead of the game. And that's exactly what the TI-55-II does for you. By giving you 112 pre-programmed functions (like definite integrals), it allows you to take short cuts without losing accuracy. You'll accomplish a lot more in less time which means increased efficiency.

With our TI-55-II you can tackle problems you thought could only be solved with higher-priced programmables. You're not only getting the standard slide rule functions but also statistical

capabilities. This way you can work out linear regressions, permutations and combinations, just to name a few.

The TI-55-II also gives you enough programmability to eliminate a lot of repetitive key punching. Our Constant Memory™ keeps programs and data on tap, even when the calculator is turned off. So once you've entered a formula, you can simply put in the variables to get your solution. The Liquid Crystal Display shows your answers in standard, scientific or engineering notations — clearly and precisely.

We also help you get the most

out of your calculator with the Calculator Decision-Making Sourcebook. It gives you step-by-step examples of the best techniques used for solving mathematical, scientific and statistical problems. And we've included a special section on how to program your TI-55-II.

So next time you're facing another time-consuming problem, cut it down to size with the TI-55-II.

**TEXAS
INSTRUMENTS**
Creating useful products
and services for you.

Program	Unix Version 7	Xenix	TRSDOS
print calendar	cal	cal*	
CAI	learn	learn*	
system manual	man	man*	help
conversion program	units	units*	

*Available with the optional Radio Shack Development System.

Table 14: Miscellaneous software features of Unix version 7, Xenix, and TRSDOS.

Program	Unix Version 7	Xenix	TRSDOS	CP/M
current date and time	date	date	date, time	
disk free space	df	df	free	stat
disk usage summary	du	du		
determine file type	file	file*		
information on user		finger*†		
input/output statistics	iostat			
directory contents		l	dir	dir, stat
directory by column		lc†	files	
directory contents	ls	ls		
file system ownership	quot	quot		
print out environment		printenv*†		
process status	ps	ps		
system statistics		pstat*	status	
working directory name	pwd	pwd		
terminal name	tty	tty		
logged-in users	who	who		

*Available with the optional Radio Shack Development System.

†From the Berkeley implementation of Unix.

Table 15: Status utilities of four operating systems.

		Real User System		
compile sieve	cc -O sieve.c -o sieve	33.0	5.4	5.9
execute sieve	sieve	10.0	9.0	0.2
simultaneous sieves	sieve&sieve&sieve&time sieve	38.0	9.0	0.2
compile terminal	cc -O terminal.c -o terminal	34.0	6.8	6.5
one terminal	terminal 1	16.0	0.4	7.5
two terminals	terminal 2	31.0	1.2	13.5
three terminals	terminal 3	46.0	1.9	19.7
compile disk	cc -O disk.c -o disk	36.0	6.4	6.4
one file	disk 1	5.0	2.0	0.5
two files	disk 2	8.0	3.7	1.2
four files	disk 4	13.0	7.5	2.1
eight files	disk 8	32.0	15.4	4.0
simultaneous sorts	sort f1>f1s&sort f2>f2s&sort f3>f3s&time sort f4>f4s	63.0	6.7	2.8
multifile sort	sort f1 f2 f3 f4 > sorted.file	97.0	37.9	12.8

Table 16: Model 16B benchmark results. Entries in the Real column represent total elapsed time; entries in the User column represent time in the user process; and entries in the System column represent kernel time. Times are given in seconds.

Miscellaneous Features

Because Unix is a fairly mature system, a lot of software has been written for it that is generally useful but hard to classify. Among the nice things available are those shown in table 14. The on-line system manual is handy for those who need access to specific manual pages fairly quickly. Note, however, that you need to know the name of the function you want to read about—you can't say, "Tell me about the utility that changes ownership of a file." The on-line computer-aided instruction (CAI) on Unix is nice, but using it tends to be a bit tedious. The conversion program for units is useful for those of us who have trouble converting from one measurement system to another in our heads.

Informal comparisons on other systems have shown the Model 16B to be about what you'd expect of a 6-MHz M68000-based machine running Unix and using the C language.

Unix and Xenix provide a number of valuable utility programs that inform you about system status and certain other data. Table 15 compares the facilities in Unix version 7, Xenix, TRSDOS, and CP/M in these areas. The `finger` utility from Berkeley retrieves information from your password file in a more readable format than contained in the file itself. You can list the status of processes running on the system with `ps`. This utility is useful in general but is especially useful to the system manager. Used in combination with the `kill` command, the `ps` utility allows the manager to free hung terminals or terminate runaway processes and unwanted processes. (Some microcomputer manufacturers don't make this feature available to their customers, claiming that their system software security scheme could be broken if it were available. However, this feature is an essential part of any Unix-style system and we applaud Microsoft and Radio Shack for making it available.) A System III utility called `pstat` prints out the kernel tables, which are loaded with useful information, if you know what you are doing.

TRS-80 Model 16B Performance

We subjected the Radio Shack TRS-80 Model 16B to an extensive list of performance tests. One of these tests was a compute-bound microprocessor speed test (the Sieve of Eratosthenes, used by Jim and Gary Gilbreath in "Eratosthenes Revisited: Once More through the Sieve," January 1983 BYTE, page 283), and others were designed by us for this article. We have done some informal comparisons on other systems available to us and have found the Model 16B to be about what you would expect of a 6-MHz M68000-based machine running Unix and using the C language. The Model 16B we tested had

THE BEST KEPT SECRET IS OUT.....

JUKI LETTER QUALITY, DAISY WHEEL PRINTERS ARE NOW AVAILABLE NATIONWIDE AT \$699⁰⁰



There's no mystery about it! Juki's Model 6100 bi-directional, daisy wheel printers are full featured and priced right!

Designed to perform word processing and graphic functions including bold face, subscript, superscript and shadow, the Model 6100 prints at 18 cps, has a proportional spacing control and utilizes 100 character drop-in daisy wheels. The Juki printer uses IBM Selectric Ribbons and is compatible to IBM, Apple, Osborne, Kaypro and most other personal computers. But that's no secret!

The news is that the Juki Model 6100 printers are now available through a reliable network of industry professionals strategically located throughout the country to give you the prompt, dependable sales and technical service you need. And Juki distributors are backed by a company who has been specializing in electronics for over 25 years.

So, contact the Juki distributor nearest you for the real undercover story on the best letter quality, daisy wheel printer around.



CONTACT YOUR JUKI DISTRIBUTOR FOR THE DEALER LOCATION MOST CONVENIENT FOR YOU.

ACORN DATA PRODUCTS
7304-L South Alton Way
Englewood, CO 80112
303/779-6644
Serving:
MT, WY, CO, UT, NM

BUTLER ASSOCIATES, INC.
82A Winchester Street
Newton, MA 02161
617/964-5270
Serving:
ME, NH, VT, CT, RI, MA

COMPUTER SERVICES
INTERNATIONAL CORP.
905 Boulevard East
Weehawken, NJ 07087
201/866-2880
Serving: METRO NY, E. PA, NJ

GENTRY ASSOCIATES, INC.
7665 Currency Drive
Orlando, FL 32809
305/859-7450
Serving:
TN, NC, SC, MS, LA, AL, GA, FL

INFORMATION SYSTEMS, INC.
2420 E. Dakton Street, Unit K
Arlington Heights, IL 60005
312/228-5480
Serving:
WI, IL, MN, IA, MO, NE, ND, KS, SD

INTERNATIONAL BUSINESS
SYSTEMS CENTER
7023 Little River Turnpike
Annandale, VA 22003
703/750-3882
Serving: MD, DE, DC, VA

OSSMANN COMPUTER
TECHNOLOGIES, INC.
6666 Old Collamer Road
E. Syracuse, NY 13057
315/437-6666
Serving: UPSTATE NY

SIGMA DISTRIBUTING
2110 116th Ave. N.E.
Bellevue, WA 98005
206/454-6307
Serving:
WA, OR, ID, AK

SOUTHERN MICRO
DISTRIBUTORS
8708 Royal Lane
Irving, TX 75063
214/258-6636
Serving: TX, OK, AR, LA

STAR-TRONIC
DISTRIBUTOR CO.
23976 Freeway Park Drive
Farmington Hills, MI 48024
313/477-7586
Serving: MI, IN, OH, KY, PA, W. PA, WV

TECHNOLOGY MARKETING CORP.
2300 Valley View Lane
Suite 109
Dallas, TX 75234
214/243-7994
Serving: TX, OK, AR, LA

VITEK
930 G Boardwalk Avenue
San Marcos, CA 92069
619/744-8305
Serving:
S. CA

WESTERN MICRO
TECHNOLOGY
10040 Bubb Road
Cupertino, CA 95014
408/725-1660
Serving: N. CA, NV, AZ

NATIONAL HEADQUARTERS
JUKI INDUSTRIES OF AMERICA, INC.
DA DIVISION
299 Market Street
Saddle Brook, NJ 07662
201/368-3666

WEST COAST
JUKI INDUSTRIES OF AMERICA, INC.
CALIFORNIA DIVISION
20437 South Western Avenue
Torrance, CA 90501
213/320-9001

512K bytes of memory and the 12-megabyte hard disk. Terminal I/O was, according to Radio Shack literature, done by the second processor in the system, a 4-MHz Zilog Z80. The kernel seems to be particularly slow, especially as it attends to terminal I/O. In contrast, the kernel is rather efficient on disk I/O, but the overall system is hampered by slow hardware. Note, however, that long average disk-access times are a consequence of efforts to keep the system price down—you have to pay for the speed you get. Performance times were col-

lected by executing the test using the Unix time command. This command monitors the time it takes to execute a process. Tabel 16 shows the results of the benchmarks in seconds. Total elapsed time ("Real"), time in the user process ("User"), and kernel time ("System") are reported individually. The Sieve program is shown in listing 1. The disk and terminal programs are shown in listings 2 and 3, respectively. The disk program is designed to provide a disk-intensive I/O load while the terminal program is designed to provide a serial-port I/O

Text continued on page 311

Listing 1: The Sieve of Eratosthenes program used as a compute-bound microprocessor speed test on the Model 16B.

```
#define TRUE      1
#define FALSE    0
#define SIZE     8190

char flags [SIZE + 1];

main ()
{
    int     count;
    int     i;
    int     iter;
    int     k;
    int     prime;

    printf ("10 iterations\n");
    for (iter = 1; iter <= 10; iter++)
    {
        count = 0;
        for (i = 0; i <= SIZE; i++)
            flags [i] = TRUE;
        for (i = 0; i <= SIZE; i++)
            if (flags [i])
            {
                prime = i + i + 3;
                for (k = i + prime; k <= SIZE; k += prime)
                    flags [k] = FALSE;
                count++;
            }
    }
    printf ("%d primes.\n", count);
}
```

Listing 2: The disk benchmark program.

```
#include <stdio.h>

FILE     *fp [8];
char     *file [] =
{
    "f1",
    "f2",
    "f3",
    "f4",
    "f5",

```

Listing 2 continued on page 315

SuperSoft FORTRAN

For CP/M-86®, MS DOS, IBM PC DOS®, and CP/M-80®

SuperSoft FORTRAN is the answer to the growing need for a high quality FORTRAN compiler running under CP/M-86 and IBM PC DOS. It has major advantages over other FORTRAN compilers for the 8086. For example, consider the benchmark program used to test the IBM FORTRAN in *InfoWorld*, p. 44, Oct. 25, 1982. (While the differential listed will not be the same for all benchmark programs, we feel it is a good indication of the quality of our compiler.) Results are as follows:

IBM FORTRAN:	38.0 Seconds
SuperSoft FORTRAN:	2.8 Seconds

In its first release SuperSoft FORTRAN offers the following outstanding features:

1. Full ANSI 66 standard FORTRAN with important extensions
2. Standard data types, double precision, varying string length, complex numbers
3. Free format input and free format string output
4. Compact object code and run time support
5. Special functions include string functions, dynamic allocation, time/date, and video access
6. Debug support: subscript checking, good runtime messages
7. Full IEEE floating point
8. Full 8087 support-available as option (\$50.00).

Program developers:

SuperSoft's family of FORTRAN compilers means you can write your programs once and they will run under CP/M-80, CP/M-86, and MS DOS. This lets you get your applications running fast no matter what the environment.

The current compiler allows 64K code space and 64K data space with expansion anticipated in future releases.

Circle 342 on inquiry card.



"At last, a FORTRAN compiler that works great on my 8086, 8087, and 8088 and Z-80 based systems!"

SuperSoft FORTRAN: available NOW and working great!

Requires: 128K with CP/M-86 or MS DOS,
32K with CP/M-80

Price: \$425 (in each environment)

In conjunction with SuperSoft, SuperSoft FORTRAN was developed by Small Systems Services, Urbana, IL, a leader in FORTRAN development.

CP/M-80 and CP/M-86 are registered trademarks of Digital Research. IBM PC is a registered trademark of International Business Machines Corp.

Japanese Distributor:

ASR Corporation International, TBL Building, 7th Floor,
1-19-9 Toranomon, Minato-Ku, Tokyo 105, Japan.
Tel. (03)-5025550, Telex: 222-5650 ASRTYO J.

European Distributor:

SuperSoft International Ltd., 51 The Pantiles,
Tunbridge Wells, Kent, England TN2 5TE.
Tel. 0892-45433. Telex: 95441 Micro-G.

SuperSoft®

FIRST IN SOFTWARE TECHNOLOGY

P.O. Box 1628 Champaign, IL 61820 (217) 359-2112 Telex 270365

```

        "f6",
        "f7",
        "f8"
};

main (argc, argv)
int   argc;
char  *argv [];
{
    int   num;
    int   x;
    int   y;

    num = *argv [1] - '0';
    for (x = 0; x < num; x++)
        fp [x] = fopen (file [x], "w");
    for (y = 500; y > 0; y--)
        for (x = 0; x < num; x++)
            fprintf (fp [x], "%50d\n", y);
    for (x = 0; x < num; x++)
        fclose (fp [x]);
}

```

Listing 3: The terminal benchmark program.

```

#include <stdio.h>

FILE  *fp [8];
char  *dev [] =
{
    "/dev/console",
    "/dev/tty01",
    "/dev/tty02",
    "/dev/tty03",
    "/dev/tty04",
    "/dev/tty05",
    "/dev/tty06",
    "/dev/tty07"
};

main (argc, argv)
int   argc;
char  *argv [];
{
    int   num;
    int   x;
    int   y;

    num = *argv [1] - '0';
    for (x = 0; x < num; x++)
        fp [x] = fopen (dev [x], "w");
    for (y = 0; y < 500; y++)
        for (x = 0; x < num; x++)
            fputs ("how fast are your terminals\n", fp [x]);
    for (x = 0; x < num; x++)
        fclose (fp [x]);
}

```

SuperSoft BASIC Compiler

for CP/M-86[®], MS DOS, and PC DOS

Compatible with Microsoft BASIC

The SuperSoft BASIC compiler, available under CP/M-86 and MS DOS, is compatible with Microsoft* BASIC and follows the ANSI standard. If you want to compile BASIC programs under CP/M-86, PC DOS, and MS DOS, SuperSoft's BASIC compiler is the answer.

Greater accuracy with BCD math routines

If you have used other languages without BCD math, you know how disconcerting decimal round off errors can be. For example:

**With IBM PC*
BASIC**

```
10 A=.99
20 PRINT A
30 END
```

Output: .9899999

**With SuperSoft
BASIC with
BCD math**

```
10 A=.99
20 PRINT A
30 END
```

Output: .99

As you can see, SuperSoft BASIC with BCD provides greater assurance in applications where accuracy is critical.

SuperSoft's BASIC is a true native code compiler, not an intermediate code interpreter. It is a superset of standard BASIC, supporting numerous extensions to the language. Important features include:

- Four variable types: Integer, String, and Single and Double Precision Floating Point (13 digit)
- Full PRINT USING for formatted output
- Long variable names
- Error trapping
- Matrices with up to 32 dimensions
- Boolean operators OR, AND, NOT, XOR, EQV, IMP
- Supports random and sequential disk files with a complete set of file manipulation statements
- IEEE floating point available soon as an option

In addition, SuperSoft BASIC has no run time license fee. SuperSoft's line of fine language compilers includes FORTRAN, BASIC, C, and Ada.

Requires: 128K memory
BASIC compiler: \$300.00

SUPERSOFT LANGUAGES: THE STANDARD OF EXCELLENCE.

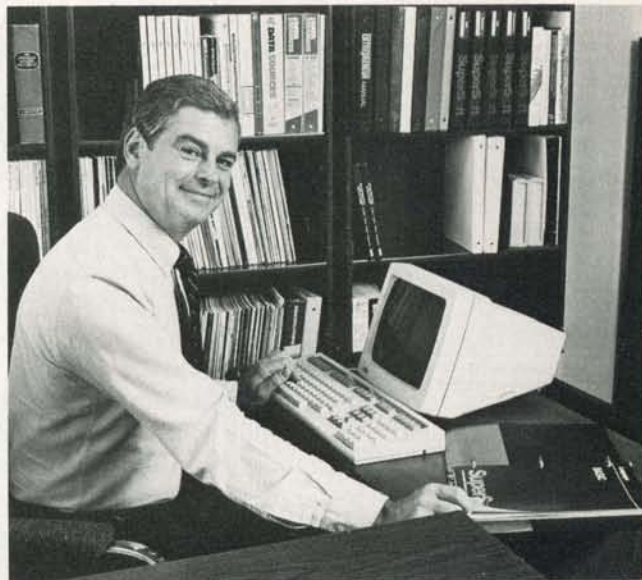

SuperSoft BASIC lets me run compiled BASIC programs under either CP/M-86 or MS DOS.

*SuperSoft BASIC is compatible with Microsoft BASIC interpreter and IBM PC BASIC. Due to version differences and inherent differences in compilers and interpreters some minor variations may be found. Machine dependent commands may not be supported. The vast majority of programs will run with no changes.

Japanese Distributor:

ASR Corporation International, TBL Building, 7th Floor,
1-19-9 Toranomon, Minato-Ku, Tokyo 105, Japan.
Tel. (03)-5025550, Telex: 222-5650 ASRTYO J.

European Distributor:

SuperSoft International Ltd., 51 The Pantiles,
Tunbridge Wells, Kent, England TN2 5TE.
Tel. 0892-45433. Telex: 95441 Micro-G.

SuperSoft[®]

FIRST IN SOFTWARE TECHNOLOGY

P.O.Box 1628 Champaign, IL 61820 (217) 359-2112 Telex 270365

Microsoft is a trademark of Microsoft Corporation.
IBM PC is a trademark of International Business Machines Corporation.
CP/M is a registered trademark of Digital Research.

load. We noted the compile times for each program and for various conditions of execution of each program. These times and conditions are shown in table 16. The Sieve was executed alone and as four background tasks, the last of which was executed under time. The terminal program used the console and either one or both of the terminal ports, each set to 9600 bps (bits per second), full duplex. The disk program wrote data to one, two, four, or eight files simultaneously. The Unix sort facility was then used to sort the resultant files under two conditions: a simultaneous sort of each file to its own destination file, and a multifile sort of each file to a single destination file. We believe these benchmarks to be a fair and accurate picture of the various activities that combine to form "system performance."

Analysis

The Radio Shack TRS-80 Model 16B is a fairly well-implemented and apparently well-supported Xenix system. Business-oriented software is available from the manufacturer, and it should be possible to get third-party "Unix-compatible" software for the machine in the near future. The machine we tested was not as reliable as we would have hoped. On several occasions, the display screen seemed to roll like a TV with a maladjusted vertical-hold control. We let the display roll for 5 to 10 minutes and the problem corrected itself on every occasion. More seriously, for unknown reasons, the 12-megabyte hard

disk went down for an afternoon. After a couple of attempts to reformat the disk (23 minutes per attempt), we finally succeeded and were able to reload the operating system and development software. Everything went fine after that. This incident illustrates the three cardinal rules to be followed by all users of nonremovable hard disks: 1) back up your data and software, 2) back them up again, and 3) back them up a third time and put the media in another room.

When we opened the back of the system unit to look at the card cage, we found that one of the rivets used to attach a card-edge guide to the card cage wall had come loose, leaving the card in that slot partly unsupported. Such mechanical strain could result in premature board failure.

Despite these problems (we regard them as new-product teething pains), we thought the system was a useful and well-executed product. Radio Shack has come a long, long way from the TRS-80 Models I and III. With Radio Shack's customary attention to providing software and a wide variety of compatible peripherals, this system could become one of the more interesting offerings in its price class. It has already met and exceeded some of its competition in the area of available business software. Its only failing in addressing its target market is its use of the standard Unix shells. A turnkey business user expects a gentler user interface, such as has been provided by some of Radio Shack's competitors. We also have to

COMPUTER T SHIRTS!

Software Fashion
P.O. Box 9861, Wethersfield,
CT 06109-0861, or call Linda
to order 1 (800) 223-1796. NY
residents call 1 (212) 371-1900.

Hey Linda, I know a good thing when I see it. Send me _____ computer shirts as indicated below. I'm enclosing \$_____ at \$9.00 plus \$2.25 postage and handling for each shirt. (CT residents add 7½% sales tax). Allow 4-6 weeks for delivery. Please print clearly.

MC Visa Check/M.O. card # _____ exp. date _____

Name _____
Address _____
City, State, Zip _____

Qty.	Color (Black/White)	Size (S,M,L,XL)	Style (a,b,c,d)

B

VERSATILE DATA REDUCTION, DISPLAY AND PLOTTING SOFTWARE FOR YOUR APPLE* II

STRIPCHARTER — Turns your APPLE and Epson MX series printer into an economical 4-pen chart recorder. Prints and displays continuous 1 to 4-channel stripcharts of any length. Ideal for large data sets. Numerous user-selectable graphics options enhance output quality. Includes 5 demos on disk with 37-page manual \$100

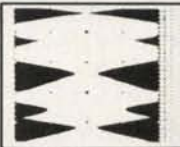

VIDICHART — Proven tool for lab data management. Fast plots of 4 data sets with scrolling in 4 directions, zoom scaling on X and Y axes, 2 types of graphic cursors and on-screen STATUS REPORT, even plots A/D input while sampling. ADD, SUBTRACT, MULTIPLY, DIVIDE, INTEGRATE, DIFFERENTIATE, AVERAGE or NORMALIZE data sets with SIMPLE COMMANDS. Ideal for spectra, chromatograms, rate curves, etc. Includes SAMPLE DATA on disk with 28-page manual \$75



SCIENTIFIC PLOTTER — Draws professional-looking graphs of your data. You choose data format, length and position of axes, 20 symbols, error bars, labels anywhere in 4 orientations. Includes 5 demos on disk plus 30-page manual \$25

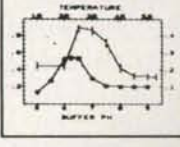

(For DIF file and Houston Instrument or H-P 7470A plotter adaptations, add \$25 for each option selected.)

CURVE FITTER — Select the best curve to fit your data. Scale, transform, average, smooth, interpolate (3 types), LEAST SQUARES fit (3 types). Evaluate unknowns from fitted curve. Includes 5 demos on disk with 33-page manual \$35

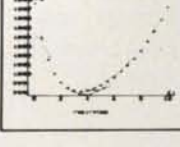

SPECIAL: VIDICHART, SCIENTIFIC PLOTTER, CURVE FITTER on 1 disk \$120

Add \$1.50 shipping on all U.S. orders. VISA or MASTERCARD orders accepted.
*Trademark of Apple Computer, Inc.

mi INTERACTIVE MICROWARE, INC.
P.O. Box 771, Dept. 3 State College, PA 16801
CALL (814) 238-8294 for IMMEDIATE ACTION

Why The Computer Industry Trusts Emery.

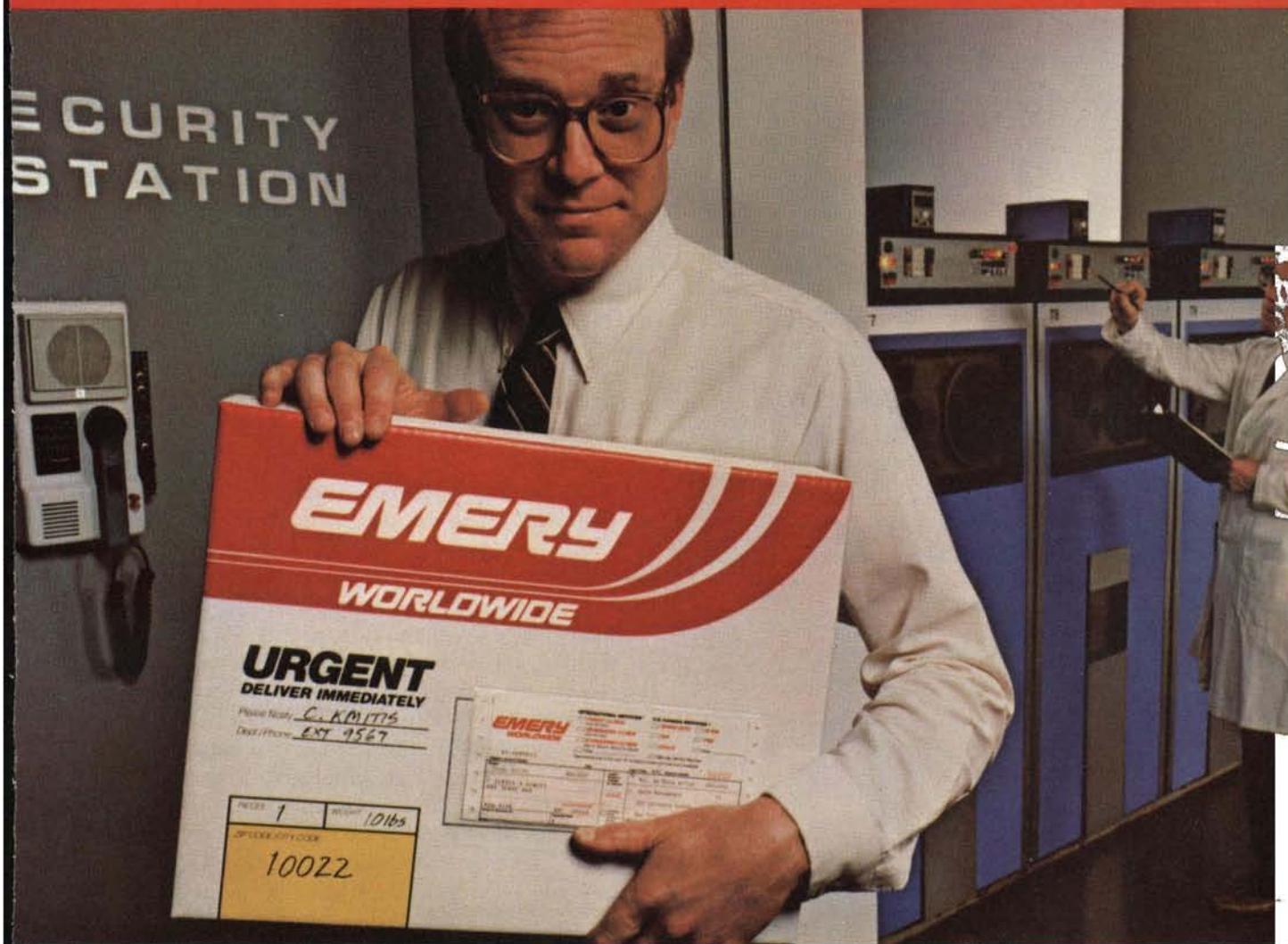

We've earned the trust of companies like yours by providing on-time delivery time after time. And with Emery you can ship virtually any weight, anywhere.

People in the computer industry especially appreciate knowing that over 96,000 U.S. communities are within their reach with a single call to Emery. You can request same day and overnight services or schedule a pickup of any shipment from a time-sensitive contract, to a computer chip, to a mainframe, because our customer service representatives are skilled at handling your special needs.

You'll also appreciate the money you can save when you send more of your shipments with Emery. You qualify for Multiple Shipment Discounts from the first time you ship with us, and our Multi-piece Savings to a single destination can save you even more. So call your local Emery office today and find out how our services can be tailored to the high-pressured needs of the computer industry. © Emery Worldwide 1983

Circle 154 on inquiry card.



EMERY
WORLDWIDE

We've earned the trust of American Business.

The BROKER / Software Services

**ATTENTION
PROGRAMERS & PUBLISHERS
of
BUSINESS - INDUSTRIAL - VERTICAL MARKET
SOFTWARE**

SOMETHING NEW IS BEING ADDED:
We can expand your market exposure: Dramatically increase your sales: Help you reach virtually all software salespeople with your product: **By having your software included** in our catalog and in our service program.

SOFTWARE
SERVICES



BUSINESS
INDUSTRIAL
CATALOG

Our catalog for business, industrial & vertical market software is designed to inform & instruct software salespeople on program application & usage. Our services will include acting as consultants to salespeople and providing many other additional services for software salespeople, at **Virtually No Cost To You**. For Additional Information:
CALL OR WRITE: 1-800-421-6468

The BROKER
Software Services
314 N. Auburn - Suite 262
Farmington, NM 87401

The BROKER / Software Services

comment on the system manuals. There are eleven of them: six for Xenix and the Development System, and five for the single-user operating systems, the assembler, and hardware owner's manuals. The manuals are long, neat, well indexed, illustrated, and index-tabbed. They are, however, rather difficult to use, especially for the intended purchasers of the machine. The documentation for the hardware and single-user software is moderately informative, but tends to brush the surface of topics that require detailed treatment. There is no clear documentation path, either. One manual says to read it first (the 16B's Operator's Manual); it deals entirely with the single-user operating systems and basic use of the machine. Although it is relatively lengthy, the Xenix documentation is only a mild improvement over standard Unix manuals. There are some custom-written sections, and the organization and indexing of the manuals is much better than for standard Unix manuals. However, we feel that naive purchasers could not use this machine without a lot of careful handholding from their dealers. We hope that Radio Shack dealers are better able to handle the complexities of Unix than are most computer retail stores today.

Conclusions

The Radio Shack TRS-80 Model 16B computer is a good competitor in the race to computerize America's small businesses. Its drawbacks for an unsophisticated user relate to the traditional Unix user interface and the lack of any real help to a novice from the large stack of manuals shipped with the system. Its advantages include good initial software offerings and the support of a very large company with many dealers and service centers. While there is certainly better executed hardware and software available in the same price category, Radio Shack has a significant potential advantage in its extensive support capabilities. It's not clear whether Radio Shack can or will invest in the educational program necessary to make sure its dealers can cope with the very sophisticated Xenix environment. The Microsoft implementation of Xenix is fairly complete and has many useful extensions to the basic Unix software set. Surprisingly, to us, the Model 16B appears to be a very good choice for people who need a small Unix development environment. Radio Shack has done a good job on this machine, and it deserves serious consideration. ■

References

1. Kernighan B. W. and D. M. Ritchie. *The C Programming Language*. Englewood Cliffs, New Jersey: Prentice-Hall, 1978.
2. Weinberg, P. N. "The Multiuser UNIX Benchmark." *UNIQUE*. June 1983, pages 3-8.

Steven H. Barry is a senior scientist with Systems Research Laboratories Inc. (Eastern Division, 6231 Leesburg Pike, Suite 300, Falls Church, VA 22044). He holds a Ph.D. from the University of Rochester and an M.A. from California State University, Los Angeles.

Randall Jacobson is a software manager for Systems Research Laboratories. He was educated at the University of Maryland.

Computer Protection

KLEEN LINE®

CONDITIONER

Prevents:

- Computer Damage
- Brownout Interruptions
- Lightning Spike Damage
- Disruptive Line Noise
- Program Errors

Regulator • Filter • Suppressor

KLR-250A	250 Watt Load	\$291.95
KLR-250A-1S0	250 Watt Load; Patented Filter Isolated Sockets	\$346.95
KLR-500A	500 Watt Load	\$390.95
KLR-500A-1S0	500 Watt Load; Patented Filter Isolated Sockets	\$445.95

Shipping: \$12.75 Land; \$45.50 Air

Ask Your Local Dealer

ESP® Electronic Specialists, Inc.
171 South Main Street, Box 389, Natick, Massachusetts 01760

Toll Free Order Desk 1-800-225-4876
MasterCard, VISA, American Express

Dirty Power In Ultra Quiet



KLEEN LINE Power Out

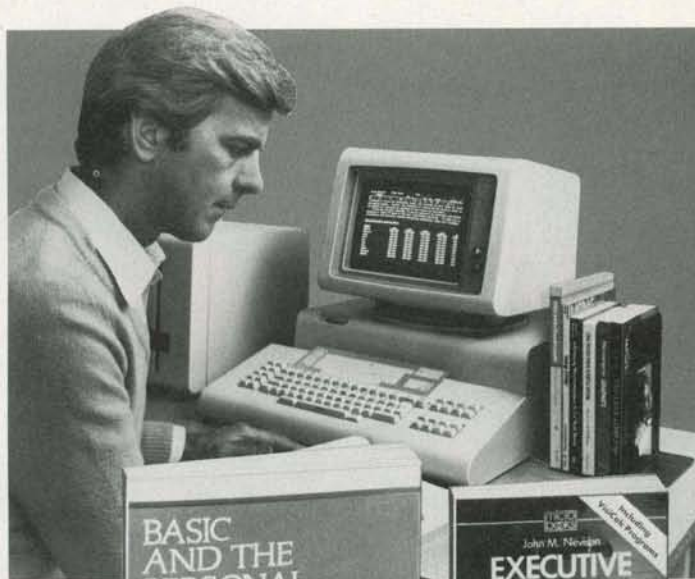

Get more from your small computer!

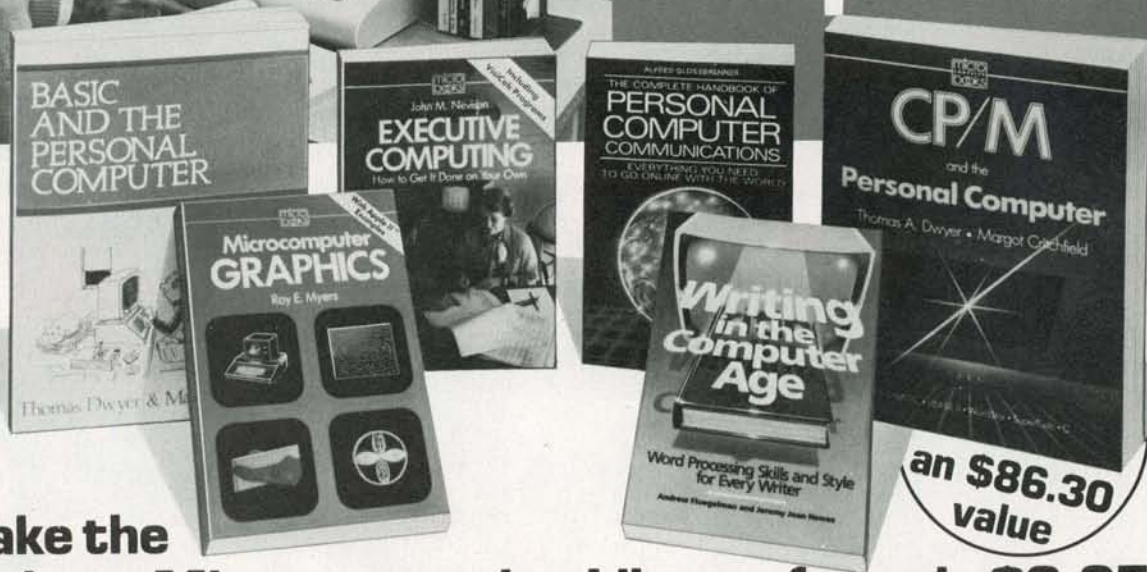

an \$86.30
value

Take the 6-volume Microcomputing Library for only \$2.95 when you join the SMALL COMPUTER BOOK CLUB

You simply agree to buy 3 more books—at handsome discounts—within the next 12 months.

This set of six carefully selected books—an \$86.30 value—will be your basic reference source for small computing.

1. BASIC AND THE PERSONAL COMPUTER.

Thomas A. Dwyer and Margot Critchfield. A down-to-earth introduction to programming in BASIC. Includes: computer graphics, program development, data bases, and more. Also, many step-by-step examples of word processing, computer games, and computer simulations. **Publisher's Price: \$15.55.**

2. MICROCOMPUTER GRAPHICS.

Roy E. Myers. Provides the essential mathematics and programming techniques you will need for computer graphics applications in BASIC, and many other topics. **Publisher's Price: \$12.45.**

3. THE COMPLETE HANDBOOK OF PERSONAL COMPUTER COMMUNICATIONS:

Everything You Need to Go Online with the World.

Alfred Glossbrenner. This digested collection of detailed information on the far-flung aspects of networking and data bases shows you how to gain access to a universe of information with your small computer. **Publisher's Price: \$14.95.**

4. WRITING IN THE COMPUTER AGE: Word Processing Skills and Style for Every Writer.

Andrew Fluegelman and Jeremy Joan Hewes. A

manual for everything from types of equipment to the fine points of formatting the finished work. **Publisher's Price: \$10.95.**

5. CP/M AND THE PERSONAL COMPUTER.

Thomas A. Dwyer and Margot Critchfield. A crisp, detailed tutorial that will easily turn the average reader into a skilled CP/M user. Features lab exercises in each chapter. **Publisher's Price: \$19.95.**

6. EXECUTIVE COMPUTING.

John M. Nevison. 25 business methods illustrated by computer programs, in a step-by-step casebook. You'll find details on pricing techniques... long-range planning... corporate data bases... and much more. **Publisher's Price: \$12.45.**

SMALL COMPUTER BOOK CLUB is a division of the Library of Computer and Information Sciences, the oldest, largest and most respected computer book club in the world. The **SMALL COMPUTER BOOK CLUB** will keep you up-to-date with the latest developments in software, improvements in hardware, programming languages, and much more—all at handsome discounts.

So start enjoying the club's benefits today.

4 Good Reasons to Join

1. The Finest Books. Of the hundreds of books submitted to us each year, only the very finest are selected and offered. Moreover, our books are always of equal quality to publishers' editions, *never* economy editions.

2. Big Savings. In addition to getting the Microcomputing Library for \$2.95 when you join, you keep saving substantially—up to 30% and occasionally even more. (For example, your total savings as a trial member—including this introductory offer—can easily be over 50%. That's like getting every other book free!)

3. Bonus Books. Also, you will immediately become eligible to participate in our Bonus Book Plan, with savings up to 70% off the publishers' prices.

4. Convenient Service. At 3-4 week intervals (16 times per year) you will receive the **Book Club News**, describing the Main Selection and Alternate Selections, together with a dated reply card. If you want the Main Selection, do nothing and it will be sent to you automatically. If you prefer another selection, or no book at all, simply indicate your choice on the card, and return it by the date specified. You will have at least 10 days to decide. If, because of late mail delivery of the News, you should receive a book you do not want, we guarantee return postage.

If the reply card has been removed, please write to the **Small Computer Book Club, Dept. Y-AF5, Riverside, N.J. 08075** to obtain membership information and an application.

Software for Writers



"Oasis Systems' software - unquestionably the best" . . . Peter McWilliams, author of the #1 best-selling book on word processing.

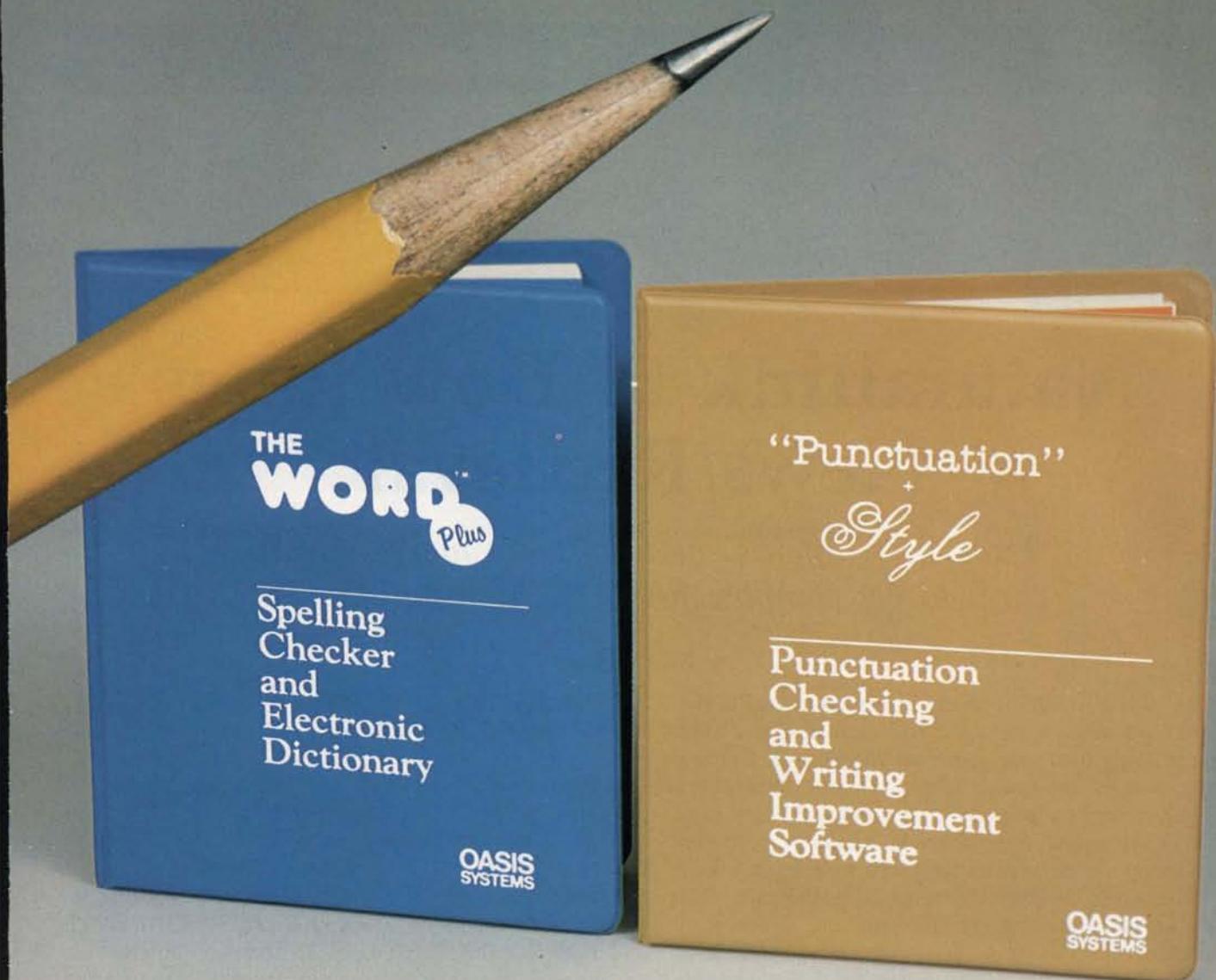

The WORD Plus is the standard by which other spelling checkers are measured. Here's why:

- Real 45,000 word dictionary.
- Shows errors "in-context."
- Interactive word look-up finds correct spelling for you and corrects at the push of a button.
- Hyphenates words automatically.
- Solves crosswords, puzzles, and anagrams.
- Works with almost any CP/M®, CP/M-86® or MS/DOS (1.0, 1.1 and 2.0) compatible word processing program (WordStar, Magic Wand (PeachText), Spellbinder, Perfect Writer, Select, Final Word, Volkswriter, . . . and more!).

Punctuation & Style takes the worry out of writing by automatically catching dozens of different punctuation errors, both common and obscure. In addition, P&S catches unpaired format commands (underline, boldface, etc.), doubled words, and more.

P&S gives you a "critique" of your writing, suggesting alternatives for commonly misused or over-worked phrases. It also shows where active voice can replace passive voice to add clarity and precision.

Punctuation & Style is the perfect companion to The WORD Plus. It works easily with most CP/M word processors. (Available also for CP/M-86 and MS/DOS.)

Call or write for
complete information:

619-222-1153

**OASIS
SYSTEMS**

2765 Reynard Way
San Diego, CA 92103

Circle 271 on inquiry card.

Dealers contact:

SOFTWARE DISTRIBUTORS

1-800-252-4024 (in California)

1-800-421-0814 (outside California)

Naturallink to Dow Jones News/Retrieval

Texas Instruments' new software makes it easy to get complex financial information

by Mark Haas

One of the problems of the Information Age is that it isn't always easy to get the exact information you want. Several large databases, such as The Source, CompuServe, Knowledge Index, Dialog, Delphi, and others, offer their services to individual users and businesses. Each of these databases, however, works in a different way, using a unique command structure. In fact, even within a single database there may be several individual services, each working in a different way. To ease connection to one of those databases—the Dow Jones News/Retrieval Service—Texas Instruments has designed a software package that speeds and simplifies access procedures.

The Dow Jones News/Retrieval Service, a division of Dow Jones and Company Inc., which also publishes the *Wall Street Journal* and *Barron's*, is used primarily by businesses and individuals interested in business. This service provides financial information on any company listed on the New York and American stock exchanges as well as selected over-the-counter companies. You have access to 15-minute-delayed stock quotes, historical stock-quote information, disclosures, and price/volume data. The service also provides information on a large number of industries, news stories from various financial newspapers, transcripts of "Wall Street Week," movie reviews, weather information, and access to an encyclopedia. It's all in there—if you know how to access it.

The major problem with Dow Jones News/Retrieval is the cryptic way in which its information is accessed. To give you an idea of how complicated this process can get, I'll quote from the *Operating Guide* for the system:

1. Type the appropriate character to obtain the desired database.

CHARACTER	DATABASE
Comma (,)	Common and preferred stocks and warrants
Slash (/)	Corporate and foreign bonds
Plus (+)	Mutual funds
Small hyphen (-)	Options
Number (#)	U.S. treasury issues

2. Immediately type in the symbol for the desired quote. Symbols are in the *Operating Guide*. SPECIAL NOTE FOR COMMON STOCKS. To access a quote from a specific exchange, not the composite, first type in the number of the exchange and then the stock symbol. No number is required for OTC stocks.

1 New York	3 Pacific
2 American	4 Midwest

To access preferred stocks add a plus (+) immediately after entering the symbol. For warrants add a percent (%) immediately after entering the symbol. For when issued stocks on the NY and AMEX, add a (@) immediately after entering the symbol, for the OTC exchange, add a V after the symbol.

3. Up to five different quotes can be obtained with each request by hitting the space bar between each symbol. Do not mix databases in a single request.
4. Hit the Return key following the last symbol in a request.

You can imagine how much time it would take you to get information for even a short list of stocks. Requests for other types of information have a similarly cryptic nature.

Enter Naturallink

Texas Instruments Data Systems Group, maker of the TI Professional Computer, has developed Naturallink to

At A Glance

Name

Naturallink to Dow Jones News/Retrieval

Type

Simplified interface to the Dow Jones databases

Manufacturer

Texas Instruments Inc.
Data Systems Group
POB 1444
Houston, TX 77001
(713) 895-3000

Format

Double-sided, double-density, 5¼-inch, MS-DOS formatted disk, copy-protected

Language

Machine language

Computer

TI Professional Computer with at least 256K bytes of memory, MS-DOS, an internal or external modem (asynchronous communications card needed for external modem)

Documentation

User Guide, approximately 60 pages

Price

\$150 (includes Dow Jones membership)

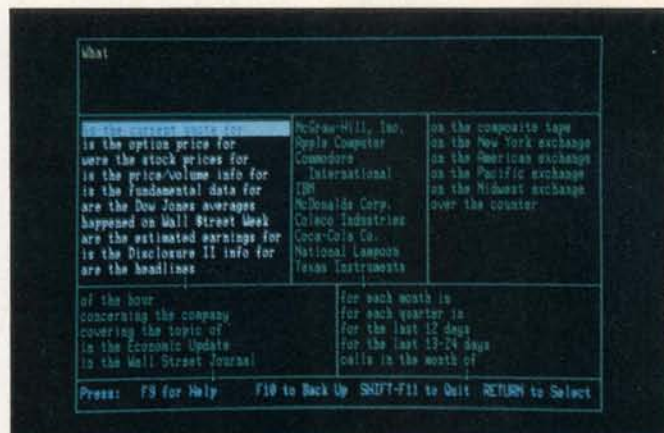

Photo 1: The Build Questions screen is the heart of the Naturallink system. Divided into windows, each window contains a specific set of phrases that are combined to form English-like sentences used to query the Dow Jones database. Small arrows at the bottom of some windows indicate that more phrases exist and can be scrolled into the window. The window across the top of the screen is used to view the progress of the sentence being constructed. The narrow window across the bottom of the screen contains information on controlling the system with the function and other keys. The stock list can be customized to your particular needs.

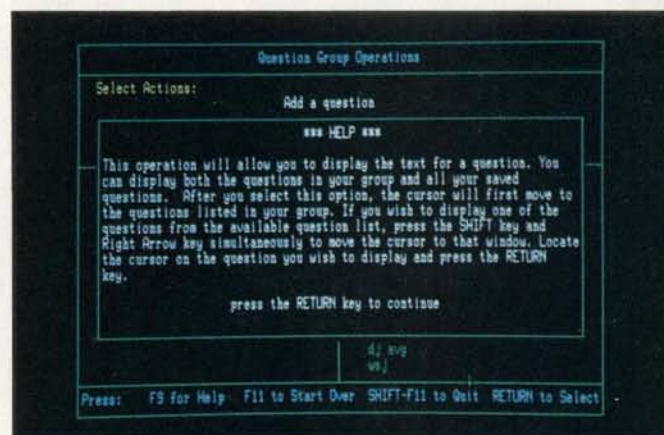

Photo 2: Context-sensitive Help screens can be called up at any time by pressing the F9 key. Further help is available to explain the purpose of an entire screen or window by pressing Shift-F9. Help appears on the screen in its own window as shown.

make the user's interaction with Dow Jones News/Retrieval more natural. This package provides owners of the TI Professional Computer with an easy-to-use method for retrieving information from the Dow Jones database. It will dial the phone, log you onto Tymnet or Telenet (Canadian subscribers, however, must log on to Datapac manually), and even use your password to connect you to Dow Jones. It can then query the database with questions you have previously set up, store the resulting data, and get you off line in a fraction of the time you would need to complete the process manually—with a resulting cost savings, too.

Naturallink's best feature, however, is that it enables you to build English-like questions that are then converted by the software into the cryptic commands used by Dow Jones. This works as follows: from the main menu, the Build Questions option presents you with the screen shown in photo 1. The topmost window contains the word "What" and is used to show the present state of the question being built. Each of the other windows contains a list of phrases used to construct queries. Queries to the database are constructed by selecting from the several groups of phrases shown to form complete sentences. Queries can be built off line and stored either individually or in groups for later use.

Phrases are selected from each window by use of the cursor. Initially, the cursor is on the first entry in the upper left-hand window, just below the word "What." All questions must begin with a phrase selected from this window. The cursor can be moved up and down within the window by using the up and down cursor

keys. It can also move from the first to the last phrase and back by use of the Home key. Additional phrases scroll into the window when the cursor is at the bottom of the window.

To select a phrase, all you have to do is move the cursor over the phrase and press the Return key. The selected phrase is then added to the contents of the topmost window, where you can see how the question you are constructing is progressing. At any point you can press the F9 key to get help on a particular phrase, and a window containing the help information will appear on the screen (photo 2); alternatively, you can press Shift-F9 to get an explanation of the particular window you are in. You can also press F10 to back up, or undo, the question you are constructing.



(3a)



(3e)



(3b)

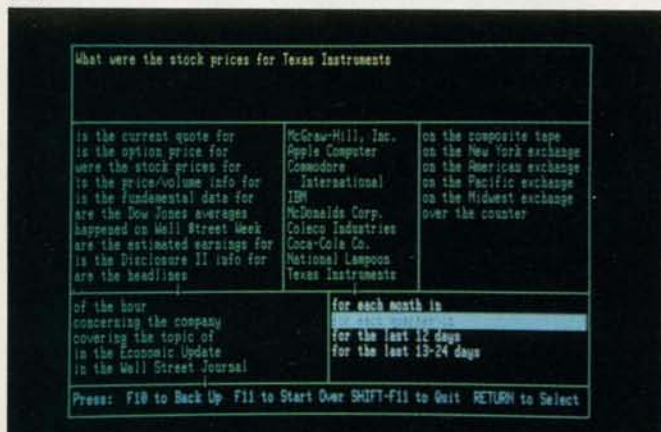

(3c)

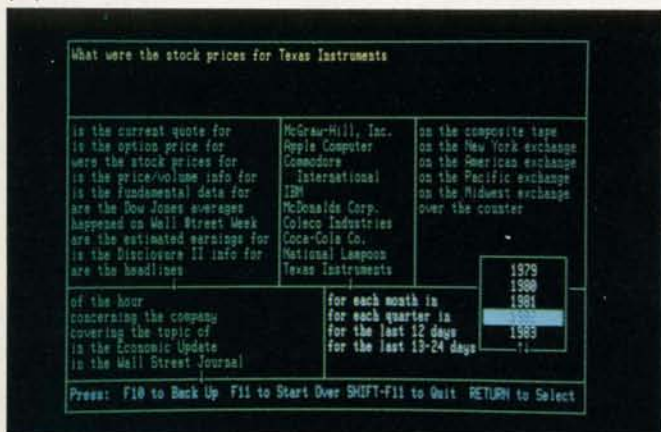

(3d)

Photo 3: In this sequence, a question is constructed by selecting phrases from the various windows using the cursor. Here, the question "What were the stock prices for Texas Instruments for each quarter in 1982?" is being built. Note that as each phrase is selected, the cursor automatically moves to the next appropriate window. You cannot build invalid questions. After the last phrase is added (in photo 3e), you can execute the question or save it to disk using the F6 key.

Phrases can also be chosen by typing the first letter of a phrase. If more than one phrase begins with this letter, the cursor will move to the first entry with this letter. Typing the second letter of the phrase will move the cursor again, until you have identified a unique phrase. This procedure usually doesn't take more than two keystrokes.

After you have selected a phrase, the cursor will then move to the next appropriate window, depending on which phrase you have selected. In some cases, merely selecting a phrase from the first window will complete a query, such as "What happened on 'Wall Street Week?'" or "What movie reviews are available?" Sometimes additional windows will appear on the screen. The sequence of screens shown in photo 3 demonstrates how you can build a question using phrases from several windows.

After a question is complete, it can be saved by pressing the F6 key. Questions are stored individually at first, but can be arranged in groups later from the main menu by selecting the Get Saved Questions option.

Most of the queries on Dow Jones will inevitably revolve around a selected group of companies listed on the various stock exchanges. Normally, this would involve having the codes for these companies handy. The Naturallink system allows you to build your own personalized group of stocks so that you can eliminate the constant necessity of looking up stock codes (remember, there are 6000 of them). The Create or Change Stock List option on the main menu takes you there. As with the rest of the Naturallink system, this operation is entirely menu driven with choices designated by the cursor. Besides creating a new group of stocks, an existing group can be modified. The stock group you create is eventually saved on disk and then appears in one of the windows of the Build Questions screen.

3" Compact Floppy Disk Drive

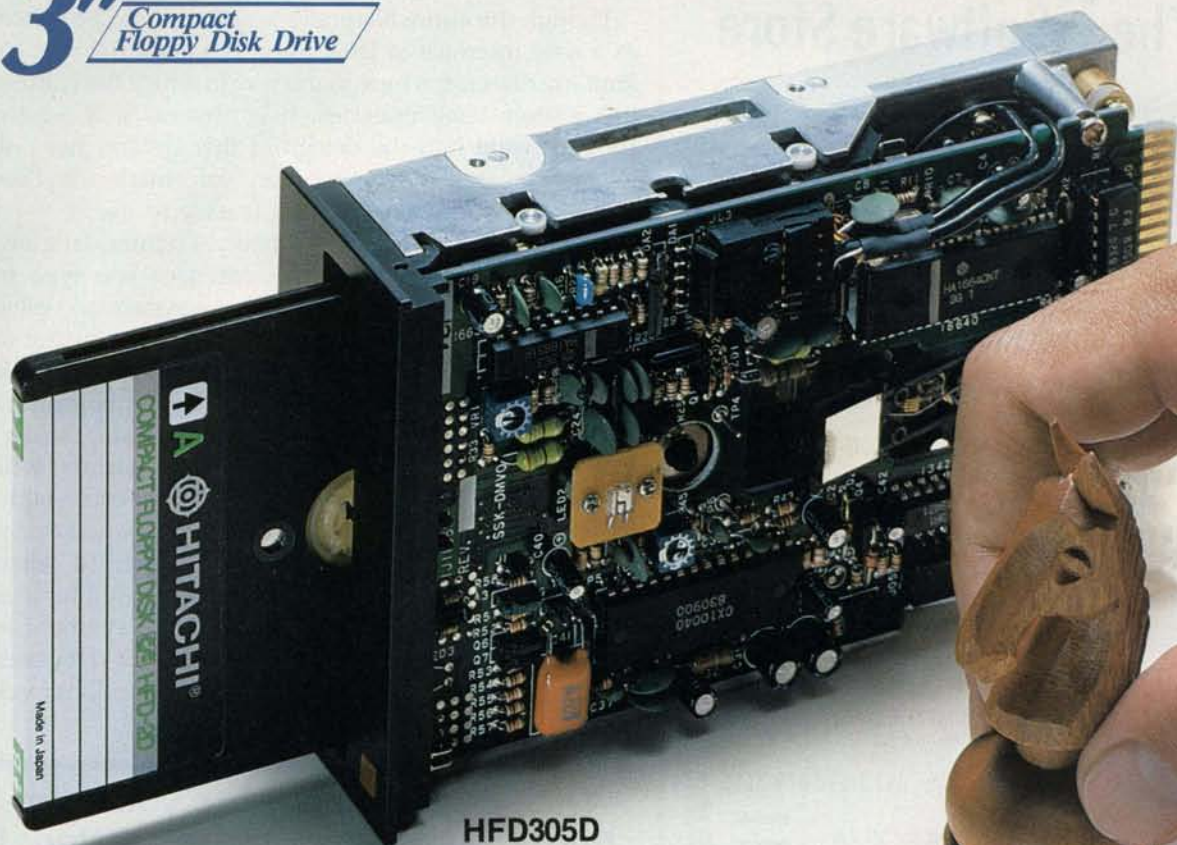

HFD305D

The winning move.

Hitachi's 3" floppy.

It's clear that the 3" floppy will become the new standard. Compact, easy to carry and mail, dust-proof and non-bendable, the 3" floppy has the powerful advantages that mean success.

To develop your share of the new 3" drive market, Hitachi's drives are the wise choice. Now double-sided and with LSI's, reduced access time and low power consumption, Hitachi's drives are better than ever.

Hitachi's resources and experience are your guarantee of quality. Over 200,000 drives will be rolling off our lines in 1983 alone. That's why choosing Hitachi is a profitable choice. No doubt about it: the format of the future is yours today with Hitachi's dependable drives.

Specifications: Storage capacity unformatted: 500 K bytes. Total no. of tracks: 80. Recording density: 9,830 bpi. Track density: 100 tpi. Transfer rate: 250 K bits/sec. Track-to-track positioning time: 3 ms/track. Dimensions (W x H x D) mm: 90 x 40 x 150. Wt.: 550g.

Floppy disk marked  can be used with this floppy disk drive.



 **HITACHI**
A WORLD LEADER IN TECHNOLOGY

For further information:

Mr. Takao Ichiki, Eastern Regional Office, Hitachi Sales Corporation of America, 1290 Wall Street West Lyndhurst, N.J. 07071 Phone: (201) 935-8980 Fax: (201) 935-4869
Mr. T. Koderu, New Jersey Office, Hitachi America, Ltd., 59 Route 17, Allendale, N.J. 07401 Phone: (201) 825-8000 Fax: (201) 825-4781

Circle 184 on inquiry card.

COMPUTER The Software Store



Mail Order Only!

WE OFFER . . .

- PROMPT, COURTEOUS SERVICE AND SUPPORT
- WIDE SELECTION
- and GREAT PRICES

for all your **Software** needs:

RECREATION • BUSINESS • EDUCATION • UTILITY
and accessories

SOFTWARE

for APPLE, ATARI, IBM, COM, VIC, TI, TRS, CP/M

WRITE OR CALL FOR FREE CATALOG

Computer
The Software Store

2549 CLEVELAND, GRANITE CITY, IL 62040
9 A.M. - 6 P.M. MON.-SAT.

Call 1-800-851-8791

Illinois Res. Call 1-618-876-2155



We accept MasterCard or VISA



MICRO BEE SOFTWARE

Manufacturing licences for the popular Australian designed Micro Bee computer have recently been granted to many companies throughout the world.

MYTEK Computing is the largest and most respected producer of software for the Micro Bee Computer.

MYTEK Computing invites dealers to sample its large and extensive range of Micro Bee Software.

Micro Bee users are also invited to request to be included on MYTEK Computing's free mailing list. Catalogues are air-mailed regularly to all parts of the world.

MYTEK
COMPUTING

1 Kent Street, Bicton, 6157, Perth, Western Australia
Telephone: (09) 330 7336

The User Interface

Though the entire Naturallink system could be viewed as a user interface to Dow Jones News/Retrieval, I will limit my discussion here to the way in which the Naturallink system itself operates. It is obvious that a lot of thought went into the design of this system, not only to create a useful tool for accessing information, but also to make it work in a way that is easy to use.

Naturallink, however, is *not* really a natural-language system. It does not interpret sentences you type in. Rather, TI has analyzed the Dow Jones system and established a finite group of phrases that, when strung together in permissible combinations, form English-like sentences that can be converted into the symbols understood by the Dow Jones system. These phrases, the decision tables associated with them that determine which combinations of phrases are valid, and the corresponding symbols understood by the database are stored in separate files on disk. There is every reason to believe that the kernel of this software package could be used with different phrase, decision-table, and symbol files to provide a similar interface to a variety of databases. This may be only the first in a series of Naturallink packages.

The software prevents you from choosing an inappropriate action: a menu option doesn't make sense, it doesn't appear.

The developers of the Naturallink system have taken advantage of every feature of the TI Professional Computer. Naturallink is a large system, requiring 256K bytes of memory. A program such as this could exist only on a 16-bit computer. Also, color is used throughout to provide status information. For instance, the active window on the Build Questions screen has white type, while the inactive windows have green type. A gentle beep of the speaker warns of inappropriate actions. The TI PC's ability to mix text and graphics is used throughout to present information on the screen in an organized way through the use of windows. Function keys provide one-stroke action on certain commands.

All this is achieved in a completely consistent way. The same keys perform the same functions no matter where you are in the system. Menu choices are selected by moving the cursor over the desired action and then pressing the Return key. The software prevents you from choosing an inappropriate action. You cannot, for example, ask for the weather on the New York stock exchange. Furthermore, the menus themselves are dynamic. If, for example, you haven't yet built a group of questions, then the Delete a Group of Questions option does not appear on any of the menus. In all cases, if a menu option doesn't make sense given a particular set of circumstances, it doesn't appear.

It is generally recognized that a menu-driven system

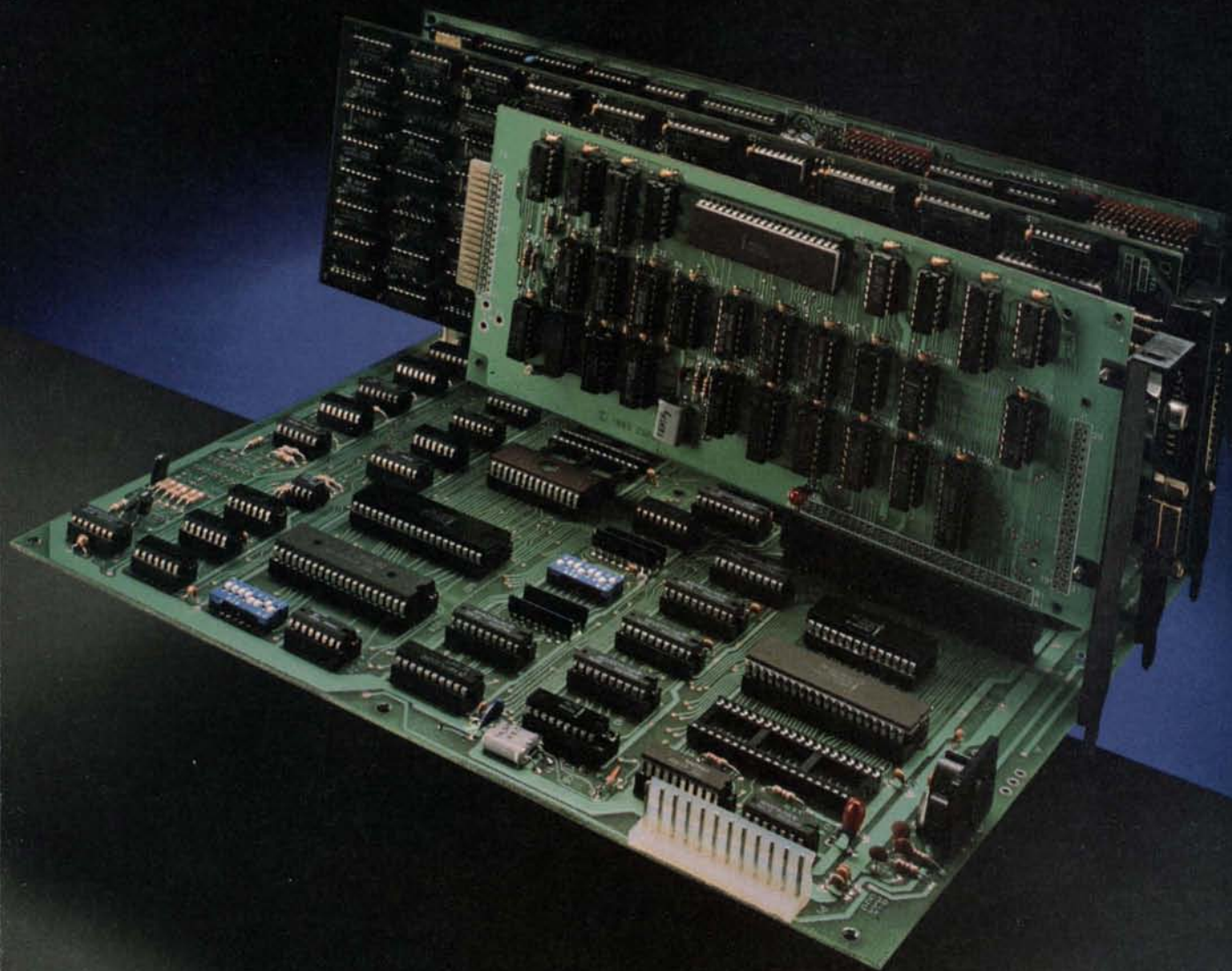

An Affordable IBM PC-Compatible OEM System

The EDGE complete family of boards is totally plug-compatible with the IBM PC system.

With the plug-in cards alone, you can expand the memory and I/O of your IBM PC. Or, you can put together your own PC-like performance computer, from start to finish, including enclosure and keyboard, easily and inexpensively. Take advantage of the limitless resources offered by IBM PC, the mainstream of the software/hardware world.

The perfect solution for industrial OEMers — a building block approach, modular, cost effective, and very flexible.

Available today: IBM-PC compatible

- System board
- Color/Graphics board
- 5¼" diskette adapter
- Multifunction card, 128K (with software)
- Keyboard
- Enclosure with power supply and wiring harness
- Boot PROM for PC DOS 2.0

EDGE MICRO SYSTEMS — dedicated to supporting industrial and OEM users with high technology systems, and service.

For more information, contact EDGE MICRO SYSTEMS, INC.



EDGE MICRO SYSTEMS, INC.
2350 Walsh Avenue
Santa Clara, CA 95051
408-980-9866

IBM is a Trademark of International Business Machines Corporation

is easy for the uninitiated to use but tends to slow down the more experienced user. As mentioned earlier, TI has taken this into consideration by allowing you to choose menu options by typing the first letter of that option. If more than one option begins with the same letter, then you have to keep typing until you have uniquely defined the option. Again, this usually requires no more than two keystrokes. Combined with the TI Professional's ability to buffer keyboard input, you could enter a series of commands rapidly while the system is fetching data from disk and it will catch up to you.

Anyone who has used the popular new generation of spreadsheet programs—for example, Lotus Development Corporation's 1-2-3 or Microsoft's Multiplan—is familiar with the use of the cursor I have just described and the keystroke option, too. Where Naturallink departs from these other programs is in its ability to use this method to also select from Dow Jones menus, menus that are not an integral part of the Naturallink software. For example, let's say you've just asked the database, "What are the headlines concerning the company IBM?" Dow Jones will then send you about five screens full of headlines (which change almost every day). If you want to read the text of the story, you normally have to enter one of the two-letter codes appearing next to each headline. Naturallink, however, provides you with a cursor to make your choice. All you have to do is scan the headlines with the cursor and press Return when you want to read a particular story. How TI does this is beyond me, but it makes the process of receiving stories extremely easy. After reading the story, you merely press F10 to bring you back to the list of headlines—at the same point where you left it—and continue to scan.

The Naturallink system, in essence, provides you with the same method of selecting information from Dow Jones as it does with its own menus. Manual selection of menu items by entering certain keystrokes is not supported directly, however, but it can be done by entering

what is called "terminal" mode.

There are, however, a few places on Dow Jones where you cannot get all the information you want via cursor selection. For example, after you ask the question, "What weather data is available?" Dow Jones presents you with a short menu of selections, and Naturallink lets you choose the desired item by moving the cursor. Below the menu, though, is the instruction to enter N for national weather or F for foreign weather. These letters must be entered manually. Naturallink allows you to shift into "terminal" mode very easily, however. All you have to do is press F12. Then you just enter your choice manually. When the next menu appears, you're back in "automatic" mode and can again choose by using the cursor.

At present, Naturallink's cursor selection capability is not available for Dow Jones' encyclopedia database or for its free-text mode. These services must be accessed manually.

Setting Up

The Naturallink system is provided on a 5¼-inch copy-protected disk. TI rationalizes the use of copy protection by stating that it is for your own good, preventing unauthorized use of your Dow Jones account, thus acting as a key of sorts.

You are provided with two copies of the master disk and directed to make a working copy on another disk or transfer the files to a hard disk. When you subsequently start the program, one of the master disks must be in the A drive, but only until the main menu appears. I had some problems copying the files onto the hard disk, but eventually they all made it.

If a company wants to protect its software, fine, but it shouldn't try to convince us that it's for our own good. At least TI provides two copies of the master disk, and this disk is used for only the briefest moment during startup. Other companies force you to use the master as the working copy.

PortaPac™

You'll Never Have To Leave Home Without Your Data Again!!

PortaPac™ is a revolutionary new product that allows the transport and transfer of information without regards to software protocols nor disk formats. PortaPac™ is small enough to fit inside a suit pocket, yet large enough in capacity to store up to 64,000 bytes of data (future versions up to 192K bytes). PortaPac™ is light-weight, versatile, totally portable, and can retain its content for up to 1 full year without ever changing batteries!

Key features:

- Industry standard RS232C interface with RTS/CTS handshake
- Full-duplex with baud rate from 50-19,200 switch-selectable
- Word length, parity, start/stop bits switch-selectable
- Transparent in-line or stand-alone host/terminal mode
- Totally portable • Can be used as a printer buffer • Virtually maintenance free • Interfaces to IBM, Apple, Radio Shack



Typical Uses:

- Transport of information - courier data pack • Exchange of information • Backup /copy • Demo of software programs/hardware devices • Printer buffer • External storage for portable computers • Data acquisition for sales people/sales demo • Diagnostic program pack for field service technicians • and more
- 16K, 32K, 64K versions available.

Ordering Information:

Send order and check, COD, VISA, MASTERCARD to
Cryptronics, Inc.
 11711 Coley River Cir, Suite 7
 Fountain Valley, CA 92078 Tel. (714) 540-1174

Add \$8.00 for freight and handling. California residents add 6½% sales tax. Allow 2-4 weeks for delivery.

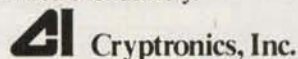

PortaPac™ is a trademark of Cryptronics, Inc. Disclaimer: Cryptronics, Inc. shall not be responsible for the use of its product for illicit purposes.

KNOWLEDGE SYSTEMS INC.

Information Processing Components,
Selected for Performance and Value.

NO SURCHARGE FOR MASTER CARD AND VISA

PREPAID PRICES INCLUDE SHIPPING AND INSURANCE, UPS Ground Continental USA only

SOFTWARE

Ashton Tate

D Base II	389
Fridays	184

Software Arts

T K Solver	215
Solver Pac	88

Sorcim

Super Calc III	294
----------------	-----

Micro Pro

Wordstar	258
Mail Merge	131
Spellstar	131
all in one pack	475

MBSI

Real World GL	533
Real World AR	533

American Training

For most Programs	Call
-------------------	------

Hayes

Smart Com	71
-----------	----

Micro Stuff

Crosstalk	134
Remote	100

Rose Soft

Prokey	60
--------	----

TERMINALS

Televideo

910	533
925	753
950	950

Teletex

3000	494
------	-----

MODEMS

Hayes

300	207
1200	493
1200B	432
Micro Modem II w/T	242

US Robotics

Password	340
Auto Dial 212A	460

Novation

Access 1-2-3	Call
Apple Cat II	282

Promethius Products

1200	365
------	-----

Rixon

212A	Call
1200	Call

California Residents add 6.5% States Sales Tax

Shipping extra for outside USA, FPO and APO

Please include an address reachable by UPS, no P.O. boxes, and your phone number where you can be reached during the day.

PRINTERS

Leading Edge

8510A	363
1550	668
F10-40	1079
F10-55	1415
A10-18	625

We Know How to make your
Prowriter IBM Compatible

Okidata

92A	430
93A	770
92IBM	486
IBM Printer ROM	45
2350	2090
2410	2380

Star Micronics

Gemini 10X	300
Gemini 15X	444
Delta 10	494

NEC

3550	1888
7710	2095

Brother

HR1	607
HR25	786

Dynax

15	462
Key Board	149

IDS

Prism 132 Color	1578
Prism 80 Color	1419

Transtar

315 Color	480
-----------	-----

Silver Reed

550	599
500	431

Juki

6100	492
------	-----

Teletex

1014	455
------	-----

IBM PC ACCESSORIES

AST Research

6-Pack 64K	269
Combo Plus 64K	269
Mega Plus II	269

Micro Graphics

RGB, Monochrome, Printer	398
--------------------------	-----

Plantronics

Color Plus	375
------------	-----

SPECIALS

SUPER CALC III - \$299

TERMINAL

TTX 3000 - \$494

EMULATES TELEVIDEO 95

Leading Edge

A10 - \$625

**C. ITOH 18 CPS daisy wheel print
Diablo Compatible 15" carriage**

8510SP - \$725

**C. ITOH 180 CPS MATRIX
Correspondence 120 CPS, Italics
True Sub Script & Super Scripts
2 K Buffer, 13 Character Sets**

MONITORS

Amdek

300A	1
300G	1
310A	1

Dynax

12" Green	1
12" Amber	1

Taxan

RGB III	1
RGB 420	1

Sanyo

8112 Hi/Res	1
-------------	---

USI

PI 2 12" Green	1
PI 3 12" Amber	1

Princeton Graphics

PGS HX 12	1
-----------	---

Sony

RGB	1
-----	---

NEC

JB 1201	1
JB 1205A	1
JC 1410	1

(213) 344-4455

**Knowledge Systems Inc.
19707 Ventura Blvd.
Woodland Hills
CA 91364**

ORDERING TERMS

Prepaid: Money Orders, Cashier's Check
Certified Checks, Bank Wire Transfer
Master Card, Visa, AMEX (add 3% f
AMEX) and Personal Checks (allow
banking days for all personal check
Please include Valid Driver's License
and Major Credit Card for Identification

Circle 479 on inquiry card.



Photo 4: After logging onto Naturallink, you are presented with the Main Menu. From here you can perform the various functions listed. Only those functions that can be performed appear on the menu. For instance, the Get Saved Questions option appears on the menu only when there are questions to retrieve.

The next step is to set up your User Profile, i.e., information the system needs to establish your files. Here you give your data file a name and store your Dow Jones password. You also designate whether you want to log on automatically or manually. Automatic log on is available only for Tymnet and Telenet.

In order for the software to work properly with your system, you have to tell it what equipment you are using. Naturallink calls this process "Creating a Communications Profile." Here you can choose between internal and external modems, automatic and manual dialing, port selection, choice of network (Tymnet, Telenet, etc.), and phone number. I found it interesting that I had to manually designate the port used by my TI's internal modem. This requirement is strange because, in order to determine what port my internal modem occupied, I had to run TI's Diagnostics disk, which automatically determines the port. If the Diagnostics software can do this, why can't Naturallink?

Beginners are advised to use the excellent tutorial disk provided with the system. It demonstrates the question-building process and provides a hands-on opportunity to use the system; helpful prompts even appear in one of the windows on the Build Questions screen. All in all, it provides a nonthreatening way to begin to use the software.

A Typical Session

After you've installed your user and communications profiles, a typical session with the Naturallink system begins with the construction of questions. After entering the appropriate user ID and password (different from the Dow Jones account password), you are presented with the main menu (see photo 4). If you haven't already done so, now is the time to create your own personalized group of stocks. But let's assume this has been done previously. The cursor is already over the Build Questions option, so all you have to do is press Return.

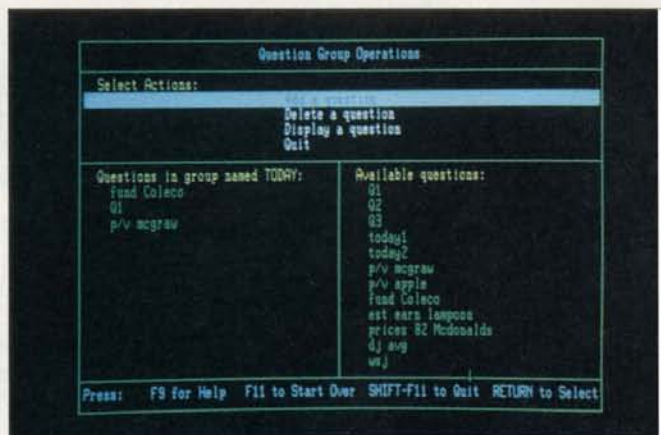

(5a)

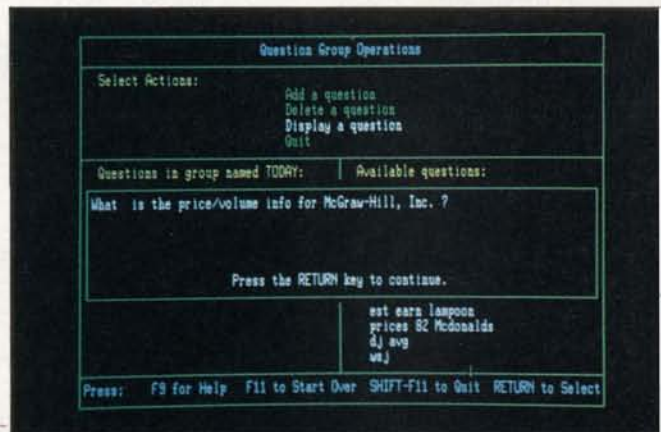

(5b)

Photo 5: Questions that have previously been saved individually from the Build Questions screen can be organized into groups from this menu. Again, only those options that are relevant appear on the menu. By organizing questions in groups, you can eliminate the need to present each question individually. At any point you can display a question's contents by placing the cursor over its name after selecting the Display Question option, as shown in photo 5b.

The Build Questions screen, with its associated windows, appears after a couple of status messages tell you what is happening. Questions are constructed as described earlier and saved onto the disk.

One of the ways to use this system most efficiently is to arrange your questions into groups. From the main menu you select the Get Saved Questions option, which presents you with another menu. From this second menu you select the Build Question Group option. This allows you to view all the questions you saved using the Build Questions screen, arrange them in groups, give these groups names, and save them on disk. Photos 5a and 5b show this process.

Once the groups of questions have been stored, it is possible to execute a group. No, this doesn't mean lining them up and shooting them. Rather, executing a group of questions causes Naturallink to begin the process of automatically logging on to Dow Jones. First, diagnostics are performed on the the TI's asynchronous communications card or internal modem, depending on

Finally a data base management system that lets you do just that. Manage.

You probably know more about managing people than managing a data base. That's why we designed a system that's easy to use, yet so sophisticated it will increase the productivity of every person in your office.

INTRODUCING INFOSTAR+™

The data base management system with the added plus of StarBurst: a systems building tool that integrates your software to let you create your own custom applications.

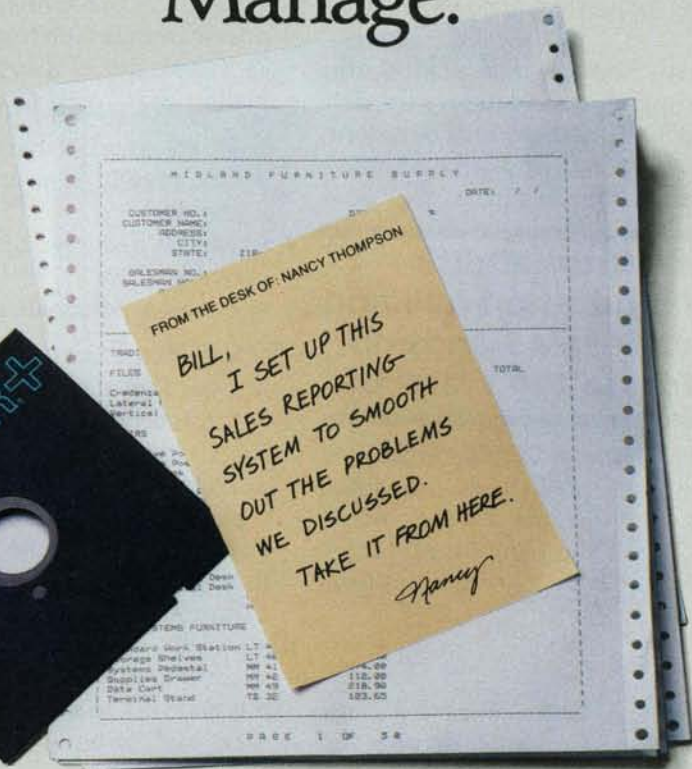
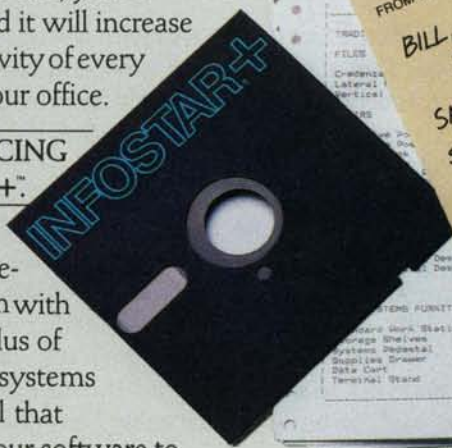

feature that lets you simply design and draw your report on the screen to format, manipulate and merge information in countless different ways. Plus a quick report feature that lets you generate a pre-formatted report in 60 seconds, or even less.

All without knowing a programming language or special code. Just English, or the language of your choice.

A SYSTEM THAT SPEAKS YOUR LANGUAGE.

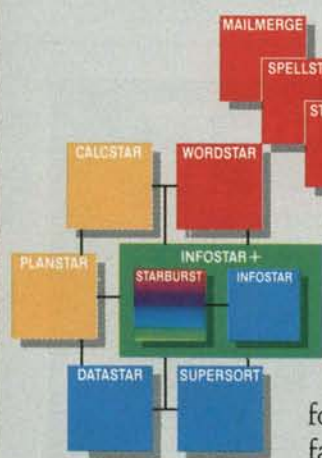

InfoStar+ makes accurate, efficient data entry easy by letting you design any form for custom data entry—mailing lists, inventories or sales figures—simply by drawing it on your screen.

Want to sort things out? InfoStar+ sorts information five to six times faster than any other DBMS.

What's more, InfoStar+ has a custom report

A GOOD MANAGER ALWAYS DELEGATES.

The StarBurst portion of InfoStar+ integrates all your MicroPro software products as well as other popular software. StarBurst lets you set up and delegate any sequence of data entry, sorting and reporting.

So see your computer dealer now, and ask about InfoStar+. The sooner you start using InfoStar+, the better.

For the dealer nearest you, call (800) 443-0100 ext. 948.



When you start with MicroPro, there's no stopping you.

Circle 480 on inquiry card.



which is being used. Next, assuming you have either the built-in modem or a programmable external one, the program dials the appropriate network, let's say Tymnet, and establishes connection. Naturallink then directs Tymnet to connect you to Dow Jones and uses your password to log you onto the system. While all this is going on, a series of status messages keeps you informed of the system's progress. After you are logged onto Dow Jones, your group of questions is presented to the system and the information you requested appears on your screen.

Instead of wasting costly connect time reading this data, however, you can simply press F6 to save the data on your disk and proceed to the next group of questions. After the last question is answered, you can disconnect and review your data file at your leisure.

An excellent tutorial disk demonstrates the question-building process and provides a hands-on opportunity to use the system.

At almost any time while connected to Dow Jones, you can call up the Build Questions screen to ask individual questions that may arise from the data you see coming in. You can also interact with the Dow Jones system manually, if you know the appropriate codes and have a masochistic streak.

Documentation

After viewing TI's new BASIC manual for the PC (see my review of the TI Professional Computer on page 286 of the December BYTE), I had high hopes for this manual. Unfortunately, this manual suffers from the same problems as most of TI's others. Although the argument could be made that the tutorial disk obviates the need for a good manual, the manual should at least be

a good reference. This manual isn't. In fact, in many places it reads like advertising copy. I think the section I liked the best was entitled "Using the Main Menu Effectively." Oh boy, I thought, here's a way to get the most out of the software—perhaps some sort of strategy. Instead I read about how the program uses the main menu effectively by limiting the user to valid choices.

Conclusions

Now, I'm not a financial wizard. I wouldn't know price/earnings ratio from a gear ratio. But I do know that TI has produced a system that makes retrieving information easy. With this system you can

- prepare your database queries off line at great savings
- automatically dial and log onto Dow Jones News Retrieval
- save the data resulting from your queries for off-line review
- prepare a personalized stock list

Naturallink lets you do this with a series of menus and screens that allow even the novice to use it with ease. A tutorial provides most of the information you need to get started, and context-sensitive Help screens are available at all times.

By combining the central logic of this Naturallink package with other phrase, decision-table, and symbol files, it would seem possible for TI to develop a series of Naturallink packages for a variety of databases. To do so would mean that you could interact with a number of diverse data services through an interface that would always work in a familiar way. It could provide a "software bus" to on-line databases. Now that's something to ponder. ■

Mark Haas, a former managing editor of BYTE, is technical director of Osborne/McGraw-Hill (2600 Tenth St., Berkeley, CA 94710).

EPROM PROGRAMMER & UV ERASER FOR THE 80's
S15 PROGRAMS OVER 300 DEVICE TYPES

MOS (8K - 256 K, SINGLE & 3 VOLTAGES) BIPOLAR PROMS, 40 PIN MICROS

- Stand Alone
- 256K Buffer (200 ns)
- Integrated keypad
- EPROM simulation
- Fast algorithm
- Power down sockets
- Temp compensated Ref. voltages
- 16 formats & 8 baud rates
- Auto-user friendly-mode



S15F \$995



BUV-IIA \$66.50

- Heavy duty
- Safety switch
- UV indicator

BUV-IIB \$95.50

- Heavy duty
- Timer
- Safety switch
- 110/220 voltage

OVER 26 FUNCTIONS

- Edit
- CRC Check
- Block Move
- Over Program
- Insert
- Delete
- 16 Diagnostic Functions
- And More!

(305) 994-3520

4089 S. Rogers Circle #7, Boca Raton, FL 33431



OTHER COMPLETE SYSTEMS

- S15R (remote) \$695
- S15P (4 key) \$795
- S15B (bipolar) \$895
- S15G (gang) \$1095

WRECK'EM RAM'EM RESCUE'EM

3 Thrillers
for the
game
players in
your family!

For the Apple®
Personal Computer.
Developed by Optimum
Resource, Inc. for Weekly Reader
Family Software, all 3 games are
available in finer computer stores
everywhere. Or call toll-free
1-800-852-5000. Dept. AC-18.

Chivalry, by Richard Hefter
and Steve and Janie Worthington. *Fat City* by Richard
Hefter and Steve Worthington.
and *Old Ironsides* by
Richard Hefter and Jack Rice
are registered trademarks of
Optimum Resource, Inc.
Apple and Apple II, IIe, II+
and III are registered trade-
marks of Apple Computer, Inc.

A/M28-M18

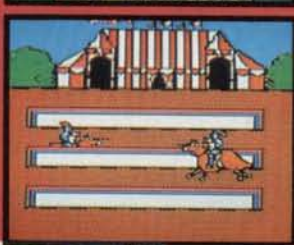
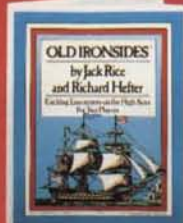
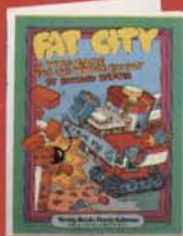

Fat City™

Knock down buildings in your wrecker while dodging bricks, rocks, cans and tomatoes. 10 rounds. Poster, stickers, user's manual, vinyl binder included. Ages 8 and up. Only \$39.95.

Old Ironsides™

Thrilling 2-player naval battle! Use the wind, cannons, compass to outwit rival ship. Detailed graphics recreate true sailing experience. Poster, log book, vinyl binder included. Ages 8 and up. Only \$39.95.

Chivalry™

The days of yore are recalled in this unique combination of board-game and computer game. Rescue the king by playing 20 animated games of skill — jousting, sword-play, etc. 1 to 4 players. Sturdy, colorful gameboard, playing pieces, poster, instructions. Ages 8 and up. Only \$49.95.

Weekly Reader
Family Software
A division of Xerox Education Publications
Middletown, CT 06457

DIGITAL BUILDS THE FINEST PERSONAL COMPUTERS YOU CAN BUY.

And after you buy them, nobody does more to make sure you'll be satisfied.

That's because Digital is the only major computer company that supports its promise of quality and commitment to customer satisfaction with a comprehensive investment protection plan.

This plan will minimize your risk. Relieve your concerns about owning a personal computer. And it's included when you purchase any one of Digital's Personal Computers, including the Rainbow™ and the new Rainbow 100+, from a participating dealer, distributor, or Digital Business Center.

Digital's Rainbow now lets you run the widest range of popular business software—including Lotus™ 1-2-3™, dBase II™, TK!Solver™, and Multiplan™.



With Digital's Rainbow, you can choose from hundreds of different software programs because only

Digital's Rainbow can run these five operating systems: MS™ -DOS, CP/M®-86/80, Concurrent CP/M,* and p-System.** That means you'll have access to the broadest array of solutions for your business, today and tomorrow.

The new Rainbow 100+. More storage and more main memory.



The Rainbow 100 is perfect for most businesses. But if you need more power, Digital introduces the Rainbow 100+. It lets you store the equivalent of 5,000 typewritten pages on a built-in 10 Mbyte hard disk. You'll also run the most advanced business programs faster and easier—thanks to 128 Kbytes of main memory, expandable to 896 Kbytes.

A wider choice of options and accessories, too.

With either Rainbow, you get a choice of monitors: white, green, amber, or high-resolution, full-color display. A choice of high-quality printers. A graphics



option that lets you create bar charts, pie charts, and line graphs. And more.

Including personal computer accessories and furniture custom designed by Digital to help you get the most out of your computer.

Call 1-800-DIGITAL.

Ask for the Rainbow desk and get more details on Rainbow and Digital's Investment Protection Plan.

Not even the world's largest computer company gives you so much. But the second largest does. Digital Equipment Corporation.

*Concurrent CP/M is available from Digital Research, Inc.
**p-System is a trademark of SofTech Microsystems, Inc.; available from Ticom, Inc.
Rainbow is a trademark of Digital Equipment Corporation.
1-2-3 and Lotus are trademarks of Lotus Development Corporation.
dBase II is a trademark of Ashton-Tate.
TK!Solver is a trademark of Software Arts, Inc.
Multiplan and MS-DOS are trademarks of Microsoft Corporation.
CP/M is a registered trademark of Digital Research, Inc.

AND NOW YOU CAN BUY THEM VIRTUALLY RISK-FREE.

digital™

Investment Protection Plan

This comprehensive plan is included with the purchase of every Personal Computer Digital makes – including the Rainbow™ Professional™ and DECmate™ II.

One-Year On-Site Computer Warranty.

Digital will provide limited warranty service including repair and replacement of defective parts wherever your computer is located in the Continental U.S.

One-Year Software Warranty.

Digital will provide limited warranty support for operating systems including updates to selected operating systems, documentation and replacement of defective media.

On-Site Options Warranty.

If you add any of Digital's personal computer options (including printers) at the time of system sale, these options will be covered by your one-year On-Site Computer Warranty. Options purchased after system sale are covered for 90 days.

One-Year "Hotline" Advisory Service.

Digital's toll-free "Hotline" Advisory Service will answer questions about operating systems, Digital Classified Software and general use. There's no extra charge, use this service as often as you like during the warranty period.

30-Day Money Back Return Policy.

Covers your entire Digital system, including Digital Classified Software and Digital options purchased at time of computer sale. Limited to one return per customer.

Offer expires January 31, 1984.



digital™

TK!SOLVER™

THE WORLD'S FIRST EQUATION PROCESSOR FOR PERSONAL COMPUTERS™

The TK!Solver™ program is a professional tool that allows you to work easily with equations. Whether your problem is a simple formula or a model consisting of many equations, TK!Solver can help improve your productivity. Once the equations are written, enter the known values, press the ! key, and TK!Solver gives you the answer.

Engineers, scientists, architects, financial analysts and planners, educators, researchers, and other professionals who use equations and mathematical models can work more creatively with TK!Solver.

TK!Solver provides you with:

BACKSOLVING

If the programs you use now require you to rewrite the same equation to solve for different unknowns, TK!Solver can dramatically improve your productivity. Enter your problem once and then solve for the unknowns no matter where they are in your equation.

ITERATIVE SOLVING

If TK!Solver can't solve an equation directly, take an educated guess at the answer. Type the ! key and the TK!Solver program starts with your guess and performs repeated approximations to converge on the answer.

LIST SOLVING

Given a list of input values, TK!Solver automatically calculates the equation for every value in

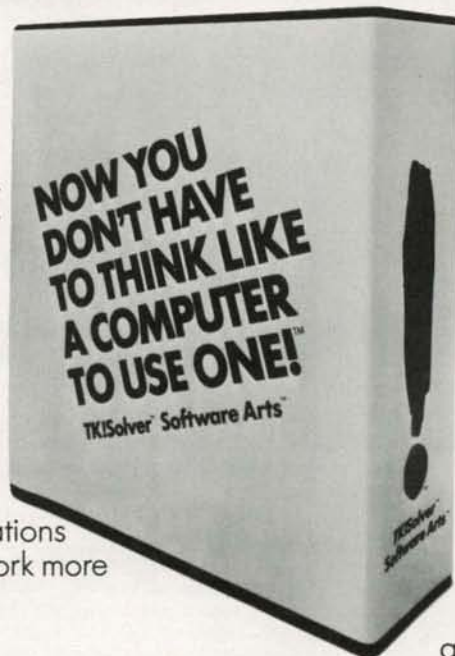

your list. For example, if you want to know how different interest rates will affect monthly loan payments, enter a list of interest rates and let TK!Solver calculate the payment amount for each value.

UNIT CONVERSIONS

Any type of unit conversion — Fahrenheit to Celsius, meters to feet, dollars to deutschmarks, newtons to dynes — can be made without altering your equations. Just define the numerical relationship between two units of measurement and the TK!Solver program automatically converts the variable value to the unit you specify.

TABLES AND PLOTS

Quickly generate tables and plots of your results on your screen or printer.

If you can define a problem mathematically, the TK!Solver program can help you find the answer. It's a flexible problem-solving tool that you can apply easily to a variety of mathematical problems.

AVAILABLE NOW

You can run the TK!Solver program on the IBM® PC and XT and compatible machines, the Digital™ Professional™ 350, the Digital™ Rainbow™ 100, the Wang Professional Computer, Apple® //e, and on the following personal computers using MS™-DOS: TI Professional Computer, GRiD Compass Computer,™ Canon AS-100, Eagle® 1600, Toshiba T300, and the Zenith Z-100.™

Software Arts™
The creators of VisiCalc® and TK!Solver™

TK, TK!, TK!Solver, TK!SolverPack, The Problem Cruncher, the stylized ! and the slogans "NOW YOU DON'T HAVE TO THINK LIKE A COMPUTER TO USE ONE!" and "THE WORLD'S FIRST EQUATION PROCESSOR FOR PERSONAL COMPUTERS" are trademarks or registered trademarks of Software Arts, Inc. TK!SATN and DIF are trademarks of Software Arts Products Corp. Software Arts is a trademark of Software Arts, Inc. and Software Arts Products Corp. The TK!Solver program and the TK!SolverPack applications packages are products of Software Arts, Inc., which is solely responsible for their contents. VisiCalc is a registered trademark of VisiCorp. GRiD Compass Computer is a trademark of GRiD Systems Corporation. Z-100 is a trademark of Zenith Data Systems. Eagle is a registered trademark of Eagle Computer, Inc. IBM is a registered trademark of International Business Machines Corporation. Wang is a registered trademark of Wang Laboratories Inc. Digital, Professional, and Rainbow are trademarks of Digital Equipment Corporation. Apple is a registered trademark of Apple Computer, Inc. MS is a trademark of Microsoft Corporation.

The Vamp DVM-1 Computer/TV Interface Kit

Interface a computer's video and audio outputs directly into a TV for enhanced picture quality

by Richard F. Gillette

The DVM-1 kit can help you overcome the display degradation that often disappoints users of systems employing an RF (radio-frequency) modulator to interface a computer's video output to a standard color television. The DVM-1 lets the computer's output bypass the TV's RF section; it applies the computer's audio and video outputs directly to the TV's audio and video amplifiers, eliminating the need for an RF modulator.

Shortly after I had purchased a computer for text and graphics applications, I became disappointed with the display quality of my RF-modulator/color-TV combination. I had no right to expect better; after all, a color TV's tuner and IF (intermediate-frequency) stages pass only a 4-MHz video signal to prevent interference among adjacent TV stations; even the cheapest black-and-white monitor has twice this bandwidth. Although the 4-MHz bandwidth is fine for TV, most computer text and graphics applications require a wider bandwidth to take advantage of their higher resolution capabilities.

To solve this problem I thought I could simply bypass the TV's RF section and connect the computer signal directly into the TV's

video amplifier. Right? Wrong. My TV, like most modern TVs, has its chassis connected directly to one side of the 110-V power line. TV manufacturers have eliminated the 60-Hz power transformer found on older models to make the new sets lighter and less costly. If I had input the computer's video directly into the TV, I would have burned out the computer and given myself a potentially lethal electric shock. Obviously, safety considerations dictate isolation of some sort.

My solution at the time (the DVM-1 was not yet available) was to purchase a bulky 110-V, 60-Hz isolation transformer and wire it permanently into the TV's line cord. The transformer would not fit in the TV, and when

it was close to the TV's picture tube, or CRT (cathode-ray tube), it distorted the picture. I then added a jack (with an integral switch) to connect the microcomputer's video directly to the TV's video amplifier. The TV had a video test point with a composite video signal at the same level as the computer; thus, no bias was required, and unplugging the computer automatically switched the CRT back to TV. The results were spectacular. It looked almost as good as any of



Photo 1: The DVM-1 kit, including the instruction manual.

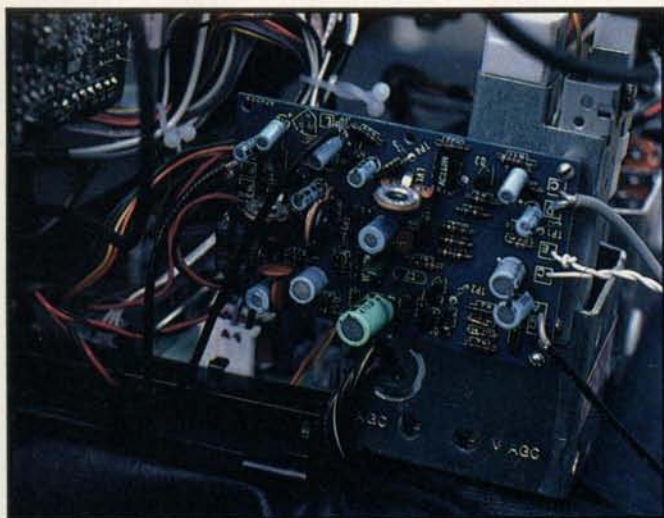

Photo 2: The assembled DVM-1 printed-circuit board, mounted in a TV. (All photos were taken by the author.)

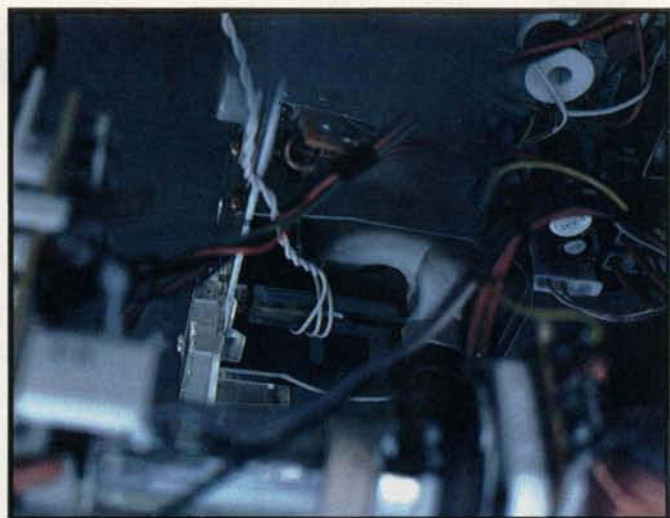

Photo 3: The flyback-transformer pickup coil (the white twisted pair in the center of the photo) that derives power for the DVM-1 board.

the composite video monitors I saw at the computer store. It was just as spectacular when used with a videocassette recorder.

I decided to upgrade the computer monitor from a 9-inch TV to a 12-inch Sony KV-1207 TV (my daughter was planning to take the 9-inch set to college). The larger TV required a larger isolation transformer, and while looking for this transformer I found the Vamp DVM-1. This kit provides all the circuits necessary to interface both the computer or videocassette recorder and audio directly into the TV. The required isolation is provided by a pair of optoisolators, one for video and one for

audio. The conversion fits inside the TV and requires no bulky isolation transformer.

The optoisolator consists of a light-emitting diode (LED) coupled optically to a photo diode. The isolator can couple signals across a 3-kV potential difference, much more than is required for the TV set.

Another feature of the DVM-1 kit is that it uses the TV's flyback transformer to supply power for the optoisolator LEDs and their drivers, eliminating the need to take power from the computer (or videocassette recorder) or to provide a separate power supply.

The kit comes in a small box complete with all parts

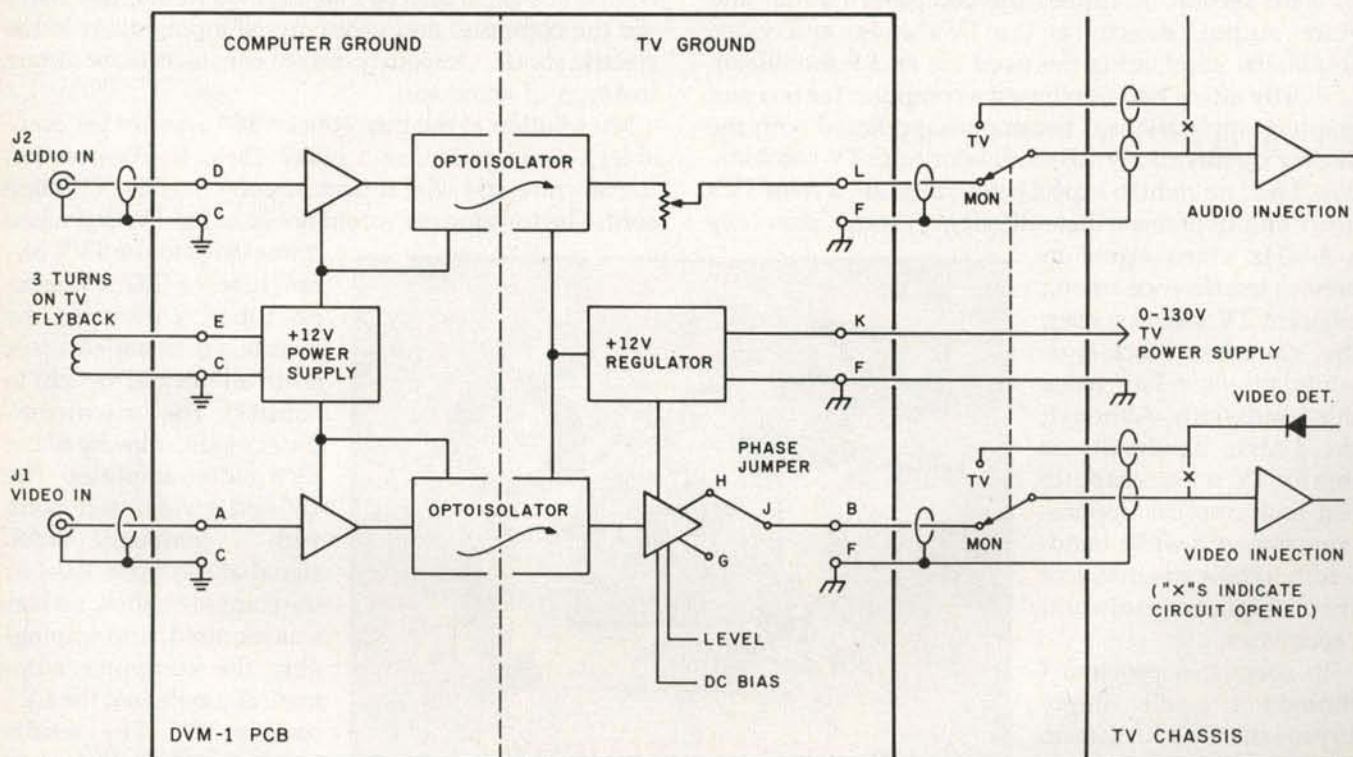

Figure 1: The DVM-1 block diagram, showing interface wiring.

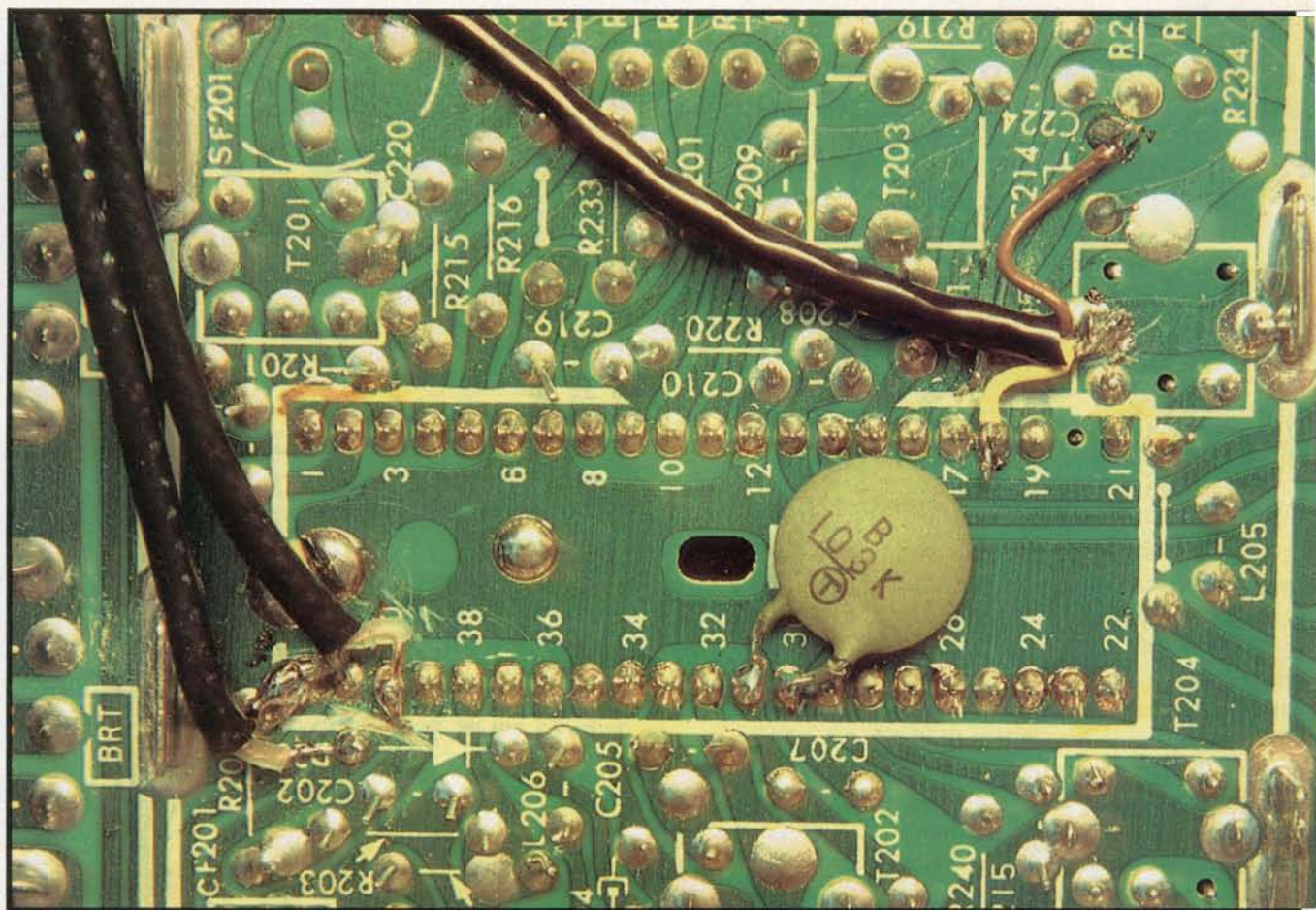

Photo 4: Video and audio connections to the TV.

and straightforward instructions (see photo 1). Only one printed-circuit board is involved; you just follow the parts list and insert the components into a well-marked board, solder, and trim the leads. You have to provide your own solder. The assembled printed-circuit board as mounted in my TV set is shown in photo 2.

Figure 1 shows the DVM-1 block diagram and the TV interface wiring. The combination of optoisolators and use of the TV's flyback transformer for the power supply to drive them provides complete isolation of the computer from the TV. The computer's video and audio signals are coupled across this interface (the dashed line on the block diagram in figure 1) by a light beam. No RF modulator is used, and thus cross-hatch interference due to modulator operation is eliminated from the other TVs in my home. The DVM-1 provides independent video and audio level settings and includes an adjustable bias supply for the TV's video; this feature allows an easy interface to TVs that have their video detector operating at a DC (direct current) voltage offset from ground. I needed this feature to use the DVM-1 with my Sony. (See "Add A Video Input to Your TV," *Radio-Electronics*, April 1983, for more technical details.)

Included with the kit are insulated jacks and a switch. The switch allows easy selection of either monitor or TV operation.

After the printed-circuit board is assembled, the next step is interfacing with the TV set. For this task, the DVM-1 manual provides a wealth of information. However, if you are not qualified to service your TV set, you will need help. If you are qualified or if you have a friend who is, you will have few, if any, electrical problems. The manual provides a good section on checking the kit. All parts are covered by warranty. Your challenge will be mechanical: where to mount the board, the input jacks, and the TV/monitor switch. The kit's small size enables it to fit inside any TV suitable for use as a monitor.

I am tempted to go into detail on the installation; however, each TV will pose unique requirements. My Sony KV-1207 installation is best described with pictures: photo 2 shows mounting details, and photo 3 shows the flyback-transformer pickup coil (the white twisted pair in the center of the photo) that derives the DVM-1's power. As you can see, installation was easy once I decided where to mount the hardware and route the wires. Photo 4 shows the video and audio wiring to the TV. You can see the cut video-printed circuit trace between the two coaxial cables (the audio trace that was cut cannot be seen in this photo).

After I installed the interface and adjusted the video and audio gain and the DC offset (simple procedures explained in the manual), I found that I wanted to touch

Listing 1: A color dot-generator program written in Applesoft.

```
10 REM COLOR DOT GENERATOR
11 REM * TO EXIT TYPE *
12 REM * CTRLC RETURN *
13 REM * TEXT RETURN *
14 REM R.F.GILLETTE 9/25/83
20 HGR2
30 HCOLOR= 3
40 FOR X = 0 TO 279 STEP 8
50 FOR Y = 0 TO 191 STEP 8
60 HPLLOT X,Y
70 NEXT Y
80 NEXT X
90 END
```

up the TV's convergence. I followed Sony's instructions using a software-programmed dot generator. The program for an Applesoft dot generator is provided in listing 1. At my wife's urging I adjusted the TV's color so the white would appear more green, as she finds green easier on her eyes. Color monitor owners may want to try this; all that is required is to turn down the red and blue CRT drive controls.

While giving the interface a thorough checkout, including a number of RF modulator to DVM-1 comparisons, I found horizontal instabilities on large-area graphics displays output from my Apple II. The top of the graphics display had a wave (horizontal displacement), as photo 5 shows. This large-area graphics display was generated using the program from listing 1, modified by changing the step size in lines 40 and 50 from 8 to 1. Close examination revealed that the wave could appear with either the RF modulator or the DVM-1. The AC (alternating current) coupled video signal from large-area graphics upsets the DC-restore circuits in some TV sets because the sync level (most negative level) is close to the level of the video signal preceding it. This small level difference can be seen on a scope, as photo 6 shows.

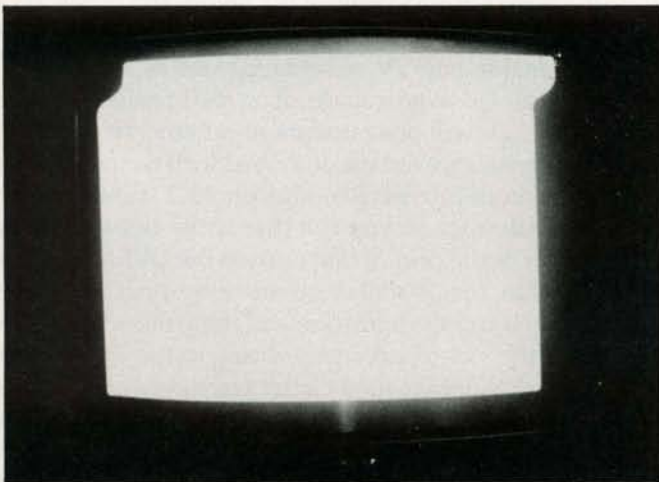

Photo 5: A horizontal instability accompanying a large-area graphics display.

At a Glance

Name

DVM-1 kit

Use

Converts a television set into a composite video (not red-green-blue) computer/videocassette record (CPU/VCR) monitor while retaining the TV function

Manufacturer

Vamp Inc.
POB 411
Los Angeles, CA 90028

Dimensions

2½ by 4 inches single-sided printed-circuit board

Price

Complete kit: \$64.95 plus \$2.00 shipping (\$4.00 foreign)

Features

Provides wide-band video and audio channels that are isolated from a hot TV chassis; uses two optoisolators

Tools Needed

Soldering iron, screwdriver, drills (10-, 7-, and 4-mm or 3/8-, 1/4-, and 1/8-inch), voltmeter, wire cutter, and schematic of TV set

Documentation

10-page manual

One solution to this problem involves a simple modification to the Apple II, and it works with both the RF modulator and the DVM-1. The video, sync, and color-burst signals are summed at the base of the Apple II's video-output transistor (Q3), which is connected as an emitter follower. Adding a fourth summing resistor (5.6K Ω , 1/4W) from Q3's base to +5V increases the amplitude of the sync pulse, solving the instability. I called Apple and the person I spoke with stated that the change is not approved by Apple; hence, such modifications to your Apple will be at your own risk.

How well does the DVM-1 coupler work? Judge for

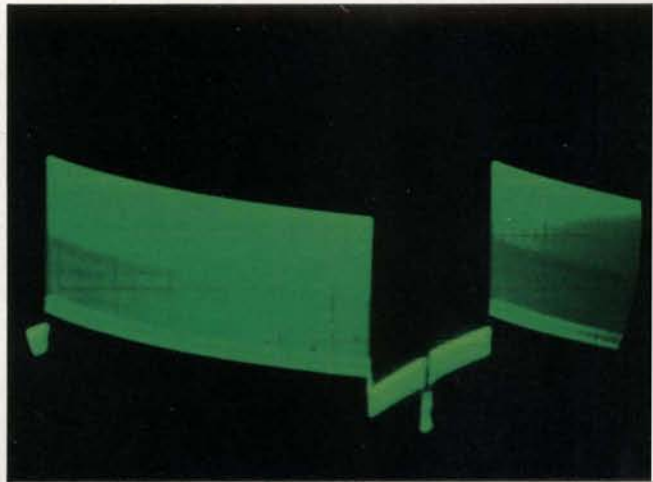

Photo 6: A scope photo showing a large-area-graphics video signal.

Buy Hardware/Software at Wholesale, And Save On Software Rentals, As A NETWORK™ Member Only!

Save hundreds of dollars when you buy DIRECT from America's Number 1 Computer Buying Service at just 8% above DEALER WHOLESALE PRICES, plus shipping.

Members receive The Personal Computer NETWORK's Giant Catalog featuring thousands of products and the lowest prices on the widest selection of computer software and hardware in the nation!

RENT BEFORE YOU BUY—Members are eligible to join The NETWORK's Business and Game Software Rental Libraries for a much smaller fee than other software rental services. And The NETWORK's rental charges are far less — just 20%-25% of the Member WHOLESALE PRICE!

Join The NETWORK today for as low as \$8 for one year (or \$15 for two years) and receive all these exclusive, money-saving benefits:

- REAL BUYING CLOUT**—Buy at just 8% above DEALER WHOLESALE PRICES, plus shipping. (On credit card orders there is a 3% service charge.)
- CONVENIENT SHOP-AT-HOME CATALOG**
- KNOWLEDGEABLE SERVICE CONSULTANTS**
- FULLY INSURED FAST HOME DELIVERY**
- OPTIONAL BUSINESS SOFTWARE RENTAL LIBRARY**—Members join for just \$30 per year in addition to the basic membership fee. Rent business software at just 20%-25% of The NETWORK's low prices for a 7-day period (plus a 3-day grace period for return shipping). 100% of your rental fee applies towards purchase.
- OPTIONAL GAME SOFTWARE RENTAL LIBRARY**—Members join for just \$10 per year in addition to the basic membership fee. All the same conditions apply as for benefit five.
- SPECIAL SAVINGS BULLETINS**—Save even more on limited-quantity merchandise!
- DISCOUNT COMPUTER BOOK LIBRARY**—Save up to 50%!
- MEMBERSHIP SATISFACTION GUARANTEE**—If you are not satisfied, notify us within 30 days to receive a 100% money-back refund.
- PRODUCT SATISFACTION GUARANTEE**—If you are not satisfied with any hardware, return it within 15 days for a 100% money-back refund.

All items subject to availability, prices subject to change without notice.
Copyright ©1983, PC NETWORK INC.

Low prices, fast home delivery and two software rental libraries are only the beginning! The NETWORK is your source for everything from memory chips to mainframes—and it's all just 8% above wholesale, plus shipping.

HARDWARE

Monitors (color and monochrome)
Printers
Complete Systems
Disk Drives (full/half height, add-on/add-in)
Multi-Function Boards
Graphics Boards
Modems
Local Area Networks
Memory Chips (all speeds available)
S-100 Components

SOFTWARE (rent or buy!)

Business	Scientific
Recreational	Data Bases
Compilers	Educational
Word Processors	Graphics
Utilities	CP/M-MS/DOS

SUPPLIES & ACCESSORIES

Blank Diskettes (all formats)
Paper Stock
Ribbons
Print Wheels
Cables
And More!

Choose hardware and software from hundreds of manufacturers, including:

- | | |
|--------------------|-----------------------|
| • Altos | • MicroPro |
| • Amdek | • Microsoft |
| • Apparat | • Morrow |
| • AST | • Motorola |
| • Ashton-Tate | • NEC |
| • Atari | • Northstar |
| • CDC | • Okidata |
| • Coleco | • Peach Tree |
| • Columbia | • Princeton |
| • Commodore | • Quadram |
| • Corona | • Sanyo |
| • Cromemco | • Sierra On-Line |
| • DEC | • Software Publishing |
| • Digital Research | • Softword |
| • Eagle | • Tandon |
| • Epson | • Tecmar |
| • Franklin | • Texas Instruments |
| • Hayes | • Toshiba |
| • IBM | • Visicorp |
| • IUS | • Zenith |
| • Lotus | |

SAVE ON UPGRADES!

NETWORK SPECIAL

Disk Drive	Retail	Wholesale
Two Tandon	\$574/	\$350/
TM 50-2 Half	pair	pair*
Height DS/DD		
	Retail	Wholesale
64K Chips	\$11 each	\$5.10 ea.*

*NETWORK Members pay just 8% over the wholesale price, plus shipping.

SPECIAL V.I.P. MEMBERSHIPS

Available at \$15 per year or \$25 for two years. V.I.P. Members receive additional benefits:

- BOTH SOFTWARE RENTAL LIBRARIES** FOR \$35 in addition to the V.I.P. membership fee.
- EXTENDED 10-DAY SOFTWARE RENTAL PRIVILEGES** (plus 3 days for return shipping).
- ADVANCE NOTIFICATION OF SPECIAL SAVINGS BULLETINS.**

CALL TOLL FREE

1-800-621-S-A-V-E

In Illinois call (312) 372-4488

Your Membership Validation Number: D777
You can validate your membership number and, if you wish, place your first money-saving order over the phone by using your VISA, MASTERCARD or AMERICAN EXPRESS. Our knowledgeable service consultants are on duty Mon-Fri 8 AM to 7 PM, Sat 9 AM to 5 PM CST.

Call now...Join the PC NETWORK and start saving today!
PC Network
180 N. Michigan Ave.
Chicago, IL 60601

THE NETWORK - MEMBERSHIP APPLICATION

YES! Please enroll me as a member in The NETWORK™ and rush my catalog featuring thousands of computer hardware and software products, all at just 8% above DEALER WHOLESALE PRICES. I will also receive all the other exclusive, money-saving services available to Members.

I am under no obligation to buy anything. My complete satisfaction is guaranteed.

Please check (✓) all boxes that apply:

- Basic Membership**
- One-year membership for \$8
 Two-year membership for \$15 (SAVE \$1)
 Business Software Rental Library for \$30 add'l. per year—members only
 Games Software Rental Library for \$10 add'l. per year—members only

- Special V.I.P. Membership** 717
- One-year membership for \$15
 Two-year membership for \$25 (SAVE \$5)
 BOTH Business and Game Software Rental Libraries for \$35 add'l. per year—V.I.P. members only
 Bill my credit card: VISA MasterCard American Express
- Exp. Date _____ mo. year

Account Number: _____

Check or money order enclosed for \$ _____

Name _____

Address _____ Apt. No. _____

City _____ State _____ ZIP _____

Telephone (_____) _____

My computer(s) is: IBM PC Apple II TRS-80

Atari Commodore Other _____

Signature _____

(Signature required to validate membership)

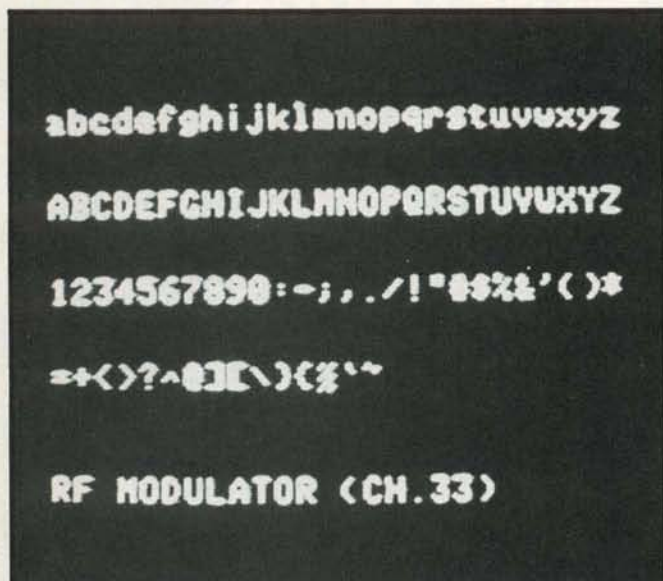

Photo 7a: Forty-column text displayed on a TV screen via an RF modulator.

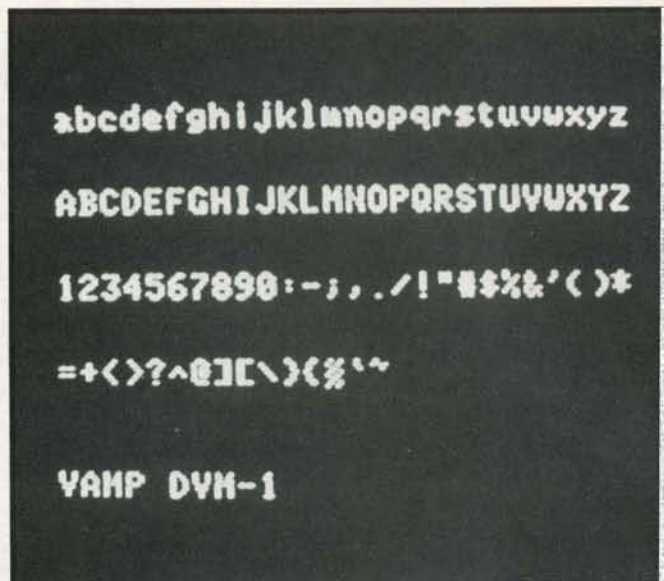

Photo 7b: Forty-column text displayed on a TV screen via the DVM-1.



Photo 8a: A color-graphics display interfaced to a TV via an RF modulator.



Photo 8b: The same color-graphics display interfaced to a TV via the DVM-1.

yourself. Photos 7a and 7b show 40-column text with the RF modulator and the DVM-1, respectively. The DVM-1 provides a bandwidth in excess of 8 MHz; mine extended past 10 MHz. These photos show the bandwidth/resolution improvement. Photo 8 shows high-resolution color graphics from the game Mad Rat (Phoenix Software), first via the RF modulator (photo 8a), then via the DVM-1 (photo 8b) (the TV was adjusted for as close a color balance as possible). The shadow mask on the screen of the color CRT reduces resolution, and TV video circuits can also reduce bandwidth. The Sony can almost, but not quite, let you use 80-column video with the DVM-1 adapter. (I tried a wider band video input and obtained the same results; the TV is the limitation.) Adding the DVM-1 to a black-and-white TV will allow 80-column operation. As you can see from the photos, my converted color TV set has the video quality of an

expensive composite video monitor. The kit also provided me with an audio channel including volume control.

When considering the upgrade of a TV to a monitor, I recommend that you consult the TV's manual to make sure you understand the video and audio circuits before you invest in the DVM-1. If you do understand the circuits, then I wholeheartedly recommend this kit. One note of caution: the TV set's warranty may be voided by this monitor conversion. (My applause to Vamp, as it noted the warranty problem in its manual.) A letter to the TV manufacturer, however, may get you conversion approval. In any case, most warranties do run out. ■

Richard F. Gillette (311 W. Daniels Rd., Palatine, IL 60067) is an engineering manager with Northrop Corporation's Defense Systems Division. He holds both a B.S.E.E. in communications and an M.B.A. in operations research.

Dow Jones Has Powerful Connections.

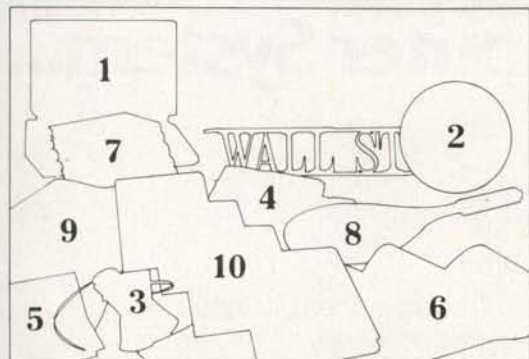

1. Your personal computer.*
2. Up-to-date world and national news.
3. Current and historical stock market quotes.
4. Business and economic news from The Wall Street Journal, Barron's and the Dow Jones News Service.
5. Detailed financial information on over 3,000 companies and 170 industries.
6. Abstracts from SEC filings on more than 6,000 companies.
7. Articles from the Academic American Encyclopedia.
8. Sports and weather reports.
9. Movie reviews, summaries and ratings.
10. Dow Jones Software™ — investment products for analysis and management of financial information from Dow Jones News/Retrieval® (available separately)*.

The Dow Jones Connector™ gives you immediate access to all Dow Jones News/Retrieval data bases through your personal computer and a modem. Dow Jones News/Retrieval is the nation's leading online information service. When you purchase the Dow Jones Connector, you receive a value of over \$100: a free password, our user's guide — the Dow Jones News/Retrieval Fact Finder, an hour of free usage on Dow Jones News/Retrieval and a \$25 coupon good toward the purchase of an investment software product: the Dow Jones Market Analyzer™, Dow Jones Market Microscope™ or Dow Jones Market Manager™.

Available at selected computer stores. Suggested retail price: \$49.95.

*For compatibility, check with your local computer dealer.

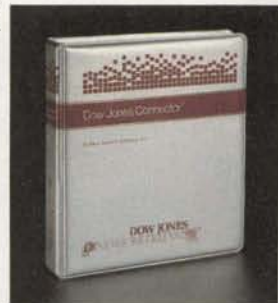

Dow Jones Connector™

Easy Access to Dow Jones News/Retrieval

For more information on Dow Jones Connector, call

800-345-8500 ext. 48

(Alaska, Hawaii and foreign call 215-789-7008 ext. 48)

Circle 138 on inquiry card.

Copyright ©1983 Dow Jones & Co., Inc. All rights reserved.



VISUAL 1050 Personal Computer System.

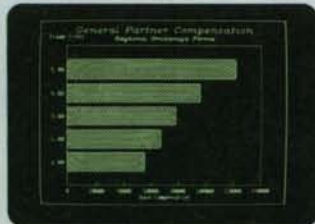

Complete Solution

The VISUAL 1050 is an advanced personal computer system designed especially for managers and professionals. It comes complete with top-rated software and high-performance hardware ... all fully configured for easy set-up and simple operation. The VISUAL 1050 costs much less than other full-feature personal computers and comes with everything you need to tackle important professional jobs, right out of the box.

Words, Numbers and Graphics

The VISUAL 1050 solves more professional problems than any other computer in its class. Whether you work with words, numbers, or graphics, the VISUAL 1050 speaks your language. You get *WordStar*,[™] *MailMerge*,[™] *Multiplan*[™] and Digital Research's *DR Graph*[™]... leading software packages for word processing, spreadsheet and graphics. And all have been specially adapted to share data and perform as an integrated software family.

	VISUAL 1050	IBM™ PC	Apple™ IIe	TRS-80™ Model 12	DEC Rainbow™
Base System Price ¹	\$2,695	\$2,750	\$2,390	\$3,999	\$3,495
Serial Port (RS232)	STANDARD	\$119	\$195	2 STANDARD	2 STANDARD
Parallel Port	2 STANDARD	\$119	\$180	2 STANDARD	STANDARD
Bit-Mapped Graphics	STANDARD	\$240	STANDARD	\$499	\$845
Word Processing Software	STANDARD	\$200-\$500	\$200-\$500	\$399	\$200-\$500
Spreadsheet Software	STANDARD	\$200-\$300	\$200-\$300	\$299	\$200-\$300
Business Graphics Software	STANDARD	\$200-\$400	\$200-\$400	\$200	\$200-\$400
Communications Software	STANDARD	\$100-\$200	\$100-\$200	\$100	STANDARD
COMPLETE SOLUTION PRICE	\$2,695	\$3,928-\$4,628	\$3,465-\$4,165	\$5,496	\$4,940-\$5,540
Dual Drive Capacity	800 KB	640 KB	280 KB	2.5 MB	800 KB
Graphics Resolution	640 x 300	640 x 200	280 x 192	640 x 240	800 x 240
Keys on Keyboard	93	83	63	82	105
Expandable Memory	YES	YES	YES	YES	YES
Optional Winchester	YES	YES	YES	YES	YES
Tilt and Swivel Display	YES	NO	NO	NO	NO

1—Includes CPU, 64K User Memory, Keyboard, Display, Two Disc Drives, and Operating System.
Based on manufacturers' information available August, 1983. VISUAL 1050 includes 128K User Memory standard.

the complete professional solution at an unbeatable price.

Communications, BASIC and More . . .

You get *Terminal Emulation* software which turns your VISUAL 1050 into a powerful ASCII terminal for dial-up access to remote computer resources. And you get *CBASIC*® for custom programming applications. *CP/M Plus*®, a new and improved release of CP/M, allows your VISUAL 1050 to support hundreds of popular third-party packages.



Unbeatable Value

\$2,695 is the total retail price for the VISUAL 1050. You get the best and most popular software packages, ready to run on hardware which offers the features and quality you should demand. Two high capacity disc drives. 128K memory standard, expandable to 256K. Fast, bit-mapped graphics. Full size green screen. Standard printer and communication ports. Rugged 93-key keyboard with special WordStar engravings. You can't buy a more complete hardware and software solution at anywhere near the price.

VISUAL

 See for yourself

Visual Technology Incorporated
540 Main Street, Tewksbury, MA 01876
Telephone (617) 851-5000. Telex 951-539

Circle 477 on inquiry card.

We're "Customer Friendly"

We're Sun Software. We're new and we're ready to start treating you like a valued customer—not just a voice on the telephone.

And we're convenient, too. Just call our toll-free number to order any one of over 2000 titles and more than 90 formats. Plus we guarantee that our prices are absolutely the lowest you'll find anywhere.

We'll take your order and get it to you in 5 days or less—virtually anywhere in the world. And if you're in the U.S., you'll never pay for shipping.

So call us to access the most in service, the best in selection. We're going to make "customer-friendly" state-of-the-art.

	SALE
NEW SUPERCALC 3	\$295.00
DBASE II	\$385.00
WORDSTAR	\$278.00
LOTUS 1-2-3	\$295.00
MULTIPLAN	\$168.50
D-BASE TUTORIAL	\$ 50.00
BASIC-80	\$239.00
MOVE-IT	\$ 92.50
QUICKCODE	\$185.00
PASCAL MT +	\$240.00

Call 1-800-222-7393

(In California call: 1-800-722-6284)

TELEX: 215604 PCS UR ATTN: Sunmicro

By modem: (213) 458-9209

Sun Software

1344 Fourth Street.

Santa Monica, CA 90401

TERMS: Shipping by UPS Surface, US Mail. Call for UPS Blue or next day delivery.
C.O.D., Check, Master Card and Visa accepted. California residents add 6% tax.
Los Angeles County residents add 6.5% tax.

**SUN
SOFTWARE™**

A division of Sunmicro Electronics, Inc.

©1983 Sunmicro Electronics, Inc.

The Einstein Compiler

This Applesoft BASIC compiler also serves as a helpful programming tool

by Peter Callamaras

The Einstein compiler, one of several BASIC compilers for Apple computers, is both easy to use and effective. Although other compilers claim they can provide compiled programs that run 2 to 20 times faster than their Applesoft BASIC counterparts, they cannot reveal what they're doing during compilation, nor can they do anything other than compile programs.

The Einstein, however, is not only a BASIC compiler: it's a useful programming tool as well. It provides a great deal of statistical information about the programs it compiles, and, when you enable the line-trace mode, you can also use it to debug a program.

The major task of a BASIC compiler is to convert a program written in BASIC into an equivalent assembly-lan-

guage program. Much of the conversion performed by Applesoft compilers is based on a series of calls to routines in the Apple's monitor. By eliminating the need to interpret each line of program code, the compilation reduces program execution time.

Size vs. Speed

Although compilation speeds program execution, it also increases the size of the original program. The Einstein compiler, however, uses a code-compression technique to limit this increase; nevertheless, its compiled versions may be twice as long as the BASIC programs it began with. If the program is very large or made up of a series of modules, then the modules can be compiled and chained as a set of integrated modules. Modular programs are useful if you wish to later enhance certain parts of the program: you need only compile new modules to replace the ones you want to change. The manual explains this feature well.

The code-compression feature can be disabled, but program size will then increase dramatically in some cases. In one workout I gave the compiler, the original program took 5 sectors, the compressed compiled program filled 12, and the uncompressed compiled version 20. I prefer to use the compressed version.

Many manufacturers claim that their compilers provide twentyfold speed increases, but you can reasonably expect a compiled program to run about five to six times faster than the original BASIC program. I realized an approximate fourfold increase in execution speed each time I used the Einstein compiler. To make your own comparison, load a program on a cassette tape into the computer and then load the same program from a disk. The difference in the time you saved using a disk drive is about the same as the time you'll save running a compiled version of your BASIC program.

At a Glance

Name

The Einstein compiler

Type

Applesoft BASIC compiler

Manufacturer

The Einstein Corporation
11340 W. Olympic Blvd.
Los Angeles, CA 90064
(213) 477-4539

Price

\$119

Computer

Apple II/II Plus/IIe 48K bytes
Apple III in emulation mode
One 5¼-inch disk drive

Format

5¼-inch DOS 3.3 disk
Free backup disk upon return of warranty card

Audience

Novice or experienced Applesoft programmers interested in speeding up BASIC programs

Number of Primes Used	BASIC Program's Execution Time (seconds)	Compiled Program's Execution Time (seconds)
55	63.95	11.21
1006	132.7	28.07
1437	210.09	42.91

Table 1: This data compares execution times for an Applesoft BASIC program with a version compiled with the Einstein compiler. Data collected from three tests using the Sieve of Eratosthenes benchmark prime-number program show that the compiled program runs about five times faster than the original.

Ease of Use

To compile your first program, simply

1. Load the BASIC program into memory.
2. Insert and run the Einstein program.
3. Press "Y" (for yes) to accept the standard Einstein parameters.
4. Save the compiled program.

That's all there is to it. The compiled program can be listed, but you will see only one line of code: 1 Call 4864. This line will start the compiled program running.

To test the time savings and size differences between BASIC programs and their compiled versions, I first ran a program I use to predict winners in professional football games. I have always been frustrated by the length of time it takes the program to determine the point spread and predict a winner when the program already has information from the preceding four or five games on which to base a decision. I selected six teams and had the program predict winners of the three games.

A BASIC program averages 23 seconds to figure a winner and point spread. The compiled version of that program (the compilation took about 65 seconds) calculated the point spread and predicted the winner in 5.3 seconds. For calculations on 28 teams (14 games), the waiting time decreased from 322 to 74.2 seconds—a 77 percent time savings.

The second test I ran was based on the Sieve of Eratosthenes benchmark prime-number program (featured in January 1983 *BYTE*, page 283). I decided not to run the full 8192 prime numbers and instead ran three tests: one with 55 prime numbers, another with 1006, and a third with 1437. The time savings, shown in table 1, were substantial. The execution rate of the compiled version was about five to six times faster than that of the original. The program did, however, expand from 3 sectors in the original to 15 sectors in the compiled version.

Compiler Components

The Einstein compiler disk contains three separate binary programs. The first is the Einstein program itself, which compiles the programs. The second program, Remark Remover, is a utility program used to remove remarks from the BASIC program before it's compiled. Because a program is converted from Applesoft into assembly language, the compiled program does not need the extra code required by the Remark statements. The third program, Remake Compiler Disk, is a special utility used to reconstruct the Einstein compiler should it be "blown up" through a destructive error. You can "destroy" the compiler by accidentally putting a write-protect tab on its disk and then attempting to use it, or by pressing the Reset key while the compiler is running.

If you damage the disk, contact the manufacturer for a replacement. When you send in the 90-day-warranty registration card, Einstein Corporation will send you a free backup disk. The compiler disk is copy-protected, not write-protected, because it constantly reads and writes to itself while compiling a program.

While you are compiling a program, various statistics concerning the compilation process appear on the video display. The compilation is carried out in several phases. In the analysis phase, variables are analyzed and stored, and the syntax of the program is checked. If a syntax error is detected, you can ignore it and continue the compilation or you can stop immediately. The Einstein software will compile a program with syntax errors in it. When I tried an "incorrect" program, it compiled and ran until the syntax error was encountered. After the analysis, the program stops and asks whether you wish to use any particular parameters.

The program then proceeds to the next phase, where the variables are defined in a symbol table, which you can examine for information about the assembly-language program being created. Specifically, the symbol table provides the name of each variable function in the original program, truncated to two characters. You also get a one-character display of the variable type. Real numbers are represented with a blank, integers with a percent sign, and strings with a dollar sign. A defined function is displayed as an asterisk. The hexadecimal address of the first byte of each variable (or variable array) is also provided. Next to the address, the length of the array, or variable, is expressed in hexadecimal units. Three special notes include 17-byte For . . . Next loops, defined functions of 8 bytes, and fixed-length strings that are 1 byte greater than their specified size. Information on dimensioned arrays is also included.

The program then proceeds into the compression analysis phase and creates a set of compression optimization tables. The final phase handles code generation, where the compiled code is generated and stored on the compiler disk. While the program prints each line number as it is compiled, a running tally of the percentage of source code compiled is reported. (You can compare this data with the compiled information in the symbol table.) Any address reference problems are then re-

solved, and the full compilation statistics are displayed on the screen.

The compilation statistics include information on the amount of space occupied by the compiled program, the area used by any global variables, the local area used by local variables, and the area reserved for use by dynamic strings (called the string pool). Other displayed information details additional facets of the compiled program. The compiler also creates a run-time library to get the compiled program up and running. The library consists of a set of machine-language routines the program uses when it runs. The amount of space saved by using the compression feature is also indicated.

The last phase of the compilation is the resolution of relocation information, of interest mainly to experienced programmers.

Once the compilation is finished, the program resides in memory, ready for you to run immediately or to save on disk. (I always save a program before running it.) Be sure you give the compiled program a different name than that of the original source program (I add the suffix .com), because once you overwrite the original BASIC source code, it is lost unless you have a backup copy. Some restrictions apply if you use relocatable code (these are covered in the user's manual).

A set of available compiler parameters covers the assignment of the printer slot, string information, addresses for the program, strings, different variable types, line tracing, code compression, reserved memory, loops, display addresses, and pause on errors.

The printer-slot parameter allows you to get a hard-copy printout of the compilation information for later use. You can select the other parameters depending on the program you are compiling and/or your use of the compiler for debugging purposes, such as enabling the line-trace mode. The manual details each of the parameters.

You can place certain embedded compiler directives inside the compiled program. They are a series of special annotated Remark statements that are not removed from the source code as are normal Remark statements. For instance, you could use one of the special Remark statements to call an uncompiled subroutine from within the compiled program. Other directives are available for the advanced programmer; these are thoroughly explained in the manual.

The manual is well-written and packed with information. It will be of help to both the novice and experienced programmer. The manual has a table of contents, an index, and an error-message section. It covers each compiler feature in separate task-oriented chapters. A set of sample tables illustrates the use of the symbol table and a set of sample programs permits practice compiling.

Conclusion

The Einstein compiler is an excellent program for converting Applesoft BASIC programs into assembly-language equivalents. It is easy to use, requiring only

three steps to compile a program (if the user does not take advantage of the special parameter settings available). This ease of use has prompted me to use this program to compile all my BASIC programs to obtain faster execution speeds.

The Einstein compiler is packed with features to support use by both experienced and novice programmers. The parameter settings, for example, should accommodate the needs of any programmer. In addition, a comprehensive set of compilation statistics provides details about the compiled program.

Programs compiled with the Einstein software exhibit speed increases five to six times over those of their Applesoft BASIC counterparts. The user's manual is well written. In fact, it would make a good model for documentation writers to follow.

This compiler can be useful for all owners of Apple computers, even those who don't do much programming. It can speed up their BASIC programs and it might even encourage them to start programming in BASIC. Thus, it gives users the best of both worlds, easy programming in BASIC combined with the speed that assembly language affords. ■

Peter Callamans, an officer of the Air Force, can be reached at AFCC/EPPE, Scott AFB, IL 62225. The recipient of degrees in computer technology and biological sciences, he recently received his master's degree in systems management. He has been interested in computers since 1966 and used to be the service department manager of a computer store.

DECADES OF SERVICE FROM THE NATION'S LARGEST NEC DEALER

NEC THE PERFECT SOLUTION

Advanced Personal Computer

PC-8800

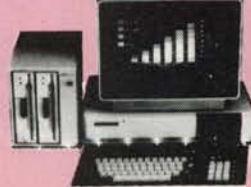

INCLUDED:

- Comprehensive Business Software
- High Resolution Graphics
- 8 & 16 Bit Power
- Built-in Reliability
- User Friendly

PC-8200 portable computer



- Low Prices
- Support
- Service
- Leasing
- Exporting

NEC, IMS, MORROW ON GSA
& N.Y.S. OGS CONTRACTS

Washington Computer Services

97 Spring Street
N.Y., N.Y. 10012

(212) 226-2121

an affiliate of
WASHINGTON
ELECTRIC COMPANY
EST. 1912

HOURS: 9 AM-5 PM / Monday-Friday TELEX: 12-5606 CABLE: WASHCOMP NYK

PLEASE! Do not confuse us with mail order dealers. We are a full service distributor serving the data processing & installation needs of business and industry from micros to mainframes. System houses, educational institutions & governmental agencies given special consideration. Dealer and international inquiries welcome.

MASTER THE "NEW ELECTRONICS" WITH MCGRAW-HILL'S Contemporary

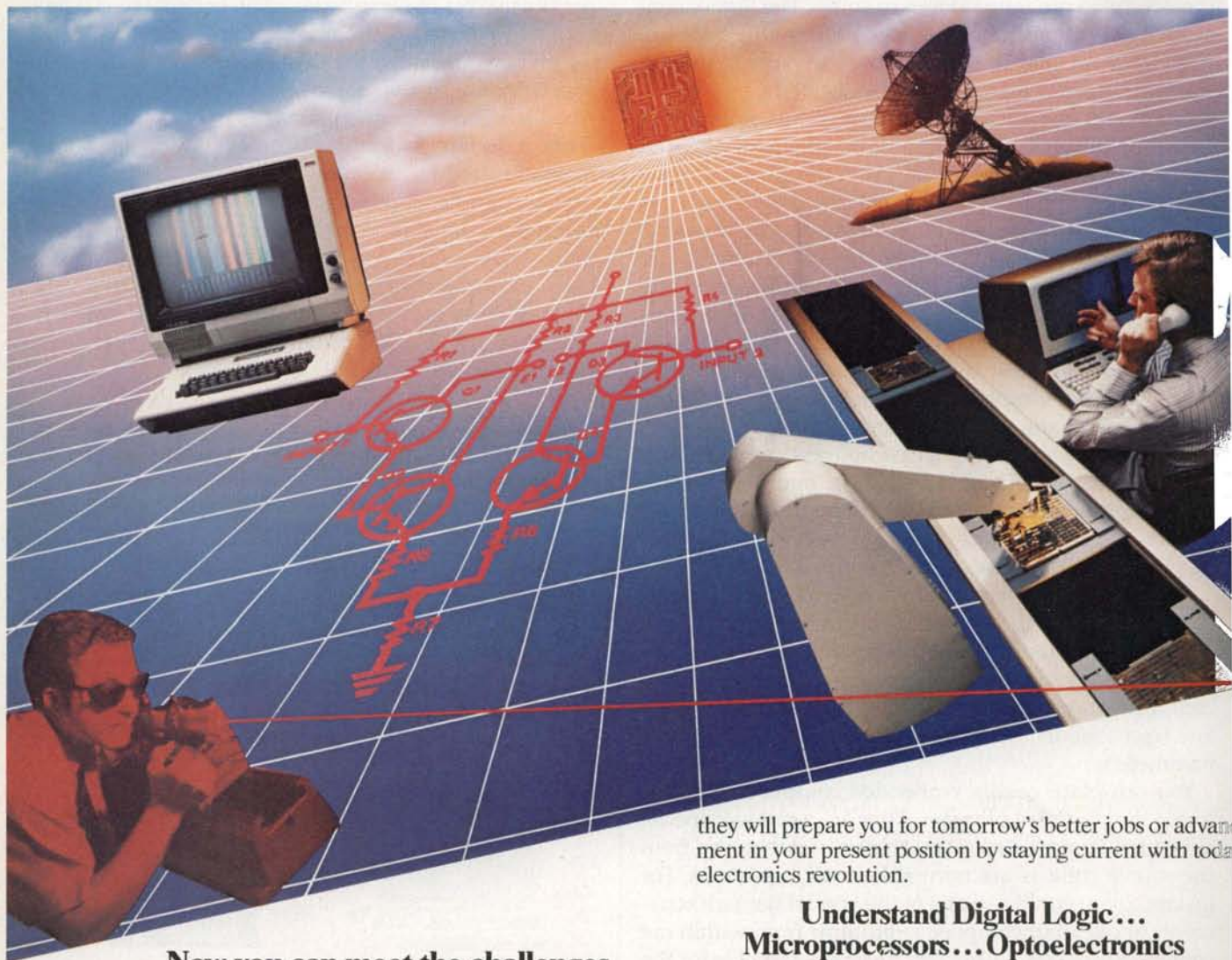

Now you can meet the challenges of today's incredibly rapid changes in electronics quickly and easily. This professional level electronics learning series is as innovative as the circuitry it explains and as fascinating as the experiments you build and explore!

From digital logic to the latest 16-bit microprocessor, you master one subject at a time with McGraw-Hill **Concept Modules** sent to you one at a time, once a month, to make up the complete **CONTEMPORARY ELECTRONICS SERIES**. Each module of the fifteen in the Series is a unique blend of "hands-on" experience, interactive audio cassettes, and vividly illustrated printed support materials. Together

they will prepare you for tomorrow's better jobs or advancement in your present position by staying current with today's electronics revolution.

Understand Digital Logic... Microprocessors... Optoelectronics

Here's an extraordinary opportunity to update your understanding of today's most important technological changes in electronics. You can start from scratch or use the Series to update yourself. You cover the latest integrated circuits, including TTL, CMOS, and ECL digital circuits; op-amps; phase-locked loops; microprocessors; and optoelectronic devices such as LEDs and LCDs.

Perform Electronic Experiments

With your first module you'll use the latest digital integrated circuits to build an oscillator circuit that demonstrates digital signals—verified visually by the flash of light emitting diodes (LEDs).

You'll learn concepts applicable to all electronic circuits. With the first module, you will be able to identify the major passive components, like resistors, capacitors, inductors, diodes and transformers, and active components such as transistors and integrated circuits.

Electronics Series

Each Concept Module goes right to the heart of the matter. You waste no time on extraneous material or outdated history. It's a fast, efficient, and lively learning experience, a nontraditional approach to the most modern of subject matter.

Construct And Use New Explorer Design Lab

What's more, laboratory experiments you perform as you expand your Explorer Design Lab system reinforce every significant point. All projects are designed to enhance and support your interaction with the cassettes and special text materials.

This essential hands-on experience with actual electronic components gives you a clear and simplified understanding of contemporary electronics. Every module will include additional components that you mount on your expanding Explorer Lab system. You'll use your Lab throughout the Series and later to design, build, and test your own circuits.



With your first module you'll use this solderless breadboarding system. As you add additional boards to create your Explorer Design Lab you retain the ability to connect and build increasingly complex circuits easily and quickly.

When you have received Module 15, you also have a wide variety of contemporary components you can continue to use for your own design projects. The principles you will have mastered in your Series will apply to all contemporary electronic circuits, right up to tomorrow's latest VLSI's (Very Large Scale Integrated) circuitry.

Unique Interactive Instruction Makes Learning Easy

With each new module you will receive a McGraw-Hill Action-Audio Cassette, a remarkable technique of interactive instruction. Each tape creates a dynamic discussion that not only quickly communicates the facts, but makes you feel that you are participating in a lively dialogue with experts in contemporary electronics who provide you with first-hand information in a warm and provocative way.

Your ability to rapidly make this knowledge your own

is further aided by a strikingly original method using diagrams, explanations, illustrations, and schematics to drive home and reinforce the meaning of all important points. Carefully indexed binders contain this material as well as the instructions to guide you through your "hands-on" lab experiments. Finally, having completed the Series, you can be awarded a Certificate of Achievement from McGraw-Hill upon passing an optional final examination.



Update Your Knowledge of the New Electronics

This program is for anyone who has an interest in electronics. It's designed for you whether you are someone looking to find new directions in this wide open field... or the kind of person who wants to understand what's going on in the world around you... you could be a teacher who would benefit from a refresher course in contemporary circuits, components, and applications... a manager or supervisor in an electronics related business or industry... an engineer in another field who finds electronics playing an ever more important role in your work. It's even for the

electronics engineers and technicians, or people with similar backgrounds who feel their training is out-of-date.

McGraw-Hill's Contemporary Electronics Series offers you the quickest and probably least expensive learning method available today, and the only one with "hands-on" experience.

15-Day Trial

To order your first module under our 15-day trial examination, simply complete the card and send today! If card is missing, write us for ordering information.

YOU COVER EVERY SUBJECT IN CONTEMPORARY ELECTRONICS

- Digital logic
- Digital gates (TTL, CMOS, ECL, NMOS)
- Flip flops
- Counters and Registers
- Op-amps and Applications
- Combinational logic circuits (ROMs, PLAs, decoders, etc.)
- Circuit analysis. LCR networks
- Transistors (bipolar and FETs), diodes and thyristors
- Integrated circuits (linear and digital)
- Oscillators
- Optoelectronics
- Microprocessors
- Voltage Regulation
- Advanced Digital Concepts

McGraw-Hill
Continuing Education Center
3939 Wisconsin Avenue
Washington, DC 20016.



The Basis 108

A sleek import from Germany combines CP/M Plus with Apple compatibility

by Seth P. Bates

Flexibility, low cost, and abundance of software are the qualities that have made the Apple II a success. Now these qualities are available in a machine that comes already equipped with a variety of upgrades as standards. As well as providing complete compatibility with Apple II software and peripherals, the Basis 108 offers serial and parallel interfaces, 128K bytes of RAM (random-access read/write memory), an 80-column display, an RGB (red, green, blue) monitor interface, and a Z80 processor card. The Basis 108 was designed to meet the needs of professionals rather than hobbyists, but it is flexible enough for both.

Basis

Since 1979, Basis ("Bah-zis") Microcomputer GmbH, of West Germany has been the exclusive Apple distributor for Western Europe. The company produced keyboard encoders for upgrading the Apple II and helped establish requirements for the European version of the computer. In addition to the 108, Basis also produces two more sophisticated systems for business applications: the Basis 208 and 216.

In 1982, however, Apple began to market its own products in West Germany. On learning of Apple's plans in 1981, Basis decided to develop a proprietary, low-cost microcomputer that was both hardware- and software-compatible with the Apple II. The result was the Basis 108, which was introduced to the European market in January 1982. It was an immediate success. A short time later it was introduced in the United States by Basis Inc. of Scotts Valley, California. Last summer the distribution rights to the computer were bought by Computer Systems Designs of Ridgefield, Connecticut, which is now selling the Basis 108 at a much reduced price: \$2595 for a complete system. It previously cost \$3500.

The Basis 108 System

The 108 is structurally similar to the IBM Personal Computer (PC) (see photo 1), with a detached keyboard and two 5¼-inch disk drives. It has a 50-watt power supply (the Apple II has a 35-watt supply), a motherboard (photo 2), and mounting planes for two 5¼-inch drives. The back panel (photo 3) provides DB-25 sockets for serial and parallel I/O (input/output) and has cutouts for as many as six connectors. It also has RGB, black-and-white, and NTSC (National Television Standards Committee) video outputs; cassette I/O; a fuse socket; and power input. Two power outlets allow you to add a video display and printer that are switched on and off with the system.

The keyboard was designed to meet European ergonomic standards and is attached to the unit by a five-foot coiled cable. The keyboard has an 18-key numeric keypad, a 9-key cursor control block, and 15 programmable function keys (photo 1). The layout is similar to that of an IBM Selectric. The cursor block provides four standard cursor controls as well as Home, four Apple control-code keys (for clear-to-end-of-line and clear-to-end-of-page functions), and four directional codes. These keys allow single-keystroke cursor control in Apple software (standard in CP/M and Pascal), and they make a nice "bleep" when they are used.

Basis at one time offered a beautiful European-made, ergonomically designed high-resolution monitor with a 25-MHz bandwidth. This unit was quite expensive, however, and Basis discontinued it. I've found that the Electrohome 1302-2x monitor and Taxan's RGB Vision I monitor work well with the system, but the Electrohome cable needs a simple modification to work properly. The technical bulletin that explains this change is available from Basis. The latest word from the new distributor is

that a monitor will now be bundled with the Basis 108 system.

The Motherboard

The Basis 108's motherboard (photo 2) is an economical design that has enabled Basis to manufacture it inexpensively, while offering standard features that would be costly to add to an Apple II. Both of the motherboard's microprocessors (a 6502 and a Z80) reside on the board, and both have direct access to the bus and address lines.

Apple Emulation

The 6502 mimics the operation of the Apple II processor, providing the same clock rate (1 MHz) and memory-mapping scheme. The monitor program for this processor resides in ROM (read-only memory) and fully supports both 40- and 80-column operation. The Z80 is dormant while the Basis is in 6502 mode.

At a Glance

Name

Basis 108

Manufacturer

Basis Microcomputer GmbH,
Muenster, West Germany

American distributor

Computer Systems Designs
99 Danbury Rd.
Ridgefield, CT 06877
(203) 431-4540

Standard system configuration

Basis 108 system unit with 128K bytes of RAM, two disk drives, monitor, keyboard, and power cables, CP/M Plus, Perfect Software packages, system disks, and operator's manual

Price

\$2595

Processors

6502 (1 MHz) and Z80 (2 MHz)

Memory

128K bytes of RAM installed; sockets for 12K bytes ROM- or EPROM-based software

Features

Text and graphics options. Black-and-white, NTSC, and RGB video outputs. Game-control socket with 3 TTL inputs and 1 TTL output. Cassette, serial, and parallel interfaces. Six Apple II-compatible expansion slots. Detached keyboard with numeric keypad, 15 function keys, and a cursor-control block

Software included

CP/M Plus operating system; Perfect Writer, Perfect Calc, Perfect Filer, Perfect Speller; three disks of system utilities

Software options

Write Away word processor (by Midwest Software): \$175

Hardware options

256K-byte RAM pseudodisk board: \$695
Basis green-phosphor monitor: \$995

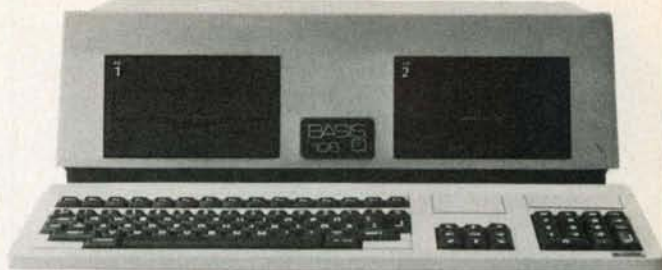

Photo 1: The Basis ("Bah-zis") 108 is a microcomputer, configured like an Apple II, with Z80 and 6502 microprocessors and 128K bytes of RAM. The 108 comes with two Basis disk drives. The earlier model (shown here) has Micro-Sci drives. The keyboard provides all the features required of a business system.

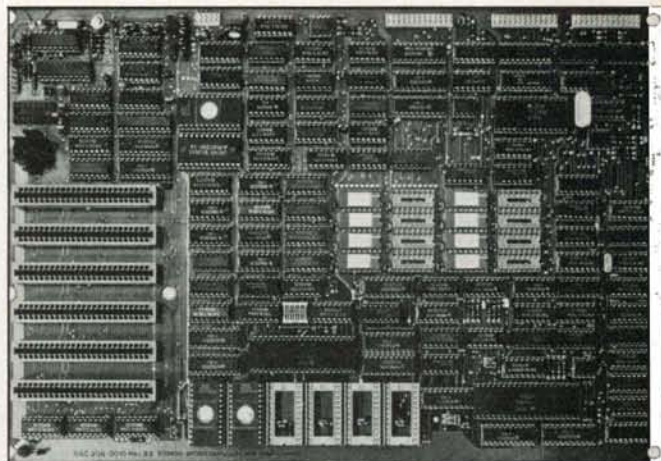

Photo 2: The motherboard's expansion slots (similar to the Apple II's slots 2 through 7) are at the left. The character-set ROM chip is just above and to the right of the top expansion slot. Sockets for resident software in ROM are at bottom center, just below the Z80 processor. The 6502 chip is at right bottom, and the memory chips are just to the right of the center (shown here with only 64K bytes of memory).

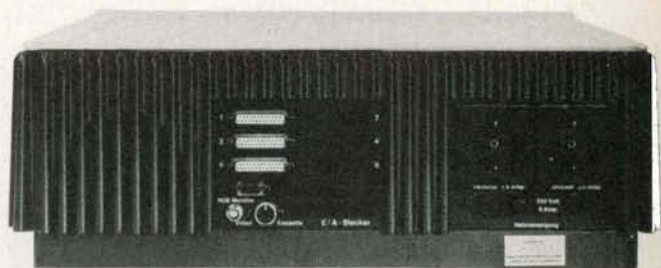

Photo 3: The aluminum casting of the chassis is finned for strength at the rear. A cutout provided for a fan is not used (or needed). Six cutouts for DB-25 connectors are available, as are cassette, composite video, and RGB connectors. A flat-cable clamp can hold any loose wires and cables not using the connectors provided. Along with an easily accessible fuse, two switched outlets are provided in this European version. The U.S. version provides 110V outlets in their place.

Basis Users Groups

N.Y. B.U.G.
William Cook, President
239 Demarest Ave.
Closter, NJ 07624
(203) 729-1600, ext. 286
(201) 767-0176

California Basis Users Group
Jim Fitch
35 National St.
POB 3068
Salinas, CA 93912

Table 1: A list of users groups for the Basis 108. These users groups receive technical and customer-support mailings.

Hardware products tested

Apple Graphics Tablet	Hayes Micromodem
Echo II voice synthesizer	Applecat modem
Grappler	J-Cat 1200 bps modem
Amlyn disk controller	

Table 3: Apple peripherals found to be compatible with the Basis 108.

Graphics modes

40 horizontal by 48 vertical	— 15 colors
80 by 48	— 15 colors
280 by 192	— 6 colors

Combined text/graphics modes

40 by 40 plus 4 lines of 40 characters
80 by 40 plus 4 lines of 80 characters
280 by 160 plus 4 lines of 40 characters
280 by 160 plus 4 lines of 80 characters

Table 2: The graphics and text modes for the Basis 108.

Software products tested

Wordstar (Apple version for Videoterm 80-column card)
Apple Visicalc
Word Handler
Magic Window
Educational software from Spinaker Software and
The Learning Company
Cfox and Aztec games

(Frogger and Pie Writer do not work with the Basis 108.)

Table 4: Apple software found to be compatible with the Basis 108.

CP/M

The Z80 has a clock rate of 2 MHz, the rate used by Microsoft's Softcard for the Apple II. It runs under a customized version of CP/M Plus (or CP/M 3.0), which is standard with the machine. This version of CP/M makes full use of the machine's 128K bytes of RAM by using a bank-selection technique. That is, small parts of the 128K memory are automatically switched into and out of the 64K memory space of the Z80. Fortunately, this procedure is user transparent.

This version of CP/M furnishes several other features, including three levels of file protection (password-based), three modes of automatic date and time stamping (a clock board is not required), and a 44K-byte print spooler. [Editor's Note: According to Basis, two versions of CP/M Plus are offered. One has a printer spooler for the parallel port and a real-time clock. The other has a spooler for the serial port but no clock, because it handles the timing of the serial port. . . . R.M.]

When running under CP/M, the Z80 uses the 6502 as a high-speed processor for I/O. The 6502 acts as an interface between the Z80 and the keyboard and the parallel and serial ports. When you start CP/M operation, the 6502 loads the operating system from disk and then passes control to the Z80. The Z80 then accesses memory directly but uses the 6502 for I/O functions.

Processor timing is critical in this system; the 6502 is a dynamic processor and would "lose itself" if it were not refreshed periodically. The Basis version of CP/M includes instructions to ensure that the Z80 controls the 6502's refresh process.

Text and Graphics

The Basis 108 provides four software-selectable character sets. They are programmed in a memory chip, a 2732 EPROM (erasable programmable read-only memory), which can be replaced or reconfigured by the user. In fact, Basis users groups (table 1) are developing some alternate character sets. The standard set includes the 64 Apple characters, the 128-character ASCII (American National Standard Code for Information Interchange) set, a full set of APL characters, and a special set of German characters. French, Spanish, Swedish, and Italian character sets are available from Basis in Europe.

The video-text-screen memory resides in static RAM chips, parallel to main memory, and is refreshed by high-speed interleaving. Video outputs are available for black-and-white, NTSC-color, and RGB monitors. The black-and-white mode provides a true gray scale for very professional-looking black-and-white graphics. Table 2 describes the various graphics and text modes.

Resident Software and RAM

In addition to the character sets in ROM, the Basis provides for up to 12K bytes of ROM-based software (or firmware). As mentioned above, the Basis 108 also comes with its own monitor program in ROM, which lets the user choose between a 40- or 80-column display. This selection may be made during initial system booting or any other time by pressing a certain key sequence. The owner's manual includes a complete listing of the monitor program code.

DBMS?

DBMS, n. A buzzword for **Data Base Management System**. A structure in which to collect information on a given subject in one or more files. A software program enabling you to store, manipulate and retrieve your information contained in those files.

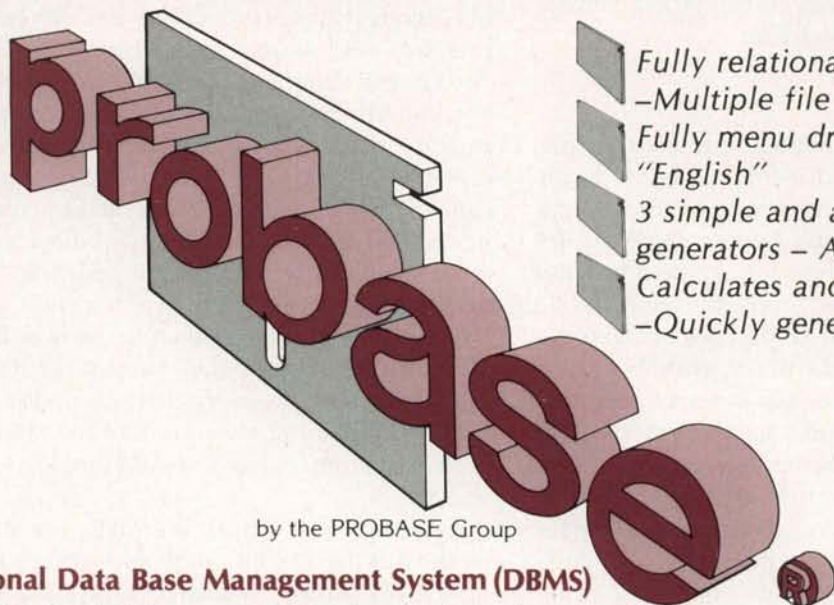

- Fully relational data base management
- Multiple file and disk access.
- Fully menu driven - Presented in "English"
- 3 simple and automatic program generators - A complete package.
- Calculates and compares figures
- Quickly generates valuable reports.

Probabase® by the PROBASE Group Fully Relational Data Base Management System (DBMS)

Probabase's Quick Gen "tells" your computer how to enter, find, sort, calculate, analyze and present information. Easily add, change, delete, or browse through your data. Probabase's ability to combine and collect data on a given subject from many separate files allows you immediate access to all of your information - **Bookkeeping, Cost Accounting, Inventory, Personnel, Portfolio Analysis, Sales, etc.** Menu Gen joins files together in an easy-to-use selection list. Report Gen compiles virtually any comparative reports you need, including projections and forecasts. And prints them in any format you choose.

Probabase® Requires No Training

Press a 'function' key for help. Concise documentation with samples on-screen assists you with your current task. And returns where you left off. Complete documentation includes a handy 2-part tutorial manual.

Easy Enough For Non-Technical Users

Probabase's three program generators (Quick, Menu, Report) create data base management applications according to your direction -automatically. Enter your requests using simple selections and fill-in-the-blank menus. Inquire, generate a report, create or up-date your data bases, design entry screens... Programming and code entry are completely eliminated, so you don't need to be a programmer, or even have computer experience, to produce professional automated business reports.

Powerful Enough For Programmers

Access 3 different files at once and work with as many as you need within a single program. Combine your files in "one-to-many" or "many-to-one" relationships. When you program in Probabase, all of your tools are immediately available: Macro Instruction Language, Subroutine Calls, Programmable Function Keys and more. Program, test and debug without an outside editor, assembler or compiler. Make changes and corrections instantly.

Free disk space... Probabase efficiently compresses screens and program tables onto your disks. And Probabase need not be present on disk when you run your applications. Enjoy more disk storage capacity and faster throughput by eliminating extra program code.

Try Probabase Free For 30 Days
Visit your local dealer or call 800-258-7070 for your copy of Probabase. If not satisfied, simply return it within 30 days for a prompt, courteous refund, whatever the reason. See for yourself how useful Probabase can be for you.

Available in PC-DOS, MS-DOS and CP/M86 (all using 128k) and CP/M (64k). Enjoy the newest, most effective data base management systems.

Circle 470 on inquiry card.

Probabase®
Another Solution® from
Data Technology Industries™
701 A Whitney Street San Leandro, CA
94577

800-258-7071 (415) 638-1206

Write or Call Today and Find Out How You Can Put Probabase To Work For You.

The standard system comes with 128K bytes of RAM, which is handy because CP/M Plus takes up a sizable portion of the lower 64K bytes. Basis also offers a 256K-byte RAM-disk board for \$695.

Bundled Software

The Basis 108 comes with a bundle of software from Perfect Software. This set includes Perfect Writer, Perfect Speller, Perfect Calc, and Perfect Filer.

Expansion Slots

The Basis 108 has six slots that accommodate Apple expansion boards. They are equivalent to slots 2 through 7 of the Apple II. Since the connections for these slots are supposed to be identical to the Apple's, the Basis 108 should be 100 percent compatible with Apple II boards. I tested these slots with several products (see table 3). Of course, any board that must go into slots that correspond to the Apple's 0 or 1 slots will not work; but since the Basis already has an extra 16K bytes of memory (which would go into slot 0) and a parallel printer port (slot 1 on the Apple II), this discrepancy in the number of slots should not be too much of a problem.

The system is configured to recognize the serial interface at logical slot 9. This interface provides two handshake circuits and transmission rates from 50 to 19.2K bps (bits per second). Several cards useful in an Apple

II or IIE are not needed here because their functions are already provided. These cards include serial and parallel interfaces, a RAM card, and an 80-column uppercase/lowercase text-display card. The six remaining slots should meet the needs of most users.

Optional Hardware and Disk Systems

Until the spring of 1983, the Basis 108 had been sold in versions with a choice of two disk drives, one, or none. It is now sold in only one version, which will provide two German-built Shugart-based disk drives offering 100 percent Apple compatibility and is controlled by a proprietary diagnostic controller card that automatically checks all system functions on power-up. This facility can be disabled or accessed at any time while the machine is on. The controller is built for Basis by Prometheus, which also developed the popular AppleShurance disk controller.

One slot of the 108 is taken up by this diagnostic disk controller, but since parallel and serial interfaces and a full 128K bytes of memory all reside on the motherboard, the five remaining slots are free for more exotic uses, such as modem cards and A/D (analog to digital) converters.

Eight-inch disk-drive controllers for the Apple will work with the 108, although such drives will not fit the 108's front-panel 5¼-inch cutouts. Basis uses 8-inch drives in its 208 and 216 models and might decide to offer an 8-inch modification kit for the 108 as an option.

Another interesting possibility would be to use two half-height 5¼-inch drives in one side of the 108 and a 5¼-inch hard disk in the other, thus providing a powerful, compact system. Davong, Xebec, and Corona hard-disk drives should all work with the 108, but since CP/M Plus is new, no manufacturer has yet written the BIOS to interface its hard-disk drive to this operating system. Apple users who own the Microsoft Softcard (and hence have the old CP/M version 2.2) can use the hard-disk drives immediately. The Amlyn 8-megabyte removable minipak drive works beautifully with the system and has been popular.

For those seeking 16-bit computing compatibility, Metamorphic's 8088 card for the Apple works without problems. It provides MS-DOS, the 16-bit UCSD P-system, and CP/M-86 compatibility. With this card, the Basis contains three separate and independent processors—a 6502, a Z80, and an 8088. It would also be compatible with seven of the current predominant operating systems—Apple DOS 3.3, Apple Pascal, CP/M, Turbodos, MS-DOS, CP/M-86, and 16-bit Pascal.

Software

Besides the CP/M Plus disk, the 108 comes with three disks of system utilities. One, The Filer from C.P. Software contains three excellent disk-management utilities, an operating system compatible with Apple DOS 3.3, and an Apple-compatible floating-point BASIC interpreter. Unfortunately, this operating system and BASIC interpreter cannot be used apart from these utilities. Pur-

De Smet C

PCDOS — CP/M-86 — MPM-86 — CCP/M-86

\$ 109

■ OUTSTANDING PRICE/PERFORMANCE

"SIEVE" Benchmark

135 bytes compiled — 6144 bytes linked

65 sec. compile (disk) — 11.5 sec. run (10 iterations)

■ FULL DEVELOPMENT PACKAGE

C Compiler, Assembler, Linker, Librarian and Full Screen Editor • Native 2.0 Support

■ COMPLETE IMPLEMENTATION

FULL K & R — plus — STUDIO LIBRARY

Both 8087 and Software Floating Point

To order specify OS & DISK SIZE/FORMAT.

Calif. residents add 6% sales tax.

C WARE

970-4 West El Camino Sunnyvale, CA 94087

(408) 736-6905

PCDOS Trademark IBM — CP/M Trademark Digital Research

IBM® + GENIE™ = Solution

5.25" Fixed/Removable Winchester Cartridge Drive Systems For The IBM Personal Computer/Compatibles



5+5™

• The Genie Cartridge Drive

A revolutionary new 10 Megabyte Hard Disk Drive that includes a 5 Megabyte removable hard disk cartridge. The cartridge drive system simply plugs into your computer, and includes all necessary software and hardware. Genie Drives are compatible with most popular software, and each cartridge replaces over 30 double-density floppy disks.

• 5.25" Removable Cartridge

(Proposed ANSI Standard). Imagine, 5 Megabytes in the palm of your hand. These small Winchester cartridges are only .75 inches thick and 5.50 inches square. The disk itself is completely sealed from the outside and all its hazards by a sliding door that opens only once the cartridge is firmly seated inside the drive.

• Genie's Solution To Personal Computer Mass Storage Problems

Up until now, people with serious mass storage applications have had no realistic means of conveniently maintaining their large data bases due to the cost of storage media and the expense and inefficiencies of doing back-ups. The Genie systems approach solves such typical storage problems by allowing both high capacity Fixed Drives and 5 Megabyte Removable Cartridge Drives to be intermixed on the same computer system. This provides the ultimate storage solution because of the new ease of doing back-ups, along with ability to maintain several large data bases on removable cartridges, eliminating the need to tie up expensive disk drives over a single data base application. With Genie Drives, the combinations are unlimited. Flexibility and versatility were key design considerations. A user can configure up to eight of our Drive Products in any combination to derive a storage solution for just about any application imaginable. With Genie, your personal computer can now take on tasks that had only been possible with mainframes.

- 10 MEGABYTES OF ON-LINE STORAGE
- FILE SIZES TO 5 MEGABYTES
- BACK-UP 5 MEGABYTES IN TWO MINUTES
- CARTRIDGE INTERCHANGEABILITY GUARANTEED



X5™

Genie Systems Are Expandable Up To 160 Megabytes Using Any Combination Of Genie Drive Models

- 5 MEGABYTES OF ON-LINE STORAGE
- FILE SIZES TO 5 MEGABYTES



MODEL X5P

SIMPLY PLUGS INTO YOUR I.B.M.



5-10-15-20

- USER CAN BACK-UP TO MODELS 5+5 OR X5 REMOVABLE CARTRIDGE DRIVES OR DISKETTES.

5 MEGABYTES
10 MEGABYTES
15 MEGABYTES
20 MEGABYTES

TALK ABOUT USER FRIENDLY...
3Com Ethershare™ Compatible (Ethernet Standard)

- IBM XT Compatible
- Automatic Install (Genie Custom BIOS)
- Comprehensive menu driven utility package
- Intermix different operating systems on disk or cartridge
- Assign to any drive codes from A thru H
- Choice of volume sizes
- Give your virtual volumes 16 character names
- Assign command allows you to assign 8 virtual drives on line at any one time
- Show command allows instantaneous viewing of all virtual drives on line
- Help command displays syntax for all new commands
- User can back up to or from any model Genie Drive
- File sizes 5-20 megabytes, dependent upon drive type.
- Automatic recovery system
- Easy back ups in minutes
- Cartridges can have 16 character names
- System status screen messages
- System expandable to eight drives using only one slot in your IBM PC
- Built-in error detection and correction
- No preventative maintenance required
- Power-on self test
- Create turnkey systems
- Ultra hi-speed DMA data transfers
- Comes complete with all necessary software and hardware
- Operating systems supported: IBM DOS 1.1, 2.0, CONCURRENT CP/M 86®, CP/M 86®, UCSD P SYSTEM®, QNX™

Manufacturer's suggested retail price. Includes all required components.
CP/M-86 and Concurrent CP/M-86 is a registered trademark of Digital Research.
IBM is a registered trademark of IBM Corporation.
Dysan is a registered trademark of Dysan Corporation.
UCSD P System is a registered trademark of the Regents of the University of California San Diego.
QNX is a registered trademark of Quantum Software System, Inc.
Etherlink is a registered trademark of 3Com Corporation.
Ethernet is a registered trademark of Xerox Corporation.

AVAILABLE AT YOUR LOCAL COMPUTER DEALER

GENIE COMPUTER CORPORATION

31131 Via Colinas #607 • Westlake Village, CA 91362 • (213) 991-6210 • TLX 658233 (GENIE USA)

Circle 169 on inquiry card.

BEST IN PRICE & QUALITY

Call Now TOLL FREE 800-368-3404 (In VA, Call Collect 703-237-8695)

AMPEX • INTERTEC • TEXAS INSTRUMENTS • GENERAL DATA
COMM. • ANDERSON JACOBSON • C. ITOH • QUME • BEEHIVE •
DATASOUTH • DIABLO • CENTRONICS • NEC • PRENTICE

MICROS

INTERTEC SUPERBRAIN II
64K DD* \$1874
64K QD* \$2249
64K SD* (96TPI) \$2689
*(Includes M/Soft BASIC)
DYNABYTE 8/16 BIT Call
CALLAN 16/32 BIT Call

PRINTERS

NEC
7710 Ser. \$1899
7715 \$1949
7730 Par. \$1899
7720 \$2449
7725 \$2496
Std. Tractor 77xx \$ 199
3510 \$1364
3515 \$1394
3530 \$1390
3550 (IBM) \$1709
DATASOUTH DS180 Call
DATASOUTH DS220 Call

DIABLO

620-SPI \$ 889
630-R-102/147 \$1949
630ECS \$2389
630-R155* \$1709
*(for IBM PC, Apple II, TRS-80)
630K104 (KSR) \$2265

QUME

Sprint 11/40-PLUS \$1355
Interface \$ 76
Sprint 11/55 Call
Sprint 9/45 FP \$1794
Sprint 9/55 FP \$2080
Bi-Dir Forms Tractor \$ 199
CENTRONICS: 122 Par \$ 689
351 \$1673
BarCode \$ 98

TERMINALS

AMPEX

D80 \$ 689

PHAZE (3270 Ex. Mem) \$1589

BEEHIVE (SMART DISPLAY)

DM5 Call
DM5A Call
DM83 (Burroughs) Call
DM3270 (3270 Emulator) Call
Protocol Converter Call

QUME

QVT-102 \$ 549

QVT-108 Call

C. ITOH

CIT 101 \$1289

CIT 161 (64 Colors) Call

CIT 201 (Graphics for

TEK 4010/4014) Call

We also make EIA RS 232 or RS 449 cables to your order, can supply you with ribbons, printer stands, print wheels, thimbles for all printers listed. Plus many, many more items. Most items in stock. CALL NOW.

All items shipped freight collect either motor freight or UPS unless otherwise specified. All prices already include 3% cash discount. Purchase with credit card does not include discount. Virginia residents, add 4% Sales Tax. For fastest delivery send certified check, money order or bank-wire transfer. Sorry, no C.O.D. orders. All equipment is in factory cartons with manufacturers warranty (honored at our depot). Prices subject to change without notice.

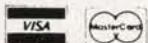

TERMINALS TERRIFIC

Terminals Terrific, Inc., P.O. Box 216, Merrifield, VA 22116
Phone: 800-368-3404 (In VA, Call Collect 703-237-8695)

CIT 414 (Graphics

640 x 480 Res.) Call

TEXAS INSTRUMENTS

745 Standard \$1172

745 Std. (Reconditioned) Call

765 Bbl M/my Call

785/787 Call

810 Basic \$1249

810 Package \$1439

820 Package RO \$1610

820 KSR Package Call

703 Std. \$ 459

707 KSR \$ 549

850 Tractor Feed \$ 549

MODEMS

Prentice Star 300 Bd. \$ 124

U.S. Rob

Password AD (212A) .. \$ 347

US Rob TelPack \$ 69

Stat Muxes Call

Ventel 212 + 3E Call

Prentice 24/9600 bd. Call

DISC DRIVES

QUME

Data Trak 5 \$ 289 or 2 for \$ 549

Data Trak 8 \$ 519 or 2 for \$ 999

SOFTWARE

BISYNC-3780 \$ 569

WordStar \$ 279

DataStar \$ 218

Mail Merge \$ 144

SpellStar \$ 144

Plan 80 \$ 249

d Base II \$ 489

CalcStar \$ 119

SuperSort \$ 144

SuperCalc \$ 144

InfoStar \$ 279

InfoStar (8") Special \$ 249

CIS Cobol \$ 689

Forms II \$ 159

C Lattice Comp. IBM PC \$ 395

"C" Compiler \$ 239

WordStar Professional

(WS, SS, MM, S1) \$ 399

ReportStar \$ 199

StarIndex \$ 129

PlanStar Call

StarBurst Call

InfoStar Plus Call

IBM PC

256K RAM Bd. \$ 256

256K RAM Bd Full Parity. \$ 305

BabyBlue \$ 600

BabyTex \$ 600

BabyTalk 3270 BISYNC \$ 895

8" Disk Controller \$ 395

chasers wishing to use Applesoft BASIC for programming must purchase the software on disk or in ROM chips. A ROM chip set is available from Computer Discount Products (860 South Winchester Blvd., San Jose, CA 95128) for about \$125. The Apple UCSD Pascal can be purchased on disk as well, for about \$230.

Another disk that is provided, the System Booter, can reconfigure a 40-column Apple BASIC interpreter to a 40/80-column selectable version for the Basis system. Most users, however, will want the dealer to take care of this reconfiguration because the booter runs only under Pascal. But if you own Pascal, you can do your own configuration.

The remaining disk is the Basis utility disk, which modifies the Apple UCSD Pascal operating system to recognize special features of the 108. Also, this utility will modify Apple DOS 3.3 to recognize the serial port at logical slot 9 and to allow the saving and retrieving of upper- and lowercase-text files.

Advanced users will probably want to turn their modified Applesoft BASIC interpreter into an EPROM chip set and thus end up with a system that strongly resembles an Apple II Plus.

A software deal that is offered by Basis is Perfect Software's CP/M-based products, including Perfect Writer, Perfect Speller, Perfect Filer, and Perfect Calc as a package with the 108 for \$275. Basis users should stay in touch with the company (or dealers) because more software is being optimized for the systems.

Dealer Support

Basis is establishing a dealer network and is most interested in dealers who will provide full-service system support. The former distributor maintained a commitment to its dealers to provide parts replacements within 24 hours of a request.

Conclusions

The Basis 108 is a beautifully designed and constructed product that offers Apple II and CP/M compatibility in addition to features that both writers and businessmen need. Some users will be disappointed by the system's size and weight (it's a bit larger than an Apple II). But professionals and hobbyists will appreciate the quality of its construction, and both its structural and electronic design. The system is also ideal for school and university applications.

The quality of the video section is excellent, and the 40-character Apple-like screen is stunning. The chassis cutouts allow the disk drives to be installed inside, resulting in a clean, attractive appearance. The detached keyboard, in addition to being well thought out, is a major improvement on any Apple II upgrade. The Basis 108 may indeed provide more built-in flexibility than any other computer on the market. ■

Seth Bates (Division of Technology, San Jose State University San Jose, CA 95014) is a doctor of industrial technology. His interests include programming, trout fishing, and reading science fiction.

Introducing ULTRAFRAME™ the multitasking, multiuser system designed for system integrators & OEM's.

FRONT VIEW

Mainframe-like Chassis Engineering Attractive aluminum chassis offers continuous-duty capability plus all the flexibility you'll need in one desktop system. Tailor a package to your unique needs. Even put your name on the front.

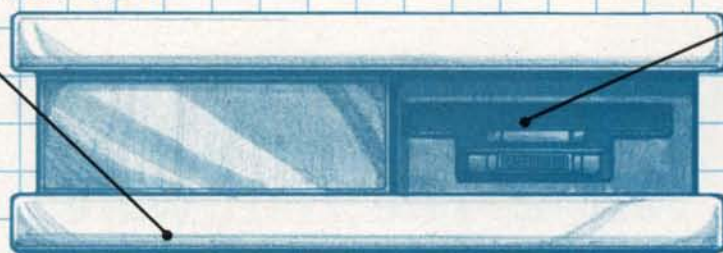

Integral 5" & 8" Floppy Drives Your choice of 5" or 8" half-height drives — up to 1.2 MB capacity.

TOP VIEW - SHOWING INTERIOR

Both 8 and 16 Bit Capability Our system is designed to accommodate both 8 and 16 bit Slavenet processors at the same time. Gives you access to the widest range of software with upward mobility in the same chassis.

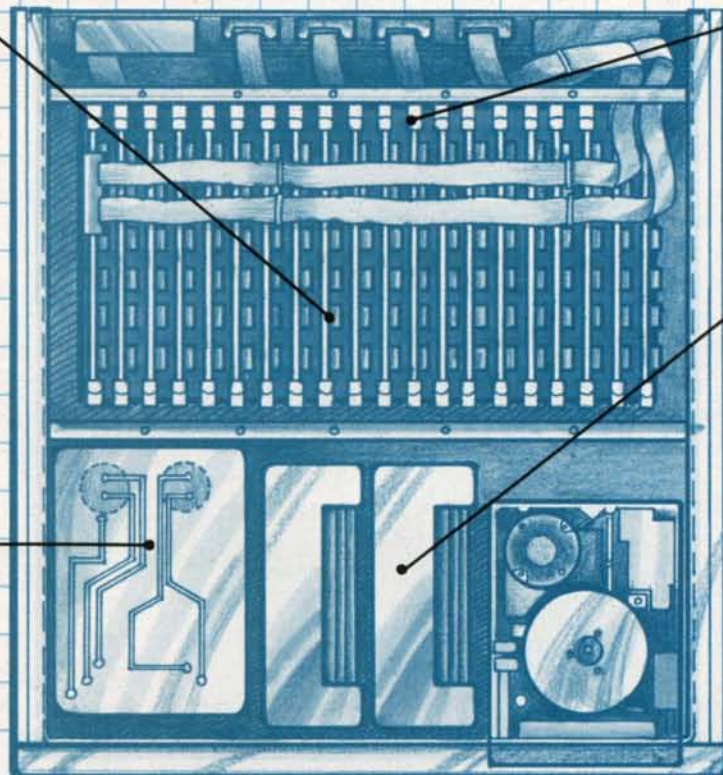

Up to 32 Users — in Parallel Our multiprocessor system uses up to 16 Slavenet™ processor boards — each a complete Z80 computer with 64K RAM per user — to maintain fast, multi-user performance as you add users or tasks. Both 12 and 20 slot S-100 models available.

Low Cost Per User Give your customer high performance and lower cost per user than any micro network. They get true multi-user, multitasking operation plus shared resources — and you get a customer for life.

Fast, High-Capacity Hard Disks Full range of fast 5" & 8" Winchester drives from 10 to 120 MB (formatted), including new high-capacity 5" models. Most 5" models have provision for adding a second drive later on. Also, 14" drive models from 145 MB to 1,160 MB.

High Capacity Power Supply Engineered to support max. load under continuous operation with two-level filtration. Easy 110/220V, 50/60 cycle switching. Solid state circuitry for max. reliability. Power regulation heat sunk to chassis.

Fast, Multiprocessor Operating Systems We offer IBS p-NET™ and TurboDOS™ — proven multiprocessor operating systems for fast, multitasking applications. Access to all UCSD-Pascal™ and CP/M™ software.

BACK VIEW

BACKSTOP™ — Video Archiving Plug in any standard video recorder to archive up to 100 MB of data. Fast, low-cost backup system for hard disks (optional).

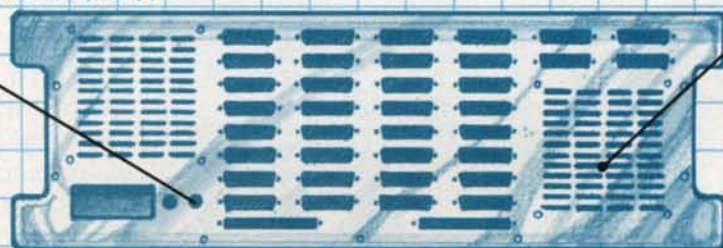

Dual Whisperfan Cooling Two high-capacity fans assure adequate cooling for around-the-clock operation. Maximum air flow around all drives and critical components.

Three-Year Warranty IBS gives you the clincher — a premium warranty to back a premium product. At a competitive price. Ask about our dealer support program.

ULTRAFRAME™

ibs

INDEPENDENT BUSINESS SYSTEMS

Call collect (415) 443-3131 TWX: 910-386-6003 IBSNE
5915 Graham Court Livermore, CA 94550

UCSD-Pascal™ is a trademark of the Regents of U. of C.
CP/M is a trademark of Digital Research, Inc.
TURBODOS is a trademark of Software 2000.
IBS is a trademark of IBS, Inc.

Bubbles on the S-100 Bus

Part 1: The Hardware

Build a fast-access 128K-byte bubble-memory board for your S-100 system

by Louis Wheeler

Before beginning work on this article, I checked back issues of BYTE for any previous articles on the subject of bubble memories. It was a short list—the loneliest number of all. A. I. Halsema's "Bubble Memories: A Short Tutorial" (June 1979, page 166) contains a lot of good information on how bubble memories work.

There was an earlier mention of

bubble memory in BYTE. The July 1977 issue contained an editorial by Carl Helmers, entitled "This Elephant Never Forgets." In it he discussed the then-new Texas Instruments TBM0103 bubble-memory chip. The editorial wound up by calling for some "technologically enterprising reader" to "purchase the early sample versions of the bubble mem-

ory chips along with documentation, and design a homebrew computer interface which we can publish for the benefit of all BYTE readers." Apparently, no one ever answered the call. Perhaps that early version was either too expensive or the circuit requirements too complicated. Anyway, here's (perhaps) the article he requested.

In part 1 I'll provide some basic information on bubble memory in general. Using Intel's BPK 72 Bubble-Memory Prototype Kit (see photo 1), I'll show you how to build a 128K-byte bubble-memory board for your S-100-bus system. Part 2 will cover the software testing and modifications necessary to realize the potential of the bubble-memory system. The completed project will function as either a floppy-disk replacement (or augmentation) or a cache memory.

Since the 1979 article and 1977 editorial were written, Texas Instruments has dropped out of the bubble-memory business. However, in 1979 Intel introduced its first bubble-memory system and, fortunately, has kept the concept alive. The Intel Magnetics Inc. version, the 7110 Megabit Bubble Memory, stores 1,048,576 bits (128K bytes) of data and has a transfer rate of 100,000 bits per



Photo 1: The Intel Magnetics Inc. BPK 72 Bubble-Memory Prototype Kit comes complete with a 4- by 4-inch PC board, all components, and extensive documentation. A simple interface and some software are all you need to build an S-100 disk emulator.

Want to hook IBM?

Terminals. Personal Computers. ASCII devices. Hook them all into the IBM world with the new AVATAR™ PA1000 Protocol Converter.

The PA1000 provides low-cost IBM 3278/2 terminal emulation and coaxial connection to an IBM 3274/3276 cluster controller. Then, a single keystroke switches you back into the asynchronous world through an auxiliary RS-232-C port to access other computer systems, public information services or copy a screen to a printer.

Our microprocessor-based unit provides user-selectable rates up to 9600 baud, terminal keyboard configura-

tions, screen management and local or remote print functions. And, you can hook the PA1000 to a modem for remote dial-in access.

Simple, economical access to the world of IBM, just when you thought there was no answer. At \$995, getting hooked has never been so affordable. For more information on our AVATAR PA1000 Protocol Converter, contact 3R Computers, 18 Lyman St., Westboro, MA 01581. Or call us at (617) 366-5300. TWX 710-390-0375.

AVATAR™

Making IBM smarter since 1983.

© 1983 RRR Computers, Inc. Avatar is a trademark of RRR Computers, Inc. IBM is a registered trademark of International Business Machines Corp.



A portable computer needs a portable surge suppressor. The PC Saver™ line cord.

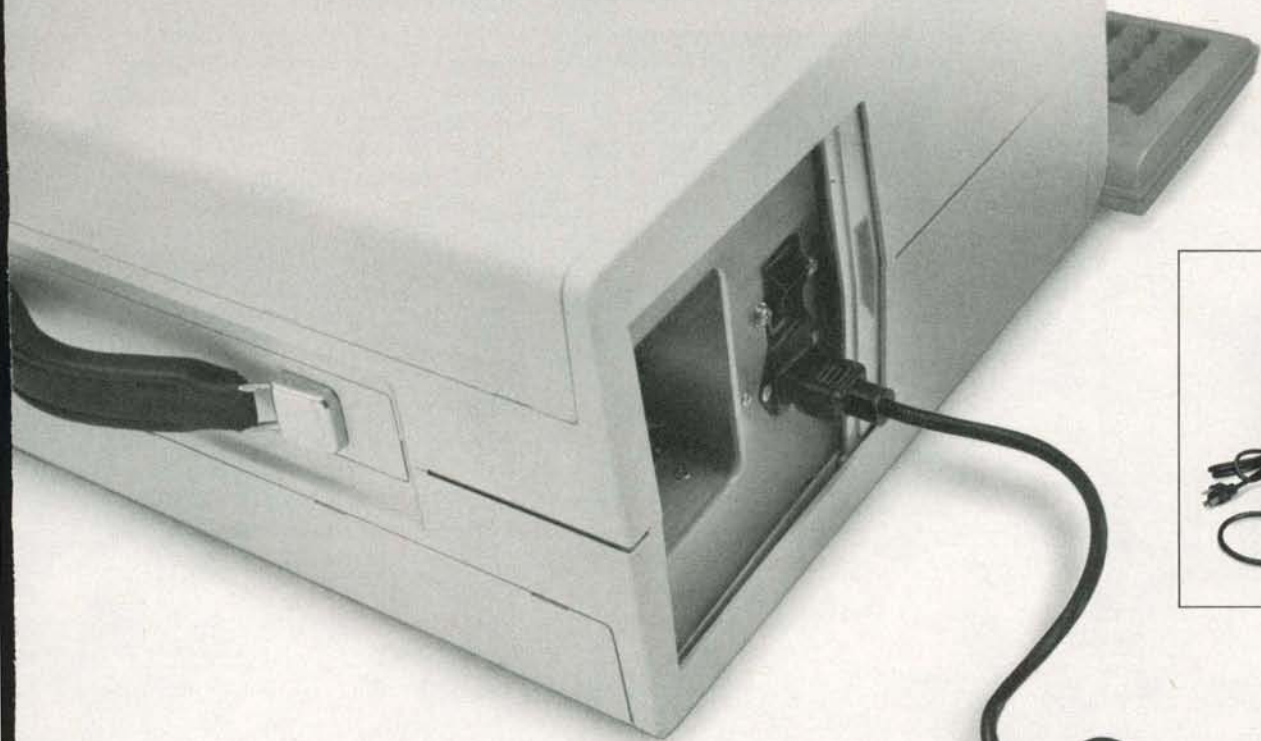

The beauty of your portable computer is that it goes everywhere you go.

Unfortunately, it meets power line problems all along the way.

In a recent PC Magazine cover story, it is estimated that 70-90% of all microcomputer malfunctions can be traced to power line problems. Problems that are magnified with a portable, since you never know what situation awaits you.

With the PC Saver, power line problems are no problem.

No matter where you plug in your portable computer, the PC Saver immediately acts to suppress surges, spikes and line noise. This prevents damage and allows your computer to function at its maximum efficiency.

The PC Saver clips surges and spikes to a safe 133 Volts RMS/175 Volts DC level in less than 50 nano seconds. An 'L' type filter attenuates common and transverse mode noise by a minimum of 20dB from 600 kHz to 30 MHz with a maximum attenuation of 50dB. All the circuitry conforms to standards established by the IEEE (Institute of Electrical and Electronics Engineers) and UL (Underwriters Laboratories).

The PC Saver is as portable as your portable.

The PC Saver is so light and compact it will fit right into your briefcase. We've put all the protective circuitry right into a power cord. To use, simply replace your factory supplied cord with the PC Saver line cord.

Will PC Saver fit *your* computer? The chances are it will. Almost all portable computers, Compaq™, Kaypro™, Eagle™, Corona™, Hyperion™, Columbia Data Systems™, and others use the standard style power cord.

Affordable protection

\$49.95 is a small investment for keeping your portable at top efficiency.

You'll find the PC Saver line cord at computer stores everywhere. Or order direct from Kensington Microware Ltd., 251 Park Avenue South, New York, N.Y. 10010, Phone: (212) 486-7707, Telex: 236200 KEN UR. For phone or mail orders please include \$2.50 shipping and handling. New York State residents add sales tax. Visa and MasterCard accepted.

 **KENSINGTON
MICROWARE**

Why it's worth every nickel.



If you laid every nickel this terminal cost end to end, it would lead to a real bargain.

Because if you're the kind of professional who buys an Ann Arbor terminal, you put the emphasis on what you get out of it. Not what it costs to get into it.

The best way to explain that is by telling you about one of our best-selling terminals: the Ann Arbor Ambassador™.

The Ambassador offers incredible value for the money.

Starting with a full 15-inch screen, portrait or landscape. A 60-line display with vertical zoom. (You won't find that anywhere else.) A hard-working keyboard with dozens of programmable keys.

Then there's the fully buffered peripheral port with separate, user-settable baud rate. ANSI-standard coding. Multiple page and window capability. Pause and Meta functions. Tilt-swivel or rack mounted frame. And dozens of other ergonomic features that have made the Ambassador a favorite among

value-minded professionals nationwide.

Now that you know all that, take another look at the nickels on this page and ask yourself this:

Is it really true that money can't buy happiness?

For more information about the Ambassador and our other fine terminals, write Ann Arbor Terminals, Inc. at 6175 Jackson Road, Ann Arbor, Michigan 48103. Or call us at 313/663-8000. You'll find it worthwhile.

ANN ARBOR

TERMINALS

Once you've worked with them, you won't work without them.

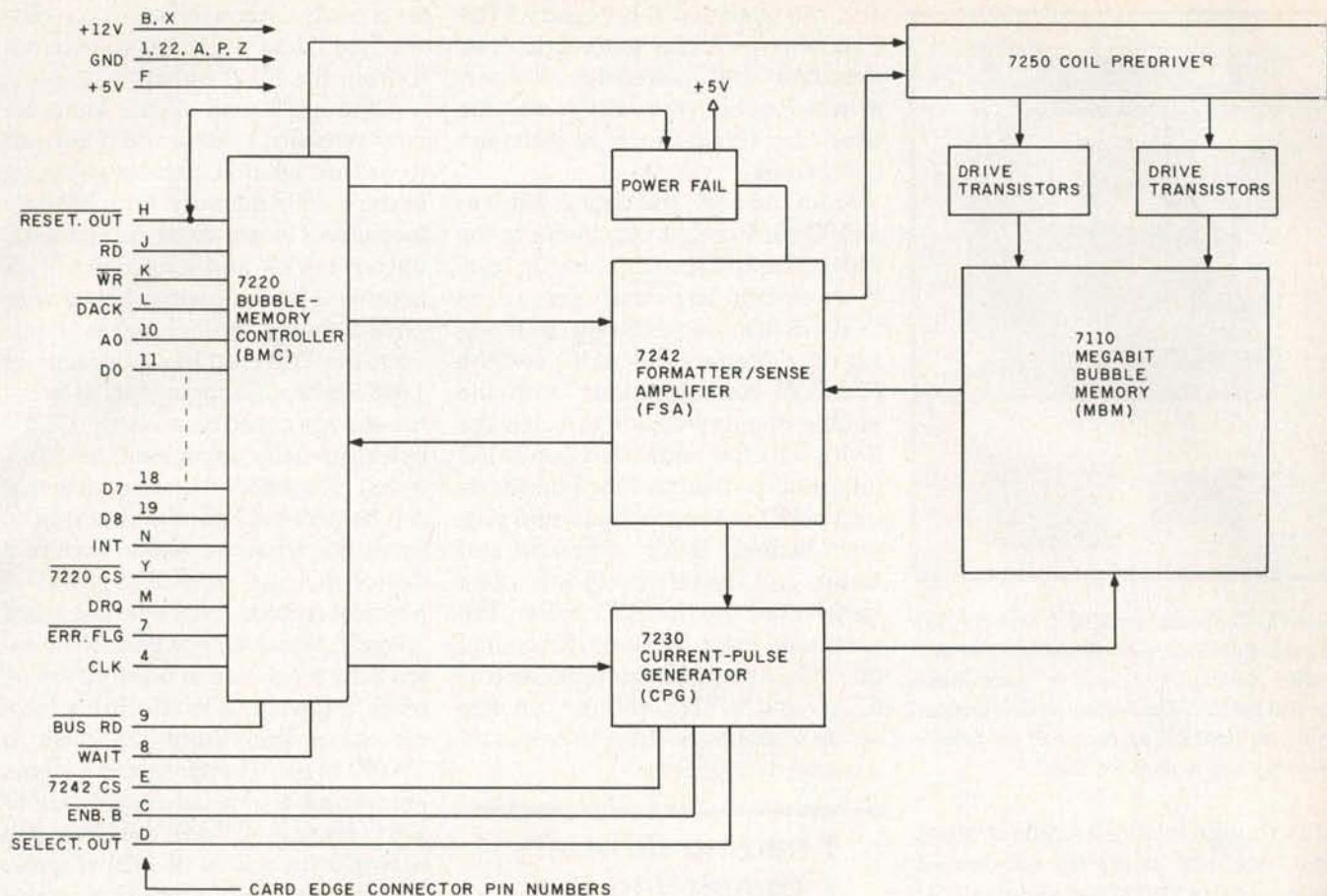

Figure 1: A block diagram of the BPK 72 Bubble-Memory Prototype Kit.

offer nonvolatile storage, which isn't true with most of the cache-memory systems now on the market. Because cache-memory systems use standard RAM (random-access read/write memory) chips, when the power fails, the data is lost. To overcome this problem, some cache-memory systems rely on bulky batteries that suffer the need for periodic replacement. Of course, all three storage systems have advantages; a library of bubble memories is still too expensive for most of us, and although they are fast, nothing is faster than RAM.

If you want to know more, obtain a copy of *A Primer on Magnetic Bubble Memory* from Intel, which is well worth reading. And even if you do not yet thoroughly understand bubble memory, don't let that stop you from enjoying this project. After all, learning is a major part of what building it yourself is all about.

The Bubble-Memory Kit

Bubble-memory chips and the required support circuitry are quite

complex. Not only are they complex, but sensitive, low-level signals and stringent layout requirements probably preclude the use of wire-wrap techniques. However, thanks to Intel, the BPK 72 Bubble-Memory Prototype Kit solves most of these design

**Intel Magnetics'
prototyping kit
includes ICs, resistors,
capacitors, test
hardware, and
documentation.**

and construction problems. A word of caution, though: this is not a Heathkit-type kit. Rather, it is an evaluation kit intended for engineers. Therefore, the user's manual is heavy on theory and light on assembly instructions.

The kit comes complete with a PC (printed-circuit) board, all resistors and capacitors, a test module, a sub-assembly to "reseed" the bubble

memory (should this be necessary), and lots of documentation. Figure 1 is a block diagram of the complete BPK 72 circuit. It lacks only an interface, clock, and power supply. Adding these three items is not very difficult, as you will see. The completed bubble-memory system illustrated in photo 2 is made up of the following active components: a single 128K-byte 7110 MBM (Megabit Bubble Memory), one transistor, and several ICs (integrated circuits): one 7220 BMC (Bubble-Memory Controller), one 7250 Coil Predriver, two 7254 Quad Drive Transistor Packs, one 7230 Current-Pulse Generator, one 7242 FSA (Formatter/Sense Amplifier), and one IN75463 OR gate.

The extensive documentation accompanying the kit details the operation of the 7110 MBM and the function of each support component. Much of the documentation is oriented toward the design of a complete bubble-memory system, including PC-board layout. However, because this project treats the BPK 72

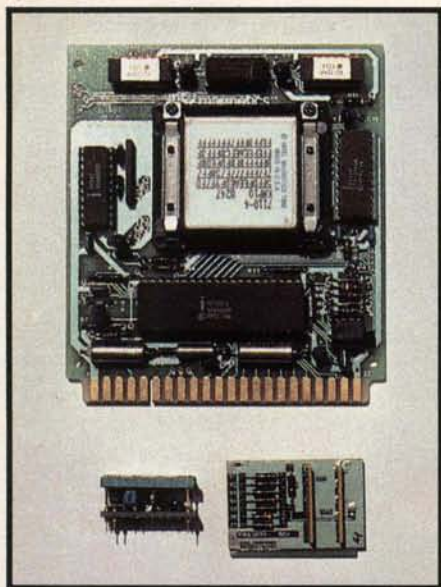

Photo 2: The assembled BPK 72 with the 7110 Megabit Bubble Memory installed. The seed module (bottom left) is used to restore missing seed bubbles. The dummy module (bottom right), an electrical equivalent of the bubble-memory chip, is used for tests.

kit as though it were a single component, we are primarily concerned with only the 7110 MBM and the 7220 BMC.

For the sake of completeness, the following is a brief description of how it works. The subject is covered thoroughly in the documentation accompanying the kit. Refer to figure 1.

Data flowing in and out of the bubble memory passes through the 7242 FSA. Two channels connect the FSA with the 7110 bubble memory (actually, the bubble memory is divided into two sections). The FSA amplifies the weak signals from the bubble memory and also masks out the defective or unused (spare) data loops according to the bit pattern stored in the *boot-loop* registers. Although 320 data loops are available, only 272 are actually used. The extra loops provide a greater production yield during the manufacturing process. This is a common practice in the manufacture of memory components. (Normally, users are usually unaware of it, and this is of little or no concern. However, this is not so with bubble memories, for even though the selection process is done at the factory and recorded in the bubble memory, we have access to the boot-loop mask

and can change it if necessary.) The FSA also performs automatic error detection and correction, a user-selected option that eliminates the need for things such as software checksums.

From the FSA, the data is fed into a FIFO (first-in/first-out) buffer in the BMC. The FIFO buffer holds up to 40 bytes of data. Its primary purpose is to alleviate timing differences among the user interface, the BMC, and the FSA. All communication with the bubble memory occurs through the BMC, which is addressed as two I/O (input/output) ports. One port (hexadecimal E1 in the schematic and software listings) is for command and status, and the other (E0) is for data transfer to/from the FIFO buffer. The command port has two functions: one to initiate BMC functions such as READ and WRITE and the other to set up a starting address to one of six parametric registers.

I had no difficulty completing the assembly after studying the schematic and parts list.

The parametric registers are akin to a disk's parameter block. They determine the number of FSA channels to be used and block length (pages of 64 bytes to be transferred); enable automatic error correction, DMA (direct memory access) operation (requires DMA controller), interrupt conditions, and data-transfer rate read); and select which bubble-memory chip to address in multibank systems and the starting page (64-byte record) address within the selected bubble memory. The setting up of the parametric registers is accomplished in the SNDREG subroutine in the driver package to be discussed in part 2. Normally, bubble-memory read/write operations proceed as follows. The parametric registers are set up with the required information, then the desired function (READ, WRITE, etc.) is selected by sending a BMC command. When the status indicates that the FIFO buf-

fer is ready to receive data or has data waiting, data is then transferred to/from the FIFO buffer.

Although I read all the literature very carefully, I still found it difficult to picture what is actually going on in the bubble memory. With 272 data loops, boot loops, seeds, input tracks, output tracks, and a lot more, it all became a bit confusing. I thus simplified things by looking at it this way: the 7110 chip has a capacity of 1,048,576 bits. Changing bits to bytes, the storage capacity is exactly 131,072 bytes (usually expressed as 128K bytes). The smallest block of data that can be accessed (read/written) is 64 bytes, so what we really have is a device that can store 2048 (64-byte) physical records (Intel uses the word "page"). However, it is possible to extend the block size in multiples of 64 bytes, allowing us to effectively have records ranging from 128 bytes to 131,072 bytes. Therefore, for systems employing a physical-record size of 128 bytes (e.g., CP/M), the block size is two, with a total of 1024 records. For systems with a physical-record size of 256 bytes, the block size is four, and the number of records is correspondingly reduced to 512.

Assembling the BPK 72 Kit

Because the BPK 72 kit is intended for engineers, so, too, is the documentation. A fair knowledge of digital electronics and some previous experience in electronic kit building would be useful, as assembly instructions are almost nonexistent. Basically, the manual says that this kit includes a printed-circuit board on which the components supplied are to be mounted. Assemble the board, referring to the assembly drawing, schematic, and parts list. Attach a suitable user interface as detailed in another section. And that's it. Although the *BPK 72 Bubble Memory Prototype Kit User's Manual* contains about 40 pages, a single paragraph covers actual assembly. The remainder of the manual is taken up with interface requirements, operating information, support components, and service information.

However, the PC board is small, 4 by 4 inches, with only eight ICs, one

Taxan monitors - engineered for style and performance

Styled to compliment Apple, IBM and most other personal computers, and designed to fit in any office or home.

☉ **TAXAN** offers a complete line of monitors including green and amber, ultra-high resolution monochrome, plus medium and high resolution RGB monitors

☉ **TAXAN** features the 410-80 80 column and RGB Card to interface with the Apple IIe.

☉ **TAXAN** monitors stand alone

Circle 365 on inquiry card.



See your local ☉ **TAXAN** dealer, or call us for details

TSK Electronics Corporation
18005 Cortney Court
City of Industry, CA 91748
(213) 810-1291

WAREHOUSE SOFTWARE

TOLL FREE ORDER — 1-800-421-3135
TECHNICAL INFO — (602) 842-1133

Call for programs not listed. We will try to meet or beat any legitimate price for CP/M or IBM PC Software.

— MOST DISK FORMATS AVAILABLE —
DATA BASE MANAGEMENT SYSTEMS.

BUY OF THE YEAR!

DBASEII+Everymans data base primer +Extra diskette with DBase Accounting, Mail List and Inventory Programs. IBM PC and CP/M — Call for our special price.

Fox and Geller Quickcode with DBase Package **\$175**

DB+SORT **\$99**
Condor III **\$420**
NWA Statpack **\$349**
TIM III **\$285**
Infostar Call

WORD-PROCESSING PACKAGES

Wordstar, Mail Merge, Spellstar, Index **\$385**
Wordstar **\$245**
Mail Merge **\$135**
Spell Star **\$135**
Lexisoft Spellbinder **\$270**
IBM PC Volkswriter **\$115**
Aspen Spellchecker **\$36**
Metasoft Benchmark **\$285**
Multimate **\$325**
Peachtext **\$265**

SPREADSHEETS

Calcstar CP/M **\$95**
Super Special Calcstar IBM PC **\$65**
Supercalc II **\$185**
Microsoft Multiplan **\$185**

ACCOUNTING

TCS•Equivalent of Peachtree•Specially Augmented By Warehouse Software Customized For Your IBM•Terminal and Printer-GL, AR, PA, AP, CP/M, XT, DOS 1.1, 2.0
Each Module **\$75** ... For All Four **\$275**

CYMA Call
Peachtree GL, AR, AP **\$265**
Home Accountant Howardsoft **\$95**

TRANSFER PROGRAMS

Move-It for IBM PC **\$105**
Hayes Smartcom Program **\$80**

Best Price in U.S. for IBM PC or Clones

Seven Function Board—Includes Async Adapter, Parallel Adapter, Clock with Battery Back-Up and Software, Game Port, 64K Memory Expandable to 512K.
1 year warranty **\$2??**

PFS File **\$95**
Hayes 1200 Modem **\$485**
Hayes 1200B Modem **\$450**
Quadram Micro Fazer Print Buffer 64K Call
Floppy Disk Controller w/Par. or Serial Port **\$195**
5 1/4" S/S D/D Diskettes w/Case **\$20**
Plantronics Color + Board **\$365**
MPI 320K D/S D/D Drives Call
Toshiba 1/2 height Drives Call
256 K Ram Board **\$299**
AST Six Pack Board Call
BMC RGB Color Monitor **\$435**
10 Meg Datamac Drives **\$1675**
Corona Computer - Portable / Desk Top Call

The Mercedes Benz of Portable Computers. IBM compatible - Hyperion — 2 Disc Drives — Software — List
\$3690 **Sale \$2995**

PCDOS

Versaform **275**
Lifeboat C Compiler **\$285**
Microsoft C Compiler **\$345**
Microsoft Pascal Compiler **\$245**
Prokey **\$55**
Norton Utilities **\$55**
PCH Copy Program **\$34**
Microsoft BASIC Compiler **\$285**
Howard Tax Preparer 83 **\$185**
Microsoft Flight Simulator **\$38**
CP/M 86 for IBM PC **\$49**
CBasic 86 **\$165**
CIS Cobol 86 **\$595**
Pascal MT+86 W/Spp **\$415**

TERMS: Prices include 3% cash discount. Add 3% for charge orders. Shipping on most items \$5.00.
AZ orders +6% sales tax. Prices subject to change.

TOLL FREE ORDER 1-800-421-3135

WAREHOUSE SOFTWARE

4935 West Glendale Ave., Suite 12
Glendale, AZ 85301

transistor, and a few other components, and I had no difficulty completing the assembly after studying the schematic and parts list. If you have assembled one of the larger Heathkit kits, you should have no difficulty in assembling this small PC board. The only tools required are a low-wattage soldering iron, side cutters, a small Phillips screwdriver, and a magnifying glass to inspect for solder bridges. An ohmmeter and a 10-MHz, or higher, oscilloscope will be needed for the preliminary testing discussed later.

I suggest assembling the kit as follows:

1. Locate and mount all the IC sockets. The 7110 bubble-memory socket must be oriented with the two Phillips-head screws on the side of the card opposite the edge-connector pins (toward the top in photo 2).
2. Install the transistor.
3. Install all the resistors and diodes. The locations are marked on the PC board, and the values are indicated on the schematic and parts list.
4. Similarly, install all the capacitors.
5. To complete the assembly, install all the ICs *except* the 7110 bubble-memory element itself; install the dummy module instead. Preliminary testing requires this dummy module.

The S-100 Interface

Before we can test the bubble-memory system, we will need an interface, a clock, and a power supply. The interface requirements of the kit are such that we can look at it as though it were a single component. The 44-pin edge connector, the P1 block in the schematic (figure 2), then represents the bubble memory and all the associated support circuitry. The rest of the process is really quite simple. The address-decoder circuit (ICs 2 and 4) consists of two 8205 (74LS138) 3- to 8-line decoders. As wired, the port addresses are hexadecimal E0 and E1; however, this can easily be changed by selecting other output pins on one or both of the decoder ICs. ICs 8 and 9 split the

MAKING THE TOUGH DECISIONS

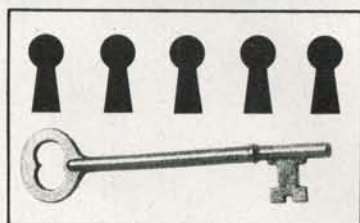

A budget-management report from United Way

At United Way, volunteers carefully review the budgets, operating patterns and track record of agencies asking to become part of the United Way organization.

They scrutinize the various functions performed by the agency, look at the kinds of people it helps, and evaluate its success in delivering its services.

But what happens when a new service agency wants to become a United Way organization—especially when there may be two or more equally qualified organizations equally in need of United Way support? Who chooses? And on what basis?

The answer to this question is often complex. And sometimes it can be an agonizing decision to admit one agency instead of another.

The people decide

But the bottom line is that volunteers do make the decisions after carefully weighing all the pros and cons. It's sometimes a hard process, but it's as fair as we know how to make it.

Volunteers work free of charge doing everything from collecting money to deciding how it will be used, so administrative costs are kept low.

And that's how United Way works so well. And why.



United Way

Thanks to you, it works.
For all of us.



A Public Service of This Magazine & The Advertising Council

- CPM®
- IBM®
- APPLE®

DIRECT SOFTWARE™

DISCOUNT DIGEST

- CPM®
- IBM®
- APPLE®

TO ORDER CALL (415) 459-1282 • TOLL FREE (800) 533-3012 CA (800) 533-3011 USA

Direct Software™ Discount Prices Save \$\$ and Make Sense to Smart Buyers Who Know What They Want!!

DIRECT SOFTWARE™ MAKES PRIME PRODUCTS SO AFFORDABLE THAT THOSE IN-THE-KNOW WILL FIND IT UNWISE TO RESIST. OUR PRODUCTS ARE BACKED BY SUPPORT AND SERVICE, WITH SAME-DAY SHIPMENT ON MOST ORDERS. COMPARE OUR PRICES AND SAVE.

	List	Sale
ALPHA SOFTWARE		
Apple-IBM Connection	250	169
Data Base Manager	145	119
Data Base Manager II	295	249
Question	45	39
Typeface	125	79

ANDERSON — BELL		
ABSTAT	395	319

ASHTON-TATE		
dBASE II	700	398
Financial Planner	700	459
Friday	295	199

ASPEN SOFTWARE		
Grammatik	75	56
Proof Reader	50	38

A.T.I.		
Training WordStar	75	65
Training dBASE II	75	65
Training Multiplan	75	65

CDEX		
MYB-Lotus 1-2-3	70	60
MYB-Visicalc	70	60

ACCOUNTING M.B.S.I.

	List	Sale
Account Payable	650	459
Account Receivable	650	459
Payroll	650	459
Order Entry -		
Inventory Control	650	459
General Ledger	650	459
Sales Analysis	325	279
RM Cobol		169

I.U.S.

General Ledger	595	359
Account Receivable	595	359
Account Payable	595	359
Order Entry	595	359
Inventory Control	595	359
Payroll	745	359

DIGITAL MARKETING

Milestone	295	249
Datebook II	295	249
Footnote	129	109
Bibliography	125	109
Notebook	150	119
MICROLINK II	89	79

DIGITAL RESEARCH

	List	Sale
Concurrent CP/M 86	350	249
CB 80 Compiler	500	369
CBASIC	150	94
SID	75	63

FOX & GELLER

Quickcode	295	175
dGraph	295	175
dUtil	99	58

GKE

Condor 3	650	369
CROSSDATA	99	89

HUMANSOFT

DBPlus	125	89
--------	-----	----

IUS

Easy Filer	400	229
Easy Planner	250	179
Easy Writer II	350	199
Easy Speller	125	99
Easy Speller II	225	129

SPECIALS

	List	Sale
DBASE II + Quickcode	995	525
DBASE II + dUtil	799	429
DBASE II + DGraph	999	539
DBASE II + ABSTAT	1095	717
DBASE II + DBASE Window	949	599
DBASE II + WordStar	1195	629

WORDSTAR \$248 | dBase II \$389
MULTIPLAN \$159 | LOTUS \$319

LEXISOFT

Spellbinder	495	229
-------------	-----	-----

LIFETREE

Volkswriter	195	125
-------------	-----	-----

LOTUS

1-2-3	495	319
-------	-----	-----

METASOFT

Benchmark Word Processor	499	279
Benchmark Mail List	250	179

MICROPRO

WordStar	495	248
WordStar / MailMerge	645	347
WordStar / SpellStar	645	347
Professional Pak	845	395
InfoStar	495	258
InfoStar + CP/M Card	695	399
WordStar + CP/M Card	695	399
MailMerge	250	129
SpellStar	250	128
CalcStar	145	88

MICROSOFT

	List	Sale
Multiplan	250	159
BASIC Interpreter	350	249
BASIC Compiler	395	285
Softcard	345	248
Flight Simulator	50	38
Word/Mouth	475	399

MICROSTUFF

Crosstalk	195	117
-----------	-----	-----

OASIS

The Word Plus	150	105
Punctuation & Style	150	99

PERFECT SOFTWARE

Perfect Writer	489	249
Perfect Speller	289	159
Perfect Filer	589	249
Perfect Writer/Speller	695	359

PETER NORTON

Norton Utilities	80	58
------------------	----	----

SELECT Information Systems

Select Word Processor	495	259
-----------------------	-----	-----

SORCIM

SuperCalc	195	129
SuperCalc II	295	169
SuperSpellguard	195	125
SuperCalc III	395	319

TYLOG

dBase Window	249	189
dBase Door	149	119

VISICORP

Visicalc	250	169
Visicalc IV	250	169
Visicalc Advance	400	295

WOLF SYSTEMS

Move it (IBM)	150	98
Move it (CPM)	125	89

- Purchase orders accepted
- Prompt UPS service
- Dealer and institutional discounts
- Quantity discounts available
- Call for charges and return policy; Prices may change

Call today for our free catalog

TO ORDER CALL
(415) 459-1282

TOLL FREE
(800) 533-3012 CA
(800) 533-3011 USA

850 College Ave., Suite #3
Kentfield, CA 94904

Figure 2: A schematic of an S-100 interface and clock circuit for the BPK 72. The kit is used as though it were a single component. Only the edge connector is shown in this figure. The schematic placement of the edge-connector pins matches that of the actual physical component. The completed project functions as either a disk emulator or a cache memory system.

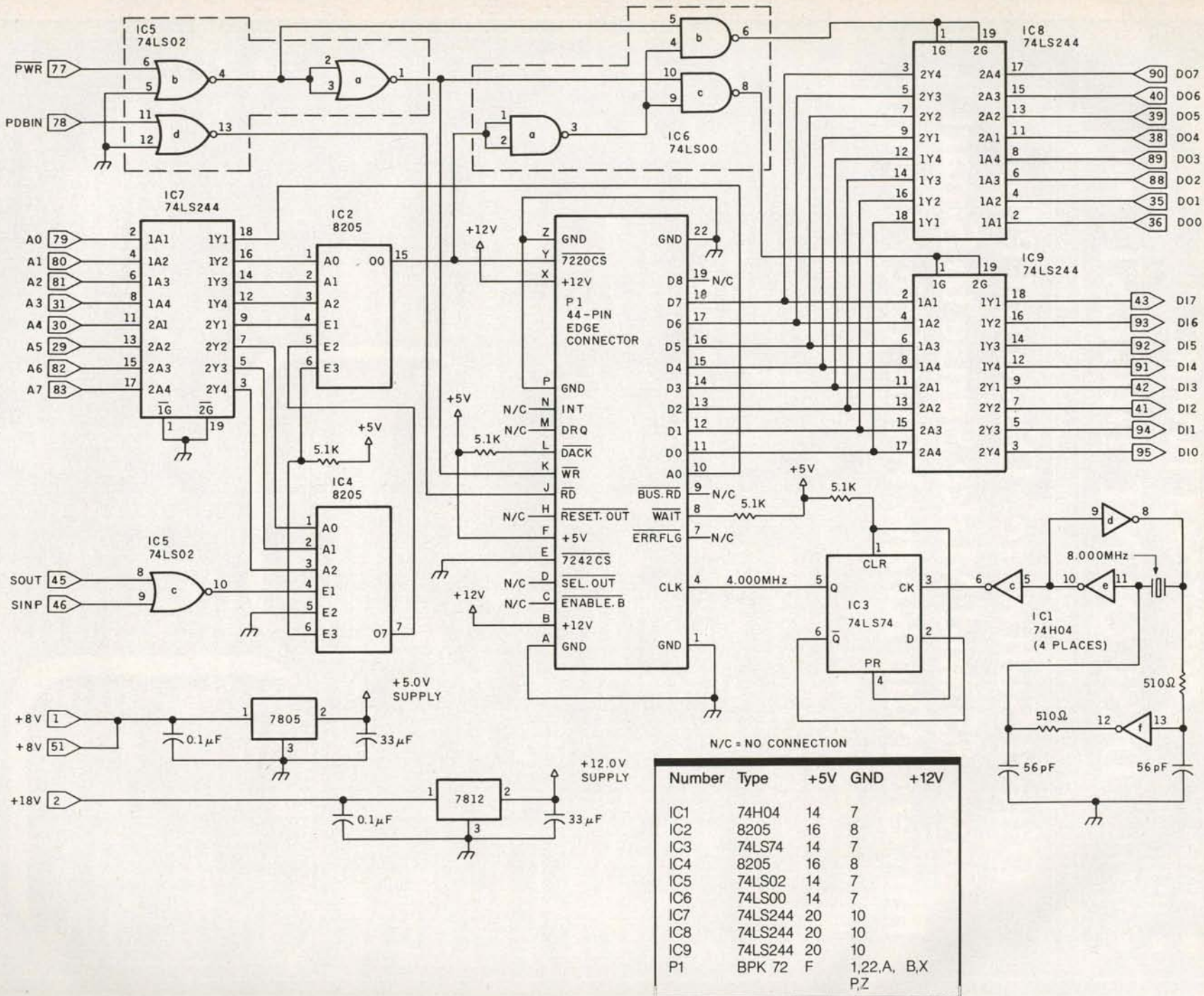

multiplexed data bus into separate input and output buses according to S-100 conventions.

The 4-MHz clock circuit, ICs 1 and 3 (oscillator/divider, respectively), is the circuit suggested in the application note supplied with the kit. It should be constructed with care, keeping the leads as short as possible. Note that the crystal is an 8-MHz series-resonant type, 0.1 percent tolerance, and should be a high-quality component. The clock frequency must be stable and within the narrow range of 3.996 to 4.004 MHz to assure that the bubble-memory rotational-field specification is met. This is more stringent than many digital-circuit clocks. The application note also calls for the use of a 74H04 inverter (IC1). Unable to obtain a 74H04, I tried a 74LS04, which *did not* work and resulted in a large number of read/write errors, plus an occasional timing error. However, when I substituted a 7404, everything worked well.

Several signals appearing on the BPK 72 edge connector (table 1) are not used in this project. Some of these signals, 7242 CS for example, are intended for use in systems employing more than one 7110 bubble memory. Others are intended for special applications. Two of these, DACK and DRQ, are for use in systems employing DMA. In small single-user systems such as mine, there is little or no advantage to using DMA (considering the added cost and complexity). If, on the other hand, you want to use the bubble memory for real-time data acquisition, DMA would become a necessity. As for interrupts, floppy-disk operating systems generally disable interrupts during disk-access operations. Therefore, no provision has been made for them. The software presented here also disables interrupts during read/write operations. If you want to use the interrupt system, it will be necessary to add an open-collector-type inverter, such as a 74LS05, connected between pin N of the edge connector and one of the S-100-bus interrupt lines.

It might appear that the RESET.OUT signal, pin H, should be

Pin Number	Signal Name	Description
1	GND	Ground (one of five).
2	—	Not used.
3	—	Not used.
4	CLK	Clock input for BMC and FSAs. Frequency should be 4.000 MHz +/- 0.1 percent with a duty cycle of 50 percent +/- 1 percent to assure that the bubble-memory rotational-field specifications are met.
5	—	Not used.
6	—	Not used.
7	ERR.FLG	A signal generated by the FSA to inform the BMC of an error condition. Used in multibank systems.
8	WAIT	A bidirectional signal used in systems with multiple BMCs, allowing them to inform each other of an error condition.
9	BUS.RD	Input/output mode signal used between BMC and FSA.
10	A0	An address bit that selects which BMC register is involved. If A0 is a "1," the command, status, or register address counter is selected. If A0 is a "0," the parametric registers are being addressed.
11	D0	Bidirectional data bus carrying data between the user's system and the BMC.
12	D1	Data bus.
13	D2	Data bus.
14	D3	Data bus.
15	D4	Data bus.
16	D5	Data bus.
17	D6	Data bus.
18	D7	Data bus.
19	D8	Parity bit for the data bus. The BMC checks D8 for odd parity coming from the user's system and generates odd parity for data transferred from the bubble memory.
20	—	Not used.
21	—	Not used.
22	GND	Ground.
A	GND	Ground.
B	+12V	+12-volt supply (one of two).
C	ENABLE.B	The same as ENABLE.A, a signal used to select the 7230 Current-Pulse Generator and the 7250 Coil Predriver. Not used.
D	SELECT.OUT	Used in multibank systems to select the next 7240 FSA in the FSA daisy chain.
E	7242 CS	Used in multibank systems as the chip-select signal for FSA bank select. In single-bank systems, it should be tied low.
F	+5V	+5-volt supply.
H	RESET.OUT	Initiates the Reset sequence to the BMC and support circuitry. After a Reset sequence is completed, the next BMC command must be an INITIALIZE or ABORT followed by an MBM PURGE command.
J	RD	Input signal to indicate to the BMC that the user wishes to read one of the user-accessible registers.
K	WR	Input signal to indicate to the BMC that the user wishes to write to one of the user-accessible registers.
L	DACK	DMA acknowledge signal; indicates to the BMC that the next memory cycle is available for data transfer. If not used, it must be pulled up to V _{cc} with a 5.1K-ohm resistor.
M	DRQ	The data-transfer request signal; it indicates to the user system that the BMC is ready to transfer 1 byte of data to/from the user system when in the DMA mode; otherwise, it indicates that 22 bytes can be transferred.
N	INT	Interrupt line from the BMC to the user system. It indicates a change in the BMC status and requires service.
P	GND	Ground.
R through W	—	Not used.
X	+12V	+12-volt supply.
Y	7220 CS	The BMC chip-select signal. Except during DMA operations, a high disables the BMC. When disabled, only RESET.OUT affects the BMC.
Z	GND	Ground.

Table 1: Pin locations and signals for the bubble-memory card. Note the missing letters in the Pin Number column. This is the standard numbering sequence for 44-pin cards. Many of the signals are not used in this S-100 bubble-memory project.

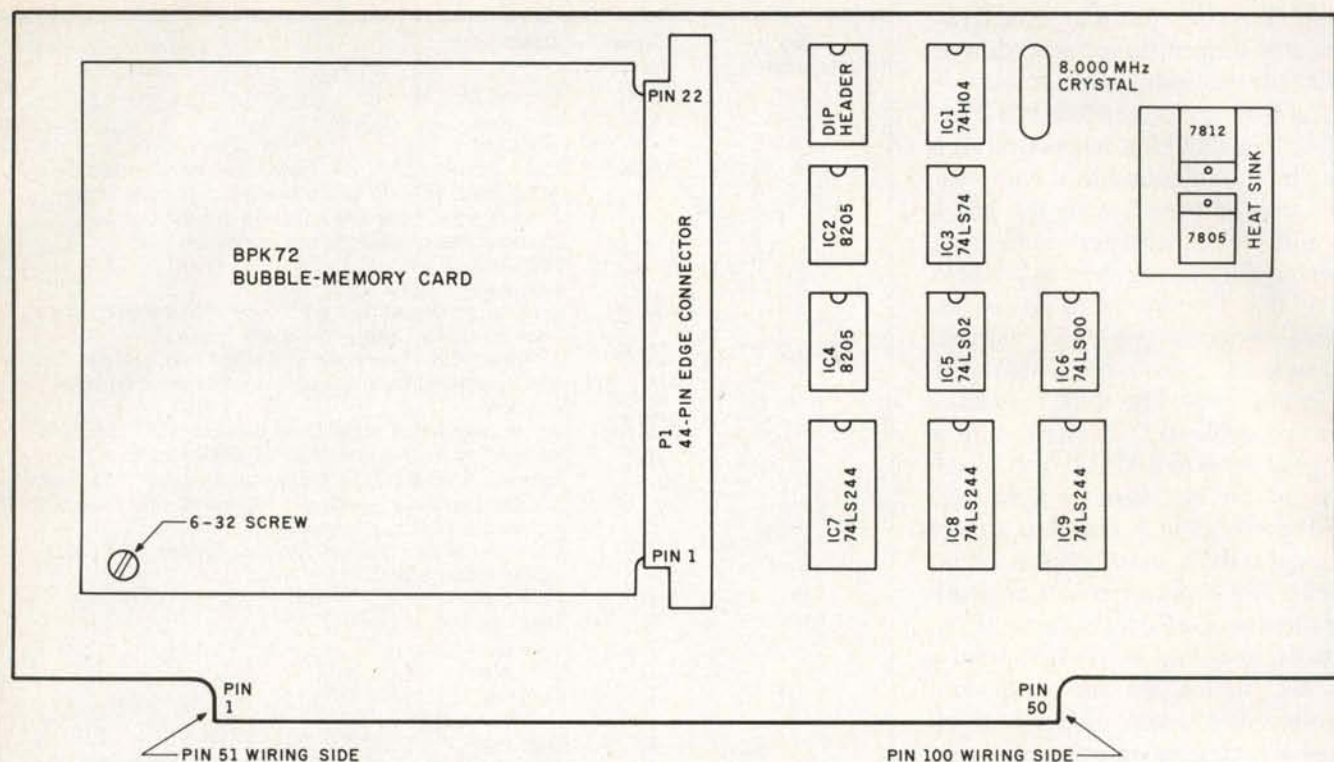

Figure 3: The S-100 bubble-memory board parts layout shown here minimizes the length of signal lines.

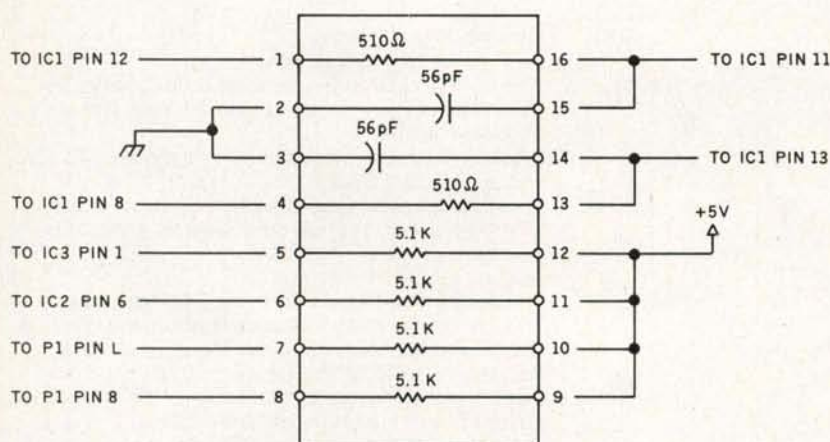

Figure 4: This top view of the DIP header wiring diagram includes all the resistors and capacitors (except power-supply bypass capacitors) shown in the figure 2 schematic. All resistors are 1/4 watt.

connected to the computer's Reset line. This is not the case. The RESET.OUT signal is an output signal from the on-board power-fail circuit, and, therefore, it should be left floating. To tie it directly to the computer's Reset line causes the on-board power-fail circuit to malfunction. Proper operation of the power-fail circuit is essential to the bubble memory's retention of data should the power fail and during the normal power-down sequence. It provides for an orderly

shutdown of the bubble-memory system.

Parts Layout

Physical placement of the BPK 72 circuit board and interface components, figure 3, is designed to minimize the length of the signal lines. Looking at the component side of the S-100 wire-wrap board, most of the S-100-bus signals appear on the right-hand side of the signal pins. Therefore, to keep signal lines short,

the S-100 interface circuit was located on the right and the BPK 72 PC card on the left. For the same reason, 74LS244 bus buffers (ICs 7, 8, and 9) were located at the bottom of the board closest to the signal pins. Because the oscillator has no off-board connections, it was located at the top of the S-100 board. All resistors and capacitors, except bypass capacitors, are mounted on a DIP (dual-inline package) header (figure 4).

S-100 Board Construction

The BPK 72 PC card is piggybacked onto the S-100 wire-wrap board (photo 3). To prevent shorting out of the foil side, I used a Vector Electronics wire-wrap board without foil pads or bus lines (VC8801-1). The 44-pin edge connector for the bubble-memory card presented the greatest problem in construction. I was unable to locate an edge connector with wire-wrap pins long enough to be bent at right angles, pass through the holes in the S-100 wire-wrap board, and still have sufficient length to accommodate two layers of wire-wrap. I solved the problem by using an edge connector with solder tails

How to make your Apple run 3½ times faster.



Just plug in the Accelerator II® and watch your Apple® II or II Plus take off.

Imagine running VisiCalc®, DB Master®, Applesoft, Apple Fortran or Pascal without long delays. With the Titan Accelerator II, your Apple II or II Plus runs these programs a true 3½ times faster. The Accelerator II also runs your Franklin, Basis and other Apple II compatibles 3½ times faster. This faster computer response time means less waiting for you and an increase in your productivity.

This Titan exclusive has its own fast 6502 processor, 64K of high-speed memory, and built-in fast language card. It is transparent to your software and is hardware compatible with most standard peripherals. And you can turn it off from the keyboard to run your Apple at regular speed.

Find out how to run faster and increase your productivity without breathing hard. For information on the Accelerator II and other Titan microcomputer products, see your computer dealer or contact: Titan Technologies, Inc., P.O. Box 8050, 3990 Varsity Dr., Ann Arbor, MI 48107; Telephone (313) 662-8542.



Titan
TECHNOLOGIES, INC.
FORMERLY SATURN SYSTEMS OF MICHIGAN

Attention dealers. Ask us about our special demonstrator unit offer.

Sales and marketing by The MARKETING RESOURCE GROUP, Costa Mesa, CA.

Apple is a registered trademark of Apple Computer, Inc. VisiCalc is a registered trademark of VisiCorp, Inc. DB Master is a registered trademark of Stoneware, Inc.

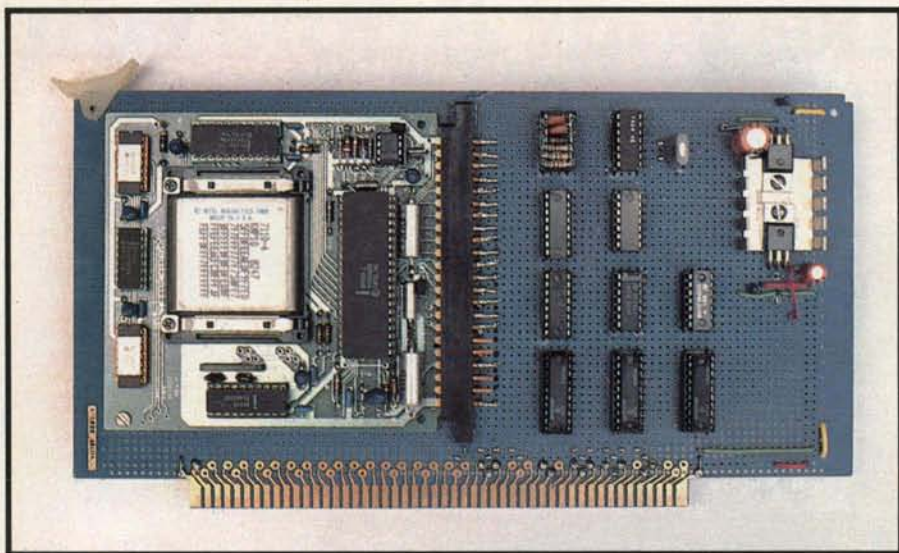

Photo 3: The completed S-100 bubble-memory board's component side with the BPK 72 installed (see figure 4 for the parts layout).

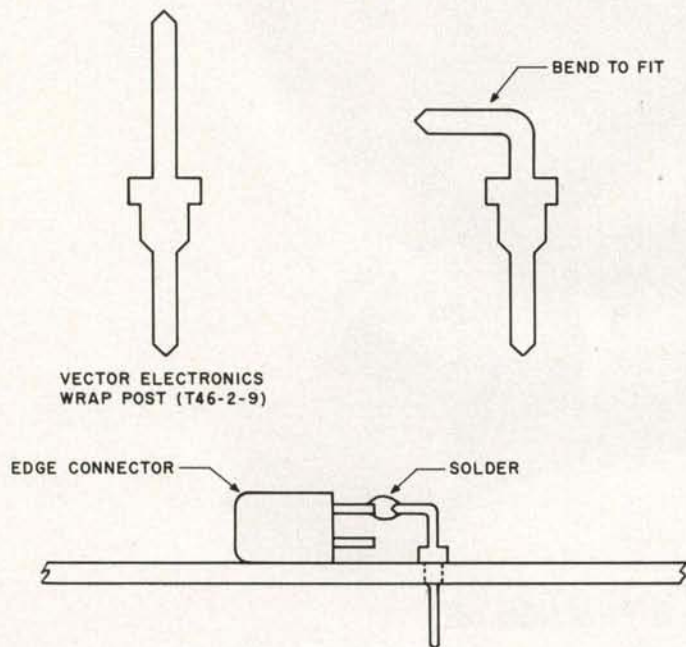

Figure 5: A detailed view of the edge-connector fabrication using wire-wrap posts. Alternatively, the wiring could be brought up through the S-100 plug-board holes. See the text for details.

and then bending wire-wrap posts (Vector Electronics T46-2-9), inserting them in the plug-board holes and soldering them to the solder tails on the edge connector, as shown in figure 5. Alternatively, an edge connector with wire-wrap pins can be used by passing the wires up through the holes in the S-100 wire-wrap board. I chose the first method, and the results are not as neat as I would have liked.

The 44-pin edge connector and all the IC sockets were attached to the S-100 wire-wrap board using one of the super glues. This type of adhesive has the advantage of being quick-setting and is strong enough for the task, yet it can be broken loose with moderate pressure applied with a screwdriver, in case of error or a change in design.

In order to provide additional mechanical stability for the BPK 72

card, I secured it to the S-100 board as follows: looking at the component side of the BPK 72 card positioned with the pins at the bottom, a small hole is in the clear area at the top left-hand corner. I enlarged the hole and drilled a matching hole in the S-100 wire-wrap board. After inserting the BPK 72 card in the edge connector, I secured the card to the S-100 board using a 6-32 screw and two nuts, with one nut between the two boards to serve as a spacer.

The power supply presented no special problems. The use of a heat sink for the two regulators is optional. I used red, yellow, and green insulated wire to indicate +5 volts (V), +12 V, and ground (GND), respectively, and white for signals (see photo 4). It makes tracing the wiring a little easier. Only two bypass capacitors are shown in the schematic, but more may be required, as discussed later. If your computer's power supply is small and/or heavily loaded, you may find it necessary to increase the value of the two 33-microfarad (μF) capacitors, as it is essential for correct operation of the power-fail circuit that the supply voltages not drop at too rapid a rate when either the computer is turned off or the power fails.

Preliminary Testing

Before installing the BPK 72 card in the edge connector or any of the interface ICs, install the S-100 board in the computer (an extender board is useful in making the following checks). Using an oscilloscope, check the output of the +5- and +12-V regulators for the correct voltage and any sign of noise. Also check for +5 V on edge-connector pins 8, F, and L, and +12 V on pins B and X. Remove the S-100 board from the computer and use an ohmmeter to check the edge-connector pins 1, 22, A, E, P, and Z for ground.

Next, install all the ICs—but not the BPK 72 card yet. Reinstall the S-100 board in the computer and then check the power-supply voltages again. If any noise is evident, bypass capacitors should be added to clean things up. Try 0.1 or 0.01 μF , if needed.

How to make your IBM run 2½ to 4 times faster.



Just plug in the Accelerator PC™ and watch your IBM* PC or XT take off.

Yes, Titan's done it again. The innovators who speeded up the Apple® now bring similar performance advantages to IBM users. Imagine running Lotus® 1-2-3™, VisiCalc®, or Multiplan™ without long delays. With the Titan Accelerator PC, your IBM PC or XT can run all your software faster. Data bases, word processors, spreadsheets, graphics, and much more will speed up by a factor of 2½ to 4 (average around 3).

The Accelerator PC has a 10 MHz 8086 processor and 128K of high-speed RAM, expandable to 640K with the memory upgrade piggyback option. It's compatible with your present hardware and software, and designed to be ready for future enhancements.

Get your work done in a third of the usual time.

See your computer dealer today or contact: Titan Technologies, Inc., P.O. Box 8050, Ann Arbor, MI 48107; Telephone (313) 662-8542.

 **Titan**
TECHNOLOGIES, INC.
FORMERLY SATURN SYSTEMS OF MICHIGAN

Sales and Marketing by The MARKETING RESOURCE GROUP, Fountain Valley, CA.

IBM is a registered trademark of International Business Machines Corporation. Lotus and 1-2-3 are trademarks of Lotus Development Corporation. Multiplan is a trademark of Microsoft Corporation. Apple is a registered trademark of Apple Computer Inc. VisiCalc is a registered trademark of VisiCorp, Inc. Accelerator PC is a trademark of Titan Technologies, Inc.

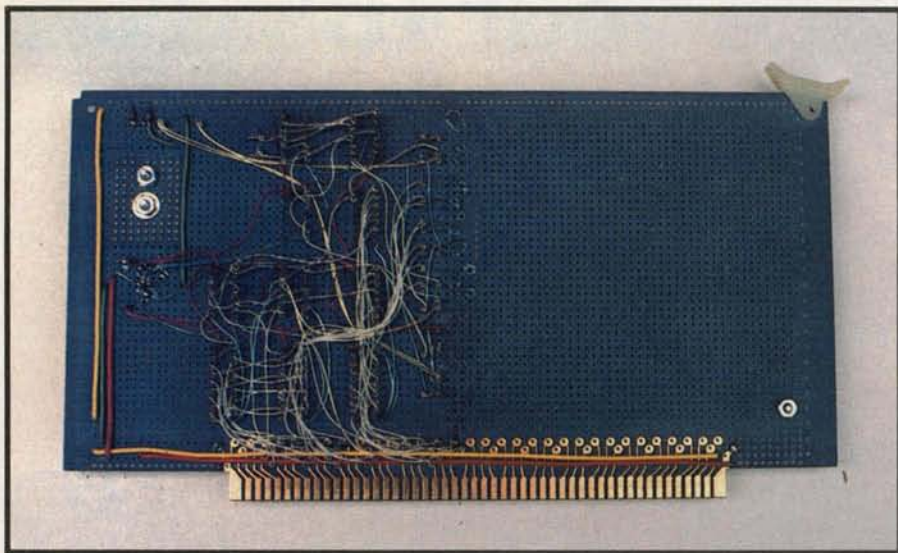

Photo 4: The wiring side of the S-100 bubble-memory board. The following color code applies: red = +5 volts, yellow = +12 volts, green = ground, and white = signal.

Using a 10-MHz, or higher, bandwidth oscilloscope, observe the 8-MHz oscillator output, pin 6 of IC1. The signal should be a reasonably clean square wave. If a frequency counter is available, measure the frequency; it should be between 7.992 and 8.008 MHz. Next, observe the clock signal on pin 4 of the edge connector. Without a load, some ringing may be evident; the frequency should be one-half the oscillator frequency.

If you haven't already done so, install the dummy module in the 7110 bubble-memory socket. The dummy module is an electrical equivalent of the 7110 bubble memory. It is intended to prevent accidental burnout of the 7110 bubble-memory chip during testing. Like the bubble-memory chip itself, it is keyed and can be installed only one way; the resistors should be visible once it is in place. A table of pin-to-pin resistances is in the users manual to check the module.

Turn off the power and insert the BPK 72 card in the edge connector and the S-100 board in the computer. At this point, a series of tests detailed in an application note (AP-119 supplied with the kit) should be conducted. The first test ascertains whether the power-fail circuit is functioning correctly by observing the RESET.OUT signal, pin 2 of the 7220 BMC. If there's a problem, you should not proceed with the remain-

ing tests until the problem has been corrected.

The remaining tests call for the use of a program to condition the 7220 BMC and to determine its status. The software presented in the application note is written in 8088/8086 assembly language. However, the microprocessor I used is a Z80, and considerable differences exist between the two assembly languages. Rather than spend time translating routines that would only be used for the tests

**A seed is a permanent
bubble from which
other bubbles are
generated to represent
binary ones.**

and then discarded, I decided to use BASIC INP and OUT commands. The idea worked just fine. In fact, I found that all bubble-memory operations can be performed using BASIC, except the actual transfer of data to/from the bubble memory. The reason that data cannot be transferred is that a BASIC interpreter is just not fast enough to keep up with a data-transfer rate of 100,000 bps, and this results in timing errors. The BASIC program in listing 1 is a collection of subroutines that I used for these tests. All that is required to use the program is to change the series

of GOSUBs (lines 1070 through 1100) to select the desired functions for each test. Details of the tests themselves, along with the expected results, are spelled out in the application note, so I won't repeat them here.

All the BASIC programs presented in this article were written for Micropolis BASIC, which uses a slightly different form of INP and OUT commands. The following examples demonstrate how the instructions appear in Micropolis BASIC along with the more general form used in other BASICs (assume "P" is the I/O port to be addressed and "D" is the data to be written/read):

Micropolis BASIC	Other BASICs
OUT(P)=D	OUT P,D
D=IN(P)	D=INP(P)

Non-Micropolis BASIC users will have to revise the programs accordingly.

The last three tests in the series call for a program to cause certain signals to be generated. This can also be accomplished using the simple BASIC program in listing 2. The signal waveforms (as shown in the application note) are to be observed on various pins of the 7110 bubble-memory socket, which presented a problem because the solder side of the BPK 72 card is inaccessible when mounted on the S-100 board. Fortunately, all the test points can be found on the face of the dummy module. Location of the test points is easily determined from the schematic of the dummy module found in the users manual.

Final Testing

After successfully completing the preliminary tests, the next step is to install the 7110 bubble-memory chip. Power down and remove the dummy module, then install the 7110 bubble-memory chip. When power is reapplied, again monitor the RESET.OUT signal on pin 2 of the 7220 BMC. It should perform exactly as it did with the dummy module installed.

Before placing the bubble-memory system in operation, one final test is to be performed. Again using the test program in listing 1, load (write) the

Listing 1: A collection of BASIC subroutines for preliminary testing of the BPK 72 Bubble-Memory Prototype Kit. The GOSUBs (lines 1070 through 1100) must be changed for each test.

```

1000 REM ===== BPK-72 TEST =====
1010 REM
1020 D=224 :REM Data Port address
1030 S=225 :REM Status Port address
1040 REM -----
1050 GOSUB 1130 :REM Write Parametric registers.
1060 GOSUB 1200 :REM Display status.
1070 REM
1080 REM Insert additional GOSUB's to select the
1090 REM desired function and function order.
1100 REM
1110 STOP: END
1120 REM -----
1130 REM ----- WRITE REGISTERS
1140 REM -----
1150 OUT(S)=11 :REM Select 'B' register.
1160 DATA 01,10,00,00,00
1170 FOR I=1 TO 5: READ D1: OUT(D)=D1: NEXT I
1180 RETURN
1190 REM -----
1200 REM ----- DISPLAY STATUS [ IN HEX ]
1210 REM -----
1220 S0=IN(S) :REM Input status.
1230 GOSUB 1270
1240 PRINT "STATUS = ";CHAR$(S1);CHAR$(S2)
1250 RETURN
1260 REM ----- CONVER DEC TO HEX
1270 S1=INT(S0/16)+48
1280 IF S1>57 THEN S1=S1+7
1290 S2=(S0 AND 15)+48
1300 IF S2>57 THEN S2=S2+7
1310 RETURN
1320 REM -----
1330 REM ----- WRITE 7220 FIFO
1340 REM -----
1350 FOR N=1 TO 40: OUT(D)=N: NEXT N
1360 RETURN
1370 REM -----
1380 REM ----- READ 7220 FIFO
1390 REM -----
1400 FOR I=1 TO 42
1410 S0=IN(D) :REM Get a byte from FIFO
1420 GOSUB 1270 :REM Convert to Hex
1430 PRINT CHAR$(S1);CHAR$(S2);" ";
1440 NEXT I
1450 PRINT
1460 RETURN
1470 REM -----
1480 REM ----- 7220 CONTROLLER COMMANDS
1490 REM -----
1500 INPUT "ENTER COMMAND (IN HEX): "; C$
1510 C=0: IF LEN(C$)<>2 THEN STOP
1520 T=ASC(LEFT$(C$,1)): GOSUB 1560
1530 C=C*16
1540 T=ASC(RIGHT$(C$,1)): GOSUB 1560
1550 RETURN
1560 IF T=>48 AND T<=57 THEN C=C+(T AND 15)
1570 IF T=>65 AND T<=70 THEN C=C+((T AND 15)+9)
1580 RETURN

```

Listing 2: A simple BASIC program to generate the signals required for testing the BPK 72.

```

1000 REM ===== COIL DRIVE SIGNAL GENERATOR =====
1010 REM
1020 D=224 :REM Data Port address

```

Listing 2 continued on page 380

How To Expand Your IBM®

Exclusive six-function card expands workspace, increases speed, and boosts memory up to 576K.

The TITAN™ is the only expansion card that gives your IBM PC or XT both hard disk SASI interface and a parallel printer port. This advanced package also includes a pair of RS-232C serial ports, real-time clock/calendar with battery back-up, plus a choice of memory expansions. And everything slips into a single slot!



Pick a TITAN with parity-checked dynamic RAM from 64K to 576K. Each comes ready to run, complete with four super software selections. PSEUDO-DISK™ makes the RAM act like an exceptionally fast disk drive. PSEUDO-PRINT™ print spooler lets your computer calculate while the printer is running. WHATIME™ keeps track of date and time so you don't have to enter them at each system restart. HARDISK™ makes a 10MB Winchester addition plug-in easy.

Yes, it's a lot for one slot. And it's available now to add new utility to your IBM system.

Let us help you expand your IBM's productivity. For information on our multi-function boards and other Titan microcomputer products, see your computer dealer or contact: Titan Technologies, Inc., P.O. Box 8050, Ann Arbor, MI 48107; Telephone (313) 662-8542.

Sales and Marketing by The MARKETING RESOURCE GROUP, Costa Mesa, CA.



IBM PC and XT are registered trademarks of International Business Machines Corp.
TITAN, PSEUDO-DISK, PSEUDO-PRINT, WHATIME, and HARDISK are trademarks of Titan Technologies, Inc.

NEW 68000

WICAT System 140



- Motorola 68000
- 512KB memory
- 10MB Winchester
- 616KB floppy
- MCS Operating System
- Language

\$7950

A powerful but low-cost single-user multitasking computer, the WICAT 140 is an excellent general-purpose system especially suited for heavy calculation.

FOR WICAT USERS now available:

- LEX68™ word processing, works with all terminals (available in 8 languages)
- cSTAT™ full statistical tools for researchers
- cACCOUNT™ accounting software (GL, AR, AP, PR, OE), no programming needed to tailor system
- TOTALCARE™ complete medical office system

Call or write for our newsletter describing software and hardware available through Concurrent



Concurrent™ Corporation
1870 Madison Road Cincinnati, Ohio 45206
(513) 281-2000 • TELEX 701492

HIGH-PERFORMANCE MICRO COMPUTERS FOR SCIENCE AND INDUSTRY

LEX68 is a trademark of ACE Microsystems, Ltd.; cSTAT, cACCOUNT, intergral, and MenuSystem are trademarks of Concurrent Corporation

Listing 2 continued:

```
1030 S=225 :REM Status Port address
1040 REM -----
1050 INPUT "GENERATE READ OR WRITE SIGNALS (W/R): ";C$
1060 OUT(S)=25: OUT(S)=30: OUT(S)=29 :REM Clear 7220
1070 REM -----
1080 REM ----- WRITE REGISTERS -----
1090 REM -----
1100 OUT(S)=11 :REM Select 'B' register.
1105 RESTORE
1110 DATA 01,16,08,00,00
1120 FOR I=1 TO 5: READ D1: OUT(D)-D1: NEXT I
1130 REM -----
1140 IF C$="W" GOTO 1230
1150 REM -----
1160 REM ----- GENERATE READ SIGNAL -----
1170 REM -----
1180 OUT(S)=18 :REM Send read command (12 Hex)
1190 K=IN(D)
1200 IF (IN(S) AND 32) = 0 GOTO 1190
1210 GOTO 1180
1220 REM -----
1230 REM ----- GENERATE WRITE SIGNAL -----
1240 REM -----
1250 OUT(S)=19 :REM Send write command (13 Hex)
1260 OUT(D)=255
1270 IF (IN(S) AND 128) <> 0 GOTO 1260
1300 GOTO 1100
```

parametric registers and display the status. You should obtain a status of 40 hexadecimal, indicating that operation is complete. The test program can then be modified by changing the DATA statement and GOSUBs to permit checking the seeds, as described in the application note. A seed is a permanent bubble in the magnetic-bubble memory, from which other bubbles are generated to represent binary ones. Checking the seeds also checks the boot loop written into the bubble memory at the factory and listed on top of the 7110 bubble-memory chip. As I explained earlier, the boot loop maps defective and unused data loops. Should there be an error in the boot loop, a simple procedure in the users manual shows how to rewrite it. If one of the seeds is missing, things become a bit more complicated. Missing seeds can be restored, but a special hardware subassembly, supplied with the kit, must be used. This procedure is also explained in the users manual. I did not experience any difficulty with either the boot loop or the seeds.

Next Month

This concludes part 1 of this article. Next month, we'll go beyond the con-

struction and preliminary testing into the software requirements needed to make the magnetic-bubble-memory board work with Micropolis MDOS and CP/M. ■

[Editor's Note: As this article went to press, Intel announced a change in the configuration of its BPK 72 Bubble-Memory Prototype Kit. Now labeled the BPK 72A, this kit comes assembled and tested, but you still must add an edge connector, an S-100 bus interface, and power-supply circuitry as described here. A different testing procedure is required, but it, too, is documented in the new kit. The current chip uses a socketed leadless package, but a chip with leads (no socket) and clock should be available in January.]

The BPK 72A kit is available for use in three temperature ranges: Standard, BPK 72A-1 (0-75°C), Commercial, BPK 72A-4 (10-55°C), and Military, BPK 72A-5, (-2-+85°C). As a promotional item, Intel is offering the Commercial kit for \$199 through any local Intel distributor. If your computer environment holds within the 50-131°F temperature range, the Commercial kit could provide 128K bytes of nonvolatile memory at considerable savings.]

Louis Wheeler is a retired federal government employee. He spent 14 years as a programmer, teacher, and manager of minicomputer systems. His special interest is data processing, in which he has an associate degree. He can be contacted at 1323 Tamera Dr., Oceano, CA 93445.

WHY PAY MORE FOR LESS?

SUNOL SYSTEMS announces Winchester storage break-through

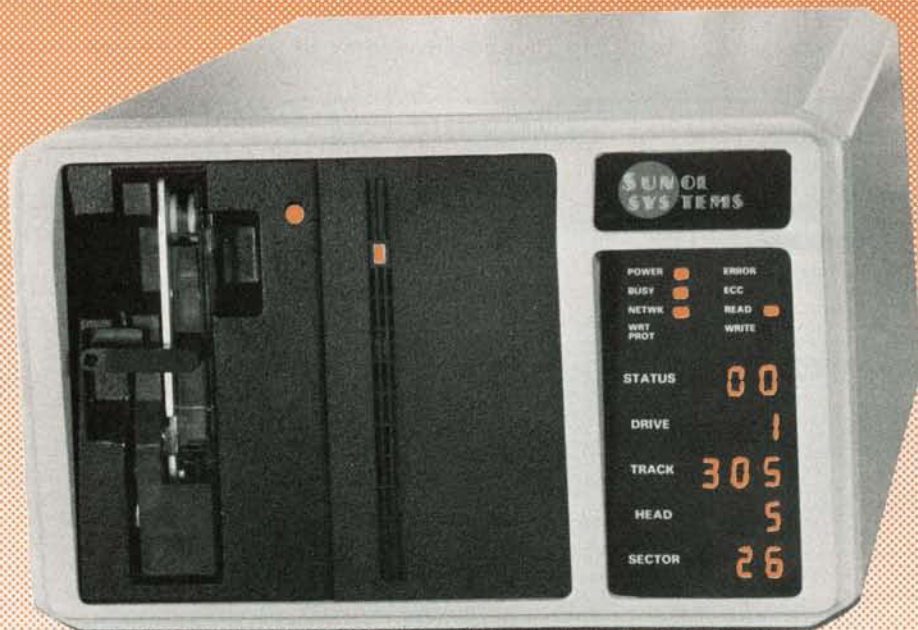

Totally Corvus Compatible

- **Over 20 Host Adapters Available**

S-100	Apple II, III
IBM P.C.	North Star
Altos	Victor
DEC	TRS-80 Models I, II, III
Osborne	Zenith Z89/90/100
Xerox 820	Texas Instruments
Atari 800	NEC PC-8000

Plus Many More

- **Up to 60% More Useable Storage**

Using Run Length Limited Coding
8, 16, 25, 35, and 51 Megabytes/Drive of
useable storage capacity (up to 4 drives
per controller for a total of 204 Mega-
bytes.)

- **Local Area Network**

Omninet™ Compatible

- **Multiplexer**

Up to 64 users

- **Integral Removable Back-Up**

Optional 32 Megabyte Removable Tape
Cartridge

- **High Reliability**

Error Correction Code and Off-Line
Diagnostics.

- **Comprehensive Display**

Dynamic display of the Drive, Status,
Track, Head, Sector and much more

- **High Performance**

50% Faster data transfer Rate 7.5 Mega-
bits/Second
Large 16K Byte Data Buffer

Major Pricing Break-through, starting at \$1,995.

Visit your local dealer for complete information or call or write. Dealer inquiries welcome.

Sunol Systems, 1072 Serpentine Lane, P.O. Box 1777, Pleasanton, CA, 94566, (415) 484-3322.

International Distributors:

HONG KONG: Convergent Microsystems
Unit 713 Hunghom Com. Ctr.
T.W.A. Ma Tau Wei Rd.
Kowloon, Hong Kong
Telephone: (3) 636397

CANADA: McKenzie Brown Ltd.
267 Richmond St. West
Toronto, Ontario M5V1W9
Telephone: (416) 593-6880

BELGIUM: Ditex Diffusion
Rue Grisar 46
1070 Brussels
Telephone: 524-01-53

Apple is a registered trademark of Apple Computers Inc.; IBM is a registered trademark of International Business Machines Corp. Xerox is a registered trademark and Xerox 820-II are trademarks of the Xerox Corp. Atari is a registered trademark and Atari 800 is a trademark of Atari Inc. Osborne is a trademark of the Osborne Corp. North Star is a trademark of North Star Computers Inc. Corvus Systems and Omnet are trademarks of Corvus Systems Inc.

COMPUTER MAIL ORDER

TERMINALS

910	\$519.00
910 Plus	\$599.00
914	\$569.00
924	\$689.00
925	\$739.00
950	\$929.00
970	\$1039.00

COMPUTERS

Teleport Portable	CALL
800A	\$1099.00
802	\$2699.00
803	\$1949.00
802H	\$4695.00
806/20	\$4999.00
816/40	\$9199.00
1602	\$3399.00
1603	CALL



SANYO

MBC-550 PC	CALL
MBC-555 PC	CALL
MBC 1100	\$1599.00
MBC 1150	\$2099.00
MBC 1200	\$1999.00
MBC 1250	\$2399.00
FDD 3200-320K Drive	\$399.00
FDD 6400-64K Drive	\$499.00
PR 5500 Printer	\$699.00

MONITORS

AMDEK	
300 Green	\$149.00
300 Amber	\$159.00
310 Amber	\$169.00
Color 1	\$279.00
Color 1 Plus	\$299.00
Color 2	\$399.00
Color 2 Plus	\$419.00
Color 3	\$349.00
Color 4	\$699.00

BMC	
12" Green	\$79.99
12" Green HI-RES	\$119.99
9191-13" Color	\$249.99

GORILLA	
12" Green	\$88.99
12" Amber	\$95.99

NEC	
JB 1260 Green	\$109.99
JB 1201 Green	\$149.99
JB 1205 Amber	\$159.99
JC 1215 Color	\$299.99
JC 1216 RGB	\$429.99

QUADRAM	
Quadchrome	\$499.99

TAXAN	
12" Green	\$119.00
12" Amber	\$129.00
Taxan 1 RGB	\$279.00

USI	
Pi 1, 9" Green	\$99.99
Pi 2, 12" Green	\$119.99
Pi 3, 12" Amber	\$149.99
Pi 4, 9" Amber	\$139.99
1400 Color	\$269.99

ZENITH	
ZVM 122 Amber	\$99.99
ZVM 123 Green	\$89.99
ZVM 135 Color/RGB	\$469.99

TeleVideo



Spirit XL Portable	\$3999.00
IIE-1	\$1369.00
IIE-2	\$1649.00
IIE-3	\$2399.00
IIE-4	\$3199.00
PC-E	\$1579.00
PC-1	\$2399.00
PC-2	\$2799.00
PC-XL	\$3599.00
1620	\$3599.00
1630	\$5499.00
1640	\$6499.00
Cyma Software	CALL



MODEMS ANCHOR

Mark I (RS-232)	\$79.00
Mark II (Atari)	\$79.00
Mark III (TI-99)	\$109.00
Mark IV (CBM/PET)	\$125.00
Mark V (Osborne)	\$95.00
Mark VI (IBM-PC)	\$169.00
Mark VII (Auto Ans/Auto Dial)	\$119.00
Mark XII (1200 Baud)	\$299.00
TRS-80 Color Computer	\$99.00
9 Volt Power Supply	\$9.00

HAYES	
Smartmodem 300	\$219.00
Smartmodem 1200	\$509.00
Smartmodem 1200B	\$459.00
Micromodem II	\$265.00
Micromodem II Plus	\$299.00
Micromodem IIE	\$269.00
Micromodem 100	\$299.00
Smart Com II	\$89.00
Chronograph	\$199.00

NOVATION	
J-Cat	\$99.99
SmartCat 103	\$179.00
SmartCat 103/212	\$399.00
AutoCat	\$219.00
212 AutoCat	\$549.00
Apple Cat II	\$249.00
212 Apple Cat	\$569.00
Apple Cat 212 Upgrade	\$309.00
Cat	\$139.99
D-Cat	\$149.00
PC-Cat	\$339.00

ZENITH	
ZT-1	\$369.00

APPLE INTERFACE CARDS & BUFFERS	
Choose from PKASO, Orange Micro, MPC, MicroMax, Tymac, Quadram & Practical Peripherals	CALL

IBM

NEC 3550.....\$1699.00 PERCOM/TANDON DRIVES

5 1/4" 320K Floppy	\$249.00
5 Meg Hard w/Controller	\$1399.00
10 Meg Hard w/Controller	\$1699.00
15 Meg Hard w/Controller	\$2095.00
20 Meg Hard w/Controller	\$2399.00

AMDEK

310A Amber Monitor	\$169.00
DX1 100 Plotter	\$599.00
Color II	\$399.00

AST RESEARCH, INC.

Six Pak Plus...from	\$279.00
Combo Plus II...from	\$279.00
Mega Plus...from	\$309.00
I/O Plus II...from	\$139.00

QUADRAM

Quadlink	\$549.00
Quadboard...as low as	\$289.00
Quad 512 Plus...as low as	\$249.00
Quadcolor...as low as	\$219.00
Chronograph	\$89.00
Parallel Interface Board	\$89.00
64K RAM Chips Kit	\$59.00

MICRO PRO

WordStar/Mail Merge	\$369.00
InfoStar	\$299.00
SpellStar	\$159.00
CalcStar	\$99.00

MICROSTUF

Crosstalk	\$105.00
-----------	----------

MICROSOFT

Multiplan	\$159.00
-----------	----------

pfs

APPLE	
Write	79.00 89.00
Graph	79.00 89.00
Report	79.00 79.00
File	79.00 89.00
Solutions* as low as	16.00 16.00
*Call On Titles	

PRINTERS

AXIOM	
AT-100 Atari Interface	\$249.00
CD-100 CBM 64/VIC 20	\$249.00
GP-100 Parallel Interface	\$199.00

BMC	
401 Letter Quality	\$589.00
BX-80 Dot Matrix	\$269.00

CENTRONICS	
122 Parallel	\$499.00
739-1 Parallel	\$399.00
739-3 Serial	\$449.00

C.ITOH	
Gorilla Banana	\$209.00
Prowriter 8510P	\$379.00
Prowriter 1550P	\$679.00
A10 (18 cps)	\$69.00
F10-40	\$999.00
F10-55	\$1499.00

COMREX	
ComWriter II Letter Quality	\$549.00

DIABLO	
620 Letter Quality	\$949.00
630 Letter Quality	\$1749.00

DAISYWRITER	
2000	\$999.00
2500	CALL
Tractor Feed	\$109.00

EPSON	
MX-80FT, MX-100, RX-80, RX-80FT, FX-80, FX-100	CALL

IDS	
Prism 80...For Configurations	CALL
Prism 32...For Configurations	CALL

MANNESMAN TALLY	
160L	\$589.00
180L	\$799.00
Spirit 80	\$309.00



ASHTON-TATE

dbASE II IUS	
EasyWriter II	\$189.00
EasySpeller	\$119.00
EasyFilter	\$229.00
CONTINENTAL SOFTWARE	
1st Class Mail/Form Letter	\$79.00
The Home Accountant Plus	\$88.00

SYNAPSE

File Manager	\$89.00
--------------	---------

LOTUS

1-2-3	\$319.00
-------	----------

PROFESSIONAL SOFTWARE	
PC Plus/The Boss	\$379.00

VISICORP

IBM AP	
VisiCalc	159.00

VisiCalc 4	159.00
------------	--------

VisiCalc-Advanced	269.00
-------------------	--------

VisiWord/Spell	249.00
----------------	--------

VisiWord/Plot	199.00 199.00
---------------	---------------

VisiLink	169.00
----------	--------

VisiFile	199.00 169.00
----------	---------------

VisiSchedule	199.00 199.00
--------------	---------------

VisiIndex	159.00
-----------	--------

VisiPlot	135.00
----------	--------

VisiTerm	75.00
----------	-------

Desktop Plan	199.00 169.00
--------------	---------------

Bus. Forecast Model	75.00 75.00
---------------------	-------------

Stretch Calc	75.00 75.00
--------------	-------------

VisiTutor Calc	59.00 59.00
----------------	-------------

VisiTutor-Advanced	75.00 75.00
--------------------	-------------

VisiTutor Word	59.00 59.00
----------------	-------------

Vision Calc	249.00
-------------	--------

Vision Graph	129.00
--------------	--------

Vision Mouse	159.00
--------------	--------

Vision Host	319.00
-------------	--------

NEC	
8023 Dot Matrix	\$379.00

8025 Dot Matrix	\$669.00
-----------------	----------

2050 Letter Quality	\$999.00
---------------------	----------

3510 Serial/Letter Quality	\$1449.00
----------------------------	-----------

3530 Parallel/Letter Quality	\$1499.00
------------------------------	-----------

3550 IBM/Letter Quality	\$1699.00
-------------------------	-----------

7710/7730 Serial/Parallel	\$1949.00
---------------------------	-----------

OKIDATA	
82.83.84.92.93.2350.2410	CALL

SMITH CORONA	
TP-2	\$449.00

Tractor Feed	\$119.00
--------------	----------

SILVER REED	
500 Letter Quality	\$469.00

550 Letter Quality	\$699.00
--------------------	----------

STAR	
Gemini 10X	\$299.00

Gemini P15	\$449.00
------------	----------

Delta 10	\$559.00
----------	----------

Serial Board	\$75.00
--------------	---------

TOSHIBA	
TRANSTAR	CALL

PRINTER CABLES	
Available for Atari, Commodore, IBM, Apple, Epson, Kaypro, TeleVideo, Franklin, Eagle, Sanyo, Osborne, NEC, Zenith and many others. We supply all your computer needs!	

PAPER SUPPLIES	
1000 shts. 8 1/2 x 11 Tractor Paper	\$19.99

1000 shts. 14 1/2 x 11 Tractor Paper	\$24.99
--------------------------------------	---------

1 or 2" Address Labels	\$9.99
------------------------	--------

= WEST = = CANADA = = EAST =

800.648.3311 800.268.4559 800.233.8950



In NV call (702)588-5654, Dept. 0101
Order Status Number: 588-5654
P.O. Box 6689, Stateline, NV 89449

In Toronto call (416)828-0866, Dept. 0101
Order Status Number: 828-0866
2505 Dunwin Drive, Unit 1B
Mississauga, Ontario, Canada L5L1T1

In PA call (717)327-9575, Dept. 0101
Order Status Number: 327-9576
Customer Service Number: 327-1450
477 E. Third St., Williamsport, PA 17701

No risk, no deposit on C.O.D. orders. Pre-paid orders receive free shipping within the UPS continental United States with no waiting period for certified checks or money orders. Add 3% (minimum \$5.00) shipping and handling on all C.O.D. and credit card orders. Larger shipments may require additional charges. NV and PA residents add sales tax. All items subject to availability and price change. We stock manufacturer's and third party software for most all computers on the market. Call today for our catalog.

COMPUTER MAIL ORDER



APPLE/FRANKLIN DISK DRIVES

MICRO-SCI	
A2	\$219.00
A40	\$299.00
A70	\$319.00
C2 Controller	\$79.00
C47 Controller	\$89.00

RANA	
Elite 1	\$279.00
Elite 2	\$389.00
Elite 3	\$569.00

APPLE IIe STARTER PACK
64K Apple IIe, Disk Drive & Controller,
80 Column Card, Monitor II & DOS 3.3
COMPLETE \$1499.00



HOME COMPUTERS



600XL..... \$189
800XL..... \$299

1200XL CALL
1400XL CALL

Commodore

CBM 4032	\$599.00
CBM 8096	\$869.00
CBM 9000	\$999.00
B128-80	\$769.00
CBM 64K Memory Board	\$269.00
8032 to 9000 Upgrade	\$269.00
2031LP Disk Drive	\$299.00
8050 Disk Drive	\$949.00
8250 Disk Drive	\$1199.00
4023 Printer	\$379.00
8023 Printer	\$569.00
6400 Printer	\$1399.00
Z-RAM	\$499.00
Silicon Office	\$699.00
The Manager	\$199.00
Soft ROM	\$125.00
VisiCalc	\$159.00

CBM 8032

\$ 599
CBM 64 \$199
VIC 20 CALL



C1541 Disk Drive	\$249.00
C1530 Datasette	\$69.00
C1520 Color Printer/Plotter	\$169.00
C1525 Dot Matrix/Parallel	\$219.00
C1526 Dot Matrix/Serial	\$279.00
C1702 Color Monitor	\$249.00
C1311 Joystick	\$4.99
C1312 Paddles	\$11.99
C1600 VIC Modem	\$89.00
C1650 Auto Modem	\$89.00
Logo 64	\$49.00
Pilot 64	\$39.00
Simon's Basic	\$19.00
Word Pro 64 Plus	\$59.00
Parallel Printer Interface	\$69.00
Calc Result 64	\$129.00
Codewriter 64	\$75.00
Quick Brown Fox	\$49.00
Word Pro 64 Plus	\$59.00

PROFESSIONAL SOFTWARE	
Word Pro 2 Plus	\$159.00
Word Pro 3 Plus	\$189.00
Word Pro 4 Plus/5 Plus...each	\$279.00
InfoPro	\$179.00
Administrator	\$399.00
Power	\$79.00

We stock a full inventory of software for Commodore, such as: Artworx, Broderbund, Commercial Data, Creative Software, Epyx, HES, MicroSpec, Nufekop, Romox, Sirius, Synapse, Thorn EMI, Tronix, UMI, Victory, Spinnaker, Rainbow & Timeworks!
CALL FOR DETAILS!

HANDHELD COMPUTERS



41CV	\$209
41CX	\$259
HP 10C	\$51.99
HP 11C	\$69.99
HP 12C	\$88.99
HP 15C	\$88.99
HP 16C	\$88.99
HP 75C	\$749.99
HPIL Module	\$98.99
HPIL Cass. or Printer	\$359.99
Card Reader	\$143.99
Extended Function Module	\$63.99
Time Module	\$63.99

PC-1500A... \$165.99
PC-1250A... \$88.99

CE-125 Printer/Cassette	\$128.99
CE-150 Color Printer/Cassette	\$171.99
CE-155 8K RAM	\$93.99
CE 161 16K RAM	\$134.99
CE 500 ROM Library	\$29.99

TIMEX/SINCLAIR 1000

Timex/Sinclair 1000	\$35.99
16K Memory	\$29.99
2040 Printer	\$99.99
VuCalc	\$17.99
Mindware Printer	\$99.99

PC-8201 Personal Computer	\$599.00
PC-8221A Thermal Printer	\$149.00
PC-82B1A Data Recorder	\$99.00
PC-8201-06 8K RAM Chips	\$105.00
PC-8206A 32K RAM Cartridge	\$329.00

1010 Recorder	\$74.00
1020 Color Printer	\$249.00
1025 Dot Matrix Printer	\$449.00
1027 Letter Quality	\$299.00
1030 Direct Connect Modem	CALL
1050 Disk Drive	\$379.00
CX30 Paddle	\$12.00
CX40 Joystick	each \$8.00
CX77 Touch Tablet	\$64.00
CX80 Trak Ball	\$48.00
CX85 Keypad	\$105.00
4003 Assorted Education	\$47.00
4011 Star Raiders	\$33.00
4012 Missile Command	\$29.00
4013 Asteroids	\$29.00
5049 VisiCalc	\$159.00
7097 Logo	\$79.00
7101 Entertainer	\$69.00
7102 Arcade Champ	\$75.00
8026 Dig Dug	\$33.00
8030 E.T. Phone Home	\$33.00
8031 Donkey Kong	\$39.00
8036 Atari Writer	\$79.00
8040 Donkey Kong, Jr.	\$39.00
8043 Ms. PacMan	\$39.00
8044 Joust	\$39.00

PERCOM

AT 88-S1	\$329.00
AT 88-A2	\$259.00
AT 88-S2	\$529.00
AT 88-S1PD	\$429.00
AT 88-DA	\$119.00
RFD 40-S1	\$449.00
RFD 40-A1	\$269.00
RFD 40-S2	\$699.00
RFD 44-S1	\$539.00
RFD 44-S2	\$869.00

TEXAS INSTRUMENTS

TX 99-S1	\$279.00
----------	----------

RANA

1000	\$319.00
------	----------

TRAK

AT-D2	\$389.00
-------	----------

MEMORY BOARDS

Axlon 32K	\$59.00
Axlon 48K	\$99.00
Axlon 128K	\$299.00
Intec 32K	\$59.00
Intec 48K	\$85.00
Intec 64K	\$99.00
Intec Real Time Clock	\$29.00

ALIEN VOICE BOX

Atari	\$119.00
Apple	\$149.00

KOALA PAD

Atari	\$75.00
Apple	\$85.00
IBM	\$95.00
CBM 64	\$75.00

CONTROLLERS & JOYSTICKS WICO

Joystick	\$21.99
3-way Joystick	\$22.99
Famous Red Ball	\$23.99
Power Grip	\$21.99
BOSS Joystick	\$17.99
ATARI/VIC Trak Ball	\$34.99
Apple Trak Ball	\$54.99
Apple Adapter	\$15.99
Apple Analog	\$37.99

KRAFT

Joystick	\$41.99
Atari Single Fire	\$12.99
Atari Switch Hitter	\$15.99
Apple Paddles	\$34.99
IBM Paddles	\$34.99
IBM Joystick	\$46.99

AMIGA

3100 Single	\$13.99
3101 Pair	\$19.99
Joyboard	\$37.99

TG

Atari Trak Ball	\$47.99
Apple Joystick	\$47.99
Apple Trak Ball	\$47.99

DISKETTES MAXELL

5 1/4" MD-1	\$29.00
5 1/4" MD-2	\$39.00
8" FD-1 (SS/DD)	\$39.00
8" FD-2 (DS/DD)	\$49.00

VERBATIM

5 1/4" SS/DD	\$26.99
5 1/4" DS/DD	\$36.99

ELEPHANT

5 1/4" SS/SD	\$18.49
5 1/4" SS/DD	\$22.99
5 1/4" DS/DD	\$28.99

HEAD

5 1/4" Disk Head Cleaner	\$14.99
--------------------------	---------

DISK HOLDERS INNOVATIVE CONCEPTS

Flip-n-File 10	\$3.99
Flip-n-File 50	\$17.99
Flip-n-File(400/800ROM)Holder	\$17.99

LJK ENTERPRISES

Atari Letter Perfect-Disk(40/80)	\$79.99
Atari Letter Perfect-ROM(40 col)	\$79.99
Atari Letter Perfect-ROM(80 col)	\$79.99
Atari Data Perfect-ROM(80 col)	\$79.99
Atari Spell Perfect-DISK	\$59.99
Atari Utility/MailMerge	\$21.00
Apple Letter Perfect	\$99.00
Apple Data Perfect	\$75.00
Apple LJK Utility	\$21.00
Apple Lower Case Generator	\$19.00

= WEST = = CANADA = = EAST =
800-648-3311 800-268-4559 800-233-8950

In NV call (702)588-5654, Dept 0101
Order Status Number: 588-5654
P.O. Box 6689, Stateline, NV 89449

In Toronto call (416)828-0866, Dept 0101
Order Status Number: 828-0866
2505 Dunwin Drive, Unit 1B
Mississauga, Ontario, Canada L5L1T1

In PA call (717)327-9575, Dept 0101
Order Status Number: 327-9576
Customer Service Number: 327-1450
477 E. Third St., Williamsport, PA 17701



CANADIAN ORDERS: All prices are subject to shipping, tax and currency fluctuations. Call for exact pricing in Canada.
INTERNATIONAL ORDERS: All shipments outside the continental United States must be pre-paid by certified check only. Include 3% (minimum \$5.00) shipping and handling. EDUCATIONAL DISCOUNTS: Additional discounts are available to qualified Educational Institutions.
APO & FPO: Add 3% (minimum \$5.00) shipping and handling.

Circle 94 on inquiry card.

Mockingbird: A Composer's Amanuensis

This display-oriented music-notation editor can help composers capture their ideas

by John Turner Maxwell III and Severo M. Ornstein

The Xerox Mockingbird is a composer's amanuensis, a computer program designed to aid a composer in capturing, editing, and printing musical ideas. The purpose of Mockingbird is not to invent new music or to suggest variations to the composer, but simply to aid him in recording his own ideas by speeding up the notation process. Mockingbird is not a publisher's aid, although it does print music, nor is it a performer's aid, although it can play; it is strictly focused on the composer's need for a powerful scribe.

Mockingbird is an interactive music-notation editor. It knows nothing about the rhythmic, harmonic, or melodic aspects of music except as they are represented in common music notation. To narrow the scope of Mockingbird, we at Xerox concentrated on handling piano music. The program presently cannot handle orchestral scores or music for instruments that require their own notational devices.

Mockingbird was written in 1980, and we find it surprising that no one had previously built such a system. We believe there are two principal reasons: first, we had at our disposal an unusually powerful set of hardware and software facilities with excellent graphics capabilities, and second, we made a number of key decisions, discussed later, that allowed us

to bypass some difficult problems.

Overview

Mockingbird is written in Mesa (see references 1 and 2), an experimental language developed at the Xerox Palo Alto Research Center (PARC). Mockingbird runs on a general-purpose computer called the Dorado (see reference 3), a powerful, experimental, single-user machine also developed at PARC. (The Dorado is now officially known as the Xerox 1132.) It has a 60-nanosecond instruction cycle, a large memory (typically 2 to 8 megabytes of RAM), and an 80-megabyte disk. It also includes a large, high-resolution bit-map display, a keyboard, and a mouse. Mockingbird presents a picture of a score on the display. The mouse provides the mechanism by which the user can point to locations within the score or to particular items, such as notes, to which some action is to be addressed. It has three program-readable push buttons on its top that are used for issuing commands to the program (sometimes in conjunction with keyboard keys).

The graphics facilities, high speed, and large memory make the Dorado a particularly suitable tool for music editing. The only special hardware we provided for Mockingbird was an interface to a Yamaha CP-30 electronic synthesizer. The Dorado can sense key positions and simulate key strokes on the synthesizer. Thus, the synthesizer can be used to "play in" music and to let the computer "play

back" music without having to synthesize the sound waveforms by program. The setup is shown in photo 1. Not shown is an experimental high-resolution, computer-driven, raster-scan laser printer that Mockingbird uses to make hard-copy pictures. The information for these pictures is sent over an Ethernet (see reference 4) connection from the Dorado. (Figures 1 and 2 illustrate Mockingbird's hard-copy output.)

In addition to these hardware resources, Mockingbird relies heavily on a general-purpose graphics software package (see reference 5) that provides simple commands for displaying characters and drawing both lines and curves. It also provides a common interface for both displaying material on the screen and printing high-resolution hard copy.

Mockingbird is designed to handle standard piano-music notation. It knows how to deal with notes, rests, accidentals, beams, chords, ties, grace notes, n-tuplets, time signatures, key signatures, clef indications, ottava, and a variety of different kinds of measure lines, embellishments (mordents, etc.), and sheet layouts (see the glossary on page 401 for definitions of these and other musical terms). Mockingbird deals with these elements not only in the graphics but, where appropriate, in the playing as well. Mockingbird understands about the key of a piece and will propagate and properly suppress accidentals.

Despite its sophistication, the

This article originally appeared, in somewhat different form, in a Xerox report of the same name.



Photo 1: The Mockingbird user's setup.

Mockingbird editor is only a research prototype. Many features are still missing and, in general, we did only enough to demonstrate feasibility. For example, there are numerous notational devices that we never incorporated in the program, such as rolled chords, staccato markings, fermata, and so on. Furthermore, although Mockingbird can handle ties, it cannot handle the more general slurs, nor can it display text such as lyrics or tempo markings. We do not feel that the addition of further features would present any insurmountable problems or violate the premises from which we proceeded.

Important Decisions

We feel that Mockingbird's success is largely dependent on the decisions

we made in the following five critical areas.

Scribe vs. Automatic Transcriber—We decided not to try writing a program that converted synthesizer keystrokes directly into a score. We made this decision for a number of reasons. First, we weren't sure that it could be done for the class of music we were interested in. Rather than pursue that question, we wanted to produce a tool that worked. Second, we knew that an editor would be needed anyway, both to correct mistakes and to satisfy the composer who did not want to use the synthesizer keyboard to enter material. So, instead of a recognizer, we built an amanuensis, or scribe, that provides a human transcriber with powerful editing tools. Our strategy was to build the

editing tools first and then work on automatic heuristics to augment the editing process. The editing tools can assist either in performing the conversion from played input to score or in entering scores graphically.

Data Structure—We believe that one of the most important decisions we made was the choice of data structure. Mockingbird treats music simply as a sequence of events. This allows us to simultaneously handle raw ("played in") material and more finished ("structured") material. Furthermore, it is convenient for presenting the material in its various external manifestations—displayed, printed, and played.

User Interface—In Mockingbird, rather than doing a lot of typing on the computer's keyboard, the user operates directly on the picture of the music that appears on the screen. To do this, he makes heavy use of the mouse. This approach is facilitated by a strong correlation between the internal representation of the music and its visual display (as well as how it is played). All of the elements of the data structure are displayed, and everything shown on the screen corresponds to some part of the data structure. If the user moves something on the screen, the data structure is immediately updated to reflect it; if the data structure is changed, the screen is immediately repainted. Not only is the picture faithful to the data structure, but so is the synthesizer "performance." For example, if the user puts a trill marking on a note, Mockingbird will trill when playing it.

Piano—Music notation is extensive and nonuniform—instruments present individual requirements and employ special notational devices. By choosing to focus our attention specifically on piano music, we limited the scope of our ambitions to a manageable size. The piano was an obvious choice as it is an instrument frequently used by composers in trying out their ideas. Furthermore, because of its keyboard structure, it lends itself naturally to connection as an I/O (input/output) device to a computer.

Voices—Music is broken "vertically"

Don't miss a single article you'd like to read

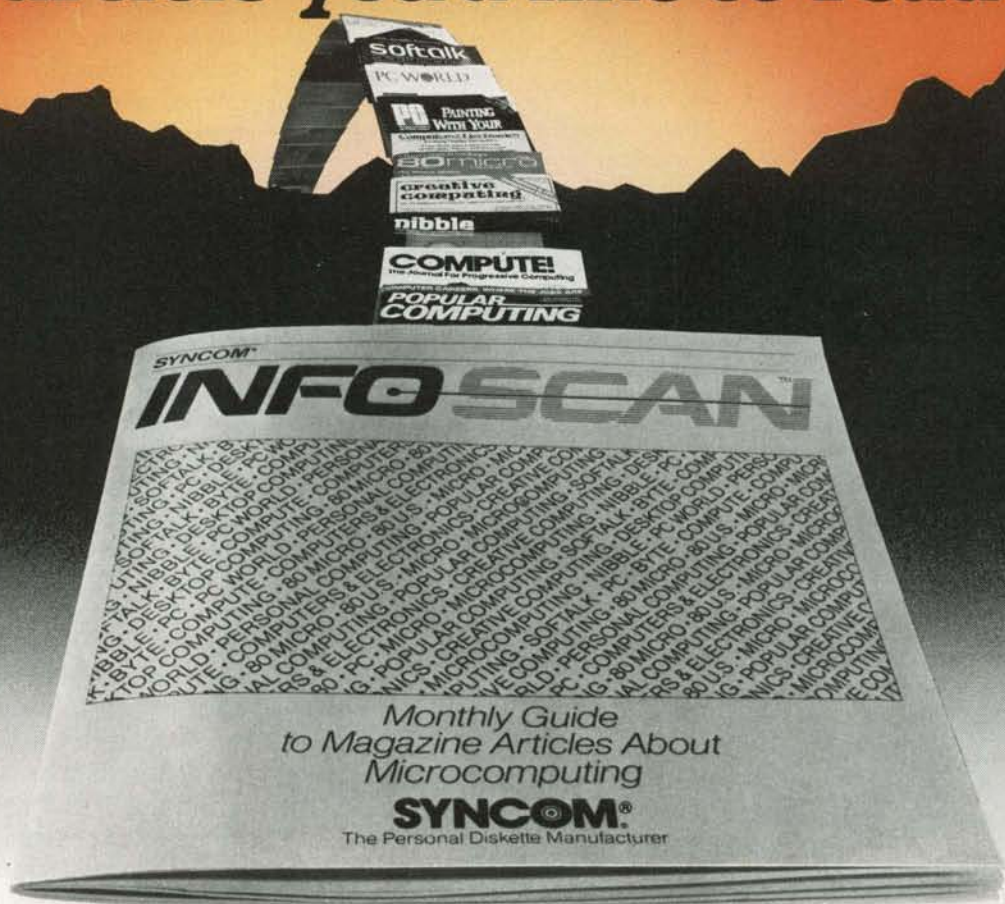

Send for your **FREE** monthly copy of Syncom® INFOSCAN™, the guide to magazine articles on microcomputing.

Syncom INFOSCAN helps you get more out of computing — both personally and professionally — by making it easier for you to stay well informed.

Every month, INFOSCAN indexes the articles appearing in microcomputing magazines. Just look beneath the topic headings that interest you

most to find the articles you definitely want to read.

INFOSCAN can help you save money, too. From the 400+ articles it indexes each month you can find out how to make smart buying decisions on new equipment and software, as well as how to make your present system work better and harder.

For your free monthly copy of INFOSCAN, just call toll-free, 1-800-843-9862. (In South Dakota, 605-996-8200.) Please call weekdays 8 to 5, Central time.

INFOSCAN is a trademark of Syncom, Division of Schwan's Sales Enterprises, 1000 Syncom Drive, Mitchell, SD 57301.

SYNCOM®

The Personal Diskette Manufacturer

into separate parts or voices. Such partitioning is obvious in multiple-instrument music, but it is also an essential structural feature in piano scores. The recognition of this fact, and its explicit representation in *Mockingbird*, greatly facilitates the editing and formatting of scores. This topic is discussed later.

The Editor

Mockingbird consists of a number of functionally distinct parts integrated into one editor. The editor allows the user to record, edit, play, and print a single piece of music. Commands are issued by making selections and typing characters. Some commands are invoked by pointing the mouse at an object on the screen and clicking a button. When the user has finished with the piece of music, he can name it and file it away in the Dorado's filing system. Later it can be retrieved by its name.

As it appears on the display, a score looks like a piece of sheet music (see photo 2). There are usually four to six staff sets (lines), each composed of two to four staves. At the left of each staff is a clef sign and an appropriate key signature. Scattered over the staves are notes, chords, beams, measure lines, and other symbols commonly found in music.

Only about a page of the score can appear on the screen at a time, so there are commands that allow the user to look at different sections. Scrolling causes the current section of the score to be moved up or down so that neighboring lines can appear. The user can scroll as little as a single line or as much as an entire page. Thumbing allows the user to jump to an arbitrary point in the score. To thumb, the user specifies approximately how far into the score he would like to be, and the program moves the display to that point. Both thumbing and scrolling are accomplished by moving the cursor into a special "scroll bar" area at the left of the score and clicking one of the mouse buttons.

The score can be edited with *Mockingbird* just as documents are edited with word processors. The usual

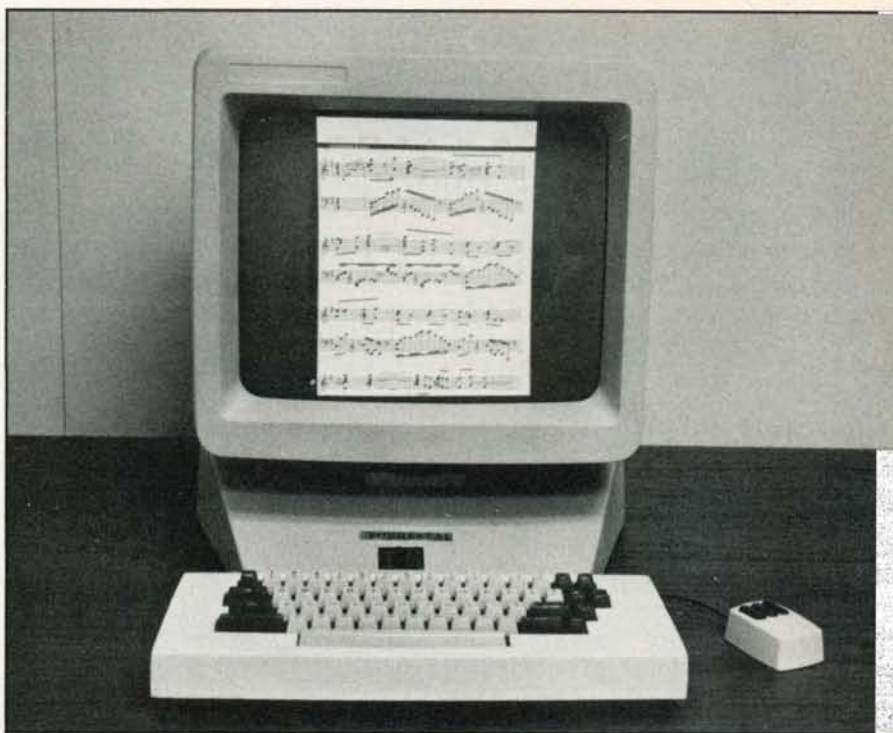

Photo 2: A computer running the *Mockingbird* program.

paradigm for making an edit is to "select" some portion of the music and then to issue a command. The command will apply only to the selected portion. The display is updated immediately to reflect the changes.

Selection

A user may select either a contiguous section of the score or an arbitrary collection of individual notes. Both types of selections are made by moving the mouse over the desired objects while holding down a mouse button.

If the user selects a section of the score, *Mockingbird* indicates that section by displaying it in reverse video (white on black instead of black on white). The section may be as small as a portion of the measure or as large as the entire score. It encompasses all of the notation that appears on all of the staves. Section selection is typically used for coarse editing operations such as copying and deleting. However, it may also be used to apply a function to all of the notes in a particular region, such as designating them all to be sixteenth notes.

Mockingbird indicates individual note selections by painting the selected note heads gray. An in-

dividual note may be selected by pointing at it with the mouse and clicking the left mouse button. Notes may be collected into a selected set for combined action either by a series of individual mouse clicks or by sweeping the mouse over the note heads while holding down the mouse button.

Because selection persists after execution of a command, it is possible with a single selection, to issue a succession of commands that all apply to the same material.

Voices

To play notes at the proper time and to place them correctly within the score, it is necessary to know where they occur within the rhythmic structure of the piece. Measure lines provide reference points from which rhythmic position is measured. For music that has only one voice, you start at the beginning of the measure and count forward through the various note and rest values until arriving at the note of interest. Its position in the measure's rhythmic structure is then given by the sum of the time values of the preceding items. If the music has several parallel voices with differing time values, you must know which



Figure 1a: A segment of a piano score.



Figure 1b: The same segment showing only voice one.



Figure 1c: The same segment showing only voice two.



Figure 1d: The same segment showing only voice three.

notes belong to which voice in order to count forward properly. Voicing thus provides a lateral indication of what goes with what.

Figure 1a shows a section of a full piano score, whereas figures 1b-1d show its separate voices. To find out when the C octave occurs in the second measure of figure 1b, add the prior eighth chord and sixteenth rest and conclude that the octave comes three-sixteenths into the measure. Now consider the situation in the third measure of figure 1d. Here a voice commences within the measure rather than at its beginning, so there is no way to count forward to it. Instead, its rhythmic position is determined by its synchrony with an element of another voice, in this case, the octave in voice one. (To enhance visual clarity, the chords are slightly separated in the full score shown in figure 1a. However, they are, in fact, rhythmically synchronous.)

In that same measure, consider the effect of erroneously placing, say, the

sixth note of voice two in voice three. The effect would be significant: first, the note would be incorrectly located (played) at the midpoint of the measure (i.e., one-eighth after the chord in voice three), and second, due to the omission in voice two, all the ensuing notes of that voice (up to the next reference point) would be located slightly earlier than they should. Mockingbird contains a mechanism to assist the user in finding such errors. Upon request, the program will check to see whether the rhythmic "time" of every measure is properly filled by the notes and rests of the voices it contains (with due allowance for parallelism of voices). Measures that don't "add up" correctly will be marked with a stipple pattern on the display.

The voicing of a piece of music is hence an important part of its underlying structure, which is revealed by the way in which the score is drawn. Thus, voicing in a piano score is indicated by such clues as shared

beaming, chording, stem direction, and staving. The reader uses these clues, together with vertical alignment within the score, in determining how to play the music, i.e., when to play the notes, which hand to use, etc.

In Mockingbird, the problem is the converse one of determining what the finished score should look like, starting from raw notes that have neither explicit voicing nor any of the structural clues of a completed score. Everything must be determined from scratch: note values, chords, staving, beaming, rests, ties, etc. One of our earliest insights was that if we could first determine the voicing of a piece, it would greatly facilitate determination of all of these other features. In studying existing piano scores, we saw no general way to infer voicing automatically, and so instead decided to give the user explicit control over its definition. Hence, Mockingbird includes commands for assigning notes and rests to voices and for indicating synchrony between the elements of different voices.

Once a piece has been voiced, the user can designate a particular voice for viewing, in which case the notes of that voice appear in black on the display while the rest of the score appears in a light gray for reference. In this mode, the user can access only items within the designated voice (i.e., area selection will select only the notes in that voice, and individual notes in other voices cannot be selected). Any editing commands issued when viewing a single voice will thus affect only that voice; the part displayed in gray is not affected.

Editing Commands

Mockingbird's editing commands include assigning note values, assigning notes to voices, transposing notes, changing their stem direction, changing their spelling, and changing the staff on which they appear. In addition, various elements of the score, such as notes, measure lines, and time, key, and clef signatures, can be individually deleted or picked up and moved to a new location with the mouse. There are also commands that group notes together with beams,

CompuPro...

for Performance, Quality and Reliability

Anyone can sell you a box full of hardware. But is it too much computer? Too little? Will it run the appropriate software? What about service? If you need the right answers both before and after the sale, call your nearest **Full Service CompuPro System Center**. For product information, see pg. 277

ALABAMA

Birmingham
Cost Plus Computers
(205) 879-5976

ARIZONA

Scottsdale
S-100
(800) 528-3138

CALIFORNIA

Bakersfield
Creative Computing Serv.
(805) 835-1118

Berkeley
American Computers &
Engineers
(415) 849-0177

Track Computer Center
(415) 845-6366

Burlingame
Mentzer Computer Systems
(415) 340-9363

Canyon Country
Creative Computing Serv.
(805) 251-9877

Carmichael
Logic Systems
(916) 971-3133

Chatsworth
Priority One Electronics
(213) 709-6789

Hayward
Best Computers Hayward
(415) 886-4732

Irvine
Priority One Electronics
(714) 660-1411

Los Angeles
American Computers &
Engineers
(213) 477-6751

Gifford Computer Systems
(213) 477-3921

Mountain View
ACC
(415) 969-4969

Oakland
Track Computer Center
(415) 444-8725

Pacific Palisades
System Interface
Consultants
(213) 454-2100

Pasadena
Omni Unlimited
(213) 795-6664

Petaluma
Advanced Information
Mgmt.
(707) 763-7283

Pleasanton
Best Computers
Stoneridge
(415) 463-2233

Sacramento
Logic Systems
(916) 922-3377

San Francisco
Gifford Computer Systems
(415) 391-4570

San Leandro
Gifford Computer Systems
(415) 895-0798

San Rafael
Computer House
(415) 453-0865

Santa Barbara
Data Bank
(805) 962-8489

Santa Maria
Data Bank
(805) 922-1333

Santa Rosa
Matrix Computers
(707) 542-0571

Sunnyvale
Pragmatic Designs Inc.
(408) 736-8670

COLORADO

Lakewood
Rocky Mountain
Microsystems
(303) 232-4545

FLORIDA

Brandon/Tampa
Micro Computer
Technology
(813) 685-7659

Orlando
Data/Office
(305) 629-6776

Satellite Beach
Binary Magic, Inc.
(305) 777-7080

HAWAII

Kahului Maui
Capacity Plus Computers
(808) 877-3496

ILLINOIS

Athens
Computers Plus
(217) 636-8491

La Grange Park
Small Business
Systems Inc.
(312) 579-3311

Skokie
Lillipute Computer
Mart Inc.
(312) 674-1383

MARYLAND

Bethesda
JR Systems
(301) 657-3598

MASSACHUSETTS

Boston
New England
Electronic Exch.
(617) 491-3000

Chestnut Hill
Key Micro Systems
(617) 738-7306

NEW YORK

Amherst
Gifford Computer Systems
(716) 833-4758

Deer Park
Datapro Systems, Inc.
(516) 595-1311

Staten Island
John D. Owens Assoc.
(212) 448-6283

NORTH CAROLINA

Greensboro
General Semantics
Computers
(919) 378-1500

OREGON

Portland
Microwest Computer
Products
(503) 238-6274

PENNSYLVANIA

Philadelphia
Information Network
Systems
(215) 364-8220

RHODE ISLAND

Coventry
Key Micro Systems
(401) 828-7270

TEXAS

Austin
CPA Systems, Inc.
(512) 458-9281

Dallas
Dator Systems
(214) 521-0915

Houston
Gifford Computer Systems
(713) 877-1212

Seguin
CPA Systems, Inc.
(512) 379-0660

VIRGINIA

Woodbridge
ONETCO
(703) 590-5464

WASHINGTON

Seattle
American Computers &
Engineers
(206) 583-0130

WISCONSIN

Greenfield
Byte Shop of Milwaukee
(414) 281-7004

Madison
Beam International
(608) 255-2325

AUSTRALIA

Bankstown
Automation Statham
Pty., Ltd.
(02) 709-4144

CANADA

Coquitlam, B.C.
CSC System Center Ltd.
(604) 941-0622

Vancouver, B.C.
Dynacomp Business
Computers Ltd.
(604) 872-7737

THE PHILIPPINES

Quezon City
Corona International Inc.
78-34-71

UNITED KINGDOM

Swansea
Comcen Technology Ltd.
(0792) 796000

CompuPro®

A GODBOUNT COMPANY

3506 Breakwater Court, Hayward, CA 94545

©1983 CompuPro

THE \$1595 COMPUTER THAT SELLS FOR \$1595.

If you're like most knowledgeable computer enthusiasts, people are bound to ask you how much they should spend for a small business computer.

You have, of course, a ready answer: As little as possible and still get a serious business system that provides all the functions they need. In short, a complete computer. Standing in the way of that goal is how most small computers are sold today. By the piece.

The first-time buyer may see a low advertised price for a basic starter system.

But once inside the store, he or she will learn about the extra-cost hardware and software that make the machine do meaningful work. The essentials called 'options': A monitor, disk drives, communication and printer interfaces, not to mention the application programs.

So the computer can end up costing

two or three times more than the shopper thought it would. And you're asked for more advice.

Next time, tell them that Kaypro includes all those so-called optional extras as standard features. On our Kaypro II, it all comes complete for \$1,595.

It's the least expensive serious business system we know of on the market today. Off the shelf, it comes complete with 64K RAM, Z-80 CPU. A 9" built-in green monitor. Two built-in disk drives with 400K total capacity. A detached, Selectric-type keyboard with numeric keypad. Interfaces for both a printer and communications. And a complete software package for Word Processing/Spelling, Data Base Management, Financial Spreadsheets, and more.

As the \$1,595 computer that sells for \$1,595, Kaypro II is the complete answer for the first-time buyer. And perhaps the best answer for your next computer.



SPECIFICATIONS

Microprocessor	Z-80	Perfect Filer	Perfect Calc
Operating System	CP/M 2.2	spreadsheet	Wordstar word processing
User Memory	64K	The Word Plus	Profit Plan spreadsheet
Disk Drives:	2 drives, 400K, unformatted	M-Basic	12 Games
Interfaces	1 Serial	Uniform - allows computer to 'read' and 'write'	TRS-80, Osborne, Xerox disks
Keyboard	Detached, 63-key with numeric keypad	Dimensions	Height: 8 inches
Software included:	Perfect Writer	Width: 18 inches	Depth: 15½ inches
	Perfect Speller	Weight: 26 lbs. (portable)	

KAYPRO

The Complete Business Computer.

Call 800-447-4700 for the dealer near you, or call Kaypro: 619-481-4318. Circle 207 on inquiry card.

Registered Trademarks: CP/M - Digital Research, Inc.; Z-80 - Zilog; M-Basic - Microsoft, Inc.; Wordstar - Micro Pro; Profit Plan - Chang Laboratories; Uniform - Micro Solutions, Inc.; The Word Plus - Oasis Systems; Perfect Writer, Perfect Speller, Perfect Filer, Perfect Calc - Perfect Software, Osborne - Osborne Computer Corp.; S-Basic - Topaz Programming; TRS-80 - Tandy Corp.; Xerox - Xerox Corp.; Selectric - IBM Corporation. © 1983 Kaypro Corporation.

chords, or slurs. Many of these commands work with either note or section selection. For instance, the user may transpose a single note down an octave or an entire voice up a fifth. The first of these actions would be accomplished by selecting the note and issuing the Transpose command. The second would be accomplished by designating the desired voice, selecting the entire score, and issuing the command.

The user may also rearrange large sections of the score in a "cut and paste" manner. To replace one section of the score with another, the user selects the section to be replaced (the primary selection), then the section to be copied (the secondary selection), and issues the Replace command. The primary selection does not have to be the same size as the secondary one. If there is no secondary selection, the resulting operation is a deletion. If the primary selection merely points at "empty space" in the score, the resulting operation amounts to an insertion.

In addition to changing the structure of the music, the user can change the way it appears on the sheet. For instance, the number of staves for each line can be changed on a line-by-line basis. The user can switch a staff's clef in the middle of a measure or designate a section to be displayed in ottava notation. Changes in key and time signatures can also be inserted within the score wherever necessary.

The user can add new material to the score by picking up items from a pop-up menu that can be made to appear under the cursor (see photo 3). The menu includes a number of small symbols (called *icons*) representing various elements of the score. There are icons for a note, a rest, bass and treble clefs, several kinds of measure lines, and a variety of markings such as trills, accidentals, etc. As the cursor is moved over the menu, its shape changes to correspond to the icon immediately beneath it. When the mouse button is released, the cursor retains the last shape. The user can then insert instances of that icon by pointing to a place in the score and clicking another mouse

TOTAL CONTROL:

FORTH: FOR Z-80®, 8086, 68000, and IBM® PC

GRAPHICS • GAMES • COMMUNICATIONS • ROBOTICS
DATA ACQUISITION • PROCESS CONTROL

● **FORTH** programs are instantly portable across the four most popular microprocessors.

● **FORTH** is interactive and conversational, but 20 times faster than BASIC.

● **FORTH** programs are highly structured, modular, easy to maintain.

● **FORTH** affords direct control over all interrupts, memory locations, and i/o ports.

● **FORTH** allows full access to DOS files and functions.

● **FORTH** application programs can be compiled into turnkey COM files and distributed with no license fee.

● **FORTH** Cross Compilers are available for ROM'ed or disk based applications on most microprocessors.

Trademarks: IBM, International Business Machines Corp., CP/M, Digital Research Inc., PC/Forth+ and PC/GEN, Laboratory Microsystems, Inc.

FORTH Application Development Systems include interpreter/compiler with virtual memory management and multi-tasking, assembler, full screen editor, decompiler, utilities, and 130 + page manual. Standard random access files used for screen storage, extensions provided for access to all operating system functions.

Z-80 FORTH for CP/M® 2.2 or MP/M II, \$50.00.

8080 FORTH for CP/M 2.2 or MP/M II, \$50.00.

8086 FORTH for CP/M-86 or MS-DOS, \$100.00.

PC/FORTH for PC-DOS, CP/M-86, or CCPM, \$100.00; **68000 FORTH** for CP/M-68K, \$250.00.

FORTH + Systems are 32 bit implementations that allow creation of programs as large as 1 megabyte. The entire memory address space of the 68000 or 8086/88 is supported directly.

PC FORTH + \$250.00

8086 FORTH + for CP/M-86 or MS-DOS \$250.00

68000 FORTH + for CP/M-68K \$400.00

Extension Packages available include: software floating point, cross compilers, INTEL 8087 support, AMD 9511 support, advanced color graphics, custom character sets, symbolic debugger, telecommunications, cross reference utility, B-tree file manager. Write for brochure.



Laboratory Microsystems Incorporated

4147 Beethoven Street, Los Angeles, CA 90066

Phone credit card orders to (213) 306-7412



Business as Usual

Business as usual these days means a computer that's up and "humming." But if your computer were stolen or damaged, you wouldn't have business as usual.

YOU'D HAVE TROUBLE!

You can get fast replacement for your entire system and be back in business in a hurry by protecting your computer with SAFEWARE Personal Computer Insurance. It's the only coverage designed specifically for personal computers used for business — in your office, shop or home.

SAFEWARE protects ALL hardware, ALL purchased software and ALL media against theft, damage or any other kind of loss, regardless of use, after a low \$50 deductible.

(Not without
your computer
it wouldn't be.)

Fast, courteous claims handling prevents your losing valuable business computer time.

Find the premium price for the coverage you need listed in the table below, available for as low as \$35 per year. Fill in the coupon today. Your coverage will begin as soon as your coupon application is received. Or for even faster coverage, call our toll free number:

1-800-848-3466

(In Ohio call 1-614/262-0559)

Phones open 8 a.m. to 8 p.m.

Monday through Saturday

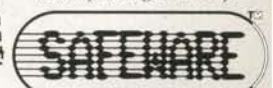

Total Hardware, Media & Software System Value	Annual Premium
Up to \$ 2,000	\$ 35
\$ 2,001-\$ 5,000	\$ 60
\$ 5,001-\$ 8,000	\$ 75
\$ 8,001-\$11,000	\$ 90
\$11,001-\$14,000	\$105

Call toll-free for rates on higher coverage. Coverage differs in Texas.

It is an underwriting requirement that you insure your system for its full value.

Mail to: SAFEWARE, P.O. Box 02211, Columbus, OH 43202.

Before I'm out of business,

please issue my SAFEWARE Insurance Coverage.

Name _____

Street _____

City _____

State _____ Zip _____

System value \$ _____

Check Enclosed VISA MasterCard

Card # _____

Exp. Date _____

BYT



Photo 3: A photo of the display screen showing the pop-up menu.

button. (Mockingbird automatically selects the inserted note or rest for the user's convenience. Thus, the user may immediately issue commands that affect the note.)

The Synthesizer

The synthesizer is both an input and an output device. As an output device it can be used to listen to music stored by Mockingbird. This is especially helpful in proofreading scores. Mockingbird "reads" the score and plays it by simulating key strokes on the synthesizer. As the synthesizer plays the notes, a pointer tracks the performance on the displayed score. Mockingbird's rendition handles polyphonic music correctly, taking into account such things as grace notes, n-tuplets, trills, ottava, and metronome markings. Thus, the composer may listen to what he has written. Although the performance sounds a little mechanical, it is sufficient for catching erroneous note values and pitches. Moreover, the music can be played at double speed for rapid scanning or half speed for careful listening.

As an input device, the synthesizer is used to capture music played by

the composer. As the user plays, Mockingbird "watches" the keys and records when every note was struck. Music in this form is displayed as a note-head time plot, which we call a "piano roll," illustrated in figure 2a. Mockingbird chooses default staffing and spelling. Figure 2h shows the final score for this same section of music.

When playing music, the composer isn't restricted to a single melodic line, nor must he follow a metronome; he may play whatever he wants as freely as he wishes. Mockingbird captures his idea in a rough form that, although a far cry from a standard score, nonetheless contains enough information to reconstruct his original intent. At this point, the composer may go on to capture more music or start transforming the piano roll into a score by editing it.

Raw piano-roll material can be mixed in freely with standard music notation, both on a measure-by-measure basis and within a single measure, as shown in figure 2c. All of the commands that apply to standard music notation can also be applied to the piano roll or to mixed sections. Thus, the composer can re-

arrange material, put notes into different voices, specify the durations of the notes, and add structural elements such as beams and chords. The ability to mix piano-roll and standard music notation gives the user a lot of freedom; he can work on the score in whatever order pleases him. Mockingbird even plays correctly across the boundaries of mixed sections of piano roll and standard music notation.

Another feature of Mockingbird is that it is possible to "play against" previously entered material. While Mockingbird plays, the user can play along with it on the synthesizer. The combined product is heard as Mockingbird records the new notes, simultaneously merging them with what it is playing. This allows the composer to build a piece one voice at a time or to lay in new material over an existing score. It also allows him to construct music that cannot be played by one person on a standard instrument.

Converting Piano Rolls

Figure 2a shows some source material recorded by Mockingbird directly from the synthesizer. Such raw piano rolls are hard for humans to read; there are no key or time signatures, no measures, chords, or beams to group things, nor have the notes been separated into voices. Because part of the composition process includes specifying such syntactic structuring, it was necessary for Mockingbird to go beyond piano-roll notation. The process of converting from piano-roll to standard music notation is not handled automatically, but rather involves the user. However, Mockingbird does provide a number of heuristics that assist in the transformation.

Figure 2 shows a typical succession of steps for turning some piano-roll input into a final section of score. At any point, the composer can use the mouse and menu to add material, because Mockingbird allows piano-roll and standard music notation to coexist.

The first step in converting piano rolls is alignment. To remove the inevitable imprecision in playing notes

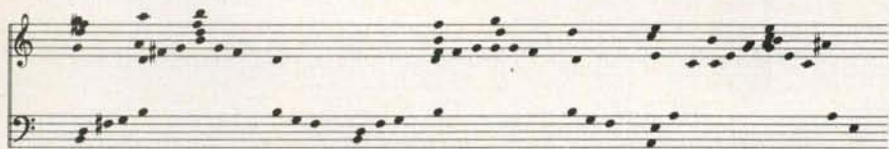

Figure 2a: The piano roll input directly from the synthesizer keyboard.



Figure 2b: The piano roll after alignment.



Figure 2c: The piano roll with key and time signatures, voicing, measure lines, some time values, beams, etc., added by the user.



Figure 2d: The results of timing and beaming heuristics.



Figure 2e: The piano roll justified with too low density.



Figure 2f: The piano roll with a more suitable density.



Figure 2g: The piano roll after correction by the user.



Figure 2h: The piano roll after final "hand" touch-up by the user.

that should be simultaneous, the user can apply a heuristic that runs through the piano roll and aligns the notes that occur close to the same time. Figure 2b shows the results of that step.

Typically, the user provides key and time signatures in the next step, then he might enter measure lines. He can do this by picking up a measure-line icon from the pop-up menu and depositing copies at suitable places into the piano roll. Alternatively, the user can tell Mockingbird to play the piano roll back on the synthesizer, and as it does so, he can "beat in" measure lines simply by striking the keyboard's space bar on the first beat of each measure. Errors can easily be corrected by moving, deleting, or inserting measure lines as appropriate.

Next, the user would normally assign notes to different voices. An individual note is assigned to a voice when the user selects the note and then indicates to which voice it belongs. More typically, collections of notes are simultaneously voiced by selecting them together and then issuing a single voicing command.

At this point, the user can go through the score, manually assigning time values to the notes and designating chords and beams. Figure 2c shows this process partially completed. However, Mockingbird has a number of heuristics to help with these tasks. After the user assigns notes to their proper voices and gives a time signature, he may ask Mockingbird to guess the time values of the notes, group them into chords, and assign beams. Although the heuristics used are only about 80 percent accurate, they save the user a lot of work. In addition, what remains is easier for the user to deal with, because it is in a more familiar form. Figure 2d shows the result of the heuristics. Mistakes made by the heuristics can be found by inspecting the score or listening to it through the synthesizer. The user then fixes the mistakes and adds more structure. Figure 2g shows the resulting score. The combination of simple heuristics and easy editing is as central to the



Figure 3a: Two voices improperly aligned.

concept of Mockingbird as an amanuensis.

By the time these steps are completed, the piano roll has become a score containing all the basic information. The only thing that remains to be done is some tidying up.

Justification

A particularly powerful command is the one that justifies a sequence of measures within the score. (The user selects some area of the score, and the justifier locates the nearest measure lines.) Justification involves several things: making the voices consistent relative to one another, laying out the graphical elements of the score in an aesthetic arrangement, and making sure that each line of the

Figure 3b: The same two voices after correction by the justifier.

score contains complete measures. Justification is concerned only with the horizontal placement of objects; details such as the height and tilt of the beams are outside of its domain. Furthermore, it doesn't disturb structural elements such as stem directions and staffing.

The justifier starts by going through each measure and making sure that all of the voices are consistently ordered relative to one another. Two voices are inconsistent if each adds up to the time signature, but when taken together, allowing for alignments and spacing, they appear to add up to more than the time signature. Figure 3a shows an example of such a situation. The justifier moves notes around to correct mat-

ters, as shown in figure 3b.

Next, the justifier redetermines the horizontal placement of the graphical elements of the score. The horizontal spacing is based on the types of elements (measure line, note, clef sign, accidental, etc.), the voicing, and the need to keep things from overlapping. The user can also give a parameter that determines how "dense" the justification should be. The justifier then squeezes things together as close as possible based on these constraints.

Finally, the justifier stretches out the spacing in the material to make an integral number of measures fit on each line. The user can justify various sections of a piece with different densities as appropriate (see figures 2e and 2f).

If at any point the user is dissatisfied with the results of justification, he can manually move items around in the score to improve the appearance. However, the justifier produces a surprisingly good layout, so that usually the only things left for the user to do are adjustments that en-

PUT THE "SOFT-TOUCH"™ ON YOUR APPLE



Now get high resolution touch screen capabilities for your Apple® IIe or Apple® II+ with CTA's Soft-Touch™ bezel and interface. It attaches easily to any Apple® Monitor III and comes with all the hardware and software you need to install and operate it.

Use CTA's Soft-Touch™ as a training device or to replace joysticks or keyboard game commands. Use it for spreadsheet programs, too.

Ask your Apple® dealer for CTA's Soft-Touch™ — and put the touch on your Apple®!

Now Available!
"SOFT-TOUCH"™
for IBM-PC!

CTA

Computer Technology Associates

New Products Division
1704 Moon, N.E.
Albuquerque, New Mexico
87112
(505) 298-0942

Apple® is a registered trademark of Apple® Computer, Inc. Soft-Touch is a trademark of Computer Technology Associates.

In Less Than 3 Minutes

Your IBM Model 50, 60, 65, 75, or 85
Electronic Typewriter
can be an RS232C PRINTER or TERMINAL



CALIFORNIA MICRO COMPUTER Models 5060 and 5061 can be installed easily and require NO modifications to the typewriter.

For additional information contact:

CALIFORNIA MICRO COMPUTER
17791 Jamestown Lane Huntington Beach, CA
92647 (714) 848-3947

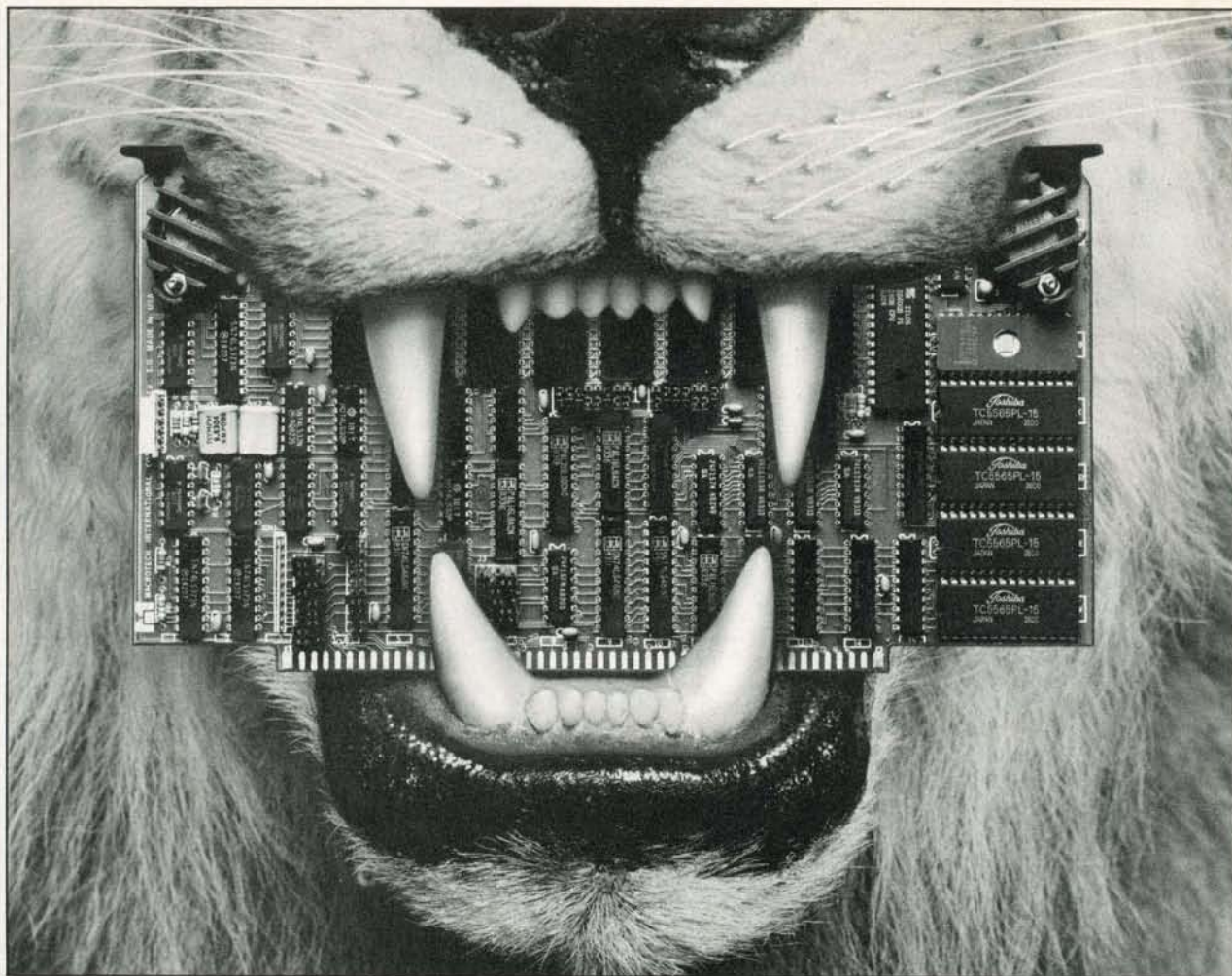

KING OF THE S-100 JUNGLE



You'll reign supreme when your S-100 system is equipped with Macrotech's high performance products. Our full megabyte high speed dynamic RAM and 16 channel intelligent DMA I/O boards provide the edge you need in today's competitive jungle.

Our one slot MAX dynamic RAM is field expandable from 256K to one megabyte. You get far more than just the low price per kilobyte of \$2.39. You get:

- IEEE 696 full parity detection • Virtual disk support in all popular Digital Research operating systems • High Speed Z80, 8085—6 MHz; 8086, 8088, 68,000—8 MHz No Wait States
- On-board refresh • 16-24 bit Memory Mapped Addressing option
- DMA fully supported in strict compliance with IEEE 696

Our ADIT 16-channel serial I/O board is no pussycat either. An on-board 6 MHz Z80B provides intelligence for a large array of commands. Plus important things like:

- Resident virtual disk interface • Memory to memory DMA
- 24-bit DMA addressing • Field expandable from 4 to 16 channels
- Full compliance with IEEE 696

Macrotech makes every slot in your computer really count! To get the rest of our story on the ADIT or the MAX, write or call us. In the S-100 jungle Macrotech products can be your key to success.

MACROTECH INTERNATIONAL CORP.

9551 Irondale Ave., Chatsworth, CA 91311, (213) 700-1501

Dealer/Distributors: Priority One Electronics (800) 423-5922, (213) 709-5111
Soft Machines (217) 351-7199; In England: Fulcrum (Europe) (0621) 828-763

hance readability (such as grouping and tilting beams, adding clef switches, etc.). In fact, given the power of the justifier, one common style of use is to enter music one voice at a time, not worrying at all about the spacing between notes. Each time a line of material has been entered, the user justifies that and then goes on to the next line. The justifier takes care of aligning the voices properly and producing a suitable layout.

The justifier is also helpful in deter-

mining page layout and page breaks. The user can indicate that specific measures are to fall at the end of a line. The justifier takes this into account when deciding how many measures to put on a line. With this feature, the user can control how many pages the score will fill and can assure that the end of the score falls at the end of a page.

Data Structures

Our first design was a hierarchical data structure that closely matched

the formal structure we saw in music. But we ran into numerous problems with it because it didn't match the needs of an editor. After much discussion, we settled on a sequential data structure. This surprised us, because in the beginning we had thought that the hierarchical design was the obvious choice. However, experience has convinced us that the sequential design is vastly superior.

There are three considerations in designing a data structure: representational power, programming convenience, and performance. Representational power concerns how much of the domain is covered by the data structure and how easy it is to represent different aspects of the domain in the structure. Programming convenience concerns how easy it is to write algorithms that deal with the data structure. This depends a great deal on what the algorithms do. In Mockingbird we are mostly concerned with playing, editing, and displaying the score (as opposed to structural analysis or automatic composition). Performance concerns how rapidly the data may be accessed. Even if a data structure is convenient, it may not be efficient. Sometimes there is a trade-off between structural complexity, memory utilization, and speed. In Mockingbird, memory was plentiful and speed was critical; for an editor to be useful, the display must respond crisply to user actions.

There are many possible hierarchical data structures that might be used to represent music. We use the term loosely to describe a class of data structures that implicitly incorporate musical structure in the design. Thus you might imagine a data structure that had a separate part for each measure or for each voice. A "sequential" data structure, on the other hand, is simply a sequence of undifferentiated entities. No attempt is made to incorporate musical structure into the design. Instead, it is up to the algorithms to determine the structure from the entities.

On the surface, the hierarchical design seems better. If the musical structure is built into the data structure, then you can guarantee a uniform interpretation over all of the

The MICROWRITER™ Daisy Wheel Printer.



Price \$480

Features:

- Microwriter parallel interface mounted internally in the Olivetti Praxis machine
- Built in self test
- Portable...comes with deluxe carry case
- Low noise level
- Slim modern styling
- Print quality is identical to the finest office typewriters on the market
- Can tab
- Rule single lines both vertically and horizontally
- Underline
- Print at 10, 12, or 15 characters per inch (switch selectable)
- Ten character memory automatic error correction, with lift-off carbon film correction ribbon (for typewriter use)
- Automatic or programmable page formats
- Handles letter, legal size sheet and fanfold paper in widths up to 12 inches wide
- 165 character/12 inch print width
- Wide selection of 21 interchangeable daisy print wheels available
- Ribbon cassettes just drop in
- Switch selectable European keyboard
- Centronics compatible parallel cables are currently available from stock

With the Microwriter you will never again have to send an important letter or a simple correspondence that doesn't look impressive. Why settle for just any printer when you can have a MICROWRITER... a fine letter quality typewriter for you and your computer. For more information, see your local computer dealer or contact Ammicro directly.

ammicro™
corp.

122 East 42 Street, Suite 1700, New York, N.Y. 10168

(212) 254-3030



Professional Software for the Software Professional

DMA products operate on
the full range of
Z80, 8086, 8088 processors,
including the IBM-PC

Here's what you can do!

Application Creation

FORMULA II™

The Application Creator

The first and only Application Creator—a do-it-yourself concept for office automation. FORMULA II lets you define your files, forms, menus, and reports—FORMULA II then creates your program. FORMULA II includes a Database manager with an English Query language and a Form/Report Creator with word processing features.

Communications

ASCOTM™

ASCOTM™ is the most versatile asynchronous communication package for microcomputers on the market. It features interactive, menu-driven, and batch operations; supports auto-answer and auto-dial modems; includes most popular protocols; provides network simulation; and many other options. Xerox Corporation, NCR, Monroe Systems for Business, and the big 8 accounting firms use ASCOTM™.

SYNCOM™—A bisynchronous communication package that will be configurable for a variety of systems and includes a flexible interface to the operating system. 2780/3780/3270 protocols available on microcomputers with appropriate hardware.

TERMCOTM™—A configurable terminal emulator allowing any personal computer to emulate most conversational and selected block mode terminals with asynchronous communications. Available December 1983.

Utilities

EM80/86™

This software emulator lets you use eight bit software on sixteen bit microcomputers without hardware modifications.

The 8086 O.S. Converter™

CP to MS—Permits execution of Digital Research's CP/M-86 programs under Microsoft's MSDOS (or PCDOS).

MS to CP—Permits execution of MSDOS programs under CP/M-86.

UT-86™

This package of user-friendly utilities for the IBM Personal Computer and similar systems includes copying, directory sorting, patching, and a general purpose file print utility.

Coming Soon

DMA."C"™—A "C" language compiler which will generate either Z80 or 8086 assembly language code. Due to a unique optimization routine which is based upon a functional "P-code" model, the efficiency of DMA."C" will far exceed that of existing compilers.

DMA DMA DMA

WE SPEAK YOUR LANGUAGE WE SPEAK YOUR LANGUAGE WE SPEAK YOUR LANGUAGE

DYNAMIC MICROPROCESSOR ASSOCIATES, INC.

545 FIFTH AVENUE, NY, NY 10017

Dealer Inquiries only • (212) 687-7115

algorithms. Not only that, but algorithms won't have to derive the built-in information.

Unfortunately, basing the data structure on the musical structure was too constraining. We wanted a uniform representation for both common music notation and piano rolls so that the user could mix both types of music freely. Although it might be possible to keep a separate data structure for piano rolls, it would make the algorithms for editing, displaying, playing, and justifying much more difficult. All of these algorithms need to know what things are near one another. A simple example is redisplaying the score after a small edit has been made. For efficiency, we would like to redisplay as little of the score as possible. But that requires knowing what objects are near the entity that was edited. In the hierarchical design, an entity that is close physically may be logically far away. It might be in another measure, voice, or chord, or on a different staff. Enumerating all of the possibilities is inconvenient and time-consuming.

In addition to all this, there is the problem of exceptions. Many of the rules of notation that are presumably inviolable turn out to be violated when the composer finds the notation too constraining. A design that has fixed rules about the structure of music built into it won't be able to handle such exceptions. Even if the exceptions were ruled out, you would still have problems with the inconsistent structures that arise temporarily during editing. We wanted our design to be tolerant of such exceptions and inconsistencies.

A sequential design doesn't have these problems. It allows piano rolls to be mixed with standard music notation because both are represented as ordered sequences. Finding things that are nearby is easy, because things that are near one another on the screen are near one another in the data structure. And finally, because the data structure is so unstructured, it is flexible enough to handle a wide range of exceptions.

Mockingbird's "sequential" data structure is simply a sequence of

events ordered by time. An event might be a measure line, a collection of notes, a time signature, a clef change, or a change in the number of staves per line. The events that contain notes are called "syncs" because they synchronize all of the notes in the event. (That is, all of the notes in the sync are played or displayed together.) The notes may belong to different voices or chords, but they all have the same "time." The editor automatically synchronizes notes that are very close to simultaneous whenever notes are entered or moved. Occasionally this will introduce an error, which can be fixed by the user.

Syncs are important because they keep simultaneous notes together while the score is being edited. Usually, if the composer plays several notes at the same time, he wants them to stay together unless he explicitly says otherwise. Inserting a note before a sync shouldn't break up the sync, even if one of the notes in the sync belongs to the same voice as the inserted note. If any of the notes

BYTE back issues for sale

	1976	1977	1978	1979	1980	1981	1982	1983
Jan.				\$2.75	\$3.25	\$3.25		\$3.70
Feb.			\$2.75	\$2.75	\$3.25	\$3.25	\$3.70	\$3.70
March			\$2.75	\$2.75	\$3.25	\$3.25	\$3.70	\$3.70
April			\$2.75	\$2.75	\$3.25	\$3.25	\$3.70	\$3.70
May		\$2.00	\$2.75	\$2.75	\$3.25	\$3.25	\$3.70	\$3.70
June		\$2.00	\$2.75	\$2.75	\$3.25	\$3.25	\$3.70	\$3.70

	1976	1977	1978	1979	1980	1981	1982	1983
July	\$2.00	\$2.00	\$2.75	\$2.75	\$3.25	\$3.25	\$3.70	\$4.25
Aug.		\$2.00	\$2.75	\$2.75		\$3.25	\$3.70	\$4.25
Sept.		\$2.75	\$2.75	\$2.75	\$3.25		\$3.70	\$4.25
Oct.			\$2.75	\$2.75	\$3.25	\$3.25	\$3.70	\$4.25
Nov.				\$3.25		\$3.25	\$3.70	\$4.25
Dec.		\$2.75	\$2.75	\$3.25	\$3.25	\$3.25	\$3.70	\$4.25

Circle and send requests with payment to:
BYTE Back Issues
P.O. Box 328
Hancock, NH 03449

Please allow 4 weeks for domestic delivery and 8 weeks for foreign delivery.

name _____
 address _____
 city _____
 state _____ zip _____

The above prices include postage in the US. Please add \$.50 per copy for Canada and Mexico; and \$2.00 per copy to foreign countries.

Check enclosed

Payments from foreign countries must be made in US funds payable at a US bank.

VISA Master Card
 Card # _____ Exp. _____

Signature _____

in a sync move, they should all move. (The justifier sometimes violates this rule, but only when it is obvious that the notes have been incorrectly synchronized.)

There are three ways of measuring the "time" of an event: as seconds from the start of play, as beats from the start of the score, and as inches from the first measure line. Although these notions of time are very different, they coexist nicely because the order of one is usually the order of the other. Thus, if note A is displayed to the left of note B, it is most likely played before note B. In general, we can use the order of the notes as they appear on the display to determine the order in which they should be played. There are a few exceptions that must be handled properly—embellishments such as trills and grace notes are not always played in the order in which they are displayed. Conversely, notes that are logically simultaneous may be separated slightly on the display in the interest of visual clarity.

Beams and chords are ancillary to the main data structure, because they act as horizontal and vertical parentheses grouping notes together; they are visual aids for the human performer and aren't otherwise crucial to the score. Removing all of the beams and chords from a score would affect its readability but not its playing. In *Mockingbird*, each beam and chord knows what notes belong to it, and each note knows what beam and chord it belongs to. In addition, chords have a stem direction and beams have a tilt and vertical position.

The linear data structure we have been discussing treats a score as a single, long sequence of measures, but because music is printed on rectangular sheets of paper, this sequence must be broken up into a succession of lines. Rather than complicate the main data structure, we use a separate data structure to map between the one-dimensional score and the two-dimensional sheet of paper. This sheet data structure keeps track of how long each line is, how many lines fit on each page, how much of the line must be de-

voted to a key signature, and which section of the score goes on which line. Only the display and the justifier need to make use of this representation of the sheet; all of the other algorithms manipulate the sequential data structure directly.

Automatic Recognition

We decided not to try to write a program that would attempt to deduce the score automatically from piano-roll input because we thought that job exceedingly difficult. Why? It has been done for some simple pieces; can it not be done more generally? We believe that the relevant question is: can it be done for polyphonic piano music where the voicing is not known in advance?

To produce a proper score you must, among other things, determine the time value of all notes. Although we traditionally think of "holding a note," say, for a quarter, we don't mean literally holding the key down. What is meant is that the next note (or rest) *in that voice* is to commence

one quarter after the beginning of the note in question. Time values thus measure intervals rather than durations. (Although often the two are almost the same, in staccato playing it is not at all the case.) So, before you can assign time values to notes, you must first understand how the music is separated into its component voices. Voicing is partly dependent on thematic and harmonic relationships within the piece, but it may also be used by a composer simply to indicate how he wishes the music to be parsed by the reader, for emphasis or for division between the hands. Sometimes a single note may participate in two different voices, possibly even with two different time values. Rests and ties further complicate the problem, as they are elements that appear in the score to help complete rhythmic structuring, but they are absent from the actual playing.

The assignment of notes to staves forms a further structuring element in piano music. This assignment is a

dBEST™



dBASE II® is, quite simply, the bestselling database management system (DBMS) made for *any* computer.

Doctors and lawyers, accountants and salespeople, stockbrokers and students, big business and small—over 150,000 users around the world are all managing their data better with dBASE II.

Books have already been written about it. Hundreds of independent businesses are based on it. And other microcomputer programs measure themselves against dBASE II.

For the name of your nearest dBASE II dealer, contact Ashton-Tate, 10150 West Jefferson Boulevard, Culver City, CA 90230. (800) 437-4329 ext. 212. In Colorado, (303) 799-4900. In the U.K., (0908) 568866.

ASHTON-TATE™

© Ashton-Tate 1983.
dBASE II is a registered trademark of Ashton-Tate.
dBASE II has a suggested retail price of \$700.

Hayes

Your computer's telephone.

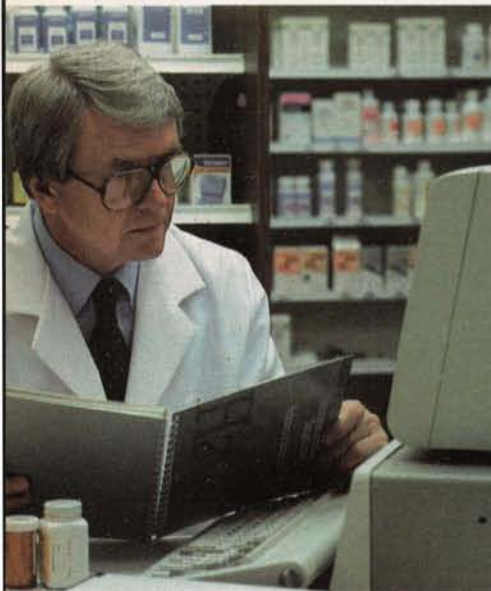

What will counteract NDC 74-0054-60?

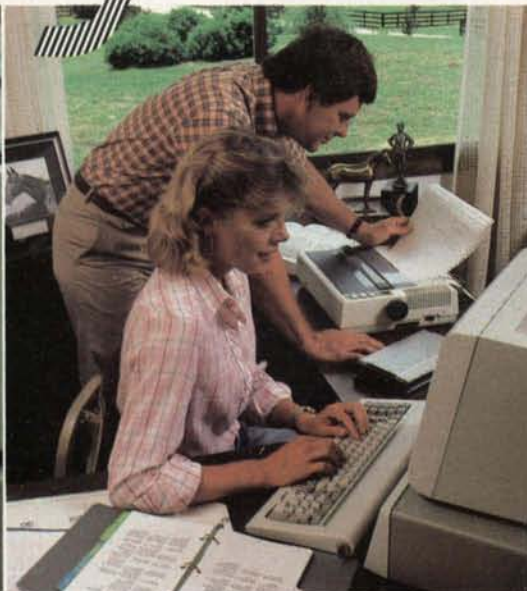

Gary: The pedigrees for next week's auction are as follows...

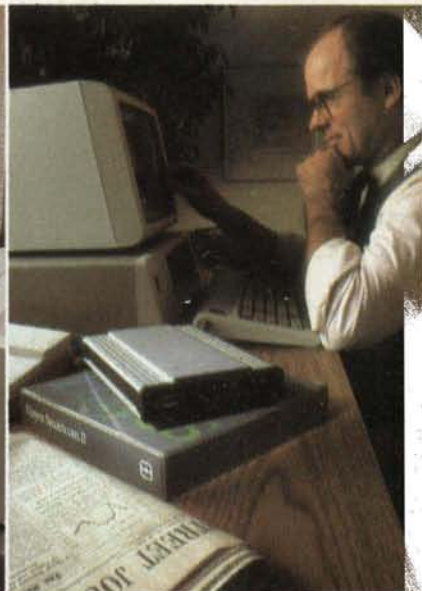

Sold 1000 shares at 33 for net profit of 6000. Richard.

Wouldn't it be great if you could use your IBM®PC to tap into vast resource libraries across the country? To transfer files to your partner, upstate? Or from your broker, down the street?

It's possible. All you need is a modem, to connect your computer to others. Down the hall. Or thousands of miles away.



Hayes Smartmodem. Think of it as your computer's telephone. Hayes Smartmodem 300™ and the faster Smartmodem 1200™ allow you to communicate over ordinary phone lines.

But any modem will send and receive data. Smartmodems also

dial, answer and disconnect calls. Automatically. And without going through the telephone receiver, making them far superior to acoustic coupler modems.

Choose your speed; choose your price. The lower-priced Smartmodem 300 is ideal for local data swaps and communicates at 300 bps. For longer distance and larger volumes, Smartmodem 1200 operates at baud rates of 300 or 1200, with a built-in selector that automatically detects transmission speeds.

Both work with rotary dials, Touch-Tone® and key-set systems; connect to most time-sharing systems; and feature an audio speaker.

Smartmodem 1200B™ is also available as a plug-in board. Developed specifically for the PC, it comes packaged with Hayes' own communications software, Smartcom II™

Smartcom II. We spent a lot of time developing it, so you can spend less time using it. Smartcom II prompts you in the

simple steps required to create, send, receive, display, list, name and re-name files. It even receives data completely unattended—especially helpful when you're sending work from home to the office, or vice versa.

If you need it, there's always "help." This feature explains prompts, messages, etc. to make communicating extra easy.

With Smartcom II, it is. Case in point: Before you communicate with another system, you need to "set up" your computer to match the way the remote system transmits data. With Smartcom II, you do this only once. After that, parameters for 25 different remote systems are stored in a directory on Smartcom II.

Calling or answering a system listed in the directory requires just a few quick keystrokes.

You can store lengthy log-on sequences the same way. Press one key, and Smartcom II automatically connects you to a utility or information service.



Smartmodem 300, 1200 and 1200B are FCC approved in the U.S. and DOC approved in Canada. All require an IBM PC with minimum 96K bytes of memory; IBM DOS 1.10 or 1.00; one disk drive; and 80-column display.

Smartmodem 1200B. (Includes telephone cable. No serial card or separate power source is needed.)



Smartcom II communications software.

NOTE: Smartmodem 1200B may also be installed in the IBM Personal Computer XT or the Expansion Unit.

In those units, another board installed in the slot to the immediate right of the Smartmodem 1200B may not clear the modem; also, the brackets may not fit properly. If this occurs, the slot to the right of the modem should be left empty.

And, in addition to the IBM PC, Smartcom II is also available for the DEC Rainbow™ 100, Xerox 820-II™ and Kaypro II™ personal computers.

Backed by the experience and reputation of Hayes. A solid leader in the microcomputer industry. Hayes provides excellent documentation for all products. A limited two-year warranty on all hardware. And full support from us to your dealer.

So see him today. Break out of isolation. Get a telephone for your personal computer. From Hayes.

Hayes Microcomputer Products, Inc., 5923 Peachtree Industrial Blvd., Norcross, GA 30092. 404/441-1617.

Smartmodem 300, Smartmodem 1200, Smartmodem 1200B and Smartcom II are trademarks of Hayes Microcomputer Products, Inc. IBM is a registered trademark of International Business Machines, Corp. Touch-Tone is a registered service mark of American Telephone and Telegraph. Rainbow is a trademark of Digital Equipment Corporation. Xerox 820-II is a trademark of Xerox Corporation. Kaypro II is a registered trademark of Non-Linear Systems, Inc.

©1983 Hayes Microcomputer Products, Inc.

Circle 181 on inquiry card.

complex function of voicing, fingering, division between hands, and aesthetic judgment. There are many other problems: identifying complex n-tuplets, distinguishing grace notes, determining rhythm and detecting rhythmic changes, identifying measure lines, determining how many staves to use, how to combine notes into beams, when to switch clefs or use ottava, and, in short, determining *all* of the complex structural-notational devices that composers use to render their music readable.

Conclusion

Our intention in presenting this material is to encourage others to pursue similar endeavors. Music editing is already being done on home computers and, while it will be some years before machines as powerful as a Dorado are found in every living room, useful tools will become feasible soon—even on home machines of modest cost. It would seem that a display of reasonable resolution and a mouse (or some similarly convenient pointing device) are prerequisites. But if you avoid the temptation to make "pretty" scores and stick to providing a simple "cut and paste" editor of piano-roll material, then a reasonable composing tool should soon become practical. The problem of storage and retrieval of snatches of material and full pieces would have to be addressed, but this seems tractable. ■

References

1. Geschke, C. M., J. H. Morris, and E. H. Satterthwaite. "Early Experience with Mesa." Report CSL-76-6. Palo Alto, CA: Xerox PARC, October 1976.
2. Mitchell, J. G., W. Maybury, and R. E. Sweet. "Mesa Language Manual," version 5.0. Report CSL-79-3. Palo Alto, CA: Xerox PARC, April 1979.
3. Lampson, B. W., K. P. Pier, S. M. Ornstein, and G. McDaniel. "The Dorado: A High-Performance Personal Computer" (three papers). Report CSL-81-1. Palo Alto, CA: Xerox PARC, January 1981.
4. Metcalfe, R. M., D. R. Boggs, R. C. Crane, E. A. Taft, J. F. Shoch, and J. A. Hupp. "The Ethernet Local Network" (three papers). Report CSL-80-2. Palo Alto, CA: Xerox PARC, February 1980.

5. Warnock, J. and D. Wyatt. "A Device-Independent Graphics Imaging Model For Use With Raster Devices." *Computer Graphics*. July 1982, pages 313-320. (Siggraph 1982).

Glossary

- accidental** - the prefix sign indicating a note that is foreign to the current key
- beam** - a bar (or bars) joining the stems of a set of notes that together form a rhythmic unit, the number of bars also indicates the time values of the notes so joined
- chord** - a group of notes played simultaneously
- clef** - (e.g., treble or bass) a sign placed at the beginning of a musical staff to determine the positions of the notes
- fermata** - a sign indicating that a note should be held past its normal value
- grace note** - a quick, light note attached to another note
- metronome** - a machine that clicks at a steady beat and can be adjusted to desired speed
- mordent** - a single rapid alteration of a principal note with an auxiliary a half-step below
- n-tuplets** - n notes, played in one beat
- ottava** - a notation for designating a section of music to be played an octave above or below where it is written
- rest** - a sign indicating silence of the same duration as the note for which it stands
- staccato** - indicates a note played crisply, in a detached manner
- time signature** - numbers at left of staff that indicate the number of beats to a measure and the note value of each beat
- trill** - an ornament produced by the rapid alterations of two notes, a half-tone or a tone apart

Acknowledgments

Mockingbird was made possible by a fortuitous convergence of people, interests, and facilities. The environment at Xerox PARC in general, and within the Computer Science Laboratory (CSL) in particular, provided a hospitable environment for this work. The existence of, and access to, a Dorado was absolutely essential. Robert W. Taylor, director of CSL, provided us with this and all other necessary facilities and support. Will Crother worked closely with us on the initial design and helped us get started. John Warnock and Doug Wyatt provided us with the Cedar Graphics software package that *Mockingbird* uses. Gene McDaniel wrote special Dorado microcode for handling the synthesizer, and Mike Overton built the hardware interface. Last, and most gratifying of all, has been the enthusiastic support that we received from our colleagues, whose vicarious pleasure in seeing *Mockingbird* come to life cheered us along the way.

John Turner Maxwell III and Severo M. Ornstein can be reached at the Palo Alto Research Center, 3333 Coyote Hill Rd., Palo Alto, CA 94304.

THE SMART CABLE™ IS THE PERFECT RS-232 MATCHMAKER FOR COMPUTERS AND PERIPHERALS.

The Smart Cables unique on-board logic "looks" at the RS-232 interface on each end of your connection, then correctly links your printer, modem or any other peripheral to your computer. Completes data lines, handshakes, everything.

NO MORE CUSTOM CABLES.

Now you can avoid the frustration and confusion of customized cables.

The Smart Cable instantly creates virtually any RS-232 interface. And if you want to swap equipment, or use other peripherals, the Smart Cable adapts. Automatically. It's one accessory that's never obsolete.

GET MORE OUT OF YOUR EQUIPMENT.

At work or at home, you can re-arrange your system with ease. One Smart Cable lets you connect many different computers and peripherals. For example, you can connect portable computers to any available serial printer. Just plug in, watch for the status lights to indicate your circuit is complete, and start working.

Best of all, the Smart Cable is priced competitively with conventional cables and custom cables.

To be a success these days you've just got to have the right connections. Call us today at 800-227-6703 (in California 800-632-7979, in Canada 800-663-9767) to make yours a whole lot easier.

REACH FOR THE SMART CABLE TO MAKE ANY RS-232 CONNECTION WITHOUT CUSTOM CABLES.

IQ TECHNOLOGIES, INC.
11811 N. E. First Street
Bellevue, WA 98005
TELEX 701 472 IQTECH U

SmartCable

The VU68K Single-Board Computer

A 68000-based system for only \$200

by Edward M. Carter and A. B. Bonds

As more and more 16-bit microprocessors appear on the market, the question of which one to base a development or hobbyist system on becomes more difficult. Ideally, most hobbyists and students would base their decision on thorough hands-on experience, but getting hold of inexpensive trainers is almost impossible. There is relief, however—the VU68K, a complete 68000-based single-board computer that can be constructed for under \$200. The VU68K is not a toy but a powerful dual-ported computing engine that is limited only by its small memory, which can easily be expanded.

Hardware Description

We set out to design a simple and low-cost 16-bit microprocessor system that would offer maximum utility in both tutorial and development applications. Of the 16-bit processors that we examined, our overwhelming choice was the 68000, which offers both simplicity and substantial processing power. This power is evident in its comprehensive instruction set, which supports two processing modes and a powerful interrupt-processing facility (also called exception processing). A secondary,

yet significant, benefit is the 68000's sales leadership. The VU68K system thus provides the user with marketable and timely knowledge. Additional reasons for selecting the 68000 include proven reliability and a commitment on the part of Motorola to maintain compatibility between its new chips and the 68000.

The 68000 uses "words" (the name for the instructions or data that the microprocessor operates on) of 16 bits or 2 bytes in "width." (Recall that an 8-bit microprocessor uses words of 8 bits in width.) We decided to include 2K words of ROM (read-only memory) with the VU68K for a monitor, and 2K words of RAM (random-access read/write memory) for developing and testing user programs. This gives the VU68K a total memory of 4K words in "length" and 16 bits in "width." In addition, we added two RS-232C-compatible serial ports for connection to a modem, a printer, or what have you.

We were able to include these features at very low cost. The parts list in table 1 shows prices from a major retail supplier of electronics parts. All of the parts are readily available and can be obtained from many sources. The prices shown are from a single

catalog—a little bargain hunting would probably yield a much less expensive system. Note that the total cost of \$190.22 is for a complete system built from scratch. It includes the costs of resistors, capacitors, wire, circuit board, etc. The cost of upgrading from an 8-bit computer to a VU68K configuration will be much less, assuming that the memories, circuit board, crystals, etc., from the old system can be retained.

Photo 1 and the schematic in figure 1 show how simple our design is. Only 15 ICs (integrated circuits) are required for the entire VU68K system. The functions of these 15 ICs can be divided into six categories: asynchronous bus operation, synchronous bus operation, interrupt handling, address decoding, communications interface, and miscellaneous support.

Asynchronous Bus Operation

The 68000 (IC2) is designed to communicate asynchronously on the system bus; that is, without a timing signal and with any amount of time between data bytes or words. To indicate when data has been received or sent, the device with which the 68000 is communicating sends an

acknowledgment signal to the 68000. This way, the device and the 68000 can operate at different rates and still communicate with each other, because one waits for the other to finish reading or writing. (See the *Motorola MC68000 16-Bit Microprocessor User's Manual* for the details on 68000 asynchronous bus communication.)

In the VU68K, only the RAM (IC9, IC10) and ROM (IC7, IC8) communicate asynchronously on the data bus. Since the memories don't themselves have an acknowledgment signal, we synthesized one with a synchronous 4-bit counter (IC4) driven by a simple oscillator circuit and 5-MHz crystal. When the address strobe signal, AS, goes low to signal a valid address on the address bus, an initial count of 1100 is loaded into the counter. After four clock ticks, the high-order output bit, connected to the acknowledge pin \overline{DTACK} (data transfer acknowledge) goes low. The transition signals that the data requested by the processor is available

Text continued on page 411

IC	Part Number	Description	Cost (\$)
1	7400	Quad 2-input NAND Gate	.19
2	68000G8	MPU 16-bit (8 MHz)	69.95
3	7404	Hex Inverter	.25
4	74161	Synchronous 4-bit Counter	.69
5	74154	4-to-16 Decoder	1.25
6	7432	Quad 2-input OR Gate	.29
7	2716	16K EPROM 450ns	4.95
8	2716	16K EPROM 450ns	4.95
9	6116-P4	Static RAM 200ns 16K CMOS	6.95
10	6116-P4	Static RAM 200ns 16K CMOS	6.95
11	6850	Async. Comm. Int. Adapter	4.95
12	6850	Async. Comm. Int. Adapter	4.95
13	14411	Bit-rate Freq. Generator	11.95
14	1488	Quad Line Driver	.69
15	1489	Quad Line Receiver	.69
—	8800V	Vector Board	24.95
—	7812	12-volt Positive Regulator	.79
—	7912	12-volt Negative Regulator	.89
—	—	5 MHz Crystal	2.95
—	—	1.8432 MHz Crystal	4.95
—	—	Capacitors, Resistors, Wire	4.25
—	—	Pushbutton Switch	1.95
—	—	8-position DIP Switch	1.49
—	—	14-pin Wire-wrap Socket	5 @ .45
—	—	16-pin Wire-wrap Socket	2 @ .69
—	—	24-pin Wire-wrap Socket	8 @ 1.29
—	—	64-pin Wire-wrap Socket	14.40

Table 1: Parts list.

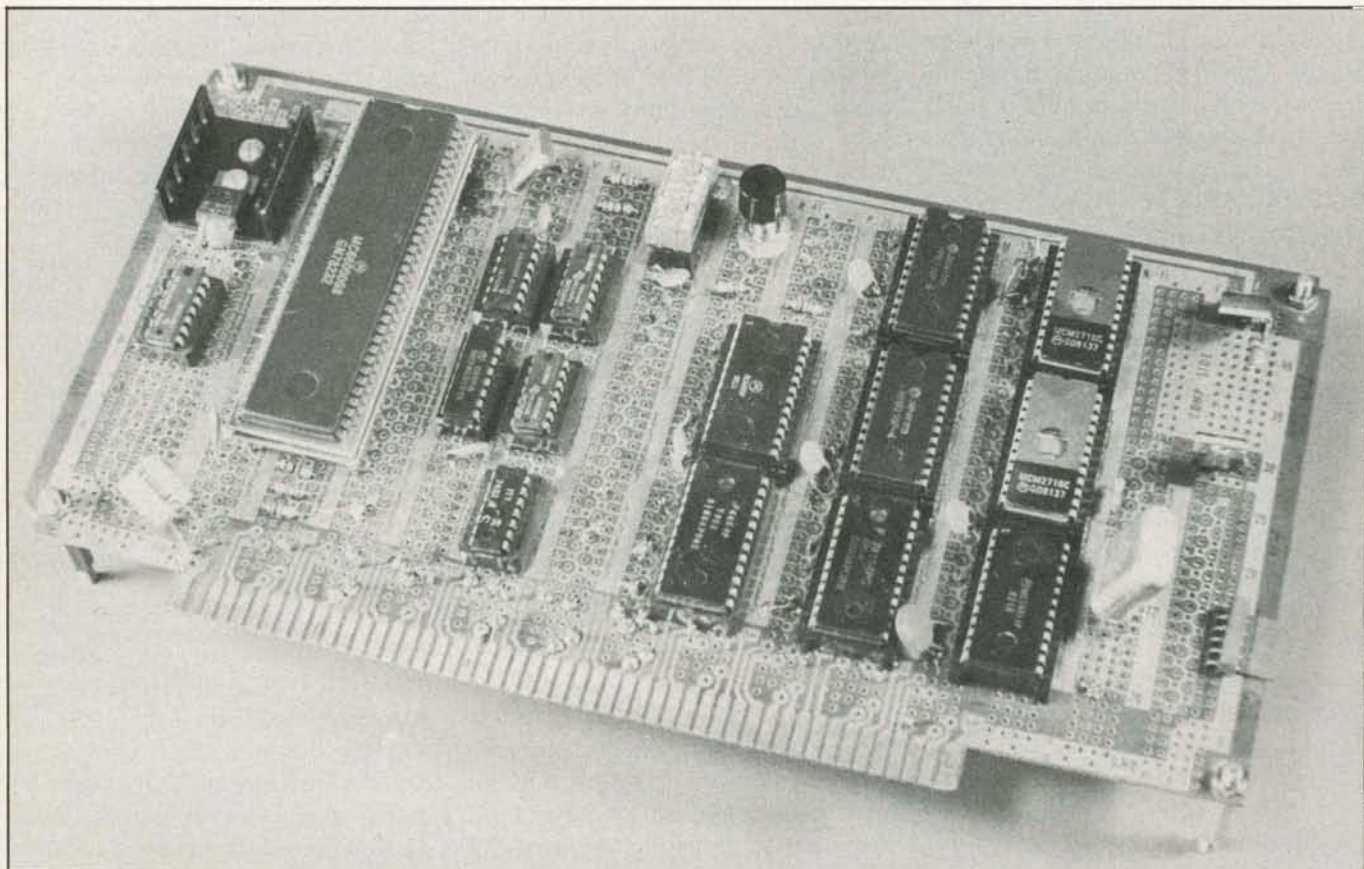

Photo 1: The VU68K board.

COMPU SHACK

PRICES AND AVAILABILITY SUBJECT TO CHANGE WITHOUT NOTICE
 ALL RETURNED MERCHANDISE SUBJECT TO A 20% RESTOCKING FEE
 ADD 10% FOR NET TERMS
 PRICES GOOD IN U.S. ONLY
 PRICES REFLECTED IN THIS SECTION ARE LOWER THAN FRANCHISE STORE

WE TEST EVERY COMPUTER SYSTEM BEFORE WE SHIP IT!

AST RESEARCH

IO Plus-Parallel & Serial Port, Clock Calendar W/Bat. back-up. Superdrive. Superspool **\$199.00**

Combo Plus—256K, Parallel & Serial Port, Clock Calendar W/Bat. back-up. Superdrive. Superspool **\$499.00**

Mega Plus—512K, Parallel & Serial Port, Clock Calendar W/Bat. back-up **\$999.00**

QUADRAM

Quad Board - 256K, Parallel Port, Serial I/O Clock Calendar with battery backup **\$599.00**

512K Ram with Serial I/O **\$799.00**

CONOGRAPHIC

Color Card **\$995.00**

HERCULES GRAPHICS CARD

This card gives you 720x350 graphics **\$499.00**

BIG BLUE **\$479.00**

MAYNARD SANDSTAR SERIES

Multifunction Card **\$95.00**

Floppy Disk Controller **\$225.00**

Memory Card **\$189.00**

MONITORS

AMDEK

300A **\$199.00** I **\$349.00**

300G **\$169.00** II **\$699.00**

310A **\$199.00** III **\$399.00**

IV **\$1199.00**

PRINCETON GRAPHICS SYSTEMS

High Res. Color **\$499**



FLOPPY DISK DRIVES

SHUGART

SA400 SS/SD **\$169.00**

TANDON

TM-100-2 DS/DD **CALL**

TM-848-1 SS/DD **\$349**

TM-848-2 DS/DD **\$399**

SIEMENS

FDD 100-5 **\$159.00**

DISK DRIVES

For IBM PC

Tandon 100-2 **CALL**

320KB DS/DD Disk Drive for IBM PC **\$199.00**

Add On Drive For PC Jr® **SCALL**

PRINTERS

BROTHER

brother

HR-1 A parallel **\$769.00**

HR-1 A serial **\$869.00**

DX-15 **\$599.00**

Tractor feed option **\$135.00**



IBM
PERSONAL
COMPUTER

Special of the Month!

IBM PC® COMPLETE LINE

IBM PC

64K, Two 320KB Disk Drives, Floppy Disk Controller, Video Card and High Res Monitor **\$2599.00**



SPECIAL OF THE MONTH!

TAVA PC

TAVA

Desk Top IBM PC® Compatible Computer, 128K RAM, Two 320KB Disk Drives, Floppy Disk Controller, Video Adapter and Monitor, One Parallel Port, Two Serial Ports. System runs DOS 1.1, 2.0, and CP/M86® **\$1995.00**

APPRICOT an IBM PC® Compatible Computer W/Two Drives & Monitor **W/\$1250** worth of Software-Complete System **\$2999.00**

LOTUS 1-2-3 SOFTWARE **\$459**

HARD DISK SYSTEMS FOR IBM

HARD DISK SYSTEM FOR IBM PC

256K IBM PC, 360KB Disk Drive, FDC, 10 MB Hard Disk w/controller, Cabinet controller & software, Color Card, Monitor **\$3999.00**

Hard Disk Sub-System for IBM PC By TAVA CORP **\$1275.00**

PRINTERS

OKIDATA

82A **\$429.00**

83A **\$699.00**

84AP parallel **\$999.00**

84AS serial **\$1099.00**

92A **\$525.00**

93A **\$899.00**

Daisywriter Daisywheel

Printer **\$1175.00**

NEC

SPINWRITER

NEC



7710-1 **\$2095** 3510 **\$1495**

7715-1 **\$2295** 3515 **\$1495**

7730-1 **\$2095** 3530 **\$1695**

7720-1 **\$2695** 3550 **\$1995**

7725-1 **\$2695** PC8023A **\$ 595**

APPLE IIe

apple

Computer System Controller, Two Disk Drives, Monitor **\$1699**

ROMAR II Apple compatible Computer W/Z-Card Controller, Two Disk Drives and a Monitor for **\$1195.00**

OTHER PRODUCTS FOR APPLE

Special of the Month!

\$179



TAVA CORP. DATA DRIVE

100% Compatible Disk drive for APPLE II+ and APPLE IIe. Runs DOS, CPM®, Pascal software.

SLIMLINE DRIVE **\$199.00**

HAYES MICROCOMPUTER PRODUCTS

Micromodem 300 baud **\$299.95**

Smartmodem 1200 baud **\$529.95**

COMPU SHACK

THE UNIQUE FRANCHISING CONCEPT WITH THE FOLLOWING FEATURES:

PRIVATE LABEL PRODUCTS WITH NO ROYALTIES, DISCOUNT PRICES, FULL SERVICE & SUPPORT, COURTESY AND MORE.

Circle 85 on inquiry card.

(714) 261-1000

FRANCHISE INQUIRIES WELCOME

16861 ARMSTRONG, IRVINE, CA 92714

HEADQUARTERS/TELEX: 181667—ANSWER BACK: COMPDHACK IRIN

*IBM is a registered trademark of IBM Corporation
 *APPLE is a registered trademark of Apple Computers, Inc.
 *CP/M and CP/M86 are registered trademarks of Digital Research, Inc.

PRODUCTS AND PRICES NOT AVAILABLE AT ALL STORES

ALL FLOPPIES REPAIRED QUICKLY AT LOW COST

CALL FOR STORE LOCATION

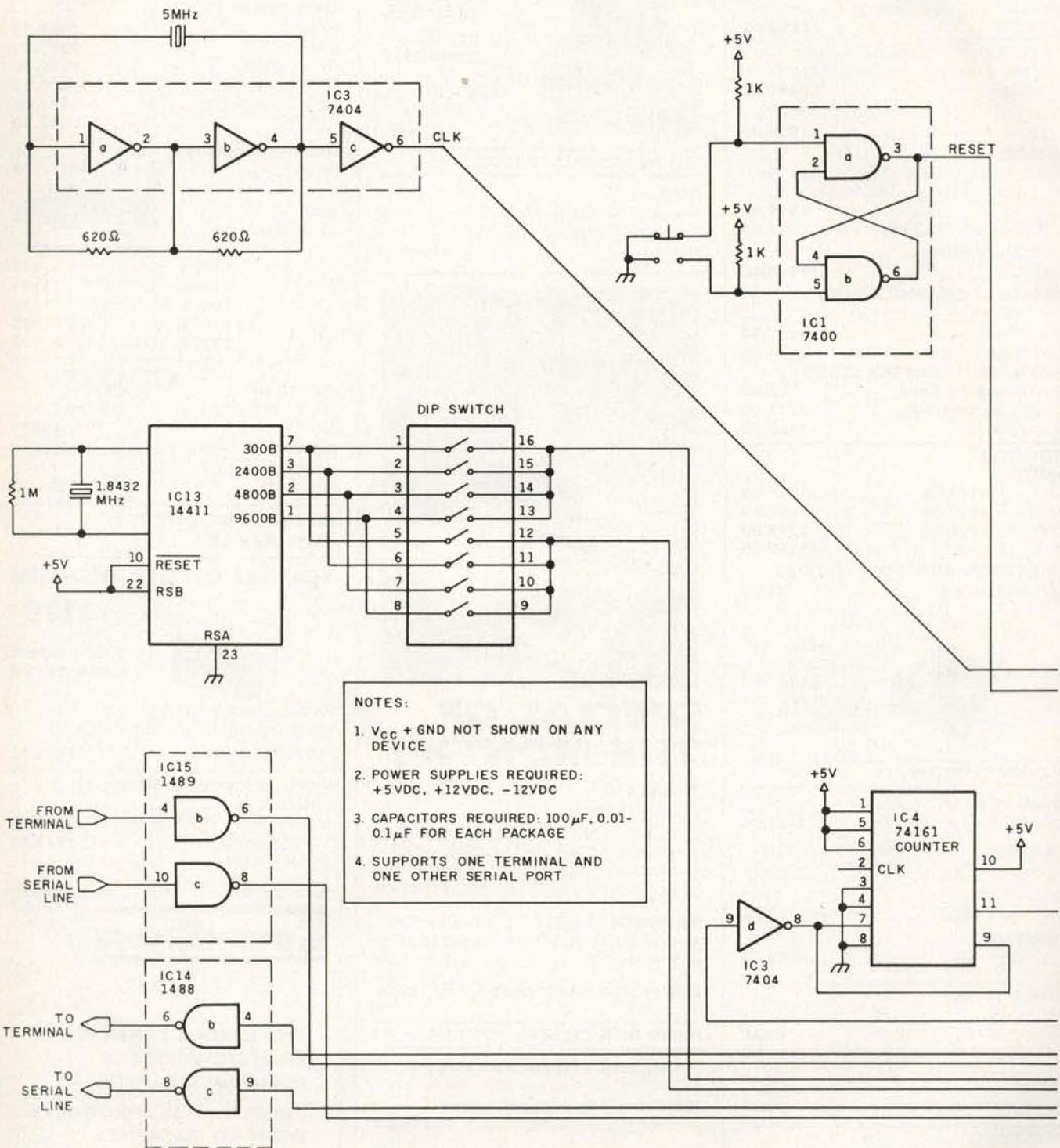
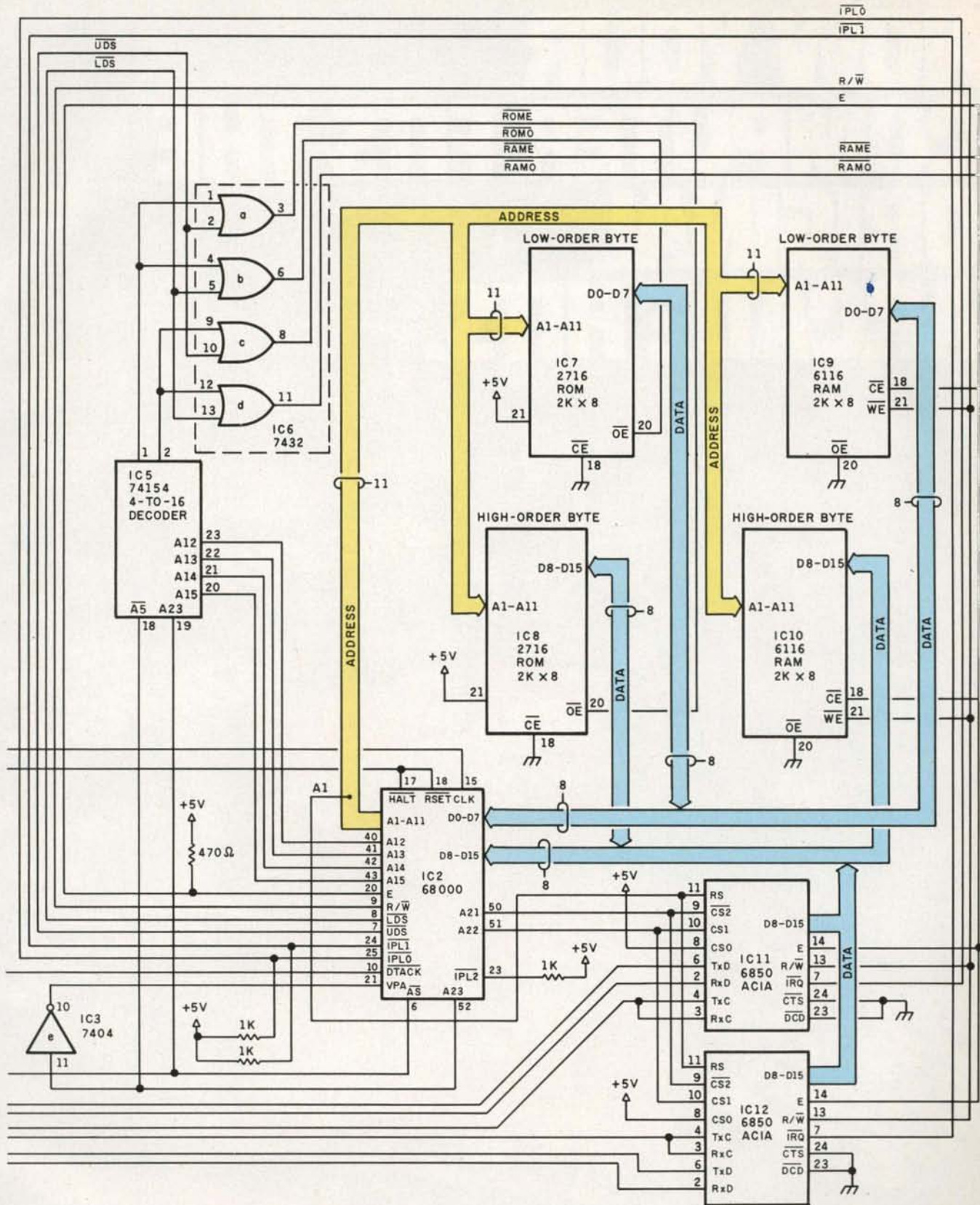

Figure 1: The VU68K schematic.



NOW YOUR COMPUTER FITS THE ORIGINAL ARCADE HITS.



Now the excitement of original arcade graphics and sound effects comes home to your computer.

Introducing ATARISOFT.™ A new source for computer software.

If you own a Commodore VIC 20 or 64, a Texas Instruments 99/4A, an IBM or an Apple II, you can play the original arcade hits.

DONKEY KONG by Nintendo, CENTIPEDE,™ PAC-MAN, DEFENDER, ROBOTRON: 2084, STARGATE and DIG DUG. (On the TI 99/4A you can also play Protector II, Shamus, Picnic Paranoia and Super Storm.)

So, start playing the original hits on your computer.

Only from ATARISOFT.

Some games also available on ColecoVision and Intellivision.

ATARISOFT™

Now your computer fits the arcade hits.

DONKEY KONG, Mario and NINTENDO are trademarks and © Nintendo 1981, 1983. PAC-MAN and characters are trademarks of Bally Midway Mfg. Co. sublicensed to Atari, Inc. by Namco-America, Inc. DEFENDER is a trademark of Williams Electronics, Inc., manufactured under license from Williams Electronics, Inc. ROBOTRON: 2084 is a trademark and © of Williams 1982, manufactured under license from Williams Electronics, Inc. STARGATE is a trademark and © of Williams 1981, manufactured under license from Williams Electronics, Inc. DIG DUG is created and designed by Namco Ltd. manufactured under license by Atari, Inc. Trade-marks and © Namco 1982. PROTECTOR II is a trademark of Synapse Software Corporation, manufactured under license by Atari, Inc. SHAMUS is a trademark of Synapse Software Corporation, manufactured under license by Atari, Inc. PICNIC PARANOIA is a trademark of Synapse Software Corporation, manufactured by Atari, Inc. SUPER STORM is engineered and designed by Synapse Software Corporation, manufactured under license by Atari, Inc. ATARISOFT™ products are manufactured by Atari, Inc. for use on the above referenced machines and are not made, licensed or approved by the manufacturers of these machines. COMMODORE 64, VIC 20, TEXAS INSTRUMENTS 99/4A, IBM, APPLE, COLECOVISION and INTELLIVISION are respectively trademarks of Commodore Electronics Limited, Texas Instruments, International Business Machines Corp., Apple Computer, Inc., Coleco Industries, Inc. and Mattel, Inc. A Warner Communications Company. © 1983 Atari, Inc. All rights reserved.

Complete this coupon and we'll keep you up to date on the newest hits from ATARISOFT.™

Name _____

Address _____

City _____ State _____ Zip _____

Telephone _____

PRODUCT OWNED: (Check one)

- | | |
|---|---|
| 1 <input type="checkbox"/> TI-99/4A | 5 <input type="checkbox"/> Commodore Vic 20 |
| 2 <input type="checkbox"/> IBM PC | 6 <input type="checkbox"/> Intellivision |
| 3 <input type="checkbox"/> Commodore 64 | 7 <input type="checkbox"/> Apple II |
| 4 <input type="checkbox"/> ColecoVision | 8 <input type="checkbox"/> _____ |

Mail to:
Atari, Inc., P.O. Box 2943,
So. San Francisco, CA 94080.

ASM 2

Circle 35 on inquiry card.

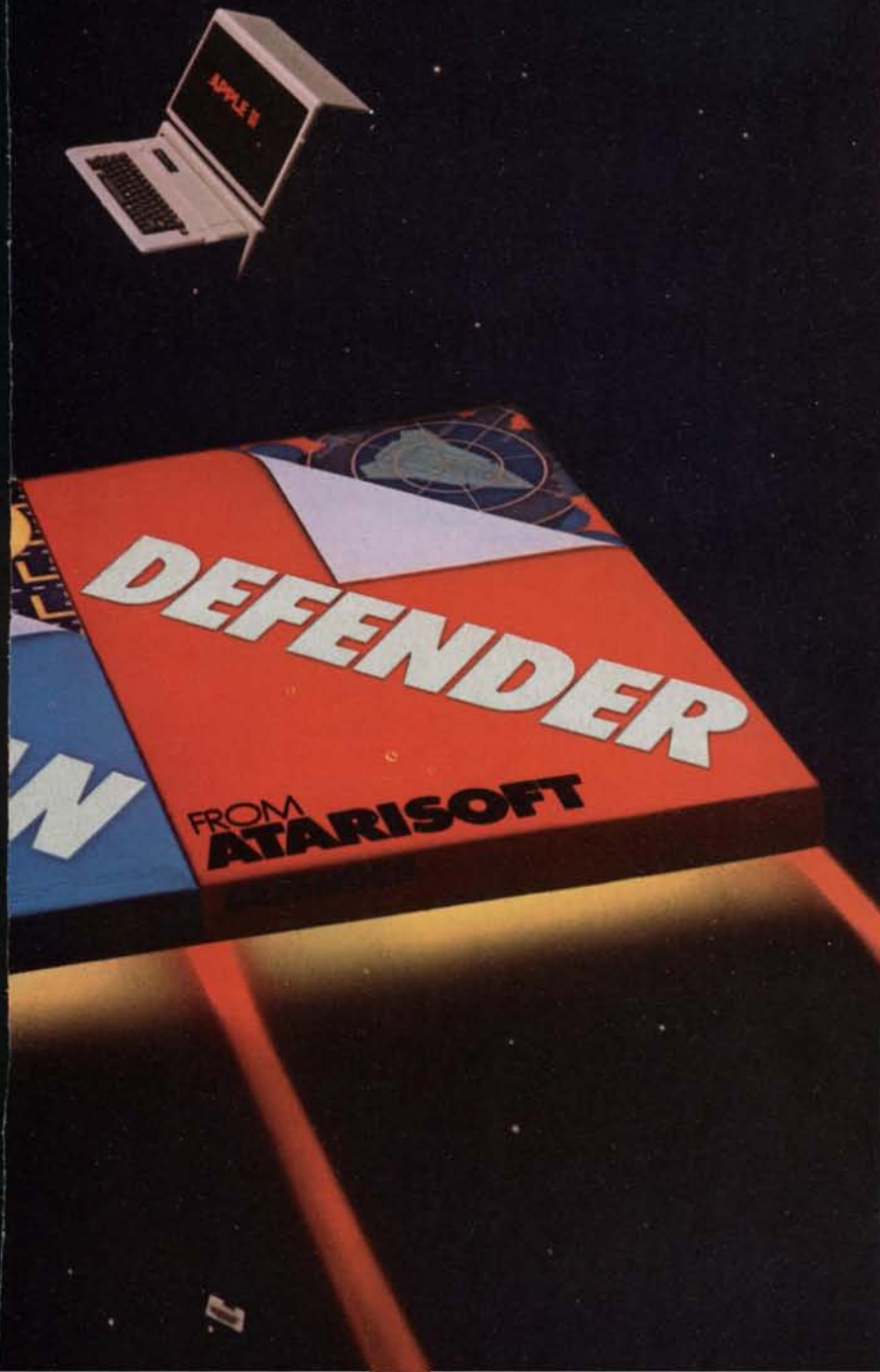

Four Reasons Why The Dysan Difference is Worth Paying For

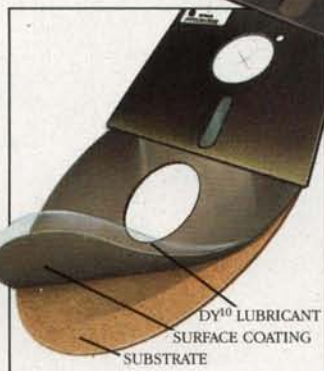
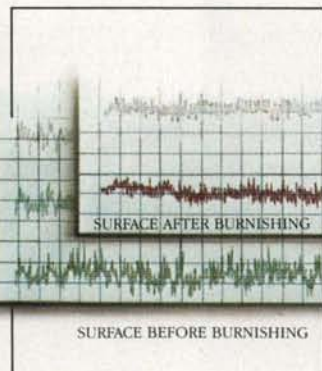

1. 100% Surface Tested

Only Dysan provides fully usable diskette surfaces that are truly 100% error-free across the entire face of the diskette. An exclusive on-and-between the track testing procedure guarantees error-free performance regardless of temperature and humidity distortions or slight head misalignments.

2. Advanced Burnishing Techniques

Dysan's advanced polishing methods create a smoother, more uniform diskette surface. This results in better signal quality on each track, less wear on drive heads and reliable access to data after millions of head passes.

3. DY¹⁰™ Lubricant

Dysan's proprietary DY¹⁰ lubricant complements the advanced burnishing process. Both maximize error-free performance while minimizing headwear. Optimal signal presence is maintained between the head and diskette surface during millions of write/read interfaces.

DY¹⁰ is a trademark of Dysan Corporation

4. Auto-Load Certification

Dysan's unique quality control methods reflect technological leadership in designing, producing and testing precision magnetic media. Each diskette is unerringly certified by Dysan-built, automated and microprocessor controlled certifiers. Your system and data base will benefit from Dysan's diskette reliability and unsurpassed quality.

Select from a complete line of premium 8" and 5 1/4" diskettes, in single or double densities, certified on one or both sides.



Corporate Headquarters:
5201 Patrick Henry Drive
Santa Clara, CA 95050
(800) 551-9000

on the bus. With a clock speed of 5 MHz, this provides 800 nanoseconds (ns) for the transfer to occur.

Synchronous Bus Operation

In the design of the 68000, Motorola recognized that a large number of 8-bit synchronous peripherals are available and familiar to many people. These devices depend on the timing signals generated by the 6800 family of processors for data communication. To provide compatibility, the 68000 can also generate a synchronous timing signal.

When the \overline{AS} line is asserted (low), the synchronous peripherals must pull the \overline{VPA} (valid peripheral address) processor pin low to generate the synchronous timing signals \overline{VMA} (valid memory address) and \overline{E} (enable). In the VU68K, the only set of devices that uses synchronous transfers is the Asynchronous Communications Interface Adapters or ACIAs (IC11, IC12), which drive the two serial ports (note that the term asynchronous here refers to the RS-232C standard and not the bus protocol). These two ports may be accessed at addresses \$A00000-\$A00002 and \$C00000-\$C00002. (For the remainder of this article, the prefix "\$" will denote a hexadecimal address.) Address line A23 is tied to the processor's \overline{VPA} pin through an inverter (IC3). When either ACIA is selected, A23 must be high, which pulls \overline{VPA} low and initiates the synchronous data transfer. After the transfer is complete, the processor automatically resumes asynchronous operation. This scheme limits addresses using A23 to synchronous devices only.

Interrupt Handling

The 68000 has two modes of interrupt processing: normal and alternate. In the normal mode, the processor responds to an interrupt request by placing the level number of the interrupt on bits A1-A3 of the address bus and driving the function code lines FC0-FC2 high. The interrupting device then must place a vector number on the data bus and pull \overline{DTACK} low to signal the 68000 that the vector number is available. The

Address	Device
\$000000-\$000FFF	ROM
\$001000-\$001FFF	RAM
\$A00000-\$A00002	Terminal
\$C00000-\$C00002	Serial Port

Table 2: The address map.

68000 uses this vector number to acquire the service-routine address from the vector table in low memory. In the alternate mode, known as auto-vectoring, the processor again places the level number of the interrupt on A1-A3 and drives FC0-FC2 high. Then, instead of placing a vector number on the data bus, the interrupting device pulls the \overline{VPA} processor pin low. This causes the processor to acquire the service-routine address from the position in the vector table that corresponds to the interrupt level. Therefore, in auto-vector mode, there are seven interrupt vectors, each of which is associated with one level of interrupt.

The VU68K uses the auto-vector mode for interrupts. When the 68000 responds to an interrupt, all address bus lines except A1-A3 are driven high. Since A23 is connected to \overline{VPA} through an inverter to support synchronous transfers, the processor is forced into the auto-vector mode for all interrupts.

The VU68K acknowledges only two levels of interrupt: level 1 for keyboard serial-port interrupts and level 2 for communication serial-port interrupts. Interrupts are signaled by lines $\overline{IPL0}$ and $\overline{IPL1}$. $\overline{IPL2}$ is always maintained high. This interrupt structure enables the keyboard and communication serial ports to be used simultaneously.

Address Decoding

The VU68K's memory is divided into 2K-word by 16-bit memory blocks, with a total potential of 32K words. The reason for this arrangement is that the VU68K uses only 11 of the 68000's address bits for word selection and another 4 address bits for memory-block selection. The 11 bits select one of 2K words, while the

other 4 bits select one of sixteen 2K-word blocks. Since each block contains 2K words, the total memory capacity is 2K by 16 or 32K words.

The word-selection bits, A1-A11, go directly to each of the ROM and RAM ICs. The block-selection bits, A12-A15, go to a 4-to-16 decoder (IC5). The decoder, through the IC OR gates, pulls the output enable (\overline{OE}) lines of the selected 2K-word block low to activate that block. Since the data bus on the 68000 is 16 bits wide and the memory ICs used in the VU68K are each 8 bits wide, we had to use two memory ICs for each 16-bit-wide memory block. One of the memory ICs is assigned to the high-order 8 bits of the data bus, while the other is assigned to the low-order 8 bits.

The VU68K uses the 68000's \overline{UDS} and \overline{LDS} lines to control the method by which data is transferred to or from memory. If both lines are low, then data transfers occur in 16-bit words. If only one of the lines is low, then transfers occur one byte at a time. Note that two memory chips are active for a 16-bit transfer, while only one chip is selected for an 8-bit transfer. To select the correct device for a memory transfer, the output of the decoder is combined through an OR gate with the \overline{UDS} and \overline{LDS} signal to generate four signals—RAME, RAMO, ROME, ROMO—for selecting the correct memory device. The address map is shown in table 2.

To add memory or other asynchronous devices to the VU68K, all we have to do is select an address in the lower 64K bytes of memory. The high-order 4 bits of this new address cause one pin of the address decoder to be driven low. The output from this pin can then be used with additional decoding logic for selecting the new device. Adding a new asynchronous peripheral is even easier. Just select an address that sets address bit A23 and is not used by any other device. Addresses that set bit A23 are in the range \$800000-\$FFFFFF.

Let's assume that we wish to add another 2K-word block. We'll place two 6116 static RAM chips, 2K by 8 bits each, at addresses \$002000-\$002FFF. From the address map in

table 2 we can see that these locations are not currently used. The new RAM select line will be pin 3 of the address decoder output. Two additional OR gates will be required to ensure that the device assigned to the upper and lower portion of the bus is addressed only when dictated by the appropriate setting of UDS and LDS. The address map in table 3 represents the new configuration.

If we want to add a new synchronous device, the address extension is even simpler. Let's assume that we wish to add another serial port. The Motorola 6850 we used earlier is a serial port chip that requires three chip selects, two in the high state and one in the low state. If we tie one of these to a high state and then use the other two select lines, we can safely use addresses \$900000-\$900002 for the device's control/status and data registers, respectively. This address avoids conflict with the other two synchronous devices and allows us to drive the device select lines without additional logic. The high select line will be address line A20, and the low select line will be address line A21. Table 4 is an address map that includes the new memory and serial port.

To enhance the interrupt structure so that not all interrupts are handled in the auto-vector mode, make sure that the synchronous mode-select line is still driven high when the terminal and serial ports are addressed. Discrete logic can easily remedy this problem.

Communications Interface

The basis of the VU68K's communication facility is the ACIA. This 8-bit device communicates synchronously on the data bus and asynchronously on the external RS-232C line. Both ACIA devices in the VU68K are initialized by the monitor software to handle full-duplex RS-232C lines with two stop bits and no parity. You can change these characteristics by moving new values to the terminal and serial port control registers at locations \$A00000 and \$C00000, respectively. The values to be loaded there can be determined from the Motorola 6850 data sheet.

Address	Device
\$000000-\$000FFF	ROM
\$001000-\$001FFF	RAM
\$002000-\$002FFF	New RAM
\$A00000-\$A00002	Terminal
\$C00000-\$C00002	Serial Port

Table 3: The extended address map.

Address	Device
\$000000-\$000FFF	ROM
\$001000-\$001FFF	RAM
\$002000-\$002FFF	New RAM
\$900000-\$900002	New Serial Port
\$A00000-\$A00002	Terminal
\$C00000-\$C00002	Serial Port

Table 4: The extended address map with a serial port added.

Vector Address	Interrupt
\$1000	User Trap-vector B
\$1004	User Trap-vector C
\$1008	User Trap-vector D
\$100C	User Trap-vector E
\$1010	User Trap-vector F
\$1014	User Interrupt-vector 1
\$1018	User Interrupt-vector 2
\$101C	User Interrupt-vector 3
\$1020	User Interrupt-vector 4
\$1024	User Interrupt-vector 5
\$1028	Auto-vector Level 3
\$102C	Auto-vector Level 4
\$1030	Auto-vector Level 5
\$1034	Auto-vector Level 6
\$1038	Auto-vector Level 7

Table 5: User interrupt-vectors.

We added two line conditioners after the ACIAs to provide RS-232C logic levels to the external lines. We used 1488 and 1489 quad line-drivers/receivers (IC14, IC15) for this purpose. A 14411 bit-rate frequency generator (IC13) and a 1.8432-MHz crystal tell the ACIAs at what data rate they may transmit and receive on the RS-232C lines. Data rates are switch selectable through a dual in-line package (DIP) switch and may be selected independently for either the terminal or communication serial port. The allowable data rates are 300, 1200, 2400, and 9600 bps. You can use other data rates by connecting the DIP switch to the proper pins on the 14411. All interrupts generated by the

terminal or communication serial port are handled by the interrupt-service routines in the monitor, which we will describe later.

Miscellaneous Support

The only devices we haven't yet covered are the reset and clock circuits. The reset circuit is simply a debounced switch that pulls both the RESET and HALT pins of the processor low. These pins must be held low for at least 100 milliseconds for the reset operation to function correctly. In the VU68K, we used a push-on/push-off switch to do this. You can use a conventional momentary contact switch if you ensure that the switch is off for at least 100 milliseconds.

The clock circuit is an oscillator circuit driven by a 5-MHz crystal. The resulting signal, CLK, drives both the processor clock and the counter used in asynchronous accesses.

A Monitor Program

To support the hardware of the VU68K, we developed a comprehensive monitor program called VUBUG. VUBUG provides a set of program-development support services that includes I/O (input/output) buffering, program-development commands, trap handlers, and error-handling utilities.

VUBUG provides buffered I/O for both the terminal and communication serial port. Separate interrupt-handling routines for these devices located at level 1 and level 2 of the interrupt structure, respectively, provide a complete set of facilities for implementing concurrent buffered I/O. When a port generates an interrupt, VUBUG causes the processor to read the port and place the data in a buffer that can store 16 bytes. A trap instruction, which we will discuss later, retrieves the data. Interrupts from the terminal keyboard cause the character read to be echoed immediately as well as buffered.

The VUBUG interrupt structure includes five auto-vectors, the first five user interrupt-vectors, and five user trap-vectors, which are loaded by the monitor to point to the locations shown in table 5. At each of these



If you're running out of ways to tell your boss the copier broke again, it's time for a Panasonic.

Before your copier causes a breakdown in communications between you and your boss, tell him about the Panasonic FP-2520. It uses advanced electronics and has four compact flat motors to help prevent breakdowns. But, like all Panasonic copiers, the FP-2520 is designed to be more than reliable.

With its patented Magnefine™ Toning Process you'll make crisp, clean copies, from edge to edge, copy after copy. Even the subtle details of photographs are captured. And with

three sizes of enlargement and four sizes of reduction, the FP-2520 can solve almost any copying problem. Add a few accessories, and this Panasonic becomes a complete copying system that can feed and collate up to 25 copies per minute. Once you get the Panasonic FP-2520 copier, you may never have to speak to your boss again.

If you're afraid to talk to your boss, talk to us. Call 1-800-526-0354. In New Jersey, call (201) 384-0275.

Panasonic®
just slightly ahead of our time.
Circle 281 on inquiry card.

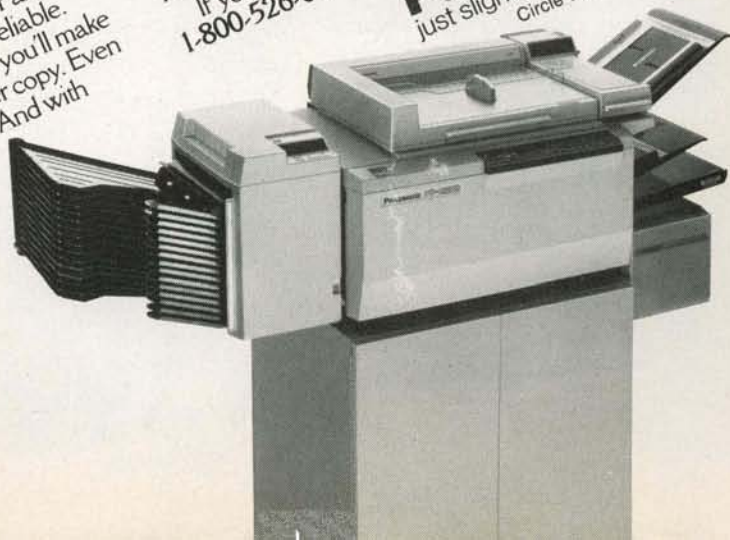



The personal portable daisywheel printer

Only \$599.

For the first time, your letter-quality printer can be used almost anywhere! Bring the new Transtar 120 with you to work, to school, or home again! Conveniently weighing in at less than 19 pounds, it generates unrivaled print quality and is the size of a standard briefcase. The new 120 is so light, so small, that you can take it with you!

Remarkably, the new \$599 Transtar 120 is "plug and go" compatible with the best-selling word processing programs. Just plug the 120 into your personal computer and watch this precision printer purr along at 14 cps Shannon text speed producing superscript, subscript, underlining and a true boldface. Even using letterhead is now a breeze with the 120's automatic single sheet loading!

Don't worry about durability: it's a tough little machine. It joins the highly reliable family of Transtar printers with a failure rate that's the envy of the industry: less than 1%. Should your 120 ever need repair, a nationwide network of authorized service centers stands ready for speedy repair on your six-month end-user warranty.

Just think of it: everything you want in a letter-quality printer...anywhere you want it. Only \$599.

Transtar

P.O. Box C-96975, Bellevue, Washington 98009

Circle 363 on inquiry card.

locations, you may assemble a branch instruction to an exception handler that you provide. The 4 bytes set aside for each vector allows for a branch with a 16-bit displacement. Be careful to terminate these exception handlers with an RTE instruction to ensure proper return from the exception handler.

VUBUG supports a set of com-

mands that we've selected to support the goal of simplicity. Table 6 summarizes the available commands and subcommands. Perhaps the most powerful command for program development is a combination of the Trace (t+) and Breakpoint (b+) commands. Trace is an instruction-by-instruction trace of the value of the user program counter; it shows the

Command	Action
m<cr>	Start memory mode
m xxxx	Start memory mode at xxxx
.xxxx	Set pointer to xxxx
= xx	Store value xx at address in pointer
,xx	Increment pointer and store xx
+	Increment pointer and display value
-	Decrement pointer and display value
l<cr>	Start program load
l xxxx	Start program load and offset each block by xxxx bytes
d<cr>	Display the next 80 bytes from memory pointer
d xxxx<cr>	Display 80 bytes starting at address xxxx
d xxxx,yyyy	Display all data between locations xxxx and yyyy inclusive
t+	Start trace
t-	Stop trace
s+	Start single step
s-	Stop single step
e	Start terminal emulator mode
g xxxx	Start program at address xxxx
g<cr>	Start user program from address in user PC
<cr>	Same as g<cr>
b+ xxxx	Insert a breakpoint at address xxxx
b- xxxx	Remove a breakpoint at address xxxx
b<cr>	Show all breakpoints
b#	Remove all breakpoints
r<cr>	Start register mode
r xx	Start register mode at register xx where xx is: SR/sr status register PC/pc program counter D0/d0 - D7/d7 data registers A0/a0 - A7/a7 address registers
.xx	Set register pointer to register xx
= xxxxxxxx	Store value in register at pointer for SR value is xxxx
<cr>	Print values in all registers
px yyyy	Associate with px the program starting at address yyyy; where x is 1, 2, or 3
px<cr>	Execute command px where x is 1, 2, or 3
c xxxx=yyyy,zzzz	Copy from location yyyy through location zzzz to locations starting at xxxx and increasing

Table 6: Command summary.

Trap	Function	Place Argument in Register	Return Argument is Placed in Register
0	Exit	None	None
1	Get byte	None	D0
2	Get word	None	D0
3	Get long	None	D0
4	Write byte	D0	None
5	Write word	D0	None
6	Write long	D0	None
7	Get character	None	D0
8	Write string	A0	None
9	Write character	D0	None
A	Write cr-lf	None	None

Table 7: VUBUG traps.

ERG/68000 MINI-SYSTEMS

- Full IEEE 696/S100 Compatibility

HARDWARE OPTIONS

- 8MHz, 10 MHz, or 12 MHz 68000/68010 CPU
- 68451 Memory Management
- Hardware Floating Point
- Multiple Port Intelligent I/O
- 64K/128K Static RAM (70 nsec)
- 256K/512K/1MB Dynamic RAM (150 nsec)
- Graphics-Digital Graphics CAT-16000
- DMA Disk Interface
- SMD Disk Interface
- Tape Streamer Backup
- 5 1/4" or 8" Floppy Disk Drives
- 5MB-474MB Hard Disk Drives
- 7/10/20 Slot Back Plane
- 20 or 30A Power Supply
- Desk Top or Rack Mount Encl.

SOFTWARE OPTIONS

- 68KFORTH¹ Systems Language
- CP/M-68K²O/S with C, 68K-BASIC¹, 68KFORTH¹, FORTRAN 77, Z80 Emulator, Whitesmiths' C
- IDRIS³ O/S with C, PASCAL, FORTRAN 77, 68K-BASIC¹, CIS COBOL⁴, INFORMIX⁵ Relational DBMS
- UNIX⁶ SYS III O/S with C, PASCAL, FORTRAN 77, BASIC, RM COBOL⁷, ADA⁸, INFORMIX⁵, Relational DBMS
- VED 68K Screen Editor
- Motorola's MACSBUG and FFP Package

Trademark ¹ERG, ²Digital Research, ³Whitesmiths, ⁴Micro Focus, ⁵RDS Inc., ⁶Bell Labs, ⁷Ryan McFarland, ⁸U.S. DoD

30 Day Delivery - OEM Discounts



since 1974

Empirical Research Group, Inc.
P.O. Box 1176
Milton, WA 98354
206-631-4855

program's execution path. Breakpoint stops the program at the address you select. With these two commands, a user may see the instructions leading to a breakpoint and then use the other commands available in VUBUG to examine registers and memory to determine why that path was taken or to modify the path that will be taken after the breakpoint.

The VUBUG monitor provides 11 traps for servicing user-program requests. These traps are called simply by executing the appropriate trap in-

struction with the appropriate argument, as shown in table 7. In addition to these trap handlers, you can use traps B through F with the vectors at locations shown in table 5.

Error handling, or exception processing, for processor-detected errors, is also provided by VUBUG. Error handling involves intercepting the interrupt and reporting the error on the terminal. In addition, the register values are copied into the register save area and are accessible via the r command. The errors trapped in-

clude address/bus errors, illegal instruction errors, privilege violations, and a class of generic errors that share a single error handler. The errors in this class are zero divide, CHK and TRAPV, and spurious interrupts.

Rounding Out

For a complete development system, you'll need an RS-232C terminal, a power supply that provides +5 volts at 0.5 amperes, and +12 and -12 volts at 0.1 amperes, and a host computer.

Development software on the host should include a disassembler, high-level language processors, cross-reference builders, machine simulators, and so forth. The only additional software required is a simple program to send the object program to the serial port for loading. Only your imagination and the capabilities of the host limit its use. ■

This system is currently running at Vanderbilt University and is proving to be an easy method for designing and testing software to run on the VU68K. Readers who desire more information on the VU68K and VUBUG can, for a nominal fee, order a copy of Vanderbilt University Computer Science Technical Report CS-83-01 from the following address:

POB 1679
Station B
Vanderbilt University
Nashville, TN 37235

The authors would like to thank the Computer Science and Electrical Engineering departments of Vanderbilt University for their support in VU68K system design and realization. Special thanks to Motorola Corporation for its assistance in the hardware design.

Edward M. Carter teaches computer science at the U.S. Air Force Academy. This work was completed while he was doing graduate work at Vanderbilt University in Nashville. He has a B.S. from the U.S. Air Force Academy, an M.S. from U.C.L.A., and a Ph.D. from Vanderbilt. He can be reached at USAFA/DFCS, USAFA CO 80840.

A. B. Bonds teaches electrical engineering at Vanderbilt. He holds a Ph.D. in electrical engineering and is currently studying models of information processing in mammalian visual systems. He also likes "to mess with antique autos." He can be reached at Vanderbilt University, POB 1824B, Nashville, TN 37235.

SEATTLE GIVES YOU AN EDGE IN S-100 SYSTEM DESIGNS

You can unlock new system capabilities with high-performance S-100 boards from Seattle Computer. All are IEEE-696 compatible. But, for innovative systems that demand performance beyond the limits of conventional S-100 boards, you'll want to know more about these Seattle Computer products. For example, with our 8 MHz 8086 CPU, you'll be able to build systems that run faster and consume less power than before. Take a closer look:

8086 CPU Set: 8 MHz 8086 CPU • CPU Support board includes a console serial port, a second serial port, Centronics parallel port, vectored interrupt controller, four 16-bit timers and EPROM monitor for 8086 • MS-DOS 2.0 plus development utilities • 8087 numeric coprocessor is optional
• **Single Qty: \$595.00**

64k Static RAM Fully static design makes interfacing easy • Compatible with a variety of CPU and DMA devices • High-speed (85 ns) RAMs operate to 10 MHz with no wait states • 16k, 32k, and 48k OEM versions are available
• **Single Qty: \$495.00 (64k)**

Disk Master™ Controls as many as four 8" and four 5.25" floppy disk drives simultaneously, in any combination • Uses 1793 disk controller chip • Can be used with 10 MHz CPUs • **Single Qty: \$325.00**

Multi-Port Serial Card 2- and 4-port versions are available • These RS-232 ports operate as either "data sets" or "data terminals" • 36" cables included
• **Single Qty: \$280.00 (4-port)**
\$210.00 (2-port)

For the whole story on high-performance Seattle Computer S-100 boards, call:

1-800-426-8936

Dealer and OEM inquiries are invited.

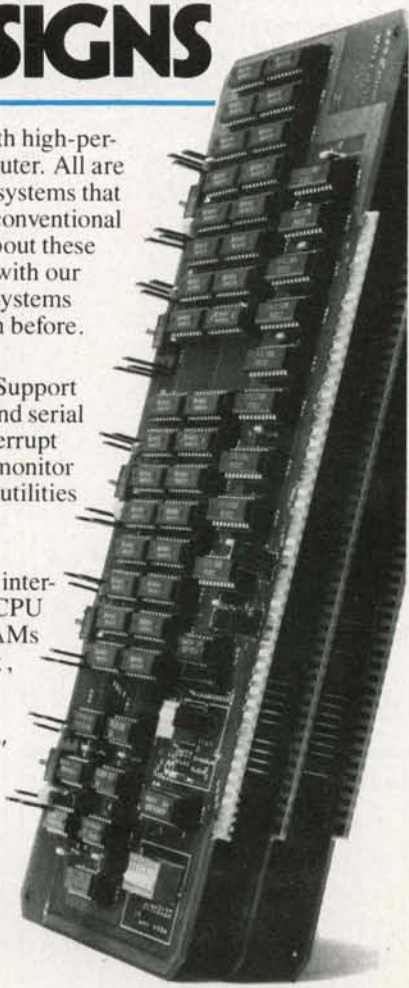

**SEATTLE
COMPUTER**

1114 Industry Drive
Seattle, WA 98188

Translating the SAS Language into BASIC

Use of a preprocessor program lets you run SAS-like syntax on microcomputers

by Jeff Bass

This article examines issues that arose when I implemented a preprocessor program to translate SAS-like program statements to statements in version 5 of Microsoft BASIC. It is easier to use a preprocessor program than to write a true SAS compiler for a microcomputer because the source and object languages of Microsoft BASIC's version 5 used with a preprocessor are more similar to each other than to those a compiler would utilize. An overview of SAS appears in the text box on page 433 and provides an introduction to the language.

Special SAS Features

Unlike SAS, traditional programming languages require the development of a data structure for each file as well as a data structure for all program variables and algorithms for manipulating these elements. SAS syntax, however, allows a programmer to take advantage of an invisible data file structure (the SAS data set) and a means of relating that structure to the program variables. In SAS programs that deal with a data set, all variables are referred to by an eight-character name, without regard to

such factors as column positions. SAS also provides a large library of programs that interact directly with this standard data structure. These features, which make SAS popular for use on mainframes, also make its syntax attractive for use on microcomputers; the size of its program library has thus far, however, prohibited the language's use on microcomputers.

The most commonly used language for microcomputers is BASIC. It's a primitive language compared to full SAS syntax, but small and easy enough to implement as an interpreter. Thus, it is almost universally used on microcomputers, where it's stored in ROM and therefore easily accessible. Kernighan and Plaugher in *Software Tools* (Reading, MA: Addison-Wesley, 1976) demonstrate how to deal with the problem of working with a less-than-optimum yet readily available language, such as BASIC, when you would prefer to work with another (SAS, for example). They show how to use a program called a preprocessor to translate RATFOR program statements, which they like to use, into a program composed of FORTRAN statements, which would be usable on their machine.

I have written a preprocessor program that similarly translates SAS-like program statements into equivalent BASIC statements and thus permits SAS-like programs to run on a microcomputer. The preprocessor approach, combined with the interpretive nature of BASIC, makes the resultant programs run slowly, but it has nevertheless proved practical for small programs and data sets. Researchers should find such a preprocessor useful with a relatively small data set—for instance, one with 200 to 300 observations of 30 variables. Such a preprocessor also could be used in teaching computer skills with microcomputers.

The remainder of this article examines the choice of a SAS-syntax subset, the strong and weak points of the BASIC dialect used, the method chosen for representing data, and preprocessor techniques employed. It concludes with a suggestion for an area to explore in the future.

SAS Syntax Features

The SAS syntax is very similar to that of PL/I in format and scope. Therefore, writing a preprocessor program that would implement the entire language on a microcomputer seemed impossible. I had to make

YOURS FREE!

The essential new catalog of the business computer forms and supplies you need most!

It's quick • convenient • easy-to-use.



Now Deluxe Computer Forms, a division of Deluxe Check Printers, gives you the software-compatible checks, invoices, statements and word processing stationery you've been searching for. And accessories too.

And we can ship them all to you in as few as 3 working days!

Deluxe delivers your order in record time because we know how much you depend on it to make your office run smoothly. And we deliver it to your precise specifications. That means customization for your unique program needs, or personalization of any of our 200 standard forms for popular software programs. And you order only what you need—as few as 500 forms.

See what we've got to offer your business. Then see just how fast we can deliver it.

Send for your **FREE** catalog today!



DELUXE

COMPUTER FORMS 530 N. WHEELER ST. P.O. BOX 43046 ST. PAUL, MINNESOTA 55164-0046
A DIVISION OF DELUXE CHECK PRINTERS, INC.

YES. Rush me your complete, new catalog of computer forms and essentials.

My Name _____ Title _____

Company Name _____

Address _____

City _____ State _____ Zip _____

Phone (____) _____

Clip out and mail or call TOLL FREE:

1-800-328-0304

(In Minnesota, call 1-612-483-7300.)

7287

some difficult choices: what was too important to leave out, and which processes were too long to keep? SAS processes, abbreviated as procs, operate as subroutines, although they are actually primitives of the language. A few candidates were eliminated: Proc Matrix, which requires that all matrices be held in memory, and Proc Sysreg, which requires that large sigma matrices be stored in memory. In addition, Proc BMDP (biomedical data processing) was eliminated because it wasn't available for use on microcomputers, and Proc Convert was not used because the types of data sets it converts would not be found on a microcomputer. Operating-system utilities that would not be useful on a microcomputer were also left out.

Even with these processes omitted, far too many remained for one person to code in a reasonable amount of time, so I decided to concentrate on the 10 I use most frequently: SORT, PRINT, CONTENTS, COPY, CORR, DELETE, MEANS, FREQ, GLM (general linear models procedure), and PLOT. Any two SAS users would probably argue about the wisdom of these choices, but these procs did provide a reasonable place to begin.

Each process would become a BASIC program, chained (executed in sequence) from the preceding BASIC program corresponding to a process or data step. Subsetting the data step proved difficult; however, one goal was sufficiently important to dominate the procedure: MAS (microcomputer analysis system) should be a true subset of the commonly accepted SAS syntax, thus making it unnecessary for users to learn another syntax. To be a true subset, it would have to maintain the original SAS syntax and spelling; deletion of features would be the only acceptable change.

This decision made it easy to drop features of the data step that would be the most difficult to implement on a microcomputer, such as those formats usable on mainframes. Because data sets used on a microcomputer are likely to have been typed in by the user (or to be sufficiently small to permit a user to type them), a pro-

fusion of formats for dealing with widely varied data is less useful on a microcomputer than it would be on a mainframe. Therefore, I decided to limit raw data input to list input and to eliminate formats from raw data as well. Also, because of their implementation and limited usefulness in small data sets, the ARRAY statement and its associated DO OVER statement were also left out. Most of the remaining data-step statements were implemented.

Special Features of BASIC Version 5

Using even a complex preprocessor to translate SAS syntax to an ordinary or standard dialect of BASIC was extremely difficult. I chose the most common version of BASIC used on microcomputers, Microsoft, which is used on many 8- and 16-bit machines. Versions of Microsoft BASIC are also the built-in language of Apple, IBM, and other popular

SAS's syntax resembles that of PL/I in scope and format.

microcomputers. In addition, BASIC is available for computers that run CP/M-86.

The current release from Microsoft, version 5, is more than an extended dialect of BASIC, however. It is nearly a complete operating system, performing many of the functions that JCL (job control language) provides for the mainframe SAS package, including creating, deleting, and renaming disk data sets and chaining programs. This release also allows common variables and files between such chained programs. In addition, Microsoft BASIC permits IF...THEN...ELSE constructs and such structured control statements as WHILE...WEND (equivalent to SAS 82's DO...WHILE...END statement). Moreover, it permits double-precision calculations, 40-character variable names, and character variables with as many as 255 characters. Version 5's most important feature, however, is its ability to write BASIC program text to a disk file and then execute that

HAPPY NEW YEAR, DARLING!



1984 is going to be his year, and he's ready. Each day holds opportunity: The right man in the right place, and always prepared. This is the year he'll do it all.

1984 is her chance to shift from "promising" to valuable. Her skills and attitudes are right. With a little savvy, this is the year she'll have it all.

Their secret is ARIS, the Action Resource Information System. The final element for success.

Now Ted's performance is really getting noticed. ARIS organizes his needs, manages his priorities, keeps track of his busy schedule. ARIS eases his work load by placing his calls, outlining his reports, and updating his client records-automatically. And, the built-in word processor has all the features he wants. Ted's getting more work done, faster, more effectively. With ARIS, Ted achieves the real management results he needs.

Susan threw out her old organizer. ARIS prints her action lists, confirms her meetings, even updates her pocket diary. She loves the simplicity of a single program managing her work and her computer. ARIS reveals the true value of total software integration. Now when Susan changes her database, the right information appears instantly in her client files, in her correspondence—everywhere she needs it. ARIS deals with the big issues and the little details, so Susan can focus on her goals.

The Action Resource Information System is their total professional support system. ARIS brings out their very best: excellence in everything.

Now, what's your New Year's resolution?

esc  EXCEL
SYSTEMS CORPORATION

655 Redwood Highway • Suite 311 • Mill Valley, CA 94941

Ask your Dealer to demonstrate the entire EXCEL SYSTEMS line for you.

Visa/MasterCard — NO CHARGE
NATIONAL ORDER DESK
1-800-231-0616
ORDER STATUS AND INFORMATION
1-713-692-7100
FREE SHIPPING!!

EAGLE SOFTWARE
 6121 Stuebner Airline
 Houston Texas 77091
 (713) 692-7100

MODEMS **DISK DRIVES** **APPLE PRODUCTS** **Videx**

<p>Hayes Micro Modem II w/Terminal Program . . . \$299 Smartmodem 300 Baud \$199 1200 Baud \$490</p> <p>Novation I-Cat \$115 Applcat II \$260 2/2 Auto Cat \$575 D-Cat Modem \$165</p> <p>Anchor Automation Mark I \$83</p>	<p>Micro-Sci A2 143K wo/Cont \$229 A2/40/70 Cont. Card . . . \$79 A40 164K wo/Cont \$285 A70 286K wo/Cont \$365</p> <p>Rana Elite I \$269 Elite II \$459 Elite III \$595 Elite Controller \$95</p> <p>Fourth Dimension Controller Card \$ 55 F-D Disk Drive \$225</p>	<p>Kraft Joystick \$47</p> <p>Microsoft 16K Ramcard \$69 Softcard (CP/M) \$235 280 Softcard Plus \$439</p> <p>Orange Micro Grappler+ \$119 Buffered Grappler+ . . . \$189 Bufferboard \$135 Orange Interface \$75</p> <p>TG Game Paddles \$28 Joystick \$43 Track Ball \$47 Select-a-Port \$43</p>	<p>Ultraterm \$265 Vidioterm \$225 Vidioterm/SS/INV \$245 Enhancer II \$99 Function Strip \$59 PSIO Card \$176 Appletwriter II Pre-boot . \$15 V-Calc 80 W/Mem. Exp. . . \$69</p>
--	--	--	--

IBM PRODUCTS

<p>CABLES</p> <p>IBM RS-232 M-F \$35 IBM Printer Cable (PAR) \$35</p>	<p>MONITORS</p> <p>USI *TAXAN *PRINCETON CALL!!!</p> <p>PRINTERS</p> <p>C. ITOH Prowriter 8510AP \$CALL Prowriter 1550P \$CALL Banana 500PS \$195</p> <p>Star Gemini 10X, 10" \$CALL 120CPS \$CALL Delta-10, 10" \$CALL 160CPS \$CALL</p>	<p>DISKETTES</p> <p>Elephant (5 1/4") SS/DD Soft Sec. (10) . . . \$18 SS/DD Soft Sec. (10) . . . \$22 DS/DD Soft Sec. (10) . . . \$28</p> <p>Maxel (5 1/4") SS/DD Soft Sec. (10) . . . \$27 DS/DD Soft Sec. (10) . . . \$39</p>	<p>VIDIO CARDS ORBITAL SYSTEMS (Lifetime Warranty)</p> <p>80/132 Column Card * For the Apple II, II+ KIT ASSEMBLED * 80 or 132 Column mode \$129 \$159 * Underline, Flash, Inverse and Soft Switch * Complete instruction manual</p> <p>11e 80 Column Card * For the Apple IIe KIT \$99 * 64K of memory ASSEMBLED \$129</p> <p>Copy Card * For the Apple II, II+ * Converts copy protected disks into standard COPY A format * Complete instruction manual KIT \$50 ASSEMBLED \$80</p>
--	--	---	--

TERMS:
 Free shipping, except monitors and printers. We will match any price providing it is not below our cost. All brands are registered trademarks. Products subject to availability.

We'll Match Any Advertised Price in this Magazine

file—exactly what is needed for SAS syntax processor.

But this version of BASIC presents problems as well as solutions. For example, it permits only as many as 15 files to be opened at one time. And because five files are required for such functions as keeping an event log and printing output, only 10 data sets remain accessible to processes and data steps. Moreover, because Microsoft BASIC is an interpreted language, each line of BASIC code is translated every time it is encountered during program execution. This can make programs run much more slowly than programs compiled into native machine code. And although Microsoft does offer a BASIC compiler that uses a language similar to the one its interpreter offers, it would be difficult to use in the preprocessor arrangement described here because it loses the ability to dynamically dimension arrays and loses some of the chaining capability provided by the interpreted BASIC.

Despite these drawbacks, however, BASIC provides features that make it a good choice for SAS syntax translation. First, it provides many functions that are identical or very similar to those used in SAS data-step programs; table 1 lists some examples. Second, like SAS, it computes the result of a logical comparison as a numeric quantity that can then be used in subsequent calculations. Consequently, an expression that categorizes variables, such as

$$\text{CAT_AGE} (\text{AGE} < 16) * 1 + (\text{AGE} \geq 16 \text{ AND } \text{AGE} < 65) * 2 + (\text{AGE} \leq 65) * 3$$

will work in a BASIC program just as it does in a SAS program, with the following exception. In BASIC programs, the result of a logical comparison is equal to -1 if true and 0 if false; in SAS programs, those results would be +1 if true and 0 if false. The preprocessor could include code to reverse the sign of all relational expressions. In the current version, however, I chose not to include it. BASIC also uses fairly understandable error messages, such as "file not found" or "attempt to divide by 0,"

HEROISM IN THE MODERN AGE

THE ROLE-PLAYING GAME OF TODAY

© Copyright 1983 Pacific Infotech Corp.



A sophisticated simulation of modern life and human psychology.

Includes: BASIC MODULE — create and guide characters through their lives...

PROJECT CONTACT (Scenario #1) — save the U.S.A. from a mad scientist and terrorist plot... you have only 60 hours to complete your mission...

HEROISM IN THE MODERN AGE is expandable to other modules and exciting scenarios.

At your computer store.

SYSTEM REQUIREMENTS:
 IBM PC* with one double-sided or two single-sided disk drives, an 80-column monitor, and 64K RAM (96K for DOS 2.0). Color graphics/adaptor optional.
 *IBM PC is a trademark of International Business Machines Corp.



10850 Wilshire Blvd.,
 Suite 800
 Los Angeles, CA 90024
 U.S.A.

Some of the best brains in the computer business are gathering in Reno to give you a piece of their minds.

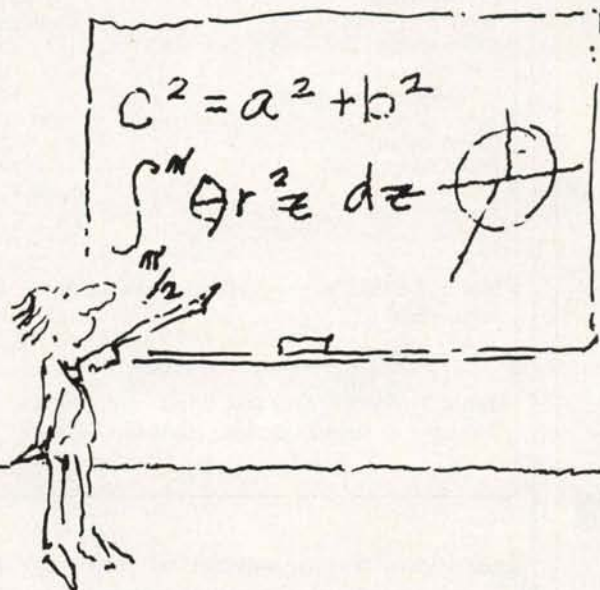

For 3 days in February, Sage Faire '84 gives you an opportunity to learn where high performance super-micro computer technology is going.

Some of the finest minds in the computer business will tell you what's happening, and more important, what is about to happen.

A series of meetings, discussions and exhibits will teach you what's going on in software development, microprocessor technology, new and improved operating systems, the supermicros, and sales and marketing.

Exhibitors will include: Digital Research, Ryan McFarland, Softech Micro Systems, State Of The Art, Timberline Systems and Whitesmiths.

It all takes place in the fun and excitement of the MGM Grand Hotel/Casino in Reno, Nevada.

Make plans to attend Sage Faire '84, February 3-5. It's your chance for a meeting of the minds with the best brains in the computer business. And a chance to win a Sage II Computer with software, valued at \$5790, just for attending the Faire.*

For more information and a registration packet including travel and lodging discounts, write:

Sage Faire '84
4905 Energy Way, Reno, Nevada 89502
or call Laura Smith at (702) 322-6868.

*Sage Faire exhibitors and speakers, employees of Sage Computer and their families are not eligible.



February 3-5, 1984

Please send information and a registration packet for Sage Faire '84.

NAME _____

TITLE _____

COMPANY _____

ADDRESS _____

CITY/STATE/ZIP _____

SAGE FAIRE '84
4905 Energy Way
Reno, Nevada 89502

**SAVE MORE
THAN EVER ON**



**3M Scotch®
DISKETTES**

**AND OTHER
COMPUTER NEEDS!**

3M Scotch® Diskettes

are boxed in **LIFETIME WARRANTY!** 10's with labels, envelopes and reinforced hubs on 5 1/4" diskettes.

\$195 ea. 5 1/4" SSDD (744)
Qty. 20

\$270 ea. 5 1/4" DSDD (745)
Qty. 20

5 1/4" SSQD-96TPI (746) **\$2.89** ea.
5 1/4" DSQD-96TPI (747) **\$3.95** ea.
8" SSDD (740) **\$2.07** ea.
8" SSDD (741) **\$2.54** ea.
8" DSDD (743) **\$3.30** ea.

SYNCOM Diskettes

are a great bargain. Packed in polybags of 10 with envelopes, labels and reinforced hubs. **LIFETIME WARRANTY!**



5 1/4" SSDD **\$1.39** ea.
5 1/4" DSDD **\$1.85** ea.

Disk Caddies

...the original flip-up disk holder for 10 diskettes. Beige or grey only.

5 1/4" **\$165** ea.
8" **\$229** ea.



FLIP 'N FILE

—Redesigned for better appearance and greater ease of use. FLIP 'N FILE 25 holds 25 5 1/4" diskettes; FLIP 'N FILE 50 holds 50 5 1/4" diskettes.

FLIP 'N FILE 25
Retail \$29.95
...DW Price
\$1750
+ \$4.00 Shpng.

FLIP 'N FILE 50
Retail \$39.95
...DW Price
\$2350
+ \$5.00 Shpng.

Minimum Order: \$35.00

Shipping: Diskettes Only: \$3.00 per 200 diskettes or fraction. **Other Items:** As shown in addition to diskette shipping charges. **Payment:** VISA, MASTERCARD, check or C.O.D. (C.O.D. customers please add \$1.65.) **Taxes:** Illinois customers add 7%.

WE WILL BEAT ANY NATIONALLY ADVERTISED PRICE!

Nationwide: 1-800-621-6827
Illinois: 1-312-944-2788

DISK WORLD!

Suite 4806 • 30 East Huron Street • Chicago, Illinois 60611

Authorized Distributor
Information Processing Products **3M**

SAS function becomes Microsoft BASIC function

SUBSTR(charvar,startpos,len)
INPUT(charvar,fmt)
PUT(charvar,fmt)
LENGTH(charvar)
ABS(numvar)
FLOOR(numvar)
INT(numvar)
SQRT(numvar)
SIN(numvar)
ATAN(numvar)
ARSIN(numvar)

COSH(numvar)

EXP(numvar)
LOG(numvar)
ROUND(numvar,places)

SIGN(numvar)
UNIFORM(numvar)

MID\$(charvar,startpos,len)
VAL(charvar)
STR\$(charvar)
LEN(charvar)
ABS(numvar)
INT(numvar)
FIX(numvar)
SQR(numvar)
SIN(numvar)
ATN(numvar)
FNARSIN(numvar)
with DEF FNARSIN(x)=ATN(x/SQR(1-x*x))
FNCOSH(numvar)
with DEF FNCOSH(x)=(EXP(x)+EXP(-x))/2
EXP(numvar)
LOG(numvar)
FNROUND(numvar,places)
with DEF FNROUND(x,y)=FIX(x/y+.5)*y
SGN(numvar)
RND
with RANDOMIZE(numvar)

Note: A BASIC statement following the word "with" is executed one time during program initialization.

Table 1: Because SAS and BASIC functions are similar, translating between the two languages is simple, as these examples illustrate.

and allows a programmer to trap errors, handle them, and resume program execution. Thus, a SAS syntax preprocessor can rely heavily on the error-trapping capability of the interpreter, greatly simplifying its design.

In addition, this version of BASIC allows the dynamic loading of machine-code programs and permits calling them as subroutines. Thus, many operations, such as sorting or inverting a matrix, which suffer from the interpreter's slowness, can be compiled into machine-code subroutines that are loaded and called as needed by the preprocessed SAS program—from an interpretive BASIC environment.

File Structure and Treatment of Missing Values

Before the processor was designed, two important system features had to be carefully specified: the file structure for system data sets residing on the microcomputer disk and the representation of missing values. Both

greatly affect the code to be generated by the preprocessor. A question of compatibility immediately arose—should the MAS file structure be designed to imitate the SAS data set structure? And should its missing value representation be the same? Careful study of these questions led to an answer of "no" to both.

SAS system files will never be transferable between mainframes and microcomputers using a BASIC preprocessor approach, because the two systems use drastically different methods for internal binary representation of numbers. Moreover, IBM mainframes use a coding scheme for text, EBCDIC (extended binary-coded-decimal interchange code), that differs from the one most commonly used on microcomputers, ASCII (American National Standard Code for Information Interchange).

After direct compatibility was ruled out, a clean slate remained for file design. The file design chosen was arbitrary, and virtually any one would work, provided it had been

MEMORIES

**512KB TO 2 MB EDC
SINGLE BOARD
MULTIBUS MEMORY**



- Pin to Pin MULTIBUS compatibility for both 8 bit and 16 bit systems.
- Addressable up to 16 megabytes.
- On board parity with selectable interrupt on parity ERROR.

OR

- Error Detecting and Correcting (EDC).

SINGLE QTY. PRICE:

	Without/EDC	W/EDC
512KB	\$ 895.00	\$1495.00
2MB	\$5995.00	\$6495.00

NEW!

NEW!

**2MB Q-BUS
EDC
512KB TO 2MB
QUAD Q-BUS
MEMORY**

**WITH ERROR
DETECTION AND
CORRECTION**

**UNBELIEVABLE LOW
PRICE!**

Call for details!

**256KB TO 1 MB
SINGLE BOARD
LSI 11 MEMORY**

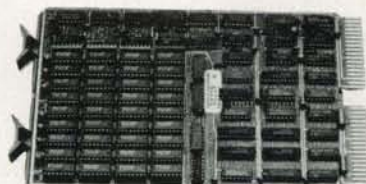

- Control Status Register (CSR)
- On board parity generator checker.
- Battery back-up mode.

**SINGLE QTY. PRICE:
256KB \$525.00**

DISK SYSTEMS COMPUTERS

2MB FLOPPY

Dual drive, double density, double sided 2MB floppy (8") with controller and bootstrap. Also reads single sided, single density!

CI-1220 TF \$2695.00

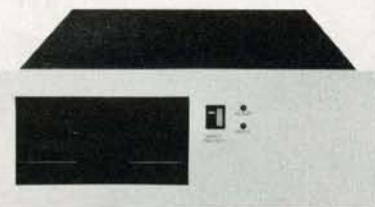

42MB, 70MB, 140MB formatted Winchester (8") disk system w/controller and 2MB floppy (8") backup w/controller.

CI-1240-WF: 42MB Winchester \$6995.00
CI-1270-WF: 70MB Winchester \$7495.00
CI-1340-WF: 140MB Winchester \$9995.00

10MB WINCHESTER OR 20MB WINCHESTER

RL02 compatible Winchester subsystems. 2MB floppy single dual controller and bootstrap is supplied with each purchase.

**CI-820:
10MB Winchester 2MB floppy (8")
\$4495.00**
20MB version add \$500.00

CI-11/23AC: LSI 11/23CPU, 256KB, 4 x 8 backplane, power supply and chassis (excluding rack slides) **\$2675.00**
CI-11/23AF: LSI 11/23 + CPU, 1MB, 4 x 8 backplane, power supply and chassis (excluding rack slides) **\$4125.00**

"OFFERING QUALITY WITH AFFORDABLE PRICING"



Chrislin Industries, Inc.

31352 Via Colinas • Westlake Village, CA 91362
Telephone: 213-991-2254 • TWX 910-494-1253 CHRISLIN WKVG

Multibus is a Trademark of Intel Corporation. QBUS, LSI, is a Trademark of Digital Equipment Corporation.

Real-Time C

for 8080, Z80

A Run-Time Library for Whitesmiths' C 2.1

- Fast execution
- ROMable
- No royalties
- Fully reentrant machine support
- CP/M file support
- Error checking
- Usable with our AMX Multitasking Executive

Real-Time C \$ 95
 manual only \$ 25
 source code \$950

Intel mnemonic \$ 50
 to A-Natural converter

Benchmarks

1. Int to ASCII conv.
2. Long to ASCII conv.
3. Long random number generator
4. Double 20 x 20 matrix multiply
5. File copy (16kb)



4 Mhz Z80, 8" SD diskette. Times may vary with processor, disks, etc.

AMX and Real-Time C are trademarks of KADAK Products Ltd.
 A-Natural is TM of Whitesmiths Ltd. CP/M is TM of Digital Research Corp.
 Z80 is TM of Zilog Corp.

KADAK Products Ltd.



206-1847 W. Broadway Avenue
 Vancouver, B.C., Canada V6J 1Y5
 Telephone: (604) 734-2796
 Telex: 04-55670

Protect and Organize

YOUR FLOPPY DISKS WITH MINI-EASEL BINDERS AND PAGES... and save 23%!

Scratched or damaged floppies can erase hours—even days—of carefully stored documents. Now there's no need to worry... you can protect all your disks in clear vinyl pages and organize them for fingertip access! This compact binder comes with 20 protective pages to hold 5¼" disks. Each page has an extra pocket with a file card for disk identification. The binder opens to become a self-standing easel to hold disks and 3-hole punched 5½"x8½" sheets at an easy-to-view angle. Closed, it stores compactly on a shelf or in a drawer.

SAVE 23%! Mini-easel binder with 20 pages and cards. Color: Black
 Stock #SFDRM... A \$20.25 value **\$15.50**

20TH CENTURY PLASTICS INC.

Supplying superior service and products to businesses for over 30 years.

CALL TOLL FREE 1-800-421-4662 Monday-Friday, 6:00 a.m.-5:00 p.m. P.S.T.
 California residents, call (213) 731-0900. (Credit card orders only.)



STATIC RESISTANT
 Specially formulated vinyl pages have tiny air pockets to insulate disks from damaging static.

YES! I want the convenience and safety of the Mini-Easel Floppy Disk Binder!

Please send me _____ (quantity) #SFDRM Mini-Floppy Disk Kit(s) at \$15.50 each. (Please include applicable tax and \$1.95 ea. postage and handling.) Total \$_____

Check enclosed
 Mail and make payable to:

20TH CENTURY PLASTICS INC.

3628 Crenshaw Blvd.
 P.O. Box 30022
 Los Angeles, CA 90030

CHARGE MY

VISA Visa

MasterCard MasterCard

Name _____

Address _____

City _____ State _____ Zip _____

Phone (____) _____

Card No.

Mastercard enter Bank No. (above your name)

Expiration date required Mo Yr

Signature X _____

Orders cannot be processed without a signature

FD2

consistently implemented in the data step and all proc steps, which call on a SAS procedure to perform a particular task on specified variables in a SAS data set. Because microcomputer files cannot easily span multiple disks, the disk was regarded as part of a microcomputer's, similar to the operating-system data set on a mainframe. One disk would correspond to one MAS database.

In the interest of simplicity, only one-part data-set names were implemented; responsibility for disk management was left to the user. Each named MAS data set generates two microcomputer disk files, which are also identified by their MAS data-set name. One file has the suffix .HDR (for header) and contains file-header information such as filenames and variable names, types, lengths, and labels. The other file has the suffix .DAT (for data) and holds the data-set data.

I performed timing tests to determine whether numeric data should be represented in binary or ASCII form. Although Microsoft BASIC permits both types, the ASCII form is much simpler to program. The tests showed that the binary form was worth the extra effort, however, because it permits files, especially those with noninteger numbers, to be read in half the time that the ASCII form does. The .DAT files therefore store numeric variables in internal binary form and character strings in ASCII representation. Block size is determined by the disk-sector size of the microcomputer used.

Missing values also presented complex choices. In the SAS package for use on mainframes, missing values behave in comparisons as though they had a value of negative infinity, and if they are used on the right-hand side of a numeric expression, they propagate to the left-hand side. Furthermore, if an illegal mathematical operation is performed, a missing value is also assigned to the left-hand side. In a microcomputer emulation, therefore, the method of representing missing values chosen should be easily recognized and also have these properties. I decided to use the 8-byte binary representation

The Micromint Collection

Micromint. Supporting the varied projects that appear in Steve Ciarcia's monthly article in *BYTE* magazine, "Ciarcia's Circuit Cellar." Offering a wide range of computers and peripherals supporting the needs of the hobbyist as well as worldwide corporate clients.

MPX-16 MICROCOMPUTER IBM PC COMPATIBLE



The MPX-16 is Steve Ciarcia's most ambitious project to date. The computer runs all application software written for the IBM PC and is IBM PC bus compatible. Can be used with video monitor & IBM keyboard with optional adapter.

Buy the MPX-16 in the form that best meets your budget. As a bare board, as a wave-soldered board that contains all components less the IC's, as an assembled and tested circuit board or as a complete system.

As featured on the cover of "BYTE" magazine. Also featured in "Ciarcia's Circuit Cellar" November, December 1982 & January 1983.

- Runs all application programs written for the IBM PC (simply boot up the system and slip in a disk formatted for the IBM PC).
- IBM PC bus compatible + 9 expansion slots.
- Intel 8088 16-bit microprocessor.
- Optional Intel 8087 math coprocessor.
- 256K bytes on-board memory.
- Up to one megabyte of system memory.
- Up to 64K bytes of system ROM/EPROM.
- Two RS-232C serial I/O ports.
- Three parallel I/O ports.
- Disk controller for 5 1/4" or 8" drives.
- Sixteen levels of vectored interrupts.

MPX-16 Microcomputer circuit board assembled w/64K RAM, CP/M-86 or PC-DOS BIOS	\$1,200.
MPX-16 as above with 256K RAM	1,395.
MPX-16 Semi-Kit (wave soldered circuit board w/all components) less IC's	595.
Complete kit of IC's w/256K RAM	595.
MPX-16 Unpopulated (bare) pc board	300.
CP/M-86 Operating System	80.
MPX-16 Switching Power Supply including cable harness for 2 disk drives	300.
MPX-16 Technical Reference Manual	50.
MPX-16 Metal Enclosure with cutouts for two 5 1/4" full height drives	300.
Tandon TM 100-2 double density drive	300.
IBM PC Keyboard Interface Adapter	100.
Serial terminal cable	35.
Parallel printer cable	35.

Shipping and handling additional on MPX-16 orders.

Z8 BASIC SYSTEM CONTROLLER

NEW!!!

Replaces Z8 Basic Computer Controller

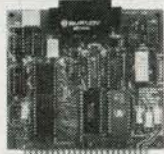

As featured in Ciarcia's Circuit Cellar, *BYTE* magazine, July & August 1981.

- Uses Zilog Z8671 single chip microcomputer.
- On board tiny BASIC interpreter.
- 2 parallel ports plus serial I/O port.
- Just connect a CRT terminal and write control programs in BASIC.
- 2K bytes of RAM, up to 4K bytes of ROM.
- Baud rates 110-9600 BPS.
- Data and address buses available for 124K memory and I/O expansion.
- Consumes only 1.5 watts at +5, +12 & -12.
- Cross Assemblers for various computers.

BCC11 Assembled & Tested \$149.
New Low Price

IBM PC is a trademark of International Business Machines, Inc.
CP/M86 is a trademark of Digital Research Inc.
MS-DOS is a trademark of Microsoft Inc.
Z8 is a trademark of Zilog Inc.

Circle 247 on inquiry card.

Z8 MEMORY, I/O EXPANSION, CASSETTE INTERFACE

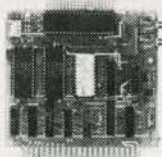

- Add up to 8K of memory plus 3 parallel ports.
- Cassette Interface—300 baud K.C. Standard.

BCC03 w/4K Assembled & Tested \$149.

Z8 ANALOG TO DIGITAL CONVERTER

NEW!!!

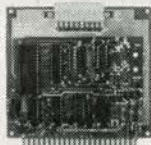

- Uses Analog Devices 7581 8 channel 8 bit IC.
- Adds Process Control capability to the Z8.
- 1000 samples per second.

BCC13 Assembled & Tested \$140.

Z8 EPROM PROGRAMMER

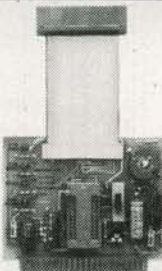

- Transfer BASIC or Assembly Language application programs from RAM to 2716 or 2732 EPROM.
- Requires Z8 Expansion Board for operation.

BCC07 Assembled & Tested \$145.

Z8 SERIAL EXPANSION BOARD

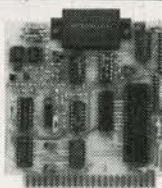

- Adds additional RS 232C and opto-isolated 20 ma current loop serial port to the Z8.
- Runs at 75 to 19,200 baud in all protocols.

BCC08 Assembled & Tested \$160.

Z8 16K MEMORY EXPANSION BOARD

NEW!!!

- Add 16K of additional memory, RAM or EPROM, to your Z8 System Controller in any multiple.
- Uses 2016, 6116, 2716 or 2732 memory types.

BCC14 w/8K Assembled & Tested \$120.

Z8 FIVE SLOT MOTHER BOARD



M802 Assembled & Tested \$69.

Z8 CROSS ASSEMBLERS

From Allen Ashley	
TRS-80 Model I or III	\$75.
CP/M 2.2 8" or Northstar 5 1/4"	150.
From Micro Resources	
CP/M 2.2 8" or APPLE 5 1/4"	75.

SPEECH SYNTHESIZERS

MICROVOX TEXT-TO-SPEECH SYNTHESIZER

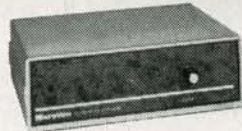

As featured in Ciarcia's Circuit Cellar *BYTE* Magazine September, October 1982.

Microvox is a second generation professional voice quality text-to-speech synthesizer that is easily interfaced to any computer, modem, RS-232C serial or parallel output device and provides speech of unbelievable clarity.

- Unlimited vocabulary.
- 64 programmable inflection levels.
- 6K text-to-speech algorithm.
- Full ASCII character set recognition and echo.
- RS232C and parallel output.
- 1000 character buffer, 3000 optional.
- Adjustable baud rates (75-9600).
- Spelling output mode.
- 7 octave music and sound effects.
- On board audio amplifier & power supply.
- X-On/X-Off handshaking.

MV01 Assembled with 1K buffer \$299.
MV02 Complete Kit with 1K buffer 219.
Add \$15.00 for 3K buffer option.

SWEET-TALKER VOICE SYNTHESIZER

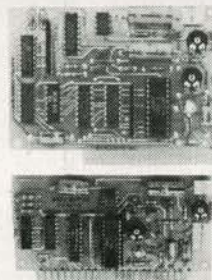

As featured in Ciarcia's Circuit Cellar *BYTE* Magazine, September 1981

The Sweet-Talker Voice Synthesizer allows you to add speech of unlimited vocabulary to your Apple II or any computer with a parallel printer port at very low cost.

- Utilizes Votrax SC-01A speech synthesizer.
- Unlimited vocabulary.
- Text-to-Speech Algorithm on disk for Apple II.
- Contains 64 phonemes accessed by 6-bit code.
- Four levels of programmable inflection.
- On board audio amplifier & volume control.

ST02 Apple II plug-in, Assembled & Tested with Text-to-Speech Algorithm on 3.3 disk \$99.
NEW LOW PRICE!!!
ST01 Parallel Port Version, Assembled 99.
New Low Price

VOTRAX SC-01A PHONETIC SPEECH SYNTHESIZER

The SC-01A Speech Synthesizer is a completely self-contained solid state device that phonetically synthesizes continuous speech of unlimited vocabulary. Used in Microvox and Sweet-Talker.

SC01A Quantity 1-99	\$44. ea.
100 +	32. ea.
1000 +	24. ea.

E-Z COLOR GRAPHICS INTERFACE

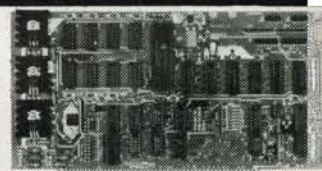

As featured in Ciarcia's Circuit Cellar *BYTE* Magazine, August 1982

Add color graphics, animation & 3-D effects to your S-100, TRS-80 Model I and III & Apple II at low cost! The Super Editor software package includes a palette editor, sprite editor, slide show, and demo scenes all in BASIC. Can be used with Color Monitor or TV set and rf modulator.

- Resolution—256 X 192 Pixels.
- 16 colors including Black & Transparent.
- 16K Bytes on board I/O mapped video memory.
- Advanced TI TMS9918A Color Video Processor.
- 32 SPRITES facilitates 3-D effect.
- Composite Video output.
- Krell & Terrapin have LOGO software packages to support the E-Z Color Boards.

Apple II E-Z Color plug-in board with Super Editor on 3.3 disk.

EZ01 Assembled & Tested	\$199.
EZ02 Complete Kit	199.
NEW!! S-100 E-Z Color Graphics board with sound generator, Atari type joy stick interface, plus MBasic, CP/M Super Editor Software on 8" disk.	
EZ04 Assembled & Tested	\$189.
TRS-80 Model I or Model III E-Z Color w/ Super Editor software, power supply and enclosure.	
Assembled & Tested	\$169.
Complete Kit	169.

300 BAUD ANSWER/ ORIGINAL MODEM KIT

NEW!!!

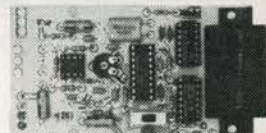

As featured in Ciarcia's Circuit Cellar *BYTE* Magazine, March 1983

The newest item to Micromint's growing list of products is this 300 Baud Modem. It is crystal controlled, uses the TI TMS 99532 IC, contains just 25 parts and can be used with an acoustic coupler or in a direct connect mode.

MD04 Complete Kit	\$89.
MD05 Transformer for Direct Connect Mode	89.
AC01 Acoustic Coupler Kit	89.

TRIPLE VOLTAGE POWER SUPPLIES

+5v @ 300 ma. +/- 12v @ 25 ma.	
UPS01 Assembled & Tested	\$89.
UPS02 Complete Kit	89.
+5v @ 1 Amp. + 12v @ .5 Amp. - 12v @ 50	
UPS03 Assembled & Tested	89.
UPS04 Complete Kit	89.

MICROMINT INC. 561 Willow Avenue, Cedarhurst, NY 11516

To Order: Call Toll Free 1-800-645-3477

For Information Call: 1-516-374-6733

Call: Monday-Friday, 9-5 PM



of negative infinity for the MAS missing value, with the least significant byte replaced by the ASCII representation of the "." character. This value is easily recognized and propagates as the SAS missing value does in comparisons. The preprocessor adds appropriate code in front of all assignment statements to check for missing values and propagate them as necessary.

Program Line-Parsing Techniques

The preprocessor program for han-

dling SAS syntax reads the file containing the user's SAS-like source code, translating it into BASIC source code on a line-by-line basis. The ASCII BASIC code is written to several files, with one program file for each SAS step. Each of these program files has a chain instruction as its last executable step, so that the next program is executed in turn. The chain is started by the preprocessor, whose last executable instruction is a chain instruction that executes the first BASIC program. Shared variables are

communicated with Microsoft BASIC's COMMON statement.

The proc steps were fairly easy to implement. For each proc, a core procedure that actually performs the work was written in BASIC, using ordinary statistical and computing algorithms. For each proc step encountered, the preprocessor writes code that stores variable names and other needed information in standard places, copies this code onto the BASIC source file, copies the core procedure onto the BASIC source file, and adds closing and chaining code to the end of the BASIC source file. The resulting BASIC program will then behave as if it were the appropriate SAS procedure with its supplied procedure information statements.

Implementing the data step, however, proved more difficult. Pseudocode is an arbitrary code, independent of system hardware, which must be translated into computer code. A SAS data step must have the ability to do the following: perform non-executable statements; initialize variables; open MAS files named in DATA statements for output; open files named in INFILE, SET, or MERGE statements for input; WHILE (observations, or obs, left on any input file and obs limit not exceeded); initialize user variables not in RETAIN to missing; perform executable statements; WEND; close files; chain to next BASIC program.

The preprocessor's job is to read the user's SAS-like code for the data step and generate a BASIC program in the pseudocode format. BASIC has another feature that eases the translation task: its program statements can be written in ASCII to a file in any order, but when loading or chaining the program, it places the statements in ascending order. As a result, the preprocessor need not save the code for forward references and write it out to the program file at the proper time. Instead, it can write code to the file as it must be generated. If, for example, the preprocessor is generating linear BASIC code at line 10000 inside a loop, and it needs to generate a subroutine outside the loop in the line-20000 range,

B-STAT

A POWERFUL NEW SET OF STATISTICS PROGRAMS FOR CP/M 80 - ALL FORMATS

Compare **B-STAT's** features:

- Data base up to 192 variables
- Computations in double precision
- Storage of data on disk
- Full editing and update
- Print-out raw data
- Data skipping flag feature
- Minimum 64K
- One or multiple drives
- Compatible with other data bases
- Unlimited number of cases
- Analyze up to 65 variables
- Data transformations
- Any subset of data selectable
- Raw or intermediate data entry
- Totally menu driven
- All MBASIC code (modifiable)
- Data coded 1,0 permitted
- Operational with hard disk.

B-STAT is a set of seven program modules sold separately or as a package:

Stepwise Multiple Regression - For up to 61 variables (straight regression up to 65 variables). Raw data, correlations, or variance-covariance entry. Each step output (addition or deletion) includes: regression coefficients, regression and residuals tables, multiple correlation coef., std. error, F-ratio, etc. Also means, standard deviations and intercorrelations. Printed listings of residuals for each observation. **\$120**

Factor Analysis - Principal components, VARIMAX and oblique simple structures, for up to 45 variables and factors. Also orthogonal-powered vector and weighted cross-factor simple structure methods. Raw data or correlation entry. Three estimates of communalities: units, absolute maximum row, and squared multiple correlations. Iterations. **\$95**

Discriminant Function - For up to 58 variables. Discriminant Function coefficients, F-ratio, cutoff point and z-score cutoff points. Discriminant function data base totally compatible with Stepwise Multiple Regression and Factor Analysis (and vice versa). **\$70**

Analysis of Variance - For up to 10 main effects and 10 levels, with equal cell frequencies. Cell means and standard deviations printed out. All two-way interactions evaluated. Output includes: degrees of freedom, mean square and F-ratio for all main and interaction effects. **\$85**

Analysis of Covariance - For up to 5 main effects with as many as 10 levels and 0 to 20 covariates. Complex least squares method. Appropriate for equal or unequal cell frequencies. All cell means and standard deviations printed. Tables include: source, degrees of freedom, mean square, F-ratio for main and interaction effects. All two-way interactions evaluated. **\$105**

Analysis of Variance (W + B) - Repeated measures design. Any combination of between and/or within subjects (cases) independent variables for a total of five factors. All interactions evaluated (up to five-way). Equal or unequal groups. Rerun feature permits output with modifications. From up to 1,000 to over 50,000 cases permitted (depending on the design). **\$115**

Matrix Manipulation - Outputs the addition, subtraction, multiplication, inversion, and transpose of matrices of up to 40 rows by 40 columns. All menu driven. Also provides for the solution of a system of equations of up to an order of 40. Outputs to screen and/or printer. **\$45**

ANY SIX PROGRAM MODULES \$245
ALL SEVEN PROGRAM MODULES \$295

For Technical Support
Robert A. Belanger, Ph.D.
(213) 969-4112

For Purchases and Literature
BELANGER
RESEARCH ASSOCIATES
541 W. 6TH ST.
AZUSA, CA 91702

CP/M is a trademark of Digital Research, Inc.
MBASIC is a product of Microsoft Corp.

NEVADA SOFTWARE

FOR CP/M. TOP QUALITY, BOTTOM PRICE.

Nevada makes it easy and economical to get the software you want and need. Need a better BASIC? We've got it. Is BASIC not solving your business or engineering problems? Nevada COBOL or FORTRAN will. The media praises Nevada, and it's priced right: just \$39.95—about 1/10 what comparable quality costs. For about half the price of one competitive package, you can own the *entire* Nevada Software library! So don't wait; order one or two or all of our bargains—today.

NEVADA BASIC™
Diskette & 220-page manual
For business, education
engineering, science

Finally, a better BASIC. This straightforward language lets beginners write useful programs without limiting them to simple programs. New Nevada BASIC's interpreter has Prof. Starkweather's great built-in full-screen text editor. You can define single- and multi-line functions. Plus there are full-matrix operations, Random Access and Sequential files, program execution with a simple command, BCD Math—no round-off errors. With Nevada BASIC, micros can run like minis costing thousands more.

NEVADA COBOL™
Diskette & 165-page manual
For business

Whether you do business computing or learn computing for business, COBOL is the language; more business application software is in COBOL than in all other languages combined. Based on ANSI-74 standards, Nevada COBOL offers many

advanced features: Random Access and Sequential files, debugging capability, COPY statement, character string, 16 bit binary and decimal data types. Colleges use the fine documentation as classroom texts. It's field-proven by 10,000+ worldwide business, government and education users. Join them.

COBOL Application Package—Book I.
Superior user documentation that saves even experienced programmers many hours.

NEVADA FORTRAN™
Diskette & 214-page manual
For science & engineering

"If you want to learn or teach someone FORTRAN, this is the package to buy." ACCESS, March/April 1983. For

learning and teaching, for scientists and engineers, Nevada is the perfect FORTRAN. Based on ANSI-66 standards (FORTRAN IV), its advanced features include IF...THEN...ELSE constructs, COPY statement, CHAINing with COMMON, TRACE style debugging, and 150 verbal error messages. And you can intermix in-line FORTRAN and Assembly Language statements for special micro needs. Requires 48K RAM. If you're shopping for FORTRAN, look no further.

NEVADA PILOT™
Diskette & 131-page manual
For dialogue

Perfect for training, testing, virtually all programmed instruction, and word puzzles. It's the ideal companion language for BASIC, COBOL, and FORTRAN application packages, because it so quickly solves training and documentation problems. Nevada PILOT meets all PILOT-73 standards and has many new features including a built-in full-screen text editor. Prof. Starkweather's

documentation is exceptional; the manual comes with 10 free programs. See *MICROCOMPUTING* review, January 1983, and you'll be convinced.

NEVADA EDIT™
Diskette & 59-page manual
For text editing

"A well-thought-out product with excellent documentation and an astoundingly low price." *MICROCOMPUTING*, May 1983.

Now, high-quality text editing for micros. A character-oriented full-screen display editor, Nevada EDIT is great for program editing as it's specifically designed to create COBOL, BASIC, and FORTRAN programs. Simple to configure, you customize tab stops, default file type, keyboard layout, and CRT by menu selection. Nevada EDIT may pay off better than any software purchase you've made.

EACH ONLY
\$39.95
COBOL Applications Package—Book I: \$9.95

Money back guarantee: you must be completely satisfied, or return the package(s)—in good condition with the sealed diskette(s) unopened—within 30 days, and we'll gladly refund your money.



CP/M is a registered trademark of Digital Research, Inc. TRS-80 is a registered trademark of Tandy Corp. Apple II is a trademark of Apple Computer, Inc. Osborne is a registered trademark of Osborne Computer Corp. Xerox 820 is a trademark of Xerox Corp. Kaypro is a trademark of Non-linear Sys. Heath/Zenith is a trademark of Heath Corp. IBM is a trademark of International Business Machines, Corp. Nevada BASIC, Nevada COBOL, Nevada FORTRAN, Nevada PILOT, Nevada EDIT, and Ellis Computing are trademarks of Ellis Computing, Inc. © 1983 Ellis Computing, Inc.



Send to
ELLIS COMPUTING, INC.
3917 Noriega Street
San Francisco, CA 94122 Phone 415/753-0186

Please send me: **Software Packages**
 BASIC COBOL FORTRAN PILOT EDIT

Disk Format

- 8" SSSD (Standard CP/M IBM 3740)
- 5 1/4" Diskette for:
 - Access
 - Apple CP/M
 - DEC VT 180
 - Epson QX-10
 - Heath Hard Sector (Z-89)
 - Heath Soft Sector (Z-90)
 - IBM-PC (Baby blue or big blue card)
 - Kaypro Double Density
 - Micropolis Mod II (Vector Graphic)
 - NEC PC 8001
 - Northstar Double Density
 - Northstar Single Density
 - Osborne (Single Density Disk)
 - Sanyo
 - Superbrain DD, DOS 3.X (512 byte sec)
 - Televideo
 - TRS-80 Model I (Relocated to 4200 hex)
 - Xerox 820 (Single Density)

Send my order for _____ packages @ \$39.95 each Total _____

COBOL Application package @ \$9.95 each Total _____

California residents add 6 1/2% Sales Tax. Sales Tax _____

Outside North America, add \$6 per package for shipping. Shipping _____

(Postage paid within North America.) Checks must be in U.S. dollars and drawn on a U.S. bank.

Check enclosed Mastercard VISA TOTAL _____

Card # _____ Exp. Date _____

Signature _____

Ship to: Name _____

Street _____

City/State/Zip _____

The CP/M operating system, an 8080, 8085, or Z-80 microprocessor, and 32K RAM are required. Note: Double Density drives can read Single Density diskettes.

DATA EXCHANGE/64K SPOOLER

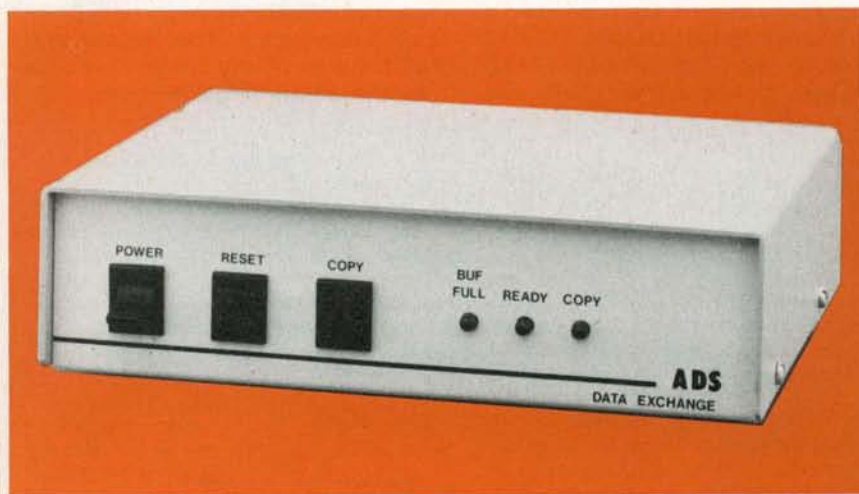

The ADS-8212 DATA EXCHANGE/64K is a computer independent interface converter and print spooler. It can be installed between virtually any computer and any peripheral.

Data can be input in either serial or parallel, stored in its 64K bytes of RAM, and output serial or parallel. Serial ports support baud rates from 50 to 19 200 and both hardware and software handshaking. The input and output ports are completely independent; input data with one protocol and baud rate and output it with a different protocol and baud rate. Selections are dip switch selectable.

A unique feature is its ability to make unlimited numbers of copies. Hitting the copy button will send another copy to the printer. When done making copies, hit the reset button to clear the memory.

Included with the DATA EXCHANGE/64K are two 4 foot output cables, one parallel cable with standard Centronics type connector and one serial cable with standard DB 25 connector. Standard plugs are supplied for input ports.

RS-232 HANDSHAKING:
RDY/BSY (DTR)
Xon/Xoff
ETX/ACK

Suggested list price: \$339.00

Dealer inquiries welcome.

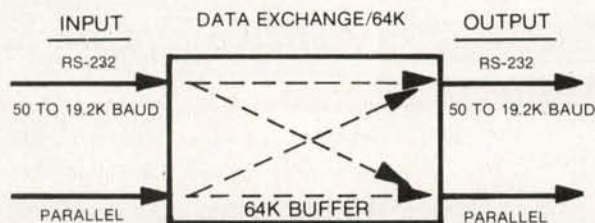

Available at your local dealer or contact:

ADS ANTEX DATA SYSTEMS
A Division of International Antex Inc.
2630 California Street
Mountain View, California 94040 ■ Phone: (415) 941-7914
Telex: 704 969 INTERAX UD

it can do so. The code written to the program file will be line-10000 code, followed by the line-20000 range subroutine, followed by the rest of the line-10000-range code. The BASIC interpreter can thus dynamically alter the line numbers, then put them into their proper order when the program file is loaded.

Let's look carefully at each line of the pseudocode outline:

1. *Perform most nonexecutable statements.* While most SAS code used in the DATA step is executable code performed once for each observation in the output data set, this is not true of all SAS statements. DROP, KEEP, and RENAME affect the code that controls what variables and variable names will be stored on the output file, but do not affect each observation. The LABEL statement, for example, generates code that writes labels for the variables to the .HDR file for the data set but has no effect on the observations. No matter where these statements appear in the SAS data step, they generate code that acts once per DATA step rather than once per observation.

2. *Initialize variables.* Many counting and control variables, such as `_N_`, `_ERROR_`, and input line counters must be initialized before the observations loop.

3. *Open MAS files named in DATA step for output.* For every data set named in the DATA statement, the .HDR and .DAT files must be created and opened; then the data set name, label, time, and date of creation can be written to the .HDR file.

4. *Open files named in INFILE, SET, or MERGE statements for input.* For "raw input" files named in INFILE statements (which specify the input used to create a SAS data set), a sequential open is performed. For MAS data sets named in SET or MERGE statements, the .HDR file is opened to gain information about the data set, then the .HDR file is closed and the .DAT file is opened to permit direct input.

ANNOUNCING THE INSIDE STORY ON DATA SPEC™ CABLES.

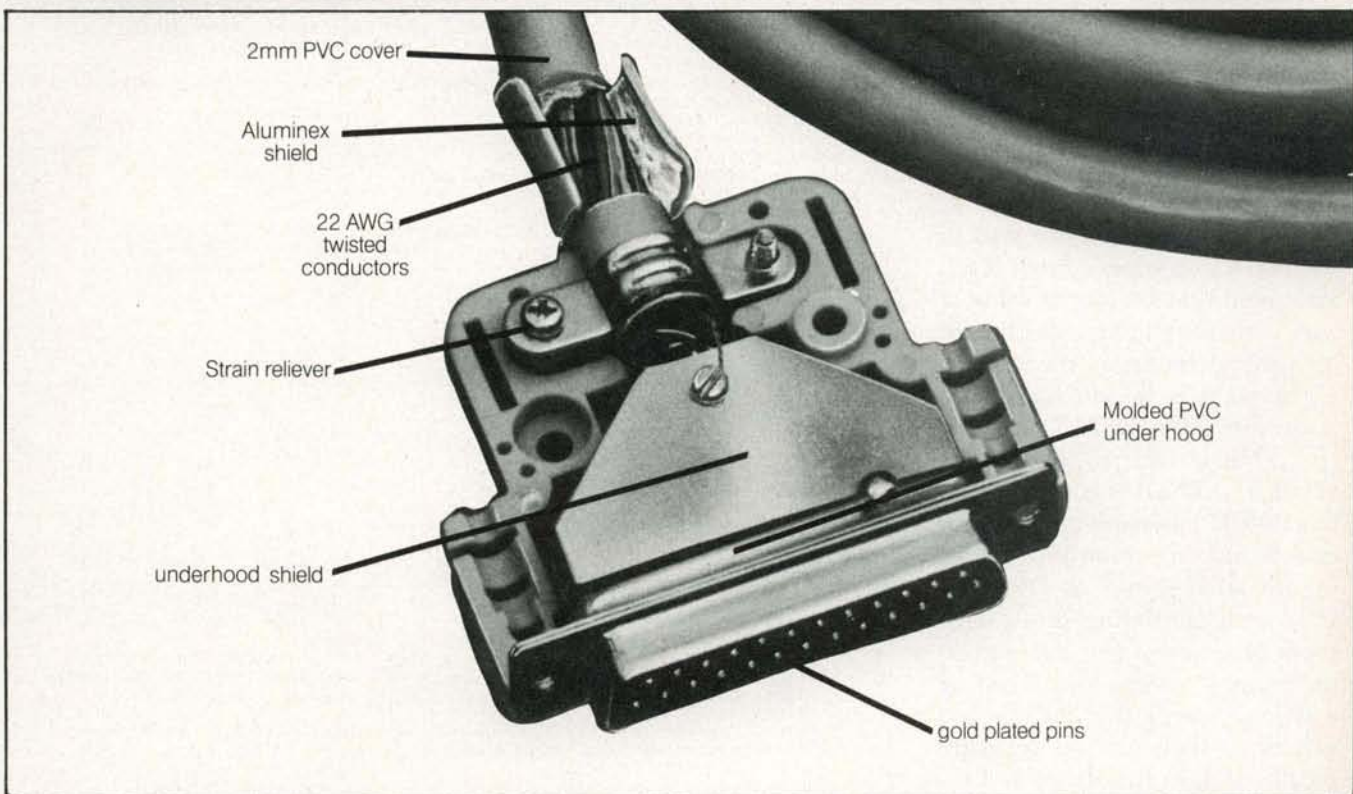

Take a look at the picture above. The shielding under the RS232 connector hood of DATA SPEC™ cables is different from anything you've seen before. No flimsy foil. Or painted hood. Instead, DATA SPEC™ gives you an extra heavy gauge shield under the normal hood which ensures that the cables exceeds the FCC requirements on emission standards.

And, if you look further inside, under the shield, you'll see the advent of PDT™* Technology. DATA SPEC™ cables are the first to employ this technique outside of aerospace applications. PDT Technology ensures that you will never have to solder a broken joint or even open the hood.

However, the biggest news is actually the littlest part of the story. The price.

You can find out about it at your dealer who carries DATA SPEC™ products. Modern manufacturing techniques have made DATA SPEC™ cables priced lower than lesser quality shielded cables.

DATA SPEC™ cables. There's more to it than meets the eye.

*PDT (Poly-vinyl doping technique) involves the injection of poly-vinyl under the shield to fuse the conductors and pins together, thus ensuring reliability under the most adverse conditions. PDT is a registered trademark of Advanced Tool Technology Inc.

DATA SPEC™

THE FAMILY OF HIGH INTEGRITY COMPUTER SUPPORT PRODUCTS.

18215 Parthenia Street, Northridge, 91326 CA (213) 701-5848

Circle 357 on inquiry card

AMERICAN EXPRESS CARDMEMBERS NO LONGER HAVE ANY EXCUSE FOR RUNNING OUT OF GAS.

NOW TEXACO WELCOMES THE CARD.

Now you can use the American Express® Card at thousands of participating Texaco retail facilities across the country.



Just pull in at the Texaco star and look for the sign welcoming the American Express Card. You'll see it at all participating stations.

Use the Card for motor fuel and all of Texaco's products and car services.

Now there's no excuse for running out of gasoline. You've got the Card. Don't leave home without it.®



© American Express Travel Related Services Company, Inc. 1983

Listing 1 continued:

5	50	1.3	.79	.49	.86
6	100	1.32	1.57	.93	1.57
7	500	1.4	7.76	4.5	7.31
8	1000	1.49	15.51	8.97	14.48

EXAMPLE SAS PROGRAM RUN TIMES IN MINUTES 01-10-1983 20:23
 TIMES ARE FOR COMPILE, DATA STEP, PROC PRINT AND PROC MEANS
 EXAMPLE WAS DATA STEP WITH CARDS, THEN PROC PRINT, PROC MEANS
 DATASET HAD 5 NUMERIC VARIABLES STORED IN DOUBLE PRECISION

LISTING OF COMPUTED 'PER OBSERVATION' TIMES

OBS	NOBS	AVGDATA	AVGPRINT	AVGMEANS
1	1	.03	.05	.15
2	5	.02	.016	.044
3	10	.017	.013	.028
4	20	.016	.0115	.021
5	50	.0158	.0098	.0172
6	100	.0157	.0093	.0157
7	500	.01552	.009	.01462
8	1000	.01551	.00897	.01448

EXAMPLE SAS PROGRAM RUN TIMES IN MINUTES 01-10-1983 20:23
 TIMES ARE FOR COMPILE, DATA STEP, PROC PRINT AND PROC MEANS
 EXAMPLE WAS DATA STEP WITH CARDS, THEN PROC PRINT, PROC MEANS
 DATASET HAD 5 NUMERIC VARIABLES STORED IN DOUBLE PRECISION

AVERAGES OF 'PER OBSERVATION' TIMES

VARIABLE	N	MEAN	STD. DEV.
AVGDATA	8	.01819	.005
AVGPRINT	8	.01595	.01397
AVGMEANS	8	.03813	.04629

One final issue affects the translation of SAS statements to BASIC statements. Microsoft BASIC, like

most BASICs, does not allow keywords to be used as variable names. Yet rather than restrict SAS variable

names in this fashion, I added an extra letter to the beginning of all user variables that would appear in the BASIC program. Since neither Y nor Z is the beginning letter of any BASIC keyword, I used Y as the beginning letter of all numeric variables and Z as the first letter of all character variables. Thus the SAS user variable ABC becomes YABC in the BASIC program. The user never sees these

The preprocessor reads pseudocode for the data step and generates a BASIC program.

names, however, since the BASIC program is never visible unless it is deliberately listed. This coding scheme also allows all the variables in the BASIC program beginning with Y to be set to double precision as well as all variables beginning with Z to be set to character-string type, using BASIC's DEFDBL and DEFSTR statements.

Give Personal BASIC™ a try. And win Hawaii!

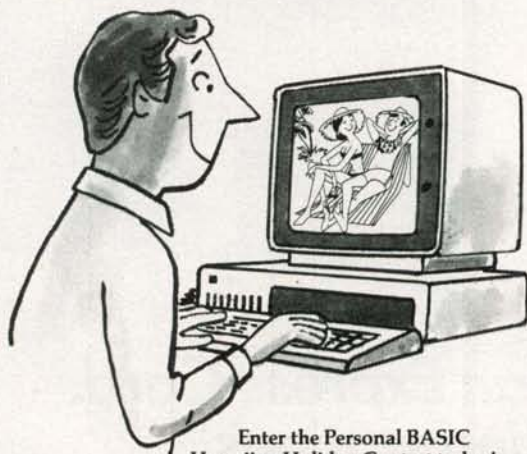

Enter the Personal BASIC Hawaiian Holiday Contest today!

Because you might become the winner of a trip to Hawaii for two — featuring airfare, hotel accommodations, a rental car and \$500 spending money.

Other prizes include a \$500 shopping spree and five \$100 shopping sprees — to be spent in those stores where the winners purchased Personal BASIC, the world's easiest-to-learn BASIC language.

Call toll free for the participating dealer nearest you: (800) 227-1617, ext. 420. In California call: (800) 772-3545, ext. 420. But hurry, contest ends January 31, 1984.

DIGITAL RESEARCH™

The Digital Research logo and products are either trademarks or registered trademarks of Digital Research Inc. ©1983 Digital Research Inc.

"COMPUTER CLASSIFIEDS"

The National Used Computer Bulletin Board

This semi-monthly classified ad publication has been designed for computer users — so they can communicate with each other in a timely and economical manner.

As a classified advertiser in Computer Classifieds, you can reach the national used equipment market in clubs, homes, offices and schools.

As a subscriber you'll know what's available to meet your needs.

GET RESULTS! SUBSCRIBE TODAY!

Subscription rates are only \$22 for 24 months (48 issues) or \$12 for 12 months (24 issues).

GET RESULTS! ADVERTISE TODAY!

Place your system in one ad, software in another ad and components in others.

Your first ad has a per issue minimum of \$5 (at 25 cents per word). Additional ads may then be placed (at 25 cents per word) with no minimum per ad. Each ad must appear in at least two issues, for a total minimum of \$10 per order.

Payment is due with your order.

Computer Classifieds
 P.O. Box 1547B
 Paramus, NJ 07652-1547
 (201) 967-9713

Now, X-shell™ brings Unix™ capability to your PC for an amazingly low \$225

Computers. You know at least two things about them: One, they should be a tool for solving your problems. Not creating them. Two, you want to spend as little time as possible on one.

X-shell Software Tools Package

That's why Standard DataCom, Inc. developed X-shell, a command interpreter software tools package for IBM PCs and MS-DOS/PC-DOS operating systems.

X-shell helps your computer solve your problems faster. Makes the time you spend on the computer more efficient. Squeezes more out of your computer investment.

Proven Unix Features

X-shell gives you Unix capability by providing these proven Unix features:

1. Support for pipelines and filters
2. Input & output redirection
3. Variable substitutions
4. Command substitutions
5. Filename expansion
6. Nested command files
7. Structured flow control:
if/then/else, while/do/done,
until/do/done, case/esac,
for/do/done

Unix is a trade mark of Bell Laboratories
X-shell is a trademark of Standard DataCom, Inc.

Hardware Requirements (where you can save hard cash)

- IBM PC or XT (or compatible)
- 256K bytes of RAM
- 2 Disk Drives—Hard or Floppy

Since X-shell can be run using floppy disk drives, you can save a bundle of money on your hardware. Hard disks are expensive. Floppies aren't. It's that simple.

Software Requirements

- PC-DOS version 1.1 or 2.0
- Software Disk Emulator

Since X-shell runs on PC-DOS, it supports existing PC-DOS software.

Over 40 Commands Utilities

X-shell's commands include:

basename —strip extension from file name	num —number lines
cat —concatenate files	pr —format files for printing
cd —change directory	print —pr directed to printer
clear —clear monitor screen	pwd —print working directory
cmp —compare files	rm —remove files (delete)
comm —output lines common to two files	sh —shell (command interpreter)
cp —copy files	size —size of object code
cpio —file backup/archival	sort —sort numerically or alphabetically
date —get or set date and time	sum —checksum file
echo —echo arguments to stdout	tail —output last lines of file
expand —expand tabs into spaces	tee —pipe fitting
expr —string and arithmetic evaluation	test —test file's or string's characteristics
false —do nothing, unsuccessfully	time —determine time to execute a command
find —produce list of selected files	tr —translate or delete characters
grep —search files for specified pattern	true —do nothing, successfully
hd —hex file dumper	unexpand —replace spaces with tabs
head —output 1st lines of file	uniq —remove duplicate lines
ls —sorted directory list	wc —count chars, words and lines
more —copy files to display	words —output file 1 word per line
mv —move files (rename)	

Dealer Inquiries Invited

What You Get For \$225

1. Complete Documentation, including: Installation, Tutorial and Reference Manuals.
2. Complete X-shell Software Tools Package on two diskettes.
3. A more efficient use of your computer time.
4. More effective use of your PC.

How To Order X-shell

Get the software package that gives you Unix capability for an amazingly low \$225.

Call Standard DataCom, Inc. 415-775-8882 with your Visa or MasterCard order, or for more information.

Or mail in the coupon below.

Or ask your dealer.

Standard DataCom, Inc.

Ask us about X.25

Enclosed is my check or money order for \$225.00*. Please send me X-shell™, the Software Tools Package that helps my PC solve my problems.
Send to:

Name	Title
Company	
Address	Phone
City	
State	Zip

PC brand, amount of memory
*California residents add sales tax

Mail check or money order to:
Standard DataCom, Inc.,
1550 California Street #6195,
San Francisco, CA 94109

What Is SAS?

SAS stands for Statistical-Analysis System, a mainframe data-processing and statistical language, and series of software packages. It was developed at North Carolina State University in the late 1960s with grants from the National Institutes of Health and the U.S. Department of Agriculture for the purpose of providing an alternative to existing computer languages for statistical applications.

In 1972 the first statistical-analysis system made available to the public contained a data-management language and permitted a user to perform about 25 statistical procedures. It required users to write a simple program in a PL/I-like syntax that can take raw data from cards or tape and convert it into a standard SAS data set with a fixed internal form. The statistical procedures it offered required data in the form of SAS data sets and produced printed reports (and optionally, new SAS data sets) of such operations as linear and nonlinear regressions. Because the system demands a standard form for all data (the SAS data set), it frees the user from specifying data structures. In addition, the statistical procedures contained in SAS provide most commonly needed algorithms, so a SAS user can concentrate on statistical analysis rather than on coding algorithms. Listing 2 is a SAS program written in current SAS syntax.

A Simple Yet Useful Language

The first group of statements make up a data step. The data step in listing 2 creates a SAS-style data set with four variables and as many observations as there are records on the tape. The variables can be picked off from any position on the record without the need for any COBOL-like fillers, and multiple records of any observation are easily handled. The next two groups of statements are PROC steps, which perform specified statistical procedures on the SAS data set that has been

Listing 2: Written in the syntax of the latest version of SAS, this program can read four variables from a survey tape, create a SAS data set, calculate the variables' means and standard deviations, and use them to perform a linear regression.

```
/* Example program with imaginary data set */
/* — demonstrates SAS syntax, not good statistics . . . */

/* SAS comments can be enclosed like this . . . */

DATA INCOME; /* Name of SAS data set to be created */
  INFILE TAPE1455; /* Data Definition Name of the Tape */
  INPUT @15 INCOME /* Income is at the 15th column of each record on */
                /* the tape */
        @22 AGE /* Age in years is at col 22 */
        @27 HEIGHT /* Height in inches is at column 27 */
        @94 WEIGHT /* Weight in pounds is at column 94 */

PROC MEANS DATA=INCOME MEAN STD /* Printed report will contain means */
/* and std devs for all the variables */

PROC SYSREG DATA=INCOME; /* A simple regression */
  MODEL INCOME=AGE HEIGHT WEIGHT /* of income on age, height and */
/* weight */
```

created. In this example, the data set is a temporary one, but it could just as easily be specified as a permanent data set.

The example in listing 2 would have required hundreds or even thousands of lines in such other languages as BASIC, FORTRAN, and Pascal. Thus, an advantage of SAS is that for many statistical and data-management tasks, it requires less programmer effort than do other languages. Yet SAS contains all the elements of a complete programming language (such as DO...WHILE...END and IF...THEN...ELSE statements and arrays) and can be used for complex nonstatistical programming tasks as well as statistical ones.

This useful language rapidly grew popular, first at universities and later in the business world. The maintenance of the package was transferred from the Institute of Statistics of North Carolina State University to a private firm, the SAS Institute, in July 1976. Expanded versions were released in 1976, 1979, and 1982, and

all of them retained the concept of a standard SAS data set and a powerful, problem-oriented language to manipulate the data in them. Graphics, time-series, and operations-research procedures were offered as optional add-on packages, but all of the packages required a large IBM 370 mainframe computer or equivalent machine until 1982, when a new portable SAS was announced for some of the 32-bit super-mini-computers, such as Digital Equipment Corporation's VAX computers. At the time of this writing, these products were still in testing stages; however, the SAS Institute maintained that it had no plans for moving SAS to microcomputers. At a SAS conference in 1982, a suggestion was made in a microcomputer users' special-interest group that it might be possible to emulate a SAS-like syntax on a microcomputer, and that suggestion led to this article. The author has no connections with SAS Institute Inc.

Conclusion

We've examined some of the steps involved in implementing a SAS syntax preprocessor for Microsoft BASIC. Some characteristics of BASIC made the task easier than writing a true SAS compiler for a microcomputer. The main drawback of this type of solution, however, is

the slow speed of the result. Compiling the resulting BASIC code instead of interpreting it should be possible, but since chaining and statement ordering are handled differently by the compiler and the interpreter, this solution has not been tried. It would be an excellent area for further work with this preprocessor. The exercise

did show that a substantial portion of the SAS syntax can be implemented on a microcomputer, however, and that for small data sets, this subset can be used effectively. ■

Jeff Bass is a senior analyst at Bass Cybernetic Labs (Rte. 1, Box 124B, Pittsboro, NC 27312).

The IBM Personal Computer Work Station. It's optional. (But essential.)

Now, we could hard-sell you on its features. Or we could soft-sell you on its virtues. Instead, we're going to level with you.

You don't have to buy it.

But we have a hunch that the more you know about the IBM Synergetix® PC Work Station the more you'll wonder how your business ever managed without it.

Necessity was surely the mother of this invention.

For as more and more businesses come to rely on the personal computer, new and extraordinary demands are being placed on the work environment itself.

The IBM PC Work Station was specifically developed to meet the challenges of today's technology. And scientifically designed to satisfy the various needs of the people who use it.

It's not just another pretty desk.

First and foremost, the IBM PC Work Station provides a convenient and compact work space that instantly opens up to expand your work area.

In addition, the IBM PC Work Station offers added mobility for your personal computer. So you get more mileage out of your investment as it moves from office to office, person to person, solving problem after problem.

And since your personal computers are as vulnerable as they are valuable, the IBM PC Work Station also functions as a security device.

It deters pilferage by providing a self-contained lockable storage compartment for your CPU, software, keyboard, printer, program books and diskettes.

It also protects valuable information, prohibiting unauthorized access to confidential computer data by keeping it all secure under lock and key.

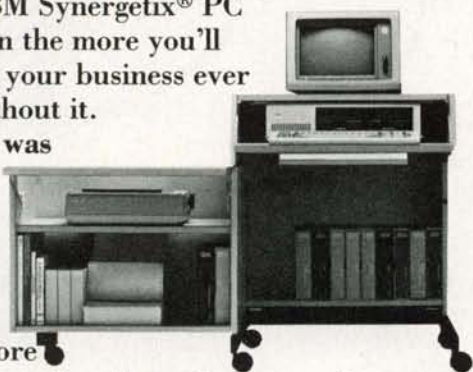

Last but not least, the IBM PC Work Station is human-factor engineered to meet IBM's strict ergonomic standards for operator comfort. For as you know, the more comfortable



people are, the more productive they can be.

There's one more important feature to our PC Work Station. It comes equipped with the added assurance of IBM quality. But then, that comes standard on all IBM products.

If all this hasn't convinced you that our PC

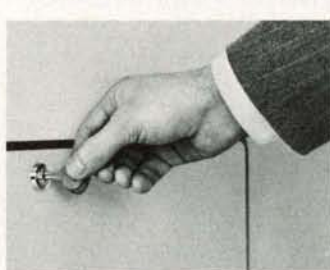

Work Station is as essential as it is exceptional, we're sure the price tag will. And IBM's quantity discounts make it absolutely irresistible.

The IBM Personal Computer Work Station—business people are finding it's one of those luxuries they just can't live without.

You can order from IBM Product Centers and ComputerLand® stores. Or call *IBM Direct* toll free at 1 800 IBM-2468 Ext. 40.

New model available for larger printers.



IBM PERSONAL COMPUTER WORK STATION 40

For more information, mail to:
IBM Corporation, Attn: *IBM Direct*,
One Culver Road, Dayton, New Jersey 08810

NAME _____ TITLE _____

COMPANY _____ TELEPHONE _____

ADDRESS _____

CITY _____ STATE _____ ZIP _____

People who know computers talk about why The Accounting Partner is a giant step forward.

Star's new sophisticated accounting package is helping the small businessman out of the Stone Age and into the Computer Age for an incredibly low \$395.

More and more, the people who know computers best are recommending The Accounting Partner™ over overpriced outmoded software.

Here's what just a few are saying:

EASE OF USE...Lynn Abbott, Epson America, Inc. — Torrance, California. *"The system is completely menu-driven with common accounting terminology instead of computer words. On a scale of 1 to 10, this user manual rates at least a '9.'"*

SOPHISTICATION...Vivian Bourne, Computerland — Greenville, Mississippi. *"We have a major accounting firm buying The Accounting Partner for their customers' private use. Farmers are buying it instead of the farm management packages available. And with the price, Star just knocks everyone out of the market."*

SUPERIOR PRODUCT...John Hanna, Software Centre International — Palo Alto and Sunnyvale, California. *"We recommend The Accounting Partner over other comparably priced packages. The client gets it all — General Ledger, Accounts Receivable, Invoicing, Accounts Payable, Purchase Orders, and Payroll — all for \$395."*

HIGHLY COMPATIBLE...Steve Cockrell, Computer Solutions — Raleigh, North Carolina. *"One good selling point is that The Accounting Partner can run on several different computers from a Kaypro, Epson, IBMPC..."*

PHENOMENAL SALES...Max Alvarez, Programs Unlimited — Miami, Florida. *"We are selling more Accounting Partners than any other accounting software."*

VALUE...Michael Edry, Next Generation Software — Torrance, California. *"What you get for your money is outrageous! It's a tried and true package and has been thoroughly tested — it works. It has substantially increased our accounting software business."*

INCREASED PRODUCTIVITY...Ken Capps, System Evaluation, Inc. — Thousand Oaks, California. *"At \$395, it's an unbelievable value! It has reduced our payroll computation from three days to 45 minutes. It's amazing!"*

The Accounting Partner is a new breed of software perfect for a growing business with annual sales up to \$5 million.* And for the revolutionary low price of \$395 for all six modules: General Ledger, Accounts Receivable, Invoicing, Accounts Payable, Purchase Orders and Payroll.

It is truly state-of-the-art software, compatible with any CP/M*, CP/M-86*, and MS-DOS™ or PC-DOS* computer (8-bit or 16-bit).** Call Star Software Systems at (213) 538-2511.

THE ACCOUNTING PARTNER...\$395.

General Ledger, Accounts Receivable, Invoicing, Accounts Payable, Purchase Orders, and Payroll
STAR SOFTWARE SYSTEMS™ 20600 Gramercy Place, Torrance, California 90501 • (213) 538-2511

*Handles totals up to \$999,999,999.99.

**CP/M* and CP/M-86* are registered trademarks of Digital Research, Inc. MS-DOS* is a trademark of Microsoft, Inc.

PC-DOS* is a registered trademark of IBM.

Requires a minimum 56K RAM; two disk drives or hard disk; a 24 x 80 video display with cursor addressing and a printer with 132 columns; 16 bit systems require 128K RAM.

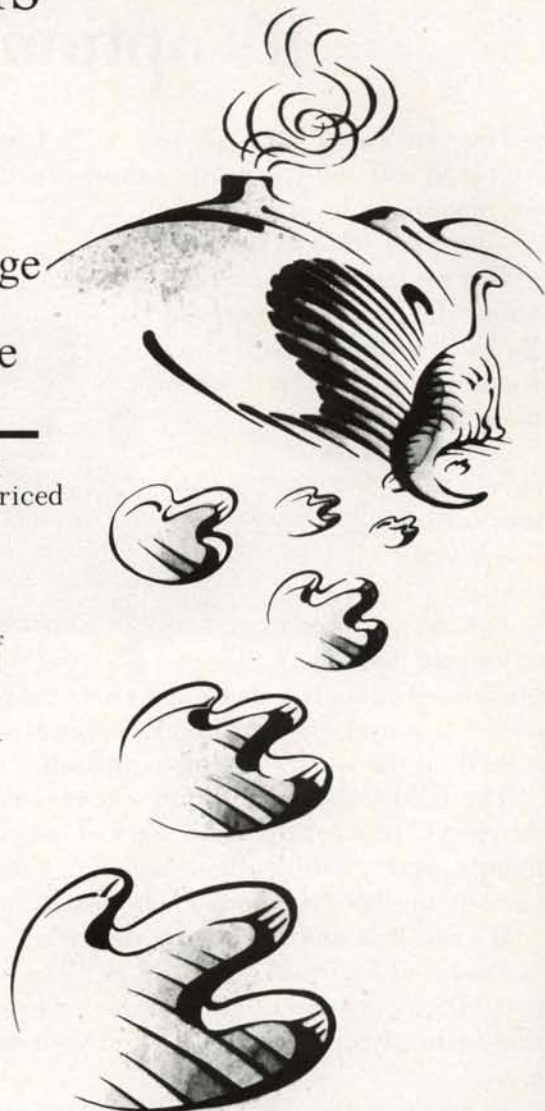

A Software Review Method That Really Works

The detailed group walk-through approach involves "playing computer"

by Andrew Citron

Programming errors create major time and money problems for the computer industry, not to mention the frustration felt by the end user. As a result, an effective method of eliminating errors is crucial to the software designer. One successful method you can use is the group walk-through. Reviewing software design and code this way ensures a low error rate and catches errors often missed in testing. Other benefits include improved documentation and software that is integrated more smoothly into the system.

The Method

The walk-through review is fundamentally a process of "playing computer." The participants emulate what the computer does with the input data by actually walking through, from start to finish, a maximum of 5000 lines of code. With careful definition of the participants' roles, standardized written preparation, and several shortcuts, the walk-through provides a workable means of correcting programming problems. In addition, a group review reduces the risk of individual errors by allowing for cross-checking between participants.

Design documents or code are reviewed, but in either case the method remains basically the same. The design document may be in the form of PDL (programming design language, or structured English), structure trees, Nasi-Schneiderman diagrams, flowcharts, or even HIPO (hierarchy plus input, process, output) diagrams. Reviewers must be concerned with both the details and

Group review reduces the risk of individual errors by allowing for cross-checking between participants.

clarity of the design. Code, on the other hand, is rarely ambiguous.

Test cases are run throughout the review; these form a series of inputs to the software and test the program's major requirements. All program statements should be tested at least once. Usually it is impossible to test all paths through the code because that number increases so quickly. By going through every statement at least once with all the main requirements included, the review partici-

pants test an adequate number of paths.

The Roles of the Participants

The review participants include the designer/coder and at least two other interested and motivated reviewers. Three seems to be the right number of people; four works, but the payoff does not increase proportionally.

Each participant has a specific role. The designer/coder remains passive while the other two reviewers are active. The designer/coder's role is to be alert for bugs and errors, answer questions, take notes on problems that need correcting, and provide the documentation and test cases for the walk-through. He does not "play computer." The designer is intensely involved with the program, and it is this involvement that increases the likelihood of repeating mistakes. Therefore, the other two reviewers are active. They remain impartial and follow the design exactly, rather than try to interpret what the designer meant. One reviewer acts as the central processor by reading the next instruction to be executed. The other writes down the variable's values for the others to see. The designer watches the two reviewers following

the design or code blindly and immediately recognizes when something is wrong.

The Process

The reviewer emulating the central processor reads the statements one at a time, marking each one as it is read. If reviewers use a different color magic marker for each test case, they get a feel for the number of paths that have been tested.

The reviewer tracking storage and registers notes modified variables in a visible place. A blackboard, an

overhead projector, or even paper glued to the walls enables all the reviewers to see the current values.

To walk through a test case, you follow the path the machine takes. When an IF statement is encountered, the storage and register tracker checks the variable being tested and chooses one path. Each case should be taken independently because a detailed understanding of the control flow is necessary to determine if the software functions properly. When the program calls a subroutine, you walk through it also, not bothering

with external routines.

In the design review, macro interface parameters are specified and checked. In the code review, you check the coded parameters against the design and walk through the expanded macro code. This catches interface errors when existing macros are called. It also catches coding errors in new macro code. It's important that you pay close attention to macro parameters and generated code because interface errors are a major source of program problems.

When a problem is found in either the design or code review, you shouldn't make any attempt to solve it unless it's trivial. The designer's role is to note the error and fix it later. If the problems are many or serious, you walk through the program again after fixing it. The addition of many new conditional statements indicates serious program problems. After a number of insertions, changes occur in paths already reviewed, and you must plan to review the program again.

Shortcuts

Once it has been asserted that a subroutine works, walking through it again and again is avoided. Making this assertion applies a technique used in formal program proving: given a precondition (the input) and a process (the program), the postcondition (the output) is true.

Three conditions must be met to make such an assertion. First, you should prepare a detailed input statement. You must state which variables are input and where they can be found. Second, a detailed output specification should be created spelling out any variables the reviewers modify and the conditions under which they've changed them, also stating any side effects such as modified registers or static control blocks. Third, you must completely walk through the routine once. When you prove a program path works, you don't need to walk through it again but must simply verify that the input conditions have been met to assume that the output conditions are true. When the input and output statements are complete and correct and

New Home and Professional Computer Books.



264
pages
\$12⁹⁵

How to Feel at Home with a Home Computer.

Finally—a book that answers the most asked questions about a Home Computer—what it is, what it does and what it can do for you. A "must read" for anyone who owns one or is thinking of buying.

You'll see that a Home Computer is useful, practical, educational, fascinating, and fun . . . For the whole family. This book tells you how. And why.

Two New Computer Books . . . available now at leading bookstores and computer retailers.

Or, if you choose to order direct, send check or money order, \$12.95 each book (plus state sales tax and \$1.25 handling), to: Texas Instruments, Dept. CB-22, P.O. Box 3640 M/S 54, Dallas, Texas 75265.

TEXAS INSTRUMENTS

Creating useful products
and services for you.

© 1983 TI Printed in U.S.A.

360116



256
pages
\$12⁹⁵

Personal/Professional Computers. How can they help you?

Here, in one clearly-written, fully-illustrated, easy-to-understand book is an in-depth look at computers and what they can do for you. It's a practical guide for using computers in your business. You'll learn enough about how computers work to effectively evaluate their utility. It's a book that managers in every business need—in every business big or small.



all the reviewers agree that the sub-routine functions correctly, the reviewer in charge of tracking variables updates the blackboard.

Another shortcut, stacking the machine state, helps you avoid walking through the same paths repeatedly. When you encounter an IF statement, write down the values of the variables and registers, note the point where the code diverges, and continue walking through the current test case. When you finish that case, you return to the machine state found at the IF statement, change the variable, and continue the walk-through.

With practice, you learn to design, code, and document programs so that review productivity improves. Input and output statements are then specified more fully, designed more simply, and use fewer variables.

Advantages of Walk-Throughs

The main advantage of walk-throughs is that reviewers find bugs earlier. And the sooner you find a problem, the cheaper it is to fix. The bugs found in reviews are often those that slip through testing: timing conditions, reentrancy problems, accidental storage modification. If you check only the testing output, you miss the side effects. Don't underestimate the value of finding and fixing these problems.

Another advantage is better documentation. Since the designer does not lead the walk-through, the two reviewers need comprehensive documentation. If documentation is incomplete, the reviewers know that something is unclear and needs fixing. You must spell out any design or code restrictions carefully. Documentation enhancements from reviews make the code more modifiable and maintainable.

Shortcomings of Walk-Throughs

While a walk-through doesn't produce a well-structured design, it guards against a bad one. If the review uncovers error after error, an experienced programmer throws the design out rather than repeatedly fixing and patching it. The major objection to walk-throughs, the time required, is not valid. Actually, a walk-

WHOLESALE RIBBONS

Save up to 50%

	3	6	12
Apple DMP	5.99 ea.	5.99 ea.	4.99 ea.
C. Itoh Prowriter (all models) ..	5.99 ea.	5.99 ea.	4.99 ea.
C. Itoh F10 40/55 Multi-Strike ..	5.99 ea.	4.99 ea.	3.99 ea.
Diablo Hytype II Multi-Strike ...	5.99 ea.	4.99 ea.	3.99 ea.
Epson MX-80	5.99 ea.	4.99 ea.	4.99 ea.
Epson MX-100	9.99 ea.	8.99 ea.	6.99 ea.
Gemini 10/10X/15/15X	5.99 ea.	2.99 ea.	2.99 ea.
IBM P. C. (MX-80)	5.99 ea.	4.99 ea.	4.99 ea.
IBM P. C. (MX-100)	9.99 ea.	8.99 ea.	6.99 ea.
NEC 3500 Multi-Strike	7.99 ea.	6.99 ea.	5.99 ea.
Okidata 80/82/83/92/93	2.99 ea.	2.99 ea.	2.99 ea.
Other Ribbons	—	—	CALL
Shipping + Handling for USA ..	3.00	Free	Free

Guaranteed! Min. order 3.

Call 1-(801) 298-0872

Rush Check or Money Order To:
C. R. E. Wholesale Products
 P. O. Box 361 N.S.L., Ut. 84054

Circle 487 on inquiry card.

QUALITY PRODUCTS FOR IBM PC RAMS

4164 64K 200 nsec DRAMS \$5.25 ea.
 4164 64K 150 nsec DRAMS SCALL
 CALL FOR QUANTITY PURCHASE!

DISK DRIVES

Stimline 320KB.....\$199
 Teac 55B.....\$229
 Shugart SA400L.....\$169
 Shugart SA455B.....\$239

COMPLETE SYSTEM

The NEW TAVA PC 128K, 2-320 floppy disk drives, controller, video card, and monitor, runs IBM DOS 1.1, 2.0, and CP/M 86.
 List Price...\$2395 OUR PRICE...\$1995

ROMAR II - Apple compatible computer, disk drive, Z card, controller and monitor
 OUR PRICE...ONLY \$999

CALL FOR IBM PC AND OTHER PRODUCTS
ANI — 17752 SKYPARK CIRCLE, STE. 210
 IRVINE, CA 92714
 714/261-6226 • 714/261-6227

Circle 488 on inquiry card.

SAVE END Only \$29.95 RS-232 TROUBLES



The COMPLETE RS-232 TESTER

- 25 PROBE PINS allow use of Oscilloscope, Voltmeter, or jumpers on ALL signals.
- 14 COLORED LEDs clearly show signal activity (positive and negative) of the 7 KEY RS-232 lines: transmit data, receive data, request to send, clear to send, data terminal ready, data set ready, carrier detect.
- 4 ADDITIONAL LEDs serve as "SPARES" to monitor ANY 2 other RS-232 signals, via jumpers (included).
- Determines GENDER directly, at a glance.
- Connects in series with ANY RS-232 interface for testing or permanent use: REQUIRES NO POWER.
- FREE "Guide To Testing RS-232 Interfaces" included.

ORDER NOW! Only \$29.95 + \$1.50 post. & handl.
Conley Graphics Corporation
 P.O. Box 60657, Palo Alto, CA 94306
 California Residents Add 6 1/2 % Sales Tax.

AFFORDABLE M-68000 COMPUTER SYSTEM

M68KCPU 6-10 MHz CPU, 20K static RAM, 16K EPROM, on board monitor, two RS-232 serial ports, 16-bit parallel port, 5 timer/counters expansion bus.
 Bare board.....\$ 99.95
 Complete Kit.....\$615.00

MDS12K 128-512K static RAM, floppy disk controller & hard disk interface
 Bare board.....\$ 99.95
 Complete Kit (128K)...\$725.00

M68KE Enclosure with power supply, fan, filter, 4 slot card cage
\$249.00

M68KASM M68000 Macro Cross Assembler for CP/M80, IBM PC, TRS-80 and Apple II computers
\$149.00

UPS shipping & handling \$ 4.00
 COD orders add \$ 3.00
 Foreign orders add \$20.00
 California residents add 6.5% tax

EMS Educational Microcomputer Systems (714)553-0133
 P.O. Box 16115 • Irvine, CA 92713

Circle 489 on inquiry card.

Contractor

Accounting & Management

JOB COSTING with Bonding Reports

Multi-state/multi-union variable-rate payroll with certified reports, subcontract management, accounts payable, equipment costing, accounts receivable, general ledger, estimating and critical path. Fully integrated, excellent audit trail, source code supplied. Mature installed 5 1/2 years nationwide. Multi-user available.

Written for CP/M 80, CP/M 86 and MS DOS
 1610 South Main • Dept. HB
 Bountiful, Utah 84010
 801-298-0052

A-SYSTEMS CORPORATION

Circle 490 on inquiry card.

1-2-3 Lotus . . . \$99.00*

VisaCalc . . . \$50.00*
 PFS: File . . . \$25.00*
 Wizardry . . . \$9.99*
 Zaxxon . . . \$8.00*

Over 1200 Programs To Choose From

SOFTRENT

*two week member rental

Free Catalog:
 619-481-0559 San Diego
 1-800-221-1031 California
 1-800-221-4568 All Others

Circle 491 on inquiry card.

FLOPPY DISK DRIVES SALES & SERVICE

SPECIALIZING IN FDD'S

H & M Disk Drive Services is a leader in the repair/refurbishment of 8-inch flexible disk drives. We service and repair 5¼ inch flexible disk drives from all manufacturers. Work is guaranteed!

- all 8 inch single-sided = \$45 plus parts
 - all 8 inch dual-sided = \$55 plus parts
 - all 5¼ inch single-sided = \$30 plus parts
 - all 5¼ inch dual-sided = \$40 plus parts
- (prices include bench and system tests plus alignments; all testing performed with state-of-the-art equipment)

NEW FDD'S FOR SALE

- 5¼ inch—Apple™ compatible ½-height. Enclosure & cable included. Controller not provided. High-performance, direct-drive motor MTBF in excess of 50K hrs. **\$229**
- 5¼ inch—Panasonic™ ½-height D/S D/D Direct Drive. Compatible with Shugart™ SA-455 **\$219**
- 5¼ inch—HiTech™ ½-height, 8" emulator. This 5¼" half-height drive replaces STD 8" drive. Software compatible. Will operate from existing hardware. Requires only +5v and +12v DC power. No AC. D/S D/D (1.6 M byte) **\$335**
- 8 inch Seimens FDD100-8 S/S D/D _____ **\$179**
Seimens FDD200-8 D/S D/D _____ **\$229**
- Other FDD's available. Call for prices & availability. All drives include 90-day warranty; extended, 2-year warranty at a nominal fee.

H&M
Disk Drive Services

Mail Order
Add \$7 Shipping
California residents
add 6% sales tax

689 L South State College Blvd.
Fullerton, CA 92631
(714) 526-1992

A WHIZ of a Switch

RS-232 Transfer Switch lets you switch your computer between printers, modems, terminals, any RS-232 peripherals. No plugging and unplugging cables. Like having extra ports. Choice of 8 models.



Exclusive features:

- LEDs monitors data lines
- Data lines spike/surge protected
- Switch reverses transmit-receive lines

These multi-function RS-232 transfer switches let you switch between peripherals, test for data and line failure, protect data lines and use as null modem for less cost than a switch alone.

Switches 10 lines (2, 3, 4, 5, 6, 8, 11, 15, 17, 20). LED data/line indicators monitor lines 2, 3, 4, 5, 6, 8, 20. Metal oxide varistors protect data lines 2, 3, 7 from voltage spikes and surges. Push button reverses transmit-receive lines. PC board eliminates wiring, crosstalk, line interference.

CHOOSE FROM 8 MODELS

- MFJ-1240, \$79.95, 1 input - 2 outputs.
- MFJ-1241, \$99.95, 2 inputs - 2 outputs.
- MFJ-1242, \$119.95, 2 inputs - 3 outputs.
- MFJ-1243, \$119.95, 1 input - 4 outputs.
- MFJ-1244, \$139.95, 3 inputs - 3 outputs.
- MFJ-1245, \$169.95, 3 inputs - 5 outputs.

- MFJ-1246, \$199.95, 5 inputs - 5 outputs.
 - MFJ-1247, \$99.95, 1 in-2 out (switches 20 lines)
- Order from MFJ and try it. If not delighted, return within 30 days for refund (less shipping).
One year conditional guarantee.
Order yours today. Call toll free 800-647-1800.
Charge VISA, MC or mail check, money order for amount indicated plus \$4.00 each shipping.

CALL TOLL FREE ... 800-647-1800

Call 601-323-5869 in Miss., outside continental USA, tech/repair info. Telex 53-4590 MFJ STKV.

Write or Call for FREE Catalog

**MFJ ENTERPRISES
INCORPORATED**

921 Louisville Rd., Starkville, MS 39759

through reduces time spent on future maintenance, testing, and integration.

Despite the completeness of walk-throughs, some errors still occur. The code must be tested; fortunately, it takes less time and effort to correct errors the second time around.

A Word on Attitude

Attitude makes the review work. New software has errors, and it's more constructive to find bugs in a review and in testing than later in production or in integration testing. Late error detection is time consuming and more difficult to correct. The proper ratio is to find many problems during the review, fewer in testing, and none when you integrate the code into the system. Error-free output from the walk-through is the reviewers' responsibility as much as the designer's.

Summary

Group walk-throughs of code and design ensure that software meets requirements, performs as intended, and has proper documentation. Well-defined reviewer roles, a proper structure, and a cooperative attitude produce an extremely effective group walk-through. ■

Acknowledgments

The author gratefully acknowledges the contributions made by his colleagues at IBM, especially J. C. O'Quin, J. R. McLean, and S. Eames, who helped with the content and the style of this article.

References

1. Schneiderman, B. *Software Psychology*. Winthrop, MA: Winthrop Publishers Inc., 1980.
2. Wegner, P. (editor). *Research Directions in Software Technology*. Cambridge, MA: MIT Press, 1979.
3. Weinberg, G. *The Psychology of Computer Programming*. New York: Van Nostrand Reinhold, 1971.
4. Yourdon, E. *Structured Walk-throughs*. Englewood Cliffs, NJ: Prentice-Hall Inc., 1979.

Andrew Citron (POB 12195, Research Triangle Park, NC 27709) has an M.S. in computer systems from SUNY at Binghamton and a B.A. in psychology from Northeastern University. He is currently with the SNA Architecture Group for the IBM 5520 Administrative System. For the previous five years he was in operating-system software development for the 5520. Any walk-through he has participated in has found lots of problems—whether he was the designer or a reviewer.

There are a lot of powerful reasons to write software for HP systems.



You're looking at two of them.

An enhanced UNIX™ operating system. And the cash bonuses you'll earn when you sell your UNIX-compatible applications with an HP system.

Those are compelling reasons to participate in HP's special program for software companies.

We have a whole range of products that can run UNIX, from our popular line of MC 68000-based machines to our powerful 32-bit systems. And we'll be expanding that range all the time.

While we're giving you a wider choice of products for your programs, we're also making it even easier for you to write them.

We've developed an especially powerful version of the industry standard UNIX, called HP-UX. Its enhancements provide for graphics, data base management and networking, to name just a few.

When you team up with HP, you have our full service organization behind you. Our factory and field support teams are dedicated to problem-

solving. So, if you or your customers have any questions about HP-UX, just give us a call. We're ready to help.

And we're ready to make your efforts very rewarding. When your customer buys an HP system because of your application, we'll give you a cash bonus of 30% of your software's sales price — up to 6% of the net HP system's price. Our only restriction is that, to qualify for the bonus, your software must sell for at least \$10,000.

There are lots of other good reasons to write HP-compatible software for UNIX or any of our other operating systems. To find out all about them, write to Hewlett-Packard, Attn: Gwen Miller, Dept. 57190, 19447 Pruneridge Avenue, Cupertino, CA 95014. In Europe, contact Henk van Lammeren, Hewlett-Packard Nederlands B.V., Dept. 57190, P.O. Box 529, 1180 AM Amstelveen, The Netherlands.



UNIX is a trademark of Bell Laboratories.

BD02315

Circle 486 on inquiry card.

BYTE January 1984

41

Real-Time Clocks and PC-DOS 2.0

Understanding the clock/device-driver interface

by David K. Broadwell

Almost every multifunction board sold for the IBM PC includes a clock, each sold with its own proprietary software. Recognizing that these real-time add-on clocks are extremely popular, IBM and Microsoft made specific provisions in the PC-DOS version 2.0 to legitimize the clocks' existence and handle their functions in a uniform way. The mechanism for this is a provision for device drivers—assembly-language (.COM) programs that can supplement or replace existing system software for doing the I/O (input/output) to a specific logical device. In this article I will provide a brief introduction to device drivers and discuss and demonstrate a character device-driver program for the clock chip on a typical multifunction board. In addition to being a nifty utility, the program demonstrates several features of 8088 code and the macroassembler.

By now, nearly all of us who bought PC-DOS 2.0 have thumbed through its accompanying volume at least once. Of all the additions inspired by Unix, perhaps the most important new feature is its powerful device-driver capability. Without using "dirty tricks" or mucking about in the system software, you can now integrate new devices into the oper-

ating environment quickly and in a manner compatible with current and, presumably, future versions of PC-DOS. Manufacturers of add-on boards, peripherals, and other hardware can now develop standardized software to interface their products to the IBM PC. System integrity is maintained no matter how many bells, whistles, and real-time gadgets are added.

PC-DOS 2.0 recognizes two types of devices: character and block. [Editor's Note: For a detailed discussion of device drivers and the IBM PC, refer to "Installable Device Drivers for PC-DOS 2.0" by Tim Field, November 1983 *BYTE*, page 188.] As the name implies, character devices do serial I/O on characters and include a system's PRN (printer), AUX (auxiliary), and CON (console) logical devices. The newly defined system device CLOCK\$ falls into this category. Block devices, on the other hand, include hard and floppy disks and do random I/O in chunks that usually correspond to a physical sector size for efficiency.

As an example of device-driver operations, assume you already have a device driver that simulates a floppy disk in RAM (random-access read/write memory). (You can use the device driver in the DOS 2.0 manual.) When PC-DOS 2.0 is booted up, it looks for a file named CONFIG.SYS, which contains information on how the system is to be initialized. Among other things, this file can contain a number of statements of the form DEVICE=file-name. If our RAM disk-driver example is called VDISK.COM, we put it into our CONFIG.SYS file for

DEVICE=VDISK.COM. This driver is loaded and left resident as a permanent and transparent part of the system. Any I/O calls to the virtual RAM disk are handled through regular channels, without altering the 8088's interrupt vector table that the DOS sets up. This is why a virtual-disk program that worked under DOS 1.1 bombs out under version 2.0.

The logical device we are replacing is the system CLOCK\$. A device driver named CLOCK.COM is installed instead of the system's default software, and it is loaded by a DEVICE=CLOCK.COM statement in CONFIG.SYS—at start-up time. Each time a call is made to read or set the date and/or time, CLOCK.COM does it. This includes the DOS commands for DATE, TIME, and pertinent DOS INT (hexadecimal) 21 file-management function calls. My clock-driver program reads and sets the National Semiconductor MM58167A Real Time Clock chip on an AST Research Inc. Combo board, but the general principles for any clock driver are represented as well as what PC-DOS 2.0 requires of a character device.

What PC-DOS 2.0 expects from a device-driver program and how they communicate are explained in the PC-DOS 2.0 manual. As previously mentioned, the RAM disk example is a handy block-device driver. Character devices, however, are quite different, and the CLOCK\$ device is also a rather special subset. Both devices use drivers structured the same way, but each is asked to do different functions by the DOS. The system creates a structure called a Request Header and passes its address

CLOCK.COM requirements:

IBM PC

64K bytes of RAM

one floppy-disk drive

PC-DOS 2.0

Any AST Research Inc. (2372 Morse Ave., Irvine, CA 92714, 714-540-1333) Multifunction board with National Semiconductor MM58167A Real-Time Clock chip.

Static Header

Byte (0)	length in bytes of Request Header (13) plus data block that follows (if any)
Byte (1)	subunit code for block devices (not used here)
Byte (2)	command code, e.g., "READ" = 08
Byte (3-4)	STATUS word (DONE, ERROR CODE, BUSY)
Byte (5-12)	reserved for DOS
Byte (13)	media descriptor (block device only—not used)

Variable

DWORD (14-17)	double-word address of system buffer for transferring data
Word	number of bytes/sectors transferred—always six for the clock, so not really used

Figure 1: A Request Header and block format for read/write to system CLOCKS.

pointer to the driver program in the extra segment (ES) register and general register (BX). All function requests, data transfers, and status checks occur through this mechanism. Following the 13-byte Request Header is an area whose length depends on what is appropriate for that particular operation. It might contain a data buffer address, initialization data, or specific device parameters the system needs to know. The format for a Request Header and the accompanying data block for our clock driver are shown in figure 1.

To continue, we'll first look at the requirements of an installable driver and then how it works within the operating system by referring to listing 1. The general format of IBM's example program is followed for easier comparison between block and character logic.

Device-Driver Structure

A device driver is a .COM file, but because it doesn't use a program-segment prefix when it's run, the code must start at 0. There is no ORG hexadecimal 100 statement as in other .COM files.

The special device header appears after all the MACROS, STRUCTURES, and EQUATES are defined. It is the logical beginning of the program and identifies the device's attributes (which are set here for character type and current clock device), its name, and pointers to crucial parts of the program. The first double word is set to -1 unless more than one

driver is in that particular .COM file.

Device Strategy (page 447) is an area of the program that saves a pointer passed to it in ES:BX. This is the address of the Request Header that PC-DOS 2.0 uses to pass data back and forth to the driver. A driver is called at this entry point to prioritize the system's request.

Device Interrupt Handler (page 448) is an area of the program called (with no parameters) directly after Device Strategy concludes. It retrieves the Request Header address, saves the registers, and services the system's request. (Interestingly, the IBM example failed to retrieve the Request Header's address. Apparently, ES:BX doesn't change at present, but CLOCK.COM follows the protocol anyway.) Both the Strategy and Interrupt addresses are stored in the device header.

A Command Code byte is passed in the Request Header, indicating the function desired of the device. The driver must decode and service this request. All drivers have an initialization call when the system is booted. As written, many other functions are possible, including nondata I/O control of the device (IOCTL). CLOCK does only simple input (read clock) and output (set clock). A call to do anything else results in the status word going back to the DOS coded as "unknown command."

It is the driver's responsibility to save the machine state, and there seems to be enough room on the DOS stack to do this as well as use PUSH and POP a few extra times.

Text continued on page 449



ANADIX	\$12.99
CITOH	\$5.99
DAISYWRITERS	\$14.99
DIABLO	\$11.99
DYNAX	\$5.99
EPSON	\$4.99
GEMINI	\$3.99
GE	\$19.99
IDS	\$7.99
NEC	\$19.99
QANTEX	\$14.99
QUME	\$19.99
SILVER REED	\$5.99
TALLY	\$3.99
TOSHIBA	\$21.99

PRICES
SO LOW—
WE CAN'T LIST THEM

ADDS	\$6.99
AMPEX	\$6.99
COMREX	\$14.99
ESPRIT	\$5.99
LEAR SIEGLER	\$5.99

All equipment is in factory cartons with manufacturers' warranty. Prices subject to change without notice. Most items in stock or shipped as received.

1 NATIONWIDE SERVICE MOST PRODUCTS
SUPER WAREHOUSE

P.O. BOX 373 WALLINGFORD, CONNECTICUT 06493
ORDER LINE ORDER HOUR
203-265-1223 9:00 AM - 5:00 PM
MONDAY-FRIDAY

PHONE ORDERS FREE
(ONE DOLLAR CREDIT FOR PHONE ORDERS)

CPM / 80 MACRO ASSEMBLERS

We've been selling these industrial-quality assemblers to the development system market since 1978. They are now available for the CP/M market.

FEATURES:

- Fully relocatable
- Separate code, data, stack, memory segments
- Linker included
- Generates appropriate HEX formatted object files
- Macro capability
- Conditional assembly
- Cross reference
- Supports manufacturer's mnemonics
- Expanded list of directives
- 1 year free update

Assemblers now available include:

Chip	Price	Chip	Price
1802/1805	\$495	NSC800	\$495
8051	495	F8,3870	495
6500/01/02	495	Z8	495
6800/01/02	495	Z80	395
6805	495	9900/9995	595
6809	495	Z8000	695
8085	495	68000	695

Take advantage of leading-edge technology. Get your own Relms assembler today. Use your MasterCard, Visa or American Express, and order by phone: (408) 729-3011

Relational Memory Systems, Inc.
1650-B Berryessa Road,
San Jose, CA 95133

All software shipped on a 8" single density floppy disk. A signed object Code License Agreement required prior to shipping. Prices subject to change without notice.



Listing 1: A replacement system clock/device driver based on the IBM PC macroassembler.

```

TITLE Replacement system clock driver for AST Board
COMMENT* This is an installable device driver to access the battery
        driven clock on AST combo board # 1/0 port 2C0 + 1F #
COMMENT* Author: David K. Broadwell -- July 1983 *
;
;
0000      CSEG      SEGMENT PARA PUBLIC 'CODE'
;
;          M A C R O S
;
STATUS   MACRO STATE,ERR,RC
        ifidn <STATE>,<DONE>
        OR ES:WORD PTR SRH_STA_FLDBX1,0100H
        endif
        ifidn <STATE>,<BUSY>
        OR ES:WORD PTR SRH_STA_FLDBX1,0200H
        endif
        ifidn <ERR>,<ERROR>
        OR ES:WORD PTR SRH_STA_FLDBX1,1000H
        endif
        ifnb <RC>
        OR ES:WORD PTR SRH_STA_FLDBX1,RC
        endif
        endm
;
;          E Q U A T E S
;
= 0000      SRH          EQU 0          ;STATIC REQUEST HEADER START
= 0000      SRH_LEN     EQU 13         ; * * * * * LENGTH
= 0001      SRH_UCD_FLD EQU SRH+1     ;SRH UNIT CODE FIELD
= 0002      SRH_CCD_FLD EQU SRH+2     ;SRH COMMAND CODE FIELD
= 0003      SRH_STA_FLD EQU SRH+3     ;SRH STATUS FIELD
= 0005      SRH_RES_FLD EQU SRH+5     ;SRH RESERVED AREA FIELD
;
; INPUT OR OUTPUT
= 000E      BUF         EQU 14         ;OFFSET INTO THE REQ BLOCK OF DATA(BUFFER) TRANSFER ADDRESS
= 0004      BUF_LEN    EQU 4          ;BUF LENGTH
;
; INIT
= 000E      BR_ADDR_0   EQU 14         ;CHARACTER DEVICE USUALLY ONLY SETS
= 0010      BR_ADDR_1   EQU BR_ADDR_0+2 ; ENDING ADDR AND RETURNS
= 0004      BR_ADDR_LEN EQU 4
;
; OFFSETS FROM CLOCK BASE PORT
= 0007      MON        EQU 7          ;OFFSET OF MONTH
= 0006      DAY1       EQU 6          ; * OF DAY OF MONTH
= 0008      VALID      EQU 8          ; * OF VALIDATION CODE IN RAM
= 0009      MON_CHK    EQU 9          ; * OF MONTH CHECKER IN RAM
= 000B      SWITCH     EQU 0BH       ; * OF LEAP BK RAM ON CHIP
= 0012      COUNTER_RESET EQU 12H    ; * OF RESET (RAM RESET IS ONE UP AT 12H)
= 0014      STATUS_BIT EQU 14H       ;OFFSET TO STATUS BYTE--80=UNRELIABLE READ,00=OK
;
; MISC
= 0160      DAYS_YR    EQU 365        ;DAYS PER USUAL YEAR
= 0002      YES_CODE   EQU 02        ;YES CODE FOR LEAP YEAR BOOKKEEPING
= 0001      NO_CODE    EQU 01        ;NO CODE FOR SAME
= 0010      VALID_CODE EQU 10H       ;VALIDATE CHIP CODE
= 003C      DAYS_FEB29 EQU 60        ;DAYS UP TO AND INCLUDING FEB 29TH(FOR LEAP YEARS ONLY)
;
; S T R U C T U R E S
= 02C0      CLOCK      EQU 2C0H       ;BASE PORT
;          ==SBI57A CLOCK-CALENDAR CHIP I/O ADDRESSES
;
CLOCK_PORTS STRUC
TEN THOUS DB ? ;1/10000s of seconds(who cares?)
HUNDRS DB ? ;hundreths
SECS DB ? ;seconds
MINS DB ? ;minutes
HRS DB ? ;hours
MEX_DAY DB ? ;day of week
DAY DB ? ;day of month
MO DB ? ;month
VERIFY DB ? ;chip RAM used to check chip config at initialization
MON_CHK DB ? ;RAM with month of last chip access
YR DB ? ;year-1980 (port 2C0+04)
LEAP_BK DB ? ;used for leap year bookkeeping (set to 02 when all is cool)
ENDS
;
;
0000      CLK      PROC FAR
;          ASSUME DS:CSEG,ES:CSEG,DS:CSEG
0000      BEGIN:
;          S P E C I A L   D E V I C E   H E A D E R
NEXT_DEV DB -1 ;POINTER TO NEXT DEVICE
ATTRIBUTE DW 800BH ;CLOCK DEVICE (NEW ETC.)
STRATEGY DW DEV_STRATEGY ;POINTER TO DEVICE STRATEGY
INTERRUPT DW DEV_INT ;POINTER TO INTERRUPT HANDLER
DEV_NAME DB 'CLOCK' ;DEVICE NAME
;          DB 0 DUP(?) ;FILLER
;
;
0012      RH_OFF     DW 7          ;REQUEST HEADER OFFSET
0014      RH_SEG     DW 7          ;R HDR SEGMENT
0016      USER_BUF   DD ?          ;USER TRANSFER ADDRESS(BUFFER)
;
;          F U N C T I O N   T A B L E
;
001A      FUNTAB LABEL BYTE
001A      0319 R DW INIT ;INITIALIZATION -USED FIRST TIME DEVICE IS CALLED
001C      028D P DW MEDIA_CHECK ;{BLOCK ONLY} -NOT USED
001E      028D R DW BUILD_SBP ; -NOT USED
0020      028D R DW IOCTL_IN ;IOCTL INPUT -NOT USED
0022      028D R DW INPUT ;INPUT(READ) = GET THE TIME/DATE
0024      028D R DW NO_INPUT ;NON-DESTRUCTIVE INPUT(CHAR ONLY) -NOT USED
0026      028D R DW IN_STAT ;CHAR ONLY -NOT USED
0028      028D R DW IN_FLUSH ;C.O -NOT USED
002A      02F1 R DW OUTPUT ;OUTPUT(WRITE) = SET TIME/DATE
002C      028D R DW OUT_VERIFY ;OUTPUT W/ VERIFY -NOT USED
    
```

Listing 1 continued on page 445

Listing 1 continued:

```

002E 0280 R      DW   OUT_STAT      +C.O.      -NOT USED
0030 0280 R      DW   OUT_FLUSH     +C.O.      -NOT USED
0032 0280 R      DW   IOCTL_OUT     +IOCTL_OUT -NOT USED
;
; LOCAL DATA BLOCK IN DOS 2.0 FORMAT
;
0034 0000 0000  CLK_TBL LABEL BYTE
0034 0000 0000  DW   ?           ;DAYS SINCE 1-1-80
0035 0000 0000  DB   ?           ;MINS
0037 0000 0000  DB   ?           ;HRS
0038 0000 0000  DB   ?           ;1/100THS SEC
0039 0000 0000  DB   ?           ;SECS
;
; MONTH TABLE
;
003A 0000 0000  MON_TBL LABEL BYTE
003A 0000 0000  DW   0           ;JAN
003C 0000 0000  DW   31          ;FEB
003E 0000 0000  DW   59          ;MAR
0040 0000 0000  DW   90          ;APR
0042 0000 0000  DW   120         ;MAY
0044 0000 0000  DW   181         ;JUNE
0046 0000 0000  DW   181         ;JULY
0048 0000 0000  DW   212         ;AUG
004A 0000 0000  DW   243         ;SEPT
004C 0000 0000  DW   273         ;OCT
004E 0000 0000  DW   304         ;NOV
0050 0000 0000  DW   334         ;334 DAYS UP TO DEC 1
0052 0000 0000  DW   365         ;DAYS UP TO JAN 1, NEXT YR
;
; TABLE OF CURRENT CLOCK VALUES
;
0054 0000 0000  UHR   CLOCK_PORTS (<) ;Allocates according to predefined STRUC
0055 0000 0000  ??
0056 0000 0000  ??
0057 0000 0000  ??
0058 0000 0000  ??
0059 0000 0000  ??
005A 0000 0000  ??
005B 0000 0000  ??
005C 0000 0000  ??
005D 0000 0000  ??
005E 0000 0000  ??
;
; VARIABLES FOR TRACKING THOSE PESKY LEAP YEARS
;
0060 0000 0000  LEAP_STAT DB   0           ;10H MEANS CURRENT YR IS A LEAP
0061 0000 0000  NUM_LEAPS DB   ?           ;NUMBER OF LEAP YEARS SINCE 1980
;
; LOCAL PROCEDURES
;
0062 0000 0000  IN_SAVE PROC NEAR
0062 26: 8B 47 0E  MOV   AX,ES:WORD PTR BUF[BX] ;SAVE CALLER'S BUFFER ADDR
0064 2E: A3 0016 R  MOV   CS:USER_BUF,AX
0066 26: 8B 47 10  MOV   AX,ES:WORD PTR BUF+2[BX]
0068 2E: A3 0018 R  MOV   CS:USER_BUF+2,AX
0072 C3           RET
;
0073 0000 0000  IN_SAVE ENDP
;
0073 0000 0000  READ_CLOCK PROC NEAR
0073 0E           PUSH  CS
0074 07           POP   ES
;SET UP TO READ CHIP AND STORE IT
0075 8D 3E 0054 R  RETRY: LEA  DI,UHR
0079 FC           CLD
007A 2B C0        SUB   AX,AX
007C B9 000C     MOV   CX,12
007E BA 02C0     MOV   DX,CLOCK
;ADDRESS OF CHIP BASE PORT
0082 EC         LOADIT: IN  AL,DX
0083 42         INC  DI
0084 51         PUSH CX
0085 EB 0132 R   CALL DEC_HEX
;CONVERT BCD TO HEX
0088 AA         STOSB
0089 59         POP  CX
008A E2 F6       LOOP LOADIT
;RESTORE COUNTER
;
; Check for counter rollover during read (STATUS BYTE=0BH)
;
008C BA 02D4     MOV   DI,CLOCK+STATUS_BIT
008F EC         IN   AL,DX
0090 B4 C0     TEST  AL,AL
0092 75 E1     JNZ  RETRY
;
; Routines to massage data for transfer to DOS
;
0094 EB 0110 R    CALL  NEW_YEAR
;CHECK TO SEE IF IT'S A NEW YEAR
0097 EB 00AF R    CALL  DAYS
;NUMBER OF DAYS SINCE 1/1/80
0099 EA 00ED R    CALL  TIME
;CURRENT TIME IN HEX
;
009D 2E: BE 06 0018 R  MOV   ES,CS:USER_BUF+2
;SET DESTINATION (ES:DI) TO POINT TO
00A2 2E: BB 3E 0016 R  MOV   DI,CS:USER_BUF
;CALLER'S BUFFER
00A7 0E           PUSH  CS
00A8 1F           POP   DS
;ESTABLISH SOURCE
;SI ALREADY HAS CLK_TBL ADDRESS
;6 BYTES
00A9 B9 0006     MOV   CX,6
00AC F3/ A4     REP  MOVSB
;SEND INFO TO BUFFER FOR "READ"
00AE C3           RET
;
00AF 0000 0000  READ_CLOCK ENDP
;
;
00AF 0000 0000  DAYS PROC NEAR
00AF 2B C0     SUB   AX,AX
00B1 A0 005E R  MOV   AL,UHR.YR
;YEAR-1980
00B4 BB 016D     MOV   BX,DAYS_YR
00B7 F7 E3     MUL  BX,DAYS
;MUL FOR DAYS
00B9 2B C9     SUB   CX,CX
00BB BA 0E 005B R  MOV   CL,UHR.MO
;LOAD MONTH IN CL AND ...
00BD EB 0104 R  CALL  DAYS_MONTH
;CALL ROUTINE TO ACCESS MONTH TABLE
00C2 03 07     ADD  AX,WORD PTR[BX]
;ADD THAT YEAR'S DAYS (EXCEPT CUR MO)
00C4 32 FF     XOR  BH,BH
00C6 BA 1E 005A R  MOV   BL,UHR.DAY
;GET DAY OF MON
00C8 03 C3     ADD  AX,BX
;DAYS SINCE 1-1-80, EXCEPT LEAP DAYS
00CC 50     PUSH AX
00CD A0 005E R  MOV   AL,UHR.YR
00D0 EB 0151 R  CALL  LEAP_CHK
;CHECK THOSE TOO
00D3 58     POP  AX

```

Listing 1 continued on page 446

FREE SHIPPING

MAIL ORDER ONLY

CALL FREE
1-800-841-2748

COMPUTERS

ALTOS 580-10 \$350
ALTOS 586-10 \$535
ATARI SCAL
APPLE LOOK-A-LIKE SCAL

TELEVIDEO

803 \$1779 1603 \$201
TETETOTE I \$121

NORTHSTAR

ADVANTAGE \$215

PRINTERS

B.M.C. BX80 \$29
BROTHER HRI \$69
DAISYWRITER 48K \$97
DATASOUTH \$115
GEMNI 10X \$27
JUKI \$49
OKIDATA SCAL
SMITHCORONA \$49

CITOH

8510 \$345 1550 \$59
F10-40C PS \$1090 F1055 \$147

DIABLO

620 \$875 630 \$169

NEC

3510 \$1364 7710 \$189
3550 \$1705 2010 \$785

TERMINALS

ADDS VIEWPOINT A1 \$48
ALTOS II \$78
TELEVIDEO 910 \$44
TELEVIDEO 925 \$69
TELEVIDEO 950 \$86
TELEVIDEO 970 \$95
VISUAL 50 GREEN \$59

MONITORS

AMDEK 300G \$130
AMDEK 300A \$145
AMDEK 310A \$209
AMDEK COLOR I \$270
B.M.C. GREEN \$89
B.M.C. COLOR \$230
NEC JB1201 \$159
TAXAN GREEN \$129

DISK DRIVES

TANDON 100-2D \$240
MICRO SCI A2 \$229
RANA 1000 \$375
RANA ELITE I \$249
ATARI 1050 \$365

MODEMS

HAYS SMART MODEM \$199
SMARTMODEM 1200 \$485
SMARTMODEM 1200 B \$429
MICROMODEM II E \$249

1st PLACE

COMPUTER SYSTEMS
13422 N. CAVECREEK RD.
PHOENIX, AZ. 85022

OTHER INFORMATION: 602-867-9897



Free shipping is on UPS ground only.
Send cashier's check or money order ... all other checks will
delay shipping two weeks.
Prices & availability subject to change without notice.



EMPLOYMENT OPPORTUNITIES

SOFTWARE PRODUCT MANAGER

Excellent growth opportunity. Possible equity. Full relocation program.

Resumes, in strict confidence, to: Director of Human Resources, Dept. Byte.

APS

1450 Broadway
NY, NY 10018

An Equal Opportunity Employer M/F

New EMPLOYMENT OPPORTUNITIES Section

BYTE will feature a special section for recruitment advertising in all future issues.

BYTE is the perfect place to look for those High Technology professionals you need — over 400,000 paid subscribers.

Or, if you're looking for a new position, this is the place to feature a **Position Wanted** ad.

The cost for any display ad in this new EMPLOYMENT OPPORTUNITIES section is only \$356 per inch. For quotes on all EMPLOYMENT OPPORTUNITIES ads, or any additional information on recruitment advertising, call our special recruitment telephone sales at 212/512-2556.

Or send in your order to:
BYTE Recruitment Advertising Center
P.O. Box 900
New York, NY 10020

Listing 1 continued:

```

0004 2B D2          SUB    DI,DX
0006 8A 16 0061 R  MOV    DL,NUM_LEAPS
000A 03 C2          ADD    AI,DX          ;ADD IN OLD LEAP DAYS
000C F6 06 0060 R 10 TEST   LEAP_STAT,10H  ;CURRENT YEAR A LEAP?
00E1 74 03          JZ     LEAP_STAT,10H ;JMP ON NO
00E3 EB 0173 R      CALL  LEAP_ADJ       ;YES -GO FIX THINGS
00E6 BD 36 0034 R  DI:   LEA    ST,CLK_TBL ;SAVE RESULT
00EA 89 04          MOV    WORD PTR [SI],AX
00EC C3            RET
00ED             ENDP

;
; GET HRS,MIN,SEC,1/100THS SEC
;
TIME PROC NEAR
;
00ED 8D 3E 0036 R  LEA    DI,CLK_TBL(2) ;SET UP TO LOAD DATA LOCALLY IN RIGHT ORDER
00F1 32 E4          IOR    AH,AH
00F3 A0 0057 R      MOV    AL,UHR.MINS
00F6 AA          STOSB
00F7 A0 005B R      MOV    AL,UHR.HRS
00FA AA          STOSB
00FB A0 0055 R      MOV    AL,UHR.HUNDOS
00FE AA          STOSB
00FF A0 0056 R      MOV    AL,UHR.SECONDS
0102 AA          STOSB
0107 C3            RET
0108             ENDP

;
; MONTH ARRIVES HERE IN CL
; ADJUST TO GET THE CORRECT
; OFFSET INTO THE TABLE
; GET ADDR OF MONTH TABLE
; NOW WORD PTR[SI] HAS NUM OF DAYS UP TO CURRENT MO
DAYS_MONTH PROC NEAR
;
0104 80 E9 01      SUB    CL,1
0107 D0 C1          ROL    CL,1
0109 BD 1E 003A R  LEA    BX,MON_TBL
010D 03 D9          ADD    BX,CX
010F C3            RET
0110             ENDP

;
; CHECK FOR A "NEW YEAR" AND/OR UPDATE MON_CHK
; CURRENT MONTH
; STORED ON CHIP- THE LAST "MONTH" WE READ IT
; 1:12 SO IT'S A NEW YEAR
; IT'S A NEW MONTH
; SAME OLD MONTH - GO BACK
; LAST YEAR - 1980, +1
NEW_YEAR PROC NEAR
;
0110 A0 005B R      MOV    AL,UHR.MO
0111 5A 06 005D R  CMP    AL,UHR.MON_CHK
0117 7C 03          JL     UPDATE
0119 7F 0F          JG     UPDATE
011B C3            RET
011C FE 06 005E R  NEW:  INC    UHR.YR
0120 A0 005E R      MOV    AL,UHR.YR
0123 EB 0142 R      CALL  HEX_DEC
0126 BA 02CA       MOV    DI,CLOCK+10 ;MAKE IT BCD LIKE EVERYTHING ELSE
0129 EE          OUT    DI,AL          ;RAM ADDR FOR YR
012A A0 005B R      UPDATE: MOV AL,UHR.MO
012D BA 02C9       MOV    DI,CLOCK+9
0130 EE          OUT    DI,AL
0131 C3            RET
0132             ENDP

;
; CONVERTS SMALL PACKED BCD TO HEX
DEC_HEX PROC NEAR
;
0132 50          PUSH  AX
0133 81 04       MOV    AL,4
0135 D2 EB      SHR    AL,CL
0137 5B          POP    BX
0138 B7 0A       MOV    BH,10
013A F6 E7       MUL   BH
013C 80 E3 0F  AND   BL,0FH
013F 02 C3       ADD   AL,BL
0141 C3         RET
0142             ENDP

;
; CONVERTS HEX NUMBERS UP TO 63H(=99) TO BCD
; HEX NUMBER PASSED IN AL
HEX_DEC PROC NEAR
;
0142 2A E4       SUB    AH,AH
0144 83 0A       MOV    BL,10
0146 F6 F3       DIV   BL
0148 81 04       MOV    CL,04
014A D2 E0       SHR   AL,CL
014C 86 C4       ICHG AL,AH
014E 0A C4       OR    AL,AH
0150 C3         RET
0151             ENDP

;
; SETS NUMBER OF LEAP YEARS PAST & STATUS BYTE
; IS IT 1980?
; YES - FORGET THE REST
; PUT YEAR-1980 IN AL BEFORE CALL
LEAP_CHK PROC NEAR
;
0151 3C 00       CMP    AL,0
0153 74 1D      JE     L1
0155 32 E4     IOR    AH,AH
0157 FE C8     DEC   AL
0159 83 04     MOV   BL,4
015B F6 F3     DIV   BL
015D 80 FC 03  CMP   AH,3
0160 75 0B     JNE   NOT_LEAP
0162 80 0E 0060 R 10 OR    LEAP_STAT,10H ;SET LEAP STATUS BIT ON(CURR YR IS A LEAP)
0167 EB 06 90     JMP   L1
016A             NOT_LEAP:
016A C6 06 0060 R 00 MOV   LEAP_STAT,0
016F A2 0061 R     LI:   MOV   NUM_LEAPS,AL ;NUMBER OF LEAP DAYS SINCE 1980
0172 C3         RET
0173             LEAP_CHK ENDP

;
; ADJUSTS CHIP AND/OR DAYS COUNT DURING LEAPS
; HAVE WE ALREADY DONE THE BOOKKEEPING?
; JUMP ON YES
; IS IT BEFORE/AT FEB29? ---(CHIP THINKS IT'S 3/1)
LEAP_ADJ PROC NEAR
;
0173 80 3E 005F R 02 CMP   UHR.LEAP_BK,YES_CODE
0178 74 AB      JE     DONE1
017A 8A 3E 005B R  MOV   BH,UHR.MO
017E BA 1E 005A R  MOV   BL,UHR.DAY
0182 B1 F8 0301  CMP   BX,0301H
0186 7E 3B      JLE   DONE2
;BACK UP A DAY AND RECORD IT IN RAM:
;
0189 80 3E 005A R 01 CMP   UHR.DAY,1
018D 74 16      JE     FDOEY
018F 50          PUSH  AX
0190 32 E4     IOR   AH,AH
0192 A0 005A R  MOV   AL,UHR.DAY
0195 FE C8     DEC   AL
0197 BA 02C6     MOV   DI,CLOCK+DAYV
019A EE          OUT   DI,AL
019B 80 02     MOV   AL,YES_CODE
019D BA 02C8     MOV   DI,CLOCK+SWITCH
01A0 EE          OUT   DI,AL ;SET LEAP_BK ON RAM SO WE WON'T HAVE TO DO THIS AGAIN
01A1 5B          POP   AX
01A2 EB 1F 90     JMP   DONE2
;
; BACK UP DAY AND MONTH BOTH
FDOEY: SUB   CX,CX

```

Listing 1 continued on page 447

Build Your Own IBM-PC Compatible!

Here are the boards, assembly instructions and parts you need... plus full back-up service from Netronics!

Complete instructions show you how to build an IBM-PC compatible that can run ANY—not just "popular"—IBM-PC programs!

Motherboard functionally duplicates IBM-PC... features IBM-PC compatible BIOS ROM plus five empty sockets for ROMs of your choice. Sockets will accept IBM-PC PROMs or other PROMs.

Instructions include step-by-step procedure for transferring ROMs from a pc onto a floppy disk, which can then be mailed away for ROM duplication.

Board kits include printed circuit board, some hard-to-get parts, and detailed assembly instructions.

Complete kits include printed circuit boards, all parts, and detailed assembly instructions.

Manuals only, \$5.00 per kit.

IBM-PC Compatible 16-bit Motherboard with IBM compatible BIOS ROM—□ Board kit, \$89.95/□ Complete kit, add \$140.00

IBM-PC Compatible Keyboard in cabinet (wired & tested), \$229.95

64k/256k Memory with serial port with DB-25 connector □ Board kit (64k), \$39.95/□ Complete kit (64k), add \$134.00/□ Each additional 64k block (to 256k), add \$75.00

Four Drive Disk Controller with hard disk SASI interface, parallel printer port, clock/calendar—□ Board kit, \$69.95/□ Parts for Four Drive Disk Controller, add \$130.00/□ Parts for Parallel Printer Port, add \$30.00/□ Clock/Calendar, add \$45.00/□ SASI Interface, add \$50.00/□ All 4 functions wired and tested, \$329.95.

IBM-PC Compatible Color Board (or B&W)—□ Board kit with ROM, \$89.95/□ Wired and tested, \$299.95.

Printer/Spooler Board with 64k buffer, clock calendar, parallel printer ports—□ Board kit with ROM, \$49.95

Modem Board, 300 BPS, direct connect/originate/auto-dial/auto answer plus 2 serial ports—□ Board kit with telephone company connectors, \$49.95

Power Supply □ Complete kit, \$179.95/□ Extra power for hard disk option, add \$20.00

□ Cabinet for PC, steel with brushed aluminum front panel and simulated oak cover, \$199.95

□ 5 1/4" Disk Drive, DSD/D (wired & tested), \$269.95

□ 10 Megabyte Hard Disk with controller & software (wired & tested), \$1295.50

Netronics offers complete service department to customers.

TERMINALS

(Terminals require ASCII keyboard and power supply.)

□ Power Transformer for either terminal, \$9.95

SmartVid Deluxe Terminal, 80 characters by 24 lines, microprocessor controlled with editing, reverse video and more—□ Board kit (includes board, character generator, video controller, 2k system ROM), \$99.95/□ Complete kit, add \$100.00

FastVid Deluxe Terminal, 64 or 32 characters x 16 lines, baud rate to 19 kilobaud—□ Board kit (includes controller, character generator, and PROM), \$49.95/□ Complete kit, add \$50.00

SPEECH

Electric Mouth Apple/S-100 Speech Board, with National NSC Digitalker speech chip—□ Apple/□ S-100 (Please check your choice.) □ Board kit (with Digitalker and 150 word vocabulary set), \$69.95/□ Complete kit, add \$30.00/□ 2nd Word Set (150 words), add \$39.95

SpeakEasy Universal Talking Board, operates with computers and terminals or in the stand-alone mode. Uses same power supply as terminals (see above). □ Board kit (includes VORTRAX speech chip and system ROM), \$89.95/□ Complete kit, add \$60.00/□ Cabinet, add \$15.00

S-100 DYNAMIC RAM BOARD

16k/64k RAM Board uses popular 4116 chips—□ Board kit (includes 8202 controller), \$69.95/□ Complete kit (16k), add \$79.95/□ Each additional 16k, add \$50.00

ELF II BEGINNER'S PAK

ELF II is a complete 256 byte, fully expandable learning computer with excellent documentation that explains hardware and software fundamentals. Learn to program in machine language! Learn the essence of how all computers operate and "think"! If you can afford to think about an IBM-PC or IBM-PC compatible, you can't afford not to have an ELF II beginner's pak! □ Complete kit, \$139.95

USE YOUR CREDIT CARD! CALL TOLL FREE 1-800-243-7428 (In Connecticut call 203-354-9375)

To order by mail, check boxes above for products you desire. Mail entire ad with remittance to:

Netronics R & D, Ltd.

333 Litchfield Road, New Milford, CT 06776

Total enclosed \$ _____ (Conn. res. add tax) □ Visa

□ MasterCard Acct. # _____

Exp Date _____ Signature _____

Print Name _____

Address _____

City _____

State _____ Zip _____

Listing 1 continued:

```

028F 2E: 8C 06 0014 R      MOV     CS:RH_SEG,ES      ;SAVE SEGMENT OF REQUEST HEADER PTR
0294 2E: 89 1E 0012 R      MOV     CS:RH_OFF,BX     ;SAVE OFFSET OF SAME
0299 CB                    RET

; DEVICE INTERRUPT HANDLER
029A
DEV INT:
;PRESERVE MACHINE STATE
    CLO
    PUSH DS
    PUSH ES
    PUSH AX
    PUSH BX
    PUSH CX
    PUSH DX
    PUSH DI
    PUSH SI

;BRANCH ACCORDING TO THE FUNCTION PASSED

02A3 2E: 8D 1E 0012 R      MOV     BX,CS:RH_OFF     ;GET REQUEST BLOCK ADDRESS FROM WHERE
02A6 2E: 8E 06 0014 R      MOV     ES,CS:RH_SEG     ;DEVICE STRATEGY PUT IT
02A9 2E: 8A 47 02         MOV     AL,ES:[BX]+2     ;GET FUNCTION BYTE
02B1 00 C0                ROL     AL,1             ;SET OFFSET INTO TABLE
02B3 8D 3E 001A R      LEA    DI,FUNTAB        ;GET ADDR OF FUNCTION TABLE
02B7 32 E4                XOR     AH,AH
02B9 03 FB                ADD    DI,AX
02BB FF 25                JMP    WORD PTR[DI]

; THE FOLLOWING ENTRIES ARE NOT SUPPORTED BY THIS DEVICE

;IOCTL IN:
02B0
IOCTL IN:
IOCTL OUT:
NO INPUT:
IN STAT:
IN FLUSH:
OUT STAT:
OUT FLUSH:
MEDIA CHECK:
BUILD BPP:
OUT VERIFY:
02B0 26: 81 4F 03 0100 +   STATUS DONE_ERROR_03   ;SET STATUS BYTE AS "ERROR-UNK COMMAND"
02C3 26: 81 4F 03 1000 +   OR     ES:WORD PTR SRH_STA_FLD[DI],0100H
02C9 26: 81 4F 03 0003 +   OR     ES:WORD PTR SRH_STA_FLD[DI],1000H
02CF EB 3F 90                JMP     EXIT

; INPUT = READ THE CLOCK CHIP
02D2
INPUT:
02D2 E8 06A2 R      CALL   IN_SAVE           ;CALL THE INITIAL SAVE RTN
02D5 EB 0073 R      CALL   READ_CLOCK       ;READ IN THAT DATE/TIME
02D8 2E: 8B 1E 0012 R      MOV     BX,CS:RH_OFF     ;RESTORE ES:BX AS REQ HDR PTR
02DD 2E: 8E 06 0014 R      MOV     ES,CS:RH_SEG
02E2 26: 81 4F 03 0100 +   OR     STATUS DONE_NDERROR,0
02E8 26: 81 4F 03 0000 +   OR     ES:WORD PTR SRH_STA_FLD[DI],0100H
02EE EB 20 90                JMP     EXIT

; OUTPUT = SET TIME & DATE
02F1
OUTPUT:
02F1 E8 06A2 R      CALL   IN_SAVE           ;CALL INITIAL SAVE ROUTINE
02F4 EB 01C4 R      CALL   SET_CLOCK        ;SET TIME & DATE
02F7 2E: 8B 1E 0012 R      MOV     BX,CS:RH_OFF     ;RESTORE ES:BX AS REQUEST HDR PTR
02FC 2E: 8E 06 0014 R      MOV     ES,CS:RH_SEG
0301 26: 81 4F 03 0100 +   OR     STATUS DONE_NDERROR,0
0307 26: 81 4F 03 0000 +   OR     ES:WORD PTR SRH_STA_FLD[DI],0100H
030D EB 01 90                JMP     EXIT

; EVERYBODY'S EXIT
0310
EXIT:
0310 5E                POP    SI
0311 5F                POP    DI
0312 5F                POP    DI
0313 59                POP    CX
0314 58                POP    BX
0315 58                POP    AX
0316 07                POP    ES
0317 1F                POP    DS
0318 CB                    RET

; INIT
0319
INIT:
0319 0E                PUSH   CS
031A 58                POP    AX                ;CURRENT CS TO AX
031B 05 0319 R      ADD    AX,OFFSET INIT
031E 26: C7 47 0E 0000 +   MOV     ES:WORD PTR BR_ADDR_0[DI],0
0324 26: 89 47 10      MOV     ES:BR_ADDR_1[DI],AX ; MAKE THAT THE BREAK ADDR

;CHECK VERIFY BYTE - HAS SOME OTHER SOFTWARE DIDDLED THE CLOCK?
032B BA 02C8        MOV     DX,CLOCK+VALID   ;PORT FOR VERIFY RAM
032B EC                IN     AL,DX
032C 3C 10          CMP     AL,VALID_CODE    ;ARBITRARY VALIDATION CODE
032E 74 0E          JZ     FINE              ;JUMP ON OK

;RESET CHIP-CAN'T TRUST IT
0330 B0 FF          MOV     AL,OFF           ;RESET ALL REGISTERS
0332 BA 02B2        MOV     DX,CLOCK+COUNTER_RESET
0335 EE                OUT    DX,AL            ;RESET ALL COUNTERS
0336 42            INC     DX               ;RAM(LATCH) RESET ADDR
0337 EE                OUT    DX,AL            ;NOW RESET RAM
0338 B0 10          MOV     AL,VALID_CODE
033A BA 02C8        MOV     DX,CLOCK+VALID   ;NOW VALIDATE RAM
033D EE                OUT    DX,AL

; FINE:
033E 26: 81 4F 03 0100 +   STATUS DONE_NDERROR,0
0344 26: 81 4F 03 0000 +   OR     ES:WORD PTR SRH_STA_FLD[DI],0100H
034A EB C4            OR     ES:WORD PTR SRH_STA_FLD[DI],0
034C                    JMP     EXIT
034C                    CLK    ENDP
034C                    ENDS
034C                    END    BEGIN

```

Text continued from page 443:

The DOS manual warns that heavy stack use might require a separate stack, however.

When initialized (INIT), the driver must tell the DOS the ending address of its code. PC-DOS 2.0 allocates all available memory to a program unless it is told otherwise, and failure to indicate an end causes quite a hang-up. This feature also allows disposable initialization code and attendant memory conservation.

When finished, the driver sets appropriate bits in a STATUS word located in the Request Header.

The Hardware

Normally, when the system is booted up, the PC starts counting timer ticks and uses software in the ROM (read-only memory) BIOS (basic input/output system) and disk system files to keep track of the time and date. You can set both, but the machine obviously has no memory of either when switched off. Many manufacturers are now supplying real-time clock/calendar chips with on-board battery backup.

Software is supplied to access the chip and set the time and date at start-up. AST Research supplies two programs at present to service the MM58167A chip. One reads the chip and sets the system time/date, and one sets the chip functions.

The MM58167A chip provides the time, day of the week, day of the month, and month, with capabilities for alarm features and synchronized start-up for precise timing. All data is stored on the chip in binary-coded decimal (BCD) format. Unfortunately, as shown in figure 2, PC-DOS 2.0 requires data from the system CLOCK\$ in a somewhat different format. Not only does it want the count of days since 1-1-80, but it also wants it in hexadecimal. The chip has no provisions for handling leap years or for keeping track of the year in any manner. Hidden in PC-DOS 2.0 are some appropriate algorithms for doing all this, but our driver reinvents the wheel and gives the PC-DOS 2.0 the raw hexadecimal data.

In addition to the counters on the clock chip, a bank of programmable latches also can be used as a non-

volatile RAM for storing the year, keeping track of leap-year bookkeeping, and checking to see if some other software has violated the clock or reset it. Much of the clock-driver program is devoted to these tasks. Other pertinent registers on the chip are a status register that indicates an invalid read due to counter rollover and registers to reset the counters and clear the RAM. All of these registers and counters have discrete I/O port addresses beginning at the base clock-port address hexadecimal 2C0

and ending at hexadecimal 2C0+1F. It appears that most other real-time clock chips work in a similar fashion storing data in BCD. This driver can be adapted to other boards by changing the appropriate base-port address and chip structure (provided it gives you a place to hide control bytes in nonvolatile RAM).

The Software

At the beginning of listing 1, the program makes use of two features of the macroassembler to make the

EXCEL SYSTEMS CORPORATION'S UNLIMITED WARRANTY

RESULTS

At Excel Systems we set our standards very high - to help you meet yours. We want to raise your expectations, your goals, and your effectiveness. We produce Software designed by real people for the real world.

ARIS Action Resource Information System is the *work processor* that leads you to success. ARIS organizes your needs, your priorities, and your activities, and goes on to create a more effective you in *action*. ARIS dials your calls, writes your letters, confirms your meetings, and prepares your schedule. ARIS prompts you to add personal, professional touches, for a style that gets noticed. ARIS is the new era of software - here for you today.

ARIS is results!

DECIDE Today's world demands clear decisions. How well you solve problems determines how good you feel and how well you perform. DECIDE is your personal counselor, leading you through a short series of processes to resolve your problem.

DECIDE is results!

PROTYPE Without effective keyboard skills you'll never harness the full power of your desktop computer. With PROTYPE you develop professional typing speed and accuracy in private, in a few weeks.

PROTYPE is results!

MNU Tired of searching through disk directories for your favorite programs and giving your computer endless commands? Create a master menu that lets you move in and out of programs with a single keystroke. Design reminders and use instructions that really work because you wrote them. And, you decide where they appear. MNU isn't for programmers, it's for you!

MNU is results!

esc  **EXCEL**
SYSTEMS CORPORATION

655 Redwood Highway, Suite 311, Mill Valley, California 94941
Ask your Dealer to demonstrate the entire EXCEL SYSTEMS line for you.

Join us

Electronics

magazine is on the move! We now have several exciting editorial openings for experienced technical editors or engineers who seek a career change.

Electronics

editors learn first about exciting new technology trends by visiting the high-tech firms that are creating them; they attend technical conferences, interview industry movers and shakers, and write and edit stories about what they learn.

We're looking for BSEEs or the equivalent, and some engineering or editorial experience in the following fields: semiconductors, microprocessor-based system design, software, telecommunications and/or data communications.

If you have these qualifications and an ability to write clearly about technical subjects, a rewarding career awaits you at McGraw-Hill with the industry's most authoritative information source. We're an equal opportunity employer.

Send your resume to or phone:

Samuel Weber
Editor-in-Chief

Electronics

1221 Avenue of the Americas
New York, N. Y. 10020
(212) 512-6093

Word (0-1)	number of days since 1 January 1980
Byte (2)	minutes
Byte (3)	hours
Byte (4)	1/100ths of a second
Byte (5)	seconds

Figure 2: PC-DOS format requirements for date/time transfer with the National Semiconductor MM58167A Real-Time Clock chip.

program easier to write and more readable. The STATUS macro borrowed from IBM helps by managing the setting of the status bit in the Request Header. It is expanded during compilation into the appropriate one or two lines of code. If the DOS should ever call on the clock for something inappropriate, like building a BIOS parameter block, the expanded STATUS macro will return the proper error code.

The STRUC (structure) pseudo op code generates no machine code directly but permits easy allocation of storage space and data access. The CLOCK_PORTS structure is set up to manipulate data the way the I/O ports line up on the chip. The UHR table of variables is set up according to this structure. The field names used act as mnemonics for offsets. For example, the value of the hours read into or written from the table is merely UHR.HRS. Similarly, [BX].HRS would return the value in memory located at the address in BX plus an offset of four. Structures also can be initialized at execution time to any value you choose, although here I've left it indeterminate.

After the required Special Device Header is the storage area of the program. This so-called data segment contains pointer storage, a function table for calculating what the DOS wants, local data storage such as UHR, and a month table. This table is used to transform the number of days to a month-day-year format and back again. It would be nice to use the 8088's XLAT op code for table lookups here but, unfortunately, XLAT translates only bytes, not words. The 8086 also suffers from this limitation.

Several of the subroutines are called many times. DEC_HEX and HEX_DEC convert packed BCD numbers back and forth to hexadecimal. LEAP_CHK checks to see if the

current year is a leap year, computes corrective leap days to add or subtract from the count, and sets local variables to indicate its findings (LEAP_STAT and NUM_LEAPS). NEW_YEAR compares the current month to a month-check byte stored in RAM on the chip. It updates the latter if necessary and handles the rollover to a new year. DAYS_MONTH (in lieu of XLAT) returns with BX pointing in the MON_TBL to the number of days in a year up to the current month.

Reading or setting the time portion of the clock is a simple pass-through of data, but special routines handle the date. DAYS reads the date and puts it into the DOS format; UNSCRAM does the opposite. The year minus 1980 is stored in RAM. During leap years the chip thinks February 29th is March 1st. In this case, LEAP_ADJ resets the chip and also writes code into its RAM to signal that it has been done.

Is It Worth It?

Are all of the new features of PC-DOS 2.0 worthwhile? I don't think a two-disk-drive PC owner will have missed the boat by continuing to use version 1.1. If you have a hard disk, however, or are contemplating special applications such as remote modem control, data acquisition, or writing your own command processor, PC-DOS 2.0 is the only way to go. ■

For those who prefer to let someone else do the typing, a 5¼-inch PC-DOS disk with the source code, CONFIG.SYS examples, and a COM version is available from the author for \$15.

David K. Broadwell, M.D. (135 Hospital Dr., Angleton, TX 77515), is a specialist in internal and aviation medicine. An instrument-rated pilot, amateur radio operator, soccer fan, and IBM PC user, he has his sights set on becoming an astronaut.

BYTE's User to User

Conducted by Jerry Pournelle

Bypassing FIELD

Dear Jerry,

In "Eagles, Text Editors, New Compilers, and Much More" (September, page 307), you mention Microsoft BASIC and make a passing reference to its FIELD statement. The FIELD statement can be almost completely bypassed if you simply ignore the way they say to use it. I always define one and only one variable in a single FIELD statement for any MBASIC "R" file. I define the variable to be the size of the entire file buffer—since the buffer is limited to 128 bytes. Unless you're using a parameter when loading MBASIC from CP/M, there is no problem about string sizes. This avoids the problem of numerous string variables that would result from following Microsoft's directions. It also allows more flexibility. The same field is used even for records with different contents. For example, in ephemeris files, my first record is two integers and a double-precision number (12 bytes), and all later records are three single-precision numbers (12 bytes). Or, a more complex record occupying five 128-byte sectors—one FIELD of 128 bytes is all it takes.

It works this way: the manuals warn you never to use normal string operations on FIELDed variables—the actual restriction is never use normal assignments. You can use LEFT\$, MID\$, and RIGHT\$ to read FIELDed variables. For assignments, what I do is build up my record using string concatenation with a throwaway string variable, then use LSET to put it in the buffer variable. The MKI\$, MKS\$, and MKD\$ functions will work with any string variable—they are not restricted to buffer variables. Similarly, the CVI, CVS, and CVD functions will accept substrings extracted by LEFT\$, MID\$, and RIGHT\$.

Is it at all likely that there will ever be an 8086 version of Write?

Mark Pottenger
838 5th Ave.
Los Angeles, CA 90005

That's certainly one way to deal with the dreaded FIELD statement.

An 8086 version of Write is in preparation now. It had better be, since I'm not going to stay with a Z80 forever! If Tony doesn't get it done pretty soon, I'll write my own version in Modula-2. . . . Jerry

A Doc's Best Friend

Dear Jerry,

A comment from a practicing physician on the Problem-Knowledge Coupler (dubbed Auto-Doc in "New Computers, Boards, Languages, and Other Tidbits," October, page 107): I want one. It will sure reduce my malpractice exposure. This is especially true for psychiatrists like myself. For example, I had a hunch that a foreign service officer's depression was actually an infection with a parasite. He had to wait until he was transferred to Southeast Asia to get it diagnosed. (National Institutes of Health was no help.)

I treated another case of depression with a diuretic. After her first visit, she didn't need me anymore. It turns out that asymptomatic mild congestive heart failure can cause depression.

The point is this: Many physicians today are specialists, and specialists perforce have limited experience outside their specialties. We need something to extend our experience. In medical school, we all carried pocket notebooks crammed with salient information which we had not yet or never would memorize. We called them "peripheral brains." I think the extension is obvious and should be welcomed.

Ed Hume
Washington, DC

An excellent point. It would be surprising if psychiatrists could keep up with new developments, or even remember all they once knew about internal medicine. Dr. Weed's Problem-Knowledge Coupler (PKC) should be a real boon to the medical specialist—not to mention to the patient. I hope to have more about his diagnostic programs in an upcoming issue. . . . Jerry

Languages of the Future

Dear Jerry,

I agree that none of us has a completely unclouded crystal ball, but I am surprised at some of the conclusions you have arrived at in your article "The Debate Goes On . . ." (August, page 312). I would have thought that both of us are in the same business, futurism, but for different reasons. You for the purpose of writing

entertainment fiction, and me for making investment recommendations. Still, your conclusions seem to ignore existing technology, let alone what seems to be coming over the horizon.

If you consider the Apple II, TRS-80 Model III, and the like, all first-generation microcomputers, then the IBM Personal Computer should be considered a later first-generation microcomputer. The Apple Lisa is the beginning of the second generation. The Motorola 68000 microprocessor in the Lisa is capable of addressing something over 11 megabytes (MB) of memory and Motorola promises a 32-bit version of that chip "soon" that would address 32 MB.

According to the trade announcements, upcoming 256K-bit memory chips will use CMOS technology that will make them usable for permanent or at least semipermanent storage, ending the distinction between RAM and ROM memory. Therefore, if you consider only existing technology and past price-curve performance, the magnetic-storage media manufacturers will be the buggy-whip makers of the mid-to-late 80s.

The answer to your question of which high-level language will prevail over the next five years is none of those you mentioned, or indeed, any high-level language as they are now recognized. Large memories will bring along self-programming computers that will program in machine language. Machine language would be our answer now, except it remains too difficult for most of us to learn and implement. The next 10 to 15 years will see microcomputers with enormous memories, probably multistate, which would be beyond human ability to program in any event. We may not see Arthur Clarke's HAL by 2001, but we seem to be on the road.

Adolph L. Friedman
112 Camino Escondido #4
POB 2856
Santa Fe, NM 87501

I thought I'd said that within five years, the floppy disks will be relegated to their original role of data transfer. Certainly I agree that with memory getting both cheaper and less volatile, we'll see some revolutionary developments in mass storage.

Regarding languages, perhaps; although five years is, I think, too short a time limit.

VAX and LISP machines aren't yet self-programming even in graduate schools of computer science; I'm pretty sure my desk micro won't be that smart by 1990, which is stretching past the five years of my article anyway.

Certainly, though, that's what some of the artificial-intelligence troops are working toward, and I expect we'll both live to see it. . . . Jerry

Defending FORTH

Dear Jerry,

I was excited to see a special article on microcomputer languages ("The Debate Goes On . . ." August, page 312). As a language hacker, I am familiar with most of the languages you mentioned, plus a few others. Much of what you wrote was timely and probably accurate. I must, however, take exception to your comments on FORTH and LISP.

You seem to be misinformed on both languages, yet you claim knowledge of both. As I am most familiar with FORTH, let me set you straight on the subject (I'm sure you'll get plenty of mail from all the LISPs).

For one thing, LISP will *never* absorb FORTH. The two languages are too different. Each has its place in the scheme of things. LISP, which is modeled after the lambda calculus, was created in the bowels of the MIT artificial-intelligence labs. Its purpose is to give experimenters in AI the tools to go about their trade. FORTH was invented by Charles Moore to provide the tools necessary for machine control and data collection. In this light, Moore's aim was to provide speed, efficiency, and productivity.

Looking at the environments of the two languages does reveal similarities. Both systems are compiled and then interpreted at run time. Both are implemented in an interactive environment and both look cryptic to the uninformed observer (LISP especially so).

If one looks a little closer, though, it becomes apparent that the two environments are totally different. FORTH is exceedingly small and very fast. On most microcomputers, FORTH's inner interpreter is only a few bytes long. The code generated by the FORTH compiler is very compact (even more compact than assembly language). One can strip out the parts of the system that aren't needed to make the code even more compact. This makes it possible to generate tight, ROMable code. With FORTH, real-time, interrupt-

driven applications are easy because the language is modular and close to the hardware. Many applications use these features to great advantage. The Craig Language Translator was programmed entirely in FORTH, as are a lot of coin-operated arcade games.

Hardware developers use FORTH because it is a very productive environment to work in. FORTH's modularity, extensibility, and virtual memory make it a hotbed for development. Recently, much is being said for developing business applications in FORTH. This is where FORTH's virtual memory can strut its stuff. Plus, the tools developed for one application can be transported to another with little or no change.

Much of the early problems with transportability of FORTH is being addressed by an international standards team composed of FORTH programmers. This gives the assurance that a standard transportable language will exist. And because FORTH is an evolving language, obsolescence is not in its future.

FORTH integrates extremely well into the microcomputer environment. Its advantages of speed and memory efficiency make it an almost ideal language for the small computer. (The Motorola 6809E is almost a FORTH machine in silicon.) For large systems, FORTH is at home as well. Multitask and multiuser primitives are easily added to the system. As a bonus, multiuser FORTH code is inherently reentrant.

Now, tell me again how LISP will absorb FORTH. As a reference to learn about each language, you may want to look at August 1980 BYTE for FORTH and August 1979 BYTE for LISP. And please try to be more informed before making rash statements like this.

Arne W. Flones
425 West Ninth St.
Wichita, KS 67203

Thank you. You speak well for FORTH. Perhaps I was a bit strong. However, what I said was, "I suspect that as LISPs get more common, LISP will get the bulk of the recruits who would otherwise have gone to FORTH." I was careful not to say that FORTH would vanish.

I'm still not certain that I was mistaken. True, the two languages are different; but as hardware evolves and computer power becomes cheaper, our desk machines will look more like the big machines available in computer labs and universities.

I think LISP is more popular with computer scientists than FORTH is. It certainly is at

MIT and Stanford (and my friendships at those two institutions probably do influence my thinking). Thus more students are likely to be exposed to LISP than FORTH, and are thus more likely to use it. Recall also that when I say "popular," I mean in the context of microcomputer sales: 30,000 to 300,000 machines a month. Given those sales, even "unpopular" can translate to a heck of a lot of users!

In any event, alas, I don't know either LISP or FORTH. However, experts on both have offered me tutorials. One day I'll have time to accept. . . . Jerry

Heathkit Horror

Dear Jerry,

I recently purchased a Heathkit H-100 computer. It has two floppy disks, 192K bytes, color graphics, color monitor, etc. My decision to buy the H-100 was influenced by several factors. The 16-bit word was a must. The advertised repair facilities at the Heathkit Electronic Centers were very important. Price was a consideration. Most important was the Heath-advertised assurance "And every step of the way, you have our pledge—We won't let you fail. Help is as close as your phone or the nearest Heathkit Electronic Center."

In the past, I have built several kits. This time, however, while building the disk-controller board I managed to get the wrong part in the right hole (or vice versa). Attempting to get it out I damaged the board. My fault, so I have no complaint there.

Remembering the glowing "We won't let you fail" message, I went trotting down to the local Heathkit center. There the local electronics guru agreed the board was damaged. However, it did not appear to be beyond repair.

For an additional fee of fifty dollars, the local Heathkit center sent the board back to the factory for "reconstruction." So far so good. For a price, Heath seemed to be living up to its representations. Not what I expected, but better than nothing.

Now the problem. This is the seventh week since the board was sent in. The local Heathkit center doesn't know when it will be returned. They somewhat apologetically offer assurances that they will call as soon as it comes back.

My concern is that I have paid Heath close to \$4000 for hardware and software. To date, it has been sitting on the shelf. If there should be a second problem, will

that take another two or three months or longer? When they say "We won't let you fail," do they really mean that if you make a mistake, it will probably be several months before you can use your computer?

What about maintenance? I bought the computer because I have a real need for its use. If it breaks, do I look forward to a two- or three-month delay for Heath to provide repairs? If so, how do I produce my letters, documents, manuals, mailing lists, etc? What happens to accounts receivable, accounts payable, etc? Do I go back to a manual system?

At this point I have serious concerns about the wisdom of my purchase. The implied support does not seem to be as represented.

I also have serious concerns about inexperienced people who attempt to assemble one of these. Quite often the assembly instructions leave a great deal to the imagination. In my opinion, no one should attempt one of these without a basic understanding of electronics, some degree of manual dexterity, and considerable experience assembling and soldering boards. Unless, of course, he is willing to pay the extra charges and put up with the extended delays which seem to be part of the "We won't let you fail" assurances from Heath.

Richard J. Townsend
35 Charles Hill Circle
Orinda, CA 94563

Yours is about the worst horror story I've ever heard about Heathkit. Most of my correspondents have been very pleased with the H-100, finding it simple to build and get running; and I've never before heard of so long a delay in getting service.

I do agree: you must be very careful about soldering. It's easier than you know to wreck one of those multilayer circuit boards. (I recall when Jim Hudson modified my Compupro 8085/8088 board to change the crystal; he was not only very careful, but he was worried about changing it back when the time came.)

I'd advise anyone contemplating construction of something as complex as an H-100 to buy a really good temperature-controlled soldering iron, and also one of those patented unsoldering devices. The two will cost nearly a hundred dollars, but it's good insurance.

Incidentally, all the Heath/Zenith stores use Heath and Zenith machines to record and report the sales, so the company obviously has some confidence in the machines. . . . Jerry

Otrona Obstacle

Dear Jerry,

The last two paragraphs in "Ulterior Motives, Lobo, Buying Your First Computer, JRT Update" (May, page 298) caught my attention. As you may know, there are a significant number of Otrona Attaché machines and users (as well as fellow enthusiasts) here at the lab. However, I have not been able to find anyone who can make the BIOS digest what ought to be valid "9" entries in the Otrona Attaché's escape sequences. For example, try to plot a point at $(x,y) = (9,9)$ from the keyboard or assembly-language calls with `^ [0^A^I^A^I` or from MBASIC with `PRINT CHR$(27); "00909"`. In contrast, the user-friendly MBASIC plotting enhancements work without a glitch. Unfortunately, I need to run FORTRAN (F80, M80, and L80). The enclosed list is not exhaustive since I also suspect the alternate lead-in `^ [V` command. The use of more offsets might help some escape commands but others require parameters with a range from 0 to 255.

Would any of your friendly wizards (hackers or consultants) happen to have a general idiot-proof patch around this turkey? Several sources indicate that the problem relates to the interface with CP/M's Tab function. I would appreciate any advice on this matter (or especially a cookbook solution).

Glenn Veeder
Jet Propulsion Laboratory
California Institute of Technology
4800 Oak Grove Dr.
Pasadena, CA 91103

Alas, you have exceeded my competence; but perhaps one of the readers will have a solution to your problem. I know of at least one Nobel physicist who has an Otrona, and who greatly enjoys playing about with its insides, as well as a number of computer professionals. You may also want to contact FAUG, The First Attaché Users Group at 449 1/2 Douglass St., San Francisco, CA 94114, or call (415) 647-8160. . . . Jerry

Move That Key!

Dear Jerry,

Regarding "Epson QX-10, Zenith Z-29, CP/M-68K, and More" (August, page 434), I have purchased the Z-29 terminal and like it. However, note the terrible placement of the Reset/Break key—right amongst several oft-used keys. If the

Break does anything at all in a system, it does something drastic. I had to modify my BIOS to keep my system from going catatonic on Break. Heath/Zenith ought to move that key. You'd think everyone would have learned by now about placement of Break keys.

When is one of your generous friends going to put together a technically oriented word-processing system—one that will do special symbols (math, Greek, etc.), superscripts and subscripts, and the like, with a screen display that looks like the printed result? Epson is coming close. Why are the Japanese ahead of us again? All the printer and screen-display technology exists. Why can't it be put together? Or do I have to program it myself?

H. Bradford Thompson
The University of Toledo
2801 West Bancroft St.
Toledo, OH 43606

Fortunately, you must do Control-Reset for the Reset key to do anything. I do agree that was a silly place to put it. I've never had any trouble with the Break key, but, as you mention, you can always jiggle the CBIOS (Customized Basic Input/Output System) to take care of it; indeed, you can retranslate the key if you really want to.

The Zenith Z-100 with the MPI 150G printer can do what you want; that is, the printer can print exactly what's on the screen. Of course, programming the special character set you want can be a problem. A good matrix printer, like the MPI, in conjunction with the Otrona Attaché does wonders too; the Attaché has Greek letters and various mathematical symbols built into its secondary character set.

Meanwhile, it's the Europeans who are really ahead. Niklaus Wirth's Lilith computer (available with laser printer in the U.S. from Diser Corporation for about \$30,000) can do all you ask for and a lot more besides; and with Modula-2 systems becoming available pretty inexpensively here, you should be able to program what you want for any good 8086 and high-quality dot-matrix printer. Let me know when you get it done. . . .

Seriously, you raise an important point. Why hasn't a U.S. company put it all together? Or have they, and I haven't seen it yet? . . . Jerry

I'll Take Your Epson

Dear Jerry,

According to your response to Chris Rutkowski's letter in BYTE's User to User (September, page 480), your Epson QX-10

programmers

READ THIS...

NOW, I KNOW I CAN MAKE BIG MONEY WRITING AND SELLING MY PROGRAMS. THIS BOOK TOLD ME WHAT TO WRITE — WHO TO SELL IT TO — THOUSANDS OF NAMES, ADDRESSES, IDEAS, GUIDELINES. "SOFTWARE WRITER'S MARKET" IS A FANTASTIC BOOK!

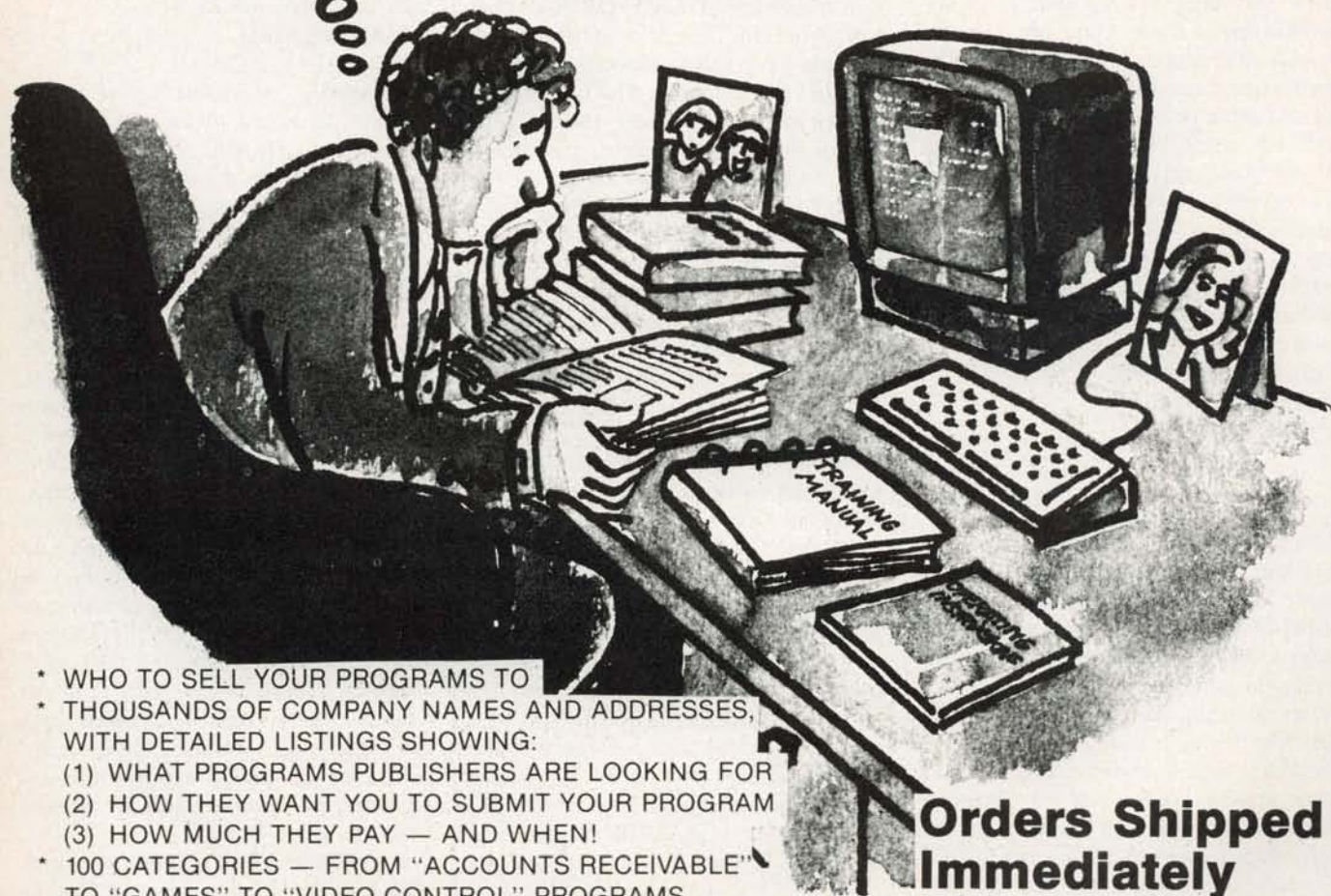

- * WHO TO SELL YOUR PROGRAMS TO
- * THOUSANDS OF COMPANY NAMES AND ADDRESSES, WITH DETAILED LISTINGS SHOWING:
 - (1) WHAT PROGRAMS PUBLISHERS ARE LOOKING FOR
 - (2) HOW THEY WANT YOU TO SUBMIT YOUR PROGRAM
 - (3) HOW MUCH THEY PAY — AND WHEN!
- * 100 CATEGORIES — FROM "ACCOUNTS RECEIVABLE" TO "GAMES" TO "VIDEO CONTROL" PROGRAMS
- * HOW TO WRITE CLEAR DOCUMENTATION
- * DEBUGGING TECHNIQUES

Enclose check or money order
for \$19.95 (No C.O.D.'s) to:

IPF Publications
146 Country Club Lane
Pomona, NY 10970
(914) 354-5585

**Orders Shipped
Immediately**

Name

Address

City..... State..... Zip.....

has been pretty much abandoned. I would like to suggest that you pack it up and send it to me! As a computer novice, I am not a fast typist, nor am I experienced with fast, powerful systems like the ones you routinely deal with. I feel the QX-10 is a great little machine, but have been unable to fund its purchase.

When I read of your ongoing disillusion with your Epson, going from one associate to another only to be abandoned by one and all, I thought I would at least write you this letter, to let you know that a home for orphan computers can be found. It would be well treated and much appreciated in our home.

It may be that many of the inherent problems with regard to operating systems will eventually become a great nuisance to us as we become more skilled in computers, and we may be financially able to move to a new and better S-100 system. If so, I promise to pass the Epson on to someone at no cost. We could be starting a great tradition here.

Jim Ralph
987 Lovers Lane
Akron, OH 44306

I guess I'd better explain what happens to review equipment here. None of it ever belongs to me. Some of it gets kept so long that it's functionally useless before we get through with it. This is often true of prototype equipment. Some is returned to the supplier. (The less we like it, the faster it goes back.) Some, at the request of the supplier, is donated to educational nonprofit institutions (and I have a long list of eligibles, so there's no point in applying for your favorite; sorry).

As for the Epson, we're not at all through with it. It's a nifty machine, and they're developing software worthy of it. As Professor Thompson points out in the preceding letter, there's nothing in the microcomputer world that comes closer to integrating screen and printout graphics. If we were truly unhappy with the QX-10, we'd have sent it back long ago. . . . Jerry

Choosing a Terminal

Dear Jerry,

I have been following your trials and tribulations relating to finding the perfect terminal and your choice of a Z-29 is a good one. I borrowed one from my "mad" furloughed friend and attached it to my North Star Horizon.

I am also in the market for a new terminal to replace my 7-year-old ACT-V. I want high-resolution graphics capabili-

ties, so I have been leaning toward the Visual 500. The Visual terminals seem to be very well designed and I especially like the extra-thin keyboard and choice of 12- or 14-inch screens. The Visual 50 is more in the league of the Z-29 as far as emulation and price (less than \$600 from some distributors). Have you ever considered the Visual terminals and, if so, what caused you to choose the Z-29 over them?

I know that you have used solid-state disk drives and are pleased with their performance. I would like to obtain one, but the price has prevented me. Have you ever tried a less expensive drive? One is sold by Digital Research Computers, \$399 for a 256K kit, or less than half the price of the newly reduced Semidisk at \$995.

James A. Whitman
Rt. #1 Box 408
Ft. Ashby, WV 26719

I seem to be batting zero. I've no experience with the Visual 500. As to how I chose the Z-29, I blush to confess that Zenith asked me to. There was a time when I could try out most of the new micro equipment; now that's not possible. I try to keep up by going to shows and reading the literature, but it's still pretty overwhelming.

Building kits is not my particular bag. I gather that if you're of a patient temperament, and willing to invest in a good temperature-controlled soldering iron, you can save a lot of money. There was a time when the best micro equipment was built from kits. My late friend Ezekial, who happened to be a Z80, was built up from kits (although not by me), because Tony Pietsch was more confident of his quality-control procedures than those of the company who made Zeke.

Nowadays, though, there's a lot of well-made equipment out there. Years ago, I once proposed building my own terminal so that I would understand what was in it. My mad friend put it succinctly: "Sounds like about as much fun as an appendectomy." Thus, I can sympathize with your desire to save money, but I won't be the one to recommend that you turn to kits. Perhaps another reader will have a comment. . . . Jerry

Protecting Pac-Man

Dear Jerry,

Hello from down-under (personally, I don't like that term . . . unless you like being called up-over).

In "The User Goes to the Faire" (June, page 306), you mentioned your participation in the Star Wars vs. Battlestar Galac-

tica dispute and the question arose of what constitutes an idea worthy of protection. Taking the Pac-Man example, surely the essential ingredient of this game is the theme of a player navigating a maze and consuming power pods. The shape of the Pac-Man or the nature of the power pods is irrelevant to the underlying theme of the game. Thus there are two views one could take.

First, the people who originally conceived the Pac-Man theme, Atari, should have sole and complete rights to its implementations. The public would have to rely on Atari to produce the different versions of this popular game, or just put up with the standard format. Intrepid programmers could of course write their own versions, as long as they'd recognize Atari's claim to part or all of any profits gained. Second, all ideas are unique (and not just one of genre). This would mean that the slightest difference in the shape of the Pac-Man would constitute a new idea. The public reaction to the multitude of different games resulting from this policy would indicate who had the best idea. This policy allows constant improvement of existing merchandise and a good climate for the small business.

I only offer these as possibilities for the resolution of a persistent problem, and do not make a judgment as to their quality. I do however feel strongly that the present situation, by which many Pac-Man games are legal but some, which most resemble the original, are sued, is totally unjust and impractical.

Brett A. Patterson
26 Athlone Rd.
Floreat, 6014,
Perth
Western Australia

I'm not sure what I think about protecting Pac-Man. I do know that Atari bought itself about a million dollars worth of unfavorable publicity by bullying some very nice teen-aged programmers; surely they could have been smoother about it. Game fads don't last long anyway. I notice that what really gets 'em in the arcades now are the games coupled to video disks; these, I fear, are not soon likely to be produced in garages, although I wish they were. I've yet to get close enough to a machine to play Dragon's Lair. . . . Jerry

A Vote for Larger Screens

Dear Jerry,

After a year's reading and research we decided to buy either two Kaypro 11's or

a NEC APC; we will probably buy the two Kaypros on the theory that if one goes down we have a spare, for the price of one more-advanced computer.

Despite all the amazing progress in computers, and despite the much advertised and vaunted spreadsheets, computers still only show a miserable 24 lines by 80 columns. How silly!

Like every business we use an 8½-by 11-inch sheet for most paperwork. We print booklets, and have been composing them on the typewriter as we write them. All computer salesmen say that it is better to be limited to the small-sized screen, but we don't believe it. We need to view the finished page so that we can see paragraphs in relationship to each other and to see if our ideas are presented correctly on the whole page.

If we had the money we could get a Vydec which shows two full pages, or a Dictaphone which shows one full page with an additional lighted line as is on our Olivetti ET221, or we could go to a Corvus Concept computer, but even that is too high for our budget. The Corvus is the way that the future lies, of course. It puts the CRT on its side for spreadsheet (a 14-inch screen) and on edge for a full page of typing. Why can't some of the other computers do this too at a reasonable price? It can't be too difficult and it is ridiculous to have all these fabulous advances with such a small screen. That is like having a 1983 car that you have to hand-crank!

S. E. Millar

POB 1

Olympia, WA 98507

I fondly remember Olympia; my wife used to race sports cars at Shelton, Washington, and we'd stop for the lumberjack's breakfast on the way.

Tony Pietsch has always said that the best service policy is another computer, preferably identical to your first. It's not much more costly than a long-term maintenance contract, and certainly more useful as long as both are running.

I keep hearing rumors of terminals that will give a great many lines to the page, but I've never had one to play with and, to tell the truth, I've never missed that feature.

I've never had much problem with screen sizes. A standard manuscript page is 60 characters wide, and double-spaced I used to get only 26 lines to the page anyway. In fact, I normally write on a memory-mapped screen that's only 16 lines. My editors tell me it improves my stuff since I don't tend to write such

long paragraphs. (Of course I use Write, which uses all the screen lines for text; none are taken up with status lines and things like that.)

I suspect you won't have to wait long before new, low-cost terminals appear with the features you want. Things flow so in micro-land! . . . Jerry

MS-DOS for the Compupro

Dear Jerry,

I have been anxiously awaiting an issue of BYTE in which you review the MS-DOS operating system for the Compupro ever since I followed your eminent logic and purchased a Compupro System 8/16 Model A in December of 1982. Before taking the plunge I did check to find out if MS-DOS was available for the Compupro because I was aware that there was a growing threat from the IBM PC and PC-DOS. I had a hint from two independent sources in BYTE that MS-DOS was available for the Compupro systems. One was a series of articles in BYTE comparing MS-DOS and CP/M-86, written by Roger Taylor and Phil Lemmons ("Upward Migration, Part 1: Translators," June 1982, page 321 and "Upward Migration, Part 2: A Comparison of CP/M-86 and MS-DOS," July 1982, page 330). Careful examination of their articles revealed that the benchmarks were run on Compupro equipment. The other source was a What's New? product blurb in BYTE which stated that Lifeboat Associates would be releasing SB-86 for Compupro systems. I called Compupro and was told: yes, Real Soon Now.

I have since called Lifeboat and the person who configured SB-86 for the Compupro systems has left without documenting the implementation. Yes, as a service, Lifeboat will sell you SB-86 for Compupro but it is not documented and you are pretty much on your own.

Fortunately, I have also discovered two other possible sources. One is Midwest Micro Warehouse which claims to have a product written by people at Compview Products. Another source is a Computer House product aptly named MS-PRO.

In "Eagles, Text Editors, New Compilers, and Much More" (September, page 307), you indicated that you and/or your associates have experience with MS-DOS/PC-DOS for the Compupro. (I should point out that I am not sure what the exact differences between MS-DOS and PC-DOS are.) I am particularly interested in the logical and/or functional

(as opposed to physical and/or implementation) equivalent of PC-DOS. I recognize that this may be a very difficult if not an impossible equivalency to achieve, thus I use the term MS-DOS as a minimal requirement. I would appreciate any additional information or recommendations you may have regarding MS-DOS for the Compupro 8/16 systems.

Chris Boynton

9500 Southwest 94 Court

Miami, FL 33176

I may have misled you, and if so, my apologies. Tony Pietsch has managed to get PC-DOS, the operating system for the IBM Personal Computer, to boot from a 5¼-inch disk run by a Compupro 8085/8088 Dual Processor. The Dual Processor normally boots from 8-inch disks, and runs Digital Research's CP/M 2.2 when in an 8-bit mode (using the 8085) and CP/M-86 when in 16-bit mode. (At least mine does.)

There are no real differences between PC-DOS and MS-DOS, except that PC-DOS is specifically tailored for the IBM PC, while MS-DOS is a generic term for the Microsoft operating system for the 8086/8088 family of computer chips.

Alas, although Tony managed to get PC-DOS to work on his Dual Processor (and indeed was using my disk controller and disks when he did it), he then went off to Europe for a month; as of this moment (October 1), he hasn't returned, and I don't have that operating.

It's quite possible that what you request will be available by the time this gets in print, but I can't guarantee it. Meanwhile, I have no experience with the other versions you mentioned.

Given the three- to four-month delay between my writing and BYTE's publication, it's always a problem as to just how much brand-new stuff I report. This time, I was a bit eager. Sorry. . . . Jerry

Assembly vs. Machine Language

Dear Jerry,

Most of the things you have written for BYTE have been so well informed that I was rather surprised to see your remarks about assembly language in "Eagles, Text Editors, New Compilers, and Much More" (September, page 307).

You say that assembly language is a fairly large step up from machine language. While fairly large is a matter of

opinion, it seems to me that because of a one-to-one correspondence between assembly codes and machine instructions, they are in fact different forms of the same language. The only difference is that the assembler mnemonics can be easily remembered by humans and easily converted to their machine form by an assembler. It is, in fact, child's play to translate a program from one to the other because of the one to one.

Machine language programs are transportable; all Z80 or other microprocessors obey the same set of machine instructions. The transportability problem arises only when the program is incomplete and relies on subroutines from the host computer, subroutines that might be at a different address in another computer or even missing from it. Of course there is the BIOS problem; trivial really.

Your statement that some computers don't have an accumulator floors me. Is your hardware knowledge so limited that you think any digital computer could operate without at least one accumulator? ENIAC had a dozen or more accumulators (20 if memory serves me) and although the von Neumann scheme cut back to one, that one has remained essential to digital computing. It was called the Mill by Babbage because that is where the work was done. The rest is just moving bits from keyboard to accumulator and to screen or from accumulator to screen, printer, storage, or modem. Perhaps, though, you have been misled by the term CPU, which has the accumulator as a vital part. Ask your friend Mr. Leventhal about it.

David Block
POB 12473
Gainesville, FL 32604

Assembly language is a hefty step up from machine language for me! I wish we'd had a good assembler for the IBM 360 I started with. . . .

I think you've floundered over a definition. While it's true that all computers (at least all I've ever worked with) have something that functions like an accumulator, some have a particular register dedicated only to that task, and some don't; which was all I meant by my remark that some "don't have an accumulator." . . . Jerry

Unix Notes from All Over

Dear Jerry,

In BYTE's User to User (September, page 480) James E. Densmore Jr. laments

the lack of an ability to suspend execution of one program while running another under the Unix operating system. He is quite in error.

Any single-tasking system can accomplish this by saving an image of the register, memory space, and associated files. On a multitasking system such as Unix, the implementation is trivial: one merely suspends operation of one process upon a prearranged signal and continues with a second process which may or may not be running already. With newer versions of Unix supporting the Berkeley C-shell, one need merely type a control character to interrupt any process in the foreground. At the user's wish, the process may be killed, restarted, or relegated to a lower priority (background processing). Meanwhile, one can proceed with additional process(es).

Furthermore, the command interpretation procedure and recursive features mentioned by this reader have existed on Unix from its very early days.

Donn S. Fishbein, MD
4000 Tunlaw Rd. NW 820
Washington, DC 20007

My late mad friend was interested in Unix, but so far I don't have any machines that run it. I expect that will soon change. Meanwhile, I can collect stories. Thanks. . . . Jerry

Dear Jerry,

I would like to clear up a misconception on the part of James Densmore about Unix. He states that while MULTICS allows virtually infinite recursion in calling "command procedures," Unix does not. Well, UNIX *does* implement the concept of "forking," which allows other processes to be generated concurrently with the generating process. These processes can be any executable file, usually a compiled C program.

While infinite recursion is not feasible (a small limit, on the order of 8, is placed on the number of subprocesses running at once), it is very rarely used. Indeed, since C is completely recursive, most recursive tasks can be done within the command module (arguably where recursion belongs). As a final note, shell scripts (i.e., command files) are recursive. Since these have flow-control instructions available, they function much like procedures.

Finally, a question on Concurrent CP/M-86. If it can run more than one program at once, how does it prevent one from corrupting the other? The IBM PC,

an 8086-like system, does not implement memory protection. Nor is memory mapping/vectoring facilitated; so how are programs relinked to function in different sections of memory? Finally, how does CP/M-86 compare with Unix's piping and redirection capabilities?

These are important questions since they directly affect the usability of an operating system like CP/M-86. While I can guess at methods by which a multiple-process operating system can function on a machine like the IBM PC (extensive swapping, instruction interpretation), none are acceptable. So, how does Concurrent CP/M work? As a systems programmer, I sure would like to know.

Michael Kilian
1869 Highland Ave.
Troy, NY 12180

I'll let others fight about Unix. Regarding Concurrent CP/M-86, I'm trying to do a good bit of a column about it. Alas, it's complicated by IBM: after three months they still haven't delivered the PC I paid for (by certified check, yet)! Until I've got that, I can't do much with Concurrent. Surely by the time you read this I'll have it. . . . Jerry

Dear Jerry,

In BYTE's User to User (September, page 480), James E. Densmore Jr. notes that MULTICS allows the user to interrupt a program being executed and return to it later, while Unix does not. This is not quite true, as the version of Unix for the VAX (distributed as version 4.1 Unix in the Berkeley "bsd" release) contains such a feature.

The implementation is nothing like the one used by MULTICS, of course. Instead, it takes advantage of the fact that Unix, like any multiprocessing system, has a way to checkpoint a process while other processes run. It simply defines a keyboard interrupt that forces the currently running process into that checkpointed state and returns control to the user's command-line interpreter (shell), using the existing signal facility. Provide a way to restart the stopped process from the shell, and you're done.

Considering that many prospective Unix system developers (and customers) are familiar with Berkeley Unix, that the feature is obviously desirable, and that it is not really very difficult to add the necessary process states and system calls to a "vanilla" Unix system during development, I should be surprised if this feature

did not become standard in Unix systems, and if not tomorrow then soon.

Richard Hussong
Applied Reasoning Corporation
77 Trowbridge St.
Cambridge, MA 02138

They tell me that "vanilla" Unix is unusable by novices; and though Unix is easy to customize, once you've done that, there's no standard way things are done, and you're sort of on your own remembering your customizations.

Perhaps what it needs is some "standard customization?" . . . Jerry■

Praise for the Final Word

Dear Jerry,

In "Eagles, Text Editors, New Compilers, and Much More" (September, page 307), you made an apparently uninformed comment about a program I truly love: the Final Word word processor from Mark of the Unicorn. Not only will the Final Word format end notes automatically, it will do footnotes or in-line notes. It will automatically create and format tables of contents and indices too! It can make all kinds of lists, like file inclusion (Wordstar needs the Mailmerge option) and keyboard input during formatting. In this instance, the formatter will prompt you if needed, and you just type in the stuff you want included. It will format style changes at any point so that you can change things like margins, indentation, justification, paper size, note style, line spacing, and tab spacing any place in the file.

And besides the terrific formatter, the editor itself is nicer. It displays text faster. You can have up to 12 editing buffers available at once. Parts of two of those buffers can be displayed at once (this is incredibly handy). A feature called State Save saves changes after you stop typing for a few seconds. If power goes down while you are editing, the only material lost is that which had not been written out with the State Save. This has saved me a couple times as my town has an incredibly wimpy power system. You can leave the Final Word to do something else, then start again, and it will return to exactly where you left off. You don't need to read in the same file again. And commands really are mnemonic.

But, if you don't like something, the Final Word is almost infinitely configurable. You can change the keys that cause movement, for example. You can even change the width it uses to print individual characters if you want. The Final Word can do true proportional spacing on printers capable of supporting it, not just microjustification like Wordstar.

Wanna hear more? The documentation is really good in my opinion. There are nine lessons included. Three of the lessons consist of a disk file containing the output of the text used to create the same chapter in the printed documentation. The manual was created with the Final Word and, as such, contains a good table of contents and index.

The Final Word can do anything Wordstar does except suggest hyphenation. It costs less and has capabilities that you have to spend hundreds of dollars more for with Wordstar. I haven't covered half of them.

Also, support from Mark of the Unicorn is very good.

David D. Clark
246 South Fraser St. #2
State College, PA 16801

Yours is not the only enthusiastic letter I've received regarding the Final Word, and I know for a fact that Mark of the Unicorn provides good support to its customers.

I'm fairly set in my preferences for computer editors—given the tens of thousands of words I have to pour out each month, it would be surprising if I weren't—so it's unlikely that I'll make many changes. However, shortly after I began writing with computers, I discovered Electric Pencil. The program I use now, Write, grew out of the Pencil's strengths and defects.

Not long after I got used to Pencil I became involved with net traffic and, working with machines at MIT, I ran into EMACS. If it had been the first full-screen editor I'd worked with, I might well have become an EMACS enthusiast.

The Final Word, like Mark of the Unicorn's MINCE (Mince Is Not Complete EMACS), is based on EMACS.

"There are nine and sixty ways of constructing tribal lays, and every single one of them is right." Editors aren't quite so much a matter of taste as that, but certainly there's no single "best" one. Glad you've found one you like! . . . Jerry

Jerry Pournelle welcomes readers' comments and opinions. Send a self-addressed envelope to Jerry Pournelle, c/o BYTE Publications, POB 372, Hancock, NH 03449. Please put your address on the letter as well as on the envelope. Due to the high volume of letters, Jerry cannot guarantee a personal reply.

We have met or have beaten most advertised prices.

Don't be foolish. Buy Direct!

For Price Quotes and Ordering Call:

1-800-328-8905

For Technical Information and
Arizona Orders, Call:
602-949-8218

For Shipping and Order Status Information,
Call: **602-990-7556**

LIBERTY
GROUP, INCORPORATED

4221 Winfield Scott Plaza · Scottsdale, Az 85251



**Everything in
computer related
products:**

- Computers
- Modems
- Printers
- Software
- Monitors
- Terminals
- Accessories
- Paper
- Ribbons
- Diskettes
- Office Furniture

We welcome Certified and Cashiers Checks, Bank Wires and Money Orders. C.O.D.s are shipped with a minimum C.O.D. charge. Allow 3-7 days for personal checks to clear. Product is subject to availability. Equipment is in factory sealed boxes with manufacturer's warranty. There will be a re-stocking charge for returned merchandise. Call first for an RMA number. Software not warranted for suitability. No return of Software which has been opened. Add 2% for shipping & handling charges (minimum \$2.50). All equipment shipped F.O.B. Scottsdale, Az 85251.

Ask BYTE

Conducted by Steve Ciarcia

Getting Started

Dear Steve,

I am a beginner in the computer field. I hope to either buy a computer that teaches the design principles of computers or to design a computer of my own. Because I live in the United Kingdom, I have found it very difficult to find one. I was wondering if you might be able to help me. Are there any computers for sale in the U.S. that are good for beginners and are not too expensive?

I have seen two computers: the Ferguson Big Board and the Insight Enterprises computer. Would either of these be a good introduction to computer design and expandable enough later on? The Big Board doesn't seem to be. I have not been able to read any reports on these computers, though, and thus am skeptical about buying them. I would appreciate your comments very much.

**Edward Newman
Sherborne, Dorset
United Kingdom**

This is an excellent time for a beginner to enter the computer field as there are many low-cost, high-performance models from which to choose. One of the fastest sellers in this country is the Commodore 64. It features 64K bytes of memory, high-resolution graphics, a full keyboard, and a price as low as \$200. A reference manual is available that describes the inner workings and advanced programming techniques.

The Radio Shack Color Computer is another low-cost model with the powerful 6809 microprocessor chip. It is well supported as evidenced by at least four magazines devoted exclusively to the "CoCo."

The two models mentioned are only representative of the vast number that are available. These

models allow you to take the unit out of the box, add a TV or monitor, and start computing. If you want to configure your own system from one of the single-board units you mentioned, recognize that considerable additional equipment is required. Most require a terminal, power supply, and disk drives to function at all.

If you are a beginner, I would recommend buying one of the just-mentioned ready-made computers. As your knowledge increases, you will recognize the features that are important to you and those that are unnecessary. . . . Steve

Videodisc Interaction

Dear Steve,

I enjoyed your June 1982 article, "Build an Interactive-Videodisc Controller" (page 60). I, too, am very enthusiastic about the future potential of this technology.

Due to my lack of knowledge about electronic hardware and limited funds, I was unsuccessful in creating the coding necessary to control the Pioneer VP-1000. I thought that if I were successful, the software could be applied universally and interactive programming would not be dependent on the type of hardware interface a person owned.

I think the problem is that the Vic-20 I own is not capable of creating a 38-kHz tone. The Vic-20 has a 6502 microprocessor and a 6522 versatile interface adapter. It has a 1-MHz clock rate that allows 1 microsecond (μ s) per cycle. Therefore, I can get only 13 μ s instead of the necessary 13.15, creating a 38.4-kHz tone. Evidently, the carrier frequency must be exact for the VP-1000 to recognize the command.

I have a question about your article: in figure 2a, and in the text on page 65, it is indicated

that the pulse burst is 0.263 milliseconds (ms) long and is included in the bit period. However, in figure 6 you indicate that the pulse burst occurs, and afterward there is a delay of 1.05 or 2.1 ms, depending on the logic code. It appears to me that for a logic=0 the first delay should be 1.05 ms minus 0.263 ms, or 0.787 ms. I have tested these and many other possible delay times, so I conclude that the problem is with the 38.4-kHz carrier frequency. Also, in a January 1982 article in Microcomputing (page 103, figure 3), it is indicated that the pulse burst is 0.233 ms long and delay times are 0.93 and 1.86 ms. Was this a mistake, or has Pioneer changed things in newer models?

Assuming that it is impossible for me to create the necessary coding due to the limitation of the 1-MHz clock rate, I am forced to resort to a hardware interface. Do you think that the 38-kHz crystal (Pioneer part number VSS-002) can be purchased and used as an external clock to control the necessary 38-kHz carrier frequency? Any ideas on how this might be accomplished would be appreciated.

Thank you for your consideration and any help you may be able to offer to help me create a low-cost universal VP-1000 controller.

**Gary W. Schroeder
San Francisco, CA**

The logic as stated in my article is correct. The bit period is defined as the time between the pulses; the length of the pulse itself is not significant for the coding. The carrier frequency is used for detection.

The article in the January 1982 Microcomputing used the code values as supplied by Pioneer, which were incorrect. I discovered this when I designed my circuit, and I brought it to Pioneer's attention.

Generating the necessary coding in software is extremely difficult. It is even more difficult to write a universal program since it is so dependent on machine timing. It is much easier to use some form of hardware assistance. The simplest is the 555 oscillator to generate the 38-kHz pulses and gate them under software control. If your hardware knowledge is limited, go with the circuit on page 72 of my article. It needs only 5 volts and is extremely easy to build. . . . Steve

Adding CP/M and Apples

Dear Steve,

I have an Apple II Plus with 48K bytes, two disk drives, and a 16K-byte RAM card. I would like to use it for CP/M. What additional hardware do I need? What is the difference between a Z80 card and Microsoft's Soft-card? Do I need both? Thank you.

**Jim Fox
Peckville, PA**

To run CP/M on your Apple II Plus, you need a card that contains a Z80 processor chip. Many such cards are on the market at various prices. The cheaper ones do not come with the CP/M operating system. The softcard is Microsoft's version of a Z80 card and includes the CP/M operating system with several utilities and Microsoft BASIC.

Many of the programs that run under CP/M require an 80-column screen and uppercase/lowercase capability. An 80-column card should also be purchased to fully utilize the system.

Make sure that your CP/M card is compatible with your 16K-byte RAM card and your 80-column card. Most cards are fully compatible, but some are not. Be sure to ask. . . . Steve

Interpreting Information

Dear Steve,

Can you recommend a source of information on the details of BASIC interpreter operation? It doesn't matter to me which microprocessor is used. I'm just looking for the fundamentals. Thank you.

Jorge S. Lucas
Belo Horizonte, Brazil

In the early days of microcomputers, at least one publication featured a series of articles on the workings of BASIC interpreters. There were listings of some Tiny BASIC interpreters for an 8080-based system, and general operation was discussed. They are contained in volume 1 of Dr. Dobb's Journal of Computer Calisthenics & Orthodontia (Dr. Dobb's, for short) and can be obtained from Hayden Book Company Inc., 50 Essex St., Rochelle Park, NJ 07662. . . . Steve

BASIC Precision

Dear Steve,

I have a suggestion and a question: how about an article on building a switching-regulator power supply using power MOSFET for the S-100 bus? I'm enclosing a copy of an article from Electronic Design (February 17, 1983, page 135). This would cut down on the heat dissipated both on the boards and in the enclosure and also conserve on energy.

I am doing a lot of work with the NBS (National Bureau of Standards) Temperature Tables. This work involves the use of polynomials and requires 54-bit accuracy to duplicate the results from the tables. My Polymorphic Systems 8813 BASIC has the ability to use up to 26-digit precision, which appears to be good enough for the job. The computer I use at work is an Altos 8500 running under CP/M and Microsoft BASIC. The Microsoft

BASIC does not have the required precision.

My question is this: can someone suggest a method for evaluating the precision of various BASICs, or does someone know of a CP/M BASIC that will have the desired precision?

Joseph R. Toman
Skokie, IL

Thank you very much for your suggestion. I have addressed this subject on a smaller scale in the November 1981 BYTE (page 36) but will keep your idea open for a future article.

Regarding the question of precision of various BASICs, it seems to me that you are mixing "bits" and "digits." For example, Microsoft BASIC has a real data precision of 7+ significant digits and is represented in the computer in a 4-byte, floating-point form. Of these 4 bytes, 1 represents the characteristic and 3 represent the mantissa. Thus, there are 3 bytes, or 24 bits, of precision allocated to the mantissa.

If double precision is used, 16 digits of precision are obtained, and the representation is 8 bytes, 1 of which is allocated to the characteristic. The remaining 7 bytes (56 bits) apply to the mantissa.

Hence, 16 digits of precision corresponds to 56 bits of accuracy. This seems more than adequate for the NBS tables to which you referred. To evaluate other BASICs, the storage format and the byte representation of the numbers must be known. . . . Steve

Author! Author!

Dear Steve,

I would like to start writing articles for computer magazines. I have a bachelor's degree in computer science and math, along with eight years of experience in the computer field. I love microcomputers. I would appreciate

any help you could give me. Thanks.

Joseph M. Ruvolu
Staten Island, NY

Writing articles for computer magazines, or any magazine for that matter, requires a subject that is appealing to a large audience and a certain style of presenting that subject. There are many computer magazines catering to different levels, and you should concentrate on those where your expertise can be utilized. You will have little chance of publishing a highly technical article in a magazine such as Popular Computing, since it is not aimed at that audience.

One way is to write an article or two and submit them to potential publishers. You can judge from their responses whether you are on the right track.

Take a look at "A Step-by-Step Guideline Outlines Writing for Publication" by George R. Dunn in the October 20, 1980, issue of EDN magazine. It offers some good advice for potential writers. . . . Steve

Apple Emulator

Dear Steve,

I have been told that some place in the market is a device that can be used with a Commodore 64 that enables it to utilize all the available Apple software. I think it is called an "emulator." I have called a number of computer distributors without success, and I thought that you might have come across this device. If so, I would appreciate your directing me to the appropriate source so that I might get further information.

Many thanks for your help.
Morton J. Perlin
Miami, FL

The device that will allow the Commodore 64 to read Apple II software is called the Amulator and is manufactured by Advanced Integrated Development.

The unit sells for \$129 and requires you to physically remove the 6510 microprocessor chip in the Commodore 64 to piggyback the Amulator. Once installed, the unit will read most 40-column Apple II software but will not allow writing to a disk.

There have been many rumors of Apple emulators and personality modules for the Commodore 64. In fact, the introductory articles describing the 64 touted, as one of its features, the ability to emulate other popular computers. It seems that this has finally come to pass.

Further information can be obtained by contacting Advanced Integrated Development, 5902 John Martin Dr., Brooklyn Center, MN 55430, (612) 561-1645. . . . Steve

Entrepreneurship

Dear Steve,

I have developed a plug-in board that gives (I believe) the Apple II computer sound capabilities as good as the Commodore 64. I would like to manufacture and market it, but I don't have the resources to do so. For that reason, I would like to have a company manufacture it for me. Can you tell me who might be interested in manufacturing it for me or how to go about finding someone who would?

Mark E. Rogers
La Place, LA

Yours is a problem shared by many budding entrepreneurs. You will find that engineering a prototype board represents only about 10 percent of the time and money involved to bring the final product to market. With advertising in magazines as high as \$8000 per page per month, it is no wonder that few have the resources to complete such projects.

Having another company manufacture your board is a logical approach, but don't expect to get rich. Stop and think

what the board could reasonably sell for and then determine the wholesale cost to the dealer (40 to 50 percent of list price). Then estimate the cost and profit of the manufacturing house, add in advertising and promotions, and the remainder may be yours. Approach some of the houses currently making cards for the Apple II to determine their interest. Then see if any of the offers are satisfactory. . . . Steve

Photon Control

Dear Steve,

I'm interested in controlling lights with a computer. I want to memorize and play back patterns of between 5 and 20 lights activated at different times for different durations. What type of interface device do I need? I'd prefer to use an inexpensive Vic-20 if possible. Thanks for your help.

Randy Maule
Gainesville, FL

The Vic-20 has a 6522 versatile interface adapter chip that contains eight I/O (input/output) lines. Additional I/O lines can be added through the use of an expansion bus. Each line can be programmed as an input or output and read simply by examining (using the PEEK command) the memory location for which the chip is mapped. Assign one line to each light to be detected and use a phototransistor to convert the light input to a 5-volt DC output. It might be helpful to have one line available to sense the presence of any light.

Your program could then poll the "any light" line to see when a light has been turned on. Then, depending on the duration of the lights to be "memorized," the program could read these lines at equal intervals and store the data. This would continue until the "any light" line sensed the absence of light.

To simply turn lights on and off, use an optoisolator and a

relay. The optoisolator consists of an LED (light-emitting diode) and a phototransistor. When your computer I/O line sends a logic "1" (5 volts DC), the LED glows and causes the phototransistor to conduct, closing a relay. . . . Steve

Video for the Sym-1

Dear Steve,

It is very difficult for me to get literature and components for experimentation, and I hope you can spare me a lot of aggravation and wasted time.

I bought a Sym-1 microcomputer and built a power supply and ASCII keyboard, but I don't know how to obtain a video output from my TV, which I've adapted for direct video display. The Sym's block diagram shows that some kind of "TV/keyboard interface" is needed. Can you help me? Thank you very much.

Tomo Mlinaric
Zagreb, Yugoslavia

A device known as a video-display board or "TV typewriter" is required to obtain video output for your Sym-1 computer. Such a device takes an ASCII input from a keyboard or computer output and converts it into video characters that can be displayed on a TV monitor screen. A construction article appeared in the February issue of Microcomputing (formerly Kilobaud) magazine on page 70. "Build a \$50 TVT!" by Duane Amundson describes a device capable of displaying 16 lines of 32 characters, using readily obtainable parts. Its low cost makes it an interesting project. . . . Steve

P.S. See my article this month for a terminal you can build.

Vic Expansion

Dear Steve,

Is it possible to build an expansion bus for the Vic-20 similar to that used with the Ap-

ple II? They both use the 6502 microprocessor. If this can be done, can you tell me where I can obtain the necessary technical information? Would function boards designed for the Apple then be compatible with the Vic-20? Thank you for your help.

Larry W. Snead
Danville, VA

While the Vic-20 and the Apple II both utilize the 6502 microprocessor chip and both can have expansion buses, peripheral cards designed for the Apple will not work on the Vic. Aside from different timing considerations on the bus, the Apple cards have on-board ROM (read-only memory) that contains programs to control their functions. These programs call routines that are either not available or are located in different memory areas in the Vic.

An expansion bus can be made or purchased for the Vic. See the back pages of any computer magazine containing Vic-20 articles for advertisements. I recently saw an ad for a 4-slot expansion bare board for only \$19, including instructions. You may want to go this route, as it will save you a lot of wiring. Contact The Data Toolbox, POB 4808 V, Las Vegas, NV 89127, (702) 648-3258. . . . Steve

Assembling a Z80

Dear Steve,

I am a senior at Monroe High School and vice-president of the Monroe High School Computer Group, an offshoot from our computer-science class. After doing some heavy 6502 machine-language work, we just touched on the Z80. Recently, I purchased a Timex/Sinclair 1000 and am looking for a good assembler. I've read several books but haven't been able to find any handy subroutines for the Z80 similar to those we used with the 6502. Can you make some recommendations for a Z80 assem-

bler and subroutines? Thanks for your help—I enjoy your column.
Jeff Kopmanis
Monroe, MI

Gladstone Electronics carries a complete line of accessories for the Timex/Sinclair 1000 computer. Included are several books on the internal workings of the Sinclair (ZX-81) ROM. Two such books are *Understanding Your ZX-81 ROM* by Dr. Logan and *The Explorers Guide to the ZX-81* by Mike Lord. Several utility programs, including an assembler, machine-code monitor, and disassembler, are also available. For further information, write or call Gladstone Electronics, 1585 Kenmore Ave., Buffalo, NY 14217, (800) 833-8400. Ask for a catalog and get on the company's mailing list. . . . Steve

Bulletin Boards

Dear Steve,

I have an Apple II Plus and a Micromodem at home, and I'd like to use them to get games from some of the bulletin boards. Can you direct me to a list of available bulletin boards and tell me how to communicate with them? Thank you.

Matt Wainwright
Brookfield, CT

Computer Shopper, a computer-oriented classified-ad newspaper, publishes a monthly listing of bulletin boards around the country. There are several in your state and many in surrounding states, so finding one to your liking should be easy. To access a bulletin board, it is only necessary to dial the telephone number and connect your modem when you hear the carrier signal. Some modems connect automatically. Usually, the Return key is hit once or twice, after which the system will ask you some questions about your equipment. This is necessary so that it can adapt to your particular equipment format. A

menu is then presented, and you can select your choice.

Some form of communications program is required so that your system can simulate a terminal. Some modems come with the required software. That is all that is required to enter the world of bulletin boards. . . . Steve

Kaypro Word Processing

Dear Steve,

I want to be able to edit documents that are about 200 single-spaced, typed pages (600K bytes) long on a Kaypro II or Kaypro 4. I'd guess that others who use similarly modest microcomputers for word processing might want to be able to edit documents that exceed both their machines' available RAM and the capacity of one floppy disk. Is there any economical and practical way of getting around the RAM and disk-memory limitations of many machines without recourse to the comparatively expensive solid-state disks or hard disks?

Perfect Writer, with its virtual-memory feature, would seem to offer one way around RAM limitations, but this doesn't solve the problems (e.g., in pagination and, therefore, in index creation) posed by a document too large to fit on one floppy disk. In addition, as configured for the Kaypro, Perfect Writer has a limited swap-file size (not useful for editing more than 20 pages), and the program for reconfiguring is not supplied in the Kaypro software package.

I'd appreciate your help in finding answers to the questions I've raised. I know of at least seven Kaypro owners who are also seeking answers to them.

David F. Austin
Amherst, MA

Practically speaking, there is no way short of a hard disk or RAM disk to handle 200 pages of text on your Kaypro. The computer must be able to read the complete data file in order to

operate on it, and this necessitates that it be on line as far as the program is concerned. Breaking the file into several smaller files is the recommended approach. . . . Steve

Video Displays

Dear Steve,

For some time now, I have been trying to acquire information on the possibility of providing an 80-column by 25-line black-and-white video display for a TI-99/4A computer used for word processing. This would avoid the horizontal scrolling now necessary.

Is it feasible to acquire an independent peripheral (monitor) that will provide this display? Would it operate through the RS-232C serial or parallel ports? Would such a unit be a combination of a stand-alone video board and a standard wide-band monitor? Could you suggest an available unit of modest cost? (Some of the suggestions have been for units that by themselves exceeded the total cost of our installation.)

Could you alternatively suggest a setup that, with our modest skills, we could put together? Would the CRT terminal outlined in chapter 9 of your book (Build Your Own Z-80 Computer) do the job? Thank you for your assistance.

Norman J. Spector
Englewood, FL

Obtaining an 80-column display on your TI-99/4A is not simply a matter of adding a wide-band monitor or terminal. The video-generation circuits in the computer itself must be modified along with the software. I have seen accessory boards for computers such as the Vic-20 that allow 80 columns, but they cost more than twice the price of the Vic. I am not aware of such a unit for your TI, but I would suspect that the cost will be rather high also. The electronics on such a card are quite sophisti-

cated and are not recommended as beginner projects.

The horizontal scrolling that you have with your word-processor program is a simple means to overcome a shortcoming of the computer. Remember that the character width was purposely reduced to allow the use of an ordinary television. If you add an 80-column card, you will also need a high-resolution monitor to display the additional characters. . . . Steve

Andromeda and CP/M

Dear Steve,

About two years ago, I purchased an Andromeda 16K-byte card for my Apple II, and it has been working fine with Applesoft and DOS ever since.

About a month ago I bought an Advanced Logic Systems (ALS) Z-Card with CP/M 2.2. The CP/M from ALS comes configured for 48K bytes of memory, and ALS supplies a utility program to reconfigure for 64K bytes. But no matter what I tried, my reconfigured CP/M would not operate.

I wrote letters to ALS and Andromeda asking them what was wrong. Andromeda replied that its card won't work with CP/M version 2.2. The company had heard of some people "patching" their boards to make it work but didn't know what changes were made. Andromeda suggested contacting a club or users group. I contacted A.P.P.L.E. but haven't had any luck yet.

Do you know how I can modify my Andromeda card to work with the CP/M 2.2?

Steve Nelson
Arlington, TX

An article in the August 1983 CALL A.P.P.L.E. may solve your problem. "Andromeda Ram-card Patch" by Jay H. Lieske describes the changes to CP/M BIOS (basic input/output system) required to utilize the Andromeda 16K-byte card with a 60K-byte version of CP/M. It may work

with your combination of CP/M and RAM cards. In any event, you can see what is necessary to activate the card. . . . Steve

TI-99/4A Compatibility

Dear Steve,

I own a Texas Instruments TI-99/4A computer and want to know if there are any circuits that will make it compatible with a Bell-103-type modem and/or a Heath/Zenith Z80 microcomputer. Thanks for the help.

Jacob E. Dockter
Bismarck, ND

Compatibility between your TI-99/4A and peripherals and modems is easily achieved through the use of the RS-232C serial port. This port is obtained with the Peripheral Expansion Interface. The ECM-103 ("Build the ECM-103, an Originate/Answer Modem," BYTE, March 1983, page 26) modem can be directly connected to this port and, since it is Bell-103-compatible, used to link up to The Source or other bulletin boards.

The Heath/Zenith microcomputer has a serial port for use with a terminal. . . . Steve ■

In "Ask BYTE," Steve Ciarcia answers questions on any area of microcomputing. The most representative questions received each month will be answered and published. Do you have a nagging problem? Send your inquiry to:
Ask BYTE
c/o Steve Ciarcia
POB 582
Glastonbury, CT
06033

Due to the high volume of inquiries, personal replies cannot be given. All letters and photographs become the property of Steve Ciarcia and cannot be returned. Be sure to include "Ask BYTE" in the address.

ORDER DESK ONLY
(800) 292-3360
 TOLL FREE IN CALIFORNIA

ORDER DESK ONLY
(800) 292-3360
 TOLL FREE OUTSIDE CALIF.

"WHY PAY MORE" COMPARE THESE PRICES MC-P APPLICATIONS BRINGS SOFTWARE & HARDWARE AT UNBEATABLE PRICES

SOFTWARE

	LIST	OUR
APPLIED SOFTWARE TECHNOLOGY		
VersaForm	\$389	\$269
ASHTON TATE		
Financial Planner	700	452
Friday	295	199
BPI ACCOUNTING SYSTEMS		
GL/AP/AR (Each)	395	285
CONTINENTAL		
Property Management	495	327
FOX & GELER Quick Code	295	174
FUNK SOFTWARE Sideways	60	45
HOWARD SOFT		
Real Estate Analyzer II Apple	199	135
Tax Preparer App.e	199	135
Apple	199	135
IBM	250	165
HUMAN SOFT DB Plus		89
LATTICE C Compiler	700	285
LIFETREE Volkswriter	195	129
METASOFT Benchmark	499	375
MICROSTUFF Crosstalk	195	129
MICROPRO Spell Star	250	162
Word Star w/Applicard	495	349
Mail Merge	250	162
Super Sort	250	149
Calc Star	145	86
Info Star	495	320
Report Star	350	221
MICROSOFT		
Flight Simulator (IBM)	50	35
Flight Simulator (Apple)		29
Multitool Word W/Mouse	475	339
Multitool Financial	100	69
Multitool Budget	150	99
Pascal Compiler	350	245
C Compiler	500	345
PBL CORPORATION		
Personal Investor	145	98
PETER NORTON		
Peter Norton Utility	80	57
PEACHTREE		
Peach Pack (AR, AP, GL)	595	239
Peach Text 5000	395	245
ROSESOF PROKEY	75	57
SOFTWARE ARTS T.K Solver	299	219
SOFTWARE DIMENSIONS		
Accounting Plus		
GL, AR, AP, PR, INV	495	295
SOFTWARE PUBLISHING		
Pfs:File	140	79
Pfs:Report	125	79
SATELLITE SOFTWARE		
Word Perfect	495	325
SOFTWARE PUBLISHING		
Pfs: File		
Apple	125	85
IBM	140	95
Pfs: Report	125	85
SOFTWARE SYSTEM		
Multimate	495	315
SORCIM SuperCalc II	295	185
SuperCalc III	395	275
SYNPSE File Manager	150	97

LOTUS 1-2-3

\$316⁰⁰

WORD STAR

\$275⁰⁰

DBASE II

\$379⁰⁰

EDIX/WORDIX

\$129⁰⁰

MULTIPLAN

\$168⁰⁰

HOME ACCOUNTANT

\$ 52⁰⁰

BANK STREET WRITER

\$ 46⁰⁰

TANDON TM1000-2

\$219⁰⁰

OKIDATA 92

\$479⁰⁰

AMDEK COLOR II

HI RES RGB

\$435⁰⁰

AST MEGA PLUS 64K

\$275⁰⁰

NOVATION J-CAT

\$105⁰⁰

EPSON FX 100

\$735⁰⁰

HERCULES GRAPHICS CD.

\$369⁰⁰

KOALA TOUCH PAD

\$ 95⁰⁰

WOLF Move-It	199	125
VISICORP		
Visicalc IV	250	175
Visifile (Apple)	250	187
Visifile (IBM)	300	195
VisiSchedule	300	195
VisiWord w/free VisiSpell	375	285
Visitrend/Plot	300	195

HARDWARE

	LIST	OUR
HAYES MICROCOMPUTER PRODUCTS		
Hayes Stack Chronograph (RS-232)	\$249	185
Hayes Stack Smart Modem (RS-232) 300 Baud	289	199
Smart Modem 1200B		
Smart Modem 1200	699	495
ADVANCED LOGIC SYSTEM (Apple II)		
Z-Card	169	115
Printer Mate (Parallel)	99	55
CP/M Card (W/ CP/M 3.0)	399	315
MICROSOFT		
Softcard (Apple)	345	259
Ram Card (Apple)	100	75
64K Ram Card (IBM)	350	249
MPC PERIPHERALS (Apple)		
Parallel Interface Card (w/Cable)	90	68
MOUSE SYSTEMS		
PC Mouse w/Software	295	218
NOVATION		
Apple - Cat II	389	275
212 Auto Cat	695	595
Smart-Cat 103/121	595	445
Smart-Cat 103	2429	187
PEGASUS		
Hard Disk 10 mgb		1439
PERSONAL COMPUTER PRODUCTS		
Applicard 6 Mhz	375	280
KRAFT & TG Joystick		
IBM	70	49
Apple	65	45
CDC DISK DRIVE		
VERBATIM DISC		
S/S D/D 10 Pk.	49	24
AMDEK MAI BOARD	599	495
ELECTRONICS PROTECTION DEVICES		
Orange	140	99
Peach	98	69
QUADRAM		
Quadboard 64K	395	295
Quadlink	680	525
MEMORY CHIP SET		
(64K/9 chips)	95	55
PRINTERS		
Mennesman Tally MT 160L	798	669
NEC 7730 RO Parallel	2595	2295
Daisy Writer 2000	1395	1185
Qume 1140	1685	1525
MONITORS		
Amdek 12" 310A	230	185
Quadchrome 17"	695	525
Princeton Graphics		
RGB Hi Res	795	495

**CALL FOR SOFTWARE
 & HARDWARE PRICES
 NOT LISTED HERE**

**INTERNATIONAL DEALER
 ENQUIRIES WELCOMED**

MC-P APPLICATIONS

111 W. St. John St., Suite 307

San Jose, CA 95113 Phone (408) 293-3360

Telex: 294207 MCPA UR

HOURS: 8 a.m. to 5:30 p.m. — Mon. - Sat.

TERMS: All prices subject to change. Cashier's check/MO/Bank Transfer. Allow time for company or personal checks to clear. Prices reflect cash prepaid discount. VISA/MASTER CARD/COD/PO's =3%. California residents add sales tax. **SHIPPING:** \$4 per item for UPS surface (\$8 for Blue Label); Monitors \$20, Printers \$25, within continental USA.

Byte Book Club™

DATABASE DESIGN. By G. Wiederhold. 2nd Ed., 704 pp. The expanded second edition of this widely acclaimed book presents the methods, the criteria for choices between alternatives, and the principles and concepts that are relevant to the practice of database design.

701/326B \$32.00
(Counts as 2 of your 3 books)

MICROCOMPUTER GRAPHICS AND PROGRAMMING TECHNIQUES. By H. Katzan, Jr. 240 pp., 100 illus. and tables. Here's a stimulating introduction to computer graphics for small computers. It covers all the advances to date in color coding and computer graphics technology and—best of all—it's written for information professionals who can't draw! Includes actual graphics programs worth hundreds of dollars!

582576-7 \$22.50

COMPUTER PERIPHERALS FOR MINICOMPUTERS, MICROPROCESSORS, AND PERSONAL COMPUTERS. By C. L. Hohenstein. 294/518 \$23.95

A PROGRAMMER'S VIEW OF THE INTEL 432 SYSTEM. By E. Organick. 418 pp., 75 illus. Really two books in one—an introduction to a powerful new computing tool and a practical guide to its many uses! Targeted at persons familiar with programming in Ada or Pascal, the book examines the i432's operating system, architecture, and language.

477/191B \$29.95
(Counts as 2 of your 3 books)

PROGRAMMING WITH ADA: An Introduction By Means of Graded Examples. By P. Wegner. 789/24X \$19.95

OPERATING SYSTEMS. By H. Lorin & H. M. Dietel. 582354-3B \$25.95
(Counts as 2 of your 3 books)

MINICOMPUTER AND MICROPROCESSOR INTERFACING. By J. C. Cluley. 266 pp., 73 illus. and tables. Unless you are content to have your information processing system simply talk to itself, you need the intense coverage of interfacing provided so brilliantly by this compact volume. In addition to discussing the logical design of interfaces assembled from small-scale integrated circuits, the book gives you a lucid picture of the interface packages designed for microprocessor systems and the way in which they are used.

582585-6B \$27.50
(Counts as 2 of your 3 books)

AN INTRODUCTION TO VISICALC® MATRIXING FOR APPLE® AND IBM®. By H. Anbarlian. 252 pp., illus., softcover. Enables you to use VisiCalc matrices—also known as templates and models—to put your Apple or IBM personal computer to productive use almost immediately. It describes the actual process of developing matrices for such applications as expense vouchers, price/earnings ratios, payrolls, stock portfolios, and more.

016/054 \$22.95

ASSEMBLERS, COMPILERS, AND PROGRAM TRANSLATION. By P. Calingaert. 582110-9B \$25.95
(Counts as 2 of your 3 books)

INTERFACE PROJECTS FOR THE TRS-80. By R. C. Hallgren. 582466-3 \$18.95

POWERFUL TOOLS! POWERFUL SAVINGS!

New Members take any **\$1.00**
3 books for only **each***
Values up to **\$79.90**

APPLE PASCAL GAMES. By D. Herget & J. T. Kalash. 582521-X \$19.95

MATHEMATICS FOR THE ANALYSIS OF ALGORITHMS. By D. H. Greene and D. E. Knuth. 107 pp. Gives you a clear picture of both the structure and the power of algorithms—and their intimate relationship to the world of the computer programmer.

582707-7 \$10.00

MICROPROCESSOR APPLICATIONS HANDBOOK. Edited by D. F. Stout. 472 pp., 284 illus. This BIG book on SMALL chips will help you make your systems timely, versatile, and cost-effective. The 16 expert contributors provide in-depth treatments of both hardware and software so you can completely analyze, design, construct, and program.

617/988B \$39.95
(Counts as 2 of your 3 books)

REAL-TIME COMPUTING With Applications to Data Acquisition and Control. Edited by D. A. Mellichamp. 552 pp., 260 illus. This comprehensive guide helps you specify the type of real-time computing system you need, start it up, and keep it running smoothly and productively.

582844-8B \$39.50
(Counts as 2 or your 3 books)

GUIDE TO THE IBM PERSONAL COMPUTER: Features DOS 2.0 and BASIC 2.0 for the IBM PC and XT. By W. Sikonowiz. 352 pp., illus. Going far beyond the manufacturer's manuals, this guide gives you the invaluable hands-on experience necessary to make the most of your machine.

574/847 \$19.95

LEARNING WITH LOGO. By D. H. Watt. 685/703 \$14.95

COMPUTER GRAPHICS: A Programming Approach. By S. Harrington. 448 pp., 242 illus. Covering everything from viewing transformations, parallel projections, and perspective projection to line removal, shading, and the drawing of curves, this introduction to interactive graphics gives you hands-on experience.

267/510B \$25.95
(Counts as 2 of your 3 books)

THE BUSINESS GUIDE TO SMALL COMPUTERS. By L. Calmus. 096/627 \$19.95

INTRODUCTION TO THE UCSD p-SYSTEM™. By C. W. Grant and J. Butah. 330 pp., illus. This book takes you through the whole process of implementing the UCSD p-System—and gives you hands-on programming experience in Pascal.

582767-0 \$24.95

MICROPROCESSOR AND MICROCOMPUTER DATA DIGEST. By W. H. Buchsbaum and G. Weissenberg. 336 pp., 199 diagrams. Containing all the detailed technical data for every microprocessor integrated circuit that is currently listed as a "standard," off-the-shelf item, this book presents the critical pin configurations, voltages, operating parameters, descriptions of each IC.

582835-9B \$29.95
(Counts as 2 of your 3 books)

ELECTRONICS DICTIONARY, 4/e. By J. Markus. 404/313B \$32.95
(Counts as 2 of your 3 books)

MICROPROCESSOR DATA BOOK. By S. A. Money. 350 pp., 220 illus. A truly awesome collection of data about virtually every chip available today!

427/062B \$42.50
(Counts as 2 of your 3 books)

ANNOUNCING: The Most Important Computer Handbook Ever Published!



**This Remarkable
New Reference
—a \$79.50 value—
Is Yours for only
\$3.00**

The McGRAW-HILL COMPUTER HANDBOOK, 992 pp., 475 illus., edited by Harry L. Helms, with over 24 world-reknown contributors, is by far the most useful and comprehensive reference yet designed for today's computer user. Cramped with easy to get at information, ranging from design concepts to programming techniques, from data bases to interfacing, networking, speech synthesis and recognition to mention just a few of hundreds of entries, this one volume reference does it all—in language and presentation everyone can understand. Invaluable for home, office, and school use. The Computer Handbook "can be helpful to users in solving many mysteries, while opening new doors for exploration and serving as a continuing reference," writes Thomas C. Bartee of Harvard University.

279/721A \$79.50
(Counts as 3 of your 3 books)

*** 3 books for only \$1.00 each . . . if you join now for a trial period and agree to purchase three more books—at handsome discounts—during your first year of membership. (Publishers' prices shown)**

MICROPROCESSOR-BASED ELECTRONIC GAMES: Design, Programming, and Troubleshooting. By W. Buchsbaum and R. Mauro. 293 pp., illus., softcover. Turn your TV into a home arcade with the first technical guide dedicated to fun!
087/229 \$9.95

STRUCTURED PROGRAMMING: Theory and Practice By R. C. Linger, H. D. Mills & B. I. Witt
788/537B \$26.95
(Counts as 2 of your 3 books)

THE SMALL COMPUTER CONNECTION: Networks for the Home and Office. By N. L. Shapiro. 256 pp. Shows you how to use existing hardware and software to link your small computer to other computers—large and small—and to a vast universe of databases.
564/124 \$15.95

ELECTRONICS ENGINEERS' HANDBOOK, 2/e By D. G. Fink & D. Christiansen
209/812A \$79.90
(Counts as 3 of your 3 books)

Z80 USERS MANUAL. By J. Carr. 326 pp., with diagrams, charts, and tables. Takes you through every opportunity the ZAP can offer! It covers Z80 pin definitions, CPU control signals, support chips, interfacing peripherals, and much more.
582336-5 \$21.95

INTRODUCING THE UNIX SYSTEM. By H. McGilton & R. Morgan. 256 pp., 50 illus., soft. This book helps you over the initial hurdles of learning this new and powerful computertool—even if you have never used the Unix system or penetrated any of its literature.
450/013 \$18.95

HANDS-ON BASIC For the IBM® Personal Computer By H. Peckham. 308 pp., spiral-bound, softcover. Learn BASIC programming right at the computer! Step by step, this manual gives you hands-on experience with BASIC through a series of guided activities. Each of the 12 chapters requires at least one hour at the computer and at least one hour studying the text.
491/78X \$19.95

HANDS-ON BASIC FOR THE Atari 400/800/12XL By H. Peckham
491/941 \$19.95

THE C PRIMER. By L. Hancock & M. Kreider. 256 pp., 25 illus., soft-bound. This is the only book on the market that describes the C language clearly and simply from the novice's point of view.
259/81X \$14.95

MICROCOMPUTER INTERFACING By B. Artwick
789/436B \$28.00
(Counts as 2 of your 3 books)

APPLE PASCAL: A Hands-On Approach. By A. Luehrmann and H. Peckham. 426 pp., spiralbound. Finally—a how-to-use-PASCAL book for Apple computer users that makes a complete language as easy as (forgive us!) applesauce. Takes you from "total ignorance" all the way up to a very impressive competence in the use of that rather complex language, PASCAL.
491/712 \$19.95

PRINCIPLES OF INTERACTIVE COMPUTER GRAPHICS. By W. M. Newman and R. Sproull. 2nd Ed., 544 pp., illus. Now in a revised, updated Second Edition, this volume has long been THE standard source of information for designers! Now, as before, it is utterly comprehensive and up to the minute in its coverage.
463/387B \$32.50
(Counts as 2 of your 3 books)

Consider these Byte Books as well!

MICROCOMPUTER OPERATING SYSTEMS By M. Dahmke
150/710 \$16.95

TRS-80 GRAPHICS FOR THE MODEL I AND MODEL III By D. Kater & S. Thomas
333/033 \$14.95

THREADED INTERPRETIVE LANGUAGES By R. G. Loeliger
383/60X \$20.75

THE BRAINS OF MEN AND MACHINES By E. W. Kent
341/230 \$20.95

BASIC SCIENTIFIC SUBROUTINES, Vol. II By Dr. F. R. Ruckdeschel
542/023B \$26.95
(Counts as 2 of your 3 books)

CIARCIA'S CIRCUIT CELLAR, Vol. 2 By S. Ciarcia
109/63X \$15.95

BYTE BOOK OF PASCAL By B. W. Liffick
789/673B \$27.50
(Counts as 2 of your 3 books)

BASIC SCIENTIFIC SUBROUTINES, Vol. I By Dr. F. R. Ruckdeschel
542/015B \$27.95
(Counts as 2 of your 3 books)

CIARCIA'S CIRCUIT CELLAR, Vol. III By S. Ciarcia
109/656 \$15.95

MICROCOMPUTER DISK TECHNIQUES By P. Swanson
625/824 \$15.95

BUILD YOUR OWN Z-80 COMPUTER By S. Ciarcia
109/621 \$18.95

Why YOU should join the Byte Book Club™ now!

- **Best and newest books from ALL publishers!** Books are selected from a wide range of publishers by expert editors and consultants to give you continuing access to the best and latest books in your field.
- **Big savings!** Build your library and save money too! Savings range up to 30% or more off publishers' list prices—usually 20% to 25%.
- **Bonus books!** You will immediately begin to participate in our Bonus Book Plan that allows you savings up to 70% off the publishers' prices of many professional and general interest books!
- **Convenience!** 14-16 times a year (about once every 3-4 weeks) you receive the Club Bulletin FREE. It fully describes the Main Selection

and alternate selections. A dated Reply Card is included. If you want the Main Selection, you simply do nothing—it will be shipped automatically. If you want an alternate selection—or no book at all—you simply indicate it on the Reply Card and return it by the date specified. You will have at least 10 days to decide. If, because of late delivery of the Bulletin you receive a Main Selection you do not want, you may return it for credit at the Club's expense.

As a Club member you agree only to the purchase of three additional books during your first year of membership. Membership may be discontinued by either you or the Club at any time after you have purchased the three additional books.



Fill out the card and mail today! If the card is missing, write to:

BYTE BOOK CLUB™, P.O. Box 582, Hightstown, New Jersey 08520

Software Received

Apple

Braille-Edit, a word-processing program for blind and sighted persons to perform text-editing operations using voice, screen, or a braille computer terminal. It is designed to work with many braille and voice devices, enabling the user to write, edit, correct, and print out formatted letters, reports, and papers using braille- or print-oriented text files. Includes audio and Versabrillette tapes. For II Plus or IIe; floppy disk, \$300. Raised Dot Computing, 310 South 7th St., Lewisburg, PA 17837.

Computer Calculator, a calculator program. Turn your computer into an algebraic and Reverse Polish Notation (RPN) calculator. Features include automatic conversions and balancing, calculations in decimal, hexadecimal, and binary, and user-defined functions. For the II Plus; floppy disk, \$19.95. Jim's Software, 384 The Great Road, Bedford, MA 01730.

Cubit, a three-dimensional strategy game in which you must change the color of cubes by jumping on them. Beware of bouncing balls, disguised snakes, and vicious gremlins who get in your way. For the II; floppy disk, \$39.95. Micromax Systems Inc., 6868 Nancy Ridge Dr., San Diego, CA 92121.

Fastform, a business program that lets you create business forms, fill out standardized forms, and perform numerical calculations. You can save all data on disk. For II Plus and IIe; floppy disk, \$34.95. User-Friendly Software, 3204 National Parks Highway, Carlsbad, NM 88220.

Finance & Amortization, a business program for banking and financial companies to calculate amortization schedules for loans, leases, and savings accounts. Features include investment-decision and loan-analysis capabilities. For II Plus and IIe; floppy disk, \$29.95. User-Friendly Software (see address above).

Fortress of the Witch King, a fantasy game. Your quest is to slay the ruler of the fortress and gain power through the orb, scepter, and crown. Your band of warriors is constantly in danger of the Witch King's warriors or the vicious hacker who want what you have gained. For II, II Plus, and IIe; floppy disk, \$25. Avalon Hill Game Co., 4517 Harford Rd., Baltimore, MD 21214.

The Graphics Magician, a programmer's tool that assists in the layout and design of homemade arcade games and high-resolution graphics programs. These new versions of the graphics editor and machine-language routines let you design shapes and their paths and assemble and control animations with your own programs. For the updated version, send your old disk and \$15 to Penguin Software. For the II; floppy disk, \$59.95. Penguin Software, 830 4th Ave., Geneva, IL 60134.

Introduction to BASIC Programming, a training and utility package. This four-disk series teaches computer literacy while training the student in BASIC programming. A quiz module in each lesson is scored automatically and evaluated by the computer. For II Plus and IIe; floppy disks, \$149.95. Orion Training Systems, POB 94, Dallastown, PA 17313.

Job Cost III, a business program that lets you keep track of 350 items of cost and quantity totals. Headings can be entered for 35 categories and 10 subcategories for cost-to-date figures. Additional categories keep track of subcontracts, overhead figures, cash advances, loans, or final payments without figuring in the cost-to-date figures. For the II Plus; floppy disk, \$34.95. User-Friendly Software (see address above).

Magicalc, an electronic spreadsheet program. You can create, manipulate, modify, and print reports that include such calculations as financial statements, budgets, cost estimates, sales forecasts, staffing plans, and development and product schedules. For II and IIe; floppy disk, \$149.95. Artsci, 5547 Satsuma Ave., North Hollywood, CA 91601.

Matrix Utility, a matrix-manipulation program that computes eigenvalues, inverses, determinants, characteristic polynomials, and ranks of a matrix. It also solves linear and polynomial equations. Programming experience is not necessary to operate program. For the II; floppy disk, \$34.95. Wesware, 2349 Fir, Glenview, IL 60025.

Miko tekst, a word-processing package. You can edit letters or memos; chart your own chapters, index, or table of contents; and print, format, or delete files. Documentation accompanies four disks: text, help, letter, and DOC. For II and IIe; floppy disks, \$190. Tomi Data, Kirkerudkleiva 4, 1313 Vøyenenga, Norway.

Minit Man, a trilevel arcade-type game. Waves of robots

have already destroyed the bridge, and your missiles are on the other side. Your job is to rebuild the bridge while simultaneously defending your building complex that houses the computer. Requires a joystick. For the II; floppy disk, \$19.95. Penguin Software (see address above).

Monthly Accounting, an accounts-management program that handles up to 100 expense and income accounts for business and home purposes. Monthly transactions can add up to six-digit quantities ranging from mortgage payments to gas mileage. For II Plus and IIe; floppy disk, \$19.99. Softcell, 13 Webster Ave., Hanover, NH 03755.

Net-Works II, an electronic bulletin-board program for home or business uses. This program automatically answers and records phone calls. It enables users to send messages to individuals, distribute memos, and use as a 24-hour-a-day message center. For the II; floppy disk, \$99. High Technology Software Products Inc., POB 60406, 1611 Northwest 23rd, Oklahoma City, OK 73146.

PTD-6502/6510 Debugger, an assembly-language utility. This program enables the user to write, modify, and debug games and utilities using BASIC editing features. Includes an 80-page tutorial manual. For the IIe; floppy disk, \$50. Pterodactyl Software, 200 Bolinas Rd. #27, Fairfax, CA 94930.

The Scrambler, a disk protection/password system. This program lets you check disks for errors, copy-protect your disks by using a password system, and create a scrambled data disk that can

Software Received

be stored. It will verify disks in 12 seconds. For II Plus and IIe; floppy disk, \$28.95. Jagware, 127 Albany Ave. SE, Orange City, IA 51041.

The Spy Strikes Back, a high-resolution graphics game in which you must locate Dr. X's terrorist operation. Reports reveal that each of the five floors in his hideaway is divided into 24 guarded sections, containing 16 rooms. The object is to get through these rooms without being seen or getting caught. For the II; floppy disk, \$19.95. Penguin Software (see address above).

Stockfile, a stock-control program for smaller businesses. You can store up to 1000 stock lines on one disk. Using extra disks, up to 30,000 stock lines can be created, viewed, updated, corrected, or printed. It automatically calculates stock values. For II and IIe; floppy disk, \$95. Felix Software, 19 Leighton Ave., Pinner HA5 3BW, England.

Super Disk Labeller, a machine-language utility package. Prepare and print floppy-disk labels that organize your disks into a library. This program allows use of a variety of printers using the printer configuration mode and lets you print labels of almost any size with the label-options mode. Requires Applesoft in ROM. For II, II Plus, and IIe; floppy disk, \$34.95. Lakefront Software, 7754 Balboa Blvd., Van Nuys, CA 91406.

Talk-U-Thru Wordstar, a step-by-step tutorial program to teach the functions of Wordstar. This program features an introduction to CP/M, Wordstar installation, cursor moves, text moves, deleting and inserting text, on-screen formatting, file-man-

agement techniques, and a variety of other functions. Includes audiocassettes covering installation, cursor moves, and formatting and printing. For II, II Plus, IIe, and III; floppy disk, \$49.95. Talk-U-Thru Tutorial Systems, 6519 Fountain Ave., Los Angeles, CA 90028.

Teacher's Pet, a report-card program that can keep track of an unlimited number of students ranging from elementary to high school. Up to 800 objectives can be placed on the master disk, which already contains about 700 standard objectives. For II Plus and IIe; floppy disk, \$300. Softcell (see address above).

Atari

Computer Football Strategy, a football-simulation game similar to the board game. Pit your strategic skills against the computer or a live opponent as you call both offense and defense plays. Many formations to choose from as the game clock ticks away. For 400/800; cassette, \$16. Avalon Hill Game Co., 4517 Harford Rd., Baltimore, MD 21214.

The Arcade Machine, a game-creation program. Develop your own animated creatures, spaceships, aliens, tanks, monsters, or other objects to move over a variety of backgrounds. Include such sounds as explosions, musical tones, and other sound effects as you design your own arcade games. For 400/800 and the XL series; floppy disk, \$59.95. Broderbund Software Inc., 17 Paul Dr., San Rafael, CA 94903.

B/Graph, a professional graphics-charting and statistical-analysis program. You can assemble, process, and

display complex, extensive numerical data in graphic form with this comprehensive, two-disk package. For 400/800; floppy disk, \$99. In-home Software Inc., Unit 8, 2485 Dunwin Dr., Mississauga, Ontario L5L 1T1, Canada.

CP/M

Billchecker, a personal financial program that runs CP/M 2.2. This lets you handle check writing and bill paying. When you categorize bills due, their dates due are automatically updated. Checkbook will hold up to 200 transactions with six-digit numerals using double precision. Floppy disk, \$39.95. Extal Alstar Inc., POB 850, Rome, NY 13440.

CP/M.D., a utility program that diagnoses and cures ailments of CP/M disks. Menu-driven functions and a variety of commands recover files from bad disks, locate and lock out bad sectors, and translate decimal numbers to hexadecimal and binary codes. Floppy disk, \$29.95. Teleprint Inc., Simpl-Simon Software, POB 10, Sylvania, GA 30467.

Magic/L, a general-purpose interactive language. Applications include mailing-list, hardware diagnostics, debugging routines, an image-processing system, database query system, a turnkey process-control system, and a cross-assembler program. Floppy disk, \$295. Loki Engineering Inc., 55 Wheeler St., Cambridge, MA 02138.

Menu, a utility package that automatically sorts disk files using number codes without typing filenames. You select numbers and Menu handles functions such as copy, re-

name, erase, type, restore, compare, and more. You can secure sensitive disk files with password protection and explore the internal system while programming. Floppy disk, \$149. Computing, 2519 Greenwich St., San Francisco, CA 94123.

Real-Time C, a utility program that provides users of Whitesmiths' C compiler with an alternate run-time library suitable for real-time programming. The library consists of approximately 100 modules combined into two library files. Features include command-line parsing and error handling accessible to the application programmer. Floppy disk, \$95. Kadak Products Ltd., 206-1847 West Broadway Ave., Vancouver, British Columbia V6J 1Y5, Canada.

SAL/80, a utility compiler and language program. This program lets you maintain and reduce development and debugging time, and test branch code. It includes a complete set of console input/output primitives that perform case and base conversion, byte, word and string input/output through standard system calls and provide data manipulation using arithmetic functions. Floppy disk, \$59. Protocols, 24225 Summerhill Ave., Los Altos, CA 94022.

Text Addresser, a word-processing package that runs CP/M 2.2. A categorized address book automatically addresses letters. You can edit, move text, center text, and print. Floppy disk, \$39.95. Extal Alstar Inc. (see address above).

Commodore

Casual Writer, a word-processing program. You can write letters and lists, print

Software Received

club bulletins, and store information on tape. For the 64; cassette, \$29. E.N. Publications, RD 1, Box V, Worden, IL 62097.

Design-a-Quilt, a graphic-design program that can design more than 450 million quilt patterns. You key in a value for colors, blocks, and patches per block for a symmetric arrangement of quilt patterns. For the VIC-20; cassette, \$29.95. Don's Designs, 1728 Womer, Wichita, KS 67203.

The Home Budget Ledger, a home-accounting program. This electronic checkbook and budget planner lets you set up spending categories to format as general ledger pages. It shows check numbers and descriptions, debits, credits, and balances. It also features routines to track checks, noncheck transactions, and disk backup. For the 64; floppy disk, \$24.95. Harpware—Software and Computers, POB 760954, Dallas, TX 75376-0954.

Intermediate Language and Math, a five-program educational package for ages 10 through 12. Program titles include Nouns and Verbs, Adjectives and Adverbs, Rocket Launch, Add Speed, and Math Squares. For the 64; cassette, \$34.95 for all five

programs or \$9.95 each. Banned Software, 113 Tenth St., West Keansburg, NJ 07734.

PTD—6502/6510 Debugger, an assembly-language utility (see description under Apple). For the 64; floppy disk, \$30. Pterodactyl Software, 200 Bolinas Rd. #27, Fairfax, CA 94930.

IBM Personal Computer

Codewriter, a utility program that lets businesspeople design their own programs without computer programming experience. Possible applications include payables and receivables, sales analyses, customer and personnel files, mailing lists, invoicing, and inventory tracking. Floppy disk, \$399. Dynatech Microsoftware Inc., 7847 North Caldwell Ave., Niles, IL 60648.

Empire, a global-conflict simulation game. You must annihilate other armies on a large map to gain total domination of the world. Requires strategic concentration. Floppy disk, \$40. Northwest Software, 15343 Southeast 43 Place, Bellevue, WA 98006.

Fast File, an applications-generator program designed for novice users to design their own application programs. This program can be used to create automated systems such as inventory, accounting, mass mailing, and other data-tracking systems. You can manipulate data, design reports, and generate labels. Includes security-protection features. Floppy disk, \$695. ICCS, 7777 Leesburg Pike, Falls Church, VA 22043.

Fixed Asset Manager, a financial-scheduling tool. Two depreciation schedules and various assets can be cataloged for business and personal uses. Features include standard depreciation methods, assets classified by location or type, extensive inquiry, and exception reporting. Floppy disk, \$150. Softrend, POB 1462, Charlottesville, VA 22902.

The Itemizer, a financial-record-keeping program. This program lets you define up to 90 categories which can be printed, saved in a file, or displayed on the screen in summary and detail form. Floppy disk, \$39.95. People Literate Software, POB 2039, Bozeman, MT 59715.

Manager Program Collection, an integrated scheduling and financial-planning system that contains three programs. Task Manager provides daily schedule control and a job-expense accounting system. Records Manager offers a client- and associate-information filing system. Project Manager is a project-planning and resource-analysis system. Floppy disks, \$499. Datamension Corp., 615 Academy Dr., Northbrook, IL 60062.

The Real Estate Consultant, an investment-analysis package. This package assists in comparing real estate investment yields against alternative investment potentials such as individual ownership vs. partners, rent-or-buy decisions, tax status vs. new tax shelters, and timing a sale vs. holding. Floppy disk, \$275. Consultant Systems Inc., Suite #311, 3704 State St., Santa Barbara, CA 93105.

Samna Word II, a word-processing business package. You can write, edit, and review any document with flexibility. This program also supports multiple window operations, a fold feature for wide columnar documents, floating footnotes, and a zoom feature that lets you see page makeup. Floppy disks, \$450. Samna Corp., Suite

Graphics for the IBMpc, Apple, Z-100

This is a spectacular collection of programs in BASIC for 2D and 3D graphics. They form a complete self-teaching guide that will show you how to write graphics software quickly and easily.

The programs are listed in a book beside full documentation. They show how to use basic plotting commands, create 2D and 3D shapes, translate, rotate, scale, stretch, remove hidden lines, shade, clip, window, draw perspective views, use hi-speed animation for simulation, games.

"If you have the slightest interest in graphics I recommend the book"
— Programmer Magazine

Book—\$30.50 Disk—\$21.50 (specify IBM, Apple Z-100)



C-1200, 2700 Northeast Expressway, Atlanta, GA 30345.

Set-FX, a printer-control program. Designed to fully utilize the Epson FX, this program can let you print the full IBM character set including line graphics, foreign languages, and math and science symbols. You can also create custom fonts for special effects, set modes for variety, and employ ideas the program provides. Floppy disk, \$59.95. Softstyle Inc., Suite 200, Department B12, 7192 Kalaniana'ole Highway, Honolulu, HI 96825.

Super Chartman II, a business-graphics-presentation program. Up to six graphs and charts can be displayed on one page, and stored data can be transferred from one graphic format to one of 20 others. This program is menu- and input-form-driven; the manual is designed for the nontechnical user. Floppy disk, \$425. Graphic Software Inc., 1972 Massachusetts Ave., Cambridge, MA 02140.

Time Value of Money, an investment problem-solving tool. Make financial decisions based on analyses of compound interest, mortgage, annuity, and gradient. Create investment and payment schedules, merge these

with reports, and file for future reference. Floppy disk, \$39.95. People Literate Software (see address above).

Type & Learn, a typing-instruction program. Learn how to type while you learn about computers by matching computer terms, definitions, and paragraphs of computer information. This program calculates your score, accuracy percentage, and words-per-minute speed. The progress of your typing skills is reported. Floppy disk, \$60. Simsoft Inc., POB 7095, Port Huron, MI 48301.

Type-Righter, a typing-tutor program. Both novice and beginning users can develop speed and accuracy in typing. Color and graphics are used to highlight keys and reinforce the lessons. Floppy disk, \$19. Martin Oakes, 2100 Oriole Dr., Freeport, IL 61032.

Universal Loan Planner, a loan-planning utility program. You can plan the terms of a loan and the printing of an amortization schedule. Features also include calculation of minimum payment, interest rates, amortization periods, and the maximum amount you can borrow. Floppy disk, \$59.95. Andy's Software, Group 1, Box 44,

RR 6, Bowmanville, Ontario L1C 3K7, Canada.

Util, a utility package to manipulate ASCII data files. Programmers can use these filter functions to provide flexibility in command lists processed by the batch-command processor. Floppy disk, \$30. John R. Hind, 4100 Pickwick Dr., Raleigh, NC 27612.

WS-Patch, a utility package to enhance your printer's power using Wordstar. This program patches special information into programs to enable special printer functions. It amends the print-control menu to reflect letter-quality printing such as bold-face, italics, superscripts, and subscripts. Floppy disk, \$49.95. CMB3 Enterprises, POB 3061, Walnut Creek, CA 95498.

Cypho.bas, an interactive program that performs cryptographic algorithms on alphabetic text. The program encrypts or decrypts data entered from the console or in a disk file, and sends the resulting data to the disk file. Floppy disk, \$10. Graven Imagery, Apt. 111, 50 Walmer Rd., Toronto, Ontario M5R 2X4, Canada.

Magic, an investment-analysis program. Enter the values for up to 15 investments based on daily, weekly, or monthly data, and Magic provides 6 moving averages and 12 ratios of moving averages for relative strength and momentum oscillators. You can compute averages for different time periods. Floppy disk, \$49.95. Sware Tools for Investors, POB 645, San Luis Rey, CA 92068.

TRS-80

Autoplot, a graphics program that automatically plots curves in color. Choose from among line graphs, scatter plots, and bar graphs plotted from mathematical functions or tabulated data. Axes are automatically scaled and labeled. For the Model 100; cassette, \$39.50. Menlo Systems, Suite 221, 3790 El Camino Real, Palo Alto, CA 94306.

Osborne 1

Animate, a graphics and animation-processor program. Using ASCII and graphics characters you can create pictures on the screen to edit, save, print, combine, and display. Floppy disk, \$30. Softborne Software, 1217 Hawthorne Lane, Fort Washington, PA 19034.

Statistics for the IBMpc, Apple, Z-100

This is a book/disk package of programs in BASIC for the application of statistics to business, science and engineering. Emphasis is on understanding statistics and using micros for the quick solution of real-life problems.

Programs are included for statistical distributions, histograms, sorting, smoothing, mean, standard deviation, errors, sampling, estimations, reliability, confidence intervals, linear and multilinear regression, curve fitting, correlation, time series and forecasting. Also numerous case studies. Takes the mystery out of statistics! **Book-** \$36 **Disk-** \$26 (specify IBMpc, Apple, Z-100)

KERN PUBLICATIONS - Call for faster delivery
433 Washington St. PO Box 1029, Duxbury, MA 02331 (617)934-0445

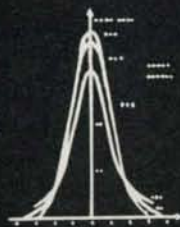

SOFTWARE

Software Received

Brainstormer, a universal problem-solving program. You can generate potential solutions to complex problems with a structure technique for describing problems in strategy selection, idea generating, and solution implementation. Applications include increasing flexible thinking, discovering new products, identifying new markets, and exploring personal or organizational problems. For the Model III; floppy disk, \$50. Soft Path Systems, c/o Cheshire House, 105 North Adams, Eugene, OR 97402.

Dyfin, a personal financing program. Make financial decisions on loans, savings, investments, and retirements. This program can calculate monthly payments or returns and balance a checkbook. A 500-year calendar feature includes a monthly

display. For the Color Computer; cassette, \$19.95. Dynamic Electronics Inc., POB 896, Hartselle, AL 35640.

Maze Runner, a maze-type game. Create your own mazes or play the maze games already on disk. Test your skill and speed as the maze constantly changes. For the Models III and 4; floppy disk, \$9.95. Point Video Products, Box 34, 2005 A St., Garden City, KS 67846.

Options 80A, a stock-option analyzing program. Investors can maximize stock-market yields, plot returns against actuals, and print graphs alphanumerically. This version includes Black-Scholes modeling and put-option spreads. For Models I and III; floppy disk, \$170. Options-80, POB 471, Concord, MA 01742.

Paintpot, an extended BASIC educational program for all ages. Four-color graphics can be sketched using arrow keys, a joystick, or mouse; colors are selected from an on-screen palette. Four screens can be stored at once. For the Color Computer; cassette and disk, \$20 and \$25, respectively. Tim Skene, 6073 Durocher Ave., Montreal, Quebec H2V 3Y1, Canada.

Scribe, a word-processing program. In addition to editing text files, you can print letters and reports in finished forms using a dot-matrix printer. For the Model 100; cassette, \$24.95. Chattanooga Systems Associates, POB 22261, Chattanooga, TN 27421.

Texas Instruments 99/4A

Dow Editor/Assembler, a utility package that provides the ability to program in assembly language, save on cassette, restore the program from cassette, and display the program on the monitor. Cassette, \$25. John T. Dow, 6360 Caton, Pittsburgh, PA 15217.

Wild Woods, an arcade-type game. After you are dropped from an airplane, you must fire your flamethrower to reach land safely and to forge

through a dense forest in search of treasures. Avoid the rushing river, incoming tide, and the search plane. Cassette, \$11.95. JW Software, 814 West Main St., Urbana, IL 61801.

Wycove Forth, a programming-language program. Gain high-speed programming and control of the computer using printer access, sound, sprites, a graphics mode, text mode, and bit-map graphics-mode displays. Floppy disk with cassette, \$50. Wycove Systems Ltd., POB 1105, Dartmouth, Nova Scotia B2Y 4B8, Canada.

T/S1000 and ZX81

The Fantastic Music Machine and Light Show, a two-part program. Music Composer transforms the keyboard into a three-octave musical instrument that plays through a radio. Light Show animates random kaleidoscopic patterns or lets you create your own designs. Cassette, \$9.95. Simulusion, Box 894, Lemon Grove, CA 92045.

Party Nibbles and Bites, a fast-recipe program. A dozen party recipes instantly appear when you select from the menu of choices. Cassette, \$9.95. Simulusion (see address above). ■

Peripheral Networking Now

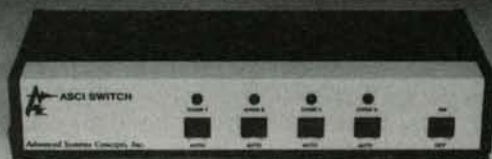

Buy ASCII Intelligent Port Expanders

- Eliminate Manual Switching by Remote Control
- Improve Productivity and Reliability
- Share Printers, Modems or Plotters
- Expand Computers or Terminals
- Use Matrix Switching for Multiple Transmission or Security
- Supports Polling and Queuing

INSTANT COMPATIBILITY with new computer devices and MAJOR OEM PRODUCTS:

Altos — Burroughs — Data General — DEC
H.P. — IBM — NCR — Northstar — Victor
and other key manufacturers.

Call 213-793-8979 to EXPAND YOUR SYSTEMS TODAY.



Advanced Systems Concepts Inc.
435 N. Lake Ave., Dept. B1
Pasadena, CA 91101
800-824-7080 Telex: 701 215

This is a list of software packages that have been received by BYTE Publications during the past month. The list is correct to the best of our knowledge, but it is not meant to be a full description of the product or the forms in which the product is available. In particular, some packages may be sold for several machines or in both cassette and floppy-disk format; the product listed here is the version received by BYTE Publications.

This is an all-inclusive list that makes no comment on the quality or usefulness of the software listed. We regret that we cannot review every software package we receive. Instead, this list is meant to be a monthly acknowledgment of these packages and the companies that sent them. All software received is considered to be on loan to BYTE and is returned to the manufacturer after a set period of time. Companies sending software packages should be sure to include the list price of the packages and (where appropriate) the alternate forms in which they are available.

Event Queue

January 1984

January

Courses from Q. E. D. Information Sciences, various sites throughout the U.S. Scheduled courses include "Cost-Benefit Analysis," "Leadership: Managing and Influencing People," and "Designing Systems Controls." Address inquiries to Q. E. D. Information Sciences Inc., Q. E. D. Plaza, POB 181, Wellesley, MA 02181, (800) 343-4848; in Massachusetts, (617) 237-5656.

January-February

Fundamentals of Finance and Accounting Using a Microcomputer, various sites throughout the U.S. This three-day seminar is sponsored by the Data Processing Institute of the New York University School of Continuing Education. It will cover microcomputer applications for effective decision making and controlling business requirements. Previous computer knowledge is not required. The fee for the course is \$695. For specific dates and locations, contact the NYU School of Continuing Education Seminar Center, 575 Madison Ave., New York, NY 10022, (212) 748-5094.

January-April

Courses in C Language and Unix, various sites throughout the U.S. Three five-day courses are offered: "C Programming Workshop," "Advanced C Topics Seminar," and "Unix Workshop." For complete details, contact Joan Hall, Plum Hall Inc., 1 Spruce Ave., Cardiff, NJ 08232, (609) 927-3770.

January-August

Conferences and Expositions from the Society of Manufacturing Engineers, various

sites throughout the U.S. and around the world. More than 25 conferences and expositions are scheduled. For a calendar, contact the Public Relations Department, Society of Manufacturing Engineers, One SME Dr., POB 930, Dearborn, MI 48121, (313) 271-0777.

January 10-12

Mainframe Seismic and Remote Sensing Applications of Optical Storage, Westin Oaks Hotel, Houston, TX. This conference will emphasize the uses of optical storage in oil exploration, geophysical, atmospheric, and oceanographic-sensing industries, where massive amounts of data must be collected, analyzed, and archived. The fee is \$695 for the first person from an organization and \$595 for each additional attendee. For details, contact Technology Opportunity Conference, POB 14817, San Francisco, CA 94114-0817, (415) 626-1133.

January 14-15

The Fourth Annual Computer Fair, Northland Mall, Sterling, IL. This event is sponsored by the Sauk Valley Computer Club. For details, contact Vinus Williams, Rt. 1, Milledgeville, IL 61051, (815) 625-8585 days.

January 16-17

Data Communications for Personal Computers, Boston, MA. This seminar seeks to impart an understanding of the fundamentals of data communications, describe the possible applications available to computer users, and provide guidance in the selection and use of data communications hardware and software. Topics covered range from electronic mail to troubleshooting an installed system. The fee is \$545, which includes all materials.

Contact the Center for Advanced Professional Education (CAPE), Suite 110, 1820 East Garry St., Santa Ana, CA 92705, (714) 261-0240.

January 16-17

MOS Analog/Digital Interface Circuit Design for VLSI Systems, San Francisco Airport Hilton Hotel, San Francisco, CA. This short course will emphasize applicable design techniques for very large-scale integration systems. Course notes are included in the \$450 fee. For a brochure, contact Continuing Education in Engineering, University of California Extension, 2223 Fulton St., Berkeley, CA 94720, (415) 642-4151.

January 16-20

The IEEE Instrumentation and Measurement Technology Conference and The Measurement Science Conference, Long Beach, CA. Both of these conferences address the theme "Automation—Quality—Productivity." Tutorials, seminars, and workshops will cover such topics as "Design for Testability," "Solid State Transducers," and "Testing Relating to VLSI Design." The first conference will emphasize automated testing and computer-aided instrumentation, while the second focuses on the latest developments in metrology. The venue for both convocations is aboard the Queen Mary ocean liner. For more information, contact John C. Schulz, Ford Aerospace and Communications Corp., Ford Rd., POB A, Building 4, Room 28, Newport Beach, CA 92660, (714) 720-4787.

January 17-19

The Midwestern Telecommunications Showcase, Bartle Hall, Kansas City, MO. Technical sessions and a large ex-

hibition of products and services designed for the telecommunications industry are planned. For details, contact the United States Telecommunications Suppliers Association (USTSA) Exhibit Office, 7076 Taft St., Hollywood, FL 33024, (305) 963-1485.

January 17-19

Mini/Micro-Southeast and Southcon/84 High-Technology Electronics Exhibition and Convention, Orange County Convention/Civic Center, Orlando, FL. Mini/Micro, designed for the original equipment manufacturing community, explores peripherals, processors, data communications, and software. A few of the topics to be addressed at Southcon/84 are artificial intelligence, computer-aided design, and factory automation. For details on these concurrent events, contact Electronic Conventions Inc., 8110 Airport Blvd., Los Angeles, CA 90045, (213) 772-2965.

January 17-20

Uniform, Washington-Hilton, Washington, DC. This conference and exposition is designed for and by users of Unix-based systems. For details, contact Mark Weber, Professional Exposition Management Co. Inc., Suite 205, 2400 East Devon Ave., Des Plaines, IL 60018, (800) 323-5155; in Illinois, (312) 299-3131.

January 18-23

Commtext International and NAVA/ICIA '84 Convention, Dallas Convention Center, Dallas, TX. Commtext, a communications and information technologies exposition, highlights the latest developments in audio-visual, video, and microcomputer products for many communication needs. The concurrent con-

vention is sponsored by the National Audio Visual Association/International Communications Industries Association (NAVA/ICIA). For information, contact Robert Milko, NAVA, 3150 Spring St., Fairfax, VA 22031, (703) 273-7200.

January 19

Microtrends Update, Dallas, TX. This conference focuses on future trends in the micro-computer industry and on the needs in the educational software field. It's held in conjunction with the NAVA/International Communications Industries Association 1984 Convention. For information, contact Kathy Eisenrauch, NAVA/ICIA, 3150 Spring St., Fairfax, VA 22031, (703) 273-7200.

January 19-20

Data Communications for Personal Computers, New Brunswick, NJ. For details, see January 16-17.

January 23-25

Teaching Math with Microcomputers, Hacienda Resort Hotel, Las Vegas, NV. This seminar, sponsored by the National Council of Teachers of Mathematics (NCTM), is designed to inform educators in elementary, intermediate, and secondary schools about using microcomputers effectively in mathematics education. For details, contact NCTM Seminar Series, 1906 Association Dr., Reston, VA 22091, (703) 620-9840.

January 24-26

Advanced Semiconductor Equipment Exposition (ASEE) and Technical Conference, Convention Center, San Jose, CA. Five sessions designed as a broad-based program cover the manufacturing aspects of the semiconductor industry. For details, contact Joyce Estill, Cartledge & Associates Inc., Suite 205, 4030

Moorpark Ave., San Jose, CA 95117, (408) 554-6644.

January 25-27

The Business Telecommunications Exposition, Stadium Club, Giants Stadium, East Rutherford, NJ. This communications exposition is designed for business, industry, and trade. Topics of interest include facsimile, voice, video, and data communications. Other topics to be covered are office automation, word processing, and purchasing. Registration is required for admittance to the exposition. Contact Michael Houston, The Exposition Group Inc., 9128 Columbia Ave., North Bergen, NJ 07047, (201) 662-1318.

January 25-27

Fundamentals of Digital Electronics: A Hands-on Workshop, Hilton Hotel, Los Angeles, CA. Technical managers and engineers will explore the practical essentials of digital theory and applications. This seminar is sponsored by *Electronics* magazine, a McGraw-Hill publication. In-house presentations can be arranged. For a catalog outlining seminars, locations, and fees, contact Irene Parker, McGraw-Hill Seminar Center, Suite 603, 331 Madison Ave., New York, NY 10017, (212) 687-0243.

January 26-27

Computers in Construction, Las Vegas, NV. This seminar is designed to assist construction contractors and construction management firms in acquiring computer systems. The fee is \$425 per registrant. More details are available from CIP Information Services Inc., 1105-F Spring St., Silver Spring, MD 20910, (301) 589-7933.

January 26-27

Software Business Opportunities in Japan, Monterey, CA. This seminar will cover

the marketing of packaged software in Japan, software licensing, protecting software from competitors, methods of distribution, tax planning considerations, and sales techniques. American and Japanese computer, technology, trade, and legal experts will discuss strategies for penetrating the Japanese market. Registration information is available from the Technology Analysis Group Inc., Suite 101, 1424 16th St. NW, Washington, DC 20036, (202) 483-6642.

January 27-29

Resource '84, Shamrock Hilton Hotel, Houston, TX. This computer exposition is dedicated to users in the medical, dental, legal, and accounting professions who need to buy a new system or want to upgrade existing systems. Telecommunications information and software applicable to home and office uses will be displayed. Admission is free for physicians, dentists, attorneys, and accountants; all others pay \$2.50. Entrance to any or all of the seminars is \$10. For details, contact Joyce Fadem, Professional Resources Inc., POB 740433, Houston, TX 77274.

January 30-31

Data Communications for Personal Computers, Los Angeles, CA. For details, see January 16-17.

January 31-February 3

The Sixth Annual Communication Networks 1984 Conference and Exposition, Washington Convention Center, Washington, DC. Voice and telecommunications, electronic mail, data processing, and communications are a few of the products and services to be displayed at this event. Registration information is available from Louise Myerow, POB 880, Framingham, MA 01701,

(800) 225-4698; in Massachusetts, (617) 879-0700.

February 1984

February-April

Courses from Integrated Computer Systems, various sites throughout the U.S. "Implementing Local Area Networks" and "Computer Network Design and Protocols" are two of the courses to be presented. For complete course information, contact Ruth Dordick, Integrated Computer Systems, 6305 Arizona Place, POB 45405, Los Angeles, CA 90045, (213) 450-2060.

February-July

Reliability and Maintainability Engineering Institutes and Short Courses, various sites throughout the U.S. A few of the programs to be offered are "Reliability Engineering, Testing, and Maintainability Engineering" and "The Tenth Annual Reliability Testing Institute." For a complete schedule, contact Dr. Dimitri Kececioglu, College of Engineering, Aerospace and Mechanical Engineering Department, University of Arizona, Tucson, AZ 85721, (602) 621-2495.

February 1-2

Data Communications for Personal Computers, San Jose, CA. For details, see January 16-17.

February 2-4

The Third Annual SCS Multiconference, Bahia Hotel, Mission Bay, San Diego, CA. This conference, sponsored by the Society for Computer Simulation (SCS), is composed of four conferences: Modeling and Simulation on Microcomputers, Simulation in Health Care Delivery Systems, Aerospace Simulation, and Simulation in Strongly Typed Languages, Ada, Pascal, Simula. For details, con-

tact Gloria Rico, SCS, POB 2228, La Jolla, CA 92038, (619) 459-3888.

February 7-9

Florida Agribusiness Computer Conference and Trade Show, Civic Center, Lakeland, FL. This conference will demonstrate how computers can be used as decision-making tools for managers in agribusiness. The sponsor of this second annual farm computer conference is the University of Florida's Institute of Food and Agricultural Sciences (IFAS). For details, contact IFAS Director of Conferences, 1041 McCarty Hall, University of Florida, Gainesville, FL 32611, (904) 392-5930.

February 7-10

Florida Instructional Computing Conference, Orlando, FL. This conference is designed to provide kindergarten,

ten, elementary school, high school, and college and university instructors and administrators with the opportunity to learn about administrative and instructional computing. More than 85 concurrent sessions, 120 exhibits, and preconference workshops will be offered. Full details are available from Educational Technology, Florida Department of Education, Knott Building, Tallahassee, FL 32301, (904) 487-3104.

February 13-16

Kuwait Info '84, International Exhibition Center, Kuwait City, Kuwait. Exhibits in this third annual event will encompass a broad range of information businesses, including data and word processing, communications, office automation, micrographics, security systems, and environmental control systems.

Information is available from Carol Purdey, Intermarket Network Corp., Suite 203, 1110 Vermont Ave. NW, Washington, DC 20005, (202) 822-9127.

February 14-15

The First Annual Automated Manufacturing Systems Conference: A Market Assessment, Inn of Westchester, White Plains, NY. For information, contact Carol Sappchin, Frost & Sullivan Inc., 106 Fulton St., New York, NY 10038, (212) 233-1080.

February 14-16

The Twelfth Annual ACM Computer Science Conference, Franklin Plaza Hotel, Philadelphia, PA. Papers, panel sessions, and abstracts will address the central themes of "Factory of the Future," "Coping with Small Computers," and "Social and Ethical Implications of Com-

puters." Exhibits will feature over 50 computer and instructional materials. Particulars are available from the Association for Computing Machinery, 1133 Avenue of the Americas, New York, NY 10036, (212) 265-6300.

February 20-22

The 1984 Office Automation Conference (OAC '84), Convention Center, Los Angeles, CA. The theme of this conference is "Office Automation and You." For the first time, an executive-only program will be offered. Further information is available from the American Federation of Information Processing Societies Inc., 1899 Preston White Dr., Reston, VA 22091, (703) 620-8926. For details on the Executive Program, contact John J. Connell, Office Technology Research Group, POB 65, Pasadena, CA 91102.

PRICE, SERVICE, INTEGRITY... YOU OWE IT TO YOURSELF TO CALL US! TOLL-FREE (800)392-7081 (ORDERS ONLY) Calif., Alaska, Hawaii & all info Call (213)725-3080

STAR GEMINI
Gemini-10X, 120 CPS, 80 Col., friction & tractor feed, parallel... \$1,850
Gemini-15, above w/15" platen Call Delta-10, New! Like 10-X but with a faster speed of 160 CPS \$Call

EPSON
FX-80, 160 CPS, 80 Col., friction & tractor feed, parallel... \$245
FX-100, 160 CPS, 132 Col., friction & tractor feed, parallel... \$245
Call RX-80, MX-80 FT, MX-100... Call

NEC
3650 Spinwriter, 30 CPS, 203 Col., letter quality, (Parallel)... \$1,850
Tractor for NEC 3650... \$245
8023A, 100 CPS, 80 col., par... \$385

C. ITOH
8510AP Prowriter, 120 CPS, 80 col., friction feed, serial & parallel... \$Call
1550 Prowriter-II, 120 CPS, 136 col., 2K buffer, graphics, (parallel)... \$Call

RITEMAN
120 CPS, 9x9 matrix, tractor/friction feed, compact, (parallel)... \$389

TOSHIBA P1350
Super dot-matrix printer w/24-pin hi-resolution head, 192 CPS draft, 100 CPS letter-quality (parallel) \$Call

OKIDATA
ML-82A, 120 CPS, 80 col., pin & friction feed, serial & parallel... \$379
ML-83A, 120 CPS, 136 col., tractor & friction feed, parallel/serial... \$629
ML-84P, 200 CPS, 136 col., friction & tractor feed, (parallel)... \$989
ML-92P, 160 CPS, 80 col., friction & tractor feed, (parallel)... \$499
ML-93P, 160 CPS, 136 col., tractor & friction feed, (parallel)... \$849

IDS PRISM
IDS Prism 80C, 200 CPS, 80 col., 4-color, graphics, friction/tractor feed, sheet feeder, (parallel)... \$1,259
IDS Prism 132C, above but 132 col. Parallel... \$1,495

BROTHER HR-25
New! 23 CPS daisywheel printer w/ 2 color printing, 3K buffer, proportional spacing, etc. Parallel... \$769

SILVER REED EXP-550
16 CPS daisywheel printer, bi-directional printing, proportional and incremental spacing, Parallel... \$649

C. ITOH F-10
40 CPS daisywheel (parallel) \$1,089
55 CPS daisywheel (parallel) \$1,349

DYNAX DX-15
13 CPS daisywheel printer, 2-color printing, 3K buffer, (parallel) \$Call

JUKI 6100
18 CPS daisywheel, 13" platen, 2K buffer, 3-pitch, (parallel)... \$539

FUJITSU SP-830
A super daisywheel printer w/ultra fast 80 CPS printing speed, plus many outstanding features... \$2,095

DAISYWHEELER 2000
The intelligent letter-quality printer w/48K built-in buffer memory, 17 CPS, bi-directional, auto margin justification, universal interfaces \$1,059

TELETEX TTX-1014
TTX-1014, 12 CPS daisywheel with built-in tractor adjustable 2%-14%". Parallel & serial interfaces... \$519

TELETEX TTX-3000
Smart Terminal Built-in text edit & graphic capability. Design for upgrading to stand-alone computer, word processing & telecom system. 80x25 line swivel screen, 10 function keys & numeric keypad... \$549
Complete w/014 printer... \$999

BROTHER HR-1A
This is the famous daisywheel printer that sets the industry standard for reliability & durability. 16 CPS, bi-directional & proportional spacing, 10,12,15 pitch. Uses standard typewriter ribbon, 16 1/2" paper. Parallel interface. We have purchased a huge quantity of this printer and offering to you at an unbelievable price... \$599

AST Multi-Function Cards for IBM PC and XT
New Low Prices!
(Each card now comes w/ SuperDrive & SuperSpool)

SixPakPlus Cards
Six-function card with 64K-384K RAM memory, Parallel port, Serial port, Optional Game port, Clock-Calendar, SuperDrive & SuperSpool Software. Memory installed on card... none 64K 128K 192K 256K 320K 384K with parallel, serial ports & clock \$227 \$267 \$317 \$367 \$417 \$467 \$517 above plus game port... \$262 \$302 \$352 \$402 \$452 \$502 \$552

MegaPlus II Cards
Amount of memory installed on board — None 64K 128K 192K 256K w/serial port No. 1 & clock... \$226 \$266 \$316 \$366 \$416 w/either parallel or serial port No. 2... \$274 \$314 \$364 \$414 \$464 w/both parallel & serial port No. 2... \$309 \$349 \$399 \$449 \$499 MegaPak... 128K/192K \$199 (256K) \$299

I/O Plus II Cards
Standard card w/one serial port (S1) and clock/calendar... \$129
Additional Parallel (P1), Game (G1), or Serial 2 (S2) port... add \$35 ea.

QUADRAM QUADBOARD - Multi-Function board for IBM-PC. Full parity checking & memory selective addressing, w/QSpool & Q-Drive software.
Amount of memory installed on card — none 64K 128K 192K 256K with parallel, serial ports, clock/calendar... \$235 \$275 \$325 \$375 \$425

Roland DXY-800 Plotter
8-pen intelligent X-Y plotter. High speed 180mm/sec. IBM-PC compatible. 11"x17" paper size. Dual speed switch. Both parallel & serial interface. Intro special \$795

HALF HEIGHT DISK DRIVES
for Apple II and Franklin Ace
Super 5 (ALPS) 40-track, SS... \$199
Super 5 (Teac) 40-track, SS... \$239
Super 5 (Teac) double sided... \$339
Control card for SS drive... \$59
Control card for DS drive... \$69

MONITOR SALE

RGB COLOR
BMC BM-AU8101MU, 13" RGB color, 640-dot, 16 col... \$449
Princeton HX-12, 12" RGB color, 690-dot hi resolution, Sale \$479
Amdtek RGB Color II Plus, 640-dot, 16 col... \$459
Quadchrome, 12" RGB color, 690-dot... \$569
Zenith ZVM 134 RGB Color... \$399

GREEN SCREEN
DYNAX GM-120, 12" green, 600 line, 20 MHz. List \$200... \$129
USI PI-2, 12" green, 1,000 line, 20 MHz... \$165
Taxan KG-12M, 12" green 800-dot, List \$199.00... \$149

AMBER SCREEN
Amdtek 310A, 12" amber, 720-dot, runs on IBM monochrome card & multi-display cards only \$179
DYNAX AM121, 12" amber, 600-dot, 20 MHz. List \$250... \$149
Taxan KA12N, 12" amber, 800-dot, List \$205.00... \$150
USI PI-3, 12" amber, 1,000-dot, 20 MHz... \$189

IBM PC & XT COMPUTERS
Call for price & availability

SOFTWARE FOR IBM PC
WordStar... \$495 \$285
MailMerge... \$250 \$145
SpellStar... \$250 \$145
Wordstar Professional... \$480
Infostar... \$295
1-2-3 (Req. DS drive)... \$495 CALL
dBASE II... \$700 \$395
Financial Planner... \$485
Friday... \$195
Bottom Line Strategist... \$285
Home Accountant Plus... \$150 \$95
TK!Solver... \$299 \$219
Multiplan... \$275 \$175
PFS: File... \$95
PFS: Report... \$85
Versiform... \$389 \$249
PeachPak (GL/AR/AP)... \$395 \$235
Peach Text 5000... \$237
The Tax Manager... \$250 \$175
VisiCalc/256K... \$250 \$169
Real Estate Analyzer... \$250 \$185
SuperCalc I... \$295 \$115
SuperCalc II... \$295 \$175
Spell Guard... \$195 \$119
Super Writer... \$295 \$185

Columbia & Compac
Call for price & details

Hayes Smart Modern
300... \$209
1200... \$485
1200B... \$429

5 1/4" DISK DRIVES
Tandon TM-100-1 5DD0 100K... \$199
Tandon TM-100-2, DSDD 320K... \$225
Tandon Half-Height, DSDD 320K... \$219
TEAC 55B Half ht. DSDD 320K... \$225
Control Data full ht. DSDD 320K... \$235
QUJME half height DSDD 320K... \$229
Panasonic half ht. DSDD 320K... \$189

EASTERN ENTERPRISES, INC.
Mass Merchandising Since 1969
2937 S. VAIL AVE., LOS ANGELES, CALIF. 90040

To order, please send money order or cashier's check. Personal or company checks require 2-3 weeks to clear. Prices reflect 3% cash discount. Visa/Mastercard accepted. Shipping, insurance & handling charges are 3% of total order value by UPS Surface, 5% by UPS Air or Parcel Post. COD's requires 20% deposit. Calif. residents add sales tax. No sales tax on out-of-state orders. Prices & availability subject to change without notice.

Event Queue

February 20-23

Arabian Productivity Advancement Using Computers/Graphics, APAC '84, Inter-Continental Hotel, Riyadh, Saudi Arabia. This is the first international conference and exposition on computer graphics to be held in Saudi Arabia. Industry and government representatives from Middle Eastern and Western nations will attend. For information, contact APAC '84 Conference Director, World Computer Graphics Association Inc., Suite 399, 2033 M St. NW, Washington, DC 20036, (202) 775-9556.

February 21-23

Softcon, Superdome, New Orleans, LA. This international software conference and trade fair is designed for retailers, independent sales organizations, consultants, government agencies, educational institutions, and professional software developers. Registration is \$15. For information, contact Northeast Expositions, 822 Boylston St., Chestnut Hill, MA 02167, (800) 841-7000; in Massachusetts, (617) 739-2000.

February 22-28

Imprinta 84, Fairgrounds, Dusseldorf, West Germany. This international congress and exhibition will feature techniques and services in print communication and its alternatives. For details, contact Dusseldorf Trade Shows, 500 Fifth Ave., New York, NY 10110, (212) 840-7744.

February 23-24

Computers in Construction, Orlando, FL. For details, see January 26-27.

February 23-26

Technology, Entertainment, Design Communications Conference, Conference Center, Monterey, CA. Audio and visual presentations documenting technological advances and their usage in

communications processes will be presented at this conference. Registration fees are \$475. Contact Judi Skalsky, T. E. D. Communications Conference, 635 Westbourne Dr., Los Angeles, CA 90069, (213) 854-6307.

February 27-March 2

MICAD '84, Paris, France. An exhibition associated with the MICAD biennial conference will be held for the first time. This event also marks the tenth anniversary of MICADO, the French Computer Graphics Association. MICAD will provide an opportunity for manufacturers of computer graphics hardware and software to make contact with the rapidly growing French computer-graphics market. For information, contact Caby Smith, World Computer Graphics Association Inc., Suite 399, 2033 M St. NW, Washington, DC 20036, (202) 775-9556. In Europe, contact MICADO, ZIRST, Chemin de Pre Carré, 38240 Meylan, France; tel: (76) 90-31-90; Telex: 980 882 F.

February 27-March 2

Welcome to the World of Personal Computing, Fort Lauderdale, FL. This workshop serves as a comprehensive introduction to the uses of microcomputer technology in business, industry, and government. Six modules, ranging from user productivity to software reliability, are on the agenda. For further information, contact Keston Associates, 11317 Old Club Rd., Rockville, MD 20852, (301) 881-7666.

February 28-29

The Twelfth Annual Midwest Digital Equipment Exhibit and Seminar, Thunderbird Motel, Minneapolis, MN. More than 100 manufacturers of computer terminals, data communications equipment, peripherals, data-acquisition systems, and digital

test instruments will display their products. Admission to both the exhibits and seminars is free of charge. For more details, contact Countryman Associates Co., 1821 University Ave., St. Paul, MN 55104, (612) 645-9151.

February 28-March 1

The Annual Computer Fair of the Computer Society of Bermuda, Princess Hotel, Southampton, Bermuda. The theme for this event is "Bermuda—The International Offshore Software Mart." Seminars, demonstrations, presentations, and vendor exhibits will highlight this show. For full details, contact James H. Young Jr., Computer Society of Bermuda, POB 1479, Hamilton 5, Bermuda, (809) 295-7111.

February 28-March 2

The Air Force Conference on Technology in Training and Education, School of Health Care Sciences, Sheppard Air Force Base, TX. This conference will explore technology in aerospace applications, technical training, and education with emphasis on current developments in the Department of Defense. Topics of discussion include computer-generated simulations and training aids and innovative uses of interactive video disks. For information, contact Captain Jim Campbell, SHCS/USAF/MSSA, SAFB Wichita Falls, TX 76311, (817) 851-6461.

March 1984

March 8-9

Computers in Construction, San Diego, CA. For details, see January 26-27.

March 8-10

The Role of the Microcomputer in Education IV, Arlington Park Hilton, Arlington Heights, IL. In-depth

seminars and sessions covering a wide range of educational topics make up this conference. Further information is available from Rick Nelson, Micro-Ideas, 1335 North Waukegan Rd., Glenview, IL 60025, (312) 998-5065.

March 12-14

Auditing and Controlling Microcomputers, Houston, TX. This seminar reviews the technology behind microcomputers and shows how they can be used by an auditor for practice management or as a tool in an audit engagement. For a course outline, contact Miriam Hoyt, MIS Training Institute Inc., 4 Brewster Rd., Framingham, MA 01701, (617) 879-7999.

March 12-15

Interface '84, Convention Center, Las Vegas, NV. For details on this twelfth annual data communications/information-processing conference and exposition, contact the Interface Group Inc., 300 First Ave., Needham, MA 02194, (800) 325-3330; in Massachusetts, (617) 449-6600.

March 13-15

Micro/SET 84: Microcomputer Expo for Scientific, Engineering, and Technology, Engineering Society of Detroit, MI. Papers emphasizing microcomputer applications in research, design, engineering, and manufacturing will be presented. Complementing the conference program will be displays of scientific, engineering, and technical microcomputer hardware and software. For more information, write to the Conference Manager, Engineering Society of Detroit, 100 Farnsworth, Detroit, MI 48202.

March 13-15

Optical Storage of Documents and Images, Biltmore Hotel, Los Angeles, CA. Topics to be covered are read-

write and read-only storage of analog and digital information including office documents, engineering drawings, and parts catalogs. The fee is \$695 for the first person from an organization and \$595 for each additional attendee. For more information, contact Technology Opportunity Conference, POB 14817, San Francisco, CA 94114-0817, (415) 626-1133.

March 18-22

Saudicomputer '84—The Business Computer Show, al-Dhafia Exhibition Centre, Riyadh, Saudi Arabia. For information, contact Philip Jenkinson, Saudicomputer '84, Overseas Exhibition Services Ltd., 11 Manchester Square, London W1M 5AB, England; tel: 01-486 1951; Telex: 24591 Montex G.

March 19-22

Automated Manufacturing Conference and Exhibition (AM84), Textile Hall, Greenville, SC. The latest automated manufacturing technologies will be the focus of this combination exhibition and seminar. Representatives from more than 200 firms are expected. Complete details about the conference can be obtained from the AM84 Registration Control Center, POB 5616, Station B, Greenville, SC 29606, (803) 242-3170, ext. 260. Details about the exhibition are available from AM84, POB 5823, Greenville, SC 29606, (803) 233-2562.

March 19-22

The Eighth Annual Federal Office Systems Expo (FOSE '84), Convention Center, Washington, DC. The theme for this year's expo is the "Realities of Integration: Technologies, Applications, Human Resources." More than 60 conference sessions and 1200 exhibits are planned. Address inquiries to Jacqueline Voigt, National Trade Productions, 9418 An-

napolis Rd., Lanham, MD 20706, (800) 638-8510; in Maryland, (301) 459-8383.

March 22-23

Computers in Construction, New York, NY. For details, see January 26-27.

March 26-28

The Seventh International Conference on Software Engineering, Orlando, FL. This conference seeks to evaluate what has been learned from the past and to provide directions for future investigations in software engineering. Its theme is "Fifteen Years of Software Engineering: Results and Futures." A software tools fair will be held concurrently. Contact the IEEE Computer Society, POB 639, Silver Spring, MD 20901, (301) 589-3386.

March 26-30

The Sixth NC Industrial Automation and Robot Conference and Exhibition, Milan Fair, Milan, Italy. Controls for automated material handling, variable mission manufacturing systems, and quality control will be featured. A concurrent conference consisting of 20 sessions will be presented. For more information, contact the Society of Mechanical Engineers, One SME Dr., POB 930, Dearborn, MI 48121, (313) 271-0023.

March 28-30

The Sixth Annual Computer Graphics Conference, Doral Hotel On-the-Ocean, Miami Beach, FL. The theme for this conference is "Forecasts and Assessments." Further details are available from Carol Saphin, Frost & Sullivan Inc., 106 Fulton St., New York, NY 10038, (212) 233-1080.

March 30-31

Third Annual Conference on Communication Technology, Joseph Stokes Auditorium, Children's Hospital of

Philadelphia, PA. This program presents advances in technology and treatment alternatives for physically handicapped and speech impaired persons. Speakers, equipment demonstrations, and workshops are planned. The two-day registration fee is \$95, which includes all course materials. If your registration request is post-marked before March 10, the fee is reduced by \$10. Group rates are offered. For full particulars, contact Joan Bruno, Children's Seashore House, 4100 Atlantic Ave., POB 4111,

Atlantic City, NJ 08404, (609) 345-5191, ext. 278.

March 30-April 1

The NY Personal Computer Show, Exposition Rotunda, Madison Square Garden, New York City. Formerly called the Eighty/Apple/PC Computer Show, this event will feature products and services for all small computer systems. More than 240 exhibitors are expected. Complete show details can be obtained from the Kengore Corp., POB 13, Franklin Park, NJ 08823, (201) 297-2526. ■

In order to gain optimal coverage of your organization's computer conferences, seminars, workshops, courses, etc., notice should reach our office at least three months in advance of the date of the event. Entries should be sent to: Event Queue, BYTE Publications, POB 372, Hancock, NH 03449. Each month we publish the current contents of the queue for the month of the cover date and the two following calendar months. Thus a given event may appear as many as three times in this section if it is sent to us far enough in advance.

WHY PAY RETAIL ?

SANYO MONITORS		ZENITH	
DM-2112 GREEN 12"	\$ 89	Z-29 TERMINAL	\$676
DM-2212 AMBER 12"	\$107	ZVM-123 GREEN 12"	\$ 88
DM-8112 GREEN 12"	\$168	ZVM-122 AMBER 12"	\$113
DM-8212 AMBER 12"	\$178		
DMC6500 RGB 13"	\$346	STAR MICRONICS PRINTERS	
AVM-196 RGB 19"	\$626	GEMINI 10X	\$275
AVM-255 RGB 25"	\$787	GEMINI 15X	\$428

PANASONIC		ZOOM MODEMS FOR APPLE	
TR-120MIP GR. 12"	\$168	NETWORKER	\$115
TR-120MDP AMB. 12"	\$185	NETMASTER	\$ 69
CT-160 COL/BW 10"	\$208	NETWORK/NETMASTER	\$149
DTD-1000G RGB 10"	\$325		
DTD-1300G RGB 13"	\$349	SILVER REED PRINTERS	
KX-P1090 PRINTER	\$349	500P/500S	\$432/\$467
KX-P1160 PRINTER	\$1199	550P/550S	\$648/\$675
VP-6801A PLOTTER	\$1399	CALL FOR \$ AMDEK, NEC...	

TERMS: COD - FREIGHT COLLECT - CHARGE CARD
CUSTOMERS ADD 4% - \$1 PHONE CALL REBATE W/ORDER.

(301) 662-1317

COMPUTER WHOLESALEERS of FREDERICK

A DIVISION OF TESCO CORP.
1030 W. Patrick Street Frederick, MD 21701

Books Received

Apple II BASIC—Quick Reference Guide, Gilbert Held. New York: John Wiley & Sons, 1983; 1 page, 15.5 by 30 cm, fold-out card, ISBN 0-471-87039-0, \$2.95.

Atari BASIC—Quick Reference Guide, Gilbert Held. New York: John Wiley & Sons, 1983; 1 page, 15.5 by 30 cm, fold-out card, ISBN 0-471-87041-2, \$2.95.

Catching up with the Computer Revolution, Lynn M. Salerno, ed. New York: John Wiley & Sons, 1983; 544 pages, 17 by 24 cm, hardcover, ISBN 0-471-87594-5, \$22.95.

The Compleat Computer, 2nd ed. Dennie and Cynthia Van Tassel. Chicago, IL: Science Research Associates, 1983; 282 pages, 30.5 by 22.5 cm, softcover, ISBN 0-574-21415-1, \$14.95.

Computer Images, State of the Art, Joseph Deken. New York: Stewart, Tabori & Chang Publishers Inc., 1983; 200 pages, 24.8 by 24.8 cm, softcover, ISBN 0-941434-40-0, \$16.95.

Data and File Management for the IBM Personal Computer, John P. Grillo and J. D.

Robertson. Dubuque, IA: Wm. C. Brown Company Publishers, 1983; 208 pages, 21.3 by 28 cm, spiral-bound, ISBN 0-697-09987-3, \$16.95.

Database Design, 2nd ed. Gio Wiederhold. New York: McGraw-Hill, 1983; 767 pages, hardcover, ISBN 0-07-070132-6, \$32.

Designing With Programmable Array Logic, 2nd ed. The Technical Staff of Monolithic Memories Inc. New York: McGraw-Hill, 1983; 690 pages, 19.5 by 24.5 cm, hardcover, ISBN 0-07-042723-2, \$32.95.

Electronic Instrumentation and Measurements, David A. Bell. Reston, VA: Reston Publishing Co., 1983; 544 pages, 18.5 by 24 cm, hardcover, ISBN 0-8359-1669-3, \$25.95.

Fifty 1K/2K Games for the ZX-81 and Timex Sinclair 1000, Alastair Gourlay, James Walsh, and Paul Holmes. Reston, VA: Reston Publishing Co., 1982; 112 pages, 15.8 by 23.5 cm, hardcover, ISBN 0-8359-1979-X, \$10.95.

54 Visicalc Models, Robert H. Flast. Berkeley, CA: Osborne/McGraw-Hill, 1983; 288 pages, 21 by 27.5 cm, soft-

cover, ISBN 0-33134-100-2, \$12.95.

Free to Teach, Achieving Equity and Excellence in Schools, Joe Nathan. New York: Pilgrim Press, 1983; 201 pages, 16 by 25 cm, hardcover, ISBN 0-8298-0657-1, \$14.95.

IBM PC BASIC—Quick Reference Guide, Gilbert Held. New York: John Wiley & Sons, 1983; 1 page, 15.5 by 30 cm, fold-out card, ISBN 0-471-87042-0, \$2.95.

Image Sequence Processing and Dynamic Scene Analysis, T. S. Huang, ed. New York: Springer-Verlag Inc., 1983; 760 pages, 17 by 25 cm, hardcover, ISBN 0-387-11997-3, \$59.20.

Interfacing to Microprocessors, J. C. Cluley. New York: McGraw-Hill, 1983; 168 pages, 16 by 24 cm, hardcover, ISBN 0-07-011409-9, \$24.50.

Intermediate-Level Apple II Handbook, David L. Heiserman. Indianapolis, IN: Howard W. Sams & Co., 1983; 328 pages, 15.3 by 23 cm, spiral-bound, ISBN 0-672-21889-5, \$16.95.

International Microcomputer Dictionary, Berkeley, CA:

Sybx, 1981; 142 pages, 10.5 by 16.5 cm, softcover, ISBN 0-89588-067-9, \$3.95.

The Intimate Machine, Close Encounters with Computers and Robots, Neil Frude. New York: New American Library, 1983; 256 pages, 14.5 by 22.5 cm, hardcover, ISBN 0-453-00450-4, \$15.50.

Introduction to Graphics for the IBM Personal Computer, John P. Grillo and J. D. Robertson. Dubuque, IA: Wm. C. Brown Company Publishers, 1983; 144 pages, 21.3 by 28 cm, spiral-bound, ISBN 0-697-09989-X, \$15.95.

M6805 HMOS M146805 CMOS Family, 2nd ed. Motorola. Englewood Cliffs, NJ: Prentice-Hall, 1983; 272 pages, 17.5 by 23.5 cm, softcover, ISBN 0-13-541375-3, \$17.95.

Machine & Assembly Language Programming, David C. Alexander. Blue Ridge Summit, PA: Tab Books, 1982; 210 pages, 13 by 21 cm, softcover, ISBN 0-8306-1389-7, \$9.95.

Managing the Data-Base Environment, James Martin. Englewood Cliffs, NJ: Prentice-Hall, 1983; 784 pages, 19 by 24 cm, hardcover, ISBN 0-

Protect your computer from high voltage power surge

SURGEFREE
NOW AVAILABLE IN 10 SOCKETS

\$79.95



VISA MASTER CARD
 CHECK AMERICAN EXPRESS CARTE BLANCHE
EXPIRATION DATE _____
NAME _____
ADDRESS _____
CITY _____ STATE _____ ZIP _____
MAIL TO: **Computronix Corporation**
BOX 1425
MELVILLE, N.Y. 11747

BASIC* Features

A powerful extension of Applesoft BASIC for engineers, scientists and students. Some of the BASIC* features are:

• **BUILT-IN COMPLEX ARITHMETIC**
Replaces Applesoft integer variables with complex variables for built-in complex arithmetic capabilities.

• **BUILT-IN COMPLEX FUNCTIONS**
Useful functions for complex arithmetic like CSQRT, CEXP, CABS and CLOG are available. Several complex/real and real/complex functions are standard.

• **POWERFUL EXTENDED HI-RES COMMANDS**
Area oriented byte graphic capabilities for pixel manipulation, image magnification, inter-screen and intra-screen image translation, and screen/memory data movement. Commands for screen switching and displays, and clearing screens to different background colors.

• **PROGRAMMABLE CHARACTER SETS**
Instead of the standard text screen, hi-res screens can be used for upper/lower cases and for mixed graphic modes. Programmable character sets for foreign language alphabets, variable fonts and animation applications.

• **VARIABLE PITCH SCREEN PRINTING**
Variable pitch printing capabilities permit printing 40 to 70 characters per line.

Several application programs (like FFT, EQUATION SOLVER) are contained in the BASIC* diskette to illustrate the powerful features of the language.

Requires APPLE II/III Plus with a 16K memory card or APPLE IIE and one disk drive.

Price: \$60 + \$2 shipping and handling + 6% tax for California residents. We accept checks, Visa or Master Card.

Contact S.S. Reddi, Softesmythe Software,
1000 W. MacArthur #49,
Santa Ana, CA 92707

Phone: 714-540-1644 or 714-660-0167

STOP

FOR GREATER SAVINGS

NEC 8200

Portable Computer

SAVE 25%

LIST \$799

OUR PRICE



\$599.25

OKIDATA 92A SAVE 40%

LIST \$699

OUR PRICE

\$419.40

All orders shipped immediately. Add 3% for shipping & insurance (Foreign orders add 10%). Add 4% for VISA/MC/ American Express.

NEVADA COMPUTER

(702) 451-9275

Box 50030, Henderson NV 89015

13-550582-8, \$49.95.

Messner's Introduction to the Computer, Fred D'Ignazio. New York: Simon & Schuster, 1983; 288 pages, 14.5 by 21.5 cm, hardcover, ISBN 0-671-42267-7, \$10.29.

Microcomputer Interfacing, Harold S. Stone. Reading, MA: Addison-Wesley, 1983; 400 pages, 16.5 by 24 cm, hardcover, ISBN 0-201-07403-6, \$32.95.

Microelectronics and Office Jobs, Diane Werneke. Washington, DC: International Labor Office, 1983; 108 pages, 16 by 24 cm, softcover, ISBN 92-2-103278-7, \$10.

Modern Methods for COBOL Programmers, John R. Pugh and Doug H. Bell. Englewood Cliffs, NJ: Prentice-Hall, 1983; 224 pages, 16 by 24 cm, hardcover, ISBN 0-13-595215-8, \$17.95.

Photovoltaics, Robert G. Seippel. Reston, VA: Reston Publishing Co., 1983; 256 pages, 18 by 24 cm, hardcover, ISBN 0-8359-5538-9, \$22.95.

Practical Digital Design Using ICs, 2nd ed. Joseph D. Greenfield. New York: John Wiley & Sons, 1983; 736 pages, 16.5 by 24.5 cm, hardcover, ISBN 0-471-05791-6, \$26.95.

Programming in Pascal, C. William Gear. Chicago, IL: Science Research Associates, 1983; 256 pages, 18.5 by 23.5 cm, softcover, ISBN 0-574-21360-0, \$14.95.

Programming the IBM Personal Computer: Fortran 77, Robert Rouse and Thomas Bugnitz. New York: Holt, Rinehart and Winston, 1983; 256 pages, 17.5 by 23.3 cm, softcover, ISBN 0-03-062042-2, \$35.95.

Programming Your Atari Computer, Mark Thompson. Blue Ridge Summit, PA: Tab Books, 1983; 280 pages, 13 by 21 cm, softcover, ISBN 0-8306-1453-2, \$10.95.

Software Engineering for Small Computers, R. B. Coats. Reston, VA: Reston Publishing Co., 1982; 256 pages, 18 by 24 cm, hardcover, ISBN 0-8359-7026-4, \$24.95.

Strategies for Natural Language Processing, Wendy G. Lehnert and Martin H. Ringle, eds. Hillsdale, NJ: Lawrence Erlbaum Associates Inc., 1983; 560 pages, 16 by 23.5 cm, hardcover, ISBN 0-89859-191-0, \$49.95.

A Structured Approach to Fortran, J. Winston Crawley and Charles E. Miller. Reston, VA: Reston Publishing Co., 1983; 766 pages, 19 by 24

cm, hardcover, ISBN 0-8359-7092-2, \$16.95.

Techniques of BASIC for the IBM Personal Computer, John P. Grillo and J. D. Robertson. Dubuque, IA: Wm. C. Brown Company Publishers, 1983; 270 pages, 21.3 by 28 cm, spiral-bound, ISBN 0-697-08276-8, \$18.95.

Useful BASIC Programs for the IBM PC, Stanley R. Trost. Berkeley, CA: Sybex, 1983; 192 pages, 14 by 21 cm, softcover, ISBN 0-89588-111-X, \$8.95.

User's Guide with Applications for the IBM Personal Computer, John P. Grillo and J. D. Robertson. Dubuque, IA: Wm. C. Brown Company Publishers, 1983; 272 pages, 21.3 by 28 cm, spiral-bound, ISBN 0-697-09985-7, \$17.95.

Using and Troubleshooting the MC68000, James W. Coffron. Reston, VA: Reston Publishing Co., 1983; 224 pages, 15.5 by 23.5 cm, hardcover, ISBN 0-8359-8158-4, \$21.95.

VisiCalc Advanced Version, Worksheets for Business, Van Wolverton. San Jose, CA: Visicorp, 1983; 256 pages, 19 by 23 cm, softcover, ISBN 0-912213-00-0, \$18.95.

VisiCalc for Science and Engineering, Stanley R. Trost and

Charles Pomernacki. Berkeley, CA: Sybex, 1983; 224 pages, 17.7 by 22.8 cm, softcover, ISBN 0-89588-096-2, \$13.95.

What Can I Do With My Timex/Sinclair 1000? Lots!, Roger Valentine. New York: John Wiley & Sons, 1983; 164 pages, 17 by 25.5 cm, softcover, ISBN 0-471-88730-7, \$9.95.

Z80 Applications, James W. Coffron. Berkeley, CA: Sybex, 1983; 320 pages, 17.5 by 22.5 cm, softcover, ISBN 0-89588-094-6, \$14.95. ■

This is a list of books received at BYTE Publications during this past month. Although the list is not meant to be exhaustive, its purpose is to acquaint BYTE readers with recently published titles in computer science and related fields. We regret that we cannot review or comment on all the books we receive; instead, this list is meant to be a monthly acknowledgment of these books and the publishers who sent them.

Extended Processing S100 Boards

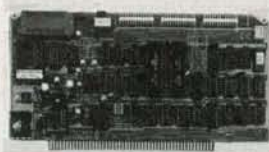

BURNER I/O

The BURNER I/O is a full feature multifunction S100/IEEE-696 board. It has a complete EPROM programmer, 2 Serial ports, parallel output port, parallel input port and memory management. Programs 2704 thru 2764, 2508, 2516 and TMS2716 EPROMS. Menu

driven disk based software supplied in 4K EPROM that is easily loaded on your disk. Zero insertion force programming socket. Totally I/O mapped. Serial ports are independent and support hardware handshaking. Baud rates from 50-19,200. Serial ports are software programmable. Separate parallel input and output ports with full handshaking plus 4 direct sense bits. Memory management controls the S-100 address lines A16-A23.

The board is offered in various configurations. In all versions it is fully assembled and tested.

- Option A: Complete board with programmer, I/O and memory management, \$354.95
- Option B: Programmer only, \$219.95
- Option C: I/O only (2S + P), \$219.95
- Option D: Options B and C, \$329.95
- Option E: Memory management only, \$109.95

Memory management may be added to Options B and C for \$25.00

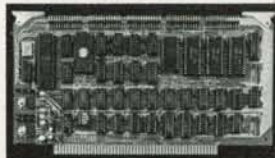

POWER I/O

The POWER I/O is a high performance slave computer that is a complete system including all hardware, software and documentation. It is guaranteed to operate properly with any S-100/IEEE-696 system. The POWER I/O sets a new standard in flexibility, ease of

integration, expandability and performance. It is designed with the future in mind. All I/O and memory may be doubled with the addition of our POWER I/O add-on. Memory can be quadrupled when the 256k rams are available. The standard software supports 6 serial ports, 2 parallel ports and 512K of ram.

The basic board consists of a 4MHz Z80A, 64K DRAM, 3 serial (8251A) I/O ports, baud rates to 19,200. Hardware, ETX, ACK and X-on/X-off handshaking, 1 parallel port, timer, 6 programmable delays, high speed parallel I/O to host, complete POWER I/O software in 4K EPROM (expandable to 8K). On board software is designed for maximum flexibility and ease of use. Supports user written programs. Complete documentation including source code, schematics and many software interface examples.

The POWER I/O add-on has 3 additional serial ports, 1 parallel port and 64K DRAM.

POWER I/O: \$375.00
64K RAM ADD-ON: \$175.00

3 SERIAL, 1 PARALLEL ADD-ON: \$195.00
RAM AND I/O ADD-ON: \$295.00

ep Extended Processing 3861 Woodcreek Lane ■ San Jose, California, 95117 ■ (408) 249-8248

Clubs and Newsletters

Exchanges via Newsletter

Electronics Projects is a newsletter for the exchange of projects, technical articles, software, computer applications, programming tips, and money-making opportunities. All members of the Electronics Projects Club can receive free advertising and are encouraged to submit articles in any electronics area. A \$15 membership fee includes a subscription to eight issues of *Electronics Projects*. For information, send a self-addressed, stamped envelope to Kamenar Enterprises, POB 186, Hatboro, PA 19040.

Unigroup of Manhattan

Unigroup is a nonprofit organization for users of the Unix operating system and its related products that meets in the New York metropolitan area. Meetings are held every two months and feature speakers who are prominent in the Unix field. Membership is \$25 a year and includes a subscription to the newsletter *Unigroup Journal*. Nonmembers must pay \$10 to attend meetings, which are open to all interested people. Address applications and inquiries to Unigroup of New York Inc., GPO Box 1931, New York, NY 10116.

New Englanders Organize for Osbornes

The Vermont—New Hampshire Osborne Users Group (VNHO) meets once a month at the Universalist Church in Woodstock, Vermont. Osborne users and

other interested people are welcome to attend meetings. Topics include database-management programs, Super-calc spreadsheets, Wordstar-Mailmerge word processing, and more. For details, contact VNHO, RFD 1, Box 20A, Killington, VT 03751, or call Solveig Overby at (802) 422-3667.

Monthly Review for the 64

The 64 Review is a monthly newsletter for users of the Commodore 64 personal computer. Features of the newsletter are a question-and-answer column, programs, a technical column, information on graphics and sound, and more. Annual subscriptions are \$11.95. Sample issues cost \$2.50. For further information, write to *The 64 Review*, POB 322, Livermore, CA 94550.

IBM PC Users Meet in Fresno

The Fresno IBM PC Users Club meets monthly in Fresno, California, to discuss intricacies of the PC. The club's newsletter announces the times and locations of future meetings, contains a trade column, and informs users of the IBM PC about events of interest. For further details, contact R. Betancourt, Fresno IBM PC Users Club, 6750 North Woodrow Ave., Fresno, CA 93710.

Tribune for CP/M Users

The CP/M Houston Users Group, an active group in Houston, Texas, produces a newsletter called the *CP/M*

Houston Tribune. The group seeks to educate its members about communications, public-domain software, and video microbroadcasting of software. Other interests include expanding the uses of CP/M-based systems regardless of brands and sharing activities with other user groups. For details on meetings and fees, contact Thomas McCormick, CP/M Houston Users Group, Box 570473, Houston, TX 77257-0473, or call (713) 975-6061.

Computer Cost Estimating

Micapp Inc. (Microcomputer Assisted Process Planning) produces the *Micapp Newsletter* bimonthly for people in the metal-working industry who use microcomputers to perform engineering tasks. Listings for applications such as cost estimating and process planning for turning, drilling, milling, boring, and grinding are included. Subscriptions cost \$37.50 a year in the U.S. and \$47.50 in Canada and abroad. For details, contact Micapp Inc., 16956 230th Ave., Big Rapids, MI 49307, or call (616) 796-6637.

For the Alpha Micro

The Southern California Alpha Micro Users Society (SC/AMUS) meets on the second Sunday of every month (except holidays) from 1 to 3 p.m. at the Fullerton Savings and Loan, 12860 Euclid in Garden Grove, California. Membership dues are \$22 the first year and \$12 thereafter for annual renewal of the newsletter. Nonmembers can receive the newsletter for \$6 a year; back issues are available. For informa-

tion, contact Bob Alex, 17632 Fiesta Way, Santa Ana, CA 92705, or call (714) 669-0360.

Comprehensive Tandy Group

The Tandy Business Users Group (TBUG) meets on the third Wednesday of every month in the Chicago metropolitan area to discuss applications for the TRS-80 Models II, 12, 16, and 16B. A newsletter, *TBUG*, is produced and is included with the \$25 annual membership. It contains information on past and future meetings, software reviews, and a consultant's column. For details, contact Carlos Hidalgo, 311 Longview Rd., Waukegan, IL 60087, or call (312) 623-9661.

Central Jersey Users

The Central Jersey IBM/PC Users (CJPC) is a group designed for users to exchange information about the IBM PC. For information, contact Howard Dean, CJPC, POB 8280, Red Bank, NJ 07701, (201) 842-5800.

TS User Newsletter

TS User is a monthly newsletter for users of the Timex/Sinclair microcomputer and its products. It includes hardware, software, and book reviews, editorials, and other columns for improved applications. Annual subscriptions are \$16.95 for 12 issues; \$25 outside the U.S. and Canada. *TS User* is available from Yagsee, POB 155, Vicksburg, MI 49097.

Osborne Group in Philadelphia

The Philadelphia Regional Osborne Group (PHROG)

meets monthly in the Lansdale area outside Philadelphia to serve those interested in increasing the scope of their Osborne-related endeavors. A newsletter is planned. For details, contact Joe Gervase, PHROG, Box 340, Lamplighter Plaza, Kulpville, PA 19443, or call (215) 362-1888.

Meet in Miami

The Miami PC User Group meets bimonthly to share experiences and knowledge in the current and future uses of the IBM PC at home and at the office. Members can access a private bulletin board service and a software library. Annual dues are \$20. For details, contact Eddy Cue, Miami PC User Group, 6925 Southwest 16 St., Miami, FL 33155, or call (305) 262-1891.

Westchester Apples

The Westchester Apple Users Club meets at 8 p.m. on the third Wednesday of

each month to discuss topics of interest to owners of Apple computers. The meetings are open to the public. A fee to cover the cost of club mailings is \$11 for adults and \$5 for students. For further information, contact Linda Halpern, 330 High Point Dr., Hartsdale, NY 10530, (914) 428-5242.

Engineering Working Group

Educators interested in using microcomputers for engineering purposes are invited to join a nationwide group and receive a quarterly newsletter. For further information, write Marilyn Henry, Microcomputer Engineering Working Group, George Washington University (SEAS), Washington, DC 20052.

Kaypro Club for People in Queens

The Peoples Computer (of Queens) Kaypro Club unites users and promotes useful information about the Kay-

pro II. An \$8 membership fee automatically enters members into a national database, and entitles them to receive a quarterly newsletter. The *Piece of Kayke National Newsletter* could become a monthly newsletter with enough input. For further details, contact Steve Bender, Peoples Computer (of Queens) Kaypro Club, Box 28360, Queens Village, NY 11428.

Telecommunicate the News

Plumb is a newsletter that includes information about electronic bulletin board systems and related communications systems for all types of computers. Stories include news and features about software downloaders, message systems, merchandise boards, and more. For details on cur-

rent subscription prices, contact *Plumb*, Box 300, Harrod Creek, KY 40027.

Schools Take Note

CHIME, the newsletter of the Clearinghouse of Information on Microcomputers in Education, is produced by the College of Education of Oklahoma State University. It contains software reviews written by teachers about educational programs for languages, sciences, mathematics, statistics, and more. A one-year subscription is \$15; additional subscriptions delivered to the same address are available for \$10 a year. For details, contact *CHIME*, College of Education, Oklahoma State University, 108 Gundersen, Stillwater, OK 74048, or call (405) 624-6254. ■

If you would like BYTE readers to know about your club or newsletter send the details accompanied by no more than one newsletter to Clubs and Newsletters, BYTE Publications, POB 372, Hancock, NH 03449. Overseas groups are encouraged to participate. Please allow at least three months for your announcement to appear.

a message to our subscribers

From time to time we make the BYTE subscriber list available to other companies who wish to send our subscribers material about their products. We take great care to screen these companies, choosing only those who are reputable, and whose products, services, or information we feel would be of interest to you. Direct mail is an efficient medium for presenting the latest personal computer goods and services to our subscribers.

Many BYTE subscribers appreciate this controlled use of our mailing list, and look forward to finding information of interest to them in the mail. Used are our subscribers' names and addresses only (no other information we may have is ever given).

While we believe the distribution of this information is of benefit to our subscribers, we firmly respect the wishes of any subscriber who does not want to receive such promotional literature. Should you wish to restrict the use of your name, simply send your request to the following address.

BYTE Publications Inc
Attn: Circulation Department
70 Main St
Peterborough NH
03458

What's New?

SOFTWARE



Time Manager Eyes Expenditures

Time Manager is just one of eight programs in Traveling Software's Business Manager Series for Radio Shack Model 100 and NEC PC-8201 computers. This program records time expenditures for projects, clients, and, if desired, by individual work activity. Hours worked can be logged as either billable or nonbillable with optional standard billing rates generated for work activities. Flexible reporting of summary information can be displayed on screen or printed out in either 40- or

80-column formats.

Time Manager costs \$59.95, which includes a tutorial notebook and audiocassette tutorial. The other programs in the Business Manager Series cover appointments, expenses, sales, projects, taxes, and accountant books. A communications program is also available. For more information, call or write Traveling Software Inc., 11050 Fifth Ave. NE, Seattle, WA 98125, (206) 367-8090.

Circle 550 on inquiry card.

Graphics Package Announced by Accent

A graphics creation and animation package for the Apple II or III has been introduced by Accent Software. TGS: The Graphic Solution combines text and graphics in a manner that's similar to cinematic animation techniques. This program provides simple keyboard commands that you

wield to build bit-mapped shapes, which are used to create interactive graphics presentations. TGS lets you mingle text and graphics on screen using its resident character set or your own fonts. Special graphics commands can be created with macroinstructions that enable execution of several

graphics tasks with a single keystroke. Multiple object and background, variable speed animation, dual low- and high-resolution operation, single-keystroke editing, and hidden line animation are provided.

TGS is fully compatible with graphics programs that permit saving high-resolution screens as standard Apple II DOS 3.3 files. Its hardware requirements are 48K bytes of RAM, Applesoft in ROM, one disk drive, and a monitor. The list price is \$149.95. A manual, backup disk, and demonstration applications are supplied. A demonstration disk is available for \$10 directly from Accent Software Inc., 3750 Wright Pl., Palo Alto, CA 94306, (415) 856-6505.

Circle 552 on inquiry card.

Program Knocks Spreadsheets on Their Side

Sideways lets you print all the columns of your spreadsheet, all at one time, on one continuous page. This program, developed by Funk Software, causes your hard copy to print out sideways and is compatible with such spreadsheets as Lotus 1-2-3, Visicalc, Multiplan, and Supercalc. Standard printing features include a choice of type sizes ranging from compressed to large, a double-strike mode, unlimited printing width, and adjustable character spacing, line spacing, margins, and print dimensions. Sideways accepts ordinary ASCII textfiles

created by spreadsheets, word processors, and editors.

Sideways works with the IBM Personal Computer. It supports such printers as the Epson MX-80/100 and FX-80/100, IBM Graphics Printer, Okidata's Microline series, C.Itoh Prowriter, and Integral Data Systems' Prism, 460, and 560. The suggested retail price is \$60. For more information, contact Funk Software Inc., POB 1290, Cambridge, MA 02238, (617) 497-6339. Circle 558 on inquiry card.

Executive Expense Account Manager

Adaptive Software's Expense Account Manager is purported to be the first microcomputer software package designed specifically to organize and track travel and entertainment expenses for company executives and professionals. Salient features include easy expense entry and corrections, reminders of expenses that are often overlooked, prompting for specific information required by the IRS, and budget projections. Expense subtotals can be organized by client or project, and a table of frequently traveled trips is maintained, which allows easy and consistent reporting of automobile mileage. Expense Account Manager automatically reconciles travel advances and tracks reimbursements. For ad hoc reporting of expense data, an interface to Visicalc is provided. Addi-

What's New?

tional features include the ability to print out pocket recording sheets for recording expenses as they are incurred and the ability to change expense items, budget lines, and subtotal definitions without programming.

The Expense Account Manager runs on 48K-byte Apple II Plus and IIe computers. It requires a disk drive and a printer. The suggested retail price is \$150. Contact Adaptive Software, 1868 Cavell Ave., Highland Park, IL 60035, (312) 831-4420. Circle 556 on inquiry card.

PC Chess Program

The Sfinks PC Chess program is designed for both beginners and experts. Program highlights include a problem mode, infinite levels of play, a dual chess clock, a save and restore function, multiple move take backs, move suggestions, and algebraic notation. Sfinks also has optional printout and audio signal capabilities. All United States Chess Federation rules, such as castling, en passant, and underpromotion, are observed. Monochrome and color graphics are supported.

The Sfinks PC Chess program runs on 64K-byte IBM Personal Computers. It's available on floppy disk for \$49.95 plus \$2 shipping, from William Fink, Suite 24-B, 1105 North Main St., Gainesville, FL 32601, (904) 377-4847. Circle 564 on inquiry card.

Multiple Applications on Screen at Once

Jack2 for the IBM Personal Computer lets you do word processing, spreadsheeting, charting, and database-management tasks on screen simultaneously without windows. One feature of Jack2 automatically changes the corresponding values in text or a bar graph when you alter a number in a spreadsheet. All screen data, such as a spreadsheet with explanatory text and a bar chart, can be printed out on a single page in the same manner as it appears on screen. Multiple columns of text can be displayed on the same page. Since word-wrap occurs within individual columns, text can be entered or deleted in any of the columns without affecting the layout of the other columns. Pages can be as large as 25½ inches wide, and horizontal scroll is automatic.

Jack2 spreadsheets can handle 1000 columns and rows, each of which can have as many as 255 values. Numeric values can be stored with up to 24 digits of precision. Additionally, Jack2 offers user-selectable automatic or manual recalculation, user-definable column widths, and right justify, left justify, or center entries. Other features include a two-line command area on top of the screen, a help line that explains what a command does, user-defined database and record formats, charting and printing functions, and the ability to hide a scratchpad and confidential information in text. Fields

can be deleted, added, or contracted, and three-level ascending, descending, alphabetic, and numeric sorts are permitted.

Two utility programs, a report generator and a data transfer program, are offered as options. Jack2 costs \$495. Contact Business Solutions Inc., 60 East Main St., Kings Park, NY 11754, (516) 269-1120. Circle 562 on inquiry card.

Accounting Programs for HP 150

BPI Systems announced the availability of a family of accounting packages for Hewlett-Packard's HP 150 personal computer. The packages are General Accounting, Personal Accounting, Accounts Payable, Accounts Receivable, Payroll, Job Cost, and Inventory Control. Each package can be used alone or integrated with other BPI software. The programs come on 3½-inch floppy disks and are supplied with documentation tailored for the HP 150. Each package retails for \$425 and is marketed through existing Hewlett-Packard outlets.

BPI Systems also produces software for such computers as the Apple, Commodore 8032, IBM Personal Computer, NEC PC 8000, Sanyo MBC series, Texas Instruments Professional Computer, and CP/M-based systems. Complete details are available from BPI Systems Inc., 3423 Guadalupe, Austin, TX 78705, (512) 454-7191. Circle 561 on inquiry card.

Prolog Interpreter Runs Under CP/M-80 MS-DOS

Micro-Prolog 3 is an extended Prolog interpreter for Z80-based machines running CP/M-80 and 8088/8086-based machines running MS-DOS. Prolog has enjoyed wide popularity abroad as a development language for intelligent databases, expert systems, and artificial-intelligence applications. Although tailored for microcomputers, Micro-Prolog 3 sacrifices none of the features of Prolog. Program development aids such as interactive text and structure editors, three trace utilities, and user-definable error trapping and recovery are standard.

Micro-Prolog 3 features user-friendly syntax, tail recursive programs run in bounded memory, a garbage collector, and the ability to wrap completed programs as protected modules that can communicate with other programs by means of import/export name lists. More than 60 primitive relations are provided, some of which include integer and floating-point arithmetic two-way conversation between constant and character lists, and formatted record I/O for intelligent database applications. Among its new extensions are user-definable commands and the ability to add new primitive relations using an integral systems interface to machine-code programs. Micro-Prolog 3 has an average speed of 240 resolutions per second on a 4-MHz Z80 or 8088 microprocessor.

What's New?

On CP/M-80 systems, Micro-Prolog 3 requires 48K bytes of memory; MS-DOS systems need 128K bytes. A single license with documentation is \$275. Additional computer licenses cost \$75. For full details, contact Prolog Systems, 54 Edgemont Rd., Milford, CT 06460, (203) 877-7988. Circle 563 on inquiry card.

Interactive Sales Aid

GINA is an interactive point-of-purchase sales aid designed to attract, inform, and entertain your customers. GINA (General Information and Analysis) is a self-paced, hands-on tutorial that acquaints customers with computer basics. It uses a simple question-and-answer format that helps to define and clarify customers' computer needs. After collecting data on your customers' needs, GINA presents them with a purchase proposal that is tailored to those needs.

Two versions of the program are available. Standard GINA recommends generic systems, while GINA+ suggests specific brand names that can be geared to your inventory. It runs on the IBM Personal Computer and its compatibles. Either version can also be purchased in almost any CP/M format. GINA costs \$295, and GINA+ is \$495. For more information, contact System Vision Corp., Suite 207, 199 California Dr., Millbrae, CA 94030, (800) 352-9999; in California, (415) 697-3861. Circle 559 on inquiry card.



SAT Study Program from Barron's

Barron's Computer Study Program for the SAT is tailored for high school students preparing to take the Scholastic Aptitude Test (SAT). This program purportedly helps students pinpoint academic strengths and weaknesses and prescribes a personalized study program. Four full-length, simulated SATs are provided, each featuring two modes of operation: Question and Test.

For each problem in the Question mode, the computer supplies an explanation of the correct response, an explanation of wrong answers for verbal questions, problem-solving strategies for mathematics questions, and a hint and a second chance to correct wrong answers. The Test mode provides uninterrupted and timed test-taking.

In addition, the program provides students with the number of questions answered correctly and incorrectly, a scaled SAT score, and the percentage of cor-

rect answers in 42 skill areas. Complementary workbooks address text, mathematics, and verbal skills. Sound effects and color are featured.

The Computer Study Program for the SAT comprises three double-sided floppy disks, a users manual, and three study guides. Versions are available for IBM PC, Commodore 64, and Apple II, II Plus, and IIe computers. The list price is \$79.95. A teacher's disk is offered. For more details, contact Barron's Educational Series Inc., 113 Crossways Park Dr., Woodbury, NY 11797, (516) 921-8750.

Circle 555 on inquiry card.

Utility Recovers Lost Files

You can reconstruct files with bad sectors, recover files from disks with damaged directories, and restore erased files with the Disk Fix-Disk Editor and Recovery Utility from the

Software Store. This utility automatically configures itself to floppy or hard disks and can display, edit, or copy any sector of a CP/M 2.0 disk. Other features include menus and on-screen editing in both hexadecimal and controlled ASCII.

Disk Fix works on 8080-, 8085-, or Z80-based computers with CP/M. It costs \$150 and is available in most 5¼- and 8-inch formats. For more information, contact the Software Store, 706 Chippewa Square, Marquette, MI 49855, (906) 228-7622.

Circle 553 on inquiry card.

Casino Pac Runs on Commodore 64

Advanced Microware recently introduced Casino Pac for the Commodore 64. Casino Pac includes four gambling games: Blackjack, Poker, Keno, and Slot Machine. Each game is said to be an accurate simulation of the video gaming machines being used in Las Vegas, Reno, and Atlantic City. Casino Pac is available on tape or floppy disk for \$39.

64Tour, a grand tour of the features and capabilities of your Commodore, is also available from Advanced Microware. It has demonstrations of all the 64's graphics modes as well as music and sound effects. It costs \$12.

Both programs can be obtained from Advanced Microware, POB 6143, Santa Ana, CA 92706, (714) 554-6470.

Circle 565 on inquiry card.

What's New?

Action Games Set on a River and In Space

Two games for the Commodore 64, River Chase and Galactic Battles, were recently released by Cyberia Inc. In River Chase, you must contend with enemy gunboats and perilous objects as you try to steer your boat safely home. Your fuel and explosives are limited, but you can replenish them at supply depots along the way. River Chase features color graphics, music, and six levels of play.

Galactic Battles is the saga of a space explorer ship that accidentally crosses into a new universe inhabited by an array of aliens. This game gives you three different scenarios to choose from. Graphics and sound effects heighten the action.

Both games require joysticks. They are available on floppy disk or cassette for \$19.95 each. For further information, contact Cyberia Inc., POB 784, Ames, IA 50010, (800) 247-3900; in Iowa, (800) 262-2004.
Circle 566 on inquiry card.

Business Graphics Package Runs on Rainbow

A business graphics package from the Redding Group, Graftalk runs on the DEC Rainbow 100. This device-independent software uses English commands interactively, runs commands from disk files, and uses customized or standard menus. It pro-

duces exploded pie charts, scatter diagrams, line and combination plots, and stacked, percentage, clustered, and floating bar charts. A range of move, draw, and other graphics and text commands are at your disposal, and a mini-spreadsheet and a text editor are provided.

Graftalk also supports the IBM PC and Zenith computers. Versions for NEC, Epson, and Victor computers will be available soon. For the DEC Rainbow, Graftalk is priced at \$450. For more details, contact the Redding Group Inc., 609 Main St., Ridgefield, CT 06877, (203) 431-4661.

Circle 567 on inquiry card.

Law Office Organizer

The Legal Assistant comprises five programs designed to increase productivity in the law office: Incorporating-by-Reference (IBR), Folio, Footnote, Grammatik, and the Random House Proofreader. IBR can be used for compiling client letters, contracts, wills, and briefs. A database manager, Folio stores and retrieves client records, indexes of legal documents, pleadings and briefs, bibliographies, and article abstracts. Footnote numbers and formats footnotes in Wordstar or Select files. Grammatik and the Random House Proofreader will check your documents for correct grammar and spelling, respectively. In addition, the Proofreader will let you

create your own dictionary of legal terms.

These programs are available in most popular micro-computer formats, including CP/M, MS-DOS, and PC-DOS. The Legal Assistant package is \$349. For full details, contact Digital Marketing Corp., 2363 Boulevard Circle, Walnut Creek, CA 94595, (415) 947-1000.

Circle 560 on inquiry card.

Model IV CP/M Has Interchange Utility

Montezuma Micro offers an implementation of Digital Research's CP/M 2.2 for the Radio Shack TRS-80 Model IV that has an Interchange utility capable of reading, writing, and copying more than 20 disk formats, including IBM, Kaypro, Osborne, and Xerox. A configuration program for 35-, 40-, 77-, and 80-track single- or double-density drives is built in, as is a utility that can format more than 50 different floppy disks. Additional features include full utilization of function keys, a 4-MHz clock speed, and ADM-3A emulation with reverse video.

Montezuma Micro has compressed the system code for CP/M 2.2 so that it will occupy only the first two tracks of a floppy disk, which leaves 170K bytes for storage. It works with either 64K- or 128K-byte Model IVs. Complete with utilities and a 300-page manual, this DOS costs \$199.95. Contact Montezuma Micro, Redbird Airport Hanger #8,

Dallas, TX 75232, (800) 527-0347; in Texas, (800) 442-1310.

Circle 554 on inquiry card.

A Fantastic Program for Printers

You can enhance your dot-matrix printouts with diagrams, charts, and special graphics characters with a new program from IHS Systems. Fantastic lets you create and incorporate such diagrams as electrical schematics or bar charts as part of the text in a standard PC-DOS file. A unique feature of this program is a full-screen font-creation utility that lets you change any standard Fontastic font, create new fonts, and add newly designed fonts to the resident library. Word-processing forms control and proportional printing are among Fontastic's other features.

Fontastic works with most popular word processors, including Benchmark, Easywriter 1.1, Peachtext, Volkswriter, and Wordstar. Printers such as the IBM Graphics, Epson MX/FX, C.Itoh Model 8510A, and Okidata Microline are supported. The program is supplied on two floppy disks; one has utilities while the other has more than 20 fonts to get you up and running. Fontastic runs on 128K-byte IBM Personal Computers. Address inquiries to IHS Systems, Suite 211, 4718 Meridian Ave., San Jose, CA 95118, (408) 265-5503.

Circle 551 on inquiry card.

What's New?

C Compiler for IBM

A full C language compiler for the IBM Personal Computer is available from Sure-Wing Systems. A complete implementation of C as defined by Kernighan and Ritchie, Sure-Wing C has full floating-point mathematics, a complete I/O library, and all standard C language structures, unions, and typedefs. With this two-pass compiler, assembled routines can be linked in and called from C routines. It produces OBJ files compatible with the PC-DOS linker. Program size can be up to 64K bytes of code and 64K bytes of data. The source code for the library functions is provided.

Sure-Wing C runs on the IBM PC or PC XT with 128K bytes of memory and either PC-DOS 1.1 or 2.0. Two 320K-byte floppy-disk drives or a combination of one floppy disk and a hard-disk unit are required. Sure-Wing C costs \$100. Updates will be available for \$10. A version for 8087-based IBMs is being developed. The compiler can be ordered from Sure-Wing Systems, POB 20008, Oakland, CA 94620, (415) 655-4773. Circle 557 on inquiry card.

LISP System for TRS-80

A fast machine-language LISP system for users of Radio Shack TRS-80 Models I/III and IV has been announced by Artificial Intelligence Technologies. This system offers standard LISP functions and is enhanced with such features as visual display capability

with pixel graphics and cursor addressability, random-access disk I/O, character-oriented I/O capabilities, user-selectable prompt, automatic closing of s-expressions with left and right brackets, abbreviated quoting, floating-point routines, and strings, files, and arrays as additional data types.

The LISP system comes with a manual containing an introduction to LISP fundamentals and detailed coverage of the use of the LISP interpreter, structurally-oriented editor, and the differentiator and algebraic simplifier. A poker player is provided. The system costs \$79.95. Full particulars are available from Artificial Intelligence Technologies, 2121 Northeast 152nd, Redmond, WA 98052, (206) 644-3068. Circle 568 on inquiry card.

Genealogy Program Handles 30 Generations

Cyclone Software's Patriarch I is a comprehensive genealogy system capable of tracking 30 generations. It offers three modes of relationships: that between two people, between one person and all the descendants of another, and all those related in a specific way to one person. Up to 26 children can be entered per person. Patriarch I lets you print family trees and generate an unlimited number of reports with up to 60 print conditions sorted on any of five fields. This fully relational database offers 50

user-definable fields, menu-driven operation, the ability to handle six indexes simultaneously, and the capacity to store 2144 characters per record.

Patriarch I is designed for 48K-byte Apple II Plus and IIe computers equipped with a disk drive and run-

ning under DOS 3.3. It costs \$195, which includes a manual with tutorials. For complete information and a sample printout, contact Cyclone Software, 3305 Macomb St. NW, Washington, DC 20008, (202) 362-8740.

Circle 569 on inquiry card.

Communications



Hayes Modem Bundled With Software

Hayes Microcomputer Products has announced the availability of a modem and communications software package for Apple computers. The Micro-modem IIe is a compact modem housed on a circuit board that slides into an Apple's expansion slot. It then connects directly to the telephone line, giving you the ability to communicate with other computers and timesharing and information services. It supports both Touch-Tone and rotary-pulse dialing and single- and multiline telephone connections. A built-in speaker lets you monitor calls as they are being made. Data rates are 110 and 300 bps. Micromodem IIe is Bell 103-type compatible, and it's FCC approved.

The Smartcom I communications software directs the Micromodem to place and answer calls and to send and receive files with

any of three transfer protocols, which are stop/start, send lines, and verification for error-free transfers between Hayes's programs. Smartcom routes data to a printer, stores three telephone numbers, and has a comprehensive set of variable communications parameters that are predefined for a common environment. This program will also create, delete, and display files and a directory. It can handle up to six disk drives, several printer cards, 40- and 80-column displays, and lowercase characters.

The suggested retail price for this package is \$329. Previous owners of the Micromodem II can obtain Smartcom for \$119. Contact Hayes Microcomputer Products Inc., 5923 Peachtree Industrial Blvd., Norcross, GA 30092, (404) 449-8791. Circle 572 on inquiry card.

What's New?



Customized Modem/Software Packages

Access 1-2-3 is a new family of customized data communications packages from Novation. The premiere system is designed for the IBM PC, IBM PC XT, Columbia Data Systems' Portable and Multi Personal Computers, the Corona Portable and Personal Computers, and the Compaq. Access 1-2-3 comprises Novation's PC1200B modem, necessary cables and accessories, and Multistuf's Crosstalk XVI software. Its suggested retail price is \$595.

The PC1200B is a smart modem featuring an extensive set of commands and responses that provide telephone line status. It has a built-in dialer with dial tone and busy detect, auto-answer, and audio monitoring through the computer's speaker. The PC1200B operates at 300 or 1200 bps, full duplex, and can perform an automatic self-test and receiver alignment at power-on. It can be put into analog or digital loopback modes. The modem requires a single expansion slot.

Crosstalk XVI is an intelligent terminal and file-



transfer program. It uses the PC1200B's features to accomplish auto-dial, automatic log-on, auto-answer, and disk-to-disk data transfers. It stores as many as 40 separate log-on passwords and IDs, which enables you to reach utilities or mainframes with a single keystroke. Stop bits, parity, data rates, and duplex operations are under its control, and extensive error-checking and retransmission are included. It provides the means for sending captured data to a printer, buffer, or floppy disk. Crosstalk also displays the transmission time for each file.

For additional information, contact Novation Inc., 20409 Prairie St., Chatsworth, CA 91311, (213) 996-5060.

Circle 576 on inquiry card.

Software Links Incompatible Computers

U.S. Digital's Copylink program provides the means for the high-speed transfer of text and program code between dissimilar computers and DOSes. Copylink also provides access to public database services, Telex and TWX capabilities, and emulation of both smart and dumb terminals. Its error-detection code supports binary file transfers, and its CP/M error recovery technique, with DOS extensions, prevents the loss of data by unintentional exiting from the program or by disk overflow during file transfers. An audible prompt signals an error condition. Standard features include the ability to receive more than one disk of data, modem data rates up to 1200 bps, single-keystroke operation of functions, auto-answer, auto-redial, automatic configuration of smart modems, full- and half-duplex transmission, display of previous file transfers, display of control characters, transmitter control for amateur radio transmission, a hard-copy option, and such user-defined parameters as originate/answer mode, parity, number of data and stop bits, and end-of-line sequence.

Copylink supports local data and program transfers between computers using 8- and 5¼-inch floppy-disk formats and machines running CP/M and MS-DOS. Its documentation includes a user's manual and *The Complete Handbook of Personal Computer Communications*. The sug-

gested retail price is \$99. User and dealer information is available from U.S. Digital Corp., 5899-D Southeast International Way, Milwaukie, OR 97222, (503) 654-0668.

Circle 573 on inquiry card.

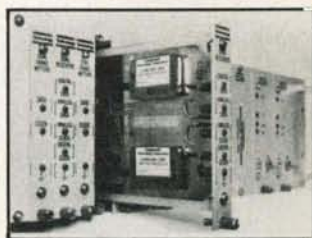

Secure Networks Safeguard Communications

Complete computer networks that are said to be virtually untappable are produced by Codenell Technology Corporation. The Codebeam line-of-sight optical communications system, the Codenet fiber-optic Ethernet local-area network, and the Codelink fiber-optic computer network transmit signals either through thin fiber-optic cables or by means of light beams. The Codenet-2020 Transceiver is compatible with Ethernet interface equipment through a 15-pin transceiver cable. It works with the Codestar passive star coupler to create a fiber-optic Ethernet network. This system enables the computer network to be removed from telephone lines, improving security and reducing operating costs.

For interbuilding networking, the Codebeam-

What's New?

20 line-of-sight system can link networks without cables or telephone connections over distances of up to 2 kilometers. Large multisite computer networks can be implemented with the combination of the Codenet, Codelink, and Codebeam. For technical specifications, possible configurations, and purchasing information, contact Codennell Technology Corp., 1086 North Broadway, Yonkers, NY 10701, (914) 965-6300.

Circle 570 on inquiry card.



Modem Can Transmit at 76,800 bps

The LVS 76.8 limited-distance modem from Complex Systems can send data 16,250 feet (5000 meters) on 22-gauge wire at 76,800 bps, and even greater distances can be achieved by transmitting at slower speeds or on heavier-gauge wire. The LVS has a front-cover thumbwheel that lets you select from eight synchronous speeds ranging from 2400 to 76,800 bps and LED indicators for power, data transmit, data receive, carrier detect, and testing. It can operate in point-to-point, multidrop polled, half-duplex two-wire, and full-duplex four-wire modes. The LVS is equipped with a Bell 43401-compatible switch. Additionally, the LVS is programmed to pro-

vide local and remote loopback.

Complex Systems offers the LVS 76.8 with either an EIA RS-232C digital interface or with a V.35 interface. The retail price for the RS-232C model is \$650,

and the V.35 version is \$725. For more information, contact Complex Systems Inc., 4930 Research Dr., Huntsville, AL 35805, (205) 830-4310.

Circle 574 on inquiry card.

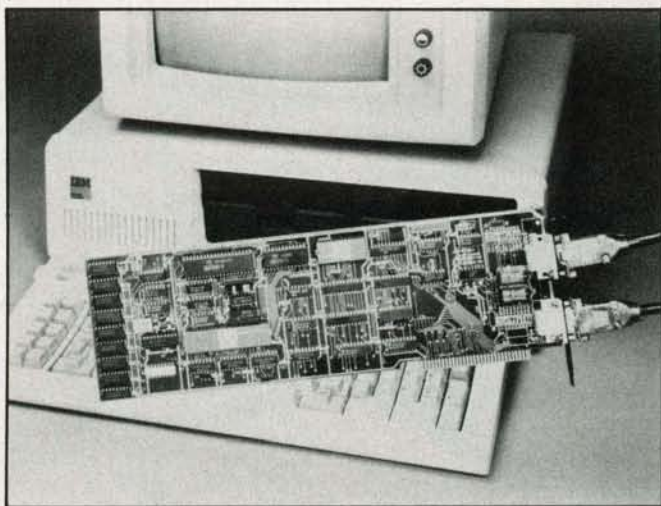

254 IBM PCs Linked with Percomnet

A user-installable local-area network, Percom Data Corporation's Percomnet interface for the IBM Personal Computer can link up to 254 nodes per network. Called the PN-IBM, this network interface plugs into the host computer and then is linked to the network through a data cable interface. At the heart of the PN-IBM is Western Digital's WD2840 network control processor. The WD2840 is designed to handle major communications tasks as they relate to the network token-access protocol, including network initialization, addressing, data transmission, acknowledgments, and diagnostics. Global addressing and dynamically alterable

station priority are supported. Other key features include NBS data encryption for data security, signal regeneration at each node in order to maintain high signal-to-noise ratios, and a built-in 64K-byte FIFO buffer to speed data transmissions. PN-IBM supports simultaneous voice and data transmissions and is available with MS-DOS-, CP/M-, or Unix-compatible software.

Percomnet interface adapters will soon be announced for S-100, Multi-bus, and STD bus computers. Technical specifications are available from Percom Data Corp., 11220 Page Mill Rd., Dallas, TX 75243, (214) 340-5800. Circle 571 on inquiry card.

Network Interface Unit for IBM and TI Computers

Ungermann-Bass has announced an intelligent Ethernet-compatible network interface unit (NIU) that allows IBM PC and Texas Instruments Professional Computers to share information and resources and integrate with large mainframes using IBM SNA protocols.

An extension of the company's Net/One general-purpose local-area network, the Net/One Personal Connection is based on the Personal NIU, a plug-in board with on-board intelligence to handle all communications. PCs configured with these NIUs can run any application programs under MS-DOS without modification. Applications can be shared across the network. Also featured are XNS protocols, and support for Ethernet and thin coaxial cabling. Net/One uses SNA gateways that let users access mainframe-based application programs. (SNA gateways are computers running software that permits them to emulate IBM 3274 controllers or 3278 terminals and 3287 printers.)

The Personal NIU costs \$850, which includes MS-DOS networking commands. Quantity discounts are available. Print and disk-sharing software packages on 5 1/4-inch floppy disks are \$500 per server. For complete details, contact Ungermann-Bass Inc., 2560 Mission College Blvd., Santa Clara, CA 95050, (408) 496-0111. Circle 575 on inquiry card.

What's New?

On-line Brokerage

C. D. Anderson & Company, a San Francisco-based brokerage house, has announced that the Desk Top Broker financial service is on line. The Desk Top Broker lets you make transactions, maintain portfolios, see current stock prices, and check such data as change from previous close through your personal computer 24 hours a day, seven days a week. A unique feature of this service is an electronic-mail facility that enables you to make requests, such as transferring securities between cash and margin accounts, and notifies you that your orders have been carried out. A Stock Watch mode will track various aspects of up to 18 selected stocks, sound an alarm if a price changes, and alert you when a stock falls or rises above preset buy-and-sell limits. Additionally, you can maintain three separate portfolios, keep up-to-date tax records that reflect trade transactions, and attach conditions to buy orders. All the information stored in the Desk Top Broker can be transferred to a spreadsheet program for analysis and chart production. Double password security ensures data integrity.

Users of the Desk Top Broker are billed with a one-time charge of \$300, which includes required software and registration fees. On-line connection fees range from \$0.40 per minute during business hours to \$0.10 per minute nighttime and weekends. Transaction charges are levied. Costs associated with the Desk Top Broker are said to be

generally tax deductible. The system works with modem-equipped Apple and IBM Personal Computers. Inquire about its availability for other systems. Further details can be obtained from C. D. Anderson & Co., Suite 440, 300 Montgomery St., San Francisco, CA 94104, (415) 433-2120.

Circle 577 on inquiry card.

Low-cost Modem Uses TI Chip

The Micromint's ECM-103 build-it-yourself 300-bps modem is based on Texas Instruments' NMOS-technology TMS99532 FSK modem chip. The TMS99532 features all the necessary modulation, demodulation, and circuitry required for a full-duplex serial asynchronous communications link and eliminates many discrete components, reducing size and improving reliability. The ECM-103 is completely crystal-controlled and is suitable for acoustic or direct telephone-line connection through an FCC-registered data-access arrangement. Connection to data terminal equipment is EIA-standard RS-232C connector. No calibrations or adjustments are required, and it does not use external filtering or frequency set-point components.

The ECM-103 comes complete with all components, a printed-circuit board, RS-232C and power connectors, and an assembly manual. It costs \$60 and is available direct-

ly from the Micromint Inc., 561 Willow Ave., Cedarhurst, NY 11516, (516) 374-6793; or (800) 645-3479 (orders only). Circle 579 on inquiry card.

Source Subscription Free with Modem

Apple users will receive a permanent subscription to The Source database service free of charge with the purchase of the Networker modem from Zoom Telephonics. The Networker, a

single-slot 300-bps modem, combines Apple communications circuitry and modem functions on a single card with direct low-noise modular-telephone connections. It works with Apple II, II Plus, and IIe computers. A floppy disk containing communications software is included in the Networker's \$129 price tag. For the name of your nearest Networker dealer, contact Zoom Telephonics Inc., 207 South St., Boston, MA 02111, (617) 423-1072. Circle 578 on inquiry card.

PRINTERS

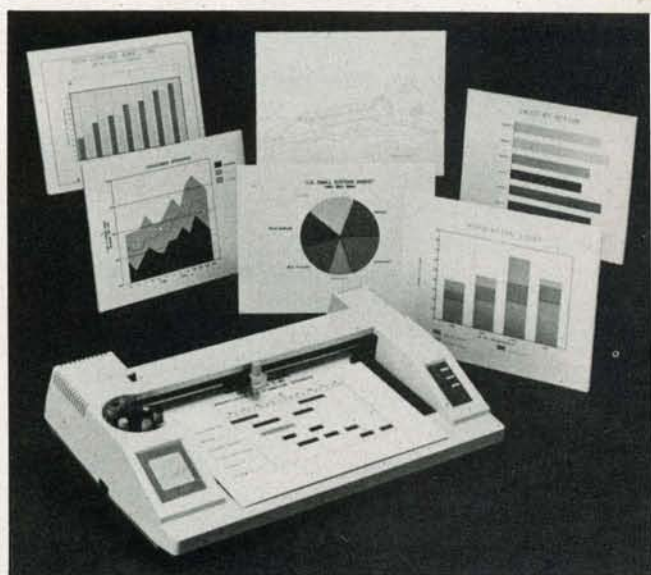

Six-color Plotter Plots Graphs at 14 IPS

A fully automated six-pen plotter, the Sweet-P Model 600 Six-Shooter is produced by Enter Computer. Standard features include a 14-ips plotting speed, 3g acceleration, RS-232C and parallel interfaces, 19 character sets, self-test, and a 2K-byte buffer. Its six pens, housed in a rotating carousel, are automatically capped after use.

Normally, the Six-Shooter plots with fiber-tip pens, but when necessary it can use a ballpoint or, for CAD applications, radiograph-type pens. It can draw on both 8½- by 11-inch and 11- by 17-inch paper, and it can create overhead transparencies. Operating features include pause and pen-selection keys and bar, pie, and polygon fill.

What's New?

The Six-Shooter senses whether it's connected to a serial or parallel port and automatically switches from one to the other. In the serial mode, it can be used as a shared resource. You can place it between a computer and printer or between a terminal and printer and, operating in its eavesdrop mode, program it to perform only those tasks you want. All graphics software that supports the single-pen Sweet-P Model 100 will work with the Six-Shooter. It operates with Enter Computer's SPGL graphics language and is

compatible with Hewlett-Packard's HPGL graphics language. It works with Apple and IBM computers, their compatibles, and CP/M-based systems.

Buffer expansion of up to 8K bytes and a choice of pens in 12 colors are options. The retail price for the Sweet-P Model 600 Six-Shooter is \$1095, including pens, paper, and operating manual. For more details, contact Enter Computer Inc., 6867 Nancy Ridge Dr., San Diego, CA 92121, (619) 450-0601.

Circle 580 on inquiry card.

Printer Mechanism Targeted at OEMs

An 80-column printing mechanism targeted at the OEM and system-integrator market has been announced by Hi-G Printers Corporation. The Model 9/80 ME printer mechanism features independent horizontal- and vertical-axis control for accurate dot placement in multipass printing and graphics output. Using a standard 9- by 7-dot array and off-the-shelf ribbons, the 9/80 ME will print at speeds as high as 200 cps. The unit has front, bottom, and rear paper entrances and top and bottom exits. It has provisions for internal roll paper and for mounting a sheet feeder for 8½- by 11-inch cut paper or envelopes. The 9/80 ME accepts externally housed, fan-folded, sprocket-driven paper and can handle standard paper stock, carbon or carbonless forms, and

gummed or pressure-sensitive labels. It's furnished with a nine-wire printhead and a standard tractor drive. Its physical specifications are 5⅞ inches high by 20¾ inches wide by 16¼ inches deep. It weighs 17 pounds. All critical components, such as the printhead, ribbon motor, and carriage subassembly, are manufactured by Hi-G Printers.

The 9/80 is also available in a reverse tractor, demand-document version featuring a dedicated paper chute. An 18-wire printhead can be furnished. Evaluation quantities cost \$299 each. Delivery is from stock. For additional information, contact Hi-G Printers Corp., 96 West Dudleytown Rd., Bloomfield, CT 06002, (203) 242-3048.

Circle 605 on inquiry card.



Portable Printer Weighs In at 16 Pounds

Sprinter is an 80-column, 160-cps portable printer from Micro Peripherals Inc. This 16-pound dot-matrix printer features an IBM-compatible parallel port, high-speed skipover, five character sets, built-in friction- and tractor-feed mechanisms, user-programmable character sets, a 4K-byte buffer, and graphics capabilities. Its base price is \$795.

The Sprinter can be ordered with a unique option called the Softswitch. Softswitch is a keypad that provides a simple way to change the printer's operating functions. It offers control over such functions as horizontal tabbing, alternate character-set selection, form length, linefeed on carriage return, and vertical line density. A battery-backed RAM that retains user-set functions when the power is off completes the Softswitch option.

Additional options for the Sprinter include up to 68K (34 pages) of data buffers and IEEE-488 and RS-232C interfaces. A carrying

case will be offered after the first of the year. The base price is \$795. For full particulars, contact Micro Peripherals Inc., 4426 South Century Dr., Salt Lake City, UT 84107, (800) 821-8848; in Utah, (801) 263-3081.

Circle 582 on inquiry card.

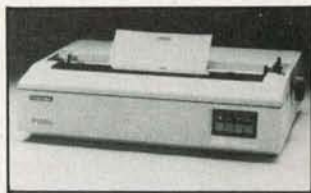

P1350 Works with Variety of Micros

Toshiba's P1350 desktop dot-matrix printer will now work with microcomputers from such manufacturers as Apple, DEC, and IBM. The P1350 produces letter-quality correspondence, high-speed drafts, and dot-addressable graphics with a 24-pin printhead that uses fine-wire 8-mil pins to overlap dots in a single pass. When in the letter-quality mode, this printer

What's New?

operates at 100 cps. Draft work runs at 192 cps, and graphics are printed at a density of 180 by 180 dots per inch.

The P1350 is a 132-column printer that yields an original plus three copies on letter-sheet or continuous-form paper that can be as wide as 15 inches or as narrow as 5 inches. Qume Sprint 5 emulation, an enhanced Courier font, and software-selectable multiple fonts, pitches, and line spacing are standard. For feeding

paper, the P1350 can be equipped with a friction roller or with optional pin-feed tractor or sheet feeders. The standard interface is Centronics parallel. An RS-232C serial interface is available as an option at no extra charge.

The P1350 retails for \$2195. For more information, contact Toshiba America Inc., Information Systems Division, 2441 Michelle Dr., Tustin, CA 92680, (714) 730-5000. Circle 677 on inquiry card.



Low-cost Impact Printer

The Impact Printer works with Fidelity Electronics' Desk Companion and the Commodore VIC-20 and 64. This dot-matrix printer offers 24, 32, or 40 columns of uppercase and lowercase 5- by 7-dot-matrix characters. Standard features include 30-cps operation, dot-addressable graphics, reverse character mode, and two character sets. A power-on LED and manual controls for power on and off and paper feed

are provided. The mean time between failures is approximately 50,000 lines. The Impact Printer measures 4 inches wide by 4½ inches long by 2 inches high. Standard 2¼-inch adding-machine roll paper is required.

The suggested retail price is \$129.95. For more details, contact Fidelity Electronics Ltd., 8800 Northwest 36th St., Miami, FL 33178, (305) 888-1000. Circle 681 on inquiry card.

Graph Option for Plotter

Yokogawa Corporation of America has announced the availability of a PROM option for its PL-1000 four-color plotter. The PROM provides the plotter with the ability to generate pie, line, and bar graphs without external programming. In addition, it provides cross-hatching and lettering/labeling capabilities. The PL-1000 has a stan-

dard RS-232C interface and plots on paper or foil as large as 11 by 15 inches.

The PROM option costs \$215. For current owners of the plotter, the option is available as a factory-installed retro fit. For more details, call or write Yokogawa Corp. of America, 2 Dart Rd., Shenandoah, GA 30265, (404) 253-7000. Circle 678 on inquiry card.

PERIPHERALS



Image Processing Camera Sees for Micros

Datcopy's Model 610 electronic digitizing camera lets you enter photos, documents, or three-dimensional objects into your office's desktop computer without the use of a keyboard. The 610 captures an image through a standard 35-mm camera lens. Inside the unit, a linear array of 1728 solid-state photosensors is

physically scanned across the image, translating it into computer-readable digital code. Image information is then organized into a matrix of 4.9 million cells, called pixels (picture elements). A digital converter changes the information into the digital equivalent of the optical image on a pixel-by-pixel basis. The image

What's New?

represented in two dimensions with shades of gray, can now be displayed, printed out, or stored in the computer's memory.

The 610 requires little illumination, even when capturing microfiche, drawings, or printed text. A complementary product, the Model 110 Image Processing Interface, provides image-capture software and the ability to work with the IBM Personal Computer. For systems integrators and software houses using the IBM, the Model 90 Integrated

System is offered. This system is made up of the 610 camera, the 110 interface, and such accessories as the camera power supply and cables.

The Model 610 electronic digitizing camera has a \$7850 end-user price. The Model 110 and Model 90 list for \$795 and \$9945, respectively. Address inquiries to Datacopy Corp., 1070 East Meadow Circle, Palo Alto, CA 94303, (415) 493-3420.

Circle 592 on inquiry card.



Joystick for Apples and IBMs

The Data Spec line of joysticks works with Apple II, I, and IBM Personal Computers. One model in the line, the Model IB-XY-23, is plug-compatible with the IBM PC. It's designed to meet the demands of the commercial/industrial market. Standard features include linear potentiometers, a metal enclosure for maximum shielding and stability, dual X-Y fine centering, positive feel push buttons, and a four-foot cord. The suggested retail price is \$69.95. Contact Ora Electronics, 18215 Parthenia St.,

Northridge, CA 91325, (213) 701-5848.

Circle 587 on inquiry card.

Multifunction A/D I/O Subsystems

The PC-DAX Subsystem provides multifunction data-acquisition and control capabilities for a variety of computers. A minimum configuration comprises a PC-DAX enclosure with interface to a host computer and LDT2801 series analog

and digital I/O boards. The LDT2801 board includes 12- or 16-bit A/D converter for 16 single-end or eight differential analog input channels, software-selectable gains of 1, 2, 4, and 8 to accommodate a range of signal levels, analog outputs, digital I/O, direct memory access, and a programmable clock. Sampling rates can be as high as 22,000 samples per second. The LDT2801 boards are built around an on-board microprocessor that acts as an interface to the computer, controls all analog and digital operations, and facilitates program control by the host computer. To initiate repetitive conversion events, the LDT2801 has an internal system clock that's programmable for periods ranging from 5 microseconds to 0.1638 seconds, in 2.5-microsecond increments. Other boards provide periods of 2.5 microseconds to 0.0819 seconds with 1.25-microsecond increments. All boards provide for an external clock, which enables synchronization of multiple A/D or D/A conversions with a frequency source. Two LDT2801 boards can be installed in a single PC-DAX. They can be programmed in any language resident in the host computer.

Two screw terminal/signal conditioning panels and software subroutine packages are available as options. For data sheets and complete price information, contact Data Translation, 100 Locke Dr., Marlboro, MA 01752, (617) 481-3700.

Circle 593 on inquiry card.

Trilo Enhances IBM PC

PC Ware has introduced three products for the IBM PC and PC XT: a parallel printer adapter, a serial communications adapter, and a 256K-byte RAM board. The parallel printer adapter, which can serve as a general-purpose I/O port, offers 12 buffered TTL latched outputs, five buffered TTL inputs, software-controlled interrupts, and full software programmability. It costs \$89.95.

The software-programmable asynchronous RS-232C serial communications adapter supports full- and half-duplex operations. Its crystal-controlled data rates are software-programmable from 50 to 19,200 bps and include 134.5 bps. Among its other features are a simple DCE/DTE configuration header; a programmable control register; double-buffered data; parity, overrun, and framing error checks; hardware selection of I/O mapping; support for such modem controls as CTS, RTS, DTR, RI, and carrier detect; four handshake signals; line-break generation and detection; and fully prioritized interrupts to control transmit, receive, error, line status, and dataset interrupts. The suggested price is \$94.95.

The RAM board offers DIP-switched addresses, selectable on any 64K-byte boundary. A bare board costs \$189.95. With RAM chips, it ranges from \$229.95 (64K bytes) to \$349.95 (256K bytes).

For full details on these products, call or write PC

What's New?

Ware Inc., 4883 Tonino Dr., San Jose, CA 95136, (408) 978-8626.
Circle 600 on inquiry card.

Color Graphics Adapter for Eagles

A single card providing the Eagle PC, Eagle 1600 Series, and the IBM PC with a color display and graphics capabilities is now being marketed by Eagle Computer. This color graphics adapter, which can operate in color or monochrome, features two basic modes of operation: alphanumeric and all-points-addressable graphics; additional operating modes are available from within these formats. A medium resolution of 320 by 200 pixels and 16 foreground and 8 background colors are offered in the color mode. In the monochrome mode, a high-resolution display of 640 by 200 pixels is achievable. Also featured in the monochrome mode are reverse video, blinking character, and highlighting. Character blinking is offered in the color mode.

The color graphics adapter will link the Eagle to a display through a composite video port, a direct-drive RGB port, or an interface for driving a user-supplied RF modulator. The adapter costs \$295. For more information, contact Eagle Computer Inc., 983 University Ave., Los Gatos, CA 95030, (408) 395-5005.

Circle 599 on inquiry card.



Bar-Code Reader Supports 39 and Interleave 205 Codes

Percon's E-Z-Reader bar-code reader supports 39 and interleave 205 industrial bar codes. It provides operator feedback and can read dot-matrix and medium-density printed labels. Operator feedback is provided by a beeper, two host-controlled LED status indicators, and a low-frequency tone. Communications is standard RS-232C, eavesdrop,

or with a stand-alone computer. The digital wand is produced by Hewlett-Packard.

The E-Z-Reader costs \$395. An operating and installation manual is available for \$20. Dealer and OEM inquiries are invited. Contact Percon, POB 1352, Eugene, OR 97440, (503) 688-3374.

Circle 595 on inquiry card.

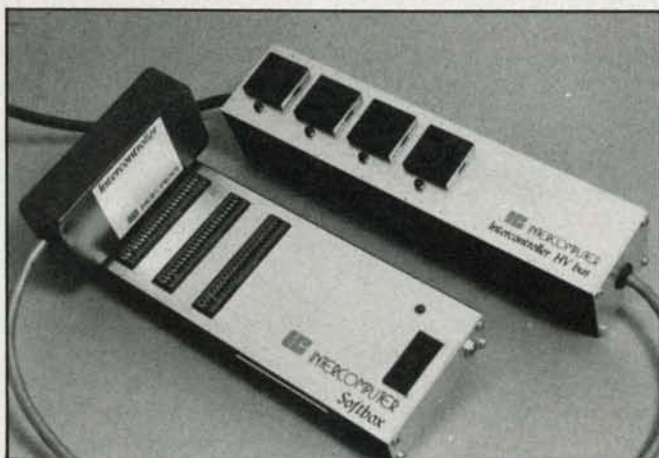

Expansion Box and Control Device Introduced

Intercomputer has introduced two interrelated products that are compatible with Timex/Sinclair,

Commodore 64 and VIC-20, and Texas Instruments 99/4A computers: Intercontroller and the Softbox. Inter-

controller is a programmable control unit that lets you control electrical devices with your computer. It has four standard electrical outlets that you can program using a few simple BASIC commands. The Softbox expansion box has four software-selectable slots that are used with program cartridges and the Intercontroller. It also contains an extra peripheral port.

A nonvolatile memory cartridge and temperature, sound, and light sensors will soon be available for the Softbox, which costs \$59.95. A required connector cable is available for \$17.95. Intercontroller is \$99.95. For dealer information or to place an order, contact Intercomputer Inc., 358 Chestnut Hill Ave., Boston, MA 02146, (617) 738-5310.

Circle 591 on inquiry card.

Autocrat Provides Remote Control over AC Lines

The Autocrat is a power-line communications product from Bi-Comm Systems. This microprocessor-based controller is used to remotely control electrical devices through existing AC wiring. It plugs directly into a standard wall socket, where it transmits and receives signals over the AC lines. Up to 256 Leviton CCS accessories and BSR X-10 devices can be controlled by Autocrat. A battery-backed CMOS clock/calendar, a firmware operating system in EPROM, memory from

What's New?

data and applications program storage, and self-diagnostics are included with Autocrat. It can operate as a stand-alone unit, as a computer-controlled interface, or under telephone modem control.

Autocrat is compatible with computers, terminals, and energy-management controllers equipped with

an RS-232C port. The manufacturer will develop custom applications software by contract and support customers developing their own software. Autocrat costs \$485 and is available factory-direct from Bi-Comm Systems, 10 Yorktown Court, St. Paul, MN 55117, (612) 481-0775.

Circle 590 on inquiry card.

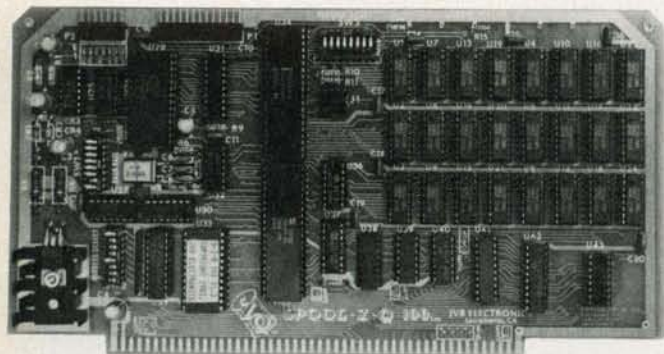

Buffer Can Handle 256K

An S-100-compatible printer buffer capable of handling up to 256K bytes of memory, the Spool-Z-Q 100 works with both serial and Centronics-type parallel printers. Its on-board microprocessor handles all protocols and handshaking, and an open socket is available for a switch panel that lets you control Copy, Clear, Buffer, and self-test functions. The Spool-Z-Q has Normal and Pause-on-Form-Feed modes that provide for both normal buffered printing and a pause for, say, inserting another sheet of paper. Several protocols are supported, including Xon/Xoff, ETX/ACK, ENQ/ACK, and DTR. For

the serial interface, Spool-Z-Q provides switch-selectable data rates, parity, and word length. The data rates are 150, 300, 600, 1200, 2400, 4800, 9600, and 19,200 bps.

The Spool-Z-Q, which uses 4164-type chips, is fully socketed for 256K bytes of memory. Memory sizes available are 32K, 64K, 128K, and 256K bytes. Prices range from \$319 for a 32K-byte buffer to \$529 for the fully loaded version. For more information, contact JVB Electronics, Suite 10A, 1601 Fulton Ave., Sacramento, CA 95825, (916) 483-0709.

Circle 594 on inquiry card.

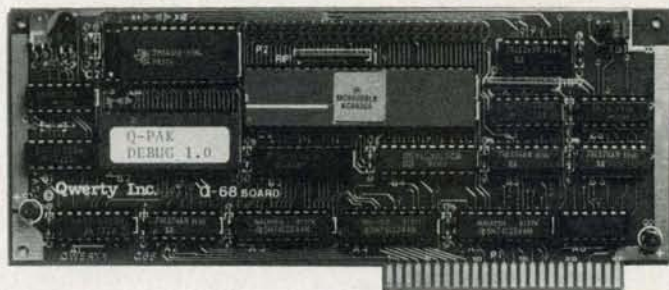

Add-on Package Turns Apple into 68000 Development System

The Apple II can be converted into a 68000 assembly-language development system with the Qpak-68 board and software package from Qwerty Inc. Qpak-68 comprises a plug-in board to run 68000 programs, an editor/assembler to create 68000 source code, a debugger, and support documentation. The board plugs directly into the Apple and uses the 68008 microprocessor, which is an 8-bit software-compatible version of the 68000. The 68008 is driven by the Apple's clock, which permits it to run parallel with the 6502 in the Apple. The processor can be started, stopped, or interrupted at any time from the Apple.

The Qpak board is able to run directly out of the Apple's memory. It shares the Apple's 64K-byte memory space and can access the same memory and peripherals as the Apple's 6502 processor, including the high-resolution display. It comes with 8K bytes of local EPROM and 2K bytes of RAM, expandable to 32K and 8K bytes, respectively. The debugger, resident in EPROM, displays five screen windows to monitor or

change registers or memory and to set breakpoints. It includes instruction single-step and disassembly. The source-code development package, which comes on an Apple-compatible disk, can assemble 68000 programs with object code larger than 8K bytes directly from RAM. Larger programs can be assembled from Apple disks.

The complete Qpak-68 package costs \$695. It's available directly from Qwerty Inc., Suite 600, Chesapeake Dr., San Diego, CA 92123, (619) 569-5283. Circle 589 on inquiry card.

Scanner Recognizes Characters and Images

When connected to an RS-232C port, Symeon & H. Corporation's Cosmos CAX-21 image-scanning system transfers images and printed characters to a personal computer. Salient specifications include a scanning width of 3.3 mm and a 0.16- by 0.16-mm per dot scanning rate. Power requirements are 9 to 12 volts DC or 110, 115,

What's New?

220, or 240 volts AC at 50 or 60 Hz, with an AC adapter. Accessories include software, a scale, RS-232C interface cable, power adapter, and a base plate. Presently, the software for CAX-21 works with the Apple II; however, the programs are being converted for other computers.

Cosmos CAX-21 features two software-based scanning modes: List Reader and Image Scanner. Program listings, documents, and other characters produced by serial dot-matrix printers can be read and transmitted to your computer with List Reader.

If the transmitted characters match a user-created standard pattern, they are displayed on your video monitor. Recognized characters can be stored on disk for later printout. The Image Scanner handles printed or hand-drawn illustrations, maps, and other images. Image editing is possible through the keyboard. Hard copies can be produced. Its maximum image size is 180 by 180 mm.

For more information, contact Symeon & H. Corp., 5676 Francis Ave., Chino, CA 91710, (714) 627-9887.

Circle 596 on inquiry card.

Half-Megabyte Bubble Memory for IBM

A half-megabyte bubble-memory board designed to emulate a mini-Winchester disk drive inside the IBM Personal Computer is available from Helix Laboratories. The PC Bubble Board is said to respond to fixed-disk commands under most operating systems, including MS-DOS 2.0, Softech Pascal IV.13, and CP/M-86 for the IBM PC XT. Among the software features available to users are Restore, Backup, and partitioning to hold multiple operating systems. The solid-state PC Bubble has four 1-megabit Intel 7110 bubble memories, a 40-millisecond access time, and a data transfer rate of 400,000 bits per second.

The PC Bubble Board will also work with such computers as the Corona and Compaq. It costs \$1495.

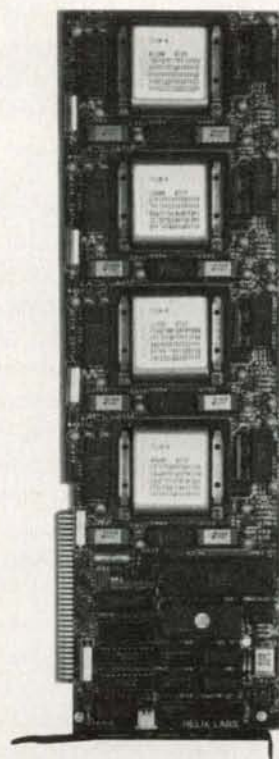

Complete specifications are available from Helix Laboratories Inc., Suite 106A, 16776 Bernardo Center Dr., San Diego, CA 92128, (619) 451-0270.

Circle 586 on inquiry card.

SYSTEMS



80186-based Systems Run Concurrent CP/M

Onyx Systems' 186 Series of 16-bit desktop computers is based on Intel's 80186 processor and is capable of running Concurrent CP/M-86. A basic configuration has a display terminal, 256K bytes of RAM, and 1 megabyte of floppy-disk storage. The 14-inch nonglare blue- or green-phosphor display features the 256-character ASCII set and business graphics capabilities. The terminal tilts and swivels and has a 104-key intelligent keyboard. A numeric keypad, cursor-control pad, 28 function keys, and a standard typewriter format are featured.

Expansion capabilities provided include six RS-232C serial ports, an 8-bit Centronics-compatible parallel port, and two disk/tape ports. Additional expansion options include up to 512K bytes of RAM, a cabinet to house drives and backup tape cartridges, 1

megabyte of floppy-disk storage, and 7-, 14-, or 21-megabyte 5¼-inch Winchester hard-disk drives. The Onyx 186 Series is available with Concurrent CP/M-86, Oasis-16, or MBOS/BB3 for multiple users and MS-DOS for single users.

Prices for complete workstations begin at \$4495. For complete details, contact Onyx Systems Inc., 25 East Trimble Rd., San Jose, CA 95131, (408) 946-6330.

Circle 609 on inquiry card.

PC Plus and PC Deluxe Run MS-DOS

The PC Plus and the PC Deluxe from Scottsdale Systems run MS-DOS programs as well as a number of PC-DOS programs. The PC Plus is an 8088-based machine that's outfitted with a 160K-byte floppy-disk drive, 256K bytes of RAM, a printer

What's New?

spooler, a parallel printer port, and color/monochrome video output. System software includes Ramdisk, MS-DOS, Wordstar, Calcstar, Easywriter, and Sanyo Color BASIC. It costs \$999.

In addition to the software supplied with PC Plus, PC Deluxe comes with

Easy Planner, Easy Filer, Easy Mailer, and Easy Speller. It also has two floppy-disk drives. Its price is \$1399. For more information, contact Scottsdale Systems Ltd., 617 North Scottsdale Rd. #B, Scottsdale, AZ 85257, (602) 941-5856.

Circle 604 on inquiry card.

80-column display capabilities. Both versions are supplied with an operator manual and a BASIC handbook.

Options include a modem and parallel printer attachment. The IBM PCjr is available at IBM Personal Computer dealers. IBM Entry Systems Division, POB 2989, Delray Beach, FL 33444.

Circle 601 on inquiry card.



IBM PCjr Available in Two Versions

A 16-bit 8088-based computer, the IBM PCjr is available in two versions: a \$699 system unit and a \$1269 slim-line floppy-disk drive model. The basic PCjr features a cordless keyboard that transmits keystrokes to the main unit by infrared signals at distances of up to 20 feet. Each of its 62 keys can be programmed for custom applications, and its function keys are color coded.

Standard equipment includes 64K bytes of ROM, two cartridge slots, 64K bytes of RAM, a serial port, cassette level BASIC, sound and graphics subsystems, and interfaces for a cassette,

two joysticks, keyboard, modem, floppy disk, light pen, direct video, composite video, and television. To help new computer users get started, the PCjr comes with a ROM-based program that uses graphics, colors, and sound to highlight the keyboard.

The PCjr can display 40 columns of text on a television, composite display, or a direct-drive color monitor with the addition of an optional adapter or connector. The enhanced PCjr has 80-column display capabilities and comes with 128K bytes of RAM, 360K bytes of floppy-disk storage, and a pair of tutorial disks. It has

2000 Uses 80186 Chip, Two DOSes

A 16-bit Intel 80186-based computer, the System 2000 was recently unveiled by Monroe Systems for Business. Supplied with two DOSes, MS-DOS and CP/M-86 DPX, and GW BASIC, the 2000 will support such languages as Pascal, FORTRAN, C, and COBOL. Single or dual 5¼-inch floppy-disk drives, 128K or 256K bytes of RAM, a monitor, a parallel printer port, five expansion slots, and a clock/calendar are standard. Mass-storage capacities are 720K bytes per disk under MS-DOS or 640K bytes under CP/M-86. The 2000's twin RS-232C serial ports offer programmable data rates ranging from 75 to 19,200 bps and are offered with asynchronous or synchronous and synchronous capabilities. The low-profile, detached keyboard that comes with the System 2000 has separate cursor and numeric keypads, four application-defined program keys,

and 10 user-defined function keys.

The 12-inch amber monochrome monitor is backed by 128K bytes of dedicated RAM. The anti-glare screen can display 2000 characters in an 80-column by 25-line format while offering 640-by-400-pixel bit-mapped graphics capabilities. Its 256 IBM-compatible character set can be produced with such attributes as reverse, underline, high-intensity, blinking, and nondisplay black or white. The tilt and swivel pedestal can also accommodate a 14-inch, 16-color RGB monitor.

Options include a Z80A coprocessor, RAM expansion up to 896K bytes, up to three RS-232C interface boards, internal or external hard-disk drives, and letter-quality and dot-matrix printers. Word-processing, spreadsheet, database-management, and graphics packages are among the programs available. Prices begin at \$3695. For additional information, contact Monroe Systems for Business, The American Rd., Morris Plains, NJ 07950, (201) 993-2000.

Circle 607 on inquiry card.

What's New?

PC-Compatible Targeted at Professionals

The TS 1605 computer is targeted at business and professional users. Manufactured by Televideo Systems, this 16-bit computer is hardware- and software-compatible with the IBM PC. It comes equipped with dual half-height 5¼-inch floppy-disk drives, each of which accommodates 368.6K bytes of formatted data, a single RS-232C asynchronous port, and an IBM-style DB-25S parallel printer port. The TS 1605's 128K bytes of user memory can be expanded to 256K bytes. High-resolution 640-by-200-pixel graphics are possible on the unit's standard 14-inch green-phosphor display. The TS 1605 can be networked under CP/M-86. For more details, contact Televideo Systems Inc., 1170 Morse Ave., Sunnyvale, CA 94086, (408) 745-7760.

Circle 602 on inquiry card.

Low-cost 64K Computer

Video Technologies designed its Laser 3000 personal computer with two tiny gate-array chips that take the place of more than 200 integrated circuits at a fraction of the cost. The basic Laser has 64K bytes of RAM, 80-column display capabilities, a Centronics-type parallel printer port, and a four-channel programmable sound generator. Its graphics capabilities comprise three modes, one of which provides a six-

color 560-by-192-pixel matrix. Other features include a 24K-byte ROM with Microsoft BASIC, eight user-definable function keys, a calculator numeric pad, and a switching power supply. The Laser 3000 is said to be able to run most Apple II software. Optional components will enable it to run CP/M software and provide 16-bit capabilities for running MS-DOS and CP/M-86.

Disk-drive units are available. The Laser 3000 costs \$695. For more information, contact Video Technologies (U.S.A.) Inc., 2633 Greenleaf Ave., Elk Grove Village, IL 60007, (312) 640-1776.

Circle 603 on inquiry card.

Computer Serves Alone or in Network

The Lanier Business Processor 1000 works as a stand-alone unit or can be linked with other workstations in a Lanier Business System 5000 network. The 1000 can also be interfaced with office data-communications systems using IBM 3270 SNA and 3780 communications protocols or those with TTY-ASCII capabilities. Basic system hardware comprises dual 8- and 16-bit processors, 128K or 256K bytes of RAM, and half-height floppy-disk drives. It can be equipped with optional 5- or 10-megabyte Winchester hard-disk and floppy-disk drive configurations. Other options include a tilt-and-swivel base for operator comfort and graphics capa-

bilities for generating business charts and graphs. The 1000 supports CP/M and MS-DOS in addition to Lanier's software.

The base price for the Processor 1000 is \$2995, which includes installation and on-site training. It's available at more than 340 sales locations nationwide. For further information, contact Lanier Business Products Inc., 1700 Chantilly Dr. NE, Atlanta, GA 30324, (404) 329-8000. Circle 608 on inquiry card.

PUBLICATIONS



CAD/CAM Directory Focuses on Specs

A directory of the computer-aided design and manufacturing hardware and software relying heavily on technical specifications, *The CAD/CAM Industry Directory* is available from Technical Database Corporation. This directory offers more than 100 listings detailing CAD/CAM systems, CAD video-display terminals, testing systems, plotters, programmable controllers, harsh en-

vironment CAM terminals, special communications software, industrial databases, systems houses, and consultants. Each product listing includes full specifications, price information, delivery time, length of warranty, European and Japanese marketing contacts, and vendor name, address, and telephone number.

The directory costs \$35 domestic, \$43 overseas. Bi-monthly specification updates are available for \$15 (\$19 foreign). Contact Technical Database Corp., POB 720, Conroe, TX 77305, (409) 539-9688. Circle 611 on inquiry card.

Research via Communication

Alfred Glossbrenner has written a buyer's and user's guide, *The Complete Handbook of Personal Computer Communications*, which details the time- and money-saving benefits of inter-computer communications. Tips in the book include descriptions of how your research is enhanced by access to Compuserve, Tradenet for swapping goods and services, three encyclopedic databases, telephone directories, a daily index of 2000 news stories, and a magazine index that can search 600,000 citations from more than 350 current periodicals. The paperback version is \$14.95. Contact St. Martin's Press, 175 Fifth Ave., New York, NY 10010, (212) 674-5151. Circle 617 on inquiry card.

What's New?

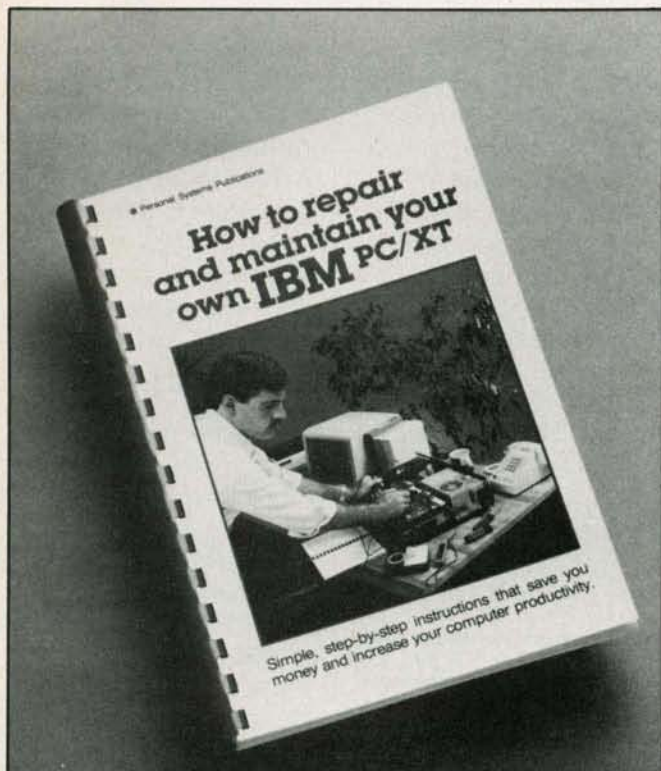

IBM PC XT Repair Manual

A 200-page IBM PC and PC XT repair manual written for both the experienced and nontechnical user has been released by Personal Systems Publications. **How to Repair and Maintain Your Own IBM PC/XT** offers step-by-step instructions, explains most probable hardware problems, and provides troubleshooting tips. The book

aids the novice by showing him or her how to use a volt-ohmmeter and logic probe for troubleshooting testing.

How to Repair and Maintain Your Own IBM PC/XT costs \$19.95. Order from Personal Systems Publications, POB 90754, Los Angeles, CA 90009. Circle 610 on inquiry card.

Communicative Directory

A 26-page directory, **Personal Computers and User-Programmable Terminals**, contains details about 100 terminals that can communicate with 51 personal computers in a data-communications environment. All products covered connect to the

communications network via an RS-232C serial interface, and all have software that supports interaction with the host processor. Different sections in the report relate to stand-alone or cluster environments, displays, data editing and formatting,

operating systems, and programming languages. The report costs \$29 and is available from Data Decisions, 20 Brace Rd., Cherry Hill, NJ 08034, (609) 429-7100.

Circle 618 on inquiry card.

The Naked Truth Behind the Computer

Computer trivia, anecdotes, world records, and lore are the subject of **The Naked Computer** by Jack B. Rochester and John Grantz. From this work you'll learn that the first computer bug was actually a moth that met its demise in a relay of the Mark I analyzer at Harvard and read about a computer that attempted to use water instead of electrons for switching circuits. Subtitled **The Layperson's Almanac of Computer Lore, Wizardry, Personalities, Memorabilia, World Records, Mind Blowers, and Tomfoolery**, this 335-page hardcover book costs \$15.95. It's published by William Morrow & Co., 105 Madison Ave., New York, NY 10016, (212) 889-3050. Circle 613 on inquiry card.

MS-DOS Explained

A thorough overview of Microsoft's popular MS-DOS operating system is provided in **How to Get Started with MS-DOS** by Carl Townsend. Written in a manner that helps beginners understand and use

MS-DOS quickly and effectively, this book covers such topics as why computers require DOSes and how to use a word processor. Other areas covered include IBM hardware, files, records, disks, using commands and utilities, and backup and safety procedures for disks. A series of appendices containing MS-DOS tables and maps, error messages, MS-DOS and BASIC commands, and a glossary round off the book.

How to Get Started with MS-DOS is \$13.95. It can be ordered directly from the Dilithium Press, Suite 151, 8285 Southwest Nimbus, Beaverton, OR 97005, (800) 547-1842; in Oregon, (503) 646-2713.

Circle 612 on inquiry card.

Computer Bulletin for Educators

The School Microcomputing Bulletin provides educators with information on the use of computers as effective teaching aids and administrative tools. **The Bulletin** has descriptions and evaluations of computer products as they performed in school settings and news on industry developments of interest to educators. Eight 8-page issues are produced during the school year. **The Bulletin** does not accept advertisements. For ordering information and a free sample copy, write to the Managing Editor, Learning Publications Inc., Department NR, POB 1326, Holmes Beach, FL 33509. Circle 616 on inquiry card.

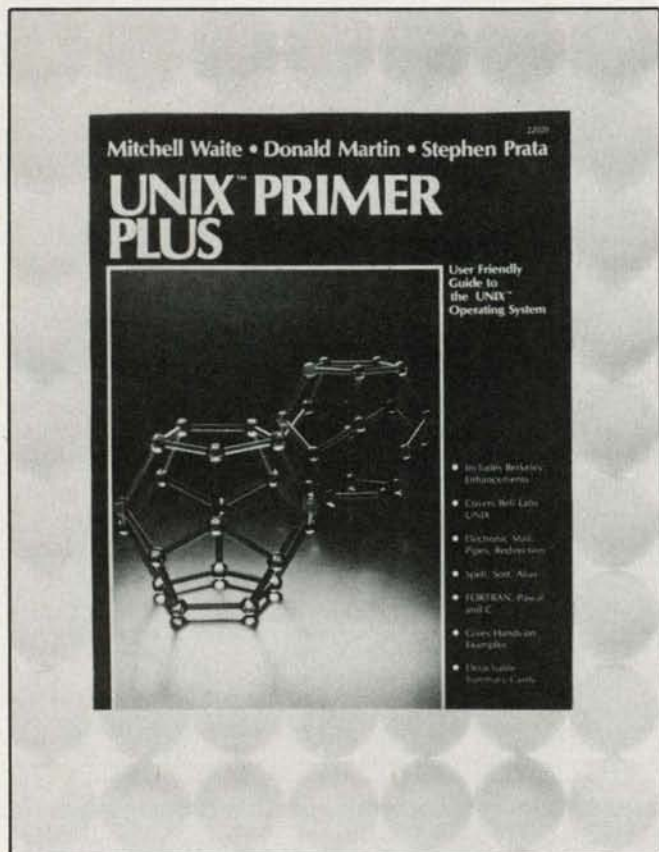

Unix Guide Starts from Scratch

Mitchell Waite, Donald Martin, and Stephen Prata have teamed up to produce a start-from-scratch guide to Bell Laboratories' Unix operating system. The **Unix Primer Plus** is a 288-page tutorial and guide designed for anyone interested in learning about Unix. Anecdotes, analogies, and illustrations frame the presentations, and nontechnical introductory chapters explain fundamental Unix concepts and commands. Later in the book, detailed chapters describe advanced commands and features. Overviews and summaries supplement introductory materials to help comprehension.

The **Unix Primer Plus** comes in a loose-leaf binder

so that readers can add pages of notes, supplement information, or customize the presentation to specific Unix installations. It costs \$19.95. For more information, contact Howard W. Sams & Co. Inc., 4300 West 62nd St., Indianapolis, IN 46268, (317) 298-5400. **Circle 615 on inquiry card.**

MISCELLANEOUS

Gang Programmer Has 32K of Buffer Memory

The Model 8204 is a self-contained gang programmer with 32K bytes of buffer memory. It offers selectable protocols for popular development systems, block-mode data transfer,

selectable data rates, editing, checksum computation, and the ability to program up to eight EPROMs. This device can operate as a stand-alone unit or in conjunction with a computer. The Model 8204 programs such EPROMs as the Intel 2758 and 2732/A, the Texas Instruments TMS2508 and TMS2558, the National NMC2724, the Motorola MCM2816, and the Hitachi HN48016P. Operation features include verification during and after the program cycle, confirmation of the master's validity by the display of its checksum, and occupancy checks to ensure that the master is present and programmed, that at least one blank slave is present, and that all devices are properly registered. Failures are indicated visually and audibly. Operating voltage is 110/220 V AC ± 15 percent at 50/60 Hz.

The Model 8204 Programmer costs \$1295. It's available from Sherman Pirkle Inc., 3 Captain Parker Arms, Lexington, MA 02173, (617) 861-6688. **Circle 621 on inquiry card.**

Standby Supply Powers 16-Bit Systems

Ladco Development's Model 250B standby power supply has a rating of 250 amperes at 115 V AC. It comes with a 10-ampere-hour maintenance-free battery, RFI line filtering, voltage surge suppression, over- and underline voltage protection, a battery

charger with overcharge and short-circuit protection, a battery condition meter, visible and audible failure indication, and a frequency-controlled, square-wave-output 60-cycle inverter. It can power 16-bit computers with hard disks as well as video terminals. The battery can operate for 10 minutes. The Model 250B monitors line voltage for factory-set limits of 103 to 130 volts and automatically switches to standby when deviation occurs.

The Model 250B costs \$545. Quantity discounts are available. For more information, contact Ladco Development Co. Inc., POB 464, Olean, NY 14760, (716) 372-0168. **Circle 619 on inquiry card.**

Videotaped Short Course on FORTRAN

A videotaped short course on FORTRAN is available from Colorado State University. This introductory course covers FORTRAN in 10 half-hour lectures. Each lecture begins with a discussion of the previous assignment. Topics such as batch use and interactive FORTRAN are covered step by step in this presentation. Leasing and purchasing information is available from W. L. Somervell Jr., Engineering Renewal and Growth Program, Engineering Research Center, Colorado State University, Fort Collins, CO 80523, (800) 525-4950; in Colorado, (303) 491-8417. **Circle 620 on inquiry card.**

MEGA BYTES FOR MICRO BUDGETS

Why pay more for top quality peripherals and accessories when our prices are consistently among the lowest anywhere? Expand your system and shrink your cost. We invite you to compare prices, then call us.

MICROSOFT	SALE PRICE
For IBM PC	
9913 64K card	\$243.10
0313 256K card	607.76
9938 64K system card	274.36
0338 256K system card	439.16
9937 mouse	135.44
For Apple II, II+, IIe	
2304 softcard system	239.62
2312 softcard system plus	436.59
2313 ramcard	69.41
2223 multiplan el. wrksheet	191.01
9804 softcard prem. system	482.73
2348 prem. softcard IIe	343.81

VIDEX	SALE PRICE
UL-00 ultraterm	\$282.39
VT-600 videoterm 60.Hz	207.87
VT-601 videoterm 60.Hz softswitch	230.22
VT-602 videoterm 60.Hz softswitch inver	237.68
VT-SPA000 switchplate	14.15
PS-000 paral. ser. I/O card	170.61
ENH-000 Enhancer II	111.04
ENH-FS-000 Function Strip	29.06
ENH-FS-001 Enhancer II, Function Strip	133.37

DYSAN DISKETTES (Boxes of 10 each)	SALE PRICE
104/1 5.25" .ss.sd	\$32.83
104/1D 5.25" .ss.dd	34.72
104/2D 5.25" .ds.dd	41.04
3740/1 8" .ss.sd	34.09
3740/1D 8" .ss.dd	42.29
3740/2 8" .ds.sd	42.29
3740/2D 8" .ds.dd	49.24

MISC. ITEMS	SALE PRICE
644-0100 lemon surge protector	\$46.73
644-0110 orange surge protector	114.86
644-0120 lime surge protector	73.47
7654 system saver (APPLE)	68.19
92P OKIDATA . printer	485.10
93P OKIDATA . printer	812.70
NEC JB1260 monitor	112.50
NEC JB1205 monitor	177.50
AMDEK COLOR II monitor	466.50
PEGASUS disk drives	CALL
CORVUS disk drives	CALL

MODEMS	SALE PRICE
01 HAYES stack chronograph	\$200.79
02 HAYES stack smartmodem	232.37
03 HAYES smartmodem 1200	568.29
04 NOVATION cat	164.17
05 NOVATION dcat	180.58
06 NOVATION autocat	657.95
07 NOVATION jcat	122.30
08 NOVATION smartcat 103/212	488.35
09 NOVATION smartcat 103	204.43

ORDERS ONLY 800-858-4810
IN CAL. 800-821-6662

VISA **COMMERCIAL BUSINESS SUPPLY** **MasterCard**
2858 S. ROBERTSON BLVD. LOS ANGELES, CA 90034

INFORMATION
(213) 559-0596

Phone orders accepted on Visa and Mastercard only. California residents add 6.5% sales tax. No C.O.D. Actual shipping and handling charge added to all orders. Prepaid orders as follows: Money orders or cashier's check—merchandise shipped upon receipt. Personal checks must clear before shipping. 20% restocking fee. Prices and availability subject to change.

SUNNY LOW LOW COST POWER SUPPLIES (LINEAR & SWITCHING) FOR S-100, DISK DRIVES

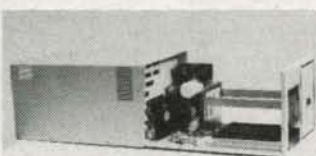

S-100 & DISK POWER SUPPLIES:

No. 806 & No. 516 Mainframes OPEN FRAME, ASSY. & TESTED, 6 OUTPUTS, ADJU. & FUSES PROTECT.
Kit 1, 2 & 3 for S-100 R₂, R₃ for 2 Drives (Floppy & Hard)

ITEM		+5V OVP	-5V	+24V(OR +12V)	+8V	±16V	SIZE W x D x H	PRICE
S ₃	12 SLOT & 2 FLOPPY (1 Floppy & 1 Hard Disk)	5A	1A	5-7A PEAK	13A	3A	10" x 6" x 5"	105.95
S ₄	6 SLOT & 2 FLOPPY	4A	1A	4-5A PEAK	8A	3A	8 3/8" x 5" x 4 3/4"	95.95

DISK POWER SUPPLIES:

OPEN FRAME, ASSY. & TESTED, REGULATED, ADJUSTABLE & FUSES PROTECT.

ITEM	IDEAL FOR	+5V OVP	-5V	+24V (or +12V)	+8V Unreg.	±12V	SIZE W x D x H	PRICE
R ₀	2 x 8" SLIMLINE	2.5A		2.5A - 5A Peak			5" x 4" x 4"	51.95
R ₁	2 x 8" or 2 x 5 1/4" DISK	4A	1A	3A - 5A Peak	2A		8" x 4" x 3 3/4"	56.95
R ₂	3 x 8" (or 5 1/4") FLOPPY	6A	1A	6A - 8A Peak			10" x 4 7/8" x 3 3/4"	71.95
R ₃	or 1x Floppy & 1x Hard	6A	1A	6A - 8A Peak		1A	9" x 6 1/4" x 4 3/4"	95.95

AC & DC POWER CABLES WITH CONNECTOR FOR 2 DRIVES 8.00

S-100 POWER SUPPLY KITS

(OPEN FRAME WITH BASE PLATE, 3 HRS. ASSY. TIME)

ITEM	(IDEAL FOR)	+8V	-8V	+16V	-16V	+28V	SIZE: WxDxH	PRICE
KIT 1	15 CARDS	15A	---	2.5A	2.5A	---	12" x 5" x 4 7/8"	54.95
KIT 2	20 CARDS	25A	---	3A	3A	---	12" x 5" x 4 7/8"	61.95
KIT 3	DISK SYSTEM	15A	1A	3A	3A	5A	13 1/2" x 5" x 4 7/8"	69.95

6 SLOT MAINFRAME ASSY. & TESTED ONLY \$399.95 + SHIPPING \$18.00

EACH MAINFRAME (ITEM NO. 806 OR 516) CONTAINS: EMI FILTER • FUSE HOLDER • AC POWER CORD • POWER SWITCH & INDICATOR • RESET SWITCH • 4 1/2" COOLING FAN • S-100 BUS 6 SLOT CARD CAGE • (110/220 VAC, 50/60 HZ.) POWER SUPPLY FOR DISK DRIVES & S-100 SLOTS • 2 EA. DC POWER CABLES WITH CONNECTOR AND MOUNTING HARDWARE FOR DISK DRIVES • 9 EA. CUT-OUTS; 7 FOR DB25 CONNECTOR, 1 FOR 50 PIN CONNECTOR & 1 FOR CENTRONICS • CUSTOM FINISH & LOGO-LESS • COMPACT SIZE • LIGHTWEIGHT, 28 LBS.
ITEM #806 FOR 2 EA. 8" THINLINE FLOPPY (TANDON TMB48-1 & 848-2 OR EQUIV.), OR ONE HARD DISK, POWER SUPPLY: +8V/8A, ±16V/3A, +5V/5A OVP, -5V/1A & 24V/5A. SIZE: 12"(W) x 19.5"(D) x 9.8"(H).
ITEM #516 FOR 2 EA. 5 1/4" FLOPPY (TANDON TM-100 - 1, 2, 3, 4 OR EQUIV.), OR ONE 5 1/4" FLOPPY & ONE 5 1/4" WINCHESTER HARD DISK (TANDON TM 600-2, 3 OR EQUIV.), POWER SUPPLY: +8V/8A, ±16V/3A OVP, +5V/6A OVP, +12V/6A, 8A PEAK. SIZE: 13.75"(W) x 19.5"(D) x 7"(H).

SHIPPING FOR EA. PWR SUPPLY: \$5.50 IN CALIF. \$8.00 IN OTHER STATES; \$18.00 IN CANADA. FOR EA. TRANSFORMER: \$5.00 IN ALL STATES \$12.00 IN CANADA. CALIF. RESIDENTS ADD 6.5% SALES TAX.

DEALER INQUIRIES INVITED



No. 806 & No. 516 Mainframes

MAILING ADDRESS:
P.O. BOX 4296
TORRANCE, CA 90510
TELEX: 182558

SUNNY INTERNATIONAL
(TRANSFORMERS MANUFACTURER)
(213) 328-2425 MON-SAT 9-6

SHIPPING ADDRESS:
22129 1/2 S. VERMONT AVE
TORRANCE, CA 90502

CHANNEL CONNECTIONS



The Channel Connecting You And Computers

APPLE SOFTWARE

*AST Versa Form	\$245.00
Qbase	139.00
Templates PO/INV @	39.00
ML/CRJ/EJ @	33.00
ARTSCI Magic Window	99.00
Magic Mailer	49.00
Magic Words	49.00
Magic Calc	99.00
*ASHTONE-TATE™ dBase II	385.00
Bottomline Strategist	279.00
Financial Planner	419.00
Friday!	198.00
110900	

BEAGLE BROTHERS

Alpha Plot	28.00
Apple Mechanic	22.00
Beagle Bag	22.00
Doss Boss	17.00
Double Take	27.00
Pronto Dos	22.00
Utility City	22.00

BLUE CHIP Millionaire

BPI GL/AP/AR/INV/PR@	295.00
BRODERBUND™ A.E.	25.00
Choplifter	25.00
Bank St. Writer	45.00
Lode Runner	26.00
G. W/AP	305.00
AR/PR @	275.00

CENTRAL POINT Copy II Plus

Filer	15.00
CONTINENTAL™ GL/AP/AR/PR@	158.00
Home Accountant	49.00
FCM	68.00
Property Management	329.00

CRANE Menu Generator

DATA SOFT (Zaxxon)	27.00
Micropainter	25.00

DIGITAL RESEARCH!

DOW JONES™ Market Analyzer™	275.00
Market Manager	235.00
Market Microscope	525.00
Investment™ Evaluator	129.00
Connector	85.00

EDUWARE

FOX & GELLER™ Quick Code	195.00
dGraph	195.00
dUtil	69.00
Quick Screen	119.00

HAYDEN Pie Writer

HAYES® Smartcom I.	89.00
INFOCOM™ Deadline	34.00
Zork I/II/III @	27.00

INSOFT Electric Duet

GraphForth	56.00
KENSINGTON® Format II	113.00

LOTUS™ Executive Briefing

System	149.00
--------	--------

MICROCOM Micro Terminal

MICRO PRO® Infostar	259.00
*MICROSOFT Multiplan™	169.00
Budget System	109.00
Financial Statement	69.00
Other products	CALL

MONOGRAM Dollars & Sense

MUSE® Supertext Home Office	73.00
Supertext Pro. (Ile)	73.00
Castle Wolfenstein	22.00

PENGUIN

Complete Graphics System II	49.00
Graphics Magician	39.00
Special Effects	29.00

PERFECT SOFTWARE™

Perfect Writer	149.00
Perfect Speller	99.00
Perfect Writer/Speller	199.00
Perfect Filer	199.00
Perfect Calc	99.00
Writer/Speller/Filer/Calc	489.00

PHOENIX Zoom Grafix

QUALITY Bag of Tricks	34.00
	29.00

SENSIBLE Speller

	83.00
--	-------

SIERRA ON LINE

Screen Writer II	85.00
Dictionary	69.00
Screen Writer/Dictionary	135.00
Frogger	25.00
Ultima II	39.00

SILICON VALLEY

Word Handler	39.00
List Handler	35.00

SIRIUS Type Attack

Pascal Graphics Editor	28.00
	75.00

SOFTWARE PUBLISHING™

(Specify II+ or Ile)

pfs: File	84.00
pfs: Report	79.00
pfs: Graph	84.00
pfs: Write (Ile only)	84.00

SPINNAKER™

up to 30% off

SSM Transcend I 69.00

Also SEE MODEMS

STONEWARE D.B. Master 145.00

D.B. Master Ver. 4 229.00

SUBLOGIC Flight Simulator

25.00

TERRAPIN Logo

119.00

VISICORP Visicale

(II/II+) (Ile) 169.00

Other Products CALL

CENTRAL POINT Alaska Card™

99.00

DANA® Fan

59.00

EPS Keyboard

319.00

Prom @

29.00

GIBSON LABS LPS Light Pen

279.00

HAYES Micromodem II W/SC I

249.00

KOALA™ Graphic Tablet

85.00

KRAFT Joystick

49.00

Paddle

39.00

MICRO SCI A2 w/o Controller

219.00

A2 Controller

79.00

A40 w/o Controller

299.00

A70 w/o Controller

399.00

A40/A70 Controller

79.00

MICROSOFT® 16K Ramcard

69.00

Softcard

219.00

Softcard Plus

449.00

Softcard Premium

479.00

Premium Softcard Ile

369.00

NOVATION

See MODEMS

ORANGE MICRO™

Buffered Grappler 16K 179.00

PRACTICAL PERIPHERALS

Microbuffer II plus 16K PAR 199.00

Other Products CALL

SSM

See MODEMS

TG Paddles

29.00

Joy Stick

45.00

Select a Port

45.00

Track Ball

49.00

Joy Stick (Ile)

49.00

TENCAL Cool & Time

75.00

VIDEX Videoterm w/ss

239.00

Ulraterm

279.00

WICO Joy Stick

59.00

IBM SOFTWARE

*AST Versa Form	245.00
Qbase	139.00
Templates PO/INV @	39.00
ML/CRJ/EJ @	33.00

*ASHTONE-TATE™ dBase II

Bottomline Strategist	385.00
Financial Planner	279.00
Friday!	419.00
	198.00

BLUE CHIP Millionaire

39.00

BPI™ GL/AP/AR/PR @

459.00

CENTRAL POINT Copy II PC

32.00

COMPREHENSIVE

PC Tutor 1.1 45.00

PC Tutor 2.0 45.00

CONTINENTAL! FCM

79.00

Home Accountant Plus

89.00

Property Management

329.00

DATAMOST Write On

89.00

DIGITAL RESEARCH™ CP/M 86

45.00

Concurrent CP/M 86

235.00

Dr. Logo

79.00

Other Products

CALL

DOW JONES™ Market Analyzer™

275.00

Market Manager™

235.00

Market Microscope

525.00

Investment Evaluator™

129.00

Connector

85.00

FOX & GELLER Quick Code

195.00

dGraph

195.00

dUtil

69.00

HAYDEN Pie Writer

135.00

HAYES Smart Com II

89.00

INFOCOM™ Deadline

34.00

Zork I/II/III@

27.00

INSOFT Data Design

169.00

MICROCOM Micro Terminal

69.00

*MICROSOFT™ Multiplan

169.00

Budget System

109.00

Financial Statement

69.00

Word

275.00

Word w/Mouse

339.00

Other Products

CALL

MONOGRAM Dollars & Sense

119.00

MUSE™ Supertext Pro

73.00

*PEACHTREE Peachtext 5000

235.00

PETER NORTON Utilities

59.00

SIRIUS Type Attack

29.00

Gorgon II

29.00

SOFTWARE ARTS TK Solver

219.00

SOFTWARE PUBLISHING

pfs: File 94.00

pfs: Report 84.00

pfs: Graph 94.00

pfs: Write 94.00

SPINNAKER™

up to 30% off

STONEWARE

D.B. Master Advanced 449.00

SUPERSOFT Personal Database

90.00

VISICORP Visicale w/C-dex

179.00

Other Products

CALL

AMDEK MAI Board

519.00

AST

Call

HAYES Smartmodem 1200B /SCII

439.00

KOALA™ Graphic Tablet

109.00

KRAFT Joystick

49.00

Paddle

★ ★ ★ The GRAY MARKET



We don't play games

Lowest Prices Anwhere! Here is why:

1. Low Advertising Budget
2. Large Volume Buying
3. No Support
4. No Repair Service

Our advertising budget is kept low, we sell in large volume and you benefit by getting the best prices anywhere. You may use **Visa, MasterCard, American Express** or prepay (cashier's check or money order).

We carry so many products that we are unable to list them all. However, call us for your specific needs. We have listed examples of some of our products and prices. Believe it or not, all our products are priced the same.

**ALL PRODUCTS ARE NEW
IN SEALED CONTAINERS**

**IF YOU WANT THE LOWEST
AND BEST PRICES CALL US
(714) 557-3934**

COMPUTERS	MONITORS	IBM PERIPHERALS
ALTOS	AMDEK COLOR I	RAM CARDS
VIC 20	NEC	QUADRAM
COLOMBIA	ZENITH	RAYTRONICS
CORONA	SANYO	AST
NORTH STAR	TAXAN	COLOR MONITORS
FRANKLIN	USI	10 MEGA BYTE HA
DEC RAINBOW	COMREX	GRAPHICS CARDS
TELEVIDEO	GORILLA	DISC DRIVES
SANYO	MODEMS	MODEMS
TEXAS INSTRUMENT	HAYES 300 BAUD	COMMADOR 64 - VIC 20
ZENITH	NOVATIONS	PERIPHERALS
PIED PIPER	SIGNALMAN	DIS DRIVES
ZORBA	TERMINALS	MONITORS
PRINTERS - DOT MATRIXES	TELEVIDEO 925	INTERFACES
EPSON FX-80	QUME	CARDCO
OKIDATA 92A	ZENITH	THE CONNECTION
STAR MICRONICS	AMPEX DIALOG	SOFTWARE
C. ITHO	TERMIFLEX	PAPER CLIP
PROWRITER	DISC DRIVES	DATA 20
IDS	SHUGART	WORD PLUS
DATASOUTH	TANDON	EXPANSION BOARD
ANADIX	SIEMANS	PLOTTERS
NEC	REMX	HEWLETT PACKARD
TOSHIBA	RANA	BAUSCH & LOMB
RITEMAN	COMMADOR 64 DRI	AMDEX
MANNMAN TALLY	APPLE PERIPHERALS	BMC
OLIVETTE	GRAPPLER PLUS	STROBE
RIKO	MICROTEK	HARD DISC DRIVES
LETTER QUALITY	OTHER PARALLEL	SWITCH BOXES
BROTHER HR-1	INTERFACES	ACCESSORIES
DYNAX DX-15	SERIAL INTERFAC	DUST COVERS
COMREX	80 COLUMN CARDS	PRINT WHEELS
NEC	CPM CARDS	RIBBONS
DIABLO	16K RAM CARDS	DISKETTE CASES
QUME	LANGUAGE CARDS	SURGE PROTECTOR
C. ITHO	APPLE DISK DRIV	DISKETTES DS/DD
STARWRITER	BUFFERS	10 ea. \$28.95
SILVER REED	COMPLETE STOCK OF	
JUKI	CABLES	

CHECK SUNTRONICS NEW LOW PRICES

TOLL FREE (ORDERS ONLY) **1-800-421-5775**
Calif. orders and all info Call **213-644-1149**

IBM Compatible Products Apple Compatible Products General Products- cont. S-100 Products

COLUMBIA PC 1600-1
Includes: Drives, Video Card, Perfect Software Package, MS-DOS, CP/M, Fast Graphics, BASIC, CP/M-86, Home Accountant and Communications Program.
PC 1600-1.....only \$2850.00
COLUMBIA VP (Portable).....only \$2750.00

AST SIXPACK CARD
Six-function card with 64K-348K RAM Memory, Parallel Port, Serial Port, Clock Calendar, Super Drive and Super Spool.
AST Sixpack Card.....only 291.00

MSI DUAL I/O
2 Serial/2 Parallel Ports, Clock.....175.00

MSI 256K RAM Board
256K RAM Board with 64K.....199.00
256K RAM Board with 256K.....Call

MSI 256K w/Parallel or Serial Port
256K w/Parallel Port and 64K.....259.00
256K w/Parallel Port and 256K.....Call
256K w/Serial Port and 64K.....259.00
256K w/Serial Port and 256K.....Call

VISTA DISKMASTER
Diskmaster Floppy and Hard Disk Controller.....225.00

APPRATE IBM PROM Blaster.....129.00

CABLE for IBM Parallel Printer.....29.95

CABLE for Columbia MPC
Parallel Printer.....29.95

MODEM Novation 103 Smart-Cat ..\$210.00

AFDC-1 Floppy Disk Drive Controller.....\$79.95
Runs DOS 3.3 with any standard Shugart compatible 5 1/4" disk drive. (2 drives each card)

ASCII KEYBOARD A&T Plug in compatible w/Apple II, has shiftlock, underscore, [] and back slash characters.....\$69.00

BMC DD and CONTROLLER for APPLE II
BAL500 Disk Drive 5 1/4" SS/DD
100% Apple II compatible.....249.00
Controller for above.....69.00

APPLE Connector 50 pin.....3.50

Apple Prototype Board.
Double Sided glass with gold plated Apple and General Purpose terminals. Contains matrix of 17 x 63 solder plated donuts on .15" x .1" spacing. Great for 14, 16, and 24 pin IC's. SUN-722.....7.95

Apprate PROM Blaster.....119.00
"ALS" 80 Column Card.....159.00
"ALS" Z-CARD (280 CPU).....149.00
API Apple Parallel Printer Interface card.
Centronics Compatible.....\$45.00

General Products

Mitsubishi Disk Drives, 5 1/4" and 8" Slim
5 1/4" Thin DSDD 40 Track.....310.00
8" Thin DSDD 80 Track.....450.00

DISKETTE SALE

5 1/4" Diskettes	10 up	100 up
SS/DD (100% certified)	1.75	1.55
DS/DD (100% certified)	2.50	2.30

SAMWOO 18MHz Video Monitors

AMBER 9".....119.00
GREEN 12".....124.00
AMBER 12".....127.00
Composite video I/O. 750 lines resolution. 75/10K ohm impedance.

BMC 13" COLOR monitor for your home computer! video game display. Offers 350 x 350 resolution with 400 dots at the center.
9191U.....249.00

BMC PRINTER
BX-80 dot matrix printer with 80 cps, 9 x 7 print head. Quiet, reliable and priced for entry level end-user.....\$259.00

Note: Please add \$10.00 shipping and handling for the video monitors or printer.

EPROM & RAM SUPER SALE

PN	Description	8-24	25up
2716	(450nS)	3.95	3.95
2732	(450nS)	4.40	4.40
2532	(450nS)	4.40	4.10
2764	(28 pin)	5.95	5.95
2114L-2	(200nS)	Call	Call
4164	(in stock)	Call	Call
6116P-3	(150nS)	6.10	5.75

Mother Boards & Card Cages

SLOTS	Bare Bd	KIT	A & T	w/CAGE
6	\$19.00	\$44.00	\$59.00	\$84.00
8	24.00	56.00	81.00	116.00
12	29.00	75.00	110.00	150.00

10MHz. No termination. Includes power indicator and wiring for muffin fan. Uses OK connector for solderless installation and removal of power & reset lines.

64KSM A&T without RAM.....\$155.00
64KSM A&T w/64K RAM (32-6116's).....339.00
S-100 Board Uses 6MHz 6116's. 1/2 A max. power. Bank Select plus Extended Addressing allow for multi-memory board set-up. 4 independent 16K Blocks make easy use with multi-user systems. Any 2K RAM may be replaced by 2716 EPROM.

SBC-880 Z80A CPU, A&T.....\$169.00
SBC-880 Z80A CPU, Kit.....149.00
4MHz Z80A CPU boards with Serial/Parallel Ports.

UFDC-1 Floppy Controller, A&T.....245.00
UFDC-1 Floppy Controller, Kit.....225.00
The UFDC-1 Floppy Controller uses the WD1795 chip which runs either and/or 8" 5 1/4" Disk Drives.

CLOCK CALENDAR A&T.....115.00
CLOCK CALENDAR Kit.....95.00
This S-100 Clock Calendar Board has 4 interrupts, Time, Day of Week and Battery Backup.

S-100 Edge Connector 100 pin.....3.95

S-100 Prototype Board
Double Sided glass with gold plated, numbered S-100 terminals. Matrix of 25 x 78 solder plated donuts on .15" x .1" spacing. Locations for headers and regulators. Great for 14, 16, and 24 pin IC's. SUN-721.....12.95

Apple Country Ltd. has your Number for ROCK BOTTOM PRICES 1-800-222-2602



MONITORS

AMDEX COLOR I PLUS	294.95
AMDEX COLOR II PLUS	424.95
AMDEX COLOR III	369.95
AMDEX COLOR IV	749.95
AMDEX VIDEO 300 (GREEN)	134.95
AMDEX VIDEO 300 (AMBER)	144.95
AMDEX VIDEO 310 (AMBER)	164.95
BMC 12AU 12" GREEN	89.95
BMC AU919IU 13" COLOR	299.95
BMC 1401 13" RGB COLOR	349.95
BMC AU919IMU 13" RGB IBM	629.95
COMMODORE COLOR MONITOR	269.95
COMREX 13" COLOR W/SOUND	269.95
COMREX 12" HI-RES AMBER	134.95
COMREX 12" HI-RES GREEN	129.95
COMREX 12" HI-RES LT GRN	129.95
COMREX 13" RGB COLOR	269.95
ELECTROHOME 9" GREEN	129.95
ELECTROHOME 12" GREEN	144.95
ELECTROHOME 13" RGB IBM	379.95
ELECTROHOME 13" RGB COLOR	359.95
GORILLA 12" GREEN	89.95
NEC 12" GREEN SCREEN	154.95
NEC 12" ECONO GREEN	109.95
NEC 12" LO-RES COLOR	289.95
NEC 12" AMBER SCREEN	164.95
NEC 12" COLOR - IBM	479.95
PRINCETON GRAPHICS HX-12	489.95
SAKATA 13" COLOR	264.95
SAKATA 13" RGB COLOR	499.95
SAKATA SUPER RGB MONITOR	679.95
SAKATA 12" GREEN	104.95
TAXAN 12" GREEN	124.95
TAXAN 12" AMBER	129.95
TAXAN RGB VISION I	294.95
TAXAN RGB VISION III	439.95
ZENITH 12" AMBER	119.95
ZENITH 12" GREEN	99.95
ZENITH RGB COLOR MONITOR	389.95
USI 9" AMBER MONITOR	129.95
USI 9" GREEN MONITOR	119.95
USI 12" AMBER	149.95
USI 12" GREEN MONITOR	139.95
USI 14" LO-RES COLOR	289.95

MODEMS

ANCHOR MARK I (RS-232)	79.95
ANCHOR MARK II (ATARI)	79.95
ANCHOR MARK III (TI99/4A)	99.95
ANCHOR MARK V (OSBORNE)	94.95
ANCHOR MARK VI (IBM PC)	199.95
ANCHOR MARK VII (RS-232)	109.95
ANCHOR MARK XII (RS-232)	279.95
NOVATION 3-CAT	104.95
NOVATION 212 AUTO CAT	579.95
SMARTCAT 212 (1200 BAUD)	429.95
SMARTMODEM 300 BAUD	194.95
SMARTMODEM 1200 BAUD	484.95
SMARTMODEM 1200B - IBM	449.95
US ROBOTICS AUTODIAL 212	449.95

PRINTERS

ANADEX DP-9725B COLOR/SCRIBE	1339.95
ANADEX DP-9625A	1129.95
ANADEX DP-9620A	1129.95
ANADEX WP-6000	2199.95
ANADEX DP-6500TR 500CPS	2329.95
C-ITOH 8510SCP COLOR	NEW!!
C-ITOH A10 DAISY WHEEL	539.95
C-ITOH 8510SP	569.95
COMREX CR-I DAISY WHEEL	629.95
COMREX CR-II DAISY WHEEL	469.95
DAISEYWRITER 2000	1129.95
DIABLO 630R155	1784.95
EPSON FX-80 W/TRACTOR	LOW!!
EPSON FX-100 F/T	LOW!!
EPSON LQ-1500 LETTER QUALITY	LOW!!
EPSON MX-100 F/T	LOW!!
EPSON RX-80	LOW!!
EPSON RX-80 F/T	LOW!!
GEMINI 10X	LOW!!
GEMINI 15X	LOW!!
GORILLA BANANA PRINTER	189.95
IDS MICROPRISM	479.95
IDS PRISM 132	1299.95
IDS PRISM 132C - COLOR	1499.95
JUKI 6100 PRINTER (P)	549.95
MANNESMANN TALLY MT160L	599.95
MANNESMANN TALLY MT180L	799.95
MANNESMANN TALLY MT440L	NEW!!
NEC 3550 SPINWRITER-IBM	1754.95
NEC 8025 120 CPS 136 COL	719.95
OKIDATA MICROLINE 80	299.95
OKIDATA PACEMARK 2350S	1999.95
OKIDATA PACEMARK 2350T	1999.95
OKIDATA PACEMARK 2410P	2329.95
OKIDATA PACEMARK 2410S	2499.95
OKIDATA B2A W/GRAPHICS	379.95
OKIDATA B3A W/GRAPHICS	579.95
OKIDATA B4P	1049.95
OKIDATA B4S	1129.95
OKIDATA 92P	449.95
OKIDATA 93P	729.95
OKIDATA 93S	829.95
PRINTMASTER (DAISY)	1549.95
PROWRITER I PRINTER	344.95
PROWRITER II PRINTER	619.95
QUADJET COLOR INK JET PRINTER	1399.95
QUME SPRINT 11/40+	1399.95
SANYO PR5500 DAISY WHEEL	659.95
SILVER-REED 550 DAISY	699.95
STAR DELTA-10 160CPS	LOW!!
STARWRITER DAISY WHEEL	1099.95
TOSHIBA B-1350 LP	1579.95
TRANSTAR 315 COLOR	449.95
TRANSTAR 120P 14CPS	464.95
TRANSTAR 130P 18CPS	699.95
TRANSTAR 140S 40CPS	1229.95
EPSON SERIAL (RS-232)	134.95
GRAFITTI CARD	84.95
GRAPPLER	119.95
MICROBUFFER II 16K	144.95
PKASO INTERFACE	129.95
WIZARD BPO 16K	129.95
WIZARD SOB 16K	179.95

OTHER PRINTERS AVAILABLE

COMPUTERS

COMMODORE 64	LOW!!
COMMODORE 1541 DRIVE	LOW!!
IBM PC	LOW!!
COLUMBIA VP PORTABLE	2349.95
COLUMBIA COMPLETE SYS.	2649.95
IBM-PC COMPATIBLE SYSTEM	128K, 2-DS/DD DRIVES, KEYBOARD AND COMPLETE SOFTWARE PACKAGE
CORVUS CONCEPT MC68000	\$3199
256K, 8" FLOPPY DRIVE	
COMPLETE SOFTWARE PACKAGE	
BI-DIRECTIONAL 8-1/2X11 SCREEN	
CORVUS CONCEPT 512K	\$3599
EAGLE PC II 128K SYSTEM	2649.95
EAGLE SPIRIT XL	3649.95
PORATABLE 128K RAM EXPANDABLE TO 640K RAM ON BOARD, 1 320K FLOPPY 10 MEGABYTE HARD DISK, IBM COMPATIBLE KEYBOARD, MONOCHROME MONITOR, 2 SERIAL & 1 PARALLEL PORT, MS DOS 2.0, GW BASIC, CP/M 86	
KAYPRO II	1449.95

LEADING EDGE
IBM COMPATIBLE COMPUTER
8088 MPC 7.16 Mhz
7 EXPANSION SLOTS, BUILT IN CLOCK, PARALLEL AND SERIAL PORTS, 128K RAM, MONITOR, WORD PROCESSING SOFTWARE.
CALL FOR LOW PRICE!

NEC APC-H01	\$2049
NEC APC-H02	\$2549
NEC APC-H03	\$3049
SANYO MBC 550 SYSTEM	769.95
SANYO WBC-1000	1529.95

TELEVIDEO 16-BIT DESKTOP
128K 8088 5MHZ DUAL 360K DRIVES
INCLUDES CP/M \$3499.95

TELEVIDEO 910 TERMINAL	549.95
TELEVIDEO 925 TERMINAL	789.95
TELEVIDEO 970 TERMINAL	1199.95

ZENITH Z-120 ALL-IN-ONE
BUILT-IN GREEN SCREEN
DUAL DRIVES SPECIAL \$2999.95

APPLE //e NOW AVAILABLE

WILDCAT STARTER SYSTEM 64K 2DR.	6502 & 280 APPLE-CLONE	1499.95
---------------------------------	------------------------	---------

DISKETTES

SS/SD ELEPHANT	16.95	OPUS	15.95
SS/DD ELEPHANT	19.95	OPUS	17.95
DS/DD ELEPHANT	25.95	OPUS	24.95

APPLE HARDWARE

ALS CP/M CARD	299.95
AMDEK AMDISK 3" DISK DR.	239.95
APPLE-CAT II	264.95
APPLE DUMPLING GX	119.95
4TH DIMENSION DRIVE+CTRL	289.95
4TH DIMENSION DRIVE-ONLY	199.95
HAYES MICROMODEM IIe	249.95
KENSINGTON SYSTEM SAVER	64.95
KOALA GR/TABLET W/SFTWR	99.95
LAZER MICROSYSTEM DRIVE	189.95
MICRO-SCI A2 DRIVE ONLY	239.95
MICRO-SCI A2 W/CTRL-CARD	299.95
MOUNTAIN MUSIC SYSTEM	289.95
ORANGE MICRO SMART CARD	NEW!!
PREMIUM SOFTWARE IIe	134.95
QUADRAM 64K800L CRD IIe	324.95
RANA ELITE I W/CTRL-CARD	349.95
RANA ELITE II W/CTRL	499.95
RANA ELITE III W/CTRL	649.95
SOUNDCHASER MUSIC SYSTEM	619.95
SOFTCARD (Z-80 CARD)	234.95
SWEET P PLOTTER	459.95
TG JOYSTICK W/TOGGLE IIe	49.95
TRANSMODEM 1200	499.95
WICD APPLE MOUSE	124.95

IBM

KOALA PAD TOUCH TABLET	99.95
KRAFT JOYSTICK	54.95
MICROSOFT SYSTEMCHD 256K	449.95
MICROSOFT MOUSE	134.95
MOUSE SYSTEMS PC MOUSE	224.95
QUADLINK APPLE EMULATOR	489.95
QUADRAM QUADBOARD I 64K	289.95
QUADRAM QUADCOLOR I	229.95
QUADRAM QUADCHROME MON	524.95
QUADRAM QUADSCREEN MON	1549.95
RANA DS/DD DISK DRIVE	259.95
STB SUPER I/O MULTIFUNCT	169.95
TG JOYSTICK W/TOGGLE	49.95
TRANSEND P.C. MODEM 1200	399.95
VERSAWRITER GRAPH TABLET	239.95
WIZARD SPOOLER P/S 16K	239.95

CM64 HARDWARE

CARDBOARD/5 5 SLOT EXPAN.	54.95
CARD? GRAPHICS INTERFACE	64.95
DATA20 280 VIDEOPAK	224.95
GRAPPLER CD NEW PRINT INTERFACE	
KOALA GRAPH TABLET W/SFT	79.95
MSD-SD1 DISK DRIVE	339.95
VOICE BOX	99.95

**We will try to meet or beat any advertised price!
CALL US... WE CAN HELP! 1-800-222-2602**

For technical assistance, order status and California calls (619) 765-0239
Apple Country, Ltd., P.O. Box 1099, 2602 Washington St., Julian, Calif. 92036

Terms: We accept American Express. No extra charge for Visa/MasterCard, Cashier's Check, personal check (allow 2 weeks to clear) Shipping & Handling: 5% (\$5 min.); APO FPO Alaska Hawaii & Monitors 5% (\$10 min.) Foreign orders 15% (\$15 min.) All items are new with manufacturer's warranty. Prices are subject to availability & change without notice. Purchase order must include check. California residents add 6% sales tax. Send \$1 (good toward first purchase) for new fall catalog.

Apple Country, Ltd. is a **DISCOUNT MAIL ORDER HOUSE** for the micro computer industry and is a California corporation not affiliated with Apple Computer Inc. Apple is a trademark of Apple Computer Inc.



S-100 get PRAM

NEW 256 K CMOS STATIC RAM
64K CMOS STATIC RAM
LITHIUM BATTERY BACKUP

**PERMANENT RAM • MPM • CDOS
CROMIX • OASIS • AMOS**

✓ MOST VERSATILE MEMORY AVAILABLE

• 8/16 BIT • 24-BIT EXTENDED ADDRESSING • PHANTOM
• 8-12 MHZ • IEEE 696 • LOW POWER • EPROM-RAM MIX

LITHIUM BATTERY BACKUP avoids power failure crashes intelligently. Unique POWER-FAIL-SENSE circuit allows processor to save register information and disable board before POWER FAILURE CRASHES memory.

BG BANK 256S\$1,299 Battery Backup.....\$79
BG BANK 64S399 Battery Backup.....39

BG COMPUTER APPLICATIONS, 206 Brookside, Bryan, Texas 77801. International orders add 30%.
(409) 775-5009

Circle 42 on inquiry card.

Apple
Compatible Drives

\$195

Includes:

- 40 TRK, 163 K Drive
- Cabinet & Cable
- Free Shipping
- 6 Month Warranty

Order Toll Free:  
Free Shipping

1-800-531-5475 (Outside Of Texas)
(512) 250-1489 (In Texas)

 **CompuAdd** Corp.

13010 Research Blvd., Suite 101
Austin, Texas 78750

Circle 79 on inquiry card.

1984 **3M SPECIAL** 

We're bringing in the New Year with specials on quality 3M information processing products. Including:

- DISKETTES • MAG TAPE
- DATA CARTRIDGES

PLUS! Specials on many other products in our full-range discount catalog of computer supplies. Call, write, or utilize reader service to obtain your FREE catalog of 1984 3M Specials.

LYBEN COMPUTER SYSTEMS
1250-E Rankin Dr., Troy, MI 48083
Phone: (313) 589-3440

Simply #1 in Service & Reliability

 Authorized Distributor
Information Processing Products

Circle 228 on inquiry card.

★ **Special** ★
SMITH-CORONA TP-1
Letter Quality • Daisy Wheel Printer



- Parallel Interface
- Microprocessor Electronics

Order Toll Free: **\$349**
Free Shipping

1-800-531-5475 (Outside Of Texas)
(512) 250-1523 (In Texas)

 **CompuAdd** Corp.

13010 Research Blvd., Suite 101
Austin, Texas 78750

Circle 80 on inquiry card.

5 1/4" DISK DRIVES

- ★ **QUME 142A**
Half Height, Double Sided, 40 TRK/Side **\$229**
Free Shipping
- ★ **TANDON: TM 100-2**
Double Sided, 40 TRK/Side **\$235**
Free Shipping
- ★ **CDC: 9409**
Double Sided, 40 TRK/Side **\$235**
Free Shipping
- ★ **SHUGART: SA 455**
Half Height, Double Sided, 40 TRK/Side **\$229**
Free Shipping

Order Toll Free:
1-800-531-5475 (Outside Of Texas) 
(512) 250-1489 (In Texas) 
Texas Residents Add 5% Sales Tax.

 **CompuAdd** Corp.

13010 Research Blvd., Suite 101
Austin, Texas 78750

Circle 81 on inquiry card.

NEW! **SMITH-CORONA**
Memory Correct III Messenger
Printer & Typewriter



- RS232 Serial Or Centronics Parallel
- Multiple Pitch 10, 12, 15

Order Toll Free: **\$559**
Free Shipping

1-800-531-5475 (Outside Of Texas) 
(512) 250-1489 (In Texas) 

 **CompuAdd** Corp.

13010 Research Blvd., Suite 101
Austin, Texas 78750

Circle 82 on inquiry card.

for you . . .
THE PERSONAL TOUCH
by

the wood works

Handcrafted Hardwood & Hardwood Veneer Micro Computer Furniture. Enjoy the function & beauty of Oak, Walnut or Cherry. We can customize work stations to suit individual needs.

beginning at **\$175**
MASTERCARD & VISA ACCEPTED

CALL FOR OUR COLOR BROCHURE
1-800-255-0524
Kansas Residents 913-842-7797

Rt. 2, Box 407 Lawrence, KS 66044

PC-LINK
DEC VT100® TERMINAL EMULATOR

- A full featured DEC VT100® terminal emulator on IBM PC or IBM XT.
- Transfer text files between host and IBM PC or IBM XT.
- Very easy to use. Complete user documentation.
- To use PC-LINK program, the PC needs to have at least one disk drive, IBM DOS IBM monochrome or color display, a RS232 port, telephone modem or direct connect.
- Support baud rate up to 1200 baud.
- \$60.00 + \$5.00 for shipping & handling.
- Inquire about source license.

SCREENWARE CORPORATION
P.O. BOX 3662
NASHUA, NH 03061-3662
Tel. 603-888-4074

IBM, IBMPC are trademarks of IBM Corporation. Digital, DEC, VT100 are trademarks of Digital Equipment Corporation.

Circle 316 on inquiry card.

ICs PROMPT DELIVERY!!
SAME DAY SHIPPING (USUALLY)

DYNAMIC RAM		
64K	200 ns	\$ 5.97
64K	150 ns	6.09
64K	120 ns	6.95
16K	200 ns	1.56
EPROM		
27128	300 ns	\$19.20
2764	250 ns	5.99
2732	450 ns	4.25
2716	450 ns	3.60
2532	450 ns	4.75
STATIC RAM		
6264P-15	150 ns	\$38.00
6116P-3	150 ns	5.62

MasterCard VISA or UPS CASH COD
Factory New, Prime Parts 
MICROPROCESSORS UNLIMITED
24,000 South Piedra Ave
BEGGS, OK, 74421 (918) 267-4961

Prices 11/15/83
Prices subject to change. Please expect higher prices on some parts due to world wide shortages. Call for volume prices. Subject to available quantities. Shipping & insurance extra. Cash discount prices shown. Federal Express Standard Air is \$5.99. Orders received by 6 PM CST can be delivered to you by the next morning. We try harder.

Circle 252 on inquiry card.

CONTROL COMPUTER

that features:

- 6502 MPU
- 55K DRAM
- 2K to 8K EPROM
- 4 Parallel I/O Ports
- 1 Serial I/O Port
- 4 Timer/Counters
- Same Bus as SLIM, AIM

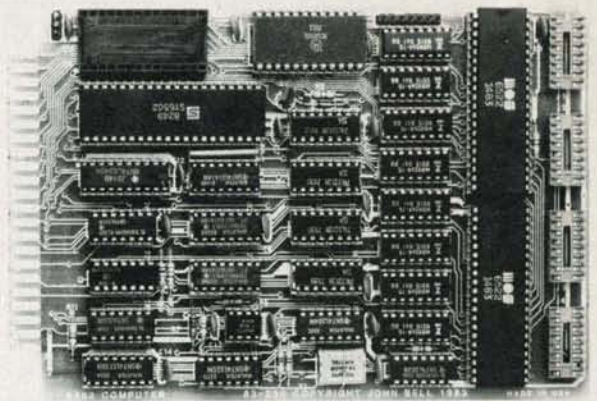

This board can stand alone or be expanded with JOHN BELL ENGINEERING, INC. peripherals.

- 6 Slot Mother Board #81-320
- Analog I/O Interface #81-292
- 12 Port Parallel I/O #82-036

The board is 4.5" x 6.5" Solder mask both sides with gold fingers. Power 5 VDC 700 MA. This board has power on reset and a crystal clock running at 1.2288 mhz. One of the 6522's is used to generate baud rates from 110 to 9600.

USES:

- Security Systems
- Heat control
- Light control
- Solar Systems
- Industrial Robot
- Lab experiments
- Automated slide show
- Personal Computer

PRICE:

- | | | |
|----------|------------|----------|
| #83-230A | Assembled | \$299.95 |
| #83-230B | Bare Board | \$ 49.95 |



JOHN BELL ENGINEERING, INC.

To order: Send check or money order. Add 6.5% tax in California. Add 5% shipping for orders less than \$100 or 3% for orders over \$100 or 10% outside U.S.A. Phone orders: We accept Visa or MC. Add \$2.00 for C.O.D. Will Call Hours 9am to 4pm. Call 415-592-8411. JOHN BELL ENGINEERING, INC. 1014 CENTER ST. SAN CARLOS, CA 94070.



HAVE YOU TRIED THE
DYSAN[®]
QUALITY
DIFFERENCE?

DEALER INQUIRIES INVITED

5 1/4"

PRICE/10

104/1	1 SIDE/SGL DENS.	\$35.00
104/1D	1 SIDE/DBL DENS.	\$37.00
104/2D	2 SIDES/DBL DENS.	\$43.90
204/1D	1 SIDE/QUAD 96 TP1	\$43.90
204/2D	2 SIDES/QUAD 96 TPI	\$51.30

8"

3740/1	1 SIDE/SGL DENS.	\$36.50
3740/1D	1 SIDE/DBL DENS.	\$45.20
3740/2D	2 SIDES/DBL DENS.	\$52.70

Checks-VISA-MC-C.O.D./Add \$2 Shipping
Call or write for our discount catalog.

LYBEN COMPUTER SYSTEMS
1250-E Rankin Dr., Troy, MI 48063
Phone: (313) 589-3440

**THE DYSAN DISKETTE STANDARD
AT AN AFFORDABLE PRICE**

Circle 229 on inquiry card.

FLOPPY DISK-DRIVE REPAIR

Command Services
exclusively repairs
Tandon and Shugart
disk drives. We are
affordable, fast and experienced.

For service, call toll free:
M-F, 9 a.m.-5 p.m., 7-9 p.m.
1-800-782-5500
In New York State call:
1-800-328-1800

Command Services Corporation
7143 Henry Clay Blvd.
Liverpool, New York 13088
315-457-1432



Circle 68 on inquiry card.

Fast ANALOG I/O

8 channels A/D & 8 channels D/A. Sampling rates up to 1/2MHz. 8 bits. Analog channels act as memory or I/O locations. Fits most computers which provide access to data and address lines (C64, Apple, Timex, TRS80...) Box & cable available. **\$220.**



FFT-SCOPE-A/D-D/A

A unique peripheral which transforms the low cost Timex 1500 & printer into a powerful 155K samples/sec instrumentation, signal processing & control system. Free catalog, call or write. I/O & EPROM boards & 70 pg docs. **\$288.**

Computer Continuum

301 Sixteenth Avenue
San Francisco, CA 94118 (415) 752-6294

Circle 89 on inquiry card.



FLEXIBLE DISCS

**WE WILL NOT BE UNDER-
SOLD!!** Call Free (800)235-4137
for prices and information. Dealer
inquiries invited and C.O.D.'s
accepted.

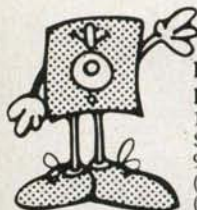

**PACIFIC
EXCHANGES**
100 Foothill Blvd.
San Luis Obispo, CA
93401. In Cal. call
(800)592-5935 or
(805)543-1037

Circle 278 on inquiry card.

WHOLESALE MODEMS

U. S. Robotics 1200/300 Baud
PASSWORD MODEM SALE!

As Low As **\$349.00**

	List	Qty 1	Qty 2	Qty 5+
Password Modem	449. ⁰⁰ ea.	359. ⁹⁹ ea.	349. ⁹⁹ ea.	CALL

Password Features:

- Free RS232 Cable
- Phone Cable Included
- 2 Year Warranty
- 1200/300 Baud
- Bell 212A Compat.
- Bell 103/113 Compat.
- Full/Half Duplex
- Manual Answer
- Manual Originate
- Auto Dial
- Auto Answer
- Auto Mode Select
- Auto Speed Select
- Direct Connect
- Software Available

Free Shipping and Handling in Continental U.S.A.!

Call 1-(801) 298-0872

Rush Check or Money Order To:
C. R. E. Wholesale Products
P. O. Box 361 N.S.L., Ut. 84054

Circle 117 on inquiry card.

SUPER PRICES SUPER MICROS SAGE

SAGE IV computers use the 68000 CPU, come with UCSD p-System, PASCAL, Macro Assembler, Multi-user system, Word processor, Spreadsheet, expandable to 1mb RAM.

Available SAGE configurations include:

2 640K floppies & 256K RAM	\$3760
1 floppy, 256K RAM, 6mb Hard disk	\$5840
1 floppy, 256K RAM, 18mb Hard disk	\$6800

BIG BROTHER'S SPECIAL—With Hard Disk SAGE:
A Freedom 100 Terminal FREE
or Okidata 92 Printer FREE
or Rebate \$400

As software developers and authorized SAGE dealers we offer customer support.

MARITIME SOFTWARE ASSOCIATES

(503) 929-2552
6660 Reservoir Road Corvallis, OR 97333

Circle 468 on inquiry card.

SUPER FAST! Z80 DISASSEMBLER

- Two pass operation - generates labels at referenced locations.
- Generates Zilog mnemonics.
- Allows user defined labels.
- Allows define byte, define word and define space directives.
- COMPLETE cross-reference
- Output to console, list or disk device(s) in any combination.
- Generates mnemonics for CP/M system calls.
- Start and stop at any location in file.
- Source or complete listing type output.

Most formats available for Z80 CP/M, CDOS, and TURBODOS. **\$6995**

S L R Systems

For more information or to order call:
1-800-833-3061
In PA. (412) 282-0864
1622 North Main Street, Butler, PA 16001

Circle 326 on inquiry card.

LIFETIME WARRANTY

GENERIC SERIAL COMMUNICATION CARD

For Apple II+[®] and Apple IIe[®]

The Generic Serial Communication Card (GSCC) is an asynchronous device that supports all protocol needed for full handshake communication (Hardware DTR, CTS, RTS and Software XON, XOFF). The board features 3 selectable options: Baud Rate from 110 to 9600, Full or Half Duplex and Auto Linefeed On or Off that are software selectable. And the 3 options can be controlled without burning a new EPROM.

Special Introductory Price **79⁹⁵** plus shipping and handling. Dealer Pricing Available.

Computer Technology Associates

CTA New Products Division
1704 Moon, N.E.
Albuquerque, N.M. 87112
(505) 298-0942

Specifications subject to change without notice. Apple is a registered trademark of Apple Computer, Inc. VISA/MC/AE Accepted

Circle 101 on inquiry card.

wabash[®]

Flexible Diskettes

6 Year Warranty - 100% Certified
DELIVERED PRICES

5 1/4" SINGLE SIDE SINGLE DENSITY 48 TPI W/HUB RING Packed 10 per Soft Pack	\$160 each	BULK SSSD 100/Case White Envelope W/HUB RING	\$140 each
5 1/4" SINGLE SIDE DOUBLE DENSITY 48 TPI W/HUB RING Packed 10 per Soft Pack	\$189 each	BULK SSDD 100/Case White Envelope W/HUB RING	\$170 each
5 1/4" DOUBLE SIDE DOUBLE DENSITY 48 TPI W/HUB RING Packed 10 per Soft Pack	\$275 each	BULK DSDD 100/Case White Envelope W/HUB RING	\$244 each

Free shipping in continental USA. Call for quantity discounts. We accept money orders, certified checks, VISA and MasterCard. Personal checks accepted, but take two weeks to clear bank. N.D. add 4%.

Software Services[™]
1326 - 25th St. S., Suite H
 Fargo, ND 58103
1-800-634-2248

Circle 332 on inquiry card.

Hewlett Packard

Write or call for prices.



SPECIALS ON INTEGRATED CIRCUITS

6502	7.45	10/ 6.95	50/ 6.55	100/ 6.15
6520 PIA	5.15	10/ 4.90	50/ 4.45	100/ 4.15
6522 VIA	6.45	10/ 6.10	50/ 5.75	100/ 5.45
2716 EPROM		4.45	5/ 4.20	10/ 3.95
2532 EPROM		5.90	5/ 5.75	10/ 5.45
6116 2Kx8 CMOS RAM		6.45	5/ 6.20	10/ 5.95
4116 RAM				8 for 14
4164 RAM				6.00

Anchor Automation Signalman Modems

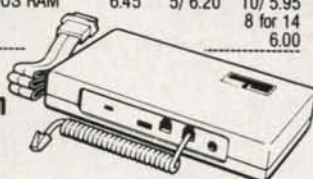

FREE SOURCE MEMBERSHIP WITH SIGNALMAN

All Signalman Modems are Direct Connect, and provide the best price-performance values.

Dealer and OEM inquiries invited

Volkmodem with computer cable	(99)	68
Mark VI for IBM Personal Computer	(279)	139
Mark VII Auto Dial/Auto Answer	(159)	99
Mark XII Smart Model 1200/300	(399)	299

DC HAYES Smartmodem	219
DC Hayes Smartmodem 1200/300	529



PROM QUEEN for VIC	170
Apple Emulator for Commodore 64	Call
STAT Statistics Package for C64	95
Solid Oak 2 Level Stand for C64 or VIC	29
C64/VIC Switch (networking)	129
BACKUP V1.0 tape copier for C64 or VIC	20
CARDBOARD/6 Motherboard - VIC	64
CARDBOARD/5 Motherboard - C64	56
CARD PRINT G Printer Int. with Graphics	72
CARD PRINT B Printer Interface—C64/VIC	40
CARDBOARD/3s Motherboard - VIC	22
CARDCO C64/VIC Calculator Keypad	32
CARDRAM/16 RAM Expansion - VIC	44
Complete CARDCO Line in stock	
CIE and VIE IEEE Interfaces in stock	
MSD SuperDrive for C64 or IEEE	365
MAE Assembler for C64	50
Koala Touch Tablet—C64 or VIC	79
CBC 4/12 12-bit A to D Board + Software	199
Multiplan for C64	79
Dust Cover for C64 of VIC	6

APPLE—FRANKLIN ITEMS

FRANKLIN—complete line in stock	219
QUENTIN Drives for Apple/Franklin	219
Swapper Stopper	26
automatic switch between paddles and joystick	
KRAFT Apple Joystick	40
Kraft Apple Paddle Pair	30
Koala Touch Tablet—Apple/Franklin	90
SPINNAKER Software in stock	
Broderbund Software in stock	
16K RAM Card for Apple	59
Multiplan—Microsoft	185
Solid Oak 2 Level Stand for Apple	29
Serial Card for Apple	89
MCP RAM/80 column card for Ite (AP/TXT)	139
Z80 Softcard and CP/M (Microsoft)	235
RANA Elite I with Controller	389
Parallel Printer Interface/Cable	69
Microtek and MCP Interfaces in stock	
Grappler + Interface	129
Kraft Products for Apple in stock	
DC Hayes Micromodem II	299
PFS: File	95
PFS: Report	95
Videx 80 Column Card	209
Apple Blue Book	19

commodore

See us for Personal, Business, and Educational requirements. Educational Discounts available.

PETSCAN I \$245 base price

Allows you to connect up to 30 CBM/PET Computers to shared disk drives and printers. Completely transparent to the user. Perfect for schools or multiple word processing configurations. Base configuration supports 2 computers. Additional computer hookups \$100 each.

COMPACT/STCP \$115

Intelligent Terminal Package for PET, CBM, C64
Includes ACIA Hardware / STCP Software

SCREENMAKER 80 Column Adapter for C64 145
Provides big screen capability for business applications.

GENESIS Computer Corp
VICController (for C64 as well) 50
combine with BSR modules for home or business control

COMSENSE Remote Sensing Adapter for C64 or VIC 35
COM VOICE Synthesizer for C64 or VIC 139
includes software for text to speech, pitch, etc.

COM CLOCK Real Time Clock with battery backup 45
VIC 20 Products and Software in stock

Thorn EMI Software	UMI Software
ABACUS Software	HES Software
16K RAM for VIC 64	Vanilla Pilot 27

VICTORY Software for VIC and C64		
Metamorphosis	16	Creator's Revenge 16
Labyrinth of Creator	16	Galactic Conquest 16
Kongo Kong	16	Annihilator 16
Chomper Man	16	Grave Robbers 13
Bounty Hunter	16	Adventure Pack I or II 16

PAPER CLIP Word Processor 99
ORACLE Data Base from Batteries Included 109
Super BusCard from Batteries Included 159
Commodore 64 Programmers Reference Guide 16
MicroChess for C64—8 levels of play 19
excellent graphics and color

SPINNAKER Software C64, Apple, IBM, Atari
Computer's First Book of PET/CBM 11
C64 or VIC SWITCH 129
POWER ROM Utilities for PET/CBM 78
WordPro 3+/64 with Spellmaster 85
WordPro 4+ - 8032, disk, printer 295
SPELLMASTER spelling checker for WordPro 189
VISICALC for PET, ATARI, or Apple 40
PET-TRAX PET to Epson Graphics Software 40
SM-KIT enhanced PET/CBM ROM Utilities 40
Programmers Toolkit - PET ROM Utilities 35
EASY CALC for C64 65
PET Spacemaker II ROM Switch 36
COPYWRITER Word Processor for C64 69
2 Meter PET to IEEE or IEEE to IEEE Cable 40
Dust Cover for PET, CBM, 4040, or 8050 8
CmC Interfaces (ADA1800, ADA1450, SADI in stock) 20
Programming the PET/CBM (Computer) — R. West 11
Computer's Machine Language for Beginners 79
MULTIPLAN for C64 79
HES MODEM with Software 65
HES Software and Hardware in stock
UMI products in stock

FlexFile for PET/CBM/ C64 \$ 50
Database, Report Writer with calculations, Mailing Lists.

FORTH for PET/C64 full FIG model—Cargill/Riley \$50
Metacompiler for FORTH for independent object code 30
KMMM PASCAL IV.1 for PET/CBM/C64 95
EARL for PET/CBM Disk-based ASSEMBLER 65
Super Graphics — BASIC Language Extensions 45
Fast machine language graphics routines for PET/CBM
RAM/ROM for PET/CBM 4K \$75 8K \$90

DISK SPECIALS



Scotch (3M) 5" ss/dd	10/ 2.20	50/ 2.00	100/ 1.95
Scotch (3M) 5" ds/dd	10/ 3.05	50/ 2.80	100/ 2.75
Scotch (3M) 8" ss/sd	10/ 2.30	50/ 2.10	100/ 2.06
Scotch (3M) 8" ss/dd	10/ 2.85	50/ 2.70	100/ 2.65

We stock VERBATIM DISKS

Write for Dealer and OEM prices.

Sentinal 5" ss/dd	10/ 1.90	50/ 1.85	100/ 1.80
Sentinal 5" ds/dd	10/ 2.55	50/ 2.50	100/ 2.45

We stock DYSAN disks

Wabash 5" ss/sd	10/ 1.60	50/ 1.55	100/ 1.45
Wabash 5" ss/dd	10/ 1.90	50/ 1.85	100/ 1.75
Wabash 8" ss/sd	10/ 2.00	50/ 1.95	100/ 1.85

We stock MAXELL DISKS

Write for dealer and OEM prices.

Disk Storage Pages	10 for \$5	Hub Rings 50 for \$6
Disk Library Cases	8"—3.00	5"—2.25
Head Cleaning Kits	12	
AMARAY Disk Storage Systems in stock		
Innovative Concepts FLIP 'N' FILES in stock		

CASSETTE TAPES—AGFA PE-611 PREMIUM

C-10	10/ .61	50/ .58	100/ .50
C-30	10/ .85	50/ .82	100/ .70

DATASHIELD BACKUP POWER SOURCE \$265

Battery back up Uninterruptible Power Supply with surge and noise filtering. The answer to your power problems.

MultiPlan—IBM or Apple 185

Quadboard for IBM available
KOALA Touch Tablets—Apple, Atari, IBM, CBM

Peachtext 5000 Software Package 209

PFS Software for IBM and Apple in stock
VOTRAX Personal Speech System 280
BMC 9191 Color Monitor 229
BMC 12A 12" Monitor 79
Brother HR-75 Daisy Wheel Printer 769
Dynax (Brother) DX-15 Daisy Wheel Printer 469
Itoh Prowriter Parallel Printer 379
Panasonic 1090 Printer with Correspondence Mode 279
Daisywriter 2000 with 48K buffer 1020
Gemini 10X 299
EPSON, Okidata, Star Micronics printers in stock
USI CompuMOD 4 R F Modulator 29

We Stock AMDEK Monitors

Amdek DXY-100 Plotter 590
A P Products 15% OFF
COMPUTER COVERUPS IN STOCK
BROOKS 6 Outlet Surge Suppressor/Noise Filter 54
Surge Suppressor-6 outlet 29
Electrohome 1302-2 13" Hi-res RGB Monitor 335
Panasonic 12" Monitor (20 MHz) with audio 135
Synertek SYM-1 Microcomputer 189

ALL BOOK and SOFTWARE PRICES DISCOUNTED

USI Video Monitors—Green or AMBER 20 MHz hi-res.
Dealer and OEM inquiries invited

ZENITH data systems

ZVM-122A 109 ZVM-123G 95
ZVM-131 300 ZVM-135 510
HERO 1 Robot (factory assembled) 2145
Z29 Terminal (DEC and ADM compatible) 680
ZT-10 Intel Terminal with Serial Port 340
Z100 16-bit/8-bit Systems CALL
We stock entire Zenith line.

ATARI — WE STOCK ENTIRE LINE

SPINNAKER and Broderbund Software in Stock.

215-822-7727
252 Bethlehem Pike
Colmar, PA 18915

A B Computers

WRITE FOR CATALOG. Add \$1.50 per order for United Parcel.
We pay balance of UPS surface shipping charges on all prepaid orders
(add extra for mail, APO/FPO, air). Prices include cash discount.
Regular prices slightly higher. Prices subject to change.

RTL

**Relocatable
Threaded
Language** **\$150**

RTL is a new language which retains the speed and extensibility of Forth but adds many additional advantages as a result of its more structured dictionary. Names, code, and variables are all stored in separate areas for easy generation of headerless, romable code. All code is relocatable. RTL supports local variables, multitasking, redirected I/O, and even allows definitions to be changed retroactively. All source code is included. Versions are currently available or under development for 68000, 6809, 8080, 280, 8086, 8088, and 6502.

RTL Programming Aids
10844 Deerwood SE
Lowell, MI 49331
(616) 897-5672

Circle 309 on inquiry card.



RS232C Computer compatible Paper Tape Transmitter/Model 612

Stops and starts on character at all speeds, uses manual control or X-on, X-off 90-260 volt, 50-60 Hz power. 50-9600 baud, up to 150 char/sec synchronous or asynchronous; gated internal or external clock, RS 232C, current loop or parallel output, reads 5-8 level tape, 7-11 frames per character, even or odd parity. Desk top or rack mount.

Addmaster Corporation, 415 Junipero Serra Drive, San Gabriel, CA 91776, (213) 285-1121, Telex 674770 Addmaster SGAB

Circle 12 on inquiry card.

300 BAUD	MODEMS	1200 BAUD
SIGNALMAN...Free hour on 'SOURCE'		
300/1200 AUTO DIAL/ANS		\$319
'Hayes Compatible'		
300 BAUD AUTO DIAL/ANS		\$119
300 BAUD direct connect		\$ 69
US ROBOTICS...300/1200...MODEMS		
'Hayes Compatible'		
'Password' with cables, spkr		\$339
'S100' card		\$339
'Auto 212' dlxe.....		\$419
DOT MATRIX	PRINTERS	LETTER QUALITY
GEMINI 10x 120 cps graphics		\$CALL
PROWRITER 120 cps hi density		\$359
JUKI daisys wheel 18 cps		\$529
IBM	HARD DISKS	CPM
10 Mbyte.....	\$1295	40 Mbyte....\$2495
23 Mbyte.....	\$1995	65 Mbyte...\$CALL
IMAGE COMPUTERS		
P.O. Box 1164, Cardiff, CA 92007		
CALL TO ORDER:		
(619) 942-7373		VISA/MC
(619) 436-7669		ADD 3%
(619) 270-3600	*Dealer Inquiries Invited	

Circle 129 on inquiry card.

MICROCONTROL!

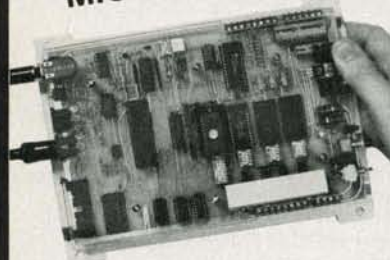

CONTROL THE REAL WORLD LIKE NEVER BEFORE!
AND DO IT FOR AS LITTLE AS \$299*

THE NEW RBE SYSTEM • Z80 28671 MCU • 18 K MEMORY
FRIENDLY BASIC INTERPRETER • PARALLEL AND SERIAL PORTS •
15V AC POWER CONTROL PORTS • A TO D SENSOR INPUT PORTS •
BATTERY RAM AND MUCH MORE • WRITE FOR INFO.

*BASE PRICE

HHS MICROCONTROLLERS
5876 OLD STATE
EDINBORO, PA 16112
(814) 724-4338

Circle 177 on inquiry card.

RS-232 DATA TAP...

Made in America



RS-232 DATA TAP...

Can be used to monitor the data which is being transmitted and received on a RS-232 line. Drives a printer, CRT, or any other RS-232 receive type device. Requires no AC power or batteries to operate.

ORDER NOW! Only \$34.95, plus \$1.75 shipping and handling, (IL res, add 5% sales tax); we accept MC or VISA. FREE: illustrated catalog of problem solving equipment. Phone: 815/539-5827. Make checks payable to:

B&B electronics
Box 475B, MENDOTA, IL 61342

Circle 37 on inquiry card.

Serial Parallel



Convert What You Have To What You Want!

- RS232 Serial
- 8 Baud Rates
- Latched Outputs
- Centronics Parallel
- Handshake Signals
- Compact 3 1/2" x 4 1/2" x 1 1/2"

No longer will your peripheral choices be limited by the type of port you have available! Our new High Performance 700 Series Converters provide the missing link. Based on the latest in CMOS technology, these units feature full baud rate selection to 19.2K, with handshake signals to maximize transfer efficiency. Detailed documentation allows simplified installation. Order the Model 770 (Ser/Par) or Model 775 (Par/Ser) Today!

Buffer Products Connector Option \$10.00
Coming Soon! 1501-B Pine Street Post Office Box 2233 Ontario, California 93030
CALL (805) 487-1665 or 487-1666 For FAST Delivery

Circle 155 on inquiry card.

Smith-Corona TP-1 Daisy Wheel Printer

only \$399⁰⁰

UNBELIEVABLE!

- fully-formed characters
- compatible with most micro-computers
- serial or parallel interface
- choice of 10 or 12 CPM models

Also for your TP-1 letter quality printer—the Smith-Corona Tractor Feed

\$129⁰⁰

- Adjustable tractor widths
- For continuous forms
- Quick, easy removal



Call Collect
(214) 826-6521

FIGURE-LOGIC BUSINESS EQUIPMENT, INC.
6408 Gaston Avenue / Dallas, Texas 75214

Circle 162 on inquiry card.

ANALOG ↔ DIGITAL DIGITAL ↔ ANALOG

CONVERSION MODULES

SOFTWARE GAIN CONTROL

high accuracy — programmable gain instrumentation amplifier — custom board test — \$-100 — 2 to 15 khz conversion time — mixable high and low inputs — gain from 1 to 1024 — 12-bit sample and hold amplifier — 8-channel differential — 16-channel — analog to digital high accuracy — programmable gain instrumentation amplifier — custom board test — \$-100 — 2 to 15 khz

For additional details about the AD-100-4 and other fine California Data Corporation 100% individually tested, high reliability products, circle the reader service card number below or for faster response write or call us.

CALIFORNIA DATA CORPORATION
3475 Old Conejo Road, Suite C-10
Newbury Park, CA 91320
(805) 498-3651

Circle 56 on inquiry card.

MEMOREX FLEXIBLE DISCS

WE WILL NOT BE UNDER-SOLD!! Call Free (800)235-4137 for prices and information. Dealer inquiries invited and C.O.D.'s accepted.

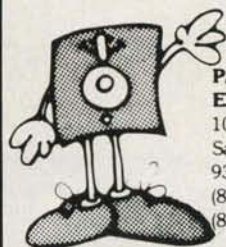

PACIFIC EXCHANGES
100 Foothill Blvd.
San Luis Obispo, CA
93401 In Cal. call
(800)592-5935 or
(805)543-1037

Circle 278 on inquiry card.

MEGA-BOARD™

new!

Ideal for

- **COMPUTERISTS**
- **OEM MANUFACTURERS**
- **DEVELOPMENT LABS**
- **UNIVERSITIES**
- **INDUSTRIAL APPLICATIONS**

**THE ULTIMATE OEM/PC
COMPATIBLE SINGLE
BOARD COMPUTER**

**FULL IBM - PC*
COMPATIBILITY!**

**DEALERS AND OEM MANUFACTURERS
QUANTITY DISCOUNTS AVAILABLE**

**Standard Key-
board Interface**
(Full PC compatible)

Hardware Reset
(Overcomes reset flaw
in PC)

**Eight Compatible
I/O Interface
Connectors**
(Full PC compatible)
(compatible with all
IBM-PC* plug-in cards)

Power Connector
(Full IBM* pinout
compatible)

**Special J1
Interface**
(Allows horizontal mount-
ing of compatible expan-
sion cards for easy bus
expansion and custom
configuring) (Board has
62 pin gold plated compat-
ible connector)

8088 Processor
(Same as PC)

**8087 Numeric
Processor**
(Same as PC)

**Peripheral
Support Circuits**
(Same as PC)

**Extended ROM
Capability**
(Runs all compatible PC
ROMS) (Jumper program-
mable to accommodate all
popular 8K, 16K, 32K and
64K ROM chips and NEW
EE ROMS! VPP power pin
available for EP ROM
burning!) (External
VPP voltage required)

**Configuration
Switches**
(Same as PC)

**Speaker/Audio
Port**
(Same as PC)

Board Size
10.5 inch X 13.5 inch

Wire Wrap Area
To facilitate special custom
applications!

**Full Mega-Byte Ram Capacity!
On board!**
(With parity)
 256K Bytes using 64K chips
 1 Mega Bytes using 256K chips

ONLY!
\$9995
**Evaluation
Board Kit**

MEGA-BOARD™ Evaluation Board Kit!
(Blank board with full assembly
instructions and parts list.)

Includes highest quality PC board
with gold plating, silk screen,
solder mask

ORDER NOW!!!

- MEGA-BOARD™** with full assembly instructions \$99.95
- USERS MANUAL** with theory of operation,
schematics, block diagram, application notes \$19.95
- MEGA-BIOS™** fully compatible MS-DOS/PC-DOS BIOS \$29.95

ORDER NOW!!!

SATISFACTION GUARANTEED!
10-day money back guarantee if not completely satisfied.

DTC™ DISPLAY
TELECOMMUNICATIONS
CORPORATION

4100 SPRING VALLEY ROAD
SUITE 400
DALLAS, TX 75234
(214) 991-1644

TERMS: Shipment made 2 to 5 weeks from
receipt of order. VISA, MC, money order,
company check accepted. COD'S require
\$25 deposit. Balance UPS COD. Please
add \$2.00 shipping and handling per order.

*IBM and IBM PC are trademarks of International Business Machines

©1983 Display Telecommunications Corporation

DISKETTES AND COMPUTER SUPPLIES



BUY QUALITY...

- 3M Scotch Brand Diskettes
- Ribbons and Printwheels
- Labels and Paper
- Diskette Storage Equipment
- and Much More!

....AT LOW PRICES!

We ship within 24 hours, and we pay the shipping.



C.O.D.



CALL TOLL FREE
800-448-4016

IN CA 800-556-6786

MY Supplier, Inc.

COMPUTER AND WORD PROCESSING SUPPLIES
348 No. Moorpark Road
Thousand Oaks, CA 91360

Circle 262 on inquiry card.

Apple II/Ile® Robotic Development Package



2 Axis Stepper Motor System

- A6 T/D Plug-In Interface
- R2 D23 Dual Axis Driver
- (2) Size 23 Motors
- Positioning Command with Ramping from Applesoft® BASIC

\$365
(35 oz. in.)

Also Available with:

- (2) Size 34 Motors (220 oz. in.) & R2 D34 Dual Axis Driver

\$595

ROGERS LABS (714) 751-0442
2710 S. Croddy Way, Santa Ana, CA 92704

Circle 308 on inquiry card.

MEMORY FOR IBM PC-XT



64K — \$159.95
320K — \$319.95
384K — \$359.95
512K — \$439.95

- Uses 64K Drums
- Gold Fingers — Solder Mask
- Addressing On Any 64K Block
- No Parity

Add 6% sales tax in California. Add \$2.00 for shipping. Add \$2.00 for C.O.D. Send check or money order to:

In Sync

5738 Commerce Blvd.
Rohnert Park, CA 94928
(707) 585-2793

Circle 188 on inquiry card.

Disks 'n Things

★ Dealer Inquiries
Welcomed

maxell

Dysan
CORPORATION

wabash



**SUPER
LOW
PRICES**

- ★ Finest Quality
- ★ Factory Warranty
- ★ Fast Delivery

CALL 213-706-8602

- Credit For Direct Dial Call With \$30 Order
 - We Pay Shipping—MC/VISA—OOD Costs
 - 2% Discount For Cash
- Applicable to USA Customers Only

Disks 'n Things

5505 Softwind Way
Agoura Hills, CA 91301



Price List Available

Circle 133 on inquiry card.

6800/6809 Micro Modules

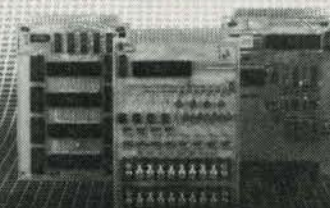

OEM 6800/6809 MICROCOMPUTER MODULES for dedicated control and monitoring. Interfaces for sensors, transducers, analog signals, solenoids, relays, lamps, pumps, motors, keyboards, displays, IEEE-488, serial I/O, floppy disks.

WINTERK

Wintek Corp.
1801 South Street
Lafayette, IN 47904
317-742-8428

Circle 380 on inquiry card.

wabash®

When it comes to
Flexible Disks, nobody
does it better than
Wabash.

MasterCard, Visa Accepted.
Call Free: (800) 235-4137

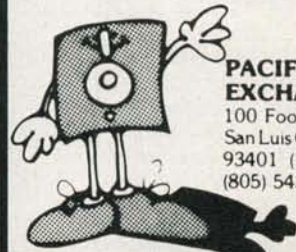

**PACIFIC
EXCHANGES**

100 Foothill Blvd
San Luis Obispo, CA
93401 (In Cal. call
(805) 543-1037.)

Circle 278 on inquiry card.

CATALOG

DISK/FILE CATALOGING SYSTEM

For 8080/286 CPM® Systems

ORGANIZE, LOCATE, IDENTIFY ALL FILES

- filenames, sizes, user numbers and user-entered notes instantly available
- powerful search directives simplify file location
- 255 disk capacity per data-base; unlimited number of data-bases
- no limit on number of files per data-base
- locates "hidden" files
- shows space used on each/all disks

\$75, plus shipping and handling

No other program can do what CATALOG does... Computer record keeping has come of age!

Dealer and OEM inquiries welcome.

CPM® is a registered trademark of Digital Research

**SRX
SYSTEMS**
2812 Westberry Drive
San Jose, CA 95132
408/926-9411

Circle 335 on inquiry card.

Multi-GRAPH Multimode-Color- Graphics- Video-Controller

APPLE, COMMODORE, SS50C-Bus, Multibus

the ultimate all in one graphics controller:

- 512x512 dot high resolution, 14 MHz dot clock
- 192 kbyte on board screen memory for 2 full pictures
- 8 of 4096 progr. colors / 8 level greyscale with b/w
- prog. hardw. ASCII char. generator 53 dots (1 - 16 zoom)
- hardw. vector generator, 4 types of lines, 1,500,000 dots/s
- built-in lightpen interface (on dot basis)
- 3 powerful operation modes, simult. colored and b/w
- designed for easy software implementation, plotter-like programming
- read-modify-write hardware for non-destructive cross-hairs, cursors etc.
- fully decoded; jumper sel. 32 byte address range
- many additional features: hardw. blinking, write-protection, tilted chars, interrupt-generation, X/Y screen-mem. addressing, no wrap-around effects, progr. comp. video input(), universal RGB and comp. video output, special b/w modes
- independent 128 kbyte EPROM area, 8 or 16 Bit (Multibus - only)
- APPLE and COMMODORE interface includes extra case with power supply!

APPLE, COMMODORE \$ 1875
(SS50-board, metal-case, power supply, interface)
SS50-Bus, Multibus (board w.o. EPROMS) \$ 1670
high speed lightpen with 50 nsec delay and switch \$ 335

delivery as described + manual, data sheet, interfacing software, please ask for detailed information

Dipl. Ing. Jürgen Knauft

SOFTWARE HARDWARE DIGITALELECTRONIC
D 6457 Maintal 1, Birkenweg 1, Tel. 0 61 81 / 4 56 43
W. Germany - Multibus is trademark of INTEL Corp.

Circle 469 on inquiry card.

JUKI 6100 LETTER QUALITY PRINTER

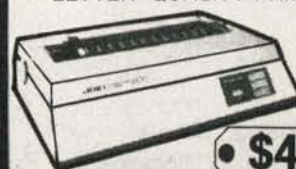

\$469.

- 18 cps
- Word processing and graphic functions
- Proportional spacing control
- Uses IBM Selectric ribbons
- Compatible with Kaypro, IBM, Apple, Osborne, and others.



Free shipping in U.S.



**COMPUTERS
and more**

2420 University Ave., To Order
San Diego, Ca. 92104 (619) 291-1442

Circle 105 on inquiry card.

Freedom - Freed the Prices!

We have met or have beaten most advertised prices.

Buy Direct!



32 CPS
48K Buffer
Serial and Parallel
1 Year Warranty
380 Z \$ Unbeatable
38K STARWRITER .. \$ Unbeatable

DTC 380 Z



Mannesmann Tally

- Standard — 7 x 9 160 CPS
- NLO — 40 x 18 40 CPS
- 2K Buffer and Tractor Standard

160 L 80 col. Call Best Seller
180 L 132 col. Call Best Seller
Spirit Call Best Seller

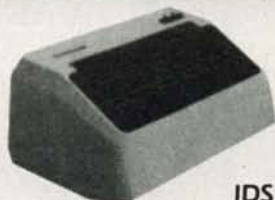

IDS

- Proportional Spacing
- 8 Character Styles
- 200 CPS Bi Directional
- Color Optional
- Sheet Feed • Graphics
- 3.4K Buffer

Prism 80 \$ Call
Prism 132 and Micro Prism \$ Call
Auto Cassette Sheet Feed \$ Call

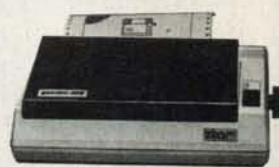

Star Micronics

Gemini 10X + 15X
120 CPS \$ Call
Delta 10X
160 CPS \$ Call
STX 80 \$ Call



EAGLE

IBM Compatible
Simply a better PC. All models
available for immediate delivery
Call Lowest \$

OUR PC FLYS



Juki 6100

18 CPS IBM Ribbons
Diablo Compatible 2K Buffer
Best Value Yet \$ Call



It's a Piece of Cake!

High Quality Software
for Personal Computers

- Word Processor
- Mail List
- Spelling Checker
- Telecom

NEW!

- Graphics Package
- Financial Planner
- Data Manager

Call for Prices!



Red Hot
Special!

Novation J-CAT

- 300 BPS Modem
- Originate/Auto Answer

Sizzling \$89.50

DAISYWRITER
FRANKLIN
HAYES
ALTOS
ZENITH
TELEVIDEO
SANYO
USI
TRANSTAR
PIED PIPER
RANA
STB
QUADRAM
PRINCETON GRAPHICS

VENTEL
AMDEK
BMC
TAXAN
DIABLO
NEC
EPSON
PRINTEK
MOLECULAR
UDS
SILVER-REED

U.S. ROBOTICS
OKIDATA
COMREX
JUKI
STAR
NORTHSTAR
ADDS
KIMTRON
INTERCOLOR
COLUMBIA
CORONA

C. ITOH
DEC
AMPEX
TOSHIBA
VEW
RIXON
HAZELTINE
SEIKOSHA
TTX
WYSE
TEXAS INSTRUMENTS

SANYO P.C.
OTRONA
BLUE CHIP
PRINTACOLOR
QUME
KEYTRONICS
ANCHOR
BROTHER
VISUAL
DAISY

Everything in computer related products:

- Computers
- Modems
- Printers
- Software
- Monitors
- Terminals
- Accessories
- Paper
- Ribbons
- Diskettes
- Office Furniture
- In-Store Training

For Price Quotes and Ordering, Call:

1-800-821-4128

For Technical Information and
Order Status, Call:

602-952-1057 or 602-954-6127



3370 North Hayden Road • Suite 123-314
Scottsdale, Arizona 85251

Prices listed reflect a cash discount and are subject to change without notice. C.O.D.s are shipped with a minimum C.O.D. charge. Allow 3-7 days for personal checks to clear. Product is subject to availability. Equipment is in factory sealed boxes with manufacturer's warranty. There will be a re-stocking charge for returned merchandise. Call first for an RMA number. Software not warranted for suitability. No return of Software which has been opened. Add 2% for shipping & handling charges (minimum \$2.50). All equipment shipped F.O.B. Scottsdale, AZ 85251. Circle 222 on inquiry card.

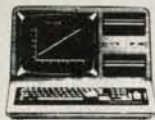

Best Prices On TRS-80 Computers

Our 6th year of discounts
Ed or Joe McManus
Fgt. Prepaid. Save Tax.
Toll Free 800-231-3680
Marymac Industries, Inc.
22511 Katy Fwy., Katy
(Houston) Tx 77450
1-713-392-0747
Telex 774132

See us in the Wall Street
Journal every Tues., Wed., Thurs.

Circle 235 on inquiry card.

DATA SWITCH FOR IBM PC PRINTER INTERFACE



Model 1220 Bi Directional Data Switch with 3-3ft. data cables gives an IBM PC user 2 Centronics Interfaces to connect a draft printer & letter quality printer to his Parallel Interface. A toggle switch on the front panel selects the desired printer. Runs at any speed. Built in data cables, save money. Supplied assembled and tested. \$179.00. Available from your local computer dealer or

Terminal Data Corp.
11878 Cookley Circle, Rockville, MD
(301) 881-7655

Circle 354 on inquiry card.

LSI C COMPILER for 8080/8085/Z80

New version of the compiler is available now!

The object code is **COMPACT** and is **FASTEST** in current C compilers

Our "Sieve" program runs in 8.0 seconds (standard) and 6.2 seconds (optimized)

(See January 1983 BYTE, pp 283-326)
price : \$500 (FOB Japan)

for pamphlet write:
P.O.Box 508 STA. CRUZ
CA. USA 95062

for further information contact:

LSI JAPAN CO., LTD.
2-24-9 YOYOJI SHIBUYA-KU TOKYO (151) JAPAN
PHONE(03)379-2427

Circle 227 on inquiry card.

HOFACKER

Books • Software • Hardware Add-Ons • for your ATARI 600XL/800 XL, Commodore-64, VIC-20, Sinclair, Timex, Apple II, Osborne-OS/1

BLIZTEXT — More than just a word processor for the C-64! More than 70 commands, screen-oriented, use any printer, terminal software included for electronic mail and networking. The best wordprocessor for the C-64.
Order No. 4965 \$89.00

MACROFIRE — Editor/Assembler for the C-64
Order No. 4963 \$89.00

The best macroassembler you can buy!
Order No. 4963 \$89.00

SUPERBOOKS for your C-64
The Great Book of Games, Vol. 1
40 programs for the Commodore-64.
Order No. 182 \$8.95

Programs from this book on disk \$19.95

MORE ON THE SIXTYFOUR
Tips, tricks, hints, very important subroutines.
Order No. 183 \$9.95

Programs from this book on disk \$19.95

How to program in 6502 Machine Language on your C-64
Order No. 184 \$12.95

Commodore-64 Tune-up, Vol. 1
How to expand your C-64.
Order No. 185 \$12.95

Small Business Programs for the C-64
Order No. 186 \$12.95

HARDWARE ADD-ONS for your C-64
Parallel printer interface, R/T
Order No. 4990 \$19.95

Universal Experimentor Board
Order No. 4970 \$9.95

Expansion Board KIT — Hooks up to 4 Exp. Boards (bare board).
Order No. 4992 \$29.95

Dealer and Distributor inquiries are invited.
ELCOMP PUBLISHING, INC.
53 Redrock Lane
Pomona, CA 91766
Phone: (714) 823-8314, Telex: 29 81 91

Wordprocessor for all ATARI computers
No one can provide better performance for this price!
ATEXT-1
This wordprocessor is an excellent buy for your money. It features screen oriented editing, scrolling, string search (reverse), left and right margin justification. Over 30 commands. Text can be saved on disk or cassette.
Order No. 7210 cassette \$29.95
Order No. 7218 disk \$34.95
Order No. 7217 cartridge \$69.00

Games for the ATARI Computer
This book describes advanced programming techniques like player-missile graphics and use of the hardware registers. Contains many ready to run programs in BASIC and one called GUNFIGHT in machine language.
Order No. 162 \$7.95

How to program your ATARI in 6502 Machine Language
Introduction to machine language for the BASIC programmer.
Order No. 168 \$9.95

FORTH on the ATARI — Learning by Using.
Introduction, programs, applications, learning exercises.
Order No. 170 \$7.95

All programs from book No. 170 on disk.
Order No. 7319 \$22.00 only!

HACKERBOOK for your Atari computer
Tests/tricks—Very important subroutines in 6502 machine language. How to make bootable cassettes, disks, and EPROMs. Complete construction article and software on how to build an EPROM burner.
Order No. 172 \$9.95

Copyright © 1983 by Ecomp Publishing Inc.

PAYMENT Check, VISA, MC, CA residents add 6.5% sales tax. Outside USA add 15% for shipping.
In Singapore contact telco #822488
In Germany contact telco 626972

Circle 148 on inquiry card.

LOOK!

SYSTEMS

CompuPro 816A (A&T)	\$55495
Eagle PC2	2738
Televideo PC (Dual)	1680
Corona PC	CALL

LETTER QUALITY PRINTERS

Daisywriter 2000 48K	1030
NEC 3510	1455
Juki	CALL

DOT MATRIX PRINTERS

Epsons FX, MX, RX	CALL
Okidata 92	506
Gemini 10x, 15x	CALL

Terminals, modems, software and more available
CALL

14 W. 3rd St., #5
Santa Rosa
CA 95401



Prices Subject
To Change
Without Notice

(707) 575-9472

VISA • MC • LEASING

Circle 377 on inquiry card.

FAST PRECISION A/D FOR APPLE II®

- * 40,000 SAMPLES / SECOND DATA ACQUISITION RATE
- * 12-BIT RESOLUTION
- * 0.1% ACCURACY
- * 8 ANALOG INPUT CHANNELS
- * REMARKABLE PRICE \$375

ALSO: LOW-COST PRECISION A/D
12 SAMPLES / SECOND \$195

ACCESSORIES

- 2-CHANNEL THERMOCOUPLE THERMOMETER
- 1° CENTIGRADE ACCURACY \$135
- 6-CHANNEL THERMOMETER \$155
- 16-CHANNEL MULTIPLEXER \$160
- 1-4 CHANNEL OUTPUT CONTROLLER CALL

LAWSON LABS, INC.

5700 RAIBE ROAD
COLUMBIA FALLS, MONTANA 59912
406-387-5355

Circle 218 on inquiry card.

IBM PC, APPLE, etc. . .

SHARING AND SWITCHING PROBLEMS?
GILTRONIX HAS THE SOLUTION!



Any CPU

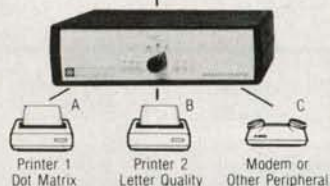

Printer 1
Dot Matrix

Printer 2
Letter Quality

Modem or
Other Peripheral

MANUAL UNITS 2-6 Ports
Selecto-Switch

OR

AUTOMATIC UNITS 2-7 Ports
Auto-Switch

Serial (RS 232)/Parallel (Centronics)

LOW COST ADD-ONS FROM THE MAIN MANUFACTURER



3780 Fabian Way, Palo Alto, CA 94303
(415) 493-1300

Circle 171 on inquiry card.

ScreenWiz FULL SCREEN CONTROL

An assembler subprogram you call from your programs to handle screen input/output as **IBM mainframes** do.

Define full screen format specifications outside your program, and call **ScreenWiz** to retrieve the formats, and do all the I/O for you.

- One command input/displays a full screen
- Use all of your CRT video attributes
- Define up to 24 function keys
- Define templates for display and input.
- Validate input while keying. Insert and delete characters to correct fields
- Tab fields forward and backward
- Draw figures using vertical field displays
- Save memory as only one format needs to be in memory at one time. Make the constants to display virtual, and they don't use any memory at all.
- Build help screens. Call them with one function key then return to where you were.

Available now for most popular —

BASIC	IBM PC	\$99
COBOL	CP/M - 80	\$99
FORTRAN	Shipping	\$ 6
PASCAL	Source code included	

INTERDATA SYSTEMS INC.

15 Toronto St. Suite 700
Toronto, Ont. Canada M5C 2E7
(416) 366-2136 (call collect to order)

Visa, M/C
Am. Express

Circle 194 on inquiry card.

Radio Shack TRS-80™ Computers

At Guaranteed Savings



from
Pan American Electronics

1117 Conway Ave.
Dept. B
Mission, Texas 78572
Ph. 512/581-2766

Telex 767339
TO ORDER
CALL TOLL FREE
800-531-7466

Circle 280 on inquiry card.

HALF-HEIGHT SHUGART DRIVE SYSTEM FOR IBM-PC

Choose 2 or 4 320K byte half heights or 2 half-heights plus a hard disk.

- Powered by energy efficient direct drive DC motor
- Mounting kits available for most popular systems
- Clear and simple instructions
- Full one year warranty

IBM-PC 10 Megabyte Half-Height Hard Disk

Up grade your PC to an XT! Call 609-799-4440 10 Megabyte Half-Height Hard Disk also available for your COMPAQ SA-712 Half-Hgt. 10 Meg Hard Disk Call

SHUGART HALF-HEIGHT DRIVES

Shugart SA465 DS/DD Half-Height 96TPI New! Allows reading and writing in single or double density 5.25 diskettes. Plug compatible with TANDON TM 100-4, SIEMENS FDD-221-5 and similar drives. 1 YEAR WARRANTY \$350 each 2 @ \$295 each Formatted single density 700K bytes



SHUGART SA860 DS/DD Half-Height 8"

A double sided half height 8" high speed disk drive. DC only operation. Same as used on Zenith Z-100. 1 YEAR WARRANTY \$495 each 2 @ \$475 each Formatted 1.25 megabyte Track to track 3ms



SHUGART SA455 DS/DD Half-Height 48TPI

A double headed minifloppy disc drive with up to 320K on-line storage capacity. Plug compatible with any standard 5 1/4" drive. Electrically the same as TM-100-2 and FDD-211-5. 1 YEAR WARRANTY \$245 each Formatted 320K bytes, extended 360K bytes Track to track 6ms

HEATH ZENITH H88, 89 or 90 TWOET SYSTEMS Dual internal half-height disk drives

Now you can replace your built-in drive with two double-sided, double or single density, internal half-height drives in either 48 or 96tpi format, with all hardware, cables, power connector adaptors, and documentation included. Our double-sided 48tpi works perfectly as a single sided right out of the box. You can even use this system with your H-17 controller. And we have the software drivers (at additional cost) so you can run out 48 or 96tpi double-sided, single density drives on it!

Both models are shipped complete with all hardware, shielded metal mounting plates, data cable with chassis connectors, and complete documentation. **WHAT TO DO WITH YOUR INTERNAL DRIVE:** For only \$60 extra plus shipping, we'll send you a single 5 1/4" case with power supply and data cable — ready to receive your SIEMENS internal drive! A regular \$80 value. The external chassis disk I/O connector comes with your TWOET system

W.S.T. DISK DRIVES (formerly Siemens)

W.S.T. FDD-100-5B4 Same model used in Heath computers. Added "Flippy" operation feature. Works with almost any SA-400 compatible system: RS Model 1, North Star, S-100 and more. \$235 each C3-\$195 each (with Shugart type Bezel)

W.S.T. FDD-211-5

Dual headed 5 1/4" Records data in single or double density, using hard or soft sector techniques. An exact TM-100-2 replacement. Use in Northstar and IBM, or any system using dual head 48 tpi drives. Same as COMPAQ. \$265 each.

NUMBER OF HEADS 2
FORMATTED DATA CAPACITY 320K bytes
extended 360K bytes

W.S.T. FDD-221-5

A double headed, 5 1/4", 96 tpi (80 track) disk drive. Capable of hard or soft sector, single or double density, it's an exact replacement for the TANDON 100-4. \$335 each 2 @ \$295 each

Increase your on-line storage capacity by 2.5 megabytes with Our new 8" double sided half height disk drive. Styling matches IBM-PC. Utilizes Shugart half-height 8" double sided disk drives. Allows reading CP-M data files with optional patch.

FD-PC8 System \$1270
Maynard Controller \$245
(Allows use of two internal 5 1/4" and the two outboard 8" system. Add \$70 for parallel)
JFormat \$50
JFormat-2 \$50
We have half-height mounting kits for IBM and COMPAQ computers.

APPLE HALF-HEIGHT DISK DRIVES Call for price

ENCLOSURES

MODEL	CONFIGURATION	STACKING	DIMENSIONS	ALSO AVAILABLE	PRICE
DH5A&T	2 standard 5 1/4"	horizontal	17" L x 12" W x 5" H	external chassis connector/blank plates	\$125.00
SV5A&T	1 standard 5 1/4"	vertical	11 1/2" L x 3 1/2" W x 6" H	vertical 5 1/4" case for 2 half-height drives	\$55.00 or \$75.00 for 1/2 height
DV5A&T	2 standard 5 1/4"	vertical	11 1/2" L x 6" W x 7" H	—	\$85.00
D5HHHA&T	2 half-height + space for single board computer	horizontal	17" L x 12" W x 3 1/2" H	blank plates ext. chassis conn.	\$125.00
5SHA&T	1 standard 5 1/4" or 2 half-height drives	horizontal	12" L x 8" W x 4" H	blank plate ext. chassis conn.	\$95.00
5SHDA&T	1 standard or 2 half-height hard disks	horizontal	12" L x 8" W x 4" H	blank plate	\$165.00

8" ENCLOSURES

All 100% our design, these 8" enclosures feature a front panel power switch designed with 1" clearance over the drive to accommodate a big board computer or a hard disk controller. All 16 gauge metal construction with DB 25 cutouts on the rear panel. CP-206 supply mounting holes, which are standard for the 8" drive industry.

DH8A&T	2 standard 8" (such as SHUGART 800-R series or SIEMENS FDD-100 series)	horizontal	21" L x 17 1/4" W x 6 1/2" H	ext. chassis conn.	\$295.00
SH8A&T	1 standard 8" or 2 half-height drives + space for single board computer	horizontal	16" L x 12 1/2" W x 6 1/2" H	blank plates ext. chassis conn.	\$285.00
DHH8A&T	for SHUGART TANDON 848 or similar 8" half-height designs	horizontal	20.5" L x 17" W x 4" H	blank plates ext. chassis conn.	\$320.00
FDC8	for SHUGART 810-860 matches IBM PC or Zenith systems	horizontal		blank plates	\$320.00

MULTIDISPLAY

For IBM-PC, contains both mono and color display plus printer port, all on one card \$575

PGS MONITOR

The best RGB monitor going \$475

SANDSTAR MODULES FROM MAYNARD

Sandstar Serial Port Module

Totally compatible with software written for IBM Asynchronous Adaptor. Connects to MODEM, serial printer, or any standard RS232-C interface device. Port may be configured as Serial Port #1 or #2. Can use IBM diagnostics. MSE1301 \$105.00

SandStar Clock Calendar Module

Features clock and calendar with battery backup, which runs when PC power is turned off or plug is disconnected. Correct time and date loaded each time system is powered up. Software included. MCL1303 \$85.00

SandStar Parallel Port Module

A Centronics compatible I/O port. Use as general purpose I/O port or connect to printer. Utilizes same type connector and pins as IBM Parallel Printer Adaptor, and is 100% compatible with its software. Configure as Port #1 or #2. Can use IBM diagnostics. MPA1302 \$75.00

SandStar Memory Module

Use with SandStar Memory Card. Expands memory by 320K bytes for 640K bytes total system memory. Uses only one IBM expansion card. No configuration required before plug in.

Module may be purchased with any 64K increment and easily expanded to 320K. Electronic disc and print spooling software are also available.

MMOD000	0K	\$115.00
MMOD064	64K	\$205.00
MMOD128	128K	\$300.00
MMOD192	192K	\$390.00
MMOD256	256K	\$485.00
MMOD320	320K	\$580.00

SandStar Game Adaptor Module

Attach up to 4 paddles and 2 joysticks to your IBM PC. Can be used for general purpose input, with 4 digital and 4 analog inputs. 100% compatible with IBM PC software. Uses same type 15 pin "D" subminiature I/O connector as the IBM Game Control Adaptor.

Maynard Electronics Multi-Function Memory Expansion Board

Adds form 64K bytes to 256K bytes to your IBM-PC. Expandable with either 1 or 2 optional asynchronous serial (RS232-C) ports. Engineered for total compatibility with IBM I/O specs. Parity generation and detection included. Ready to plug into 64K byte systems. Optionally available with 1 or 2 RS232-C ports with 20mA current loop. 100% compatible with IBM hardware and software, and may be used to connect your computer to a modem serial printer or other devices with computer interface. Board ports may be enabled or disabled and assigned as COM1 and/or COM2.

MMF 1000	0K	\$210.00
MMF 1064	64K	\$305.00
MMF 1128	128K	\$410.00
MMF 1192	192K	\$510.00
MMF 1256	256K	\$615.00
MMF1SER		\$100.00
(with one serial port added)		
MMF2SER		\$160.00
(with two serial ports added)		
(No parallel available)		

Maynard Disk Controllers

Description	RET.
MODFDC (Controller w/mod ports)	\$265
FDC8 (8" Controller)	\$245
FDC 5 1/4" (5 1/4" Controller)	\$195
FDCPARALLEL (Contr. and para ports)	\$275
FDCSERIAL (Contr. and serial ports)	\$285
FDC8 PARA (8" Contr. and para ports)	\$315
HDM (hard disk module)	\$495

CONTROLLERS Magnolia Micro-systems for the H-89 & Z-90 Double Density Disc controller including CP/M 2.2

Complete hardware & software support for:
- Four 5 1/4" and Four 8" single or double sided drives
- 48 TPI (40 track) drives
- 96 TPI (80 track) drives
- 3-5 1/4" drives supported by Heath Zenith controller H-17

This package includes:
- double density controller card
- CP/M 2.2 on either 5 1/4" or 8" media
- new I/O decoder and monitor PROMS
Shipping weight 7 lbs.

DATA CONNECTORS

50 pin edge card	609-5015	50 pin inline end connector	
34 pin edge card	609-3415	609-5001M	
50 pin inline chassis	609-5016	34 pin inline end connector	
34 pin inline chassis	609-3416	609-3401M	

POWER CONNECTORS

stacking bracket for 5 1/4" or 8" half-height drives	AC socket 8", single sided	
S85 or S88	5 1/4" DC connector	C1116
SA 810/860 DC power	5 1/4" DC socket	C1119
C1115	PCB-8" DC	C1122
SA 850/851 FDD-200-8-AC	free-standing 8" 8" double sided	C1124
8" AC connector standard.	C1114 DC connector socket	C1121
single sided	8" DC standard	C1112
	C1113	

We sell many other disk drive models too numerous to list here. We encourage you to call for our latest pricing and catalog. Due to production deadlines, prices are 60 days old. Please call Dealer inquiries invited. In our 5th year!

Prices and specifications subject to change without notice
MasterCard, VISA accepted. NJ residents, add 6% sales tax.
Shipping charges: \$3.00 first 4 lbs., \$4.00 each additional lb.
COD charge \$5.00.
TOLL FREE ORDER LINE: 800-223-0306
In NJ, Call: 609-799-4440 9:00 am-5:30 pm est.

FLOPPY DISK SERVICES INC.

FLOPPY DISK SERVICES, INC.
741 Alexander Road
Pricenton, NJ 08540

maxell®

Floppy Discs

CALL NOW - TOLL FREE

1-800-328-DISC

Dealer inquiries invited. C.O.D.'s and charge cards accepted.

All orders shipped from stock, within 24 hours. Call toll FREE.



North Hills Corporation

3564 Rolling View Dr.

White Bear Lake, MN 55110

1-800-328-DISC

MN Call Collect 1-612-770-0485

ZENITH/ Heath Users

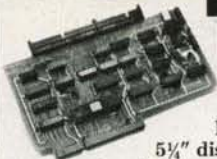

Double Your
5 1/4" disk storage
capacity without adding a drive.

Get twice as much from your H88 or H89 microcomputer. Our FDC-880H floppy disk controller, in conjunction with your 5 1/4" drives, for example, expands memory capacity from 256 bytes to 512 bytes per sector.

And it handles single and double-sided, single and double-density, 8" and 5 1/4" drives - simultaneously.



C.D.R. Systems Inc.

Controlled Data Recording Systems Inc.
7210 Clairmont Mesa Blvd., San Diego, CA 92111
(619) 560-1272

Circle 57 on inquiry card.



THE FULL-FEATURED KEYBOARD EXPANDER

Redefine any key to send a string of characters. MagiKey™ does more...

- * automates application software, integrates function or cursor keys
- * "help" menus displayed at any time
- * built-in batch processing more powerful than SUBMIT or XSUB
- * strings can redefine keys, pause for fill-the-blanks keyboard input, or contain nested key definitions
- * invisible to system and software
- * for any 8080-8085-Z80-CP/M 2.2, no system or software modifications

\$100

8" SSSD Kaypro 5 1/4" - inquire about other 5 1/4" formats
check VISA, MC add 6% tax in CA



16609 Sagewood Lane

Poway, California 92064

(619) 693-1022

CP/M (tm) Digital Research

Circle 295 on inquiry card.



flexible disks

Call Free (800)235-4137

for prices and information.
Dealer inquiries invited.
C.O.D. and charge cards
accepted.



VISA

PACIFIC EXCHANGES

100 Foothill Blvd

San Luis Obispo, CA

93401 (In Cal call

(805) 543-1037)

Circle 278 on inquiry card.

The Statistician

CPM IBM-PC
TRS-DOS XENIX

- * Multiple Regression Stepwise Ridge All Subsets Backward Elimination
- * Time Series Analysis
- * Descriptive Statistics
- * Transformations
- * Survey Research
- * Nonparametrics
- * XY Plots
- * ANOVA
- * Random Samples
- * Data Base
- * Search & sort
- * Hypothesis tests

Please call TOLL FREE

1-800-334-0854 (Ext. 814)



for more information

or write:

Quant Systems

Box 628

Charleston, SC 29402

VISA/MC Accepted

Circle 299 on inquiry card.

The INTELLIGENT GRAPHICS TERMINAL

All of this on a single S-100 board

- Full 512 color mapping palette
- TTL/analog RGB color or 8 level grey
- 680x480 4 color and/or 340x480 16 color
- Transparencies, overlays, multiple pages
- 8086, EPROM, 128K RAM expandable on-card
- Full editing terminal/graphics firmware
- Text throughput is greater than 2000 cps
- 10 windows, individually scrollable
- Programmable terminal formats to 113x40
- 64K x 64K virtual screen graphics with clipping and scale
- Drawn/filled circle, pie, arc, polygon
- Complex fill patterns and line styles

Low introductory prices: Assembled and tested \$895. Partial kit \$295.

Available soon: Fully integrated expansion card adds speech, sound effects, serial and parallel ports, and time-of-day clock.

Advanced Graphics Engineering
P.O. Box 3403, Reston, VA 22090
(703) 435-8110

Circle 15 on inquiry card.

Computer Software Associates, an established software house, supplies software for COMMODORE, APPLE, and IBM home computers. CSA is currently looking to expand its product base of serious programs in the areas of home, education, and office.

Computer Software Associates offers over 30 years of market experience, worldwide distribution, innovative packaging, generous royalties, and programmer support.

Interested programmers should contact Mike Mahan, Product Development Department, Computer Software Associates, 50 Teed Drive, Randolph, Massachusetts 02368 Tel. (617) 961-5700.



Circle 97 on inquiry card.

APPLE II COMPATIBLE DISK DRIVES

Mitac AD-1 only \$189.00

Controller Card \$55.00

Just Plug in and Run

VERBATIM

5 1/4" Diskettes SS DD Soft

per box of 10 \$23.55

HARD DISKS FOR APPLE and IBM

Mitac AD-100 10 MB only \$1395.00

TELEVIDEO

910 \$429.00

925 \$659.00

950 \$859.00

MONITORS

Mitac 12" 20 MHZ

Green \$115.00

Amber \$115.00

IBM PC COMPATIBLE DISK DRIVES

National JA-551-2 1/2 HT \$205.00

OZtech, Inc. VISA/MC Accepted

1400 Coleman Ave. Suite E-25

Santa Clara, CA 95050

(800) 222-6677

in Calif. (408) 980-9987

Circle 23 on inquiry card.

COMPUTER INTERFACES



Convert your electronic typewriter to a letter-quality computer printer! Available for Olivetti Praxis 30,35, 40, & 41 and Adler/Royal 1005, 1010, 1011/5005, 5010, 5011.

- Centronics parallel or RS-232C serial
- Easily installs inside typewriter
- Compatible with most computers
- Cable assemblies available
- Prices start at only \$149.

Selectone

28301 Industrial Blvd.

Hayward, CA 94545

CALL TOLL FREE

800-227-0376

800-421-5389 (In CA)

Circle 320 on inquiry card.

WHO'D LET A 23-YEAR-OLD WORK WITH THE WORLD'S MOST SOPHISTICATED LASER SYSTEM?

Or evaluate primary sensor performances of multimillion dollar satellites?

Or manage millions of dollars a year in defense contracts?

The Air Force, that's who.

If you're a talented, motivated electrical engineer or plan to be, you don't have to wait to work with the newest, most sophisticated technology around.

You can do it now, as an Air Force officer working as an electrical engineer.

Don't get us wrong. We don't hand it to you on a silver platter. You have to work for it. Hard.

But if you do, we'll give you all the responsibility you can handle. And reward you well for taking it.

You'll get housing, medical and dental care — and excellent pay that increases as you rise in rank.

Plus there are opportunities to attend graduate

school. If you're qualified and selected, we'll pay 75% of your tuition. Those with special qualifications can even study full time, at no cost.

So plug into the Air Force. Because when it comes to technology, the Air Force can help you achieve great sophistication at a very tender age.

For more information mail in the card, or call toll-free 1-800-423-USAF (in California 1-800-232-USAF). Better yet, send your resume to HRS/RSAANE, Randolph AFB, TX 78150. There's no obligation.

AIM HIGH AIR FORCE

A great place for engineers

IBM PC 256K 2X 320 KB DS/DD DISK DRIVES FLOPPY DISK CONTROLLER

ALL FOR \$2599



*Call for prices on
System Configurations.*

**IBM PC256K COLOR GRAPHICS BOARD FLOPPY DRIVE CONTROLLER
WITH PARALLEL PORT 360KB DS/DD DISK DRIVE, PRINTER, CABLE
DOS 2.0, 10MB HARD DISK SUBSYSTEM INCLUDES CABLE,
CONTROLLER, POWER SUPPLY, CABINET, SOFTWARE**

DISK DRIVES FOR IBM PC

Double Sided/Double Density 320KB \$225

HARD DISK FOR IBM PC

5MB \$1399 10MB \$1599 15MB \$2199

MEMORY BOARDS

AST MULTIFUNCTION \$299

AST I/O PLUS \$199

QUADRAM 256K MULTIFUNCTION... \$399

HERCULES CARD \$499

QCS BIG BLUE CARD..... \$479

HAYES

SMARTMODEM 300 BAUD \$239

SMARTMODEM 1200 BAUD \$559

MONITORS

PGS COLOR MONITOR HX-12 \$499

AMDEK, NEC MONITORS AVAILABLE . CALL

APPLE IIe STARTER SYSTEM \$1599

DISK DRIVE FOR APPLE II & IIe ... \$219

PRINTERS

BROTHER HR-1 \$750 HR-15..... \$499

OKIDATA 82A. \$499 83A \$699

84A \$999 93A \$959

GEMINI 10 ... \$359 15 \$529

NEC 3510 .. \$1499 3550 \$1899

7710 \$2075

EPSON RX80 . \$379 FX80 \$599

MX80 \$449 MX100 \$649

HAYES SMARTMODEM 300 BAUD ... \$239

HAYES SMARTMODEM 1200 BAUD .. \$559

VISICALC ... \$199 MULTIPLAN .. \$199

LOTUS 1-2-3.. \$359 WORDSTAR .. \$329

SUPER CALC II \$199 MAILMERGE.. \$179

WORD PERFECT \$349 EASY WRITER \$129

TAVA PC

Desk Top, IBM PC Compatible Computer, Runs

DOS 1.1, 2.0, CP/M86 \$1025

COMPUTER POST INC.

22102 CLARENDON ST. STE. #1
WOODLAND HILLS, CA 91367
(213) 999-1041

CALL FOR FREE PRICE SHEET.

PRICES SUBJECT TO CHAGE WITHOUT NOTICE.
SHIPPING AND HANDLING EXTRA

SUPER PRICE SAVER

Apple 2E System	\$1450.
IBM PC System	2550.
Dynax	449.
Gemini 10X	269.
OkiData 92/93	449./829.
NEC 8023	399.
NEC 3550	1895.
Amdex 300/310	135./167.
PI 3	148.
Rana I	259.
Tandon TM 100-2	249.
Slim Dr. 5 1/4 Apple/IBM	198.
Videx 80 col.	149.
Anchor Mark XII 300-1200	289.
Hayes 1200/1200B	479./489.
Koala IIe	79.
Wesper IPI/BPO	69./159.
Quadram 64K	269.
Software 30% OFF	CALL

Computer Price Club

16783 Beach Blvd., Huntington Beach, CA 92647



714-841-6160



Circle 96 on inquiry card.

TeleVideo DEALERS

- Fast Dump/Restore over 800K per disk \$60
 - Type Ahead with Print Screen 64 Character Type Ahead Buffer \$60
 - 3270 & 2780/3780 Bisynd Communications from Phone 1 & Batach \$700 & \$300
 - TurboDOS for TeleVideo Start at \$225
 - BIOS & Formatting for 802H use all 20 MB \$150
 - 8" Disk Drive for 802 Computer Drive & Software \$1,100
 - RM Cobol™ for TurboDOS Full System \$525 Run Time \$175
 - Standby Power System 200VA-400VA-800VA As low as \$363
- RM/COBOL is a registered trademark of Ryan-McFarland Corp.
CP/M is registered trademark of Digital Research, Inc.
TurboDOS is a registered trademark of Software 2000, Inc.

PLUS OTHER GOOD TELEVIDEO STUFF!

COGITATE, Inc.

SPECIALISTS IN UNIQUE TELEVIDEO SOFTWARE
24000 Telegraph Road, Southfield, MI 48034
(313) 352-2345

VISA/MASTER CARD Accepted

Circle 65 on inquiry card.

AFFORDABLE & RELIABLE

EPROM PROGRAMMERS & UV ERASERS

See our ad on Page 80

LOGICAL DEVICES, INC

Circle 224 on inquiry card.



Scotch DISKETTES

Call Toll-Free

1-800-328-DISC for prices and information. Dealer inquiries invited. C.O.D. and charge cards accepted.

All orders shipped from stock, within 24 hours. Call toll FREE



North Hills Corporation

3564 Rolling View Dr.
White Bear Lake, MN 55110
1-800-328-DISC

MN Call Collect 1-612-770-0485

CONVERSE WITH YOUR COMPUTER

AT LAST! A FULL IMPLEMENTATION of the original ELIZA program is now available to run on your microcomputer!

Created at MIT in 1966, ELIZA has become the world's most celebrated artificial intelligence demonstration program. ELIZA is a non-directive psychotherapist who analyzes each statement as you type it in and then responds with her own comment or question—and her remarks are often amazingly appropriate!

Designed to run on a large mainframe, ELIZA has never before been available to personal computer users except in greatly stripped down versions lacking the sophistication which made the original program so fascinating.

Now, our new microcomputer version possessing the FULL power and range of expression of the original is being offered at the introductory price of only \$25. And if you want to find out how she does it for teach her to do more, we will include the complete SOURCE PROGRAM for only \$25 additional!

Order your copy of ELIZA today and you'll never again wonder how to respond when you hear someone say, "Okay, let's see what this computer of yours can actually do!"

ELIZA IS AVAILABLE IN THE FOLLOWING FORMATS:

1. 5 1/4 inch disk for the 48K Apple II, II Plus, IIe or III \$25 for Protected Version—\$45 for Applesoft Source Version
2. 5 1/4 inch disk for the 64K IBM Personal Computer \$25 for Protected Version—\$45 for IBM Disk BASIC Source Version
3. 5 1/4 inch disk or tape cassette for the Commodore 64 (specify which) \$25 for Protected Version—\$45 for C-64 BASIC Source Version
4. Standard 8 inch single density disk for all CP/M based computers \$25 for ELIZA.COM—\$45 with Microsoft BASIC-80 Source
5. 5 1/4 inch disk for most CP/M based computers (specify computer) \$25 for ELIZA.COM—\$45 with Microsoft BASIC-80 Source

Please add \$2.00 shipping and handling to all orders (California residents please add 6% sales tax)

ARTIFICIAL INTELLIGENCE RESEARCH GROUP

921 North La Jolla Avenue, Dept. B
Los Angeles, CA 90046
(213) 656-7368 (213) 654-2214
MC, VISA and checks accepted



Circle 32 on inquiry card.

IBM PC COMPATIBLE

Slimline Disk Drive \$215.00 ea.

(Shugart SA 455. DS/DD 320KB)

Slimline Hard Disk \$495.00 ea.

(Shugart SA 706 5MB)

Computer Case Call

Keyboard Call

Power Supply Call

Disk Controller Card Call

Color Graphic/Monochrome/Printer Interface Card Call

Compatible Bare PCB Call

3M Diskette SS/DD \$20/box

3M Diskette DS/DD \$28/box

Dealer Inquiries Welcome

ELECTRADE CO. (408) 946-2541

780 Trimble Rd., Suite 605

San Jose, CA 95131

Circle 149 on inquiry card.

Electronic Circuit Analysis

- AC and DC analysis
- Very fast, optimized machine language
- Worst case, sensitivity analysis
- Sweep component values
- 64 Nodes
- Compare circuits
- Log or linear sweep
- Full file handling
- Full editing, error trapping
- Frequency response, magnitude and phase
- Complete manual with examples
- Transmission lines
- Complex y parameters
- Available for CP/M, MSDOS, TRSDOS
- Price - \$150.00

Tatum Labs

P.O. Box 698

Sandy Hook, CT 06482

(203) 426-2184

Circle 347 on inquiry card.

HOOKING IN

1984 EDITION—THE UNDERGROUND COMPUTER BULLETIN BOARD WORKBOOK AND GUIDE

FIRST TIME BETWEEN TWO COVERS

No matter what type of computer you own, this book will get you on-line TODAY! Complete information on computer bulletin board systems including:

- What they are (and what's happening).
- Kinds of information available.
- Public domain systems.
- Free software (and how to get yours).
- Blitz course in telecomputing.
- Buyer's guide to modems.

Over 400 verified listings. Periodically Updated. On-line Logbook. Electronic Mail Address Book. \$14.95 P.P. Make checks payable to:

Computer Food Press
Div. of Coltrane & Beach
31754 Foxfield Dr.
Westlake Village, CA 91361



Voice Orders—(213) 838-7716 Modem Orders—(213) 558-9033

HOOK IN NOW!!

SPECIAL OFFICE

When ordering, refer to this AD and receive your FIRST UPDATE FREE!

Circle 91 on inquiry card.

"CONTROL YOUR WORLD" WITH YOUR VIC-20

With simple circuits using low cost parts and our program supplied on cassette tape, we'll show you how to use your COMMODORE VIC-20 for:

- Digital Thermometers ■ Digital Clock
- Burglar Alarm - 2 Zone, Time Controlled
- Fire Alarm - 2 Zone, Time Controlled
- Dusk to Dawn Lighting with Photo Cell
- Furnace and Air Cond., Clock and Thermostat
- Clock Controlled Appliance Switches

Simple program variations in basic can operate lights, motors, furnaces, machines, heat pumps, radios, sound systems, test equipment, swimming pools, garden watering, and more.

Your video screen will display simultaneously:
• Two Digital Temperatures • Digital Time • Two Analog Inputs • Five Input Ports Status • Eight Output Ports Status.

GET A LOW COST EDUCATION IN COMPUTER CONTROL. ORDER YOUR CASSETTE AND INSTRUCTION BOOK NOW! \$39.90 PRICE INCLUDES POSTAGE.

Terms: MASTER CARD/VISA

The Continental Press, Inc., Elizabethtown, PA 17022
Toll free: 800-233-0759 Collect in PA: (717) 367-1836

Circle 111 on inquiry card.

Lycy Computer Marketing & Consultants

TO ORDER
CALL US

TOLL FREE 800-233-8760
In PA 1-717-327-1824

PRINTER
INTERFACING

PRINTER PAPER
AVAILABLE

SAVE on these in-stock **PRINTERS**

Available for IBM PC, Apple, Atari, Vic 20 & Vic 64

EPSON

LETTER QUALITY

SMITH CORONATP2...\$449.00

DIABLO 630 ..\$1719.00

ALPHACOM 42\$89.00
ALPHACOM 81\$129.00
NEC 8023\$369.00
NEC 8025\$699.00
NEC PC-8200
COMPUTER\$CALL

MANNESMANN TALLY

SPIRIT 80\$CALL
MT 160L.....\$CALL

OKIDATA

80\$SAVES
82A\$CALL for
83A\$LOWEST
84\$PRICES
92on these
93In-Stock
PACEMARK 2350...PRINTERS

ATARI 850 REPLACEMENTS IN-STOCK

CITOH

GORILLA GX100\$179.00
PROWRITER 8510\$339.00
PROWRITER II\$659.00
8600\$1025.00
STARWRITER\$1099.00
PRINTMASTER\$1499.00

STAR MICRONICS

GEMINI 10X\$269.00
GEMINI 15X\$CALL
DELTA 10\$479.00

MODEMS

ANCHOR MARK I ..\$79.00
ANCHOR MARK II..\$79.00
HAYES SMART ...\$239.00
HAYES MICRO II \$309.00
Micro Bit
MPP-1000.....\$129.75
NOVATION
CAT\$144.00
D-CAT\$155.00
J-CAT\$115.00
APPLE CAT II ..\$279.00
212 APPLE CAT ..\$589.00

MONITORS

Sakata Color\$229.00
Amdek Color I\$275.00
Amdek 300 Green\$149.00
Amdek 300 Amber\$149.00
Gorilla Green\$99.00

HES 64

Sound Box\$9.95
64Forth\$55.75
Hesmon\$25.75
Turtle Graphics\$37.75
Heswriter\$28.75
Gridrunner\$19.75

DUST COVERS

800\$3.99
400\$3.99
1200\$3.99
410\$3.99
810\$3.99
1050\$5.99
PROWRITER\$5.99
GEMINI 10X.....\$5.99
PERCOM DISK\$5.99

SSI

Battle of Shilo\$26.75
Tigers in the Snow.....\$26.75
Cosmic Balance\$26.75



APPLE DUMPLING GX\$99.75
APPLE DUMPLING 64 (16 Buffer)\$179.75

INFOCOM

Zork I, II, or III\$26.75
Deadline\$33.75

CARDCO

Cardprinter / LO1.....\$499.00
Cardprint DM1\$109.00
5 Slot Expansion 64\$54.00
64 Write NOW.....\$39.00
64 Mail NOW\$29.00
2J Write NOW.....\$29.00
64 Keypad\$29.00
Universal Cass. Int.....\$29.75
Printer Utility\$19.75
6 Slot Expansion.....\$79.95
3 Slot Expansion.....\$24.95
PRINTER INTERFACE.....\$39.75
PRINTER INTERFACE with
full graphics\$65.75
LIGHT PEN\$29.75

SPINNAKER 64

Kindercomp\$21.75
Story Machine\$23.75
Face Maker\$23.75
Snooper Trooper.....\$29.75
Delta Drawing\$34.75
Shamus II c/d\$24.95
Pinhead c/d\$22.95

SYNAPSE 64

ZEPELIN C/D\$24.75
BLUE MAX C/D\$24.75
DIMENSION X C/D\$24.75
EPYX 64
ASPHI R\$28.75
JUMPAN JR R\$28.75
PIT STOP R\$28.75

commodore

BRODERBUND 64

BANK STREET
WRITER\$49.75
CHOPFLIFTER\$24.75
LODE RUNNER\$24.75
DROL\$24.75
KOALATOUCHTABLET...\$69.75

ATARI

Computers for people:

Voice Box 2 . \$99.75

600XL ... \$CALL
800XL for
1400XL... Lowest
1450 Prices
1050 DISK DRIVE ... \$SAVES
1010 RECORDER \$74.75

PARKER BROTHERS

Tutankham R.....\$33.75
Super Cobra R\$33.75
Astro Chase R.....\$33.75
Frogger R\$33.75
QBert R\$33.75
Popeye R\$33.75

Monkey Wrench 2 \$52.75

SPINNAKER

Story Machine R ..\$26.75
Face Maker R.....\$24.75
Kinderomp R\$20.75
Fraction Fever R ..\$24.75
Delta Drawing R...\$26.75

BLANK DISKETTES ELEPHANT

Single Side 5D (10).....\$17.75
Single Side DD (10).....\$21.75
Double Side DD (10).....\$26.75

MAXELL

MD I (10)\$28.75
MD II (10)\$38.75

CERTRON CASSETTES

CC-10 12 for\$15.99
CC-20 12 for\$17.99

INNOVATIVE CONCEPTS

Disk Storage (holds 10).....\$4.95
Disk Storage (holds 15).....\$9.95
Disk Storage (holds 50).....\$26.95

TRAK DISK DRIVES

AT-D1\$379.00
AT-D2\$399.00
PRINTER CABLE\$22.95
Software for ATD-2\$22.95

RANA DISK DRIVE

COMPUTER CARE

BIB
5 1/4 DISK DRIVE
CLEANER\$12.75
COMPUTER CARE
KIT\$19.75

HARD DISK DRIVES for

APPLE IBM-PC

5MEG\$1349.00
10MEG ...\$1599.00
15MEG ...\$1999.00
20MEG ...\$2359.00

*Add \$30.00 for TRS 80 Drives

TEXAS INSTRUMENT

Disk Drive...\$245.00

PERCOM

FOR ATARI COMPUTERS

AT88S1\$299.00
AT88S2\$535.00
AT**S1PD...\$439.00
RFD40S1...\$399.00
RFD40S2...\$675.00
RFD44S1...\$449.00
AT88 doubler



TO ORDER

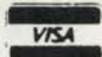

CALL TOLL FREE

800-233-8760

Customer Service 1-717-327-1825 Jersey Shore, PA 1774C

or send order to
Lycy Computer
P.O. Box 5088

POLICY

In-stock items shipped within 24 hours of order. Personal checks require four weeks clearance before shipping. No deposit on C.O.D. orders. Free shipping on prepaid cash orders within the continental U.S. PA residents add sales tax. All products subject to availability and price change. Advertised prices show 4% discount offered for cash, add 4% for MasterCard or Visa. DEALER INQUIRIES INVITED.

TYPED
of looking for reliable
Source of Supply?
RUN DOWN
from Looking???

NERVOUS
about
QUALITY??

**DISKETTES +
RIBBONS +
ACCESSORIES**



Call Bob Kelly Now...
Kelly Computer Supplies
1811 Carl St. • St. Paul, MN 55113
Toll Free . . . 800 - 447 - 2929
MN Res. Call Collect. . . 612/644-9030

MAXELL - DISKETTES

Circle 208 on inquiry card.

Verbatim flexible disks

Call Free (800) 235-4137 for
prices and information. Dealer
inquiries invited. C.O.D. and
charge cards accepted.

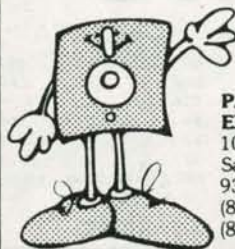

**PACIFIC
EXCHANGES**
100 Foothill Blvd.
San Luis Obispo, CA
93401. In Cal. call
(800) 592-5935 or
(805) 543-1037.

Circle 278 on inquiry card.

APPLE - PROM EPROM BURNER CARD



All menu-driven software is provided along
with a complete user's manual. All com-
mands are self-prompting, there are no per-
sonality modules required and all voltages
are on-board card.

BURNS EPROMS	FEATURES	
2708	2532 2732	*Auto erase verify
2716	2516 2764	*Auto burn verify
2732A	2564	*Partial burn capacity
		*Low insertion force socket

only **149⁹⁵**
Now Available APPLE - PROM Console Unit
Computer Technology Associates



New Products Division
1704 Moon, N.E.
Albuquerque, N.M. 87112
(505) 298-0942

Specifications subject to change without notice.
Apple is a registered trademark of Apple Computer, Inc.
VISA MC AE Accepted

Circle 102 on inquiry card.

Tektronix 40XX Terminal Emulation

**EMU-TEK™ IS NOW AVAILABLE FOR
IBM PC, XT, AND MOST COMPATIBLES**

- Access powerful mainframe graphics using:
 - PLOT 10 (trademark of TEKTRONIX, Inc.)
 - DISPLA (registered trademark of ISSCO)
 - DARC (available from QUESTEL, Inc.)
 - and most similar packages and services.
- Upgrade with complete software compatibility.
- Increase versatility with options such as:
 - High resolution board support
 - Local pen-plotter support
 - Hard copy on matrix printer
 - Advanced communications program features
 - Other terminal emulations, including:
 - VT100 (trademark Digital Equipment Corp.)
 - RETRO-GRAPHICS (trademark Digital Engineering, Inc.)

• **30 DAY NO-RISK TRIAL PRIVILEGE.**



10801 Dale St./P.O. Box 615
Stanton, CA 90680
DATA SYSTEMS (714) 995-3900

FTG will soon become PC INNOVATIONS

Circle 160 on inquiry card.

RIBBONS CARTRIDGES AND SPOOLS

PRICE PRICE
PER PER
RIBBON DOZEN

Anadex 9500	13.50	147.00
Commodore Pet 8023	7.00	81.00
C. Itoh Prowriter	5.95	68.40
C. Itoh Starwriter F-10	4.75	54.00
Data South DS-180	6.50	75.00
Epson MX-70/80	5.25	60.00
Epson MX-100	9.95	108.00
Epson MX-100 Reload	6.50	72.00
Gemini - 10	2.50	27.00
IDS Microprism - 480	6.00	69.00
IDS Paper Tiger 460/560	7.50	87.00
IDS Prism	8.00	93.00
Okidata - 80, 82 & 83	2.50	27.00
Okidata - 84	5.00	57.00

TO ORDER CALL (313) 569-3218 or
WRITE FOR OUR CATALOG

DWIGHT COMPANY, INC.
15565 NORTHLAND DRIVE
WEST TOWER SUITE 804
SOUTHFIELD, MICHIGAN 48075

Circle 139 on inquiry card.

(6502 & Z-80 dual processor) 64K COMPUTERS
(Apple compatible) in super modern styles. US\$420



- (Above prices exclude drives, monitor) & keyboard
 - Add 5% as shipping charge
 - (Detail brochure forwarded on request)
 - We also sell cases, keyboards, power supplies, motherboards, components separately and interfaces.
 - Full repair & guarantee available
 - Assembled in Canada with C.S.A. (Shipment from WA., U.S.A.)
- ABC COMPUTERS LTD.** (6 stores in B.C. Canada)
683 E. HASTING ST., VANCOUVER, B.C. CANADA V6A 2Z8
PH: (604) 254-2834 & 254-1062 Dealer inquiries welcome
Apple is a registered trademark of Apple Computer Inc.

Circle 8 on inquiry card.



**CORONA
\$2395**

- 2 Dr. 320K ea.
- 128K RAM
- software

Your choice of **DESKTOP** or **PORTABLE**

- NEC 8201A note book computer . . . \$677
 - IBM-PC 64K, 2 Drs, color graphics . . . \$2499
 - COLUMBIA 2 Drs, Kybd, software . . . \$2495
 - EAGLE-PC 2 Drs, Mon, 128K, software . . . \$2495
 - SANYO-550 IBM Compatible, 128K . . . \$899
 - FRANKLIN Ace 1200 OMS package . . . \$1699
 - FRANKLIN Ace 1000 Pro package . . . \$1199
 - SIGMA DESG 10MB expan chassis . . . \$1799
 - DATAMAC 10 MB Internal (IBM-PC) . . . \$1499
 - EPSON FX-100 the best of Epson . . . \$739
 - Delta 10 better than FX-80 . . . call
 - DYNAX DX-15 letter quality, 16 cps . . . \$429
 - SILVER REED EXP-550 20 cps, 16" wide . . . \$599
 - OKI 92 160 cps DP, 40 cps correspdn . . . \$475
 - OKI 84 200 cps DP, 50 cps correspdn . . . \$948
- Call for other items not listed—

MICROLAND 5223 Beechnut
Add 3% for MC/VISA Houston, TX 77096
COD 15% deposit (713) 668-4695
(ship same day order)

Circle 250 on inquiry card.



APPLE COMPATIBLE

Disk Drive	\$150.00 ea.
Controller Card	\$35.00 ea.
Computer Case	\$55.00 ea.
Keyboard	\$70.00 ea.
(Numeric and Function Keys)	
Switching Power Supply	\$49.50 ea.
Joystick (Heavy Duty)	\$17.50 ea.
Slim Fan	\$25.00 ea.

Prices for dealers in quantities of 25 or more.
End Users Inquiries welcomed.

ELECTRADE CO. (408) 946-2541
780 Trimble Rd. Suite 605
San Jose, CA 95131

Circle 150 on inquiry card.

PERIPHERALS FOR APPLE AND IBM(PC)

**ONE YEAR WARRANTY ON ALL ITEMS
ALL PRODUCTS BUILT IN U.S.A.**

	EACH	P.C.B.
APPLE/SHUGART DRIVE (5 1/4")	\$179	
DISK CONTROLLER (DOS 3.2-3.3)	59	\$ 19
80 COLUMN CARD (INDEX EQUIVALENT)	139	29
80 COLUMN WITH 64K RAM (FOR IIE ONLY)	129	28
GRAPHER PRINTER INTERFACE WITH 16K TO 64K BUFFER AND GRAPHICS	179	29
QUAD CARD (4 FUNCTIONS) (PARALLEL SERIAL, BSR, CLOCK) (PRINTER GRAPHICS ROM)	159	33
280 SOFTCARD (MICROSOFT EQUIVALENT)	99	29
IBM(PC) BARE MOTHER BOARD		175
GEMINI 10X	289	
SILVER REED 500	459	
5 1/4" FLOPPY DRIVE ENCLOSURE	17	

**COLORADO COMPUTER PERIPHERALS
THE P.C.B. COMPANY**
R.R. 6, BOX 7-D GOLDEN, CO 80403
(303) 278-7172

Circle 66 on inquiry card.

ORDER WITH CONFIDENCE

from one of the nation's largest
consumer electronic parts distributors!

DISK DRIVE

LOWEST PRICE EVER!

Slim disk drive for Apple II® computer. New in a box.



A sturdy cabinet and 3' cable are included. Runs on Apple controller or our optional controller.

ORDER NO. 83-APL-DD-1 **\$229.95**

CONTROLLER CARD

For two disk drives.

ORDER NO. 83-APL-CTL-1 **\$49.95**

IBM COMPATIBLE JOYSTICK

Heavy duty all metal. Featuring ultra linear pots, self centering, dual fine center adjustments. The finest industrial/commercial joystick available.



ORDER NO. 83-IB-XY-23 **\$44.95**

APPLE® COMPATIBLE JOYSTICK

With double trigger feature. (Four total) light weight, linear pots.

ORDER NO. 83-APL-XY-9 **\$24.95**

SELF CENTERING APPLE® COMPATIBLE JOYSTICK

With double trigger feature. (Four total) light weight, linear pots.

ORDER NO. 83-APL-XY-18 **\$29.95**

5 1/4" DISK DRIVE SPECIAL

MPI MODEL B-51

single side, double density BRAND NEW Never used, no cabinet.

ORDER NO. 83-MPI-B51 **\$149.00**

REPLACEMENT KEYBOARD FOR APPLE II™



Heavy duty — error free switches. Switchable N key rollover, last key repeat. Upper/lower case capability. Alpha lock, cable included.

ORDER NO. 83-APL-KB-7 **\$79.95**

APPLE® COMPATIBLE JOYSTICK

Cord terminated with 16 Pin plug. Our most popular joystick.

ORDER NO. 83-APL-XY-10 **\$16.50**

RF MODULATORS



Use your TV as a monitor. Converts video signals into RF. Hooks up to Apple with no modifications. FCC listed. Two versions: With sound and without sound.

ORDER NO. 83-VM-42 Without Sound **\$16.00**

ORDER NO. 83-CRM-320 With Sound **\$21.95**

5A APPLE II® COMPATIBLE REPLACEMENT POWER SUPPLY



Full 2A more than the original power supply. Heavy duty. 110/220V operation. Mounts directly into Apple II case. AC cord included.

ORDER NO. 83-APL-PS-51 **\$79.95**

5A POWER SUPPLY With BUILT-IN COOLING FAN

NEW!



Newly patented Apple II® compatible 5A power supply. Fits completely into Apple II case. Eliminates the need for external cooling fan.

ORDER NO. 83-APL-PS-53 **\$89.95**

DATA SPEC™ SUPER CABLES

Fully shielded — shock proof — low loss. 25 Conductor RS232 cable assembly with 100% alluminum shield. Special underhood molding and shielding. The best cables currently made!

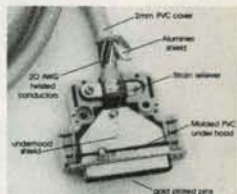

ORDER NO.	LENGTH	PLUG/JACK	PRICE
83-MRS232MM-3	3'	Male/Male	\$24.95
83-MRS232MM-5	5'	Male/Male	27.95
83-MRS232MM-10	10'	Male/Male	29.95
83-MRS232MM-25	25'	Male/Male	37.95
83-MRS232MF-3	3'	Male/Female	25.95
83-MRS232MF-5	5'	Male/Female	28.95
83-MRS232MF-10	10'	Male/Female	30.95
83-MRS232MF-25	25'	Male/Female	38.95

SOLDER TYPE 25 PIN "D" (RS232) CONNECTOR



ORDER NO.	Solder Type	1-11	12-49
83-DB25M	Male	\$2.25	\$2.00
83-DB25F	Female	2.90	2.60
83-DH25H	Hood with hardware	1.30	1.20

RF CABLES



RCA to RCA. Connects computer to monitor, etc.

ORDER NO.	LENGTH	PRICE
83-BRR-3	3'	\$1.95
83-BRR-6	6'	2.50
83-BRR-12	12'	4.50

Please Note: ORA Electronics products are intended to be sold to persons with a working knowledge of electronics and computing. If you do not have such knowledge, please visit your local dealer for products and information.



MINIMUM ORDER \$25.00. VISA, MASTER CARD accepted. No surcharges. Exact UPS charges will be added. PREPAID: Certified checks and money orders, send exact amount. No shipping, handling or insurance charges in the continental USA. PERSONAL CHECKS: add 5% shipping charges, allow 3 weeks to clear. INTERNATIONAL BUYERS: US currency and 20% extra for shipping. CA Residents, add sales tax.

OEM / DEALERS: send for special prices on your company letterhead.
NO PURCHASE ORDERS OR OPEN ACCOUNTS—NO EXCEPTIONS.



"OUR SERVICE MAKES THE DIFFERENCE"

To order, call TOLL FREE: **(800)423-5336**
Calif. TOLL FREE: **(800)382-3663**
Local: **(213)701-5848**
Telex 181011 ORA PARTS NTGE

18215 PARTHENIA STREET, NORTHRIDGE, CA 91325



FORMULA INTERNATIONAL INC.

12603 Crenshaw Blvd., Dept. B, Hawthorne, CA 90250

For information (213) 973-1921 • Orders Only (outside Calif.) (800) 672-8758



pinecom™

Pioneer of Low Cost Apple* Compatible Computer

No Copyright Infringements!

Compare These Features with Our Competitors:

- Powerful Utility Program (100% Apple Compatible)
- 68-Key Upper & Lower Case Keyboard with Numeric Keypad
- 25 Pre-programmed Function Keys
- 2 Speed Auto Repeat Function
- 64K User Memory—expandable to 192K
- 5A Switching Power Supply (110/220VAC)
- All ICs Are Socketed for Easy Service
- Nation-wide Dealer Network for Convenient Technical Support

And best of all, the price Assembled and Tested is just.....



Now with New Improved Keyboard and 64K RAM \$499⁰⁰

NEW



pinecom™ DP-64

- Dual Processor (6502 and Z80A)
- Detached Keyboard
- 64K RAM Expandable to 192K
- 25 Function Key Keyboard
- Auto Repeat Keys w/Upper/lower Case
- 2 Slim Disk Drives (optional)
- 100% Apple II Compatible
- 40/80 Column Display (optional)
- Runs Both Apple Soft and CP/M Software

Model DP-64 Fully Assembled ... \$625⁰⁰

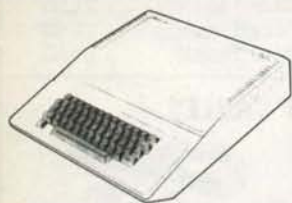

AP-II COMPUTER A&T

Apple Look Alike
48K User Memory
Supports Upper & Lower Case
100% Apple II* Compatible

\$445⁰⁰

AP-II MOTHERBOARD

Apple II+* Compatible
48K Memory Space
8 Expansion Slots

Bare Board..... \$69.95 ea.
Assembled & Tested \$295.00 ea.

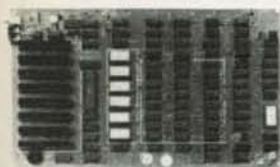

MICRO-II COMPUTER

100% Apple Compatible • No Copyright Problems!

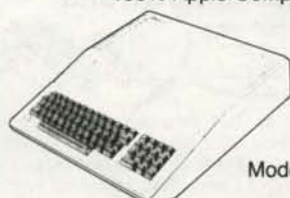

Model I 48K RAM \$475⁰⁰

Model II 64K RAM \$499⁰⁰

Model III 64K RAM w/Dual CPU... \$545⁰⁰
(6502 for Applesoft & Z80A for CP/M)

All above models are standard with Numeric Keypad, Function Keys, Auto Repeat Keys, Upper/lower Case Function, Fully Assembled and Tested.

PERIPHERALS

- Autoterm 80-Col. w/Softswitch \$99.95
- 80-Column Card 99.95
- 80-Column for Apple II* 49.95
- Z80 CP/M Card (no software) 99.95
- 16K RAM Card 49.95
- Parallel Printer Interface 85.00
- Buffer for Printer Interface (16-64K) 85.00
- Serial Printer Interface Card w/Adj. Baud 85.00
- Disk Controller 65.00
- Disk Controller DOS 3.2/3.3 Auto Select. 75.00
- EPROM Writer Card (2716/2732/2764) ... 75.00

★ SEND ★ ONE DOLLAR FOR OUR DETAILED CATALOG



PRINTER by BMC

Parallel Interface (Centronics Compatible) Standard
Microprocessor Electronics
80cps Bidirectional with Logic Seeking
96 Character ASCII
Adjustable Sprocket and Friction Feed

Model BX-80 \$265⁰⁰

SEND ONE DOLLAR FOR OUR DETAIL CATALOG

Shipping & Handling Charges	
Under \$50.00 Purchase	Over \$50.00 Purchase
10%	5%
15%	10%
25%	20%

Minimum Order \$10.00/Calif. Residents add 6.5% Sales Tax. Phone Orders Accepted on VISA or MC ONLY. NO C.O.D.'s. Prices subject to change without notice.



STORE HOURS
MON-FRI—10-7
SAT—10-6

Inside California
Outside Calif. (incl. Mexico & Canada)
Overseas

Dealer Inquiries, Circle 165. All others, Circle 166.

*Apple and Apple II are the trademark of APPLE COMPUTERS, INC.

DIGITAL RESEARCH COMPUTERS

(214) 271-3538

32K S-100 EPROM CARD PRICE CUT!

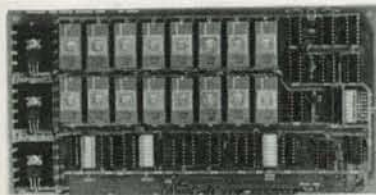

\$59.95

USES 2716's
Blank PC Board - \$34
ASSEMBLED & TESTED
ADD \$30

SPECIAL: 2716 EPROM's (450 NS) Are \$4.95 Ea. With Above Kit.

KIT FEATURES:

1. Uses +5V only 2716 (2Kx8) EPROM's
2. Allows up to 32K of software on line!
3. IEEE S-100 Compatible.
4. Addressable as two independent 16K blocks.
5. Cromemco extended or Northstar bank select.
6. On board wait state circuitry if needed.
7. Any or all EPROM locations can be disabled.
8. Double sided PC board, solder-masked, silk-screened.
9. Gold plated contact fingers.
10. Unselected EPROM's automatically powered down for low power.
11. Fully buffered and bypassed.
12. Easy and quick to assemble.

256K S-100 SOLID STATE DISK SIMULATOR! WE CALL THIS BOARD THE "LIGHT-SPEED-100" BECAUSE IT OFFERS AN ASTOUNDING INCREASE IN YOUR COMPUTER'S PERFORMANCE WHEN COMPARED TO A MECHANICAL FLOPPY DISK DRIVE.

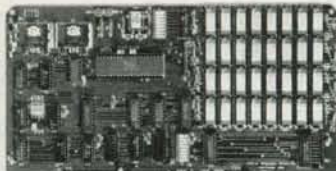

BLANK PCB
(WITH CP/M* 2.2
PATCHES AND INSTALL
PROGRAM ON DISKETTE)

\$69.95

FEATURES:

- * 256K on board, using + 5V 64K DRAMS.
- * Uses new Intel 8203-1 LSI Memory Controller.
- * Requires only 4 Dip Switch Selectable I/O Ports.
- * Runs on 8080 or Z80 S100 machines.
- * Up to 8 LS-100 boards can be run together for 2 Meg. of On Line Solid State Disk Storage.
- * Provisions for Battery back-up.
- * Software to mate the LS-100 to your CP/M* 2.2 DOS is supplied.
- * The LS-100 provides an increase in speed of up to 7 to 10 times on Disk Intensive Software.
- * Compare our price! You could pay up to 3 times as much for similar boards.

\$399.00

#LS-100 (FULL 256K KIT)

THE NEW ZRT-80 CRT TERMINAL BOARD!

A LOW COST Z-80 BASED SINGLE BOARD THAT ONLY NEEDS AN ASCII KEYBOARD, POWER SUPPLY, AND VIDEO MONITOR TO MAKE A COMPLETE CRT TERMINAL. USE AS A COMPUTER CONSOLE, OR WITH A MODEM FOR USE WITH ANY OF THE PHONE-LINE COMPUTER SERVICES.

FEATURES:

- * Uses a Z80A and 6845 CRT Controller for powerful video capabilities.
- * RS232 at 16 BAUD Rates from 75 to 19,200.
- * 24 x 80 standard format (60 Hz).
- * Optional formats from 24 x 80 (50 Hz) to 64 lines x 96 characters (60 Hz).
- * Higher density formats require up to 3 additional 2K x 8 6116 RAMS.
- * Uses N.S. INS 8250 BAUD Rate Gen. and USART combo IC.
- * 3 Terminal Emulation Modes which are Dip Switch selectable. These include the LSI-ADM3A, the Heath H-19, and the Beehive.
- * Composite or Split Video.
- * Any polarity of video or sync.
- * Inverse Video Capability.
- * Small Size: 6.5 x 9 inches.
- * Upper & lower case with descenders.
- * 7 x 9 Character Matrix.
- * Requires Par. ASCII keyboard.

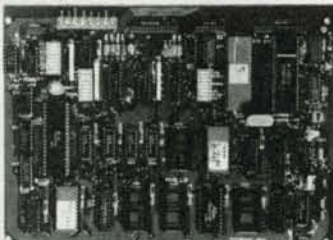

BLANK PCB WITH 2716
CHAR. ROM, 2732 MON. ROM

\$59.95

SOURCE DISKETTE - ADD \$10

SET OF 2 CRYSTALS - ADD \$7.50

WITH 8 IN.
SOURCE DISK!
(CP/M COMPATIBLE)

\$129.95

ZRT-80 (COMPLETE KIT,
2K VIDEO RAM)

64K S100 STATIC RAM

\$199.00
KIT

NEW!

LOW POWER!
RAM OR EPROM!

BLANK PC BOARD
WITH DOCUMENTATION
\$55

SUPPORT ICs + CAPS
\$17.50

FULL SOCKET SET
\$14.50

FULLY SUPPORTS THE
NEW IEEE 696 S100
STANDARD
(AS PROPOSED)

FOR 56K KIT \$185

ASSEMBLED AND
TESTED ADD \$50



FEATURES:

- * Uses new 2K x 8 (TMM 2016 or HM 6116) RAM's.
- * Fully supports IEEE 696 24 BIT Extended Addressing.
- * 64K draws only approximately 500 MA.
- * 200 NS RAMs are standard. (TOSHIBA makes TMM 2016s as fast as 100 NS. FOR YOUR HIGH SPEED APPLICATIONS.)
- * SUPPORTS PHANTOM (BOTH LOWER 32K AND ENTIRE BOARD).
- * 2716 EPROM's may be installed in any of top 48K blocks (within any 64K block) for maximum flexibility.
- * Any of the top 8K (E000 H AND ABOVE) may be disabled to provide windows to eliminate any possible conflicts with your system monitor, disk controller, etc.
- * Perfect for small systems since BOTH RAM and EPROM may co-exist on the same board.
- * BOARD may be partially populated as 56K.

64K SS-50 STATIC RAM

\$179.00
(48K KIT)

NEW!

LOW POWER!
RAM OR EPROM!

BLANK PC BOARD
WITH
DOCUMENTATION
\$52

SUPPORT ICs + CAPS
\$18.00

FULL SOCKET SET
\$15.00

56K Kit \$219

64K Kit \$249

ASSEMBLED AND
TESTED ADD \$50

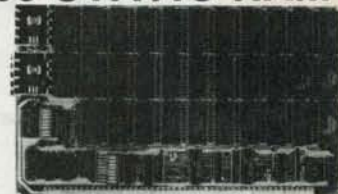

FEATURES:

- * Uses new 2K x 8 (TMM 2016 or HM 6116) RAM's.
- * Fully supports Extended Addressing.
- * 64K draws only approximately 500 MA.
- * 200 NS RAMs are standard. (TOSHIBA makes TMM 2016s as fast as 100 NS. FOR YOUR HIGH SPEED APPLICATIONS.)
- * Board is configured as 3-16K blocks and 8-2K blocks (within any 64K block) for maximum flexibility.
- * 2716 EPROM's may be installed anywhere on Board.
- * Top 16K may be disabled in 2K blocks to avoid any I/O conflicts.
- * One Board supports both RAM and EPROM.
- * RAM supports 2MHZ operation at no extra charge!
- * Board may be partially populated in 16K increments.

32K S100 EPROM/STATIC RAM

NEW!

FOUR FUNCTION BOARD!

NEW!

EPROM II
FULL
EPROM KIT
\$80.00

A&T EPROM
ADD \$35.00



BLANK
PC BOARD
WITH DATA
\$39.95

SUPPORT
ICs +
PLUS CAPS
\$23.00

FULL
SOCKET SET
\$18

We took our very popular 32K S100 EPROM Card and added additional logic to create a more versatile EPROM/RAM Board.

FEATURES:

- * This one board can be used in any one of four ways:
 - A. As a 32K 2716 EPROM Board
 - B. As a 32K 2732 EPROM Board (Using Every Other Socket)
 - C. As a mixed 32K 2716 EPROM/2K x 8 RAM Board
 - D. As a 32K Static RAM Board
- * Uses New 2K x 8 (TMM2016 or HM6116) RAM's
- * Fully Supports IEEE 696 Bus Standard (As Proposed)
- * Supports 24 Bit Extended Addressing
- * 200 NS (FAST!) RAM's are standard on the RAM Kit
- * Supports both Cromemco and North Star Bank Select
- * Supports Phantom
- * On Board wait State Generator
- * Every 2K Block may be disabled
- * Addressed as two separate 16K Blocks on any 64K Boundary
- * Perfect for MP/M* Systems
- * RAM Kit is very low power (300 MA typical)

32K STATIC RAM KIT — \$129.95

For RAM Kit A&T - Add \$40

Digital Research Computers

P.O. BOX 461565 • GARLAND, TEXAS 75046 • (214) 271-3538

TERMS: Add \$3.00 postage. We pay balance. Orders under \$15 add 7.5% handling. No C.O.D. We accept Visa and MasterCard. Tex Res. add 8.25% Tax. Foreign orders (except Canada) add 20% P & H. Orders over \$50, add 85¢ for insurance.

ALL SALES ARE MADE SUBJECT TO THE TERMS OF OUR 90 DAY LIMITED WARRANTY. A COPY OF THIS WARRANTY IS AVAILABLE FREE, ON REQUEST.

MICROMAIL™



IBM PC-COMPLETE SYSTEM VERY SPECIAL PRICE

64K, Two 320KB Disk Drives, Floppy Disk Controller,
Video Card and High Res Monitor **\$2590**

TAVA PC

Desk Top IBM PC® Compatible Computer, 128K
RAM, Two 320KB Disk Drives, Floppy Disk Con-
troller, Video Adapter and Monitor, One Parallel
Port, Two Serial Ports. System runs DOS 1.1, 2.0,
and CP/M86® **\$1995**

CORONA

Desk Top Computer **\$2395**

SLIMLINE DISK DRIVE FOR IBM PC

DS/DD 320KB By TAVA CORP **\$190**

DISK DRIVES FOR IBM PC

Tandon 100-2 **\$240**

ADD-ON Disk Drive for IBM PCjr® **CALL**

MONITORS

AMDEK

300A	\$190.00	I	\$340.00
300G	\$160.00	II	\$690.00
310A	\$190.00	III	\$390.00
IV			\$1190.00

PRINCETON GRAPHICS SYSTEMS

Hi-Res Color **\$490**

PRINTERS

DAISYWRITER 2000 **CALL**

OKIDATA

82A	\$440	84A	\$975
83A	\$690	92A	\$575
93A			\$970

BROTHER

HR-1	\$750
DX-15	\$490

NEC SPINWRITER

7710-1	\$2050	3510	\$1450
7715-1	\$2200	3515	\$1450
7720-1	\$2500	3530	\$1650
7725-1	\$2500	3550	\$1950
7730-1	\$2050	PC8023A	\$550

HARD DISKS FOR IBM PC®

10 MB Hard Disk Sub-System by TAVA CORP.
includes Software, Cables, etc. Internal. **\$1295**

MEMORY BOARDS

AST

IO Plus. Five function Card **\$199**

Combo Plus. 4 function card. Fully pop. 256K **\$450**

Mega Plus. Fully pop. 512K **\$890**

AST SIXPAK 384K **CALL**

QUADRAM

Quad Card. Fully pop. 256K **\$450**

QUADLINK **CALL**

CONOGRAPHIC

High Res. Color Graphics Card **\$995**

BIG BLUE **\$470**

HERCULES Graphics Card **\$490**

MAYNARD SANDSTAR SERIES

FDC 5 1/4 & 8" **\$220**

Multifunction Card **\$90**

Memory Card **\$180**

DISK DRIVE FOR APPLE

Slimline, or Standard **\$190**

APPLE IIe

Computer System, Controller, Two Disk Drives,
Monitor **\$1590**

MICROMAIL

631 E. First St., Tustin, CA 92680

PRICES AND AVAILABILITY SUBJECT TO CHANGE WITHOUT NOTICE

(714) 838-9100

APPLE is a trademark of Apple Computers, Inc.
IBM is a trademark of IBM Corp.
CP/M86 is a trademark of Digital Research, Inc.

We Offer You More!

That's right. If you compare the benefits of ordering from National Computer to all our competitors, you'll see why more smart shoppers buy from us everyday. We save you money even before you order with our toll-free 800 line, and then if you find a lower advertised price we'll try to meet it. Since we stock what we advertise you can rest assured your order will be shipped promptly. In addition, if for any reason you are not satisfied with any hardware you purchase from National Computer you may return it for exactly what you want or a full refund. Check us out! We've been in business for over 4 years, and one glance at our catalog will demonstrate the commitment we have to direct marketing and to our fine customers.

HOURS:
MONDAY-FRIDAY
7:30 AM-6:00 PM P.S.T.
SATURDAY
9:00 AM-3:00 PM



VIDEO MONITORS

AMDEK 300 12" Hi-res green	145.00
AMDEK 300A 12" Amber	159.95
AMDEK Color II Plus 13" Color	329.95
AMDEK Color II Hi-res RGB	439.95
AMDEK 310G Green	179.95
AMDEK 310A Amber	179.95
COMREX 5600 12" hi-res amber	169.95
NEC 1201M 12" Hi-res green	159.95
Princeton PGS HX-12	499.95
TAXAN Vision 12" md/rgb	329.95
RGB	329.95
TAXAN 12" hi-res amber	149.95
ZENITH 12" hi-res green	110.95



POPULAR SOFTWARE

WordStar by MicroPro	269.95
Random House Thesaurus	129.95
MailMerge by MicroPro	169.95
SuperSort by MicroPro	169.95
SpellStar by MicroPro	169.95
dBase III/MS-DOS or CP/M86	429.95
PC Tutor by Comprehensive	69.95
Home Accountant Plus	115.95
Crosstalk by MicroStuf	129.95
Peachtree GLA/RAP 4 pak	389.95
SuperCalc by Sorcim	139.95
VolkaWriter by Lifetree	139.95
Microsoft MultiPlan	179.95
Microsoft Flight Simulator	39.95
VisiCalc	169.95
VisiFile	219.95
VisiTrend/Plot	219.95
VisiSchedule	219.95
VisiWord (req. 128K)	299.95



IBM Personal Computer
Includes 64K, 2 DS/DD 320K drives, keyboard, color video card and MS-DOS.
PLEASE CALL FOR SYSTEM PRICES



PC MOUSE
For use with IBM, Radio Shack, Apple, etc. System includes Mouse Systems M-1 optical mouse w/par & RS-232 interface.
\$249.95

MICROSOFT MOUSE AVAILABLE
PLEASE CALL FOR PRICE



BIG BLUE Z-80 CARD
Z 80 with 64K parallel & serial bus hard disk interface & clock BYAD DS1 Z 80 card with software.
459.95
519.95



KOALA TOUCH TABLET
A new dimension in computer control with the touch of a finger.
Special price 109.95



MISCELLANEOUS

1 to MIT Light Pen	139.95
1 IBM 1 Joystick	59.95
1 KHAI 1 Joystick	49.95
Micro of color System Equi Tablet	479.95



SWEET-P PLOTTER
Simple to operate plotter with 4 easily interfaces to the PC using a centronics parallel port. Complete with software, set of pens, paper and operators manual. List Price \$795.00.
Special Offer 529.95



EPSON FX-80
EPSON RX-80
Call for Special Price
EPSON FX 100
STAR GEMINI 10X & 15X
1170i PRCWRITERS I & II
NEC 8023A
JOSHUA P 1350
IBM PRISM 132 W/COLOR
Please Call for BEST PRICE and Availability



OKIDATA ML92
100+ ps 10 carriage, 80 columns
\$469.95
Only
Tractor for MI 92 59.95
OKIDATA A 91 759.95
OKIDATA A 92A with tractor 389.95
OKIDATA A 81A 595.95
OKIDATA A 84 (jet) with tractor 969.95



TRANSTAR 315 COLOR PRINTER
Prints 2 colors plus more than 80 shades, all in a single pass of the printing head. Available in both 1/2 and 1/4 size.
Only \$549.95



LETTER QUALITY PRINTERS

CECILE 10 Starwriter 40 ps	1149.95
CECILE 10 Printmaster 55 ps	1649.95
They write 40 cps w/48K buffer	1079
NEC 3510 11 cps HS 242 serial	CALL
NEC 3530 33 cps parallel	CALL
IBM 6100 18 cps	CALL
RECHIFFER 117NAX 11R 1 and 11R 15	CALL
TRANSSTAR 120 & 130	CALL
QUME SPRINT 11 PLUS	CALL



NEC 3550 Sprinwriter for IBM PC
Only \$1889.95



QUADRAM QUADBOARD
256K only \$399.95
64K 289.95 128K 349.95 192K 639.95
512 QUADBOARD
64K 289.95 256K 349.95 512K 639.95
Coming soon! New direct connect modem



AST MEGAPLUS
64K with serial & clock 339.95
128K 399.95 192K 449.95 256K 499.95
67K with parallel & serial 379.95
128K 439.95 192K 489.95 256K 549.95
MegaPak option (256K) for 512K total 329.95



IO PLUS
Serial, parallel, clock and game adapter port
225.00



Apparit, Inc. COMBOARD II
Serial port, parallel port, clock and game port all on one card
Only \$169.95
1/2" 2.5" for combo card 29.00



HI RES COLOR GRAPHICS CARD
Includes draftsman utility software
PLEASE CALL FOR BEST PRICE



DISK DRIVES FOR IBM PC

Tandon TM 100 2 DS/DD	249.95
Tandon 5 1/4" Half Heights	CALL
Daving 5 mb	CALL
Daving 10 mb	CALL
Daving 15 mb	PRICES



COLUMBIA MPC
IBM PC Compatible System
Includes 128K, two DS/DD 320K drives, 2 RS-232 serial ports, centronics parallel printer ports, 8 IBM compatible expansion card slots, video monochrome/color/graphics card, and IBM type keyboard. Included with system is MS-DOS, CP/M 86, BASICA (w/color graphics, asynchronous communications support, macro assembler) Perfect Writer, Perfect Speller, Perfect Calc, Perfect Filter, Columbia Tutor, diagnostics and HOT Line Support.
Please call for price.
Available with Winchester Disk.



COLUMBIA VP PORTABLE
Featuring IBM-PC and COMPAQ compatibility teamed with the most comprehensive software package in the industry to deliver all the functions you need. Includes 128K RAM, expandable to 256K, 2.5 1/4" half-high floppy disk drives with 320K DS/DD 5 1/4" green screens, 80x25 characters. Full IBM compatible keyboard. The unit only weighs 32 lbs.
PLEASE CALL FOR MORE DETAILS.



Inexpensive IBM PC Compatible
The new SANYO MBC 550 is a 16 bit IBM PC work a like that will run all software currently available IBM PC software. Features include:
• 8088 CPU • 128K RAM memory • 160K Floppy disk storage • Color graphics centronics printer port • Sanyo BASIC • Utilities • Speaker • Joystick port • MS-DOS • Word Processing and Spread Sheet Software all included.
All this for less than \$1000
Call for more information and prices on other configurations.



MICROFAZERS by Quadram
PRINT BUFFERS
Please call for prices on the configuration of your choice.

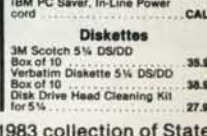

PROTECT YOUR COMPUTER

Lemon 6 out surge prot.	49.95
Line w/power switch & 6" cord	79.95
Orange w/EMI-RFI filter	115.00
Plum 3 out EMI-RFI AC filter	44.50
IBM PC Saver, In-Line Power cord	CALL

Diskettes

3M Scotch 5 1/4 DS/DD	35.95
Box of 10 Verbatim Diskette 5 1/4 DS/DD	35.95
Box of 10 Disk Drive Cleaning Kit for 5 1/4"	27.95



KAYPRO
The anytime-anywhere computer. Includes CP/M, CBASIC, a spreadsheet and wordprocessing software.
PLEASE CALL FOR MORE DETAILS.



EAGLE COMPUTER
EAGLE PC-2 IBM Compatible
Includes 128K, two DS/DD 320K drives, color card, keyboard, monitor, two serial ports, one parallel port. Eagle Writer, Eagle Calc, MS-DOS and CP/M 86. Other Eagle configurations available.
Call for pricing



PRINCETON PGS HX-12 IDEAL FOR IBM PC I
High Resolution 12" RGB color monitor.
• 80 character x 25 lines
• 680 x 240 dot resolution
• 16 colors, high & low intensity
• Includes IBM PC cable
• Very affordable



CALL
We carry the Quadram Quadchrome for only \$329.95



New! TAXAN 420 MONITOR
17" hi res RGB
CALL



MODEMS
ANCHOR MARK XII—Now Available
300/1200 BAUD, DC Hayes Compatible
HAYES Smartmodem 300 299
HAYES Smartmodem 1200 499



COMPATIBLE MODEMS FOR IBM PC

HAYES Smartmodem 1200B	449
Cactus Technology	299
Novation-Cat 300	115
Rixon PC212A (IBM PC) PC Modem Plus	349

Your Guarantee of Satisfaction
We guarantee every item in this advertisement for 30 days. If, for any reason whatever, you are not satisfied with any merchandise purchased from us, we want you to return it to us at our expense. We will exchange it for exactly what you want, or will refund your money, and include any shipping charges you have paid. Sorry, software must be excluded from our policy due to copyright laws.
NATIONAL COMPUTER PRODUCTS

To order please send money or cashier's check. Personal checks 3 weeks to clear. Prices reflect 2% cash discount. We accept VISA, MasterCard, American Express, Diners Club and Carte Blanche. Shipping, handling & insurance charges add 3% of merchandise total (min. \$5.00). California residents add 6% sales tax. Foreign customers please call or write. Prices and availability subject to change without notice. All equipment is new and warranted by the manufacturer.

It's Here! National Computers Winter 1983 collection of State-of-the-art computer merchandise is available now. You'll find dozens of products, including computers, printers, video monitors, modems and accessories for IBM PC, APPLE IIe and many other computer systems, all at the great price you expect from us. It includes dozens of illustrations and informative descriptions. And best of all, it's free!

TOLL-FREE ORDERING 800-854-6654

VISA NATIONAL COMPUTER PRODUCTS
8338 Center Drive, La Mesa, CA 92041-3791 Calif. Alaska, & Hawaii call (619) 698-8088
Information on products, and order inquiries call (619) 460-6502
DEALERS, WE BUY EXCESS STOCK, PLEASE CALL OR WRITE

KENSINGTON MICROWARE



SYSTEM SAVER

- Surge Suppression
- Fits Apple Stand
- Dual Outlet
- U.L. Listed
- Great Gift!

\$65

QUADRAM

APIC (APPLE /// PARALLEL)	129.99
IPIC (IBM PARALLEL)	89.99
ERAM 80 column 64K IIE	SCALL
MICROFAZER	SCALL
QUADBOARD I or II (64K)	279.99
QUADCOLOR I	234.99
QUADCOLOR II	209.99
QUAD 512+(64K)	249.99
QUADCHROME MONITOR	499.99

**QUADLINK
479.99**

MICROSOFT

A.L.D.S.	75.99
APPLESOFT COMPILER	116.99
BASIC COMPILER	259.99
COBOL COMPILER	559.99
FLIGHT SIMULATOR (IBM)	34.99
MOUSE (IBM)	129.99
MULTI-TOOL BUDGET	109.99
MULTI-TOOL FIN. STMT.	69.99
SOFTCARD II	215.99
SOFTCARD PREMIUM (IIE)	359.99
64K IBM SYSTEMCARD	295.99
WORD	SCALL

**MULTIPLAN
165.99**



CP/M 3.0
279.99

Dispatcher 99.99

SMARTERM II, or
Z-CARD II
129.99



380 Z
LETTER QUALITY
DAISY WHEEL PRINTER

- 48 K Buffer
- 32 CPS
- Graphics
- 10, 12, 15 Pitch
- Proportional spacing

Sheet Feeder 599.
Tractors 129.
Cable (Please Specify) 49.
NEW! Stylewriter SCAL

999

SPINYAKER

ALPHABET ZOO (new)	19.99
DELTA DRAWING	32.99
FACEMAKER	21.99
FRACTION FEVER (new)	21.99
HEY DIDDLE DIDDLE	19.99
KINDERCOMP	19.99
MOST AMAZING THING	26.99
RHYMES AND RIDDLES	19.99
SNOOPER TROOPS 1	27.99
SNOOPER TROOPS 2	27.99
STORY MACHINE	21.99

ALL OF ABOVE 214.99



ALPHA PLOT	24.99
APPLE MECHANIC	19.99
BEAGLE BASIC	24.99
DOS BOSS	15.99
DOUBLE TAKE	24.99
FLEX TEXT	19.99
FRAME-UP	16.99
PRONTO DOS	19.99
TIP DISK #1	14.99
TYPEFACES	14.99
UTILITY CITY	19.99

ALL OF ABOVE 234.99

EDUWARE

ALGEBRA I, II, or III	27.99
COMPIMATH	34.99
COMPUREAD	21.99
COMPUSPELL	21.99
COUNTING BEE	21.95
DECIMALS 3.0	33.99
FRACTIONS 3.0	33.99
PERCEPTION GAMES	19.99
PRISONER II	23.99
PSAT WORD ATTACK	33.99
RENDEZVOUS	27.99
SAT WORD ATTACK	33.99
SPELLING BEE GAMES	27.99
SPELLING/READING PRIMER	27.99
STATISTICS	21.99

APPLE SOFTWARE

BPI (GL, AP, AR, PAY, INV)	299.99
BRODERBUND Arcade Machine	44.99
Bank Street Writer	49.99
Chopdler	26.99
David's Midnite Magic	26.99
Loderunner	26.99
CENTRAL POINT Copy II +	25.99
CORVUS	SCALL
DATAMOST Aztec	29.99
Shwabsticker	26.99
Kids & Apple, VIC, COMM, ea.	14.99
DATASOFT Canyon Climber	17.99
Zaxxon	29.99
DLM Alien Addition	Sch-37.99, H-27.99
Alligator Mix	Sch-37.99, H-27.99
Demolition Division	Sch-37.99, H-27.99
Dragon Mix	Sch-37.99, H-27.99
Meteor Multiplication	Sch-37.99, H-27.99
Minus Mission	Sch-37.99, H-27.99
Spelling Wiz	37.99
Verb Viper/Word Invasion	37.99
Word Man/Word Master	37.99
Word Radar	37.99
EDUFUN Frenzy Flip Flop	23.99
EPYX Crush Crumble Chomp	22.99
GRAPH 'n CALC	14.99
HAYDEN Piewriter	129.99
Sargon II	26.99
INCREDIBLE JACK	129.99
JOR-AND Secret Agent	21.99
KENSINGTON Format II	26.99
L&S Crossword Magic	39.99
LEARNING CO Bumble Games	29.99
Bumble Plot	29.99
Gertrudes Puzzle	32.99
Juggles Rainbow	22.99
Magic Spell	26.99
Moptown Parade	26.99
Rocky's Boots	37.99
LIGHTNING Mastertype	29.99
MICROLAB Highrise	22.99
Miner 20-49er	29.99
Death in the Caribbean	26.99
Data Factory	229.99
ODESTA CHESS	53.99
Checkers	37.99
Odin	37.99
PEACHTREE	SCALL
PENQUIN Graphics Magician	44.99
SIERRA ON-LINE Frogger	24.99
Screenwriter II	89.99
Screenwriter PRO	149.99
Ultima II	44.99
Cannonball Blitz	26.99
General Manager	169.99
Dark Crystal	29.99
SOFTWARE DIMENSIONS ACCT +II	SCALL
STATE OF THE ART	SCALL
SUBLOGIC Pinball	26.99
ULTRASOFT Serpents Star	29.99
Mask of the Sun	29.99
VISICORP	SCAL

APPLE HARDWARE

CDP 16K RAM CARD	39.99
Printer Card & Cable	39.99
Fan w/surge, 2 outlets	39.99
DAN PAYMAR Lower Case I (rev 1-6)	25.99
Lower Case 2 (rev 7)	19.99
DARK STAR Snapshot II	89.99
EASTSIDE Wildcard	119.99
FOURTH DIMENSION Drive	219.99
HAYES Micromodem II	254.99
HAYES Micromodem Iie	SCALL
HOME Repeat Key	19.99
KOALA PAD	89.99
KRAFT Joystick	44.99
KRAFT Paddles	31.99
LEGEND 128K Ram	359.99
MICRO-SCI Drive	219.99
MOUNTAIN CPS Card	159.99
NOVATION Appocal II	269.99
Appocal Upgrade 1200 Baud	309.99
ORANGE MICRO Grappler +	119.99
Bufferboard	119.99
Buffer Grappler +	179.99
PADDLE ADAPPLE	24.99
SATURN 128K Ram	379.99
Accelerator II	444.99
Neptune 64K	199.99
Neptune 128K	299.99

ACCESSORIES

3-Ring Disk Sheets (10)	7.99
Printer Stand Small (plxgls)	24.99
Printer Stand Large (plxgls)	29.99
64K CHIPS (9x4 164-200ns)	9.99
16K CHIPS (8x4 116-200ns)	9.99
LIBRARY CASE	1.99
Fip 'n File (ORIGINAL)	17.99
Fip 'n File 25 Locktray	17.99
Fip 'n File 50 Locktray	27.99
Power Strip w/surge	17.99
HAYES 300 Baud Smartmodem	199.99
1200 Baud Smartmodem	474.99
NOVATION J CAT	104.99
NOVATION 103/212 AUTOCAT	429.99
NOVATION 103 SMARTCAT	169.99
NOVATION INFONE MAXI	869.99
NOVATION EXPANSION MOD	29.99
MX & FX 100 RIBBONS	7.99
MX & FX 80 RIBBONS	4.49
OKI 82, 83, 92, 93, (GM) RIBBONS	2.99
USI Compumod RF MOD.	34.99

**Fingerprint
(Epson Enhancer) 44.99**



1/2 Height DS/DD Drive	259.99
ALPHA Data Base MGR II	169.99
Apple-IBM Connection	129.99
Executive Package	115.99
Typefaces	79.99
ARMONK Executive Suite	27.99
ASHTON TATE dBase II	SCALL
Encyclopedia	59.99
Friday	SCALL
AST Boards	SCALL
BRODERBUND Apple Panic	21.99
Serpentine	26.99
CENTRAL POINT Copy II PC	25.99
DATAMOST Space Strike	21.99
Pin Pen	21.99
Real Estate Inv Prog	69.99
Write On	69.99
EDUWARE Algebra I	29.99
Prisoner II	29.99
EPYX Crush Crumble Chomp	22.99
Curse of Ra	14.99
Jabbertalky	22.99
Oil Barons	74.99
Star Warrior	22.99
Temple of Apsah	22.99
Upper Reaches of Apsah	14.99
GRAPH 'n CALC	149.99
HAYDEN Piewriter	129.99
HAYES 1200B Modem	439.99
KENSINGTON PC Saver	SCALL
KRAFT Joystick	44.99
LIFETREE Volkswriter	119.99
LIGHTNING Mastertype	36.99
LOTUS 1-2-3	SCALL
MICROLAB Highrise	22.99
Death in the Caribbean	25.99
Miner 20-49er	29.99
MOUNTAIN Hard disk	SCALL
NORTON Utilities	59.99
PC CRAYON	49.99
PC TUTOR	47.99
PERFECT SOFTWARE	SCALL
PPOOL 1.5	27.99
PLANTRONICS ColorPlus	409.00
SIERRA ON-LINE Frogger	26.99
Crossfire Lunar Leap, Mouskattakin	22.99
Golf Challenger	19.99
Urvises & Golden Fleece	29.99
SIR-TECH Wizardry	44.99
SUBLOGIC Pinball	29.99
TRAKER	169.99
TG Joystick	44.99
TITAN 64K BOARD	499.99
VISICORP, Visicalc, or Visidex	164.99
Visilink, Trend/Plot, Schedule ea	199.99
Visilink	SCALL
Visi-on	SCALL
Visispell	179.99
Visiword	269.99

EAGLE PC SCALL



SUPERCALC
SUPER SPELLGUARD
119.99ea.

SUPERWRITER
SUPERCALC 2
167.99ea.

APPLE, IBM & CP/M VERSIONS



APPLE WRITER PRE-BOOT	14.5
CHARACTER ROMS	24.5
ENHANCER II	99.5
HUNCTION STRIP	34.5
HARDSWITCH	16.5
MICROMODEM CHIP	24.5
PS10	169.5
SOFTSWITCH	25.5
ULTRATERM PRE-BOOTS	SCAL
VIDEOTERM W/S + INV	219.9
VISICALC PRE-BOOT	39.9

ULTRATERM 249.99

VIDEOTERM 199.99

INFOCOM

ENCHANTER DEADLINE	32.99
PLANETFALL	32.99
SUSPENDED WITNESS	32.99

STARCROSS

ZORK I	24.99
ZORK II	24.99
ZORK III	24.99

CP/M VERSIONS \$7.00 MORE

MONITORS

AMDEK	SCALL
PRINCETON RGB HZ-12	489.99
QUADCHROME RGB HX-12	499.99
USI Pi 1 9" Green 20 mh	116.99
USI Pi 2 12" Green 20 mh	119.99
USI Pi 3 12" Amber 20 mh	146.99
USI Pi 4 9" Amber 20 mh	136.99
USI 1400C Color Composite	288.99
OSBORNE Monitor Cable	SCALL
TI Monitor Cable	SCALL
RCA 6" Male-Male	2.99
Iie to Princeton card/cable	139.99

TAXAN 12" Green 18 mh 134.99

MicroPro

CALCSTAR	89.99
DATASTAR	179.99
MAILMERGE	139.99
REPORTSTAR	199.99
SPELLSTAR	139.99
STARINDEX	109.99
SUPER SORT	139.99
WORDSTAR PRO	389.99

INFOSTAR & WORDSTAR
Call for special pricing

Continental

APPLE SOFTWARE 1983 BOOK	9.99
ATARI SOFTWARE 1983 BOOK	9.99
APPLE GRAPHICS BOOK	14.99
CPA (GL, AP, AR, PAY) ea	149.99
FCM/FL 1st CLASS MAIL (AP)	61.99
FCM/FL 1st CLASS MAIL (IBM)	71.99
HOME ACCOUNTANT+ (IBM)	84.99
HOME ACCTNT+ (KAYPRO OSB)	59.99
HOME ACCTNT+ (TI PRO)	119.99
PROPERTY MANAGEMENT	299.99
TAX ADVANTAGE	39.99
HOME FILE (IBM)	SCALL

HOME ACCOUNTANT
Apple, Atari, Commodore **\$44.99**

DISKETTES

DYSAN 5" SS/DD (10)	31.99
DYSAN 5" SS/DD (100)	299.99
MAXWELL 5" SS/DD (10)	27.99
MAXWELL 5" SS/DD (100)	259.99
MAXWELL 5" DS/DD (10)	37.99
MAXWELL 5" DS/DD (100)	359.99
VERBATIM 5" SS/DD (10)	24.99
VERBATIM 5" SS/DD (100)	229.99
VERBATIM 5" DS/DD (10)	36.99
VERBATIM 5" DS/DD (100)	349.99

Dysan BOX or CASE
Double-sided, double density
10/box 38.99
100/case 369.99

PRINTERS

C-ITOH PROWRITER	SCAL
EPSON (ALL MODELS)	SCAL
OKIDATA 82A	384.99
OKIDATA 83A	629.99
OKIDATA 84P	969.99
OKIDATA 92	489.99
OKIDATA 93	859.99
STAR GEMINI 10X	SCAL
STAR GEMINI 15X	SCAL
STAR DELTA	SCAL
TRANSTAR	SCAL
RIBBONS IN STOCK FOR MOST MODELS	

SMITH CORONA
TP2 **499.99**



SAN JOSE:
860 S. Winchester Bl.
San Jose, CA 95128
(408) 985-0401
MON-FRI 8AM-7PM
SAT-SUN-HOL 10AM-5PM

COMPUTER DISCOUNT PRODUCTS
MAIL & PHONE ORDERS
860 S. Winchester Bl.
San Jose, CA 95128
(408) 985-0400

SAN FRANCISCO:
1230 Market St.
San Francisco, CA 94012
(415) 626-2244
MON-FRI 10AM-7PM
SAT-SUN-HOL 10AM-5PM

- No Charge For Credit Cards
- Prices Subject To Change
- Software Sales Are Final
- Min. \$4.00 Shipping Charge
- Purchase Orders Call First

VISA MASTERCARD

**TOLL-FREE
ORDERING:
800-222-8686**

**FOR TECHNICAL SUPPORT/
SERVICE / IN ARIZONA:
602-282-6299**

CCT CUSTOM COMPUTER TECHNOLOGY

1 CRAFTSMAN COURT — BOX 4160 — SEDONA, ARIZONA 86340

Purchase your Hardware and Software directly from an OEM/Systems Integrator. Take advantage of our buying power! We stock a full line of Board Level Components, Software, and Peripherals. Call for your needs. We'll give you the Lowest Prices, and the Technical Support and Know-How we are quickly becoming well-known for. Satisfied Customers Nationwide! The Nations's Custom Systems House for Business, Education and Science. Call for a system quote.

• FOREMOST QUALITY • ADVANCED SUPPORT • REASONABLE COST •

OF PRIME INTEREST

Our prime interest at CCT is **service and support**. We build and sell hundreds of systems per year to the serious computer market. We rigidly adhere to our strict policy of reliable machines, and reliable people behind them. We feel the CompuPro product line to be the state-of-the-art of the computer industry.

THE CCT EXCLUSIVE WARRANTY

With any system we build, we provide, in writing, an unconditional 12 month **direct** warranty on the entire system, including mainframe, boards, drives, power supplies, cabling and peripherals! We offer guaranteed 24 hour in-house repair and/or replacement with just a toll-free phone call. We can offer this, since we are so sure of our level of quality and reliability. It's great to know that in the event of a problem, you're not out of business waiting on service turnaround. We deliver!

Our various OEM contracts with all the manufacturers of the components we integrate, allow us this unprecedented flexibility. No factory O.K.'s necessary — just get it running — **NOW!**

Wyse 100 terminal - 14" Green ... **\$699**
 WS Prom Option - Installed ... **\$50**
 Mitsubishi 8" DSDD drives, full or half height. Set-up FREE OF CHARGE ... **\$449**
 Okidata 82 ... **\$389 / 83 ... \$619**
 84 ... **\$1029 / 92 ... \$469 / 93 ... \$779**
 Ashton-Tate dBASE II 8" or MD ... **\$299**
 Supercalc 86 - for CP/M 86 & MP/M ... **\$99**
 Visual Terminals in stock ... **Call**
 Lear Siegler ADM 20 ... **\$499**
 Freedom 50 ... **\$499 / 100-\$549**
 Hays Modem-\$259 • Diablo 620-\$1029

We carry a full line of software in all available formats at discount prices.

TECH TIP CORNER

dBASE II USERS - CUSTOM TERMINAL KEYS! Implement your arrow keys; emulate Wordstar edit commands - send an SASE with \$2.00 - (ATTN: TTC). Tell us your arrow key codes. We'll return easy, detailed instructions to change almost anything. It's beautiful — Pat...



CompuPro

**PROFESSIONAL LEVEL BUSINESS SYSTEMS
STATE-OF-THE-ART QUALITY, PERFORMANCE, RELIABILITY**

CCT ANNOUNCES: OUR OWN IN-HOUSE ENGINEERED CUSTOM COMPUPRO SYSTEMS

CCT-1 — ENTRY LEVEL S-100 BUSINESS SYSTEM

- Enclosure 2-Desk-20 Slot Mainframe •
- CPU 8085/88 - 6Mhz 8085/8Mhz 8088 •
- Disk 1 - DMA Floppy Disk Controller •
- RAM 16 - 64K Static RAM - 12 Mhz •
- Interfacer 4 - 3 Serial/2 Parallel I/O •
- CCT 2.4 Dual 8" Mitsubishi
- DSDD Drive System - 2.4 Megabytes •
- CP/M 80 - 2.2 LD/M - CCT Modified •
- All Cabling, Complete CCT Assembly, Testing, and Minimum 20 Hour Burn-in •

**INTRODUCTORY PRICE
\$3,399**

RUNS ALL STANDARD 8" CP/M SOFTWARE - INCLUDES OUR EXCLUSIVE 12 MONTH DIRECT WARRANTY

CP/M MP/M NOTE: Each copy we furnish is CCT modified for the target system. M-Drive/H and hard disk drivers are furnished, and the BIOS optimized for the fastest disk step rate, as well as terminal and printer compatibility.

★ ★ CCT-2 — THE FASTEST MICROCOMPUTER IN THE WORLD!! ★ ★

- Enclosure 2-Desk •
- CPU 8086 - 10Mhz •
- 128K - 16 Bit Memory •
- Interfacer 3-8 •
- SS1 •
- All Cabling, Complete CCT Assembly, Testing, & Minimum 20 Hour Burn-in
- 90K Baud Parallel Terminal Board •
- Disk 1 •
- CP/M 86 - CCT Modified •
- All Cabling, Complete CCT Assembly, Testing, & Minimum 20 Hour Burn-in
- 78 Key Professional Ergonomic Keyboard
- High Resolution Amber Monitor.
- CCT 2.4 Dual DSDD Drive System

**INTRODUCTORY PRICE
\$6,799**

RUNS ALL CP/M 86 SOFTWARE - ULTRA FAST - INCLUDES 12 MONTH DIRECT WARRANTY

★ ★ CCT-3 — 10Mhz 68K System similar to above, with 128K RAM \$6,699 ★ ★

We are the largest in the custom configuration of complete state-of-the-art S-100 systems, at package pricing, with integration, burn-in and programming. We custom build CompuPro systems / hard disk systems for business applications. Call for CompuPro literature, CCT system configuration data and technical information. We can save you money!

★ SUPER PRICES ★ COMPUPRO COMPONENTS ★ IN STOCK ★

SYSTEM SPECIALS — ALL CCT A&T, BURNED IN:

816A-\$4299	816B-\$4999	816C-\$6499
M-Drive CP/M - Blowout-\$39	Disk 1w/CP/M-\$449	M-Drive/H-512K-\$1149
CPU 8085/88-\$319	CPU 8086/87-\$579/10Mhz-\$659	CPU 68K-\$519/10Mhz-\$639
CPU 286-\$1249/10Mhz-\$1359	Disk 1-\$369	Disk 2-\$599
RAM 17 (12Mhz)-\$329	RAM 16 (12Mhz)-\$359	RAM 21 (128K)-\$779
RAM 22 (256K)-\$1399	Interfacer 1-\$229	Interfacer 2-\$249
Interfacer 3-5-\$399/3-8-\$459	Interfacer 4-\$349	System Support 1-\$299
Enclosure 2-Desk-\$599/Rack-\$649	20 Slot Motherboard-\$210	CP/M 80-\$99
CP/M 86-\$150	MP/M 86-16-\$699	CP/M 68K-\$279
UNIX - SOOM	86 Upgrade Kit: Consists of CP/M 86, 64K Ram, System Support 1, Cable - \$749	

Call for CSC Boards — New Releases — Operating System Mods/Updates

★ PRICE BREAKTHROUGH ★

Hard Disk Subsystems

CCT/Fujitsu 5 1/4" subsystem, includes Disk 3, custom enclosure & power supply, all cabling, A&T, formatted, burned-in. Ready for any CompuPro or similar S-100 system:
CCT-5 (5.5 Meg)-\$1599
CCT-10 (11 Meg)-\$1899 / CCT-20 (22 Meg)-\$2299

?? HARD DISK DECISIONS ??

Hard/Floppy Combinations

An exclusive CCT innovation. CCT/Fujitsu/Mitsubishi ultra-system: 5 1/4" hard disk next to a 1.2 Meg. DSDD 8" floppy. Includes Disk 3, custom horizontal enclosure and power supply, all cabling, A&T, formatted, burned-in. Will stand alone in any CompuPro system:
CCT-5/1-\$2099 CCT-10/1-\$2399 CCT-20/1-\$2799

★ NEW DISK 3/5 1/4" HD SYSTEMS ★

2.4 Megabyte Floppy Systems

CCT/Mitsubishi 2.4 Megabyte Dual DSDD 8" system. Includes custom horizontal enclosure, all cabling, A&T, burned-in. This is the fastest system available:
\$1149
 With stacked half-height drives: **\$1175**

All Systems Carry Our Exclusive 12 Month Warranty.

Prices & availability subject to change. All products new, and carry full manufacturer's warranties. Call for catalog. Free technical help to anyone. We can configure boards & software for your system. Plug-in and go. Arizona Residents add sales tax. **CompuPro**™ Trademark — W.J. Godbout; **CP/M**™ **MP/M**™ Trademarks — Digital Research

7400		
7400	19	74125 39
7401	22	74126 44
7402	22	74128 59
7403	22	74132 69
7404	22	74136 75
7405	23	74139 95
7406	2.35	74141 79
7407	2.35	74142 2.95
7408	26	74143 2.95
7409	23	74144 2.95
7410	22	74145 62
7411	29	74147 1.95
7412	29	74148 1.20
7413	39	74150 1.09
7414	59	74151 67
7416	29	74152 67
7417	29	74153 67
7420	22	74154 1.19
7421	35	74155 78
7422	29	74156 78
7423	29	74157 69
7425	29	74158 1.65
7426	29	74159 2.49
7427	25	74160 88
7429	45	74161 88
7430	23	74162 89
7432	29	74163 87
7437	25	74164 87
7438	29	74165 87
7439	29	74166 1.20
7440	19	74167 1.95
7441	79	74170 1.69
7442	57	74172 4.75
7443	95	74173 79
7444	95	74174 89
7445	79	74175 85
7448	79	74176 75
7447	65	74177 75
7448	79	74179 1.34
7450	19	74180 75
7451	19	74181 1.75
7453	19	74182 75
7454	19	74184 2.25
7459	25	74185 2.25
7460	23	74186 9.95
7470	29	74188 3.90
7472	29	74190 1.15
7473	34	74191 1.15
7474	34	74192 85
7475	38	74193 85
7476	34	74194 85
7479	4.60	74195 88
7480	49	74196 85
7482	95	74197 85
7483	55	74198 1.39
7485	65	74199 1.39
7486	35	74221 1.19
7489	1.75	74251 95
7490	39	74273 1.05
7491	57	74276 1.89
7492	45	74279 75
7493	45	74283 1.40
7494	69	74284 3.90
7495	65	74285 3.90
7496	69	74290 1.25
7497	2.90	74298 95
74100	2.90	74365 68
74107	32	74366 68
74109	37	74367 68
74116	1.95	74368 68
74121	29	74390 1.45
74122	39	74393 1.90
74123	59	74490 1.90

74LS00		
74LS00	26	74LS162 1.05
74LS01	28	74LS163 1.05
74LS02	28	74LS164 1.19
74LS03	28	74LS165 89
74LS04	35	74LS166 2.48
74LS05	28	74LS168 1.15
74LS08	28	74LS169 1.15
74LS09	35	74LS170 1.99
74LS10	28	74LS173 89
74LS11	39	74LS174 89
74LS12	33	74LS175 89
74LS13	47	74LS181 2.20
74LS14	95	74LS190 1.15
74LS15	33	74LS191 1.15
74LS20	26	74LS192 98
74LS21	33	74LS193 98
74LS22	33	74LS194 1.15
74LS26	33	74LS195 95
74LS27	33	74LS196 89
74LS28	33	74LS197 89
74LS30	26	74LS221 1.15
74LS32	33	74LS240 1.69
74LS33	55	74LS242 1.69
74LS37	45	74LS243 1.69
74LS38	39	74LS244 1.49
74LS40	26	74LS245 2.20
74LS42	79	74LS247 1.10
74LS47	79	74LS248 1.10
74LS48	95	74LS249 1.19
74LS51	26	74LS251 1.40
74LS54	29	74LS253 1.40
74LS55	29	74LS257 85
74LS73	45	74LS258 98
74LS74	1.42	74LS259 2.95
74LS75	59	74LS260 65
74LS76	45	74LS261 2.49
74LS78	45	74LS266 59
74LS83A	79	74LS273 1.75
74LS85	1.19	74LS275 4.40
74LS86	45	74LS279 59
74LS90	57	74LS283 99
74LS92	75	74LS290 99
74LS93	75	74LS293 99
74LS95	88	74LS295 1.10
74LS96	98	74LS298 1.19
74LS107	45	74LS324 1.75
74LS109	45	74LS347 1.95
74LS113	43	74LS348 1.95
74LS114	43	74LS352 1.19
74LS122	55	74LS353 1.19
74LS123	1.19	74LS363 1.49
74LS124	1.35	74LS365 69
74LS125	89	74LS366 69
74LS126	52	74LS367 69
74LS132	79	74LS368 69
74LS136	49	74LS373 1.89
74LS138	85	74LS374 1.89
74LS139	85	74LS375 69
74LS145	1.25	74LS377 1.95
74LS148	1.49	74LS385 1.95
74LS151	79	74LS386 65
74LS153	79	74LS390 1.95
74LS154	1.70	74LS393 1.95
74LS155	1.19	74LS395 1.70
74LS156	99	74LS399 2.35
74LS157	85	74LS424 2.95
74LS158	75	74LS668 1.75
74LS160	1.05	74LS670 2.29
74LS161	1.15	74LS378 1.95
74LS133	85	74LS379 1.95
74LS241	1.69	74LS381 2.95
74LS280	2.90	74LS640 2.95
74LS299	2.00	74LS645 2.95
74LS339	1.95	74LS690 1.50

Tel: 1-(800)-821-3628

74S00	
74S00	39
74S02	43
74S03	45
74S04	52
74S05	52
74S08	49
74S09	49
74S10	42
74S11	42
74S15	42
74S20	42
74S22	42
74S30	42
74S32	49
74S38	1.19
74S40	49
74S51	42
74S64	46
74S65	46
74S74	69
74S86	72
74S112	72
74S113	72
74S114	72
74S124	3.69
74S133	54
74S134	66
74S135	1.15
74S136	1.69
74S138	1.29
74S139	1.29
74S140	73
74S151	1.29
74S153	1.29
74S157	1.29
74S158	1.29
74S160	2.79
74S174	1.49
74S175	1.49
74S188	2.69
74S194	1.89
74S196	1.89
74S240	2.75
74S241	2.75
74S242	2.99
74S243	2.99
74S244	2.99
74S251	1.35
74S253	1.35
74S257	1.29
74S258	1.29
74S260	75
74S280	2.79
74S287	2.99
74S288	2.55
74S373	3.10
74S374	3.10
74S387	2.75
74S471	7.95
74S472	7.95
74S473	7.95
74S474	9.95
74S475	9.95
74S570	5.75
74S571	5.75
74S572	8.95
74S573	8.95
74S940	2.90
74S941	2.90
74S132	2.15
74S161	2.95
74S163	3.15
74S181	2.15
74S189	2.95
74S225	7.75
74S283	4.15
74S289	3.95

LINEAR	
LM301CN	35
LM304H	1.98
LM305H	1.89
LM306H	3.25
LM307CN	3.25
LM308CN	98
LM309K	1.49
LM310CN	1.25
LM311D/CN	89
LM312H	1.75
LM317T	1.70
LM318CN	1.49
LM319H/H	1.25
LM320K-XX*	1.35
LM320T-XX*	1.39
LM320H-XX*	1.25
LM323K	4.95
LM324N	95
LM337K	5.95
LM338K	6.95
LM339N	95
LM340K-XX*	1.75
LM340T-XX*	1.25
LM340H-XX*	1.25
LM344H	1.95
LM348N	1.20
LM350K	5.60
LM358CN	98
LM360N	1.49
LM372N	1.95
LM376N	3.75
LM377N	2.75
LM380CN/N	1.25
LM381N	1.79
LM383T	1.95
LM386N	1.25
LM387N	1.40

16 RAM CARD

Compatible with DOS 3.3, CP/M, Visicalc, PASCAL
1 YR WARRANTY

\$39.95

MULTIFUNCTION BOARD WITH MEMORY, I/O CLOCK

FOR IBM P/C
CALL FOR LOWEST PRICE

SPEEDY EPROM PROGRAMMER FOR APPLE II PROGRAMMING

2716, 2732, 2764, 27128, 2532, 2564

IN 30 SECONDS **\$99.00**

Apple II/e Compatible Disk Drive CONTROLLER CARD

\$175.00
\$44.95

SUPER COOLING FANS FOR APPLE WITH SURG

\$39.50

Allow up to four computers
Share one printer

IBM MEMORY EXPANSION KIT

IBM 64K **\$52.95**
(9 Pcs 64K RAM)

High Quality Diskettes

5 1/4" SS/SD 15/Box
5 1/4" SS/DD 17/Box
5 1/4" DS/DD 27/Box

80 Column Dot Matrix Printer

CP-80 by C.T.I.
80 cps parallel interface
graphics printing compatible with EPSON MX80FT

SALE PRICE **\$299.00**

DIP SWITCHES

4 Position	85
5 Position	90
6 Position	90
7 Position	90
8 Position	95

SOUND CHIPS

76477	2.95
76489	8.95
AY3-8910	9.95
AY3-8912	12.95
MC3340	1.49

Z80 SERIES

8000 SERIES

8200 SERIES

6800 SERIES

CALL FOR PRICE

Miscellaneous

6502	4.95
68000	49.95
8748	24.95
8255-5	5.95
82S123	2.55
82S129	2.99
82S131	3.99
93422	8.95
93L422	9.95
93425	3.95
93427	8.95
D2125AL-2	3.95
D2104	1.95
AY5-3600	12.95
6810	3.95
8304	3.95

MOS PROMS

2708	3.95
2758	5.95
2716	3.95
2716-1	5.95
TMS2516	5.50
TMS2716	7.95
TMS2532	5.95
2732	4.95
2732-250	8.95
2732-200	11.95
2764	8.95
2764-250	10.95
2764-200	16.95
TMS2564	12.95
MC68764	39.95
27128	25.95

S-RAM

2101	1.95
5101	3.95
2111	2.49
2112	2.99
2114	8.95
2114-25	8.10
2114L-4	8.12
2114L-3	8.13
2114L-2	8.13
2147	4.95
HM6116-4	4.75
HM6116-3	4.95
HM6116-2	8.95
HM6116LP-4	5.95
HM6116LP-3	6.95
HM6116LP-2	10.95

DRAM

TMS4027	1.99
UPD411	3.00
MM5280	3.00
MK4108	1.95
MM5298	1.85
4116-300	8.11
4116-250	8.11
4116-200	8.12
4116-150	8.14
4116-120	8.29
2118	4.95
4164-200	5.95
4164-150	6.95

TERMS: For shipping include \$2 for UPS Ground or \$3 for UPS Blue Label Air. Items over 5 pounds require additional shipping charges. **\$10 minimum order.**

1-(800) 821-3628

Handwellcorp

4962 EL CAMINO REAL, SUITE 119 • LOS ALTOS, CA 94022
(415) 962-9265 • TLX: 171947 HANDWELL LTOS

Computer Components Unlimited SUPER BOWL SPECIALS

**We Will Try To Beat All
Competitor's Prices In This Magazine!**



BMC Color Monitor

- Composit Video
- Great for Apple's

\$219

Dual 5 1/4" Cabinets

- Power Supply
- Hi Quality
- Mfg. by PC Products

\$79

CDC Disk Drive for PC

- Cadillac of the Drives
- Fully IBM Compatible

\$239

Okidata 92

- 160 cps
- Close to Letter Quality

\$429



Hayes Micro Modem IIE

- w/Software
- Lowest Advertised Price ever

\$239

Gemini 15X

- 15" Carriage
- 120 cps

\$399

MicroSci A-2

- Fully Apple Compatible
- Looks Like Apple Drive

\$209

C. Itoh F-10 -55

- Letter Quality
- 55 cps

\$1395

Siemens FDD100-8

- 8" Disk Drive
- Sgl. Side/DbI. Density

\$159

2 For \$300

Gorilla Monitor

- Amber Video
- 12" Composite

\$99



Lotus 123

- State-of-the-Art Software
- The BEST!!

\$329

PGS Monitor

- IBM Copy
- Color Res.

\$479

Plantronics

- Color Board for PC
- Parallel Port
- Great Software Included

\$399

Franklin Ace 1000

- 64K
- Numeric Key Pad
- Large Power Supply & Fan
- Apple Compatible

\$799

IBM, Kaypro, RS232 Cables

- 6 ft. Long

\$24

MORE

Computer Components Unlimited



800-847-1718

OUTSIDE CALIFORNIA

RETAIL STORE:
11976 Aviation Blvd.
Inglewood, CA 90304

MAIL ORDER:
P.O. Box 1936
Hawthorne, CA 90250

**This Ad Supersedes All Other
(213) 643-5188**

All merchandise new. We accept MC, Visa, Wire Transfer, COD, Call, Certified Check, P.O.'s from qualified firms, APO accepted. Shipping Minimum \$4.50 first 5 pounds. Tax: California Res. Only add 6 1/2% sales tax.

Prices Subject to Change

**Mon.—Fri. 8 a.m. to 6 p.m.
Sat. & Sun. 10 a.m. to 5 p.m.**

Circle 71 on inquiry card.

**We Will Try To Beat
ALL Competitor's Prices
In This Magazine!!**

MORE SUPER FROM Computer

PERSONAL / PORTABLE SYSTEMS

Franklin

Ace 1000 w/64K	\$ 799
Ace 1100	299
Ace 1200 OMS	1795
Ace Pro Pack	1149
Franklin Ace Drive	299

Apple Computer

IIE w/64K	\$ 995
IIE Starter System	1395
Apple Drive	299
Apple IIE 80 col. card	49

IBM

PC 64K, Keyboard, 1 Drive	\$1995
PC 64K, Keyboard, 2 Drives	2245
XT Hard Disk Drive, 128K	4995
PC Monochrome Card	335
PC Color Card	275
PC Monochrome Monitor	335

Kaypro

Kaypro II	\$1495
Kaypro 4	1795
Kaypro 10	2595

Columbia

1600-1, 2 Dbl. Drives, Color Card, Keyboard	\$2795
--	--------

Eagle Call for pricing

Televideo

Teletote I	\$1395
Teletote II	1695
TS 803	1900
TS 1603	2450

Compupro

816A	\$4195
Call for Compupro Board Pricing	

Sanyo

MBC-555	\$ 975
MBC-1000	1395

STM Computers

Pied Piper I	\$ 995
--------------	--------

MODEMS

Hayes Micro Computer

300 Baud Smart Modem	\$ 209
1200 Baud Smart Modem	499
Micro Modem w/software	259
1200 Baud w/smart.com for PC	409
Chronograph	229

Novation

J-Cat 300 Baud	\$ 109
Apple Cat II	249

APPLE, FRANKLIN Accessories

Advanced Logic Systems

CPM 3.0 Card (6 MHz)	\$ 299
Z Card	139
CPM Card + Super Calc	499

Astar

RF Modulator	\$ 18
Fan	39
Hi-quality Joystick	29

Gibson

Light pen	\$ 239
-----------	--------

Micro Max

80 col. for II+ or Franklin, Inverse Char., Soft switch, Videx Compatible	\$ 139
80 col. for IIE w/64K exp. 128K	139

Kensington

System Saver	\$ 79
--------------	-------

Micro Soft

Softcard w/cpm	\$ 239
16K Card	69
Premium Pack	499

California Computer Systems

Serial interface card	\$ 129
-----------------------	--------

TG Products

Joystick	\$ 44
Paddles	34
Selectaport	39

Kraft

Joystick	\$ 49
----------	-------

Micro Tek

Bam 16K card	\$ 59
Serial Interface	119

LOW PRICED Hi Quality DISKETTES

Computer Components

5 1/4" Disks

Sgl Side / Dbl Density	\$18 a box
Dbl Side / Dbl Density	27 a box

8" Disks

Sgl Side / Sgl Density	\$19 a box
Dbl Side / Dbl Density	29 a box

All Disks come w/ Reinforced Hub,
5 yr warranty and not bulk packed.

FlipTubs

Smoked Plexiglass Diskette File Holds 70	\$ 19
---	-------

Call for all brands of Disks.

IBM PC ACCESSORIES

Ast Research

IO +	\$ 119
Combo +	259
Six Pack +	279
Mega +	279
Mega Pack	279

Quadram

Quad Link	\$ 475
Color Graphics Card	245
Quadchrome Color Monitor	475

Tandon

320K Disk Drive	\$ 235
-----------------	--------

Panasonic

Slimline Drive, 320K	\$ 205
----------------------	--------

CDC

320K Disk Drive	\$ 249
-----------------	--------

64K Upgrade

each 64K	\$ 59
----------	-------

Paradise Systems

Multi Display Card	\$ 399
--------------------	--------

Plantronics

Multi Display Card	\$ 399
--------------------	--------

PC Cable

Printer Cable (6 ft)	\$ 29
----------------------	-------

5 1/4" & 8" DISK DRIVES

Shugart

SA400, Sgl/Dbl	\$ 160
SA455, 1/2 Height	225
SA801R Sgl/Dbl	355
SA851R Dbl/Dbl	475

Tandon

TM 100-1, 160K	\$ 160
TM 100-2, 320K	235
TM 101-4 (quad)	299
TMTM 848-1 Sgl/Dbl Den	359
TM 848-2 Dbl/Dbl Den	435

Mitsubishi

2894 Dbl/Dbl 8"	\$ 399
-----------------	--------

Siemens

FDD 100-8, Sgl/Dbl	\$ 159
--------------------	--------

CDC

9409T, 320K	\$ 239
-------------	--------

**We accept all P.O.'s from Universities
CALL 800-847-1718**

We Offer More Than ^{Just} Low Prices!!!



BOWL SPECIALS

Components Unlimited

STOP! Compare our
Super Bowl Prices



DISK DRIVES FOR APPLE & FRANKLIN

Super 5

Sup-5 (1/2 Height) \$ 209
Controller 69

Rana Systems

Elite I \$ 250
Elite II 400
Elite III (Quad Density) 500
Controller (controls 4 drives) 90

Quentin Research

Apple Mate \$ 219
Controller 60

Micro Sci

A-2 \$ 209
Controller 70

Mountain Computer

5 meg hardisk \$1795

DISK DRIVE CABINETS

5 1/4" Cabinets

Single Cab. w/ power supply \$ 59
Dual Cab. w/ power supply 85

8" Cabinets

Single Cab. w/ fan & power supply \$ 209
Dual Cab. w/ fan & power supply 259

HOT CIRCUITS

Watch Computer Components to
expand in this area. Call for all
volume requirements.

TTL

74LS244 \$1.39

Dynamic Rams

TMS 4027 \$1.99
UPD 411 3.00
4116-200 ns 1.59
4164-200 ns 5.95
4164-150 ns 6.95

Static Rams

2114 L-2 \$1.69
6116-4 200 ns 4.65

Eproms

1702 \$4.40
2708 4.00
2716 4.00
2732 4.80
2764 6.00

PRINTERS

C. ITOH

Gorilla-Banana, 50 cps \$ 194
Prowriter 8510, 120 cps 349
Prowriter II 1550 (15") 649
Prowriter I Serial 499
Prowriter II Serial 695
Starwriter F-10, 40 pu 1129
8600BP, 180 cps 999
Printmaster F-10-55 1375

Epson

RX-80 (120 cps) Call
MX-80FT (80 cps) Call
FX-80 (160 cps) Call
FX-100 (15" Carriage) Call

NEC

PC8023A (100 cps) \$ 399
PC8025 (15" Carriage) 699

Okidata

Microline 92P (160 cps) \$ 429
Microline 92S (160 cps) 599
Microline 93P (160 cps, 15") 749
Microline 93S (160 cps, 15") 899
Microline 82A (Par. & Serial) 369
Microline 83A (15" Carriage) 599
Microline 84P (200 cps) 969
Microline 84S (200 cps) 1049

Star Micronics

Gemini 10X (120 cps) \$ 294
Gemini 15 (100 cps) 339
Gemini 15X 499
Delta 10 449

Letter Quality

Brother Hrl \$ 599
Comrex II 499
Juki 499
Dynax DX-15 479

Daisywriter

2000 w/Buffer \$1199

Call For All Printers

TERMINALS

Qume

102, 80 col. Green \$ 539
102AM 549
103, 80/132 749

Adds

Viewpoint 3A + \$ 570

Televideo

925 \$ 719
950 919

PRINTER ACCESSORIES

Orange Micro

Grappler + \$
Grappler + w/16K exp. to 64K \$

Apple Par. Card

Card & Cable \$

Microtek

Dumpling GX \$
Dumpling w/ 16K exp. to 64K \$
Additional 16K for \$

Wesper Micro

Full Graphics Interface Card \$

Cables

IBM to Printer \$
Kaypro to Printer \$
Osborne to Printer \$

Okidata Options

Tractor for 82 & 92 \$
2K Serial Buffer \$

Star Options

Serial Interface \$

Epson Options

Buffer w/ Serial \$

VIDEO DISPLAY MONITORS

USI

PI 1 (9" Green HiRes) \$
PI 2 (12" Green HiRes) \$
PI 3 (12" Amber HiRes) \$
PI 4 (9" Amber HiRes) \$

BMC

12 AUW (12" Green) \$
9191 Color Composite \$
12 EUN (20MHZ HiRes) \$

Zenith

ZVM122 (Green) \$
ZVM123 (Amber) \$

Gorilla

HiRes Green \$
HiRes Amber \$

Amdek

Color I Composite Color \$
Color II RGB \$
300A \$
310A \$
300G \$

Princeton Graphics

PGS HX12 \$

Circle 72 on inquiry card.

Computer Components Unlimited

800-847-1718

OUTSIDE CALIFORNIA

RETAIL STORE:

11976 Aviation Blvd.
Inglewood, CA 90304

MAIL ORDER:

P.O. Box 1936
Hawthorne, CA 90250

This Ad Supersedes All Other
(213) 643-5188

All merchandise new. We accept MC, Visa, Wire Transfer, COD Call, Certified Check, P.O.'s from qualified firms, APO accepted. Shipping Minimum \$4.50 first 5 pounds. Tax: California Res. Only add 6% sales tax.

Prices Subject to Change

Mon.—Fri. 8 a.m. to 6 p.m.
Sat. & Sun. 10 a.m. to 5 p.m.

COMPUTER SUPPLIES

DISKETTES

5 1/4
S/S S/D
MIN. ORDER 50

\$160

RIBBONS

OKIDATA
MICROLINE 84

\$377

EPSON
MX100
MIN. ORDER 6

\$784

LABELS • CONTINUOUS FORMS

PeachText 5000 REG 395⁰⁰ 275⁰⁰



complete line of
EDUWARE SOFTWARE

- Terms: Visa, M.C. or C.O.D.
- Dealer Inquiries Invited

**COMPU-MEDIA
SOFTWARE, INC.**

159 Main St. S.I.N.Y. 10307

CALL TOLL FREE 1-800-248-2418
in N.Y. State 212-967-1700

Circle 381 on inquiry card.

FREE SOFTWARE

RENT THE PUBLIC DOMAIN!

User Group Software isn't copyrighted, so no fees to pay! 1000's of CP/M software programs in .COM and source code to copy yourself! Games, business, utilities! All FREE!

CP/M USERS GROUP LIBRARY

Volumes 1-91, 46 disks rental—\$45

SIG/M USERS GROUP LIBRARY

Volumes 1-90, 46 disks rental—\$40

Volumes 91-154, 30 disks rental—\$40

SPECIAL! Rent all SIG/M volumes for \$75

IBM PC-SIG (PC-DOS) LIBRARY

Volumes 1-75, 5 1/4" disks \$99.50

SPECIAL "Flippy" Floppies

copy both sides—8" \$3.00

5 1/4" \$2.00

Disk—Public Domain User Group Catalogs \$5 (check in advance, please)

Rental is for 7 days after receipt, 3 days grace to return. Use credit card, no deposit.

ALL FORMATS AVAILABLE! SPECIFY.

Shipping, handling & insurance—\$7.50 per library.

(619) 941-0925 information.

(619) 727-1015 anytime order machine

Have credit card ready!



P.J.S. Co.
993 S. Sante Fe "C"
Vista, CA 92083



Circle 288 on inquiry card.

C LANGUAGE PROGRAMMERS

**c-systems
C COMPILER
c-window™**

The complete c language source level program testing and debugging tool.

- Single step by c source line.
- Set breakpoints at line numbers.
- Display and alter variables by symbol name, using c expression syntax.
- No more print or assembler level debugging!

c-window™ is a support package for the **c-systems C COMPILER** for 8086/8088 based systems.

Contact:

c-systems
P.O. Box 3253

Fullerton, CA 92634
714-637-5362

TM c-systems

SEE OUR CATALOG FOR 8" DISKETTES

SAVE UP TO 50% 5 1/4 DISKETTES

SPECIFY SOFT, 10 or 16 SECTORS

	\$/10	\$/50	\$/100
wabash			
SSDD (M13A411X)	21.00	102.50	199.00
DSDD (M14A411X)	29.00	142.50	279.00
DSDD-96TPI (M16A411X)	43.00	209.00	410.00
control data			
SSDD (C2C1242-00)	22.00	106.00	210.00
DSDD (C2C1244-00)	30.50	147.00	290.00
3M scotch			
SSDD (3M 744D-0)	22.00	109.00	213.00
DSDD (3M 745-0)	31.00	150.00	295.00
DSDD-96TPI (3M-747-0)	45.00	212.00	399.00
verbatim			
SSDD (MDS25-01)	25.20	124.00	245.00
DSDD (MDS50-01)	36.50	180.00	352.00
DSDD-96TPI (MDS57-01)	45.80	226.00	448.00
maxell			
SSDD (MAX-MD-1M)	26.50	130.00	255.00
DSDD (MAX-MD2-DM)	38.00	185.00	360.00
DSDD-96TPI (MD2-DDM)	43.00	210.00	410.00
dysan			
SSDD (DYS 104-1D)	35.00	172.00	340.00
DSDD (DYS 104-2D)	41.00	200.00	395.00
DSDD-96TPI (DYS 204-2D)	48.50	240.00	475.00

CALL TOLL FREE 800-824-7888
VISA, M.C., C.O.D. ORDERS ONLY OPERATOR 906
Creativity Unlimited 7 DAYS A WEEK

1741 SARATOGA AVE., #201
SAN JOSE, CA 95129
(408) 252-4210

M-F, 8:00 AM TO 5:00 PM
FOR NEXT DAY RESPONSE

DEALER INQUIRIES INVITED

Circle 118 on inquiry card.

PIPED
of looking for reliable
Source of Supply?

RUNDOWN
from Looking???

NERVOUS
about
QUALITY???

**DISKETTES +
RIBBONS +
ACCESSORIES**

Call Bob Kelly Now...
Kelly Computer Supplies
1811 Carl St. • St. Paul, MN 55113
Toll Free . . . 800 - 447 - 2929
MN Res. Call Collect. . . 612/644-9030

3M SCOTCH DISKETTES

Circle 209 on inquiry card.

**FOR YOUR APPLE,
RADIO SHACK,
IBM PC,
OSBORNE ETC.**

DISKETTES-5 1/4 IN.

	3M	MEMOREX
SSDD	\$2.10 Ea./50	\$2.10 Ea./100
DSDD	\$2.85 Ea./50	\$2.85 Ea./100

HARD DISC SUBSYSTEMS

	5MB	10MB	15MB
APPLE	\$1,250.	\$1,500.	\$1,700.
IBM	\$1,300.	\$1,550.	\$1,750.

PRINTERS

FACIT 4510 P AND S \$450. Ea.
PROWRITER 8510 P \$395. Ea.
PROWRITER 1550 P \$695. Ea.
TRANSTAR 315 \$515. Ea.

We carry Daisy Wheel Printers, Floppy Disc Drives, Monitors, Terminals, Expansion Boards, Software, Ribbons, Printwheels, Etc.

Met-Chem

Met-Chem International Corporation
2911 Dixwell Avenue, Hamden, Conn. 06518
Phone: (203) 248-3212 or 1-800-638-2436

Circle 240 on inquiry card.

CP/M CROSS SOFTWARE for the NS16000

INCLUDES:

- ★ Cross Assembler ★
- ★ Cross Linker ★
- ★ Debugger ★
- ★ Librarian ★
- ★ Pascal Cross Compiler ★

Prices start at
\$500 for Assembler only.

SOLUTIONWARE CORPORATION

1283 Mt. View-Alviso Rd.
Suite B
Sunnyvale, CA 94086
408/745-7818

Circle 334 on inquiry card.

Scotch® Diskettes

Rely on Scotch® diskettes to keep your valuable data safe. Dependable Scotch diskettes are tested and guaranteed error-free. The low abrasivity saves your read/write heads. They're compatible with most diskette drives.



(800)235-4137

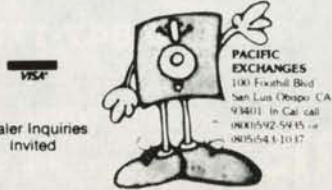

Circle 278 on inquiry card.

DISK DRIVES

(For PC, Mod I, III & IV)

Tandon TM55-2	\$229
Tandon TM100-1	\$175
Tandon TM100-2	\$229
Tandon TM101-4	\$315
CDC 9409	\$239
Case and PS	\$ 45

PC EXPANSIONS

MAYNARD

Disk Controller	\$162
Sandstar Series	call

QUADRAM

Quad board (64K)	\$269
------------------	-------

AST

Six Pak Plus: 64K SPC	\$269
Mega Plus: 64K & SC	\$269
I/O Plus (SC)	\$114
2nd S or P or Game	\$ 35

64K CHIPS
Set of nine \$ 55

EPSON
RX80, FX80, FX100 call

VLM Computer Electronics
10 Park Place • Morristown, NJ 07960
(201) 267-3268 Visa, MC, Check or COD.

Circle 240 on inquiry card.

MORE THAN 7 REASONS

MINIMUM SHIPPING \$3.00 · NO SURCHARGE ON VISA/MASTERCARD

TOLL FREE 1-800-545-2633 - Continental U.S.

DISK DRIVES

SHUGART	
5 1/4" SA400 (35 TR) 160K	150.00
5 1/4" SA400L (40 TR) 190 K	189.00
5 1/4" SA455L (40 TR) 320 K 1/2 HGT	235.00
8" SA801R(SS/DD) 600 K	355.00
8" SA851R(DS/DD) 1.2 MG	479.00
QUME	
5 1/4" 142 (40TR) 320 K 1/2 HGT	239.00
8" DT8 (842)	490.00
MITSUBISHI	
5 1/4" M-4853 1/2 size	410.00
96 TPI same as TM 100-4	
M-289-63(DS/DD) 220V	449.00
8" M-2896-63	399.00
Thinline 8" DS/DD 1.2 MG	

8" M-2894-63 (110V) 389.00
STD 8" DS/DD 1.2 MG

AC SURGE ELIMINATORS

Grizzly (200W) uninterruptible power system + surge protection	750.00
Grizzly (500W) uninterruptible power system + surge protection	1,802.00
Hawk AC power monitor w/surge protection	160.41
Lemon (6AC outlets-3 prong)	44.00
Lime (5-3 prong pwr cord w/on-off switch)	69.00
Orange-AC surge + EMI filter (6 outlets)	95.00
Peach (3 outlets) AC surge/EMI filter	69.00

DATA CABLES

8"DSC 88-2SKT-for 2-8" drvs w/skt. conn.	20.00
5 1/4"DSC55-2SKT-for 1-5 1/4" dvs w/skt. conn.	20.00
RS232MM-5' (male to male)	19.00
IBM to PAR	32.00
Osborne to PAR	32.00
Kaypro to PAR	32.00
OKI-Data Serial	24.00

E-PROM ERASERS

QUV-T8/1H (hobby)	49.95
QUV-T8/2I (Industrial version)	68.95
QUV-T8/2P (w/timer & safety switch)	97.50

CDC

5 1/4" 9409-DS/DD	225.00
TANDON	
5 1/4" TM100-1 SS/DD 160K	150.00
5 1/4" TM100-2A FOR IBM-PC DS/DD (320 K)	225.00
TM101-4 (96 TPI Quad Den)	339.00
8" TM848-2 (DS/DD) 1.2 MG	400.00
SIEMAN'S	
8" FD100-8 (SS/DD) 110V/801 R)	189.00
8" FD100-8 (SS/DD) 220V (Compatible)	199.00
MPI	
5 1/4" B-51 40TR SS/DD 180 K	145.00

CONNECTORS

RS232 Connectors SOLDER TYPE	
DB25P	2.50
DB25S	3.00
DB25 Hood	1.00
S-100 Connectors	10 for 25.00
DE9P	2.00

DISK DRIVE CABINETS

8" CABINETS

8" DDC88V28 w/PS vertical for 2-8" drives	269.00
8" DDC88T-1 w/PS vertical-for 2 or 4-8" thinline drives	269.00
8" DDC88T-2 w/PS vertical for 2 or 4-8" thinline drives	200.00
8" DDC8H w/PS horizontal for 1 ea. 8" drive	249.00
8" DDC8V w/PS vertical for 1 ea. 8" drive	249.00
8" DDC8H w/PS horizontal for 2-8" drives	269.00

5 1/4" CABINETS

5 1/4" DDC5H w/PS horizontal-for 1-5 1/4" drive	55.00
5 1/4" DDC5V w/PS vertical-for 1 ea. 5 1/4" drive	65.00
5 1/4" DDC55V w/PS vertical-for 2-5 1/4" drives	85.00

DISK SUB ASSEMBLY

OUR BEST BUY'S

8" SUB ASSEMBLY	
DDS + O 2EA SS/DD Siemens FD100-8 Drives w/Cabinet	593.00
DDS + 2 2EA DS/DD Mitsubishi M2894-63 w/cabinet	1,073.00
DDS + 4 2EA DS/DD 8" Thinline Drives w/Cabinet	1,150.00
Specify—Vertical or Horizontal Cabinet	
5 1/4" SUB ASSEMBLY	
DDS + 5 1EA SS/DD Disk Drive	203.00
DDS + 6 2EA SS/DD Disk Drive	363.00

MODEMS

★ Hayes Smart 300	199.00
★ Hayes Smart 1200	425.00
Multi-Tech MT 212 AD (1200/300)	475.00
Novation J-Cat 300	109.00
U.S. Robotics 212A Auto Dial	469.00
★ U.S. Robotics (300/1200) Password	375.00

DISKETTES

5 1/4" Soft Sector SS/DD	18.00/10
FOR APPLE, ETC.	
5 1/4" Soft Sector DS/DD	24.00/10
FOR IBM PC & PARTNERS FOR QTY OF 100 (15% DISCOUNT)	

Diskettes are 3m media/processed, packaged and certified by CENTECH. Lifetime warranty—5 colors in each pkg. (Red, Yellow, Blue, Green, Brown)

5 1/4" Sgl side/dbl den	22.00/10
5 1/4" Dbl side/dbl den	29.00/10
5 1/4" 10 sector	24.00/10
5 1/4" 16 sector	24.00/10
8" Sgl side/dbl den	30.00/10
8" Dbl side/dbl den	40.00/10

MAXELL

Sgl. side/dbl. den	24.00
Dbl. side/dbl. den	36.00
Dbl. side/quad den	45.00
MEMOREX	CALL
TDK	CALL

DISKETTE STORAGE

AA-5 1/4" (Holds 82 Disks)	17.00
AA-8 (Holds 82 Disks)	26.00
Smoked Plexiglass Disk Tubs	
LIBRARY CASES	
CAS-5 1/4" Colors Available; color burst asst.	2.50
CAS-8" beige, black, blue, red, gray	3.00
Color Burst (Pack of 5)	12.00
FLIP "N" FILE	
Flip "N" File 25-5 1/4" (holds 25) w/lock	21.00
50-5 1/4" (holds 50) w/lock	27.95
Flip "N" File "Original-5" (holds 50)	21.00
Flip "N" File "Original 8" (holds 50)	29.95

VIDEO DISPLAY MONITOR

AMBER

Dynax AM121 (20 MHZ) Hi-Res/80 Col/12"	129.00
USI PI-4 (20 MHZ) Hi-Res/80 Col/12"	119.00
USI PI-3 (20 MHZ) Hi-Res/80 Col/12"	149.00
Zenith ZM122 (18 MHZ) Hi-Res/80 Col/12"	109.00

COLOR

Amdek I-12" Composite (For Apple)	239.00
Amdek II-12" RGB (For IBM-PC) w/audio	439.00
Amdek I + Composite w/audio	279.00
★ Princeton HX-12-RGB (For IBM-PC)	439.00
Sakata SC-100-13" Composite (For All)	239.00
Sakata SC-200-RGB (For All)	439.00

GREEN

BMC 12AU (15 MHZ) 80 Col/12"	139.00
Dynax GM 120 (20 MHZ) Hi-Res/80 Col/12"	129.00
Sanyo DM 2112 (15 MHZ) 64 Col/12"	139.00
Sakata SC-1000 (18 MHZ) 80 Col/12"	119.00
USI PI-1 (20 MHZ) Hi-Res/9"	129.00
USI PI-2 (20 MHZ) Hi-Res/12"	139.00

S-100 PRODUCTS

CARD CAGES/MOTHER BOARDS

*IEEE-696-No termination required

Slots	Bare Bd	A + T	w/cage	bare card	cage
4	15.00	40.00	60.00	20.00	
6	20.00	48.00	70.00	22.00	
8	25.00	69.00	100.00	31.00	
12	30.00	99.00	140.00	41.00	
18	45.00	150.00	200.00	50.00	
22	60.00	185.00	—	75.00	

All card cages will accommodate a 4" fan
Add \$20.00 for 1 fan-Add \$30.00 for 2 fans

CLOCK/CALENDAR

S-100 Time in hrs., min., sec. *AM/PM or Military Format*Date in Mo., Day, Yr., Day of Week & Leap Year recognition w/hard interrupts (1024 Hz, 1 Hz, 1 min, 1 hr)*On board battery (will last 14 mos. w/no power on)

QTC-CCS-BB (S-100)	45.00
QTC-CCS-A (A + T) for S-100	95.00

MAINFRAMES

For 2 Standard 8" Drives	
MF + DD6 (6 slot M/B)	575.00
MF + DD8 (8 slot M/B)	625.00
MF + DD12 (12 slot M/B)	675.00
For 2 Thinline 8" Drives	
IMF + DD6F	300.00
For 2 5 1/4" Disk Drives	
MF + MD12 (12 slot M/B)	560.00
Standard Plain Front	
MF + 12 (12 slot M/B)	499.00
MF + 22 (22 slot M/B)	550.00

All mainframes except IMF + DD6F have EMI filter, 2 AC outlets, 15 ea. DB25, 2 ea. 50 pin, 2 ea. 34 pin, 1 ea. Centronic cutouts, power supply for 8" MF (-5V1A/+5V6A/+8V16A/+16V3A/+24V6A)

SIERRA DATA

SDS-SBC-100-Z80 (4mhz) master 2 serial 2 par/floppy controller/64k ram	\$655.00
SDS-SBC-100S4mhz slave/2 serial 2 par/64k ram	\$565.00
SDS-ZSIO/4-4 serial port I/O bd	\$250.00
SDS-MUX-RS232 multiplexer bd	\$235.00
SDS-HDI-M-Hard disk bd for micropolis	\$129.00
SDS-CPM/B105-cp/m for SBC100 w/BIOS	\$150.00
SDS-Turbodos-Multi-user for master & slaves	\$645.00

CPU/MEM/I/O

QTC-SBC 2/4 BB (SBC880)	\$399.00
QTC-SBC 2/4 A A + T (SBC880)	\$239.00
QTC-Z + 80 BB (BIG Z)	\$239.00
DYNAMIC (64K/256K or 1 MEG)	
QTC-EXP + III Bare Bd. (CT256)	\$79.00
QTC-EXP + III 64K A + T (CT256)	\$379.00
QTC-I/O + BB 2 SER 2 PAR A + T	\$59.00
QTC-I/O + A + T	\$39.00
QTC-ADA ADA Converter A + T	\$49.00
QTC-Dual GPIB-488 IEEE 488 Interface bd.	\$79.00
Interfacer 2	249.00
Interfacer 3	519.00
Interfacer 4	329.00
System Support	309.00
Active Terminator	69.00
Enclosure 2 (Desk)	729.00
Enclosure 2 (Rack MT)	779.00
CPU-Z	229.00
CPU-Z	229.00
M-Drive H	1,229.00
6 Slot MB	129.00
12 Slot MB	159.00
CPU 68K	519.00

COMPUTIME/QT BARE BOARD SET

PN-2048 Best Bare Board Set Available	
QTC-SBC 2/4 CPU (SBC 880)	
QTC-EXP + III 256K (CT256) Memory bd./Expandable to 1MG	
QTC-FDC 5/8 Floppy disk controller	

Bare Board Set \$150.00

- 1) Includes manuals & assembly instructions
- 2) Parts available
- 3) Monitor & B10S available. Add \$30.00.

COMPUPRO

20 Slot MB	225.00
CPU 8085/88	349.00
CPU 8086/8087	550.00
Disk I	399.00
CPM 2.2 for Disk I	150.00
Disk II	610.00
Ram 16-64K	339.00
Ram 17-64K	329.00
Ram 21-128K	650.00
Interfacer 1	198.00

Circle 172 on inquiry card.

CUSTOMER SERVICE
CLAIRE
1-801-972-2739

The Great Salt Lake
Computer Company, Inc.

1-801-972-2717

Retail Sales
123 East 200 South
Salt Lake City, Utah 84111
Retail Hours
Monday-Friday 10 AM to 6 PM
Saturday 10 AM to 5 PM
Retail Phone — 364-0057

TO BUY FROM YOUR

CALIFORNIA RESIDENTS SAVE 6% SALES TAX

8 YEARS (1976) EXPERIENCE IN COMPUTER MAIL ORDER BUSINESS

PRINTERS

ALPHACOM

- FOR ATARI, COMMODORE or TI.
- 40 or 80 COL.
- 80 CPS
- FULL CHARACTER SETS
- GRAPHICS
- LIGHT WT. 4 TO 6 LBS.
- FRICTION FEED



ALPHACOM 42 (40 col) w/interface	89.00
ALPHACOM 81 (80 col) w/interface	149.00
40 COL PAPER (per roll)	2.80
80 COL PAPER (per roll)	4.50

BROTHER

HR-1A 17CPS Daisywheel 3K Buff	575.00
HR-1A 17CPS Daisywheel 3K Buff	589.00
HR-25	

CENTRONICS

351P—200CPS, Par 100 CPS CORR.	1,795.00
6085P—600CPS, Par w/cabinet	6,500.00
6085S—600CPS, Serial w/cabinet	7,000.00
6085IBM—600CPS w/cabinet	7,500.00
358 3 or 4 Automatic cut sheet feeder	695.00

DATA-SOUTH

DS 180 180CPS/Serial or Par/Tractor	1,400.00
-------------------------------------	----------

DAISYWRITER

Daisywriter 2000-48K Buffer/20T040CPS LTR/Par	1,095.00
Daisywriter Cable	40.00
Daisywriter Tractor	140.00

DIABLO

620 (25CPS/Serial)	920.00
630 (40CPS/Multi-IF)	1,790.00
630 ECS/IBM	2,100.00

DYNAX

Dynax-15 Par-13CPS Daisywheel	
2 color PTG-3K buff	475.00
Dyanx 15 Serial-13CPS Daisywheel	525.00

EPSON

FX80 (160 CPS-Par 10")	CALL
FX100 (160 CPS-Par 15")	CALL

C. ITOH

Pro-writer I (8510A) Par 120 CPS	350.00
Pro-writer I (8510A) Serial 120 CPS	529.00

Pro-writer II Parallel-15"	669.00
8600 (180CPS) Par or Serial 18 PIN 90 CPS LTR	1,099.00
F-10 40CPS/Diablo/Par or Serial	1,125.00
F-10 55CPS/Diablo/Par or Serial	1,425.00

GENERAL ELECTRIC

Demand Document Printers	
3400—400CPS Serial/Tractor to 60 100 CPS CORR.	2,175.00
3404—400CPS Serial/Tractor 100CPS CORR.	2,459.00

JUKI

6100-18 CPS/Diablo Compatible Par/Daisywheel	569.00
--	--------

MANNESMAN-TALLY

Spirit 80CPS Par 10"	330.00
160L (160CPC-40CPS LTR 10")	589.00
180L (160CPS-40CPS LTR 15")	829.00

MPI

MPI-Portable Sprinter/160CPS/IBM Port/4K Buff. up to 64K 100 CPS CORR. Keyed avb.	795.00
MPI-99G (9") Par	499.00
MPI 150 BI (15") Par 2K Buff w/Graphics	675.00
MPI 150 AI (15") Par 4K Buff w/Graphics	799.00
MPI 150 AI (15") Par 16K Buff w/Graphics	899.00

NEC

NEC2010 20CPS Serial Daisywheel	950.00
NEC2015 20CPS Diablo Comp Daisywheel	950.00
NEC2030 20CPS Par Daisywheel	950.00
NEC2050 20CPS for IBM Daisywheel	1,050.00
NEC3510 35CPS Par Daisywheel	1,595.00
NEC3550 35CPS IBM	1,850.00
NEC7710 55CPS Serial Daisywheel	1,995.00
NEC7715 55CPS Diablo Comp Daisywheel	1,995.00
NEC8023A 100CPS-Par-Graphics-10"	389.00
NEC8025A 100CPS Par Graphics 15"	699.00
Serial Card	139.00

OLYMPIA

Typewriter/Printer Daisywheel 14 CPS	649.00
--------------------------------------	--------

OKI-DATA

2350—350CPS 2 color tractor	2,195.00
2410P 350CPS 2 color tractor	2,495.00
Microline 82A (SER & PAR-120CPS 10")	379.00
Microline 83A (SER & PAR-120CPS 15")	625.00
Microline 92 (PAR-160CPS-LTR-10")	459.00
Microline 93 (PAR-160CPS-LTR-15")	789.00
Microline 84P (PAR-200CPS-LTR-15")	999.00
Microline 84S (SER-200CPS-LTR-15")	1,059.00

STAR MICRONICS

Gemini 10X NEW VERSION (PAR-120CPS-10")	CALL
Gemini 15X (PAR-120CPS-15")	CALL
Gemini Delta 10 (Par-160CPS-10" 8K buffer serial)	CALL

SILVER REED

EXP 550P-17CPS Daisywheel-PAR	669.00
EXP 550S-17CPS Daisywheel-Serial	669.00

TOSHIBA

P-1350 (192CPS-120CPSLTR PAR or Serial)	1,499.00
---	----------

TRANSTAR

120 P 14CPS Par Diablo Comp.	479.00
315 Color Printer 500CPS Par	489.00

PRINTER ACCESSORIES

DIABLO

Diablo 620-Uni-Direct Tractor	110.00
Diablo 620-Sheet Feeder	720.00
Diablo 630-Bi-Direct Tractor	275.00
Diablo 630-Tractor Sound Cover	29.00
Diablo 630-SGL Sheet Feeder	775.00

JUKI-6100

Serial Interface	55.00
Bi-Dir Tractor	120.00
Uni-Dir Tractor	90.00

MANNESMAN-TALLY

Factory Quick Tear	230.00
Auto Front Feed	1,150.00

NEC

Thimbles	20.00
Vertical Tractor	219.00
Horizontal	152.00
Bi-Dir. Tractor	330.00
Cut Sheet Feeder	1,100.00

OKI-DATA

84 Cut Sheet Feeder	515.00
82/92 Tractor	55.00
Serial Intf. w/2K Buffer (For 82A)	115.00
Serial Intf. w/2K Buffer (For 92 & 93)	120.00
Okigraph I 82A or 83A Graphics ROM	40.00
Okigraph II 82A or 83A Disk for Apple	55.00

STAR-MICRONICS

Serial Intf. Bd	70.00
Serial Intf. Bd w/2K Buffer	120.00
Commodore 64 Intf. Bd.	72.00

TOSHIBA

P-1350 Cut Sheet Feeder	800.00
P-1350 Bi-Dir. Tractor	210.00

SYSTEMS

APPLE/FRANKLIN

APPLE II E Starter—Includes CPU 1 F.D. Monitor and Stand	1,475.00
FRANKLIN 1000 w/color	799.00
FRANKLIN 1200 Starter includes CPU 2 F.D. 80 col.	1,825.00
FRANKLIN 1200 OMS includes CPU-2 F.D. and bundled software	1,825.00

IBM*PC TYPES

COLUMBIA (1600-1) 16 bit 128K Ram 2 ea. 320K Disk Drive-2 SER, 1 PAR, Key Bd. 8 slots, Display Cd., bundled software	2,775.00
IBM P.C. 16 bit 64K Ram 2 ea. 320 K Disk Drive, Princeton HG12X-Color Card	3,395.00
EAGLE PC-2 16 bit 128K Ram 2 ea. 320K Disk Drive 12" Green (HH-Res) bundled software	2,650.00
EAGLE PORTABLE 16 bit 128K Ram 1 F.D./10 MG HD/Green Screen MS-DOS 210 bundled software	4,000.00

KAYPRO

KAYPRO II w/bundled software	1,475.00
KAYPRO 4 w/bundled software	1,875.00
KAYPRO 10 w/bundled software	2,695.00

(Trade-in Allowance \$75 for SS/DD Drive)

MOLECULAR SYSTEMS

MICRO 10-8 16 bit (8086) CPU 1 ea. 8" F.D.—1 ea. 10 MB HD—64K Ram expands to 256K up to 8 users w/additional application processors—CP/M and CP/M 86	5,200.00
--	----------

MICRO 15-8 16 bit (8086) CPU 1 ea. 8" F.D.—1 ea. 15 MB HD—64K Ram expands to 256K up to 8 users w/additional application processors—

CP/M and CPM 86	6,800.00
AP 8001—ASYNC/9600 BPS Application Processor	589.00
AP 8003—ASYNC/19,200BPS Application Processor	839.00
AP8011—SYNC/50K BPS	1,079.00

NEC

PC8201A-Portable 2.4 MHz CPU 16K Ram/Expands to 64K-32K RAM LCD Display—Keybd (67 key-5 function) Modem, Serial and Par Port-FD and Cassette Interface—Uses 4 AA Batt—bundled software	660.00
PC8201A-90—N1 Cad Pak	16.00
PC8221A—Portable Printer	149.00
PC8271A-02—AC Adapter	15.00

S-100

COMPUPRO 816A	4,125.00
COMPUPRO 816B	5,495.00
COMPUPRO 816C	6,995.00

TELEVIDEO

TS-803 4 MHz CPU-64K 2 ea. 360K F.D.—Graphics 12" green	1,900.00
TS-1603 5 MHz CPU-128K 2 ea. 360K F.D.—Graphics 12" Green CP/M	2,400.00
TELETOTE 1 4 MHz CPU 64K 1 ea. F.D. 9" Amber detach KYBD Par/Ser mouse port CP/M	1,350.00

TERMINALS

ADDS

Viewpoint-A1 (White)	509.00
Viewpoint-A2 (Green)	539.00
Viewpoint-3A + (Green)	509.00
Viewpoint 60-Same as Televideo 925	715.00

QUME

QVT-102 80 Col. Green (910 comp)	549.00
QVT-102 80 Col. Amber	560.00
QVT-103 80/132 Col. Green	885.00
QVT-103 80/132 Col. Amber	895.00
QVT-108 80/132 Col. Amber (925 Corp.)	715.00

TELEVIDEO

TV910	529.00
TV910 +	585.00
TV925 w/2nd page memory	715.00
TV950 w/2nd, 3rd, 4th page memory	925.00
TV970	1,019.00
RG1000/TV60 Graphics Upgrade for 925/950	1,100.00

WYSE

WYSE-100	725.00
WYSE-300 (Color)	1,125.00



TOLL FREE
1-800-545-2633

CONTINENTAL U.S.

Circle 173 on inquiry card.

The Great Salt Lake
Computer Company, Inc.

1-801-972-2717

Mail Orders
P.O. Box 3150
Salt Lake City, Utah 84110
Mail Orders
Monday-Friday 8 AM to 6 PM
(sometimes much later)
Saturday 10 AM to 5 PM

COMPUTER SUPERMARKET

OUR SALTIER DEAL

TRADE YOUR 5 1/4" DRIVE

SGL SIDE/DBL DEN FOR DBL SIDE/
DBL DEN DRIVE \$75.00 ALLOWANCE

DBL SIDE/DBL DEN FOR 2 EA
(TM100-2) FOR 1/2 DBL SIDE/DBL
DRIVES \$175.00 ALLOWANCE

IBM ACCESSORIES

AST	
Six Pak Plus (Serial/Par/CLK 64K Expands to 384K)	289.00
Meg-A-Plus (Serial/CLK/64K Expands to 256K)	269.00
Meg-A-Pak (Expands Meg-A-Plus to 512K)	269.00
I/O Plus (SP)	129.00
PC-Net (with Shared User Software)	556.00
PC-Net Starter Kit	1,192.00
AST-5251 (Allows connection of IBM PC to System 340038)	626.50

MANY OTHER OPTIONS AVAILABLE.

ASHTON-TATE

D-Base II	400.00
Bottom Line Strategist	279.00
Financial Planner	499.00
Friday	189.00

DOW JONES

Dow Jones Invest/Evaluator	125.00
----------------------------	--------

D.C. HAYES

Smartmodem 1200B-Smartcom 2 software included	429.00
Smartcom 2-Telecomputive for 300/1200 on disk	89.00

LOTUS DEVELOPMENT

Lotus 1-2-3 (on disk)	369.00
-----------------------	--------

KRAFT

Joy Stick	47.50
Paddle (pair)	37.00

KEYTRONICS

Enhance your PC-with a superior keyboard	210.00
--	--------

MAYNARD

Floppy Controller	155.00
Floppy Controller (Serial)	225.00
Floppy Controller (PAR)	205.00

MODULAR ADD-ONS FOR SANDSTAR MOD-FDC

Sandstar MOD-FDC (for 5 1/4" or 8" drives)	200.00
Pararell MOD	60.00
Serial-MOD	79.00
Clock Calendar MOD	69.00
Game Adapter MOD	49.00

Sandstar Multi-Function Bd (Holds up to 6 modular add-ons)	82.00
--	-------

PLANTRONICS COLOR PLUS

Color + Color Display Card (16 colors)	395.00
--	--------

PRINCETON GRAPHICS

PGS HX12-Hi-Res Color, The Best	469.00
---------------------------------	--------

QUADRAM

Quadlink—Allows Apple Software to be used in IBM PC HAS 64K Ram-Game Port Display Gen-Disk Intf. w/software	520.00
Quadboard 2—64K Ram (expands to 256K) 2 Ser Port CLK and software	289.00
Quadboard — 64K (expands to 256K) Par and Serial Port CLK and software	289.00
Quad 512 — 64 Ram (expands to 512K) Serial Port and software	258.00
Quadchrome — Color Monitor	489.00
Tilt Table	40.00
Chronograph Clk/Calendar BD.	79.00

SHUGART DISK DRIVES

SA455L-1/2 HGT 320 K DS/DD w/BRACKETS	239.00 ea.
	440.00 for 2 ea.

TANDON DISK DRIVES

TM100-2A 320K DS/DD	225.00
TM55-2 1/2 HGT 320 K DS/DD w/BRACKETS	249.00 ea.
	440.00 for 2

APPLE/FRANKLIN ACCESSORIES

ALS

CPM 3.0 Card	289.00
Z-Card II	139.00

ASHTON-TATE

D-Base II	400.00
-----------	--------

ASTAR

RF Modulator	19.00
Fan, Clock, Cool Time, Surge Protector	80.00

DOW JONES

Dow Jones Invest/Evaluator	125.00
----------------------------	--------

GENERIC

Z-80 Card (Emulates Micro-Soft)	99.00
80 Col. Video (Videx Compatible)	99.00
80 Col. Video w/Soft Switch	125.00
Joy Stick	20.00
E-Prom Writer	79.00
Pararell Interface	49.00
Pararell Interface w/Graphics	65.00
16K Ram Card	40.00
RF Modulator	13.00

HAYES

Joy Sticks	29.00
Micro-Modem II	259.00
Micro-Model II w/terminal package	279.00

KENSINGTON

System Saver/Fan & Surge Pro	75.00
------------------------------	-------

KOALA TECH

Koala Gr/Tablet w/Software	99.00
----------------------------	-------

KRAFT

Joystick for II E	44.00
-------------------	-------

LOTUS DEVELOPMENT

Executive Briefing System	139.00
---------------------------	--------

MICRO-MAX

View Max 80 (80 Col for II +)	139.00
View Max 80E (80 Col w/64K Memory Exp to 128K)	129.00

MICROTEK

Dumpling 64K/Interface and Graphics 64K Buffer	235.00
Dumpling GX-P/Par Interface Card and Cable	99.00
Parallel Interface Board (RV611C)	61.00
BAM 16 (16K Add-on Memory)	45.00

NOVATION

Apple Cat II w/software	269.00
212 Apple Cat	625.00
Handset	29.00

ORANGE MICRO

Grappler + (Graphics Interface)	119.00
Grappler + 16K (Buffer and 5 to 64K)	175.00
Buffer Board	135.00

PRINCETON GRAPHICS

Interface Card allows use of HX12 Color Monitor	156.00
---	--------

QUADRAM

RAM 80—80 Col 64K card	119.00
APIC—Par Intf. card	60.00
APIC/G—Par Intf. w/Graphics	65.00
CPI—8" Cable (APIC to Cen. Printer)	34.00
APIC III—Par Printer Intf. for Apple w/8" Cable	95.00

TG PRODUCTS

Joy Stick—For Apple II +	38.00
Paddles	29.00
Selecta Port	38.00

VIDEX

Ultraterm	279.00
Videterm	199.00

VISTA

A800 Floppy Controller for 8" Drives	300.00
A-800-1 Cable	27.00

APPLE DISK DRIVES

Vista Solo (35TR)	189.00
Micro-Sci A-2 (35TR)	225.00
Micro-Sci A-40 (40TR)	269.00
Micro-Sci A-70 (Quad)	329.00
Micro-Sci Controller	70.00
Rana Elite I	249.00
Rana Elite II	399.00
Rana Elite III	509.00
Rana Controller	85.00
Super 5 "THINLINE" / size 163K 40TR	189.00
Super 5 "THINLINE" 1/2 size 163K 40TR (TEAC DIRECT DRIVE)	225.00

ATARI

KRAFT Joy Stick	15.00
PERCOM AT 88 SS/DD Disk Drive w/Printer Port	499.00
RANA Rana 1000—SS/DD Disk Drive	379.00
TRAK AT-D2 SS/DD Disk Drive	379.00

COMMODORE

STAR Star Gemini Interface to VIC 20 + CMD 64	65.00
DOW JONES Dow Jones Invest/Evaluator	125.00
KRAFT Joy Stick	15.00
KOALA Koala GR/Tablet w/software (specify VIC20 or CMD64)	99.00

KAPRO II — IV

Sprinter K (5MHZ Speed-up)	99.00
K-Clock (Batt Backup Clk/Cat)	99.00
Video Output BD(allows use of video monitor)	125.00
Kaypro II Upgrade Disk Drives (DS/DD)	239.00
(Trade in Allowance \$75 for SS/DD Drive)	

TI-PROFESSIONAL

LOTUS 1-2-3	369.00
QUADRAM TI-64 64K Ram Card	206.00
QUADRAM TI-92 192K Ram Card	319.00

WESPER

WIZARD BPO (Same as Grappler + 16K Specify Printer)	149.00
WIZARD IPI (Same as Grappler + Specify Printer)	89.00
WIZARD EBO (Internal Buffer for Epson)	109.00
WIZARD 80 Col/64K For II E	139.00
WIZARD 80 Col/For II +	139.00

IBM UP-GRADE KIT

Includes 9 Ea. 4164-200NS
For Expansion on all IBM
Products with Parity
\$55.00/per set



TOLL FREE
1-800-545-2633
CONTINENTAL U.S.

Circle 173 on inquiry card.



1-801-972-2717

Retail Sales
123 East 200 South
Salt Lake City, Utah 84111
Retail Hours
Monday-Friday 10 Am to 6 PM
Saturday 10 Am to 5 PM
Retail Phone — 364-0057



VOICE SYNTHESIZER FOR APPLE AND COMMODORE



JE520CM

• Over 250 word vocabulary - affixes allow the formation of more than 500 words • Built-in-amplifier, speaker, volume control, and audio jack • Recreates a clear, natural male voice • Plug-in user ready with documentation and sample software • Case size: 7 1/4" L x 3 3/4" W x 1-3/8" H

APPLICATIONS:

- Security Warning
- Teaching
- Instrumentation
- Telecommunication
- Handicap Aid
- Games

The JE520 VOICE SYNTHESIZER will plug right into your computer and allow you to enhance almost any application. Utilizing National Semiconductor's DIGITALIZER™ Speech Processor IC (with four custom memory chips), the JE520 compresses natural speech into digital memory, including the original inflections and emphasis. The result is an extremely clear, natural vocalization.

Part No.	Description	Price
JE520CM	For Commodore 64 & VIC-20	\$114.95
JE520AP	For Apple II, II+, and IIe	\$149.95

Micro-Logic Corp. MICRO-CHARTS



• Fully decoded data • Instant access • 2-sided, totally comprehensive • Compact 8 1/2 x 11 in. durable credit card plastic • Perfect for programmers & engineers • Clear & concise tables for: full instruction set, disassembly, ASCII, base conversion, effect of flags, compare vs. jump, interrupt structure, pinout, cycle times, diagrams, loop notes, & much more.

PART NO.	REFERENCE	PRICE
ML-Z80	Z80 CPU	\$5.95
ML-8080A	8080A/8085A	\$5.95
ML-6502	6502 (65XX)	\$5.95
ML-8048	8048, Relatives	\$5.95
ML-7400	5400/7400 TTL Pin-Outs	\$5.95
ML-ALGO	Basic Algorithms	\$5.95

BOOKS

30001	National CMOS Data Book (1981) (840 pages) 74C, CD4000, and A/D Converters	\$6.95
30003	National Linear Data Book (1982) (1376 pages) LM, LF, DAC, ADC, LH Series	\$11.95
30008	National Memory Data Book (1980) (464 pages) RAMs, ROMs, PROMs, EPROMs Series	\$6.95
30009	Intel Data Book (1983) (1356 pages) Complete lines	\$9.95
30010	National Audio/Radio Handbook (1980) (240 pages) Pre-Amps, AM, FM & FM Stereo, Power Amps	\$5.95
30012	National PAL Data Book (1982) (176 pages) Application Notes, Linear Briefs, etc.	\$5.95
30013	Zilog Data Book (1983) (841 pages) Microprocessors and Support Chips	\$7.95
210830	Intel Memory Components Handbook (1983) (798 pages) Contains all Application Notes, Article Reprints, Data Sheets, and other design information on Intel's RAMs, EPROMs, EEPROMs & Bubble Memories.	\$14.95
210844	Intel Microprocessor & Peripheral Handbook (1983) (1027 pages) Contains Data Sheets on all of Intel's Microprocessors and Peripherals.	\$14.95

4-Digit Fluorescent Alarm Clock Kit



• Bright 4-digit 0.5" high display • 10 minute snooze alarm • AM/PM indicator • Automatic display dimmer

The JE750 Clock Kit is a versatile 12-hour digital clock with 24-hour alarm. The clock has a bright 0.5" high blue-green fluorescent display. The 24-hour alarm allows the user to disable the alarm and immediately re-enable the alarm to activate 24 hours later. The kit includes all documentation, components, case and wall transformer. Size: 6-5/8" L x 3 1/4" W x 1 1/8" H.

JE750 Alarm Clock Kit \$29.95

Jameco Digital Thermometer Kit

Dual sensors - switch controls for indoor/outdoor or dual monitoring - can be extended to 500 feet. Continuous LED 8" ht. display. Range: -40°F to 190°F, -40°C to 100°C. Accuracy: ±1° nominal. Calibrate for Fahrenheit/Celsius. Simulated wound case. AC wall adapter included. Size: 9 1/2" L x 3 1/4" W x 1 1/2" H.

JE300 \$39.95

Universal Computer Keyboard Enclosures

"DTE" Blank Desk-Top Enclosures are designed for easy modification. High strength epoxy molded and pieces in machinable finish. Sliding rear/bottom panel for service/component access. Top/bottom panels (0.60" thick alum. anodized type 1200 finish (gold tint color) for best paint adhesion after modification. Ventured top & bottom panels for cooling efficiency. Rigid construction provides unlimited applications. Assembly instructions included.

DTE-8	Panel Width 7.5"	\$24.95
DTE-11	Panel Width 10.75"	\$27.95
DTE-14	Panel Width 13.5"	\$29.95
DTE-20	Panel Width 19.25"	\$34.95
DTE-22	Panel Width 21.375"	\$39.95

CARD-EDGE CONNECTOR

Mates with double-sided 1/16" PC board with contact pitch of 100 mil centers

Part No.	No. of Contacts/Connectors	1-8	10-99	100+
C20	20	3.39	2.89	1.89
C25	25	3.89	3.29	2.09
C34	34	3.29	2.95	2.59
C40	40	3.89	3.29	2.89
C50	50	4.39	3.95	3.39

SOCKET CONNECTORS

Mates with 2 rows of 125 mil sq. or dia. posts on pattern of 100 mil centers and shielded receptacles

Part No.	No. of Contacts/Connectors	1-8	10-99	100+
S20	20	1.39	1.25	1.00
S25	25	1.59	1.40	1.20
S34	34	2.09	1.79	1.50
S40	40	2.29	2.00	1.70
S50	50	2.59	2.29	2.00
S60	60	3.39	2.95	2.59

SOLDER TRANSITION CONNECTORS

FOR PERMANENT TERMINATION TO PRINTED CIRCUIT BOARDS

Part No.	No. of Contacts	1-8	10-99	100+
ST20	20	1.15	.99	.80
ST25	25	1.25	1.15	.99
ST34	34	1.49	1.35	1.15
ST40	40	1.89	1.75	1.55
ST50	50	1.99	1.85	1.49

MALE CONNECTOR

Mates with Socket Connector 10" x 10"

Part No.	No. of Contacts/Connectors	1-8	10-99	100+
M20	20	4.99	3.65	3.11
M25	25	4.49	3.95	3.49
M34	34	4.99	4.49	3.95
M40	40	5.49	4.89	4.39
M50	50	6.49	5.75	4.99

36-Pin CENTRONICS RIBBON CONNECTORS

Part No.	No. of Contacts/Strips	1-8	10-99	100+
CEN14M	14 Male	6.29	5.45	4.49
CEN14F	14 Female	6.19	5.29	4.29
CEN24M	24 Male	7.95	6.95	5.85
CEN24F	24 Female	7.69	6.79	5.75
CEN36M	36 Male	8.99	7.99	6.69
CEN36F	36 Female	8.75	8.05	7.95

24-Pin IEEE488 RIBBON CONNECTORS

Part No.	No. of Contacts/Strips	1-8	10-99	100+
IEE14M	14 Male	6.29	5.45	4.49
IEE14F	14 Female	6.19	5.29	4.29
IEE24M	24 Male	7.95	6.95	5.85
IEE24F	24 Female	7.69	6.79	5.75
IEE36M	36 Male	8.99	7.99	6.69
IEE36F	36 Female	8.75	8.05	7.95

28AWG FLAT GREY CABLE

Part No.	No. of Contacts/Strips	Connector & Wire Type	Price Per Foot
171-9	9	28AWG Flat Stranded	19
171-14	14	28AWG Flat Stranded	25
171-15	15	28AWG Flat Stranded	27
171-18	18	28AWG Flat Stranded	29
171-20	20	28AWG Flat Stranded	30
171-24	24	28AWG Flat Stranded	34
171-25	25	28AWG Flat Stranded	47
171-28	28	28AWG Flat Stranded	49
171-34	34	28AWG Flat Stranded	62
171-36	36	28AWG Flat Stranded	65
171-37	37	28AWG Flat Stranded	68
171-40	40	28AWG Flat Stranded	75
171-50	50	28AWG Flat Stranded	95

CUSTOM ASSEMBLIES

Use the part numbers from the connectors and cable to order your own custom assembled cables.

EXAMPLE: If you desire a 25-foot cable with a "Centronics" connector on one end, and a "Serial" connector on the other end, you would order:

CEN24M-25-IEE24F CUSTOM \$18.44

8 x 25 (25 feet 28 gauge cable) = \$18.25

2 28 AWG Flat 28 inch cable = \$ 2.50

This CEN24M-25-IEE24F CUSTOM Cable would cost \$39.19

Please specify "CUSTOM" after the part no. to ensure your order will be filled correctly. (Important: Please specify cable in FEET, not inches)

ALL CUSTOM ASSEMBLIES MUST BE PREPARED BEFORE ASSEMBLY. THERE ARE NO RETURNS ON CUSTOM CABLE ASSEMBLIES. \$1.00 SET-UP CHARGE, PER STRIP, ON ALL CUSTOM CABLES.

ACCESSORIES FOR APPLE® COMPUTERS

Numeric/Auxiliary Keypad for APPLE II®

Computer Ready

The JE614 is a newly introduced numeric/auxiliary keypad for the APPLE II®. It offers the flexibility of a 10-key pad and the convenience of 22 directly accessible functions. Screen manipulating functions make word processing a snap and cursor controls make the keypad ideal for "VisiCalc" users. The JE614 Keypad is housed in a durable metal enclosure and is color-coordinated with your APPLE IIe computer. Operation of the keypad can begin within minutes from unpacking. Special functions include: Home, Clear, Clear to End of Screen, Scroll-Up, Scroll-Down, Tab, Delete, Left, Right, Up and Down. Each key has auto-repeat.

JE614 Assembled and Tested \$89.95

Extended 80 Column/64K RAM Card for APPLE II®

Now you can double the memory capacity and get an 80 column display format for your APPLE IIe computer at an affordable price. Just plug the JE604 card into your APPLE IIe and expand your display to 80 characters per line. Perfect for word processing. The JE604 will feature 64K bytes of additional memory to allow programming well beyond standard APPLE IIe computers.

JE604 Assembled and Tested \$149.95

Switching Power Supply for APPLE II, II+ and IIe®

Can drive four floppy disk drives and up to eight expansion cards • Quiet cooling and constant protection • 1/2 inch metal flange construction • Fully regulated • 10V @ 5A, 12V @ 2A, 15V @ 1A, 18V @ 1A • Automatic input selector • Input: 100V-240V, 50/60 Hz • Output: 110V @ 1.5A, 120V @ 1.5A, 150V @ 1.5A, 180V @ 1.5A • Weight: 3 lbs.

Part No. KHP4007 \$79.95

*APPLE and APPLE IIe are registered trademarks of Apple Computer, Inc. • "VisiCalc" is a registered trademark of Visi Corp. Inc.

Cooling Fan for APPLE II, II+ and IIe®

Single on the side of APPLE II, II+ and IIe enclosures • Eliminates overheating problems, thereby increasing reliability and operation life of computer • Fits on front of fan frames as shown in section view • Power and ground wire leads

Part No. APF-1 \$49.95

POWER SUPPLY +5VDC @ 7.5 AMP, 12VDC @ 1.5 AMP SWITCHING

Input: 115VAC 50-60Hz @ 3 amp/220VAC, 50/60 @ 1 amp. Fan volt./power supply select switch. Line reg. ±0.2%. Ripple: 30mV p-p. Load reg. ±1%. Overcurrent protection. Adj. 5V max out. 13 1/2" L x 3 1/2" W x 5 1/2" H.

Part No. PS94V05 \$39.95 each

POWER SUPPLY 4-Channel Switching - Apple Compatible

Microprocessor, mini-computer, terminal, medical equipment and process control applications. Input: 90-130VAC 47-440Hz. Output: +5VDC @ 5A, -5VDC @ 1A, +12VDC @ 1A, -12VDC @ 1A. Line reg. ±0.2%. Ripple: 30mV p-p. Load reg. ±1%. Overcurrent protection. Adj. 5V max out. 15 1/2" L x 6 3/8" W x 1 1/8" H x 4 1/2" H. Wt. 1 1/2 lbs.

Part No. PS4-504A \$69.95 each

\$10.00 Minimum Order - U.S. Funds Only
California Residents Add 6 1/2% Sales Tax
Shipping - Add 5% plus \$1.50 insurance
Send S.A.S.E. for Monthly Sales Flyer!

Spec Sheets - 30¢ each
Send \$1.00 Postage for your
FREE 1984 JAMECO CATALOG
Prices Subject to Change

1355 SHOREWAY ROAD, BELMONT, CA 94002
1/84 PHONE ORDERS WELCOME - (415) 592-8097 Telex: 176043

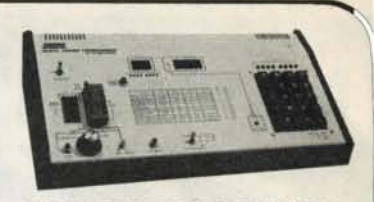

JE664 EPROM PROGRAMMER 8K TO 64K EPROMS - 24 AND 28 PIN PACKAGES

• Programs, validates, and checks for properly erased EPROMs • Emulates PROMs or EPROMs • RS232C computer interface for editing/program loading • Loads data into RAM by keyboard • Changes data in RAM by keyboard • Loads RAM from an EPROM • Compares EPROMs for content differences • Copies EPROMs • Power input: 115VAC, 60Hz, < 10W power consumption • Enclosure: Color-coordinated, light tan panels w/matched knobs brown and pieces • Size: 15-5/8" L x 8 1/2" D x 3 1/4" H, Wt.: 5 1/2 lbs.

JE664-A EPROM Programmer \$995.00
Assembled & Tested (includes JM16A Module)

JE665 - RS232C INTERFACE OPTION - The JE665 RS232C Interface Option implements computer access to the JE664's RAM. Sample software written in BASIC provided for TRS-800® Model I, Level II Computer, Bard, model 9600, Wordcrafter, 8-bit, odd parity, Stop bits: 2. Option may be added to other computers. The JE665 can be interfaced to any computer with an RS232C port. Information is also provided for interfacing to any CP/M system with an RS232C port.

JE664-ARS EPROM Programmer w/JE665 Option \$1195.00
Assembled & Tested (includes JM16A Module)

EPROM JUMPER MODULES - The JE664's JUMPER MODULE (Personality Module) is a plug-in Module that pre-sets JE664 for proper programming pulses to the EPROM & configures EPROM socket connectors for that particular EPROM

PIN	EPROM	EPROM MANUFACTURER	PRICE
JM16A	2708	AMD, Motorola, National, Intel, TI (25V)	\$14.95
JM16A	2716, TMS2516	Intel, Motorola, National, SEC, TI, (25V)	\$14.95
JM16B	TMS2716	Motorola, TI (+5, -5, +12)	\$14.95
JM32A	TMS2532	Motorola, TI (25V)	\$14.95
JM32B	2732	AMD, Fujitsu, NEC, Hitachi, Intel (25V)	\$14.95
JM32C	2732A (21V)	Fujitsu, Intel (21V)	\$14.95
JM44A	MCM56764, MCM56L764	Motorola (21V)	\$14.95
JM44B	2764	Intel (21V)	\$14.95
JM44C	TMS264	TI (25V)	\$14.95

UV-EPROM Eraser

8 Chips - 51 Minutes

1 Chip - 37 Minutes

Erases 2708, 2716, 2732, 2764, 2516, 2532, 2564. Erases up to 8 chips within 51 minutes (1 chip in 37 minutes). Maintains constant exposure distance of one inch. Special conductive foam liner eliminates static build-up. Built-in safety lock to prevent UV exposure. Compact - only 9.00" x 3.70" x 2.60". Complete with holding tray for 8 chips.

DE-4 UV-EPROM Eraser \$79.95

UVS-11EL Replacement Bulb \$16.95

5 1/4" APPLE™ COMPATIBLE DISK DRIVE

• Uses Shugart SA330 mechanics • 143K formatted storage • 5 tracks - compatible with Apple controller • Complete with controller card • Size: 6 1/2" L x 3 1/2" W x 8-9/16" D • Weight: 4 1/2 lbs.

Part No. ADD-514 \$195.95

8" FLOPPY DISK DRIVE

• Shugart 801R compatible • Single-Sided • 77 Tracks • 400/800 Bytes Capacity • Industry Standard

The FDD100-8 8" Floppy Disk Drive (Industry Standard) features single or double density. Recording mode: FM single, FM double density. Transfer rate: 250K bits/sec. single density; 500K bits/sec. double density. The FDD100-8 is designed to work with the single-sided soft sector IBM 486 format. Complete with controller card. Power: 115VAC @ 50-60Hz, ±24VDC @ 1.7 amps max., ±5VDC @ 1.2 amps max. Unit as pictured above does not include case, power supply, or cables. Size: 6.55" W x 14" L x 4.5" H. Weights 12 lbs. Incl. 96-egg manual.

FDD100-8 .. \$169.95 ea.

IBM MEMORY EXPANSION KIT

SAVE HUNDREDS OF \$\$\$ BY UPGRADING MEMORY BOARDS YOURSELF!

Most of the popular memory boards allow you to add an additional 64K, 128K, 192K, or 256K. The IBM64K Kit will populate these boards in 64K byte increments. The kit is simple to install - just insert the nine 64K RAM chips in the provided sockets and set the two groups of switches. Directions are included.

IBM64K (Nine 200ns 64K RAMs) \$49.95

EXPAND YOUR MEMORY

TRS-80 to 16K, 32K, or 48K
 **Model 1 = From 4K to 16K Requires (1) One Kit
 Model 3 = From 4K to 48K Requires (3) Three Kits
 Color = From 4K to 16K Requires (1) One Kit
 **Model 1 equipped with Expansion Board up to 48K - Two Kits Required - 1 Kit Required for each 16K of Expansion

TRS-16K3 *200ns for Color & Model III \$12.95
 TRS-16K4 *250ns for Model I \$10.95

TRS-80 Color 32K or 64K Conversion Kit

Easy to install kit comes complete with 8 ea. 4164-2 (200ns) 64K dynamic RAMs & conversion documentation. Converts TRS-80 computer with E circuit boards, & all new color computers to 32K. Minor modifications of 32K memory will allow the use of all the 64K of the dynamic RAM providing you have a FLEX DOS operating system.

TRS-64K2 \$44.95

Do Kay

COMPUTER
PRODUCTS,
Inc.

ORDER TOLL FREE

(800)

538-8800

(CALIFORNIA RESIDENTS)

(800)

848-8008



TERMS: For shipping include \$2.00 for UPS Ground or \$3.00 for UPS Blue Air. \$10.00 minimum order. Bay Area and Los Angeles Counties add 6½% Sales Tax, other California residents add 6% Sales Tax. We reserve the right to limit quantities and substitute manufacturer. Prices subject to change without notice.

VISIT OUR RETAIL STORE

2100 De La Cruz Blvd.
Santa Clara, CA 95050
(408) 988-0697

Do Kay

STATIC RAMS

2101	256 x 4 (450ns)	1.90
5101	256 x 4 (450ns) (cmos)	3.90
2102-1	1024 x 1 (450ns)	.88
2102L-4	1024 x 1 (450ns) (LP)	.98
2102L-2	1024 x 1 (250ns) (LP)	1.45
2111	256 x 4 (450ns)	2.45
2112	256 x 4 (450ns)	2.95
2114	1024 x 4 (450ns)	8/9.90
2114-25	1024 x 4 (250ns)	8/9.95
2114L-4	1024 x 4 (450ns) (LP)	8/11.95
2114L-3	1024 x 4 (300ns) (LP)	8/12.45
2114L-2	1024 x 4 (200ns) (LP)	8/12.95
2147	4096 x 1 (55ns)	4.90
TMS4044-4	4096 x 1 (450ns)	3.45
TMS4044-3	4096 x 1 (300ns)	3.95
TMS4044-2	4096 x 1 (200ns)	4.45
MK4118	1024 x 8 (250ns)	9.90
TMM2016-200	2048 x 8 (200ns)	4.10
TMM2016-150	2048 x 8 (150ns)	4.90
TMM2016-100	2048 x 8 (100ns)	6.10
HM6116-4	2048 x 8 (200ns) (cmos)	4.70
HM6116-3	2048 x 8 (150ns) (cmos)	4.90
HM6116-2	2048 x 8 (120ns) (cmos)	6.90
HM6116LP-4	2048 x 8 (200ns) (cmos)(LP)	5.90
HM6116LP-3	2048 x 8 (150ns) (cmos)(LP)	6.90
HM6116LP-2	2048 x 8 (120ns) (cmos)(LP)	9.95
Z-6132	4096 x 8 (300ns) (Qstat)	33.95

LP = Low Power Qstat = Quasi-Static

DYNAMIC RAMS

TMS4027	4096 x 1 (250ns)	1.95
UPD411	4096 x 1 (300ns)	2.95
MMS200	4096 x 1 (300ns)	2.95
MK4108	8192 x 1 (200ns)	1.90
MMS298	8192 x 1 (250ns)	1.80
4116-300	16384 x 1 (300ns)	8/10.75
4116-250	16384 x 1 (250ns)	8/10.95
4116-200	16384 x 1 (200ns)	8/11.95
4116-150	16384 x 1 (150ns)	8/13.95
4116-120	16384 x 1 (120ns)	8/28.95
2118	16384 x 1 (150ns) (5v)	4.90
4164-200	65536 x 1 (200ns) (5v)	5.90
4164-150	65536 x 1 (150ns) (5v)	6.90

5V = single 5 volt supply

EPROMS

1702	256 x 8 (1us)	4.45
2708	1024 x 8 (450ns)	3.90
2758	1024 x 8 (450ns) (5v)	5.90
2716	2048 x 8 (450ns) (5v)	3.90
2716-1	2048 x 8 (350ns) (5v)	5.90
TMS2516	2048 x 8 (450ns) (5v)	5.45
TMS2716	2048 x 8 (450ns) (5v)	7.90
TMS2532	4096 x 8 (450ns) (5v)	5.90
2732	4096 x 8 (450ns) (5v)	4.90
2732-250	4096 x 8 (250ns) (5v)	8.90
2732-200	4096 x 8 (200ns) (5v)	10.95
2764	8192 x 8 (450ns) (5v)	9.90
2764-250	8192 x 8 (250ns) (5v)	13.95
2764-200	8192 x 8 (200ns) (5v)	23.95
TMS2564	8192 x 8 (450ns) (5v)	16.95
MC85784	8192 x 8 (450ns) (5v) (24 pin)	38.95
27128	16384 x 8Call	Call

5v = Single 5 Volt Supply

74LS00

74LS00	.23	74LS173	.68
74LS01	.24	74LS174	.54
74LS02	.24	74LS175	.54
74LS03	.24	74LS181	2.10
74LS04	.23	74LS189	6.90
74LS05	.24	74LS190	.88
74LS08	.27	74LS191	.88
74LS09	.28	74LS192	.78
74LS10	.24	74LS193	.78
74LS11	.34	74LS194	.68
74LS12	.34	74LS195	.68
74LS13	.44	74LS196	.78
74LS14	.58	74LS197	.78
74LS15	.34	74LS221	.88
74LS20	.24	74LS240	.94
74LS21	.28	74LS241	.98
74LS22	.24	74LS242	.98
74LS26	.28	74LS243	.98
74LS27	.28	74LS244	1.25
74LS28	.34	74LS245	1.45
74LS30	.24	74LS247	.74
74LS32	.28	74LS248	.98
74LS33	.54	74LS249	.98
74LS37	.34	74LS251	.58
74LS38	.34	74LS253	.58
74LS40	.24	74LS257	.58
74LS42	.48	74LS258	.58
74LS47	.74	74LS259	2.70
74LS48	.74	74LS260	.58
74LS49	.74	74LS266	.54
74LS51	.24	74LS273	1.45
74LS54	.28	74LS275	3.30
74LS55	.28	74LS279	.48
74LS63	1.20	74LS280	1.95
74LS73	.38	74LS283	.68
74LS74	.34	74LS290	.88
74LS75	.38	74LS293	.88
74LS76	.38	74LS295	.98
74LS78	.48	74LS298	.88
74LS83	.59	74LS299	1.70
74LS85	.68	74LS323	3.45
74LS86	.38	74LS324	1.70
74LS90	.54	74LS352	1.25
74LS91	.88	74LS353	1.25

74LS92	.54	74LS363	1.30
74LS93	.54	74LS364	1.90
74LS95	.74	74LS365	.48
74LS96	.88	74LS366	.48
74LS107	.38	74LS367	.44
74LS109	.38	74LS368	.44
74LS112	.38	74LS373	1.35
74LS113	.38	74LS374	1.35
74LS114	.38	74LS377	1.35
74LS122	.44	74LS378	1.13
74LS123	.78	74LS379	1.30
74LS124	2.85	74LS385	1.85
74LS125	.48	74LS386	.44
74LS126	.48	74LS390	1.15
74LS132	.58	74LS393	1.15
74LS133	.58	74LS395	1.15
74LS136	.38	74LS399	1.45
74LS137	.98	74LS424	2.90
74LS138	.54	74LS447	.36
74LS139	.54	74LS490	1.90
74LS145	1.15	74LS624	3.95
74LS147	2.45	74LS640	2.15
74LS148	1.30	74LS645	2.15
74LS151	.54	74LS668	1.65
74LS153	.54	74LS669	1.85
74LS154	1.85	74LS670	1.45
74LS155	.68	74LS674	9.60
74LS156	.68	74LS682	3.15
74LS157	.64	74LS683	3.15
74LS158	.58	74LS684	3.15
74LS160	.88	74LS685	3.15
74LS161	.64	74LS688	2.35
74LS162	.68	74LS689	3.15
74LS163	.64	74LS783	23.95
74LS164	.68	81LS95	1.45
74LS165	.94	81LS96	1.45
74LS166	1.90	81LS97	1.45
74LS168	1.70	81LS98	1.45
74LS169	1.70	25LS2521	2.75
74LS170	1.45	25LS2569	4.20

6500

1MHZ

6502	4.90
6504	6.90
6505	6.90
6507	9.90
6520	4.30
6522	7.90
6532	9.90
6545	21.50
6551	10.85

2 MHZ

6502A	6.90
6522A	9.90
6532A	10.95
6545A	26.95
6551A	10.95

3 MHZ

6502B	13.95
-------	-------	-------

6800

68000	58.95
6800	3.90
6802	7.90
6808	12.90
6809E	18.95
6809	10.95
6810	2.90
6820	4.30
6821	3.20
6828	13.95
6840	11.95
6843	33.95
6844	24.95
6845	13.95
6847	10.95
6850	3.20
6852	15.70
6860	9.90
6862	10.95
6875	6.90
6880	2.20
6883	21.95
68047	23.95
68488	18.95

6800 1MHZ

68B00	9.95
68B02	21.25
68B09E	28.95
68B09	28.95
68B10	6.90
68B21	6.90
68B45	18.95
68B50	5.90

8000

8035	5.90
8039	6.90
INS-8060	16.95
INS-8073	23.95
8080	3.90
8085	5.90
8085A-2	10.95
8086	28.95
8087	CALL
8088	38.95
8089	88.95
8155	6.90
8155-2	7.90
8156	6.90
8185	28.95
8185-2	38.95
8741	38.95
8748	23.95
8755	23.95

8200

8202	23.95
8203	38.95
8205	3.45
8212	1.75
8214	3.80
8216	1.70
8224	2.20
8226	1.75
8228	3.45
8237	18.95
8237-5	20.95
8238	4.45
8243	4.40
8250	9.95
8251	4.45
8253	6.90
8253-5	7.90
8255	4.45
8255-5	5.20
8257	7.90
8257-5	8.90
8259	6.85
8259-5	7.45
8271	38.95
8272	38.95
8275	28.95
8279	8.90
8279-5	9.00
8272	6.45
8283	6.45
8284	5.45
8286	6.45
8287	6.45
8288	24.00
8289	48.95

Z-80

2.5 Mhz

Z80-CPU	3.90
Z80-CTC	4.45
Z80-DART	9.95
Z80-DMA	13.95
Z80-PIO	4.45
Z80-SIO/0	15.95
Z80-SIO/1	15.95
Z80-SIO/2	15.95
Z80-SIO/9	15.95

4.0 Mhz

Z80A-CPU	4.90
Z80A-CTC	4.90
Z80A-DART	10.95
Z80A-DMA	15.95
Z80A-PIO	4.90
Z80A-SIO/0	15.95
Z80A-SIO/1	15.95
Z80A-SIO/2	15.95
Z80A-SIO/9	15.95

6.0 Mhz

Z80B-CPU	12.95
Z80B-CTC	12.95
Z80B-PIO	12.95
Z80B-DART	18.95

ZILOG

Z6132	33.95
Z8671	38.95

DISC CONTROLLERS

1771	15.95
1791	23.95
1793	25.95
1795	48.95
1797	48.95
2791	53.95
2793	53.95
2795	58.95
2797	58.95
6843	33.95
8272	38.95
UPD765	38.95
MB8876	28.95
MB8877	33.95
1691	16.95
2143	17.95

UARTS

AY3-1014	6.90
AY5-1013	3.90
AY3-1015	6.90
PT-1472	9.90
TR1602	3.90
2350	9.90
2651	8.90
TMS6071	5.90
IMS402	7.90
IMS403	8.90
INS8250	9.95

INTERFACE

8T26	1.54
8T28	1.84
8T95	.88
8T96	.88
8T97	.88
8T98	.88
DM6131	2.90
DP8304	2.24
DS8835	1.94
DS8836	.98

VOLTAGE REGULATORS

7805T	.74	7805T	.84
78M05C	.34	7908T	.84
7808T	.74	7912T	.84
7812T	.74	7915T	.84
7815T	.74	7924T	.84
7824T	.74	7905K	1.44
7805K	1.34	7912K	1.44
7812K	1.34	7915K	1.44
7815K	1.34	7924K	1.44
7824K	1.34	79L05	.78
78L05	.68	79L12	.78
78L12	.68	79L15	.78
78L15	.68	LM323K	4.90
78H05K	9.90	UA78S40	1.90
78H12K	9.90		

C, T = TO-220 K = TO-3 L = TO-92

DIP SWITCHES

4 POSITION	.84
5 POSITION	.89
6 POSITION	.89
7 POSITION	.94
8 POSITION	.94

IC SOCKETS

	1-99	100
8 pin ST	.12	.10
14 pin ST	.14	.11
16 pin ST	.16	.12
18 pin ST	.19	.17
20 pin ST	.28	.26
22 pin ST	.29	.26
24 pin ST	.29	.26
28 pin ST	.39	.31
40 pin ST	.48	.38
64 pin ST	4.20	call

ST = SOLDERTAIL

8 pin WW	.58	.48
14 pin WW	.68	.51
16 pin WW	.68	.57
18 pin WW	.98	.89
20 pin WW	1.04	.97
22 pin WW	1.34	1.23
24 pin WW	1.44	1.30
28 pin WW	1.64	1.44
40 pin WW	1.94	1.75

WW = WIREWRAP

16 pin ZIF	6.70	call
24 pin ZIF	9.90	call
28 pin ZIF	9.95	call

ZIF = TEXTTOOL (Zero Insertion Force)

CRYSTALS

32.768khz	1.90
1.0 mhz	4.90
1.8432	4.90
2.0	3.90
2.097152	3.90
2.4576	3.90
3.2768	3.90
3.579535	3.90
4.0	3.90
5.0	3.90
5.0688	3.90
5.185	3.90
5.7143	3.90
6.0	3.90
6.144	3.90
6.5536	3.90
8.0	3.90
10.0	3.90
10.738635	3.90
14.31818	3.90
15.0	3.90
16.0	3.90
17.430	3.90
18.0	3.90
18.432	3.90
20.0	3.90
22.1184	3.90
32.0	3.90

RESISTORS

1/4 WATT 5% CARBON FILM ALL STANDARD VALUES FROM 1 OHM TO 10 MEG OHM

50 PCS.	1.25
100 PCS.	2.00
1000 PCS.	15.00

APPLE ACCESSORIES

80 Column Card	129.95
16 K Card	42.50
Fan	38.95
Power Supply	84.95
RF Mod	24.95
Joy Stick (Apple II)	29.95
Paddles Apple	9.95
Z80 Card	129.95
SCRG Switch-A-Slot	19.95
Paddle Adapple	24.95
Extend-A Slot	19.95
Disk Drive	224.95
Controller Card	69.95

5 1/4" DISKETTES

ATHANA OR NASHUA

SSSD	18.95
SSDD	22.95
DSDD	27.95

PERISOFT

ACCESSORIES FOR APPLE II & IIe

ALL WITH 1 YEAR WARRANTY BY

PRINTERLINK

CENTRONICS
PARALLEL INTERFACE

- Simple to use — No configuring required
- Use with any centronics printer — EPSON, OKIDATA, etc.
- Includes Cable & Manual

\$58⁰⁰

MESSENGER

SERIAL INTERFACE

- Connects to any RS-232 serial device
- 8 switch selectable drivers for printers, terminals and modems
- Includes Cable & Manual

\$98⁰⁰

TIMELINK

REAL TIME CLOCK

- Applications in file management, word processing, communications, etc.
- Exclusive Alarm Clock feature
- Battery recharges automatically

\$83⁰⁰

NEW BUFFERLINK

ADD-ON PRINTER BUFFER

- No more waiting for printed output
- Connects easily to any parallel interface
- Expandable from 16K to 64K

\$138⁰⁰ (16K)

The Flip Sort™

The new Flip Sort™ has all the fine qualities of the original Flip Sort™, with some added benefits. Along with a new design, capacity has increased 50%, to hold 75 diskettes and the price is more reasonable than ever. \$19.95 ea.



The Flip Sort Plus™

The Flip Sort Plus™ adds new dimensions to storage. Designed with similar elegant lines as the original Flip Sort™, in a transparent smoked acrylic. The Flip Sort Plus™ has a storage capacity of over 100 diskettes and has all the outstanding features you have come to expect from the flip sort Family. 24.95 each

Do Kay

2100 De La Cruz Blvd.
Santa Clara, CA 95050

ADVANCED COMPUTER PRODUCTS

IBM PC HARDWARE

SEND \$2.00 for 1983 CATALOG

IBM PC COMBO CARD MEMORY PLUS AT LOW PRICES!

Now! "Multicard" expandable from 64-256K with

- (1) PARALLEL (1) SERIAL
- (1) CLOCK/CALENDAR

COEX 64 SPC with 64K **\$229⁰⁰**

COEX 256 SPC with 256K **\$399⁰⁰**

S-100 64K "CMOS" RAMCARD



Unbelievable Price!

\$299⁰⁰

Assembled and Tested

- ACP has sold over 1000 of these IEEE compatible, low-priced, high-reliability 64K Static RAM Cards.
- Single 5-Volt operation.

SIEMEN'S SALE

You can now purchase Shugart compatible 8" Disk Drives below your existing factory direct pricing!



These Prices are the lowest ever published. *Siemens' SSSD FDD100-8... \$169.00

Also, with purchase of Disk Drives you can buy the Vista V-1000 Dual Case with Power Supply and Cable for only \$375.00... Regular Price \$495.00

Offer Limited! Factory Warranty 90 Days! Shipped Immediately from Stock! *OEM Quantities

DOT MATRIX PRINTER

COEX 80-FIT

- ✓ 9x7 Dot Matrix, 80 CPS, Bi-Directional Printing
- ✓ 2K Buffered Memory
- ✓ 80, 96, 132 Columns, Graphics and Block Printing
- ✓ Selectable Char Pitch, Line Spacing and Feed



\$199⁰⁰

COEX Interface Card to Apple... \$48.95

ACP HAS DISK DRIVES

APPLE II™ COMPATIBLE

Thin Line Drive

\$249⁰⁰



TANDON 100-2

PC Compatible • Double Sided

\$289⁰⁰

TOSHIBA Half-High

PC Compatible • Double Sided

\$249⁰⁰



OTHER DRIVES WE STOCK

TANDON 848-2 Thinline	\$479.00	SHUGART 801R	\$399.00
TEAC F0558	299.00	SHUGART 850 Thinline	479.00
PANASONIC C155 (PC Comp)	259.00	SHUGART 8400	210.00
MPI 852	279.00	SEAGATE ST506 (5MB Win.)	599.00

Item	List	ACP
AST Megaplus™ Card	395	\$279
P/N MG064 (64K, S, C)		
•Combioplus™ Card	395	279
P/N MC-064SPC (64K, S, P, C)		
•PC I/O Plus™ Card	165	115
P/N IO (C, S)		
•"SIX PACK"		
P/N SP064SPC (64K, S, P, C)	299	
COEX Extender Card	40	29
Prototype Card	69	35
HERCULES Hercules Graphic Card	379	
MOUSE SYSTEMS Mouse for IBM	260	
MICROSOFT Mouse plus Multifoot Word	Call	
M&R 8 Slot Expansion Chassis for IBMPC/XT or Eagle etc	439	
ORCHID Hi-Res Graphics Adaptor	395	339
PERSYST Spectrum (64-256K)	319	
P/N SP64, (64K, Ck, S, P)	469	
PLANTRONICS Color plus™ Card	395	
QUADRAM Quadboard (64-256K)	395	279
P/N Q64, 64K w/4 functions	279	
QuadLink Apple Card	680	525
Quadboard 64K	190	279
Microfazer Print Buffer MP-64	488	
Quadronics (Hires RGB)	596	449
RIXON PC212A Modern I/O	479	
SSI Transmodem 1200	299	
USM Multidisplay Card		
VISTA "Multicard™" (exp. 64-256K)	395	229
P/N V-064 (64K, Ck, S, P)	695	399
P/N V-256 (256K, Ck, S, P)		
•"Maxicard™" (up to 576K)	240	
P/N V-576-64K	729	
P/N V-576-576K	495	329
•"PC Master™" (10 I/O)	249	199
•"PC Extender™" (up to 10 I/O)	299	199
•"Diskmaster™"	299	199
•"ThinLine Dual Floppy		
•V1200 6.2Mb Cartridge Drive	999	

Item	List	ACP
COEX 80FIT 80cps	\$299	\$199
DYNAX Daisywheel		325
SILVER REED		
EXP500 132 Column	649	
STAR MICRONICS - NEW!		
Gemini 10X 120cps	399	319
Gemini 15 15"	599	399
EPSON FX80	699	549
FX100	895	749
BROTHER HR-1/BMC	1195	895
DAISYWRITER	1495	1295
TTX Daisywheel		549
IBM PC Spinwriter 3550		1875
NEC PC to Parallel Cable	60	39

Item	List	ACP
AMDEK CORP		
300 Green 12"	\$199	\$155
310 Amber 12"	210	175
Color II Composite-Hitachi	399	339
Color II RGB Hi-Res	899	695
BMC		
12" Green	129	89
PRINCETON GRAPHICS		
RGB IBM Lookalike	700	545

Item	List	ACP
DYSAN 5 1/4" SS SD	10/555	\$38
DYSAN 5 1/4" DS SD	10/65	48
IBM 5 1/4" SS SD	10/60	43
IBM 5 1/4" DS SD	10/65	47
VERBATIM 525-01 SS	10/45	23
VERBATIM 550-01 DS	10/55	34
MAXELL MD1 SS	10/50	29
MAXELL MD2 DS	10/60	39
Flip Storage Box 5 1/4" (80 disks)	19	19
BULK SPECIAL SS	10/25	19
With Sleeve and Box	100/195	149

MORE IBM GOODIES

Item	List	ACP
COMPUABLE Keyboard & Drive Covers (set)		\$19
CURTIS PC Pedestal	800	64
PGS or Quadchrome Adaptor		20
Vertical PC System Stand		44
IBM Mono Extension Cable	50	44
Keyboard Ext. Cable (3-9')		34
EPD PROTECTION DEVICES		43
The Lemon (Surge Protector)		68
The Peach (Surge Protector)		122
The Orange (with EMI/RFI)		76
The Lime		76
INTEL 8087 IC		99
KOALA PAD		99
KRAFT Joystick IBM	70	40
RAM EXPANSION		
16K Motherboard (16 IC's)		19
64K Memory Exp. (9 IC's)		50

TIME SHARE SERVICES

COMPUSEWER Subscription	\$40
SOURCE Subscription	75

MODEMS

Item	List	ACP
HAYES Smartmodem 300	\$210	
PC Modem Software 1.3 (above)	49	
Smartmodem 1200	525	
PC Software 1.4C (above)	79	
Smartmodem 1200B	445	
Smartcom II	79	
Smartmodem to IBM Cable	25	

TOLL FREE
800-854-8230
TWX
910-595-1565

APPLE™ COMPATIBLE DISK CONTROLLER

Only **\$49⁹⁵**

Apple Printer Interface w/Apple to Epson Cable **\$49⁹⁵**

Apple IIe Compatible 80 Column Card w/64K **\$99⁹⁵**

APPLE COOLING FAN with Surge Suppression **\$49⁹⁵**

APPLE COMPATIBLE POWER SUPPLY **\$79⁹⁵**

+ 5V @ 5A
+ 12V @ 3A
- 12V @ 25A
- 5V @ 25A

APPLE COMPATIBLE JOY STICK **only \$15⁹⁵**

Vista Computer Company

VISTA V1200 6.2 Cartridge Drive w/Controller Apple or IBM Compatible **\$999⁹⁵**

Please Specify with Order

VISTA "SOLO" Apple II/Ile Compatible Disk Drive **Only \$199⁹⁵**

Controller... \$49.95

Just plug in and run.

Apple II 16K RAM CARD Compatible with Z80 Softcard™ . PASCAL CP/M™ Full 1 year Warranty, Top Quality by COEX **\$49⁹⁵**

NEW LOW ACP PRICE

Also from COEX, NEW EPSON Parallel Interface for Apple. With cable... \$49.95

VISTA A800 8" Disk Controller for Apple **\$299⁹⁵**

VISTA "DISKMASTER" IBM Compatible 3", 5", 8" and V1200 Compatible... **\$199⁹⁵**

apple computer Authorized Dealer

Item	LIST	ACP
Apple IIe w/64K	\$1395.00	\$1195.00
Apple IIe System	1995.00	1695.00
Apple IIe Sys w/Ext Text	2195.00	1895.00
Disk II w/Controller	545.00	449.00
Disk II w/ Controller	395.00	359.00
Monitor III Green	249.00	189.00
Super Serial Card	195.00	169.00
Parallel Interface Card	165.00	139.00
80 Column Text Card	125.00	
Extended 80 Column Text	295.00	249.00
Dot Matrix Printer	695.00	529.00

Apple Products Available In-Store Only

MORE HARDWARE

Item	LIST	ACP
MICROSOFT Z80 Softcard	\$395.00	\$249.00
16K Ramcard	195.00	89.00
SSM AIO-II 4 Function Serial/Parallel	225.00	179.00
EASTSIDE Wildcard Apple II	149.00	115.00
KENSINGTON System Saver	89.95	69.00
KEYBOARD COMPANY Numeric Keypad	149.95	124.95
Apple II Joystick	49.95	44.50
Apple II Hand Controllers	29.95	25.95
KRAFT Joystick	49.00	40.00
Hand Controller		
MPC 128K Bubble Memory	875.00	699.00
PROMETHEUS VERSAscard Four-in-1	199.00	166.00
VISTA COMPUTER CO. 8000 8" Disk Control	379.95	299.00
Quantat Disk Drive 5 1/4"	849.00	799.00
Solo Disk Drive w/Contr	299.00	249.00
Solo Drive w/ Contr	249.00	199.00
Vista 5 1/4" Disk Contr	92.00	49.00
Typehead Buffer	49.95	35.00
VIDEX Videoterm 80x24 Card	345.00	279.00
Keyboard Enhancer II	149.00	129.00
Soft Switch	35.00	30.00
Function Strip Keys	79.00	69.00
PRACTICAL PERIPHERALS 16K Microbuffer	259.00	220.00
32K Microbuffer	299.00	253.00
Snapshot Option	149.00	109.00
VOTRAX Type n Talk Speech Personal System	249.00	219.00
395.00	339.00	
VYNET Apple II Voice Syn.	395.00	349.00
Apple II Telephone I/O	295.00	249.00
SCOTT INSTRUMENTS Voice Recorder n VET80	799.00	675.00
COEX 16K RAM Card	99.00	49.95
Parallel Card w/Cable	99.00	49.95
Apple Protocard	29.00	19.95
Apple Extendercard	29.00	19.95
Apple II Ext RAM Card	199.00	99.95
CORVUS ORANGE MICRO The Grappler I/O (Plus)	175.00	139.00
The Bufferboard	175.00	139.00
SATURN SYSTEMS 32K RAM Card	219.00	179.00
128K RAM Card	499.00	439.00
STREET ECHO II	149.00	129.00
LEGEND 64K II file	327.00	269.00
128K II file	599.00	499.00
183RC 18K Start	149.00	135.00
MICROPRO Wordstar w/CPM	499	415
MOUNTAIN COMPUTER CPS Multifunction	239.00	169.00
Music System	395.00	335.00
A/D plus D/A	350.00	299.00
ROM Plus	155.00	129.00
M&R ENTERPRISES Sup nrm 80x24 Card	395.00	269.00
Sup nMod II	69.00	49.00
Sup nMod V (IBM)	69.00	49.00
ALS The CP/M Plus Z80 Card	399.00	329.00
Smarterem 80x24 Card	349.00	279.00
The Synergizer Package	699.00	549.00

Apple Compatible Software

Item	LIST	ACP
BUSINESS ASCII Exprs, Prof		99
HOBBY Screen Writer	\$129	
BD Master	155	Zoom Graphics 32
Visical™ 3.3	185	Unity City 22
Visplot	159	Locksmith 4.0 90
PFS, File II	115	Nibbles Away II 49
PFS, File III	155	GAMES 25
Visitrend/Visplot	25	Choppliter 26
PFS, Graph II	115	Frogger 24
PFS, Graph III	155	Space Invaders 39
Multipan	199	Snack Attack 24
Versaform	279	Cannonball Blitz 26
Wordstar	299	Knight Diamonds 28
dBASE II	439	Zork I 29
Supercalc	169	Zork II 29
PFS, Report II	95	Starcross 29
PFS, Report III	115	Serpentine 25
Acct Plus G/L	299	Star Blazer 25
G/L, A/P, A/R	590	Deadline 39
Above + Inventory	799	Tubeway 25
Magic Window	115	Flight Simulator 25
HOME Home Accountant	59	Space Vikings 43
Transend I	76	Spiffire Simulator 29
Transend II	119	Apple Panic 22
Visitem	89	Olympic Decath 23

Apple™ Apple Trademark of Apple Computer
IBM™ IBM Trademark of International Business Machines

TERMS: MO, Cashier's Check, Bank Wire, Personal checks allow 2 week processing. Include Drivers License and credit card #s Visa, AMEX, CB add 3% service charge. Add 3% shipping & handling or \$2.50, whichever is greater. Add 10% for foreign orders or US Peronial Post. Include Telephone number. NO C.O.D.s. Prices subject to change without notice. Some items subject to prior sale. We reserve the right to substitute manufacturer. Retail prices may vary.

ADVANCED COMPUTER PRODUCTS

Serving Computer Professionals Since 1976

HOOKED ON IBM PC



If You're Thinking IBM PC™, READ THIS!

LOW COST MEMORY - AVAILABLE NOW!

HARDWARE

AST Megaplus™ Card P/N MC064 (64K, S, C)	List 395	ACP \$279
•ComboPlus™ Card P/N MC-064SPC (64K, S, P, C)	395	279
•PC I/O Plus II™ Card P/N I/O (C, S)	165	115
•"SIX PACK" P/N SP064SPC (64K, S, P, C)	40	299
COEX Extender Card	69	35
COEX Prototype Card		
HERCULES		
Hercules Graphic Card		359
MOUSE SYSTEMS Mouse for IBM		269
MICROSOFT		
Mouse plus Multitool Word		Call
ORCHID		
Hi-Res Graphics Adaptor	395	339
PERSYST Spectrum (64-256K)		
P/N SP64 (64K, Ck, S, P)		319
PLANTRONICS Color plus™ Card		399
QUADRAM Quadboard (64-256K)		
P/N Q64, 64K w/d functions	395	279
QuadLink Apple Card	680	525
Quadboard 64K		279
Microfazer Print Buffer MP-64		190
Quadchrome (HiRes RGB)		488
RIXON PC212A Modem I/O	596	449
S&S Transmodem 1200		479
USI Multipdisplay Card		299
VISTA "Multicard"™ (exp. 64-256K)		
P/N V-064 (64K, Ck, S, P)	395	229
P/N V-256 (256K, Ck, S, P)	695	399
•"Maxicard"™ (up to 576K)		
P/N V-576-64K		249
P/N V-576-576K		729
•"PC Master"™ (10 I/O)	495	329
•"PC Extender"™ (up to 10 I/O)	249	199
•"Diskmaster"™	299	199
•8" Thinline Dual Floppy		Call
•V1200 5.25Mb Cartridge Drive		999

PRINTERS

COEX 80F/T 80cps	\$299	\$199
DYNAX Daisywheel		525
SILVER REED		
EXP500 132 Column		649
STAR MICRONICS - NEW!		
Gemini 10X 120cps	399	319
Gemini 15 15"	599	469
EPSON FX80	699	549
FX100	895	749
BROTHER HR-1/BMC	1195	895
DAISYWRITER	1495	1295
TTX Daisywheel		549
NEC Spinwriter 3550		1875
IBM PC to Parallel Cable	60	39

MONITORS

AMDEK CORP		
300 Green 12"	\$199	\$155
310 Amber 12"		210
Color I Composite/Hitachi		399
Color II RGB Hi-Res		899
BMC		
12" Green	129	89
PRINCETON GRAPHICS		
RGB IBM Lookalike	700	545

DISKETTES

DYSAN 5 1/4" SS SD	10/55	\$38
DYSAN 5 1/4" DS SD	10/65	48
IBM 5 1/4" SS SD	10/60	43
IBM 5 1/4" SS DD	10/65	47
VERBATIM 525-01 SS	10/45	23
VERBATIM 550-01 DS	10/55	34
MAXELL MD1 SS	10/50	29
MAXELL MD2 DS	10/60	39
Flip Storage Box 5 1/4" (80 disks)	10/25	19
BULK SPECIAL SS		
With Sleeve and Box	100/195	149

MORE IBM GOODIES

COMPCABLE		
Keyboard & Drive Covers (set)		\$19
CURTIS		
PC Pedestal	\$80	64
PGS or Quadchrome Adaptor		10
Vertical PC System Stand		20
IBM Mono Extension Cable	50	44
Keyboard Ext. Cable (3-9")		34
EPD PROTECTION DEVICES		
The Lemon (Surge Protector)		43
The Peach (Surge Protector)		68
The Orange (with EMI/RFI)		122
The Lime		76
INTEL 8087 IC		199
KOALA PAD		99
KRAFT Joystick IBM	70	40
RAM EXPANSION		
16K Motherboard (16 IC's)		19
64K Memory Exp. (9 IC's)		50

TIME SHARE SERVICES

COMPUSERVE Subscription	\$40
SOURCE Subscription	75

MODEMS

HAYES		
Smartmodem 300	\$210	
PC Modem Software 1.3 (above)	49	
Smartmodem 1200	525	
PC Software 1.4C (above)	79	
Smartmodem 1200B	445	
Smartmodem II	79	
Smartmodem to IBM Cable	25	

SOFTWARE

dBASE II
\$399⁰⁰

Condor
\$389⁰⁰

SuperCalc
\$99⁰⁰

SuperCalc 2
\$179⁰⁰

Multiplan
\$189⁰⁰

Wordstar
\$299⁰⁰

Lotus 1-2-3
Call!

T. K. Solver!
Call!

Flight Simulator
\$45⁰⁰

Context MBA
Call!

Computer Inovations
Call!

C86C Compiler
\$369⁰⁰

Copy II Plus
\$32⁰⁰

Visiword
\$289⁰⁰

Digital Research
Pascal MT + 86 \$295.00
Concurrent CP/M 86 260.00
CBASIC 86 149.00

Plus More Great Software Values In Our 1983 Catalog! Send For Your Copy NOW.

COEX Combocard II

- ★ 64K to 256K RAM
- ★ ASYNC Serial Port
- ★ Clock/Calendar w/NiCad Backup
- ★ Parallel Printer Port
- ★ RAMDisk Software
- ★ Spooler Software

64K only \$229⁰⁰

256K only \$399⁰⁰

Zero "K" Version Available Only \$199.00

PLUS! . . .with Purchase of either Memory card above

- SUPERCALC™only \$89.00 (195.00 value)
- Disk Emulator FREE
- Print Spooler FREE

ACP PC "FEATURE OF THE MONTH"

1. DISKMASTER™. Disk Controller for IBM PC or XT adds both 5 1/4" and 8" floppy drives. Complete with Software. Same card can also handle the Amlyn 6.2 Mb Cartridge Add-on Subsystem List \$299 ACP \$199
2. VISTA 1200 with DISKMASTER™ \$999
3. M&R "SUP'R EXTENDER"™. IBM PC & XT Expansion Chassis with (6) Slots, Power Supply and Fan. Your price!!! only \$439.00. You cannot afford to live without one.

DISK DRIVES

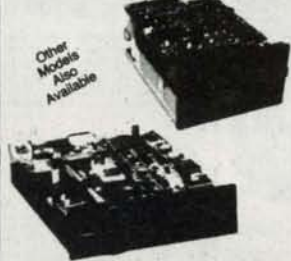

TANDON 100-2
PC Compatible • Double Sided
\$289⁰⁰

TOSHIBA 1/2 High
PC Compatible • Double Sided
\$249⁰⁰

Circle 14 on inquiry card.

TERMS: MO, Cashier's Check, Bank Wire. Personal checks allow 2 weeks for processing. Include Drivers License and credit card #s Visa, AMEX, CB add 3% service charge. Add 3% shipping & handling or \$2.50, whichever is greater. Add 10% for foreign orders or US Parcel Post. Include Telephone number. NO CODs. Prices subject to change without notice. Some items subject to prior sale. We reserve the right to substitute manufacturer. Retail prices may vary. We are not an authorized IBM dealer. IBM™ trademark of International Business Machines.

MAIL ORDER: P.O. Box 17329 Irvine, CA 92713
Retail: 1310 E. Edinger, Santa Ana, CA 92705 (714) 558-8813
542 W. Trimble, San Jose, CA 95131 (408) 946-7010

TOLL FREE
800-854-8230
TWX
910-595-1565

64K MEMORY + P.S.C. \$229.00

California Digital

Post Office Box 3097 B • Torrance, California 90503

★ FREE ★

Plastic library case supplied with all diskettes purchased from California Digital

\$19.95

Manufactured for California Digital by one of the most respected producers of magnetic media. Each diskette is double density at 40 tracks. To insure extended media life all diskettes are manufactured with a reinforced hub. Each box of diskettes is supplied with a free plastic library case.

Soft sector CAL-501; Ten sector CAL-510. Also Available Double sided soft sector diskettes for use with the IBM/PC CAL-551 \$24.95



5 1/4" DISKETTES WITH LIBRARY CASE

\$26.50

Your Choice
**SCOTCH
MEMOREX
VERBATIM**

Single Side Double Density
Soft Sector 10 Sector 16 Sector

SCOTCH	744D-0	744D-10	744D-16	26.50
MEMOREX	3481	3483	3485	26.50
VERBATIM	525-01	525-10	NA	26.50
MAXELL	MD1	MH1-10	MH1-16	26.50
DYSAN	104/1D	107/1D	NA	45.00

Double Side Double Density

SCOTCH	745-0	745-10	745-16	39.00
VERBATIM	550-01	550-10	NA	42.50
MAXELL	MD2-D	MH2-10D	MH2-16D	45.00
DYSAN	104/2D	107/2D	NA	49.50
DYSAN 96	204/2D	NA	NA	59.50

EIGHT INCH DISKETTES

Single Side Single Density		Single Side Double Density		
SCOTCH	740-0	29.50	SCOTCH 741-0	39.00
MEMOREX	3060	29.50	MEMOREX 3090	35.00
DYSAN	3740/1	39.50	DYSAN 3740/D	57.50
Thirty Two Sector		Double side Double Density		
SCOTCH	740-32	29.50	SCOTCH 743-0	47.50
			MEMOREX 3114	39.50
			DYSAN 3740/2D	65.00

23" COMPOSITE MONITOR \$159

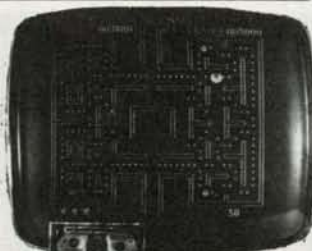

Ideal monitor for classroom demonstrations.

Ever by gathering a classroom of students around a 23" monitor? Here is your opportunity to purchase a 23" high resolution monitor at a reasonable price. These units accept standard composite video signals generated by most personal computers including the Apple and IBM. Attach it your computer and in second you are shooting down Kingpins in wide screen video.

MOT-BW23 35 Lbs. Monitors are open frame and for safety should be enclosed. Wood grained enclosure for above \$35.00, additional CAL-ENG23 15 Lbs.



SPECIAL

Shugart 410
\$129

These Shugart 410 5 1/4" disk drives are all factory fresh 1983 production, recently purchased from the Four Phase Division of the Motorola Corporation. These disk drives are single sided 80 track (96 TPI) suitable for use with the Radio Shack Model 1 and Model 3. Or any other application that can support an 80 track second drive such as the IBM/PC. The 410 is full height and functionally the same as the Tandon TM 100-3. Complete with power connector and installation manual. When these Shugart 410's are liquidated the price will revert to our regular price of \$249. SHU-SA410

MEMORY

16K DYNAMIC	2732 EPROM
1.95	4.95
4116 150ns.	450ns.
64K DYNAMIC	16K STATIC
5.95	4.95
4164 150ns.	6116 200ns.

2764 EPROM SALE \$5.95

DYNAMIC MEMORY

4027 4K dynamic 250ns.	ICM-4027250	1.31	32 +	100 +
4116 150ns 16K	ICM-4116150	1.99	1.55	99
4164 150ns 64K 128 refresh	ICM-4164150	1.75	1.65	1.45
41256 150ns 256K	ICM-41256150	5.95	5.25	5.19
DP8409 dynamic controller	ICT-8409		Availability: Mar 84	
		39.00	35.00	29.00

STATIC MEMORY

21L02 200ns 1K static	ICM-21L02200	1.49	1.29	1.15
21L02 450ns 1K static	ICM-21L02450	1.29	1.15	99
2112 450ns 2K static	ICM-2112450	2.99	2.85	2.75
2114 300ns 1K x 4	ICM-2114300	1.95	1.85	1.75
30350 300ns 4K x 8	ICM-30350300	3.49	3.25	2.99
4044TMS 450ns 4K x 1	ICM-4044TMS	2.50	2.25	1.99
5237 300ns 4K x 8	ICM-5237300	4.85	4.50	4.25
6116 P4 200ns 2K x 8	ICM-6116200	4.75	4.55	4.35
6116 P3 150ns 2K x 8	ICM-6116150	7.95	7.50	7.90
6167 2102 100ns 10K x 1 (20 pin)	ICM-6167100			

EPROMS

2708 450ns 1K x 8	ICE-2708	4.95	4.75	4.55
2716 450ns 2K x 8	ICE-2716	4.50	4.25	3.97
2732 450ns 4K x 8	ICE-2732	7.95	7.50	7.25
2732 450ns 4K x 8	ICE-2732	4.50	3.75	3.55
2732 450ns 4K x 8	ICE-2732	8.50	8.00	7.60
2764 350ns 8K x 8	ICE-2764	10.50	9.90	9.50
27128 350ns 16K x 8	ICE-27128	5.95	5.65	5.35
2817 EEPROM 2K x 8	ICE-2817	18.95	18.25	17.75
		45.00	39.00	36.50

BLOWOUT SALE

\$169



California Digital has recently participated in the purchase of several thousand Siemens FDD 100-8 floppy disk drives. These units are electronically and physically similar to that of the Shugart 801R. All units are new and shipped in factory sealed boxes. Manual and power connectors supplied free upon request. Your choice 115 Volt, 60 Hz. or 230 Volt, 50Hz.

REMEX DOUBLE SIDED \$219

California Digital has just purchased a large quantity of Remex RFD-4000 Eight inch double sided disk drives. Remex is the only double sided disk drive that has a double gimbal mounted head assembly that guarantees lower head tracking. This drive is mechanically solid. Remex has always been known for producing premiere products for the floppy disk market. The Remex company is a subsidiary of the Ex-cell-o Corporation, a Fortune 500 Company.

Eight Inch Single Sided Drives

	One	Two	Ten
SHUGART 801R	385	375	365
SHUGART 810 Half Height	385	375	365
SIEMENS FDD 100-8	169	169	159
TANDON 848E-1 Half Height	369	359	349

Eight Inch Double Sided Drives

SHUGART SA851R	495	485	475
SHUGART 860 Half Height	485	475	459
QUME 842 "QUME TRACK 8"	459	459	449
TANDON 848E-2 Half Height	459	447	465
REMEX RFD-4000	219	219	209
MITSUBISHI M2894-63	379	375	369
MITSUBISHI M2896-63 Half Ht.	459	449	409

Five Inch Single Sided Drives

SHUGART SA400L	235	229	225
SHUGART SA410 96TPI/80 Trk.	129	119	call
SHUGART SA200 3/4 Height	159	149	139
TANDON TM100-1	189	179	175

Five Inch Double Sided Drives

REMEX RFD480 IBM compatible	199	189	175
SHUGART SA450	319	309	299
SHUGART SA455 Half Height	259	249	239
SHUGART SA465 Half Ht. 96TPI	289	279	269
TANDON TM50-2 Half Height	215	209	199
TANDON TM55-4 half Ht. 96TPI	329	319	309
TANDON 100-2	279	269	259
TANDON 101-4 96TPI 80 Track	369	355	350
MITSUBISHI 4851 Half Height	259	249	245
MITSUBISHI 4853 1/2 Ht. 96TPI	339	329	319
MITSUBISHI 4854 1/2 Ht., 8" elec.	465	449	439
QUME 142 Half Height	239	229	219
TEAC FD-55B Half Height	299	289	275

Three Inch Disk Drives

SHUGART SA300 with diskette	229	219	209
-----------------------------	-----	-----	-----

Five Inch Winchester Hard Disk Drives

SHUGART 612 13 M/Bytes	895	865	825
SHUGART 706 6 M/Byte, Half Ht	795	775	755
SHUGART 712 13 M/Byte, 1/2 Ht.	895	865	825
SEAGATE 506 6 M/Byte	465	445	425
TANDON 503 19 M/Byte	895	875	855

Upon request, all drives are supplied with power connectors and manual

ENCLOSURES

California Digital manufactures an assortment of stock and custom disk drive enclosures. If the volume is justified we will custom design an enclosure for your application. The following stock disk drive enclosures are available. All include power supplies the 8" enclosures are supplied with exhaust fans.

Horizontal mount two 8" full height drives.	\$279.00
Vertical mount two full height 8" disk drives.	\$299.00
Horizontal mount one full height or two half height 8" disk drives.	\$239.00
Vertical mount two full height 5 1/4" disk drives.	\$139.00

CONNECTORS



GOLD S-100 EDGE CARD CONNECTORS

Imasi s/1 250	CNE-IMS	2.95	2.50	2.19
Sullins Hi/Fat	CNE-H100	4.19	3.85	3.47
S-100 Wire Wt	CNE-W10	3.95	3.50	3.19
Altair 140 s/1	CNE-100A	4.95	4.50	4.19

156" CENTER EDGE CARD CONNECTORS

22/44 Eyelet	CNE-44E	2.50	2.15	1.96
43/72 Moto. s/1	CNE-72S	6.80	6.15	5.75
36/72 D/3 s/1	CNE-72S	5.95	5.50	5.19

RIBBON CONNECTORS

DB25P male	CND-25P	5.95	5.25	4.15
DB25S female	CND-25S	5.95	5.39	4.50
57-30360 male	CND-36S	7.95	6.75	5.90
57-30360 female	CND-36S	7.95	6.75	5.90
20 pin edge	CNI-DE20	4.35	3.90	3.50
20 pin socket	CNI-DS20	2.75	1.65	1.60
26 pin edge	CNI-DE26	4.95	3.50	2.70
26 pin socket	CNI-DS26	3.50	2.40	2.15
34 pin edge	CNI-DE34	4.95	4.50	3.50
34 pin socket	CNI-DS34	4.50	3.95	3.15
50 pin socket	CNI-DS50	8.60	4.90	
50 pin socket	CNI-DS50	4.89	4.60	3.90

"D" TYPE catalog each 10-99 100+

DESP male	CND-9P	1.60	1.40	1.30
DESP female	CND-9P	2.25	2.00	1.30
DE hood	CHM	1.50	1.25	1.20
DA15P male	CND-15P	2.35	2.10	1.90
DA15S female	CND-15S	3.25	3.10	2.90
DA15 hood	CND-15H	1.60	1.35	1.30
DB25P male	CND-25P	1.95	1.75	1.30
DB25S female	CND-25S	2.95	2.55	1.65
DB25 hood	CND-25H	1.35	1.15	.77
DC37P male	CND-37P	4.20	3.95	3.65
DC37S female	CND-37S	6.95	5.75	5.50
DC37 hood	CND-37H	2.25	1.95	1.65
DD50P male	CND-50P	5.50	5.10	4.75
DD50 hood	CND-50H	2.60	2.40	2.10
Hardware 2/set	CND-2HS	.89	.89	.42

AMPHENOL / CENTRONICS TYPE

57-30360 36P	CNP-36P	7.95	6.35	5.97
IEEE488 C or D	CND-34P	7.95	6.35	5.35

DISK DRIVE POWER CONNECTORS

8 5 pin D.C.	CNP-8DC	1.95	1.29	.89
8 3 pin Sigs	CNP-3SS	1.69	1.09	.89
3 4 pin D.C.	CNP-3DC	1.69	1.09	.69
5 4 pin D.C.	CNP-4DC	1.79	1.19	.99
3 pin DIN relet	CNP-D3P	2.59	1.99	1.59

TOLL FREE ORDER LINE
(800) 421-5041
TECHNICAL & CALIFORNIA
(213) 643-9001

Shipping: First five pounds \$3.00, each additional pound \$.50.
Foreign orders: 10% shipping, excess will be refunded.
California residents add 6 1/2% sales tax. • COD's discouraged.
Open accounts extended to state supported educational institutions and companies with a strong "Dun & Bradstreet" rating.
Retail location: 15608 Inglewood Avenue, Lawndale 90260.

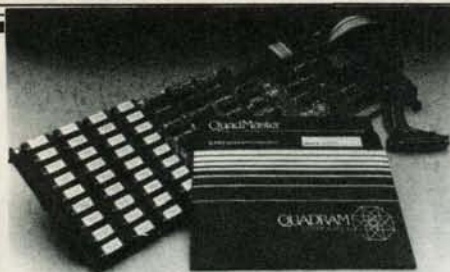

DISKETTES For IBM PC

High quality double-sided, double-density diskettes, certified to be absolutely error free. Box of ten, warranted for one year

MMD-5220104 With FREE! plastic case _____ \$24.95
MMD-5220101 Verbatim Datafile _____ \$34.95

A ACCESSORIES for your IBM PC

QUADBOARD I—QUADRAM

Up to 256K RAM, serial port, parallel printer port, clock calendar, RAM disk, and printer spooler software

MEX-41000A Quadboard w/o RAM _____ \$214.95
MEX-41064A 64K Quadboard _____ \$275.00
MEX-41256A 256K Quadboard _____ \$399.95

QUADBOARD II—QUADRAM

Two serial ports, clock/calendar, memory expansion, and Quadmaster software

MEM-40064A Quadboard II, 64K _____ \$275.00
MEX-40256A Quadboard, 256K _____ \$399.00

QUADLINK—QUADRAM

Allows IBM PC to run Apple software, includes interface card and software to allow your IBM PC to run both Apple DOS and PC DOS

CPX-50500A Quadlink _____ \$485.00

SIX PAK PLUS—AST

Up to 384K RAM, clock calendar with battery back-up, serial port, parallel printer port, optional game port. Super drive and super spool software included FREE!

MEX-38064A 64K, C.S.P. _____ \$269.95
MEX-38256A 256K, C.S.P. _____ \$489.95
For Game Port Option Add _____ \$39.95

MEGA PLUS—AST

Up to 512K RAM, clock calendar with battery back-up, 2 serial ports, parallel printer port, game port. Super drive and superspool software included FREE!

MEX-51064A 64K, C.1 serial _____ \$269.95
MEX-51000S Second serial port option _____ \$39.95
MEX-51000P Printer port option _____ \$39.95
MEX-51000G Game port option _____ \$39.95
For Each Additional 64K RAM Add _____ \$49.95

COMBO PLUS II—AST

Up to 256K RAM, clock with battery back-up, serial port, parallel port, superspool software included FREE!

MEX-25064A 64K, C.S.P. _____ \$269.95
MEX-25256A 256K, C.S.P. _____ \$419.95

I/O PLUS II—AST

Up to 2 serial ports, parallel printer port, game port, clock calendar with battery back-up. Super drive and superspool software included FREE!

IOI-7500A Clock & 1 serial port _____ \$129.95
IOI-7500P Printer port option _____ \$39.95
IOI-7500S Second serial port option _____ \$39.95
IOI-7500G Game port option _____ \$39.95

KEYTRONICS KEYBOARD

Similar to the IBM PC keyboard, but with all the keys in the right places for word processing

KBE-45100 Keytronics/IBM _____ \$199.95

320K DISK DRIVES

Tandon TM-100-2 double-sided, double-density 320K disk drive. Original equipment drive on IBM PC

MSM-551002 Full size Tandon _____ \$224.95
MSM-991004 Half-height 320K drive _____ \$199.95
MSM-660551 Teac Half-height _____ \$239.95

HARD DISK For IBM PC

Hard disk with controller, software, and P/S

MSH-990205 5MB system _____ \$1395.00
MSH-990210 10MB system _____ \$1699.00
MSH-990215 15MB system _____ \$2199.00

SYSTEM CARD—MICROSOFT

From the authors of MS-DOS—up to 256K RAM, serial port, parallel printer port, clock calendar, plus RAM drive disk emulation, print spooler, time utilities, and terminal emulation software. DOS 1.1 or 2.0 compatible

MEX-16064A 64K system card _____ \$279.95
MEX-16256A 256K system card _____ \$429.95

HI-RES COLOR MONITORS

Only the best Quadchrome or Princeton HX-12, 690 x 480 resolution, 16 brilliant colors, special .31mm dot pitch tube, includes FREE! cable

VDC-241301 Quadram Quadchrome _____ \$549.95
VDC-241401 Princeton Graphics HX-12 _____ \$529.95

AMDEK MONITORS

Full line of high quality monochrome and color video monitors

VDM-801270 Video 310 Amber (IBM) _____ \$159.95
VDC-801320 Color II (RGB) _____ \$429.95
VDC-801330 Color III (RGB) _____ \$399.95
VDC-801340 Color IV (Analog RGB) _____ \$775.00

HERCULES GRAPHIC CARD

Two pages of ultra-high resolution text and graphics, 720 x 348, compatible with Lotus 123, Visicalc, dBASE II, etc. Includes parallel printer port

IOV-5010A Hercules graphic card _____ \$359.95

QUADCOLOR I & QUADCOLOR II

Quadcolor I delivers standard IBM PC color and graphics, add Quadcolor II and hi-resolution (640 x 200) color graphics are possible

IOV-4010A Quadcolor I basic board _____ \$234.95
IOV-4020A Quadcolor II add on _____ \$229.95

PLANTRONICS COLOR PLUS

Up to 16 colors, 80 characters, bi-planar technology, includes parallel printer port

IOV-6010A Plantronics Color Plus _____ \$379.95

OKIDATA IBM KIT

Okidata's new plug-n-play ROMs for Oki 82, 83, 84, 92, and 93 printers are fully IBM PC compatible! 412 ASCII characters, full graphics, complete Epson emulation, and near letter quality printing not available with Epson

PRA-43086 Plug-n-play for 92 _____ \$49.95
PRA-43087 Plug-n-play for 93 _____ \$49.95
WCA-2536A IBM PC to Oki or Epson cable _____ \$32.95
PRA-43084 Plug-n-play for 82 _____ \$39.95
PRA-43085 Plug-n-play for 83 _____ \$39.95
PRA-43089 Plug-n-play for 84 _____ \$89.95

NEC 3550 LETTER QUALITY

Only full IBM PC compatible letter quality printer available—why settle for less!

PRD-35501 NEC 3550 printer _____ \$1799.95

64K RAM UPGRADE For IBM PC

High speed RAM upgrade kit with parity (error detection) and one year warranty

MEX-64100K 64K kit for IBM PC _____ \$49.95

HAYES SMARTMODEMS

300 and/or 1200 baud direct connect, auto answer-auto dial, pulse or touch tone, auto baud rate selection. 1200B is a plug-in board for IBM PC only and includes Smartcom II FREE!

IOM-5550A 1200B with Smartcom II _____ \$399.95
IOM-5500A Smartmodem 1200 _____ \$475.00
IOM-5400A Smartmodem 300 _____ \$199.95
SFP-5500550M Smartcom II _____ \$79.95

THE BEST SOFTWARE For IBM PC

We have taken the top rated programs and reduced the price making them a super value

LOTUS 1 2 3 Best spreadsheet
SFP-24001020M Lotus 123 (1A) _____ \$329.95
dBASE II Best Data base
SFP-11210100M Ashton-Tate dBASE II _____ \$429.95
CROSSTALK Best communications package
SFP53770100M MicroStuff Crosstalk _____ \$129.95

THE BEST MOUSE

From Mouse Systems. Optical mouse with no moving parts—nothing to wear out, includes software and is compatible with all major software packages

SYX-14100A Mouse Systems mouse _____ \$249.95

MICROSOFT MOUSE

Mechanical mouse from the folks that wrote your PC's operating system. Includes software and cables

SYX-16100A Microsoft mouse _____ \$149.95

PLACE ORDERS TOLL FREE!

Continental USA
(800) 421-5500

Inside California
(800) 262-1710

Los Angeles Area
(213) 973-7707

for your APPLE



SUPER DISKETTE SPECIAL!

We bought out a major manufacturer's overstock, and we are passing the savings on to you! Single sided double density, package of ten FREE plastic case
MMD-5120103 Apple diskettes \$18.95

DISK DRIVE For APPLE

Totally Apple compatible, 143,360 bytes per drive on DOS 3.3 full one year factory warranty, half-track capability, reads all Apple software, plugs right into Apple controller as second drive, DOS 3.3, 3.2.1 Pascal, & CP/M compatible

MSM-431010 Standard Disk II size \$199.00
MSM-431030 Controller only \$60.00

HALF-HEIGHT DRIVE For APPLE

Totally Apple compatible. Works with all Apple software and controllers. Faster and quieter than most other drives, yet only half the size!

MSM-581010 Half-height \$199.95

DUAL 8-inch DISK DRIVES

Up to 2 Megabytes for your Apple, two double density 8 inch slimline disk drives, cabinet, power supply, cable, controller, and software. Compatible with DOS, CP/M, Pascal and IBM 3740 formats

1 MEGABYTE SUB SYSTEM \$1195.00
2 MEGABYTE SUB SYSTEM \$1395.00

GRAPPLER PLUS—Orange Micro

The ultimate parallel printer graphics interface card with many new features, now at a new low price!

IOP-2300A Grappler Plus \$119.95

BUFFERED GRAPPLER PLUS

Combines the flexibility of the Grappler + with the convenience of the Bufferboard, all on a single board
IOP-2320A Buffered Grappler+ \$175.00
IOP-2325A Buffered Grappler+ \$225.00

BUFFERBOARD—Orange Micro

Add up to 20 pages of text output buffering to your existing Grappler + board

IOP-2310A Bufferboard \$135.00

ASIO—SSM/TRANSEND

RS232 serial I/O board for Apple, works with printers or modems, 110 to 9600 baud, DOS, CP/M and Pascal compatible

IOI-2052A ASIO \$119.95

A488—SSM/TRANSEND

Allows Apple II, IIe, II+ to operate as an inexpensive IEEE 488/GPIB instrument controller. Comes with cable

IOX-7488A A488 \$339.95

8088 COPROCESSOR—PCPI

Similar in concept to Z80 cards for Apple, but uses 8088, the same microprocessor used in IBM PC. Complete with MSDOS and MBASIC

CPX-88088A PCPI 88 card \$459.95

FAN/POWER CENTER For APPLE

Cooling fan for your overheated Apple II, II+, or IIe; also includes power switch and two switched outlets with voltage protection circuitry

SYA-1520A Apple fan \$59.95

NEW! MICROMODEM IIe HAYES

The standard in direct-connect, plug-in modem cards for Apple. 110-300 baud. Includes FREE Smartcom I

IOI-2000A Micromodem IIe \$529.00

KOALA PAD—KOALA TECH.

A touch sensitive pad that functions like a joystick or mouse, allowing you to move the cursor around the screen with the touch of a finger. Complete with software

SYA-1518A Koala Pad \$99.95

CP/M 3.0 CARD For APPLE—ALS

The most powerful card available for your Apple!

6 MHz, Z-80B, additional 64K RAM, CP/M 3.0 plus, 100% CP/M 2.2 compatibility, C Basic, CP/M graphics, 300% faster than any other CP/M for Apple

CPX-62810A ALS CP/M card \$299.00

Z CARD For APPLE—ALS

Two computers in one, Z-80 and 6502, more than doubles the power and potential of your Apple, includes Z-80 CPU card, CP/M 2.2 and complete manual set, Pascal compatible, one year warranty

CPX-62800A A & T with CP/M 2.2 \$139.00

PRINTER CARD & CABLE

For Apple. Standard centronics parallel interface for Epson, Okidata, C. Itoh, Gemini, NEC, Comrex, etc. Includes printer cable and supports graphics

IOP-2100A Printer card & cable \$49.95

80 COLUMN CARD

80 column x 24 line video card for Apple II addressable 25th status line, normal/inverse or high/low video, 128 ASCII characters, upper and lower case, 7 x 9 dot matrix with true descenders, CP/M, Pascal and Fortran compatible, 40/80 Hz, 40/60 column selection from keyboard. Best 80 column card!
 2 year warranty

IOV-2450A Viewmax 80 \$139.95
IOV-2455A Visicalc/Easywriter Preboot \$24.95

16K RAM CARD For APPLE II

Expand your Apple II 64K, use as language card, full one year warranty. Why spend \$175.00?

MEX-16700A Save over 115.00 \$49.95

DISPATCHER By ALS IOI-1000A \$99.95

MICROFAZER—QUADRAM

The Microfazer stand-alone printer buffers are available in any configuration of serial or parallel input, with serial or parallel output. All are expandable up to 64K of memory (about 30 pages of 8 1/2 x 11 text); the parallel-to-parallel version is expandable to 512K Copy and pause feature included

Parallel/Parallel
IOP-26008 8K List 169.00 \$139.95
IOP-26032 32K List 225.00 \$164.95
IOP-26128 128K List 445.00 \$269.95

Serial/Parallel
IOP-27008 8K List 199.00 \$169.95
IOP-27032 32K \$199.95

Parallel/Serial
IOP-29008 8K List 199.00 \$169.95
IOP-29032 32K \$199.95

Serial/Serial
IOP-28008 8K List 199.00 \$169.95
IOP-28032 32K List 220.00 \$199.95

MICROBUFFER PRACTICAL PERIPHERALS, INC

Stand-alone Microbuffers
IOP-2500A Parallel, 32K \$249.95
IOP-2510A Parallel, 64K \$299.95
IOP-2520A Serial, 32K \$249.95
IOP-2530A Serial, 64K \$299.95
IOP-2564K stand alone microbuffer 64K add-on board \$179.00

Microbuffers for Apple II
IOP-2560A Parallel, 16K \$199.95
IOP-2570A Parallel, 32K \$249.95
IOP-2580A Serial, 16K \$199.95
IOP-2590A Serial, 32K \$249.95

Microbuffers for Epson Printers
IOP-2540A Parallel, 16K \$139.95
IOP-2550A Serial, 8K \$139.95

Spring CATALOG

Better than free! Circle 198 on inquiry card.
Just circle bingo card number to receive your free catalog!

JADE

Computer Products

4901 West Rosecrans Avenue, Hawthorne, California 90250

JADIE

Computer Products

DISK DRIVES S-100 BOARDS

QUANTITY LIMITED!

8080 CLOSE-OUT SPECIAL!

S-100 CPU Board with features / Problem Solvers Brand
• 2 serial ports, with handshaking, software selectable baudrates

- On-board 2708 can be shadowed out!
- 8 level priority interrupt controller
- Real Time interrupt clock on-board
- IMSAI front panel connector on-board
- INCLUDES MANUAL AND SCHEMATIC
- For Technical types Sold "AS IS"

CPU-10000A _____ ONLY \$49.95

THREE BOARD SET—CCS

S-100 board set featuring Z80A cpu, 64K of high speed RAM, serial I/O port, double-density disk controller for 5 1/4 inch or 8-inch drives. FREE CP/M 2.2 on 8-inch disk with full manual set, all necessary diagnostic and control software. All boards are assembled and tested with full factory warranty

SPECIAL PACKAGE _____ \$694.95

64K STATIC RAM—JADE

Uses new 2K x 8 static RAMs, fully supports IEEE 696

MEM-99152B Bare board	\$49.95
MEM-99152K Kit less RAM	\$89.95
MEM-32152K 32K kit	\$169.00
MEM-56152K 56K kit	\$225.00
MEM-64152K 64K kit	\$265.00
Assembled & Tested	add \$30.00

EXPANDORAM III

High density memory board, 64K, 128K or 256K

MEM-65064A 64K	\$398.95
MEM-65128A 128K	\$464.95
MEM-65192A 192K	\$524.95
MEM-65256A 256K	\$589.95

I/O-4 SSM MICROCOMPUTER

Two serial I/O ports plus two parallel I/O ports

IOI-1010A A & T _____ \$245.00

ISO BUS—JADE COMPUTER

Silent, simple and on SALE! A better motherboard

6 Slot (5 1/4" x 8 1/2") 19 MHz	
MBS-061B Bare board	\$22.95
MBS-061K Kit	\$39.95
MBS-061A A & T	\$49.95

12 Slot (9 1/4" x 8 1/2") 10 MHz	
MBS-121B Bare board	\$34.95
MBS-121K Kit	\$69.95
MBS-121A A & T	\$89.95

18 Slot (14 1/4" x 8 1/2") 6MHz	
MBS-181B Bare board	\$54.95
MBS-181K Kit	\$99.95
MBS-181A A & T	\$139.95

Priced Too Low To Advertise!

S-100 BOARDS ON SALE!

COMPUPRO, SD SYSTEMS,
CCS, MULLEN, ADC &
JADE COMPUTER

WE WILL TRY TO BEAT ANY
ADVERTISED PRICE IN THIS
MAGAZINE!

ISOBAR

The ISOBAR looks like a standard multi-outlet power strip, but contains surge suppression circuitry and built-in noise filters, plus a 15amp circuit breaker

EME-115105 4 receptacle	\$59.95
EME-115100 8 receptacle	\$69.95

DOUBLE D—JADE COMPUTER

High reliability, double density disk controller

IOD-1200B Bare board & h/wr man	\$59.95
IOD-1200K Kit w/h/wr & st/wr man	\$299.95
IOD-1200A A & T w/h/wr & st/wr man	\$325.00
SFC-59002001F CP/M 2.2 with Double D	\$99.95

THE BUS PROBE

Best selling inexpensive S-100 diagnostic analyzer

TSX-200B Bare board	\$59.95
TSX-200K Kit	\$179.95
TSX-200A A & T	\$199.95

SBC-200 SD SYSTEMS

4 MHz Z-80A CPU with serial and parallel I/O

CPU-30200A A & T	\$339.95
------------------	----------

VERSAFLOPPY II—SD SYSTEMS

Double density disk controller for 5 1/4" and 8"

IOD-1160A A & T with PROM	\$344.95
IOD-1170A Versafloppy III/696 A & T	\$349.95
SFC-55009047F CP/M 3.0 with VF-II	\$80.00

THE BIG Z—JADE

2 or 4 MHz switchable Z-80 CPU board with serial I/O

CPU-30200B Bare board w/manual	\$35.00
CPU-30201K Kit w/manual	\$179.95
CPU-30201A A & T	\$199.00

ULTRA-VIOLET EPROM ERASERS

Inexpensive erasers for industry or home

XME-3100 Spectronics w/o timer	\$69.50
XME-3101 Spectronics with timer	\$94.95
XME-3200 Logical Devices	\$49.95

5 1/4 inch DISK DRIVES

TANDON TM 100-1 SS DD 48 TPI	
MSM-551001 _____	\$225.00 ea 2 for \$195.00 ea
SHUGART SA 400L SS DD 48 TPI	
MSM-104000 _____	\$209.00 ea 2 for \$199.95 ea
TANDON TM 100-2 DS DD 48 TPI	
MSM-551002 _____	\$229.00 ea 2 for \$225.00 ea
MPI B52 DS DD 48 TPI can be substituted for CDC	
MSM-155200 _____	\$275.00 ea 2 for \$270.00 ea
MPI B51 SS DD 48 TPI	
MSM-155100 _____	\$209.00 ea 2 for \$199.00 ea
MPI B91 Single sided, Quad Density 96 TPI	
MSM-155300 _____	\$285.00 ea 2 for \$275.00 ea
MPI B92 Double sided Quad density 96 TPI	
MSM-155400 _____	\$400.00 ea 2 for \$390.00 ea

5 1/4" CABINETS/POWER SUPPLY

END-000216 Single cab w/power supply	\$69.95
END-000226 Dual cab w/power supply	\$85.00

8 inch DISK DRIVES

SIEMENS FDD 100-8 Single sided, double density	
MSF-201120 _____	\$179.00 ea 2 for \$175.00 ea
SHUGART SA 801R Single sided, double density	
MSF-10801R _____	\$355.00 ea 2 for \$349.00 ea
SHUGART SA-851R Double sided, double density	
MSF-10851R _____	\$459.00 ea 2 for \$455.00 ea
QUME DT-8 Double sided, double density	
MSF-750080 _____	\$479.00 ea 2 for \$459.00 ea
TANDON TM 848-1 SS DD thin-line	
MSF-558481 _____	\$369.00 ea 2 for \$359.00 ea
TANDON TM 848-2 DS DD thin-line	
MSF-558482 _____	\$439.00 ea 2 for \$435.00 ea
NEC FD1165 DS DD thin-line	
MSF-851165 _____	\$450.00 ea 2 for \$440.00 ea
NEC FD1164 SS DD thin-line	
MSF-851164 _____	\$360.00 ea 2 for \$350.00 ea

DISK SUB-SYSTEMS JADE

Handsome metal cabinet with proportionally balanced air flow system, rugged dual drive power cable kit, power switch, line cord, fuse holder, cooling fan, nevrmar rubber feet, all necessary hardware to mount two 8-inch disk drives, power supply, and fan, does not include signal cable

Dual 8" Sub-Assembly Cabinet	
END-000420 Bare cabinet	\$49.95
END-000421 Cabinet kit	\$199.95
END-000431 A & T	\$249.95

8" Sub-Systems—Single Sided, Double Density

END-000423 Kit w/2 Siemens FD100-8Ds	\$579.00
END-000424 A & T w/2 Siemens FD100-8Ds	\$595.00
END-000433 Kit w/2 Shugart SA-801Rs	\$939.00
END-000434 A & T w/2 Shugart SA-801Rs	\$969.00

8" Sub-Systems—Double Sided, Double Density

END-000426 Kit w/2 Qume DT-8s	\$1229.00
END-000427 A & T w/2 Qume DT-8s	\$1249.00
END-000436 Kit w/2 Shugart SA-851 Rs	\$1199.00
END-000437 A & T w/2 Shugart SA-851 Rs	\$1219.00

DUAL SLIMLINE SUB-SYSTEMS

Dual 8-inch Slimline Cabinet	
END-000820 Bare cabinet	\$59.95
END-000822 A & T w/o drives	\$164.95

Dual 8-inch Slimline Sub-systems

END-000843 Kit w/2 SS DD drives	\$869.00
END-000844 A & T w/2 SS DD drives	\$879.00
END-000845 Kit w/2 DS DD drives	\$1060.00
END-000846 A & T w/2 DS DD drives	\$1099.00

DISK DRIVE POWER SUPPLY

Sufficient current to power up to three 8" drives	
PSD-206A List Price 149.00	\$89.95

We accept cash, checks, credit cards, or purchase orders from qualified firms and institutions. Prices quoted are for prepaid orders only and are subject to change without notice. Minimum prepaid order \$15.00 California residents add 6 1/2% tax. Export customers outside the U.S. or Canada please add 10% to all prices. Shipping and handling charges via UPS Ground 50¢/lb UPS Air \$1.00/lb minimum charge \$3.00

PRINTERS



MODEMS



SMARTMODEM—HAYES

Sophisticated direct-connect auto-answer/auto-dial modem, touch tone or pulse dialing. RS232C interface programmable

IOM-5500A Smartmodem 1200	\$475.00
IOM-5550A 1200B for IBM PC	\$399.95
IOM-5400A Smartmodem 300	\$199.00
IOK-1500A Hayes Cronograph	\$199.00
IOM-1100A Micromodem 100	\$349.00
IOM-2000A Micromodem IIe	\$259.00

1200 BAUD SMART CAT NOVIATION

103/212 Smart Cat and 103 Smart Cat, 1200 and 300 baud, built-in dialer, auto re-dial if busy, auto answer/disconnect, direct connect, LED readout displays mode analog/digital loopback self tests, usable with multi-line phones

IOM-5241A 300 Baud 103 Smart Cat	\$229.95
IOM-5251A 1200 Baud 212/103 Smart Cat	\$549.95

J-CAT MODEM—NOVIATION

1/5 the size of ordinary modems, Bell 103, manual or auto-answer, automatic answer/originate, direct connect, built-in self-test, two LEDs and audio beeps provide status information

IOM-5261A Novation J-Cat	\$119.00
--------------------------	----------

SMART BUY IN MODEMS SIGNALMAN

Direct connect, low cost, high quality, and state-of-the-art features. Includes FREE! subscription to the Source

MARK I Universal 300 baud, automatic originate/answer selection, RS232C	
IOM-5600A 300b RS-232	\$79.95

MARK VI 300 Baud for IBM PC, auto-answer, auto-dial, plug-in modem board with full communications software included FREE!	
IOM-5630A 300 Baud IBM card	\$159.95

MARK VII Universal 300 baud, auto-answer, auto-dial RS-232 modem	
IOM-5610A Deluxe RS-232 300b	\$149.95

NEW! MARK XII New Universal 1200 Baud auto-answer, auto-dial modem with all the popular features of the Hayes Smartmodem 1200	
IOM-5620A 1200B deluxe modem	\$399.95

EPSON PRINTERS SAVE At Least \$150.00!

CALL US FOR THE BEST DEAL ON THE WORLD'S BEST SELLING LINE OF PRINTERS!

EPSON RX-80 100 CPS w/tractor, graphics	
PRM-29082 A 499.00 Value, Save 200.00	\$299.95
EPSON RX-80FT 100 CPS with FREE graphics	
PRM-29084 Friction & tractor feed	SAVE \$150.00
EPSON MX-80FT 80 CPS with FREE graphics	
PRM-28082 Friction & tractor feed	SAVE \$150.00
EPSON MX-100 100 CPS 15" platen	
PRM-28100 Friction & tractor	SAVE \$150.00
EPSON FX-80 160 CPS with FREE graphics	
PRM-29080 Friction & tractor feed	SAVE \$150.00
EPSON FX-100 160 CPS 15" platen	
PRM-29100 Friction & tractor feed	SAVE \$150.00

OKIDATA—MICROLINE 92 & 93

160 CPS, true correspondence quality printing, full graphics, IBM PC compatible (optional), handles single sheet as well as fan-fold paper, professional design construction and quality

PRM-43092 Oki 92 parallel List 699.00	\$479.95
PRM-43093 Oki 93 parallel List 1199.00	\$795.95
PRA-43181 2K serial board	\$115.00
PRA-43086 IBM PC ROMS for 92	\$49.95
PRA-43087 IBM PC ROMS for 93	\$49.95
PRA-43080 Extra ribbon (2)	\$9.95
PRA-43088 Tractor for Oki 92	\$54.95

MICROLINE 82, 83, & 84

120 CPS (82, 83) 200 CPS (84), industry standard printers, serial and parallel interfaces, true lower case descenders, handles single-sheet as well as fan fold

PRM-43082 Oki 82 List Price 599.95	\$379.95
PRM-43083 Oki 83 w/ FREE! tractor	\$625.95
PRM-43084 Oki 84 parallel List \$1399.00	\$925.00
PRM-43085 Oki 84 serial List 1499.00	\$995.00
PRA-43081 2K serial board	\$159.95
PRA-43080 Extra ribbons 82/92, 83/93	\$9.95
PRA-43088 Tractor for Oki 82	\$54.95
PRA-43180 Ribbons 83, 84, 93	\$9.95

GEMINI 10X & 15X

Star Micronics—up to 120 CPS, full graphics, friction and tractor feed, Epson FX-80 compatible

PRM-66010 Gemini 10X	SAVE \$150.00
PRM-66015 Gemini 15X	SAVE \$150.00
PRA-66200 Serial board, G-10, G-15	\$69.00
PRA-66202 Serial board, G-10X, G-15X	\$55.00
PRA-66206 10X, 15X 4K serial	\$109.00

NEW! DELTA 10

160 CPS, up to 16K buffer, serial and parallel interfaces, graphics friction and tractor. FX-80 compatible

PRM-66120	Save \$150.00
-----------	---------------

COMREX CR-II

Best buy in letter quality printers. NEW! from Comrex! full featured letter quality printer, FREE! 5K buffer, logic seeking bi-directional printing, boldface proportional spacing, double-strike, backspace, underline, true super script and sub script, drop in daisy wheel cartridge

PRD-11101 CR-II parallel	\$495.00
PRD-11102 CR-II serial	\$589.95
PRA-11100 Tractor option	\$99.95
PRA-99700 Cut sheet feeder	\$189.95
PRA-11115 Keyboard option	\$179.95

SILVER REED EXP-550

Economical daisy wheel printer with 200 words per minute (18 CPS), full 15-inch platen, Diablo 630 protocol, 10, 12, 15 pitch or proportional printing. Very quiet, very reliable; a bargain in the under \$1000, letter quality printer market

PRD-52001 Parallel, List 895.00	\$669.00
PRD-52002 Serial, List 995.00	\$775.00
PRA-52000 Tractor, List 159.95	\$129.00

Save



MONITORS



AMDEK MONITORS

Full line of high quality monochrome and color video monitors

VDM-801270 Video 310 Amber (IBM)	\$156.00
VDM-801260 Video 300 Green	\$135.00
VDM-801265 Video 300 Amber	\$149.00
VDC-801310 Color-I (composite)	\$285.00
VDC-801320 Color-II (RGB)	\$425.00
VDC-801325 Color-II plus (analog RGB)	\$435.00
VDC-801330 Color III (RGB)	\$399.00
VDC-801340 Color IV (analog RGB)	\$775.00
VDA-80990 DVM-2 (Apple II/II+)	\$129.00
VDA-809901 DVM-80E (Apple IIe)	\$139.00

BEST MONITORS AVAILABLE!

Ultra-high resolution, up to 22 MHz, 1000 lines per inch, amber or green phosphor, FREE! tilt and swivel base, US manufacturer

VDM-881220 12" green 22 MHz	\$149.95
VDM-881210 12" amber 22 MHz	\$149.95
VDM-880920 9" green 18 MHz	\$139.95
VDM-880910 9" amber 18 MHz	\$139.95

12-inch GREEN—ZENITH

15 MHz, 40 or 80 column

VDM-201201 12" green	\$94.95
----------------------	---------

STARWRITER F10

High speed letter quality printer, 40 CPS daisywheel. Extensive built-in word processing functions, up to 15 inch paper width. Uses standard Diablo style print-wheels

PRD-22010 F10/parallel	\$1125.00
------------------------	-----------

MANNESMAN-TALLY

Spirit 80 CPS 10" parallel	PRM-32100	\$329.00
160L 160 CPS 10"	PRM-32161	\$588.00
180L 160 CPS 15"	PRM-32181	\$828.00

Place Orders Toll Free!

Continental U.S.A.
(800) 421-5500

Inside California
(800) 262-1710

Los Angeles Area
(213) 973-7707

Circle 199 on inquiry card.

TAXAN



**AMBER & GREEN
\$129 \$119
12" MONITORS**

For complete specifications, see page 24 of our New '83/'84 Engineering Selection Guide.

Part Number	Description	List Price	SALE Price
BATAKXG12H	Green Screen (Sh. Wt. 18 lbs.)	\$179.00	\$119.00
BATAKXG12HUY	Amber Screen (Sh. Wt. 18 lbs.)	\$189.00	\$129.00

SAVE ON RGB MONITORS, TOO!

BATAKXRGB1	Medium Resolution (30 lbs.)	\$399.00	\$329.00
BATAKXRGB3	Super-High Resolution (30 lbs.)	\$699.00	\$569.00
BATAKXRGB420	IBM™ Styling Hi-Res RGB (30 lbs.)	\$699.00	\$569.00

NEW! Star
MICRONICS-INC

**POWER TYPE
18 CPS DAISYWHEEL
PRINTER**

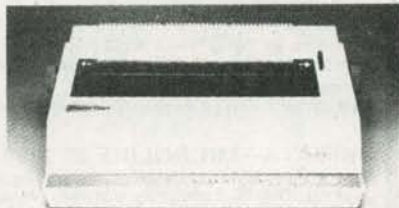

\$499.00

- Parallel and Serial Interface • Four Print Sizes
 - Wheels and Ribbons are QUME Compatible
 - Selector Switches for Columns, Line Spacing and Paper Length
- BASTRPOWERTYPE Daisywheel Printer (Sh. wt. 22 lbs.) **\$499.00**

**MANNESMANN
TALLY**



**Letter Quality
Dot Matrix Printer**

For complete specifications, see page 41 of our New '83/'84 Engineering Selection Guide

- 160 cps • 40 cps (Letter Quality)
 - Serial & Parallel Interface • Double wide characters
 - Tractor and friction feed • "Bullet-Proof" cast frame with metal cabinet
- Not the Cheapest —
Just the Best Dollar Value!**
- | | | |
|-------------|---------------------------------------|-----------------|
| BATALMT160L | 80 column / 160 cps (21 lbs.) | \$589.00 |
| BATALMT180L | 132 column / 160 cps (28 lbs.) | \$829.00 |
| BATALNTR160 | Replacement Ribbon for MT160L (1 lb.) | \$15.75 |
| BATALNTR180 | Replacement Ribbon for MT180L (1 lb.) | \$17.80 |

CompuPro The World's Largest Dealer of S-100 Boards

SDS SYSTEMS
A SYNTech COMPANY

CPU BOARDS

Part Number	Description	List Price	SALE Price
BAGBT51068	CPU 68K A&T 8MHz	\$ 695.00	\$ 595.00
BAGBT51568	CPU 68K CSC 10MHz	\$ 850.00	\$ 765.00
BAGBT51086	Co-Processor w/8086 only A&T's	750.00	\$ 675.00
BAGBT51586	Co-Processor w/8086 only CSC's	850.00	\$ 765.00
BAGBT51067	CPU 8086/8087 A&T	\$1050.00	\$ 939.00
BAGBT51567	CPU 8086/8087 CSC	\$1150.00	\$1065.00
BAGBT51080	CPU 8085/88 A&T	\$ 495.00	\$ 389.00
BAGBT51580	CPU 8085/88 CSC	\$ 595.00	\$ 487.87
BAGBT51060	3/6MHz CPU-Z A&T	\$ 325.00	\$ 279.00
BAGBT51560	3/6MHz CPU-Z CSC	\$ 425.00	\$ 347.87

DISK CONTROLLER BOARDS

Part Number	Description	List Price	SALE Price
BAPDB171ACPM	DISK 1 (A&T) w/CP/M™ 2.2	\$670.00	\$489.00

When purchased with two 8" disk drives: \$450.00

BAGBT54018	DISK 1 Floppy controller (A&T)	\$495.00	\$425.00
BAGBT41000	CP/M™ 2.2 for 280/8085 w/manuals & BIOS, 8" S/D Disk		\$148.95
BAGBT41050	CP/M-86™ for CPU 8085/88 & CPU 8086/87 CPUs w/manuals, BIOS, 8" S/D Disk		\$249.00
BAGBT54025	DISK 2 8" hard disk controller w/CP/M™ 2.2 (A&T)	\$795.00	\$725.00
BAGBT54030	DISK 3 ST-506 type 5 1/4" hard disk controller w/CP/M-80™ & CP/M-86™ (A&T)	\$795.00	\$725.00

I/O BOARDS

BAGBT56010	System Support 1 Multifunction I/O (A&T)	\$450.00	\$375.00
BAGBT56010/56531	SS1 w/8231 Math Chip A&T	\$645.00	\$570.00
BAGBT56010/56320	SS1 w/8232 Math Chip A&T	\$645.00	\$570.00
BAGBT53030	Interface 3 - 8 port serial (A&T)	\$699.00	\$599.00
BAGBT53040	Interface 4 - 3 Serial, 1 Centron-ics Parallel, 1 Parallel (A&T)	\$450.00	\$389.00

8/16 BIT MEMORY BOARDS

BAGBT52016	RAM 16 12MHz 32K Static A&T's	\$550.00	\$ 495.00
BAGBT52021	RAM 21 12 MHz 128K Static A&T's	\$995.00	\$ 895.00
BAGBT52022	RAM 22 12MHz 256K Static A&T's	\$1750.00	\$1549.00
BAGBT52012	M-Drive/H 512K RAM Disk A&T's	\$1475.00	\$1195.00

MAINFRAMES

BAGBT1200	20 Slot Desk Top (A&T)	\$925.00	\$795.00
BAGBT1250	20 Slot Rack Mount (A&T)	\$975.00	\$850.00

For more CompuPro Specifications see page 2-33 of our New Catalog

Vector

Manufactured by Vector Electronic Co. under license from CompuPro

BAVCT8800GFB	Interface 1, 2-Serial (A&T)	\$295.00	\$219.00
BAVCT8800GF2B	Interface 2, 3-Par, 1-Ser (A&T)	\$325.00	\$239.00
BAVCT8800GR17B	RAM 17 64K 10MHz, Static RAM (A&T)	\$450.00	\$389.00

Part Number	Description	List Price	SALE Price
BASDS38095	SBC-300 4MHz Z80A CPU A&T's	\$741.00	\$ 619.00
BASDS38092	SBC-300 6MHz Z80B CPU A&T's	\$825.00	\$ 689.00
BASDS38007	Z80 Starter System A&T	\$ 450.00	\$ 399.00
BASDS38088	ExpandoRAM IV 256K A&T	\$1145.00	\$ 975.00
BASDS38089	ExpandoRAM IV 256K w/EDC A&T	\$1990.00	\$1675.00
BASDS38097	ExpandoRAM III/696 256K	\$ 825.00	\$ 749.00
BASDS38076	PROM-100 w/software A&T	\$ 285.00	\$ 219.00
BASDS38082	RAM Disk 256K A&T	\$ 875.00	\$ 775.00
BASDS38081	ROM Disc 128K A&T	\$ 350.00	\$ 319.00
BASDS38096	I/O-8 4-Port Async Ser A&T	\$ 600.00	\$ 549.00
BASDS38093	I/O-8 8-Port Async Ser A&T	\$ 695.00	\$ 589.00
BASDS38094	I/O-8 4, Sync, 4 Async, 8-Port Serial I/O A&T	\$ 795.00	\$ 699.00

BASDS38099	Versafloppy III Floppy & ST-506's Hard Disk Controller	\$ 895.00	\$ 759.00
BAPDBVF339145*	w/5 1/4" unbanked CP/M™ 3.0	\$1083.00	\$ 888.00
BAPDBVF339146*	w/8" unbanked CP/M™ 3.0	\$1083.00	\$ 888.00
BAPDBVF339147*	w/5 1/4" banked CP/M™ 3.0	\$1083.00	\$ 888.00
BAPDBVF339148*	w/8" banked CP/M™ 3.0	\$1083.00	\$ 888.00
BASDS38093	Versafloppy II/696 (A&T)	\$ 400.00	\$ 344.00
BAPDBVF239141*	w/5 1/4" unbanked CP/M™ 3.0	\$ 588.00	\$ 424.00
BAPDBVF239142*	w/8" unbanked CP/M™ 3.0	\$ 588.00	\$ 424.00
BAPDBVF239143*	w/5 1/4" banked CP/M™ 3.0	\$ 588.00	\$ 424.00
BAPDBVF239144*	w/8" banked CP/M™ 3.0	\$ 588.00	\$ 424.00

*CP/M-Plus™ (3.0) configured for the SBC-300
See Complete Specifications on Pages 12-25 Of Our '83/'84 Engineering Selection Guide

Octagon

BOARD LEVEL PRODUCT

BAOCTCP0816	8/16 Bit SBC (A&T)	\$ 895.00	\$ 795.00
BAOCT8087NDP	8087 for CPU 8/16		\$ 300.00
BAOCTCPM86	CP/M-86™		\$ 150.00
BAOCTCONCPM86	Concurrent CP/M-86™		\$ 195.00
BAOCTMPM86	MP/M-86™		\$ 495.00
BAOCTHDC	ST-506 Hard Disc Controller	\$ 595.00	\$ 525.00
BAOCTHDSUB19	19.2Mb Hard Disc Subsystem	\$2295.00	\$ 195.00
BAOCTDS26T0D	256K Static RAM (A&T)	\$1850.00	\$1719.00
BAOCTDS12K	512K Dynamic RAM (A&T)	\$1450.00	\$1345.00

See Specifications on Pages 12-27 Of Our '83/'84 Engineering Selection Guide

COMPLETE OCTAGON 8/16™ SYSTEMS

BAOCT816SMPM	w/256K Static RAM & MP/M-86™	\$7350.00
BAOCT816SCPM	w/256K Static RAM & Concurrent CP/M-86	\$7350.00
BAOCT816DMPM	w/512K Dynamic RAM & MP/M-86	\$7350.00
BAOCT816DCPM	w/512K Dynamic RAM & Concurrent CP/M-86	\$7350.00

See Complete Specifications on Page 5 Of Our New '83/'84 Engineering Selection Guide

MACROTECH International Corp.

S-100 Boards



See Page 16 Of Our New '83/'84 Engineering Selection Guide for Complete Specifications

Ordering Information: The 256K and 384K versions include the fully socketed Host card. The 512K and larger versions also include the fully socketed "piggy-back" card.

Part Number	Description	List Price	SALE Price
BAMACMAX256	256K Dynamic RAM (A&T)	\$1125.00	\$1165.00
BAMACMAX384	384 Dynamic RAM (A&T)	\$1467.00	\$1395.00
BAMACMAX512	512K Dynamic RAM (A&T)	\$1880.00	\$1795.00
BAMACMAXM	1 MEG Dynamic RAM (A&T)	\$2449.00	\$2325.00
BAMACMAXTM	MAX Technical Manual		\$ 15.00
BAMACMAXVSK	MAX Virtual Disk Software supplies on 8" S/D Disk		\$ 25.00
BAMACM3	Memory Mapping Option		\$ 91.00

Attention CompuPro CPU 8085/88 Users: You must order the CPU modification hardware to insure complete compatibility.

BAMACGMT0D	Hardware modification for CompuPro CPU 8085/88	\$ 10.00	
------------	--	----------	--

DISK DRIVES

5 1/4" Hard Disk

Part Number	Description	SALE PRICE
BANCP1302	Micropolis 20.4/25.9 Mb (12 lbs.)	\$1465.00
BANCP1303	Micropolis 33.9/43.2 Mb (12 lbs.)	\$1875.00
BANCP1304	Micropolis 40.8/51.9 Mb (12 lbs.)	\$2195.00
BATNDTM501	Tandon 6 Mb (9 lbs.)	\$ 749.00
BATNDTM502	Tandon 12 Mb (9 lbs.)	\$ 895.00
BATNDTM503	Tandon 19 Mb (9 lbs.)	\$1049.00
BALIH05002	Dual Hard Disk Enclosure	\$ 395.00

5 1/4" Floppy Disk Drives

BAMP151*	MPI Full Height SS 48TPI (5 lbs.)	\$200.00
BAMP152*	MPI Full Height DS 48TPI (5 lbs.)	\$270.00
BAMP191*	MPI Full Height SS 96TPI (5 lbs.)	\$275.00
BAMP192*	MPI Full Height DS 96TPI (5 lbs.)	\$400.00
BAMP1501	MPI 1/2-Height SS 48TPI (4 lbs.)	\$260.00
BAMP1502	MPI 1/2-Height DS 48TPI (4 lbs.)	\$300.00
BAMP1901	MPI 1/2-Height SS 96TPI (4 lbs.)	\$300.00
BAMP1902	MPI 1/2-Height DS 96TPI (4 lbs.)	\$355.00
BATNDTM1001	Tandon Full Height SS 48TPI	\$225.00
BATNDTM1002	Tandon Full Height DS 48TPI	\$260.00
BATNDTM1014	Tandon Full Height DS 96TPI	\$390.00

*Replace with M for MPI Door, or S for Shugart SA400 Type Door

8" Floppy Disk Drives

BASHU801R	Shugart Full Height SS (18 lbs.)	\$369.00
BASHU851R	Shugart Full Height DS (18 lbs.)	\$525.00
BAQMEDT8	Qume Full Height DS (18 lbs.)	\$475.00
BAMITM289463B	Mitsubishi Full Height DS (18 lbs.)	\$380.00
BAMP1415	MPI Full Height SS (11 lbs.)	\$380.00
BAMP1425	MPI Full Height DS (11 lbs.)	\$460.00
BAMP141D	MPI Dual 1/2-Height SS (22 lbs.)	\$760.00
BAMP142D	MPI Dual 1/2-Height DS (22 lbs.)	\$830.00
BAMP141M	MPI 1/2-Height SS (9 lbs.)	\$380.00
BAMP142M	MPI 1/2-Height DS (9 lbs.)	\$460.00
BATNDTM8481	Tandon 1/2-Height SS (9 lbs.)	\$395.00
BATNDTM8482	Tandon 1/2-Height DS (9 lbs.)	\$495.00

ONE IN PRICE — NUMBER ONE IN SERVICE

HITACHI DUAL TRACE SCOPES
Hitachi Denshi, Ltd.

NOW WITH A
5 YEAR WARRANTY!!

NEW LOWER PRICES!

FOR COMPLETE SPECIFICATIONS ON HITACHI OSCILLOSCOPES,
SEE PAGES 82 & 83 IN OUR '83/'84 ENGINEERING SELECTION GUIDE

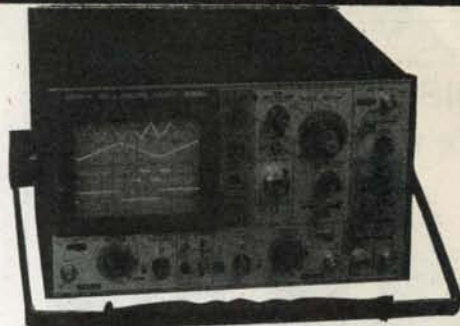

20MHz Low Profile
BAHITV222 List Price: \$695.00
SALE PRICE:
\$595.00
(Shipping Weight: 17 lbs.)

40MHz with Delay Line
BAHITV422 List Price: \$895.00
SALE PRICE:
\$749.00
(Shipping Weight: 17 lbs.)

60MHz with Trigger View
BAHITV650F List Price: \$1195.00
SALE PRICE:
\$995.00
(Shipping Weight: 31 lbs.)

100MHz Delayed Sweep/Quad Trace
BAHITV1050F List Price: \$1595.00
SALE PRICE:
\$1395.00
(Shipping Weight: 31 lbs.)

A UNIT OF GENERAL SIGNALS **GS**
SOLA
Uninterruptible Power System



For more specifications, see page 94 of our New '83/'84 Engineering Selection Guide.

A mini UPS goes one step further than a aminicomputer regulator. It provides the same voltage, noise, and brownout protection plus maintains power to keep equipment running smoothly during a blackout. When a power failure occurs, the internal maintenance free battery continues powering the inverter without the use of any switching devices. This provides uninterrupted, conditioned AC power to the critical load.

PORTABLE 120VAC 60Hz UNINTERRUPTIBLE POWER SYSTEMS

Part Number	Mx. Out. VA rating/ Time	Dimensions H x W x D	Approx. Weight	PRICE	
				List	SALE
BASLA260050400281	400/20min	12x19x11	95lbs	\$1617.00	\$1406.00
BASLA260050750300	750/10min	12x19x11	125lbs	\$1722.00	\$1497.00
BASLA401751BA0	Add-on battery pack (120 lbs.)			\$1014.00	\$882.00

The Micro/Mini Computer Ultra Isolated Regulator provides instantaneous voltage regulation, and ultra isolation from both transverse and common mode noise for any type of load. It is particularly applicable in systems involving mini or microcomputers, POS equipment, industrial control equipment, or data terminals.

MINICOMPUTER REGULATORS
With Line Cord

Part Number	Dimensions	Weight	List Price	Our Price
BASLA8313070	70 12x 6x 6	10lbs	\$192.05	\$159.00
BASLA8313114	140 12x 6x 6	18lbs	\$251.85	\$209.00
BASLA8313125	250 14x 8x 8	31lbs	\$300.15	\$249.00
BASLA8313150	500 17x 9x 9	47lbs	\$416.30	\$349.00
BASLA8313175	750 17x 9x 9	60lbs	\$530.15	\$439.00
BASLA8313210	1000 17x 9x 9	75lbs	\$614.10	\$519.00
BASLA8313220†	2000 17x11x11	108lbs	\$1044.20	\$889.00

† Unit is supplied with 30 amp twist type plug and receptacles.

EPD AC SURGE PROTECTORS FOR YOUR COMPUTER
THE LEMON™ SOURS SURGES

Part Number	Description	List Price	Our Price
BAEPOLEMGH	6 outlet wall mount w/power switch	\$59.95	\$44.95
BAEPODIME	6 outlet 4 1/2' cord w/power switch	\$89.50	\$69.95

(Shipping weight on above items 4 lbs. each)

EMI-RF FILTERED AC SURGE PROTECTOR

BAEPOORANGE	6 outlet 4 1/2' cord w/power switch	\$139.95	\$104.95
BAEPOPEACH	3 outlet wall mount	\$97.50	\$74.95

(Shipping weight on above items 4 lbs. each)

AC POWER LINE MONITOR / SURGE PROTECTOR

BAEPOHAWK	(Sh. Wt. 6 lbs.)	\$195.00	\$149.00
-----------	------------------	----------	----------

SPECIAL PURCHASE DISKETTES!!
TDK
8" DOUBLE DENSITY

BATDKF1S
SINGLE SIDED
\$19.95
PER BOX OF 10

BATDKF2D
DOUBLE SIDED
\$29.95
PER BOX OF 10

ATARI & COMMODORE PLUG AND RUN PRINTERS!
Complete with Built-in Interface Cables!



AXIOM

1 Year Warranty!

BAAXMAT100A For ATARI (Sh. Wt. 11 lbs.)
BAAXMCD100A For COMMODORE (11 lbs.)
BAAXMGP100A 30 cps; 80 col. dot matrix printer (11 lbs.) Parallel Interface
\$229
\$199.00

1200 BAUD MODEM SALE

For more details of Modems, see pages 38 & 39 of our New Catalog.



U.S. ROBOTICS INC.

AUTO DIAL/ AUTO ANSWER

FREE SOFTWARE!

Part Number	Description	List Price	SALE Price
BAPOBPASSTELB	Password Modem w/Communication Software 8" CP/M*	\$528.00	\$398.00
BAPOBPASSTELS	Password Modem w/Communication Software 5 1/4" Apple	\$528.00	\$398.00
BAPOBASIALTELB	Auto Dial 212A Modem w/Communication Software 8" CP/M*	\$678.00	\$495.00
BAPOBADIALTELS	Auto Dial 212A Modem w/Communication software 5 1/4" Apple	\$678.00	\$495.00
BAPOBS100TELB	S-10 Modem Card w/operating software on 8" CP/M* diskette	\$528.00	\$398.00

D.C. HAYES

Part Number	Description	List Price	SALE Price
BADCH0400P	1200 Baud Smartmodem	\$695.00	\$514.95
BADCH0200P	300 Baud Smartmodem	\$279.00	\$229.00
BADCH0300P	Chronograph	\$249.00	\$199.00
BADCH0100P	MicroModem 100	\$399.00	\$349.00
BADCH000P	MicroModem II	\$379.00	\$299.00
BADCH1200B	IBM-PC™ Modem card	\$599.00	\$499.00

RIXON

1200 Baud Direct Connect w/10 Number Memory

BARIXR212A	1200 Baud Stand Alone unit	\$495.00	\$449.00
BARIXPC212A	1200 IBM PC™ modem (2 lbs.)	\$495.00	\$449.00
BARIXPC001	IBM PC™ Modem Software (1 lb.)		\$ 89.00
BAPOBRIXIBM	IBM Modem & Software Together (3 lbs.)		\$539.00

Are You A Regular Customer Of PRIORITY ONE ELECTRONICS?

Look for your January Issue of **PRIORITY INTERRUPT** — a NEW Sixteen-Page Newsletter Containing:

- Special Pricing Available ONLY Through Our Newsletter
- Tech Tips • Profiles of our major suppliers
- In-depth product reviews • Customer "Talk-Back"
- Meet the Priority One People • Application Notes

Phone Today and Get On Our Priority Interrupt Mailing List!

Don't Miss Out On This Unique Offer!



PRIORITY ONE ELECTRONICS

9161 Deering Ave., Chatsworth, CA 91311-5887



ORDER TOLL FREE (800) 423-5922 - CA, AK, HI CALL (213) 709-5111

Terms: U.S. VISA, MC, BAC, Check, Money Order, U.S. Funds Only. Ca residents add 6 1/2% Sales Tax. MINIMUM PREPAID ORDER \$15.00. Include MINIMUM SHIPPING & HANDLING of \$3.00 for the first 3 lbs. plus 40¢ for each additional pound. Orders over 50 lbs. sent freight collect. Just in case, include your phone number. Prices subject to change without notice. We will do our best to maintain prices through January, 1984. Many quantities are limited. Sorry, no rainchecks, no refunds or exchanges on sale merchandise. Credit card orders will be charged appropriate freight. Sale prices for prepaid orders only. We are not responsible for typographical errors.

Circle 294 on inquiry card.

U.S. MICRO SALES

★ MADE IN USA ★ BUY FACTORY DIRECT ★

DISK DRIVE SPECIALS

We've Lowered Our Prices

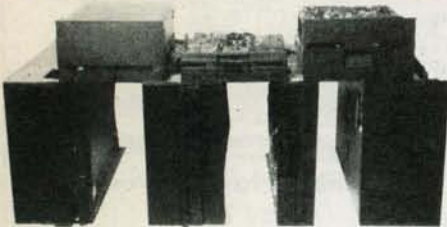

Offering A Complete Selection And...
THE LOWEST PRICES IN BYTE!

8" Shugart 801R SS/DD — The Industry Standard	\$355.00
8" Shugart 851R Double Sided 1.2 Meg — The Old Reliable	457.00
8" Qume Datarak-8 DS/DD "THE BEST" of the floppies	479.00
8" Mitsubishi Full Height Double Sided 1 Year Parts + Labor	445.00
8" Mitsubishi Thinline DS/DD 1 Year P+L Direct Drive	465.00
8" Tandon 848-1 Slimline SS/DD 600K BYTES D.C. Motor	355.00
8" Tandon 848-2 Slimline Double Sided 1.2 Meg. D.C. Motor	475.00
8" Siemens 100-8 SS/DD ON SALE NOW!!! But How Long?	169.00
5 1/4" Mitsubishi Full height 96T.P.I. DS/DD 750K M4852	295.00
5 1/4" Mitsubishi Slimline 96T.P.I. DS/DD 750K M4853	315.00
5 1/4" Qume 142 Slimline DS/DD	375.00
5 1/4" Tandon TM-100-2 I.B.M. PC Add-on! DS/DD 48 T.P.I.	259.00
5 1/4" Tandon TM 100-4 DS/DD 96T.P.I. 750K	369.00

★ WINCHESTER HARD DISKS ★
SPECIALS
5 1/4" Miniscribe Hard Disk
* 5 Meg \$589 * 10 Meg \$749

8" Quantum 20" Megabyte Winchester — Two Platters	1895.00
8" Quantum 40" Meg Four Platter — Most Popular	2395.00
8" Quantum 85" Megabyte — Special Order on this Monster!	2895.00
8" IOMEGA 10-Meg* Removable Disk Drive with SCSI Controlled Interface Board. Runs up to four drives	1895.00
8" IOMEGA 10 Meg* Cartridge Drive — No Control Interface	895.00
8" 10 Meg* Removable Cartridge Media #M-2000-51	50.00

★ LAST MINUTE SPECIAL!!! Buy any Winchester hard disk drive above and get a Western Digital hard disk interface board AT COST! ONLY 295.00!
*Total storage space after formatting.

California Computer Systems

YEAR END SALE

SAVE \$61.00

New CCS2066 64K Dynamic Memory
• 65,536 bytes of Dynamic RAM • Z-80/8080, S-100 compatible • Port bank/16 levels of 64K = system memory of 1024K • Independently addressed in 16K blocks • 200ns access and data lines • Hysteresis drivers and receivers for high noise immunity and minimal bus loading effects. Part #S-5000-50 ONLY \$299.00

YEAR END SYSTEM SALE

- 2300A Mainframe
- 2066 64K Memory
- 2810 Z-80A CPU
- All AC/DC & Data Cables
- 2422 Disk Controller
- CP/M Operating System
- 2719 2-Port RS-232 Serial
- 8-bit Parallel I/O

A powerful package at ONLY \$1495.00

CCS CALSTAR SYSTEM

Now available and with FREE SOFTWARE: • Perfect Writer • Perfect Calc • Perfect Speller and • Perfect Filer.
This powerful single box system includes: • Z-80 with 128K of RAM expandable to 256K • A networking interface • SASI hard disk interface to add-on a Winchester • CP/M 3.0 operating system • One parallel and two serial ports • Reads and writes the IBM 3740 format (compatible with XDR) AND • Two double-sided double-density 8" floppy drives for 2.4 Megabytes of formatted storage AND • Will run two or more 8" or 5 1/4" floppies. Part #S-1500-05

ON SALE NOW

Regular ~~\$2295.00~~ — Our Price Only \$2695.00



SPECIAL ONLY \$450.00

Limit 5 per customer
XOR-500 DAISYWHEEL PRINTER
A letter-quality daisy-wheel printer at an unheard of wholesale price. This 20 cps workhorse features a daisy-wheel compatible with QUME's products. Full 132 column format with 256 character buffer, serial AND parallel interfacing (standard), 8 level automatic impression control — original and 3 copies. The \$450.00 price is not a misprint. High reliability and quality performance sums-up the XOR-500 Daisy-wheel Printer.



XOR-500 TERMINAL SLASHED!
Cut another \$50
Only \$445.00

That's right! A 700.00 terminal for \$445.00, a special deal for our customers.
Features: ★ Screen tilt ★ Detached keyboard ★ 9 cursor control keys ★ 5 function keys ★ 7 screen attributes ★ 25th status line ★ 50-19.2 Kbaud ★ Column plus field tab ★ AND MORE
★ All these features with a full 6 month warranty makes this terminal the best buy on the market.

FANTASTIC SAVINGS



\$395
HELD OVER

ON THE ORIGINAL S-100 MOD

For engineers, hobbyists, and anyone who wants to save a bundle, the S-100 MOD is the answer. Full regulated power to run up to four floppy disks coupled with a mammoth S-100 power supply and 12 slot bus, makes the S-100 MOD an exceptional computer base. Single board design means no wiring from the power supply to the motherboard. This eliminates all ground loop problems associated with other brands of mainframes who are forced to use termination. The S-100 MOD is being offered this month with a matching S-100-12 cabinet. Fan cooled, turn with reset and keylock the cabinet is also enamel painted and silk screened. Four A.C. outlets are provided for peripheral hookup and plenty of cabinet space available for RS-232, centronics + others. Our regular \$225.00 price for the S-100 MOD and 250.00 price for our 12 slot cabinet is being SLASHED!

SPECIFICATIONS:

- Regulated +5V @ 5A
- Unregulated +8V @ 30A
- +24V @ 3A
- +16V @ 6A
- 5V @ 1A
- 16V @ 6A



SAVE OVER \$100

Don't settle for those cheap 6 slot imitations you've seen elsewhere in the mag. OWN THE BEST! XOR S-1 MOD and S-100-12 Cabinet \$395.00

DUAL DRIVE SUBSYSTEM



HORIZONTAL OR VERTICAL
Fully Assembled and Tested Units
ONE YEAR P+L WARRANTY
On Shugart and Mitsubishi Subsystems

w/two Mitsubishi DS/DD Assem. + Tested 2.4 Meg	\$117.00
w/two Shugart 801R SS/DD Assem. + Tested 1.2 Meg	97.00
w/two Shugart 851R DS/DD Assem. + Tested 2.4 Meg	122.00
w/two Siemens 120-8 SS/DD Assem. + Tested 1.2 Meg	67.00
w/two Qume DT-8 DS/DD Assem. + Tested 2.4 Meg	125.00
Cabinet Assem. & Tested w/Power Supply and Accs.	23.00
Cabinet Top and Bottom with Mounting Hardware	Only 6.00
All cabinets A & T and subsystems include all AC/DC wiring and 50 pin data cable except the horizontal model which includes the internal 50 pin cable and requires an external 50 pin cable part #C-6000-01	\$ 2.00
5 1/4" Subsystems — Cabinet — Power Supply — Drives — Cables	
w/two 48TPI SS/DD includes all cables Assem. + Tested	49.00
w/two 48TPI DS/DD includes all cables Assem. + Tested	59.00
w/two 96TPI DS/DD includes all cables Assem. + Tested	69.00

CUSTOMER SERVICE HOTLINE 1 - (714) 898-5522

DO YOU NEED AN IBM-PC 16-BIT COMPUTER TO PROCESS YOUR DATA?

COMPLETE SYSTEM
Model XPC with MS/DOS features:
★ MS/DOS standard, CP/M-86 operating system available at only \$65.00
★ 64K memory
★ Green CRT
★ 2 serial, one parallel port
★ 2 floppy drives for a total of 750K storage
★ Optional EPROM to 32K
★ Optional Hard Disk add-on
★ Optional floppy add-on
★ Optional 8087 math co-processor
★ Multi-function keyboard (this is one part of the system that's NOT like IBM's, it's better)
★ Fully expandable memory On-Board to 256K PLUS 5 expansion slots (all IBM compatible)
★ All available through U.S. Micro Sales and YES it's all fully IBM compatible

ONLY \$1895



THE XPC

A New Model PC by XOR

So close to the IBM PC you'll have to look twice. Due to the thousands of requests we've been receiving by phone, mail and visitors, we've responded by getting XOR to design this fantastic 16-bit IBM duplicate. We're offering a ONE YEAR warranty (vs. 90 days). Need more information? Order the manual for \$5.00 (plus shipping). This low price includes drives, controllers, monitor, power supply, etc. About the keyboard... If you've ever seen or used the IBM PC keyboard, you'll understand why we HAD to come up with something better — and we did! As a matter of fact, for those of you who own an IBM PC — it's time to take a hammer to that keyboard and call Toll Free to pick-up one of our compatible replacement keyboards at only \$239.00

BASIC COMPUTER

ONLY \$895

The Features:
★ 64K RAM memory
★ Expandable to 256K
★ Full monitor PROM
★ IBM PC compatibility
★ Multi-function keyboard and cable
★ Runs MS/DOS and CP/M-86 (not included) ★ Power Supply +5V @ 10 Amp, +12V @ 6 Amp, -12V @ 1 Amp
★ EPROM expandable on-board to 32K ★ 5 expansion slots with room for 4 more
INCLUDES: ★ 8 level interrupt ★ 2 serial and one parallel port ★ 3 timer channels ★ 4 DMA channels ★ Reset ★ Speaker port ★ and MORE!





TWO Locations to Serve You

ORDER TOLL FREE

★ EAST ★

★ WEST ★

800-435-9357

800-854-8174

In Ill. (815) 485-4002

In Calif. (714) 898-1492

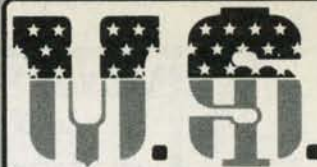

MICRO SALES

★ MADE IN USA ★ BUY FACTORY DIRECT ★

★ EAST ★ 11 Edison Drive, New Lenox, Illinois 60457

★ WEST ★ 15392 Assembly Lane, Huntington Beach, CA 92646

TERMS: We accept VISA/MC, prepay, check or money order. Please allow personal checks two weeks to clear before shipment. \$5.00 handling charge on all orders under \$50.00. 15% restocking fee. All orders shipped via UPS unless otherwise specified. All UPS C.O.D. orders over \$100.00 require a Cashiers Check. Our products carry a full ONE YEAR Parts and Labor Warranty excluding drives, printers and terminals which carry the full OEM factory warranty. PRICES SUBJECT TO CHANGE WITHOUT NOTICE.

CUSTOM COMPUTER SYSTEMS by XOR

Why do companies like I.B.M. Corp., Atari Corp., Mattel Elec., Kennedy Space Center, Edwards A.F.B., Motorola Corp., Raytheon, and Pacific Technology buy product by mail from us? May it's our full 1 year parts and labor warranty on all XOR O.E.M. products. It could be our state of the art technology, or even the factory direct sales and service. We think it's our custom computer systems with over 1000 possible configurations. If you don't see it advertised, call us today, chances are we CAN custom build the system YOU need.

★ MICRO MANAGERS: POWERFUL, PORTABLE, AND AFFORDABLE ★



Don't be fooled by the system's small portable size. A full 64K of memory with an industry standard S-100 bus. Includes CP/M 2.2 and many utilities on two disks. Add on a hard disk when you need more storage. The software and hardware that comes with each 5 1/4" system, is ready to run a pair of 8" single or double sided floppies, just plug in the 50 pin data cable to the system — many other configurations are available.

5 1/4" Z-80A 64K CP/M System

- ★ Dual Floppy 375K SS/DD 40 Track #S-1000-86 \$1445.00
- ★ Dual Floppy 750K DS/DD 40 Track #S-1000-87 \$1595.00
- ★ Dual Floppy 1.5 Meg DS/DD 80 Track #S-1000-88 \$1645.00
- ★ System Chassis (No boards, drives, CP/M) #S-1000-84 \$ 425.00



Inexpensive but powerful, small enough for portability, these mini hard disk systems have a special XOR interface to the S-100 bus that leaves an S-100 slot open for expandability. Choose from 5, 10, and 16 megabyte sizes (6.5, 12, + 20 megabyte unfformatted). Includes CP/M operating system. One year parts and labor warranty. Includes software and controller for 8" floppies.

5 1/4" Hard Disk with 1/2 Height Floppies

- ★ 5 Meg Hard Disk w/375 Floppy #S-1000-81 \$2195.00
- ★ 5 Meg Hard Disk w/750K Floppy #S-1000-90 \$2345.00
- ★ 10 Meg Hard Disk w/2 1.5M Floppy #S-1000-92 \$2795.00
- ★ 16 Meg Hard Disk w/2 1.5M Floppy #S-1000-93 \$2895.00



Our most popular computer features a 4 slot S-100 bus and an industry standard format. Reads and writes the IBM 3740 format as well as any byte size sector. Expandable? Yes, add a hard disk or cartridge subsystem when your data base grows. You've probably seen some "look-a-like" S-100 4-slot systems lately, but they just don't measure up the XOR Micro Manager

2.4 Meg DS/DD 8" CP/M System

- ★ System w/Dual SS/DD 1.2 Meg #S-1000-40 \$1795.00
- ★ System w/Dual DS/DD 2.4 Meg #S-1000-39 \$1995.00
- ★ System w/NO Drives (Includes CP/M) #S-1000-71 \$1195.00
- ★ System Chassis (No boards, drives, CP/M) #S-1000-70 \$ 395.00

★ THE BASIC PROFESSIONAL FLOPPY, HARD DISK AND TAPE BACKUP ★

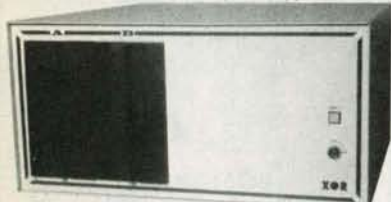

2.4 Meg DS/DD 64K Z-80A CP/M System

This "Industry Standard" computer features a 12 slot motherboard, 30 amp power supply, 2 serial RS-232 ports, centronics parallel port and CP/M software. The XOR disk controller included, will read and write the I.B.M. 3740 format (8" CP/M standard) as well as R/W single on double sided, single or double density, and any byte/size sector. One year parts and labor on the complete system. #S-1000-36 \$2345.00

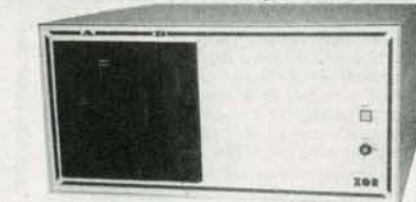

20 Meg Winchester w/2.4 Meg Floppies

For the serious professional this system features the famous S-100-12 cabinet with XOR's S1-MOD 12-slot motherboard. The Quantum hard disk has two 10 Meg platters (A: and B:). One platter can be "backed-up" on another. 2/DS/DD 1.2 floppies are used for software entry, copies, and back-up. One year parts and labor. #S-1000-63 \$5275.00

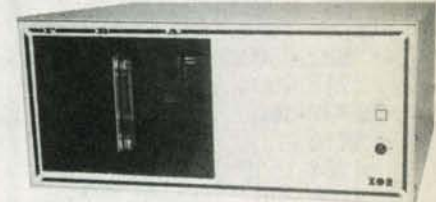

20M H.D. with 17M Tape and 1.2M Floppy

Backup your priceless data on this full 17 megabyte tape drive and be able to pip files between any of the three peripherals for total versatility. Boot CP/M from hard disk or floppy, change tapes for archival storage. Reads and writes the IBM 3740 Format (8" CP/M standard). #S-1000-69 \$6390.00
Above system 40 megabyte hard disk #S-1000-82 \$7240.00

A word on Special Orders and Configuring the System you need

We've built and shipped hundreds of Custom Computers that we have never advertised but, have been able to build to the customer specifications. Example: A 10 port hard disk system set-up to poll micro-wave devices; a Micro Manager interfaced to an X-Ray machine; a 7-User system with six of the users satellite stations via phone line modem communication throughout the United States. So whatever configuration you need; 4 floppies, 4 hard disks, 10 serial ports, etc., call us Toll Free and talk to our Engineering Sales Crew and let us quote a price and delivery date that will satisfy your needs.

★ THE OFFICE MASTERS! REMOVABLE CARTRIDGE DISK SYSTEMS ★

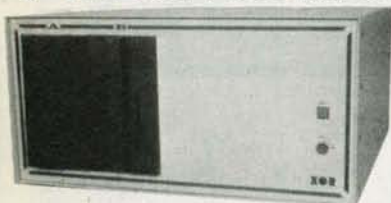

10 Meg Cartridge Disk And 1.2 Meg Floppy

An office system at an almost unbelievable price when you consider the bundle of applications software that comes with the system. Ten megabytes of formatted storage on a removable cartridge disk allows unlimited storage space with extra 10 Meg cartridges available at \$50.00 each. With the speed and reliability of a hard disk and removability of a floppy, this office master is the choice. #S-1000-74 \$3695.00

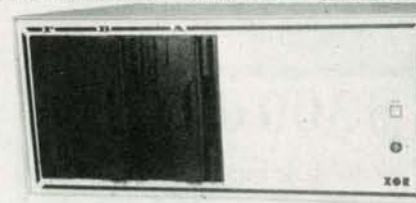

TWO 10 Meg Removable and DS/DD Floppy

Destined to be our #1 seller and no one else makes anything like it. A true state-of-the-art system with virtually no-limit to storage capacities in 10 Meg removable cartridges. Backup problems? Get high speed backup from cartridge to cartridge, ten megabytes worth, in 6 minutes! HINT: We don't use "PIP." Future technology here today. #S-1000-76 \$4595.00

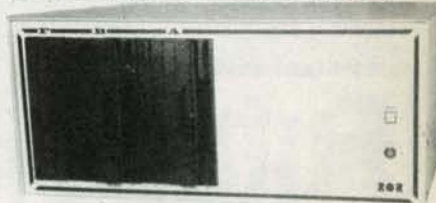

4 User Cartridge Disk System

Four users and two 10 megabyte removable cartridge disks may be just what you want to automate your office or small business, with all the software packages you'll ever need. A multi-user version of the system at left, these users can be up to 100 feet away from each other. Most any terminal will work with the user ports. #S-1000-80 \$5825.00

★ THE BUSINESS PROFESSIONALS: HARD DISK MULTI-USER SYSTEMS ★

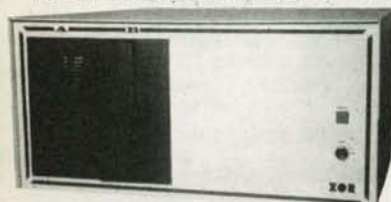

2 User Hard Disk System

A twenty meg hard disk (2 platter) with a DS/DD 1.2 Meg floppy disk makes this a perfect system for a small business. Two user allows dual access to the system files with each station up to 100 feet apart! Includes above software. Full one year parts and labor. #S-1000-61 \$5495.00

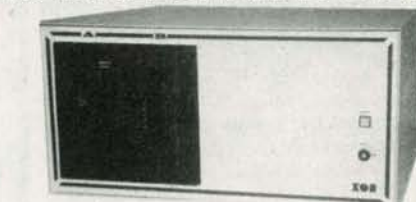

40 Meg Hard Disk 4 User System

A must for a growing business! Two DS/DD floppies (2.4 Meg) for data backup and copy with a 4 platter 40 Meg hard disk four user capability to automate the whole front office. You can even designate a 10 Meg platter to each user! Same warranty as all our products — (configurable from 2 to 7 users) #S-1000-60 \$7295

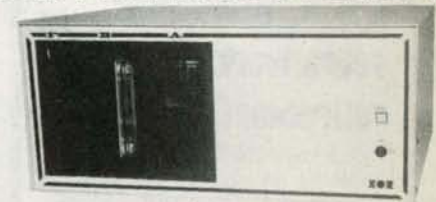

7 User 85 Meg w/17 Meg Backup

Now it's available, the automated business system to run even those large companies! 7 separate users tied into one professional host system. If 85 Meg isn't enough, we can put together as much as three hundred and forty megabytes! Full 17 Meg tape backup insures archival storage of valuable data #S-1000-96 \$9595.00

SMITH-CORONA
Memory Correct III Messenger
PRINTER & TYPEWRITER



- RS232 Serial or Centronics Parallel
- Multiple Pitch 10, 12, 15

UNBELIEVABLE!
\$539.00

CALL COLLECT: 214/826-6521
FIGURE LOGIC
BUSINESS EQUIPMENT, INC.
6408 Gaston Ave. • Dallas, Texas 75214

Circle 163 on inquiry card.

Maxell Floppy Disks

The Mini-Disks
with maximum quality.



Dealer inquiries invited. C.O.D.'s accepted. Call FREE (800) 235-4137.



PACIFIC EXCHANGES
100 Foothill Blvd., San Luis
San Luis Obispo, CA 93401.
In Cal. call (800) 592-5935 or
(805)543-1037.

Circle 278 on inquiry card.

FROM SHARING PERIPHERALS . . .

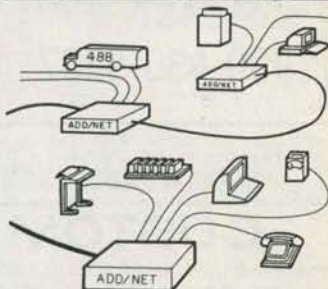

. . . TO INDUSTRIAL DATA ACQUISITION AND CONTROL—ADD/NET™

Expandable auto-data transfer via RS-232C, RS422, GPIB-488, HDLC. Easy menu setup.

CALL OUR ENGINEERS TODAY
(305) 293-2002

ADROIT ELECTRONICS, INC.
Dept. A, 3790A Silver Star Rd.
Orlando, FL 32808

Circle 13 on inquiry card.

*IBM PC Compatible



Low, direct prices • Fast, direct service

*2532-450	\$425
2716-450	320
2732-450	399
4116	155
*4164-150P	520
*4164-200	505
6116-P3	499
6116-LP-3	499

Add \$2.95 shipping to all orders. 2.6% for credit card orders
OEM • Quantity discounts available • P.O.s on approval • C.O.D. OK • Credit cards • FL residents add 5% tax • All new, no surplus, no seconds
(Prices subject to change)

4920 Cypress St., Suite 100,
Tampa, FL 33607

In FL, and for info., call 813-875-0299
FOR ORDERS ONLY, 800-237-8910

8 AM-8 PM EST



Circle 159 on inquiry card.

PROPORTIONAL SPACING on WordStar

Now you can have the professional appearance of typeset text using WordStar's built in print capability. PS is easier to read and allows up to a third more text on a page without appearing cluttered. Using it is as easy as turning on bold or underline and is done right in your document, then printed by WordStar automatically!

Easy to read instructions for printing in PS, setting two or more justified columns on a page, underlining spaces between words, and more. The techniques will work on all versions of WordStar, and will drive Diablo, Xerox, Qume, NEC, C. Itoh and other daisywheel printers. No technical knowledge is needed.

PS on WordStar—\$20 postpaid
Please send me _____ Copies. Enclosed is my check (or Visa/MC# and exp. date) for \$_____, made out to:

WRITING CONSULTANTS
Suite 138
11 Creek Bend Drive
Fairport, New York 14450
Call Toll Free 1-800-227-3800 Ext. 7018
Dealer inquiries invited.

Circle 382 on inquiry card.

SIBEC 51



8051-Based Single-Board Computer with Monitor/Debugger

- Versatile - 4 28-pin byte-wide sockets; monitor will program EEPROMs.
- Affordable - just \$335
- Perfect for System Development and Educational Applications

Binary Technology
P.O. BOX A-59 • HANOVER, NH 03755 • 603 643-2881

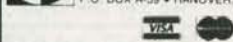

Circle 17 on inquiry card.

Future Shock!

age 65
years worked 40
retirement benefits 0

The U.S. Department of Labor has a free booklet that will help you answer these questions and a lot more. Send for it today.

Write: Pensions, Consumer Information Center, Pueblo, Colorado 81009

U.S. Department of Labor

\$300.00

8/16 Bit Fast Static Ram

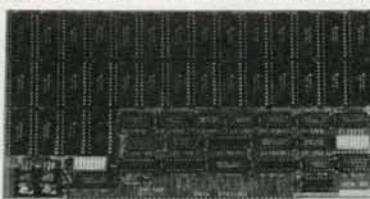

Lexicomp's SR-64K is the ideal low cost/advanced technology memory board for S100/IEEE 696.D2.1 systems integrators.

- Features:**
- 24 Bit Addressing
 - 10 MHz Speed
 - 8000-FFFF Deselectable
 - Phantom Pin 67
- Send for free brochure and price list.

Lexicomp
67 Valley Road-POB 222-Lexington, MA 02173
Telephone: (617) 862-3088

Circle 220 on inquiry card.

APPLE USERS FOURTEEN FUN & EDUCATIONAL PROGRAMS

- ARTIFICIAL INTELLIGENCE
TRAVELING SALESMAN PROBLEM
KNIGHT'S TOUR
- UTILITIES
LISTING FORMATTER
RECOVER LOST PROGRAMS
DEBUGGER
- MICRO P
A NEW PROGRAMMING LANGUAGE
- VOICE SYNTHESIS
RECORD YOUR VOICE
MAKE YOUR APPLE TALK

AND MORE! LISTABLE & UNPROTECTED!

ONLY \$24.95!

FREE SHIPPING

ALPHA ENTERPRISES
PO BOX 522
DENTON, TX 76201

Circle 17 on inquiry card.

WHY JDR MICRODEVICES? OUR CUSTOMERS SAY IT VERY WELL:

ANATEK

September 9, 1983

Becky
JDR Microdevices
1224 S. Bascom Ave.
San Jose, CA 95128

Becky:

Thank you so much for the speedy reshipment of the order we placed. Our experience with JDR has been excellent, and the manner in which you handled this situation will reinforce that impression.

Thanks,

Howard Katz

JDR Microdevices
1224 S. Bascom Ave.
San Jose, CA 95128

Dear Sir or Madam:

I want to thank you personally for the help you gave in updating one of my orders. It was truly a service that you did not have to provide but nevertheless fulfilled.

I have been buying merchandise from your organization for years now and intend to be one of your major customers in the future. In a recent inquiry from TI they asked who my major suppliers for MOS memories and LSI circuitry were and why. I placed the name of your organization down for both entries for several reasons.

- (1)* You run a total service operation.
- (2)* You have the largest range of merchandise.
- (3)* You have the lowest prices. (We compared you to 4 leading distributors.)
- (4)* You carry 100% quality components.
- (5) You have several delivery options.
- (6) You have delivery shipped within 2 weeks.
- (7)* You can ship within 3 days with Blue Label Air.
- (8)* You provide telephone orders. (Toll free number is excellent.)
- (9)* You include an updated catalog in every order.
- (10)* You are the first to carry new technology LSI circuitry. (Before others.)
- (11) You sell not only IC packages but periphery and accessories as well.
- (12)* You have regular SALES on merchandise.

*NOTE: Items marked with asterisk indicate features most favorable to my firm.

We at Computer Research Technology are behind you 100%! Keep up the excellent work!

Sincerely,

Sebastian Sullivan
Supervising Engineer
Computer Research Technology

JDR Microdevices
1224 S. Bascom Ave.
San Jose, CA 95128

Dear Reyna:

Enclosed please find the 4164-200 RAM chip as per our phone conversation on 08/24/83.

I want to thank you for your cooperation and swift action.... This is usually a rare quality not found in most of the mail order firms we've dealt with in the past. I can assure you that you will be at the top of our list whenever we require any of your fine products.

Thank you,

Patrick Grace
President
TECHNI-SOFT

25 April 1983

JDR Microdevices, Inc.
Office of the President
1224 S. Bascom Avenue
San Jose, CA 95128

Dear Sir:

I am writing this letter to highly commend the service afforded me by the employees of JDR Microdevices. Not only do I find your pricing policy to be very superior to that of your competitors, but the service given each customer by far exceeds any that I have received from other component distributors. I have found that any order or problem has been handled in the most courteous and expeditious manner.

These two attributes are combined in a seemingly successful business approach that should continue to prosper in the future. I thought that I would take this opportunity to show my appreciation for a job well done and a pledge of continued patronage.

Thank you very much.

Sincerely,

David Lovelace

Dear JDR:

...time for something that I don't normally do. That is congratulate JDR for the great service I have received in the past. I have ordered quite a number of times this past year and am continually impressed with the friendly sales staff, the speed at which the order arrives and the accuracy of the orders. I do quite a bit of business through the mail and JDR has been the best firm that I have dealt with. So, please keep up the good work. My associates and I really appreciate it!

Thanx a bunch,
Gordon Scott Mather

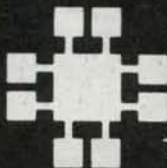

JDR Microdevices

1224 S. Bascom Avenue, San Jose, CA 95128

800-538-5000 • 800-662-6279 (CA)

(408) 995-5430 • Telex 171-110

© Copyright 1983 JDR Microdevices

416464K DYNAMIC
200 NS**\$595****TMM2016**2KX8 STATIC
200 NS**\$415****STATIC RAMS**

2101	256 x 4 (450ns)	1.95
5101	256 x 4 (450ns) (cmos)	3.95
2102-1	1024 x 1 (450ns)	.89
2102L-4	1024 x 1 (450ns) (LP)	.99
2102L-2	1024 x 1 (250ns) (LP)	1.49
2111	256 x 4 (450ns)	2.49
2112	256 x 4 (450ns)	2.99
2114	1024 x 4 (450ns)	8/9.95
2114-25	1024 x 4 (250ns)	8/10.95
2114L-4	1024 x 4 (450ns) (LP)	8/12.45
2114L-3	1024 x 4 (300ns) (LP)	8/13.95
2114L-2	1024 x 4 (200ns) (LP)	8/13.95
TC5514	1024 x 4 (650ns) (cmos)	2.49
TC5516	2048 x 8 (250ns) (cmos)	9.95
2147	4096 x 1 (55ns)	3.49
TMS4044-4	4096 x 1 (450ns)	3.99
TMS4044-3	4096 x 1 (300ns)	3.99
TMS4044-2	4096 x 1 (200ns)	4.49
MK4118	1024 x 8 (250ns)	9.95
TMM2016-200	2048 x 8 (200ns)	4.15
TMM2016-150	2048 x 8 (150ns)	4.95
TMM2016-100	2048 x 8 (100ns)	6.15
HM6116-4	2048 x 8 (200ns) (cmos)	4.75
HM6116-3	2048 x 8 (150ns) (cmos)	4.95
HM6116-2	2048 x 8 (120ns) (cmos)	8.95
HM6116LP-4	2048 x 8 (200ns) (cmos) (LP)	5.95
HM6116LP-3	2048 x 8 (150ns) (cmos) (LP)	6.95
HM6116LP-2	2048 x 8 (120ns) (cmos) (LP)	10.95
Z-6132	4096 x 8 (300ns) (Qstat)	34.95
HM6264	8192 x 8 (150ns) (cmos)	49.95

LP - Low Power Qstat - Quasi-Static

DYNAMIC RAMS

TMS4027	4096 x 1 (250ns)	1.99
UPD411	4096 x 1 (300ns)	3.00
MMS280	4096 x 1 (300ns)	3.00
MK4108	8192 x 1 (200ns)	1.95
MMS298	8192 x 1 (250ns)	1.85
4116-300	16384 x 1 (300ns)	8/11.75
4116-250	16384 x 1 (250ns)	8/7.95
4116-200	16384 x 1 (200ns)	8/12.95
4116-150	16384 x 1 (150ns)	8/14.95
4116-120	16384 x 1 (120ns)	8/29.95
2118	16384 x 1 (150ns) (5v)	4.95
MK4332	32768 x 1 (200ns)	9.95
4164-200	65536 x 1 (200ns) (5v)	5.95
4164-150	65536 x 1 (150ns) (5v)	6.95
MCM6665	65536 x 1 (200ns) (5v)	8.95
TMS4164-15	65536 x 1 (150ns) (5v)	8.95

5V = single 5 volt supply

6800

68000	49.95
6800	2.95
6802	7.95
6803	19.95
6808	13.90
6809E	14.95
6809	11.95
6810	2.95
6820	4.35
6821	2.95
6828	14.95
6840	12.95
6843	34.95
6844	25.95
6845	14.95
6847	11.95
6850	3.25
6852	5.75
6860	7.95
6875	6.95
6880	2.25
6883	22.95
68047	24.95
68488	19.95
6800 = 1MHZ	1795
6800	10.95
68B02	22.25
68B09E	29.95
68B09	29.95
68B10	6.95
68B21	6.95
68B40	19.95
68B45	19.95
68B50	5.95
68B00 = 2 MHZ	2143

6500

6502	1 MHz	4.95
6504		6.95
6505		8.95
6507		9.95
6520		4.35
6522		6.95
6532		9.95
6545		22.50
6551		11.85
6502A	2 MHz	6.95
6522A		9.95
6532A		11.95
6545A		27.95
6551A		11.95
6502B	3 MHz	9.95

DISC CONTROLLERS

1771	16.95
1791	24.95
1793	26.95
1795	29.95
1797	49.95
2791	54.95
2793	54.95
2795	59.95
2797	59.95
6843	34.95
8272	39.95
UPD765	39.95
M88876	29.95
M88877	34.95
1891	17.95
2143	18.95

8000

8035	5.95
8039	5.95
INS-8060	17.95
INS-8073	49.95
8080	3.95
8085	4.95
8085A-2	11.95
8086	24.95
8087	CALL
8088	29.95
8089	89.95
8155	6.95
8155-2	7.95
8156	6.95
8185	29.95
8185-2	39.95
8741	29.95
8748	24.95
8755	24.95

CRT CONTROLLERS

6845	14.95
68B45	19.95
HD46505SP	15.95
6847	11.95
MC1372	6.95
68047	24.95
8275	29.95
7220	99.95
CRT5027	19.95
CRT5037	24.95
TMS9918A	39.95
DP8350	49.95

8200

8202	24.95
8203	39.95
8205	3.50
8212	1.80
8214	3.85
8216	1.75
8224	2.25
8226	1.80
8228	3.49
8237	19.95
8237-5	21.95
8238	4.49
8243	4.45
8250	10.95
8251	4.49
8253	6.95
8253-5	7.95
8255	4.49
8255-5	5.25
8257	7.95
8257-5	8.95
8259	6.90
8259-5	7.50
8271	79.95
8272	39.95
8275	29.95
8279	8.95
8279-5	10.00
8282	6.50
8283	6.50
8284	5.50
8286	6.50
8287	6.50
8288	25.00
8289	49.95

Z-80

2.5 Mhz	
Z80-CPU	3.95
Z80-CTC	3.95
Z80-DART	10.95
Z80-DMA	14.95
Z80-PIO	3.95
Z80-SIO/0	11.95
Z80-SIO/1	11.95
Z80-SIO/2	11.95
Z80-SIO/9	11.95
4.0 Mhz	
Z80A-CPU	4.49
Z80A-CTC	4.95
Z80A-DART	9.95
Z80A-DMA	12.95
Z80A-PIO	4.49
Z80A-SIO/0	12.95
Z80A-SIO/1	12.95
Z80A-SIO/2	12.95
Z80A-SIO/9	12.95
6.0 Mhz	
Z80B-CPU	9.95
Z80B-CTC	12.95
Z80B-PIO	12.95
Z80B-DART	19.95
Z80B-SIO/2	39.95
ZILOG	
Z6132	34.95
Z8671	39.95

EPROMS

1702	256 x 8 (1us)	4.50
2708	1024 x 8 (450ns)	3.95
2758	1024 x 8 (450ns) (5v)	5.95
2716	2048 x 8 (450ns) (5v)	3.95
2716-1	2048 x 8 (350ns) (5v)	5.95
TMS2516	2048 x 8 (450ns) (5v)	5.50
TMS2716	2048 x 8 (450ns)	7.95
TMS2532	4096 x 8 (450ns) (5v)	5.95
2732	4096 x 8 (450ns) (5v)	4.95
2732-250	4096 x 8 (250ns) (5v)	8.95
2732-200	4096 x 8 (200ns) (5v)	11.95
2732A-4	4096 x 8 (450ns) (5v) (21vPGM)	6.95
2732A	4096 x 8 (250ns) (5v) (21vPGM)	9.95
2732A-2	4096 x 8 (200ns) (5v) (21vPGM)	13.95
2764	8192 x 8 (450ns) (5v)	6.95
2764-250	8192 x 8 (250ns) (5v)	7.95
2764-200	8192 x 8 (200ns) (5v)	19.95
TMS2564	8192 x 8 (450ns) (5v)	14.95
MCM68764	8192 x 8 (450ns) (5v) (24 pin)	39.95
MCM68766	8192 x 8 (350ns) (5v) (24 pin) (pwr dn.)	42.95
27128	16384 x 8 (300ns) (5v)	29.95

5v - Single 5 Volt Supply 21vPGM - Program at 21 Volts

EPROM ERASERS

	Timer	Capacity Chip	Intensity (uW/Cm ²)	
PE-14		9	8,000	83.00
PE-14T	X	9	8,000	119.00
PE-24T	X	12	9,600	175.00
PL-265T	X	30	9,600	255.00
PR-125T	X	25	17,000	349.00
PR-320T	X	42	17,000	595.00

- * Computer managed inventory — virtually no back orders!
- * Very competitive prices!
- * Friendly staff!
- * Fast service — most orders shipped within 24 hours!

CRYSTALS

32.768 khz	1.95
1.0 mhz	3.95
1.8432	3.95
2.0	2.95
2.097152	2.95
2.4576	2.95
3.2768	2.95
3.579545	2.95
4.0	2.95
5.0	2.95
5.0688	2.95
5.185	2.95
5.7143	2.95
6.0	2.95
6.144	2.95
6.5536	2.95
8.0	2.95
10.0	2.95
10.738635	2.95
14.31818	2.95
15.0	2.95
16.0	2.95
17.430	2.95
18.0	2.95
18.432	2.95
20.0	2.95
22.1184	2.95
32.0	2.95

CMOS

4000	.29	4528	1.19
4001	.25	4531	.95
4002	.25	4532	1.95
4006	.89	4538	1.95
4007	.29	4539	1.95
4008	.95	4541	2.64
4009	.39	4543	1.19
4010	.45	4553	5.79
4011	.25	4555	.95
4012	.25	4556	.95
4013	.38	4581	1.95
4014	.79	4582	1.95
4015	.39	4584	.75
4016	.39	4585	.75
4017	.69	4702	12.95
4018	.79	74C00	.35
4019	.39	74C02	.35
4020	.75	74C04	.35
4021	.79	74C08	.35
4022	.79	74C10	.35
4023	.29	74C14	.59
4024	.65	74C20	.35
4025	.29	74C30	.35
4026	1.65	74C32	.39
4027	.45	74C42	1.29
4028	.69	74C48	1.99
4029	.79	74C73	.65
4030	.39	74C74	.65
4034	1.95	74C76	.80
4035	.85	74C83	1.95
4040	.75	74C85	1.95
4041	.75	74C86	.39
4042	.69	74C89	4.50
4043	.85	74C90	1.19
4044	.79	74C93	1.75
4046	.85	74C95	.99
4047	.95	74C107	.89
4049	.35	74C150	5.75
4050	.35	74C151	2.25
4051	.79	74C154	3.25
4053	.79	74C157	1.75
4060	.89	74C160	1.19
4066	.39	74C161	1.19
4068	.39	74C162	1.19
4069	.29	74C163	1.19
4070	.35	74C164	1.39
4071	.29	74C165	2.00
4072	.29	74C173	.79
4073	.29	74C174	1.19
4075	.29	74C175	1.19
4076	.79	74C192	1.49
4078	.29	74C193	1.49
4081	.29	74C195	1.39
4082	.29	74C200	5.75
4085	.95	74C221	1.75
4086	.95	74C244	2.25
4093	.49	74C373	2.45
4098	2.49	74C374	2.45
4099	1.95	74C901	.39
14409	12.95	74C902	.85
14410	12.95	74C903	.85
14411	11.95	74C905	10.95
14412	12.95	74C906	.95
14419	7.95	74C907	1.00
14433	14.95	74C908	2.00
4502	.95	74C909	2.75
4503	.65	74C910	9.95
4508	1.95	74C911	8.95
4510	.85	74C912	8.95
4511	.85	74C914	1.95
4512	.85	74C915	1.19
4514	1.25	74C918	2.75</

2114 450 NS 8/\$995

2114 250 NS 8/\$1095

74LS00

74LS00	.24	74LS173	.69
74LS01	.25	74LS174	.55
74LS02	.25	74LS175	.55
74LS03	.25	74LS181	2.15
74LS04	.24	74LS189	8.95
74LS05	.25	74LS190	.89
74LS08	.28	74LS191	.89
74LS09	.29	74LS192	.79
74LS10	.25	74LS193	.79
74LS11	.35	74LS194	.69
74LS12	.35	74LS195	.69
74LS13	.45	74LS196	.79
74LS14	.59	74LS197	.79
74LS15	.35	74LS221	.89
74LS20	.25	74LS240	.95
74LS21	.29	74LS241	.99
74LS22	.25	74LS242	.99
74LS26	.29	74LS243	.99
74LS27	.29	74LS244	1.29
74LS28	.35	74LS245	1.49
74LS30	.25	74LS247	.75
74LS32	.29	74LS248	.99
74LS33	.55	74LS249	.99
74LS37	.35	74LS251	.59
74LS38	.35	74LS253	.59
74LS40	.25	74LS257	.59
74LS42	.49	74LS258	.59
74LS47	.75	74LS259	2.75
74LS48	.75	74LS260	.59
74LS49	.75	74LS266	.55
74LS51	.25	74LS273	1.49
74LS54	.29	74LS275	3.35
74LS55	.29	74LS279	.49
74LS63	1.25	74LS280	1.98
74LS73	.39	74LS283	.69
74LS74	.35	74LS290	.89
74LS75	.39	74LS293	.89
74LS76	.39	74LS295	.99
74LS78	.49	74LS298	.89
74LS83	.60	74LS299	1.75
74LS85	.69	74LS323	3.50
74LS86	.39	74LS324	1.75
74LS90	.55	74LS352	1.29
74LS91	.89	74LS353	1.29
74LS92	.55	74LS363	1.35
74LS93	.55	74LS364	1.95
74LS95	.75	74LS365	.49
74LS96	.89	74LS366	.49
74LS107	.39	74LS367	.45
74LS109	.39	74LS368	.45
74LS112	.39	74LS373	1.39
74LS113	.39	74LS374	1.39
74LS114	.39	74LS375	.89
74LS122	.45	74LS377	1.39
74LS123	.79	74LS378	1.18
74LS124	2.90	74LS379	1.35
74LS125	.49	74LS385	3.90
74LS126	.49	74LS386	.45
74LS132	.59	74LS390	1.19
74LS133	.59	74LS393	1.19
74LS136	.39	74LS395	1.19
74LS137	.99	74LS399	1.49
74LS138	.55	74LS424	2.95
74LS139	.55	74LS447	.95
74LS145	1.20	74LS490	1.95
74LS147	2.49	74LS824	3.99
74LS148	1.35	74LS840	2.20
74LS151	.55	74LS845	2.20
74LS153	.55	74LS868	1.69
74LS154	1.90	74LS869	1.89
74LS155	.89	74LS870	1.49
74LS156	.89	74LS874	14.95
74LS157	.65	74LS882	3.20
74LS158	.59	74LS883	3.20
74LS160	.69	74LS884	3.20
74LS161	.65	74LS885	3.20
74LS162	.69	74LS888	3.20
74LS163	.65	74LS889	3.20
74LS164	.69	81LS95	1.49
74LS165	.95	81LS96	1.49
74LS166	1.95	81LS97	1.49
74LS168	1.75	81LS98	1.49
74LS169	1.75	25LS2521	2.80
74LS170	1.49	25LS2569	4.25

74S00

74S00	.32	74S132	1.24	74S225	7.95
74S02	.35	74S133	.45	74S240	2.20
74S03	.35	74S134	.50	74S241	2.20
74S04	.35	74S135	.89	74S244	2.20
74S05	.35	74S138	.85	74S251	.95
74S08	.35	74S139	.85	74S253	.95
74S09	.40	74S140	.55	74S257	.95
74S10	.35	74S151	.95	74S258	.95
74S11	.35	74S153	.95	74S260	.79
74S15	.35	74S157	.95	74S273	2.45
74S20	.35	74S158	.95	74S274	19.95
74S22	.35	74S161	1.95	74S275	19.95
74S30	.35	74S162	1.95	74S280	1.95
74S32	.40	74S163	1.95	74S287	1.90
74S37	.88	74S168	3.95	74S288	1.90
74S38	.85	74S169	3.95	74S289	6.89
74S40	.35	74S174	.95	74S301	6.95
74S51	.35	74S175	.95	74S303	2.45
74S64	.40	74S181	3.95	74S374	2.45
74S65	.40	74S182	2.95	74S381	7.95
74S74	.50	74S188	1.95	74S387	1.95
74S85	1.99	74S189	6.95	74S412	2.98
74S86	.50	74S194	1.49	74S471	4.95
74S112	.50	74S195	1.49	74S472	4.95
74S113	.50	74S196	1.49	74S474	4.95
74S114	.55	74S197	1.49	74S482	15.25
74S124	2.75	74S201	6.95	74S570	2.95
				74S571	2.95

VOLTAGE REGULATORS

7805T	.75	7905T	.85
78M05C	.35	7908T	.85
7808T	.75	7912T	.85
7812T	.75	7915T	.85
7815T	.75	7924T	.85
7824T	.75		
7805K	1.39	7905K	1.49
7812K	1.39	7912K	1.49
7815K	1.39	7915K	1.49
7824K	1.39	7924K	1.49
78L05	.69	79L05	.79
78L12	.69	79L12	.79
78L15	.69	79L15	.79
78H05K	9.95	LM323K	4.95
78H12K	9.95	UA78S40	1.95

C, T = TO-220 K = TO-3
L = TO-92



7400

7400	.19	74123	.49
7401	.19	74125	.45
7402	.19	74126	.45
7403	.19	74132	.45
7404	.19	74136	.45
7405	.25	74143	8.95
7406	.29	74145	.60
7407	.29	74147	1.75
7408	.24	74148	1.20
7409	.19	74150	1.35
7410	.19	74151	.55
7411	.25	74153	.55
7413	.35	74154	1.25
7414	.49	74155	.75
7416	.25	74157	.55
7417	.25	74159	1.65
7420	.19	74160	.85
7421	.35	74161	.69
7425	.29	74163	.69
7427	.29	74164	.85
7430	.19	74165	.85
7432	.29	74166	1.00
7437	.29	74167	2.95
7438	.29	74170	1.65
7442	.49	74173	.75
7445	.69	74174	.89
7446	.69	74175	.89
7447	.69	74177	.75
7448	.69	74181	2.25
7451	.23	74184	2.00
7473	.34	74185	2.00
7474	.33	74191	1.15
7475	.45	74192	.79
7476	.35	74193	.79
7482	.95	74194	.85
7483	.50	74195	.85
7485	.59	74197	.75
7486	.35	74198	1.35
7489	2.15	74221	1.35
7490	.35	74246	1.35
7492	.50	74247	1.25
7493	.35	74259	1.95
7495	.55	74273	2.25
7497	2.75	74276	1.25
74100	1.75	74279	.75
74107	.30	74366	.65
74109	.45	74367	.65
74116	1.55	74368	.65
74121	.29	74393	1.35
74122	.45		

INTERFACE

8T26	1.59
8T28	1.89
8T95	.89
8T96	.89
8T97	.89
8T98	.89
DM8131	2.95
DP8304	2.29
DS8833	2.25
DS8835	1.99
DS8836	.99
DS8837	1.65
DS8838	1.30

ORDER TOLL FREE

800-538-5000

800-662-6279

(CALIFORNIA RESIDENTS)

SOUND CHIPS

76477	3.95
76488	5.95
76489	8.95
AY3-8910	12.95
AY3-8912	12.95
MC3340	1.49

FEDERAL EXPRESS

SERVICES AVAILABLE!

DATA ACQUISITION

ADC0800	15.55	DAC0808	2.95
ADC0804	3.49	DAC1020	8.25
ADC0809	4.49	DAC1022	5.95
ADC0817	9.95	MC1408L6	1.95
DAC0800	4.95	MC1408L8	2.95

CONNECTORS

RS232 Male	2.50
RS232 Female	3.25
RS232 Hood	1.25
S-100 ST	3.95

EXAR

XR 2206	3.75
XR 2207	3.75
XR 2208	3.75
XR 2211	5.25
XR 2240	3.25

INTERSIL

ICL7106	9.95
ICL7107	12.95
ICL7660	2.95
ICL8038	3.95
ICM7207A	5.59
ICM7208	15.95

9000

9316	1.00
9334	2.50
9368	3.95
9401	9.95
9601	.75
9602	1.50
96S02	1.95

LINEAR

LM301	.34	LM340 (see 7800)		LM565	.99	LM1558H	3.10
LM301H	.79	LM348	.99	LM566	1.49	LM1800	2.37
LM307	.45	LM350K	4.95	LM567	.89	LM1812	8.25
LM308	.69	LM350T	4.80	NE570	3.95	LM1830	3.50
LM308H	1.15	LM358	.69	NE571	2.95	LM1871	5.49
LM309K	1.95	LM359	1.79	NE590	2.50	LM1872	5.49
LM309H	1.25	LM376	3.75	NE592	2.75	LM1877	3.25
LM310	1.75	LM377	1.95	LM709	.59	LM1889	1.95
LM311	.64	LM378	2.50	LM710	.75	LM1896	1.75
LM311H	.89	LM379	4.50	LM711	.79	ULN2003	2.49
LM312H	1.75	LM380	.89	LM723	.49	LM2877	2.05
LM317K	3.95	LM380H-8	1.10	LM723H	.55	LM2878	2.25
LM317T	1.19	LM381	1.60	LM733	.98	LM2900	.85
LM318	1.49	LM382	1.60	LM741	.35	LM2901	1.00
LM318H	1.59	LM383	1.95	LM741H-14	.35	LM3900	.59
LM319H	1.90	LM384	1.95	LM741H	.40	LM3905	1.25
LM319	1.25	LM386	.89	LM747	.69	LM3909	.98
LM320 (see 7900)		LM387	1.40	LM748	.59	LM3911	2.25
LM322	1.65	LM389	1.35	LM1014	1.19	LM3914	3.95
LM323K	4.95	LM390	1.95	LM1303	1.95	LM3915	3.95
LM324	.59	LM392	.69	LM1310	1.49	LM3916	3.95
LM329	.65	LM393	1.29	MC1330	1.69	MC4024	3.95
LM331	3.95	LM394H	4.60	MC1349	1.89	MC4044	4.50
LM334	1.19	LM399H	5.00	MC1350	1.19	RC4136	1.25
LM335	1.40	NE531					

2716 16K EPROMS **\$395** EA

4116 250 NS **8/\$795**

RF MODULATOR

(ASTEC UM1082) QUANTITIES LIMITED

- * PRESET TO CHANNEL 3
- * USE TO BUILD TV-COMPUTER INTERFACE
- * +5 VOLT OPERATION

NOW ONLY \$695

POWER SUPPLIES

IDEAL FOR HOBBYIST, BENCHWORK & DO-IT-YOURSELFERS! 90-DAY WARRANTY! NEW & UNUSED! QUANTITIES LIMITED!

ASTEC AA11190

- * QUAD OUTPUT SWITCHING DESIGN AS USED IN APPLE III
- * +5 @ 4A; -5 @ .25A
- * +12 @ 2.5A; -12 @ .30A; 15.5"x4.5"x2"

NOW ONLY \$5990

SIGMA INSTRUMENTS

Model 2PC2241

- * DESIGNED FOR DEC EQUIPMENT
- * FUSE PROTECTED * LINEAR DESIGN
- * AUXILIARY AC OUTLET
- * +5 @ 4A; -15V @ 1.5A; 12.25"x4"x4.75"

NOW ONLY \$1995

OUR BUYER BLEW IT

& BOUGHT TOO MANY OF THESE GEMS!

4116 250NS **8/7.95**
DYNAMIC RAM MM5298 8K x 195

CAPACITORS

TANTALUM

	6V	10V	15V	20V	25V	35V
.22uf						.40
.27						.40
.33						.40
.47				.35		.50
.68						.45
1.0			.40	.40	.45	.45
1.5				.45		.50
1.8						.75
2.2		.35	.40	.45		.65
2.7		.40	.45			.90
3.3		.45	.50	.55	.60	.65
3.9		.45				
4.7	.45	.55		.60	.65	.85
6.8			.70		.75	
8.2						1.00
10	.55	.65	.80	.85	.90	1.00
12	.65		.85	.90		
15	.75	.85	.90			
18			1.25			
22		1.00	1.35			
27			2.25			
39		1.50				
47	1.35					
56	1.75					
100		3.25				
270	3.75					

DISC

10pf	50V	.05	470	50V	.05
22	50V	.05	560	50V	.05
25	50V	.05	680	50V	.05
27	50V	.05	820	50V	.05
33	50V	.05	.001uf	50V	.05
47	50V	.05	.0015	50V	.05
56	50V	.05	.0022	50V	.05
68	50V	.05	.005	50V	.05
82	50V	.05	.01	50V	.05
100	50V	.05	.02	50V	.05
220	50V	.05	.05	50V	.05
330	50V	.05	.1	12V	.10
			.1	50V	.10

MONOLITHIC

.1uf-mono	50V	.18	.47uf-mono	50V	.20
.047uf-mono	50V	.15	.01uf-mono	50V	.10

ELECTROLYTIC

RADIAL

AXIAL

.47uf	50V	.14	1uf	50V	.14
1	25V	.14	4.7	16V	.14
2.2	35V	.15	10	16V	.14
4.7	50V	.15	10	50V	.16
10	50V	.15	22	16V	.14
47	35V	.18	47	50V	.20
100	16V	.18	100	15V	.20
220	35V	.20	100	35V	.25
470	25V	.30	150	25V	.25
2200	16V	.60	220	25V	.30
			330	16V	.40
			500	16V	.42
			1000	16V	.60
			1500	16V	.70
			5000	16V	.85

COMPUTER GRADE

26,000uf 30V 3.95

OPTO-ISOLATORS

4N26	1.00	MCA-7	4.25
4N27	1.10	MCA-255	1.75
4N28	.69	IL-1	1.25
4N33	1.75	ILA-30	1.25
4N35	1.25	ILQ-74	2.75
4N37	1.25	H11C5	1.25
MCT-2	1.00	TIL-111	1.00
MCT-6	1.50	TIL-113	1.75

MICRODEVICES AT MICROPRICES

TRANSISTORS

2N918	.50	MPS3706	.15
MPS918	.25	2N3772	1.85
2N2102	.75	2N3903	.25
2N2218	.50	2N3904	.10
2N2218A	.50	2N3906	.10
2N2219	.50	2N4122	.25
2N2219A	.50	2N4123	.25
2N2222	.25	2N4249	.25
PN2222	.10	2N4304	.75
MPS2369	.25	2N4401	.25
2N2484	.25	2N4402	.25
2N2905	.50	2N4403	.25
2N2907	.25	2N4857	1.00
PN2907	.125	PN4916	.25
2N3055	.79	2N5086	.25
3055T	.69	PN5129	.25
2N3393	.30	PN5139	.25
2N3414	.25	2N5209	.25
2N3563	.40	2N6028	.35
2N3565	.40	2N6043	1.75
PN3565	.25	2N6045	1.75
MPS3638	.25	MPS-A05	.25
MPS3640	.25	MPS-A06	.25
PN3643	.25	MPS-A55	.25
PN3644	.25	TIP29	.65
MPS3704	.15	TIP31	.75
		TIP32	.79

BYPASS CAPS

.01 UF DISC	100/6.00
.01 UF MONOLITHIC	100/12.00
.1 UF DISC	100/8.00
.1 UF MONOLITHIC	100/15.00

LED LAMPS

	1-99	100-up
JUMBO RED	.10	.09
JUMBO GREEN	.18	.15
JUMBO YELLOW	.18	.15
LED MOUNTING HARDWARE	.10	.09

LED DISPLAYS

HP 5082-7760	.43"	CC	1.29
MAN 72	.3"	CA	.99
MAN 74	.3"	CC	.99
FND-357 (359)	.375"	CC	1.25
FND-500 (503)	.5"	CC	1.49
FND-507 (510)	.5"	CA	1.49
TIL-311 4x7	.270"	HEX W/LOGIC	9.95

RESISTORS

1/4 WATT 5% CARBON FILM ALL STANDARD VALUES FROM 1 OHM TO 10 MEG OHM	
50 PCS. SAME VALUE	.025
100 PCS. SAME VALUE	.02
1000 PCS. SAME VALUE	.015

IC SOCKETS

8 pin ST	1-99	100
14 pin ST	.13	.10
16 pin ST	.15	.10
18 pin ST	.17	.10
20 pin ST	.20	.10
22 pin ST	.29	.20
24 pin ST	.30	.20
28 pin ST	.40	.30
40 pin ST	.49	.30
64 pin ST	4.25	call
ST = SOLDERTAIL		
8 pin WW	.59	.40
14 pin WW	.69	.50
16 pin WW	.69	.50
18 pin WW	.99	.90
20 pin WW	1.09	.90
22 pin WW	1.39	1.20
24 pin WW	1.49	1.30
28 pin WW	1.69	1.40
40 pin WW	1.99	1.80
WW = WIREWRAP		
16 pin ZIF	5.95	call
24 pin ZIF	7.95	call
28 pin ZIF	8.95	call
ZIF = TEXTPOOL (Zero Insertion Force)		

DIP SWITCHES

4 POSITION	.85
5 POSITION	.90
6 POSITION	.90
7 POSITION	.95
8 POSITION	.95

NEW UN-USED MUFFIN FANS

4.68" Square	14.95
3.125" Square	14.95

HEAT SINKS

TO-3 style	.95
TO-220 style	.35

SWITCHES

SPDT mini-toggle	1.25
DPDT mini-toggle	1.50
SPST mini-pushbutton	.39

JDR Microdevices

1224 S. Bascom Avenue, San Jose, CA 95128

800-538-5000 • 800-662-6279 (CA)

(408) 995-5430 • Telex 171-110

VISIT OUR RETAIL STORE

HOURS: M-W-F, 9-5 T-Th., 9-9 Sat. 10-3

PLEASE USE YOUR CUSTOMER NUMBER WHEN ORDERING

TERMS: Minimum order \$10. For shipping and handling include \$2.50 for UPS Ground and \$3.50 for UPS Air. Orders over 1 lb. and foreign orders may require additional shipping charges — please contact our sales department for the amount. CA residents must include 6% sales tax. Bay Area and LA residents include 6 1/2%. Prices subject to change without notice. We are not responsible for typographical errors. We reserve the right to limit quantities and to substitute manufacturer. All merchandise subject to prior sale.

2732 32K EPROM

\$495

2764 64K EPROM

\$695

**MICROCOMPUTER
HARDWARE HANDBOOK
FROM ELCOMP — \$14.95**
Over 800 pages of manufacturers data
sheets on most commonly used IC's.
Includes:
* TTL — 74/74LS and 74F
* CMOS
* Voltage Regulators
* Memory — RAM, ROM, EPROM
* CPU's — 6800, 6500, Z80, 8080,
8085, 8086/8
* MPU support & interface —
6800, 6500, Z80, 8200, etc.

**DISK DRIVES
TANDON**

TM100-1 5 1/4" (FOR IBM) SS/DD **229.00**
TM100-2 5 1/4" (FOR IBM) DS/DD **259.00**
SHUGART
SA 400L 5 1/4" (40 TRACK) SS/DD **199.95**
SA 400 5 1/4" (35 TRACK) SS/DD **189.95**
PERTEC
FD-200 5 1/4" SS/DD **179.95**
FD-250 5 1/4" DS/DD **199.95**
MPI
MP-52 5 1/4" (FOR IBM) DS/DD* **249.00**

NOTE: Please include sufficient amount
for shipping on above items.

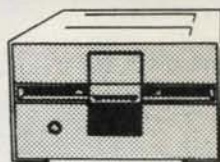

**8-INCH
DISK DRIVE
SALE**

FD 100-8 **FD 200-8**
SHUGART 801 EQUIV. **SHUGART 851 EQUIV.**
SS/DD — 10/\$175 EA. **DS/DD — 10/\$220 EA.**

\$18900 **\$23900**

**BEST SELLING
BOOKS**

OSBORNE/MC GRAW-HILL
Apple II User's Guide 16.95
CRT Controller's Handbook 9.95
68000 Assembly Language
Programming 16.99
CBASIC User Guide 15.00
SYBEX
Your First Computer 8.95
The CP/M Handbook 14.95
The PASCAL Handbook 18.95
Microprocessor Interfacing
Techniques 17.95

**EDGE-CARD
CONNECTORS**
S-100 ST 3.95
S-100 WW 4.95
72 pin ST 6.95
72 pin WW 7.95
50 pin ST 4.95
44 pin ST 2.95
44 pin WW 4.95

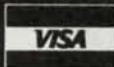

CABINETS FOR 5 1/4" DISK DRIVES

CABINET #1 \$29.95

- * DIMENSIONS 8 1/2 x 5 1/16 x 3 1/16"
- * COLOR MATCHES APPLE
- * FITS STANDARD 5 1/4" DRIVES,
INCL. SHUGART
- * INCLUDES MOUNTING
HARDWARE AND FEET

CABINET #2 \$79.00

- * COMPLETE WITH POWER
SUPPLY, SWITCH, LINE
CORD, FUSE & STANDARD
POWER CONNECTOR
- * DIMENSIONS: 11 1/2 x 5 3/4 x 3 1/16"
- * +5V @ 1 AMP, +12V @ 1.5 AMP
- * FITS STANDARD 5 1/4" DRIVES
- * PLEASE SPECIFY
GRAY OR TAN

NOTE: Please include sufficient amount for
shipping on above items.

**TRANSFORMERS
FRAME STYLE**

12.6VAC 2amp 4.95
12.6VAC CT 2amp 5.95
12.6VAC CT 4amp 7.95
12.6VAC CT 8amp 10.95
25.2VAC CT 2amp 7.95

PLUG CASE STYLE

12VAC 250ma 3.95
12VAC 500ma 4.95
12VAC 1amp 5.95
12VAC 2amp 6.95

DC ADAPTER

6, 9, 12 VDC selectable with universal
adapter 8.95
NOTE: Please include sufficient amount for
shipping on above items.

**VISIT DURING
OUR EXPANDED
RETAIL STORE HOURS
SATURDAY 10 to 3**

CENTRONICS

IDCEN36 Ribbon Cable 36 Pin Male 8.95
IDCE436/F Ribbon Cable 36 Pin Female 8.95
CEN36 Solder Cup 36 Pin Male 7.95

DIP CONNECTORS

DESCRIPTION	HIGH RELIABILITY TOOLED ST IC SOCKETS	COMPONENT CARRIERS (DIP HEADERS)	RIBBON CABLE DIP PLUGS (IDC)
ORDER BY	AUGATxx-ST	ICCxx	IDPxx
CONTACTS 8	.99	.65	
14	.99	.75	1.45
16	.99	.85	1.65
18	1.69	1.00	
20	1.89	1.25	
22	1.89	1.25	
24	1.99	1.35	2.50
28	2.49	1.50	
40	2.99	2.10	4.15

For order instructions see "IDC Connectors" below.

RIBBON CABLE

CONTACTS	SINGLE COLOR		COLOR CODED	
	1'	10'	1'	10'
10	.50	4.40	.83	7.30
16	.55	4.80	1.00	8.80
20	.65	5.70	1.25	11.00
25	.75	6.60	1.32	11.60
26	.75	6.60	1.32	11.60
34	.98	8.60	1.65	14.50
40	1.32	11.60	1.92	16.80
50	1.38	12.10	2.50	22.00

D-SUBMINIATURE

DESCRIPTION	SOLDER CUP		RIGHT ANGLE PC SOLDER		IDC RIBBON CABLE		HOODS	
	MALE	FEMALE	MALE	FEMALE	MALE	FEMALE	BLACK	GREY
ORDER BY	DBxxP	DBxxS	DBxxPR	DBxxSR	IDBxxP	IDBxxS	HOOD-B	HOOD
CONTACTS 9	2.08	2.66	1.65	2.18	3.37	3.69	—	1.60
15	2.69	3.63	2.20	3.03	4.70	5.13	—	1.60
25	2.50	3.25	3.00	4.42	6.23	6.84	1.25	1.25
37	4.80	7.11	4.83	6.19	9.22	10.08	—	2.95
50	6.06	9.24	—	—	—	—	—	3.50

For order instructions see "IDC Connectors" below.

MOUNTING HARDWARE 1.00

IDC CONNECTORS

DESCRIPTION	SOLDER HEADER	RIGHT ANGLE SOLDER HEADER	WW HEADER	RIGHT ANGLE WW HEADER	RIBBON HEADER SOCKET	RIBBON HEADER	RIBBON EDGE CARD
ORDER BY	IDHxxS	IDHxxSR	IDHxxW	IDHxxWR	IDSxx	IDMxx	IDExx
CONTACTS 10	.82	.85	1.86	2.05	1.15	—	2.25
20	1.29	1.35	2.98	3.28	1.86	5.50	2.36
26	1.68	1.76	3.84	4.22	2.43	6.25	2.65
34	2.20	2.31	4.50	4.45	3.15	7.00	3.25
40	2.58	2.72	5.28	4.80	3.73	7.50	3.80
50	3.24	3.39	6.63	7.30	4.65	8.50	4.74

ORDERING INSTRUCTIONS: Insert the number of contacts in the position marked "xx" of the "order by" part number listed. **Example:** A 10 pin right angle solder style header would be IDH10SR.

FOR APPLE COMPUTER USERS



JDR Microdevices

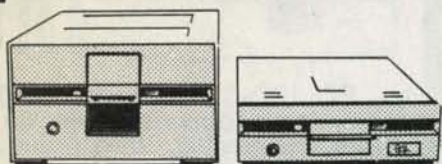

GET SLIM IN 1984!

JDR HALF-HEIGHT DISK DRIVE

- ★ 35 Track w/Apple Controller
- ★ 40 Track Controller and DOS Available (Call for Price)

\$239⁹⁵

JDR 16K RAM CARD FOR APPLE II+

★ 2 YEAR WARRANTY

Kit with Instructions **\$44⁹⁵**

Bare PC Card **\$14.95**

JDR COOLING FAN CLEARANCE SALE!

- ★ With Surge Protection
- ★ Quantities Are Limited!

\$49⁹⁵

OTHER ACCESSORIES FOR APPLE II

THUNDERCLOCK **\$129.95**

- ★ Real-Time Clock Calendar ★ Software Included
- ★ Mountain Software Compatible
- ★ BSR Control Options Available

KRAFT JOYSTICK **\$39.95**

micromax MANIA

VIEWMAX-80 NOW ONLY \$159⁹⁵

- ★ 80 Column Card for Apple II+
- ★ Video Soft Switch
- ★ Inverse Video ★ 2 Year Warranty

VIEWMAX-80e NEW \$129⁹⁵

- ★ 80 Column Card for Apple IIe
- ★ 64K RAM Expandable to 128K
- 64K RAM Upgrade **\$47.60**

GRAPHMAX **\$129⁹⁵**

- ★ Hi Resolution Graphics
- ★ Printer Card
- ★ Centronics Parallel Interface

Graphmax with Color & Zoom Options **\$149.95**

MA SYSTEMS

FD-35 DISK DRIVE **\$229.95**

★ Shugart Mechanism — Made in U.S.A.

★ Direct Replacement for Apple Disk II ★ 1 Year Warranty

CONTROLLER CARD **\$69.95**

★ One Year Warranty

APPLE COMPATIBLE POWER SUPPLY

★ Use To Power Apple-Type Systems

★ +5V @ .5A +12V @ 3A

★ -5V @ .5A -12V @ .5A

★ Instructions Included

\$79⁹⁵



FEDERAL EXPRESS

SERVICES

AVAILABLE

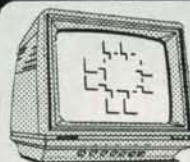

MONITORS MONOCHROME

BMC BM 12AUW GREEN 12" NEW **\$89.95**

BMC BM 12AUU 18 MHZ AMBER **\$139.95**

NEC JB1201M - 20 MHZ GREEN **\$169.00**

ZENITH ZVM-121 - 15 MHZ GREEN **\$99.00**

COLOR

BMC BM-AU9191U COMPOSITE 13" **\$279.00**

AMDEK COLOR I - COMPOSITE **\$335.00**

NO C.O.D. ORDERS PLEASE

VERBATIM DATALIFE DISKETTES

SS/DD SOFT SECTOR
29.95

SS/DD 10 SECTOR HARD
29.95

NASHUA DISKETTES

5 1/4" WITH HUB RING

MD1 SOFT SECTOR, SS/SD **19.95**

MD1D SOFT SECTOR, SS/DD **26.25**

MD2D SOFT SECTOR, DS/DD **30.75**

MD2F SOFT SECTOR,
DS/QUAD DENSITY **45.00**

MD110 10 SECTOR HARD, SS/SD **19.95**

MD210D 10 SECTOR HARD, DS/DD **30.75**

8" WITHOUT HUB RING

FD1 SOFT SECTOR, SS/SD **24.75**

FD1D SOFT SECTOR, SS/DD **30.00**

FD2D SOFT SECTOR, DS/DD **36.75**

VISIT OUR RETAIL STORE

HOURS: M-W-F, 9-5 T-Th., 9-9 Sat. 10-3

PLEASE USE YOUR CUSTOMER NUMBER WHEN ORDERING

TERMS: Minimum order \$10. For shipping and handling include \$2.50 for UPS Ground and \$3.50 for UPS Air. Orders over 1 lb. and foreign orders may require additional shipping charges — please contact our sales department for the amount. CA residents must include 6% sales tax, Bay Area and LA residents include 6 1/2%. Prices subject to change without notice. We are not responsible for typographical errors. We reserve the right to limit quantities and to substitute manufacturer. All merchandise subject to prior sale.

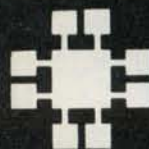

JDR Microdevices

1224 S. Bascom Ave. • San Jose, CA 95128

(408) 995-5430 • Telex 171-110

© Copyright 1983 JDR Microdevices

Unclassified Ads

WANTED: Information, documentation, and peripherals for Altair 8800b manufactured by MITS to be used in a vocational-rehabilitation class. K. Luhrs, Education Department, California Rehabilitation Center, POB 1841, Norco, CA 91760.

WANTED: Hospital wishes to purchase or welcomes donation of one or more Tektronix 4051 computers. Dr. Peter Hulick, Lynchburg General Hospital, Lynchburg, VA 24506.

WANTED: If you need answers to any questions concerning CPM, Pascal, C language, programming techniques, computer and software selection criteria, or related topics, ask me. I will locate the answers to your questions. Send SASE. Bhavisyat, RD 1, Box 331, Moundsville, WV 26041.

WANTED: Unitarian-Universalist churches need used computing equipment, or unused manufacturer's over-runs or out-dated units. Have immediate requirements for DEC-compatible LQ Printer, two Atari-compatible disk drives, and two Atari-compatible printers. All tax-deductible. Also, willing to exchange information and equipment. Unitarian Universalist Computer Interchange, c/o D. P. Lantz, 1373 Howell Dr., Newark, OH 43055, (614) 344-6600.

FOR TRADE: I am interested in exchanging software with Commodore 64 users. Send a full list of all your software, plus a SASE for my list. ICC, Kim Moser, 127 East 15th St., New York, NY 10003.

WANTED: We would like to exchange ideas, suggestions, and information regarding software and hardware with other Epson QX-10 owners from anywhere and everywhere. Bruce and Lynn Holloway, 8 Tri City Rd. Apt. 10, Dover, NH 03820.

WANTED: Information on licensing, copyrighting, or protecting software to insure the buyer agrees not to change the software. V.E.H., 914 North Court, Rockford, IL 61103.

WANTED: People with knowledge of sequential text files of Apple II Plus and TRS-80 Models II and III. Possible formation of a computer club (I have an Apple II Plus 64K and access to TRS-80s). Also, information on procedures for on and off of Reset and CTRL-C keys; knowledge and/or advice for selling software and/or forming a software company; Applesoft 3.3 BASIC Compilers and offers too. Will trade Apple game programs and utilities. George R. Levicky, 7 Durst Dr., Milltown, NJ 08850.

WANTED: Last updated version of Heath tape O.S. and use of Phi-Decks with Heath cassette board. C.T. Huth, 146 Schonhardt St., Tiffin, OH 44883.

WANTED: Information and/or correspondence with users of Timex/Sinclair computers about clubs, programs, books, modems, software, and hardware. I will also trade cassette programs. Greg C. Backman, Naval Base Seattle, 7500 Sand Point Way NE, Seattle, WA 98115.

FOR SALE: Apple II 48K Applesoft in ROM with Applesoft and reference manuals; 2 1/2 years old; \$890. Disk II with the DOS 3.3 manual. \$295. Disk II controller card: \$60. All in good condition: \$1200. All U.S. funds. I will pay shipping. Louis Roy, 2590 4th Ave., St-Georges Ouest, Cte Beauce, Quebec G5Y 3S8, Canada.

FOR SALE: HP-41C system: HP-41C, asking \$167/was \$250; Quad RAM, \$63/\$95; Two each RAM, \$20/\$60; PPC ROM with manuals, \$200/\$95; circuit-analysis ROM, \$20/\$30; card reader, \$143/\$215; bar-code reader, \$83/\$125; homebrew I/O breakout, \$10/\$30; three 3-inch binders of software and information, \$80/\$120. Everything above: asking \$500/was \$1020, shipping included. Jan Steinman, 4622 North 3rd St., Arlington, VA 22203, (703) 524-7560.

TO TRADE: I would like to swap Apple II programs: games, utilities, and business. Send me a list of your programs and I will send you mine. Also looking for people interested in corresponding. Matthias Pohl, Heidelbergstr. 33, 6901 Mauer, West Germany.

WANTED: High school student and future hacker would appreciate any kind of electronic junk or broken equipment you could send. I will pay shipment. Ricardo Correa K., Metsakorventie 6 A 4, 08500 Lohja as., Finland.

FOR TRADE: I would like to swap IBM PC software. Need graphics, games, utilities, financial, education, and home programs. Have many French programs. Send \$5 disk for one or mine. D. Coulombe, Box 1283 Notre-Dame, Levis, Quebec G6W 6A8, Canada.

WANTED: Reset key cover for Apple II keyboard to prevent Reset accidents when reaching for the Return key, or name of a supplier. Paul Connolly, 389 Courtland Ave., Stamford, CT 06906, (203) 327-3318.

FOR SALE: Shugart SA400: \$125. BASF 6106 SSDD: \$160. S-100 8K static RAM board: \$35. M6800 S-100 board: \$50. Datamedia 1521A video terminal: \$300 (\$1100 new). All currently in use, like new, with full documentation, UPS prepaid. Inquire about back issues of BYTE. Robert Boyd, Woodlawn Ave., Box 1044, Kennebunkport, ME 04046.

FOR SALE: HP 608D Signal Generator 10-420 MHz spare tubes, works: \$325. Dual Siemens FDD-100-5 5 1/4-inch drives with power supply and signal cable: \$400. New TI-59 calculator, hardly used: \$125. K. W. Humbard, Cape Lisburne AFS AK, APO Seattle, WA 98716, (907) 725-1237.

WANTED: Computer pen pals who want to connect with others via a modem, send your name, address, phone number, time you're available, and interests (programming or games, etc.) to Computer Pals, c/o Steve Smith, POB 27533, Atlanta, GA 30327.

FOR SALE: TRS-80 Model I, Level II with 16K and lowercase hardware installed: \$250. Also, Radio Shack Line Printer II with interface cable for TRS-80: \$300. Keith Wishart, Rt. 2 Box 13, Mapleton, MN 56065, (507) 524-3921.

FOR SALE: Radio Shack Quick Printer II with manual and cables for connection to Model I CPU and expansion interface. Perfect condition: \$100. Michael Friedman, 495 East 18 St., Brooklyn, NY 11226, (212) 282-4029.

WANTED: High school student with an interest in computers is looking for donations of equipment or manuals in any condition. Will try to cover shipping costs. Scott Fahey, 7 Boundary Circle, Brockton, MA 02402, (617) 588-4444.

WANTED: For Texas Instruments TI 99/4A: peripherals expansion system, modem, drives, RS-232C interface card, P-code card, or any other TI hardware or software. Wayne M. DeMello, 26 Norwell St., South Dartmouth, MA 02748, (617) 994-7885.

WANTED: Target game for SOL computer wanted, including any information or source code (300 bps tape). Need information on tape format. Also, Tarbell cassette interface for \$25 or less. Michael Dunn, 45 Livingston Rd. #501, West Hill, Ontario M1E 1K8, Canada, (416) 266-1635.

FOR SALE: Radio Shack Line Printer II [same as Centronics #730-I] with parallel interface for 9 1/2-inch fixed-pinned or up to 8 1/2-inch cut-sheet or roll paper; excellent condition, with dust cover, one ribbon, and manual. Will include cable for TRS-80 Model III and/or a homemade interface for direct connection to TRS-80 Model I keyboard, if desired. Shipped prepaid in U.S. on receipt of certified check: \$350, offers considered. David Shinn, 28 Wagon Bridge Run, Moorestown, NJ 08057.

FOR SALE: Public domain software for VIC-20 and CBM-64. Many useful games, utilities, and more. Includes complete documentation. Program-Pac with 10 CBM-64 programs: \$5. Ten programs on tape for VIC-20: \$5. Add \$1 for shipping. Prepaid; check or money order. Also, inquire about user group forming. J. Jesrani, 1052 Southeast 54th Ave., Ocala, FL 32671.

FOR SALE: Apple II Plus 48K without disk or monitor. Two years old, in perfect condition. Includes serial interface and 10 games on cassette: \$900. Mike Underwood, 11122 Fairhaven Ct. Apt E, Fairfax, VA 22030, (703) 352-0180.

FOR SALE: Two OSI C38 four-user systems. Both feature 200K static RAM, dual 8-inch floppy disks, and BOM Winchester disk. One system features one Centronics printer port and three RS-232 ports. The other features one Centronics printer port and one RS-232 port. Includes manuals, timeshare software, some custom software, and assorted goodies: \$13,000 each or prices negotiable. Rapid Die & Molding, 800 East Amelia, Cassville, WI 53806, (608) 725-5114 (ask for Barry).

FOR SALE: TRS-80 Model I 48K two Percom drives, lowercase conversion, Percom double-density board, RS-232, cassette, Quick Printer II, and all dust covers. All cables and many programs included. \$1700; I'll ship. Rick Thompson, 1212 El Camino Reale, Socorro, NM 87801.

FOR SALE: Ithaca Intersystems DPS-1 computer includes mainframe, front panel, Series II processor board, MIO board with two parallel and two serial ports, vectored interrupts, FDC-2 DMA disk controller, 64K of 8 1/2-inch bit memory. Also, a Heath H-19 terminal, and 8-inch double-density disk with power supply and cabinet. Software includes Pascal-Z, CPM, relocatable macro assembler, and m-bug. New \$5200, sell \$2500. Keith Pattison, 9629 Bradhugh Ct., Sacramento, CA 95827, (916) 361-3648.

FOR SALE: Commodore 64: \$275. Gemini printer with interface for Commodore: \$450. Dennis Hallingstad, (608) 269-2392.

FOR SALE: BYTE Vol. 1, No. 12 and all issues of Vol. 2, 3, 4, 5, 6, and Vol. 7, No. 9. (Inclusive, 68 consecutive issues). Best offer for all. W. J. Holland, 2675 Gulf of Mexico, Longboat Key, FL 33548.

FOR SALE: 12-inch RGB color monitor. Taxan RGB I; like new, only used several hours. Compatible with Apple II, Apple III, IBM and others: \$295 or best offer. David Klotzbach, 25 Columbia Circle, Plymouth, MA 02360, (617) 747-0430.

WANTED: Collections of software, programs, books, manuals, or magazines to buy pertaining to Atari 400/800. Stephanie Ring, Star Route Box 132, Staples, MN 56479, (218) 587-2838.

FOR SALE: Hewlett-Packard HP-41C calculator, card reader, quad RAM: \$225. Also, bar-code wand, timer module, extended function, extended memory modules, AME port extender, and HHC 16K EPROM box. Also, wanted: Commodore 2031 single disk drive in good condition. John E. Barnes, 13 Alcott Dr., Wilmington, DE 19808, (302) 453-3622 days; 994-7831 evenings.

FOR SALE: PowerText Word Processing System by Beaman Porter Inc., Apple III, version 1.61, brand new: \$100 or best offer. H. R. Flores, 113 Fairmont Ave., Worcester, MA 01604, (617) 756-2980.

FOR SALE: Okidata 84A printer with 200 cps, near letter-quality, high-resolution (144 by 144 dots per inch) graphics, downloadable character set, full software control. Also, free PROMs from manufacturer for future enhancements, parallel interface, friction/tractor feed, perfect condition: \$700. 2K serial board: \$75. Or both: \$750. Make an offer. D. B. Phuoc, Box 4403, Hayward, CA 94540, (408) 970-3832.

FOR SALE: BYTE, all issues from 1976 thru 1979. Make offer. G. March, 2110 Country Club Pkwy. SE, Cedar Rapids, IA 52403, (319) 364-0092.

FOR SALE: Novation 212 auto-cat modem. Brand new condition, asking \$500. Arnold Slavin, 655 Union Blvd., Totowa, NJ 07511, (201) 256-2300.

WANTED: College student would appreciate a donated computer for experiments. Vatche Terzian, 2421 Foothill Blvd. #22B, La Verne, CA 91750.

WANTED: SOL-20 systems manual, sections III and IX and Solos operating system manual. I will pay for duplication and postage. Jeff Henkels, 1312 Birch, Ames, IA 50013, (515) 294-7298.

WANTED: I have a BASIC-E compiler and interpreter; I need a users manual or other documentation for BASIC-E language. Will buy, rent, or borrow. Wm. F. Fowler, 4014 Hillwood Court, Beltsville, MD 20705.

FOR SALE: New Xerox 820 CPU module with printer port, communications port, and disk interface. ADDS Regent 40 terminal with printer port and manuals. Diablo 1650 38-cps daisy-wheel letter-quality printer with manual. RS-232C serial interface, and 1200 bps. Debbie Pullinger, 208-D Stephen Ave., Mary Esther, FL 32569, (904) 581-3319 after 5 p.m. CT.

FOR SALE: NEC 8001A computer, new condition: \$375. Bob Quint, 4378 Gina St., Fremont, CA 94536, (415) 657-7385.

WANTED: Used, serviceable, Xerox 88 character, metalized (9R21100 series) printwheels with over twenty typesets. Which typesets do you have? Bob Greenawalt, 9239 De Adalena St., Rosemead, CA 91770, (213) 572-0419 evenings.

FOR SALE: BYTE, first 16 issues, good condition, best offer. Edvv. L. Hayden, 16 Decatur Ave., Annapolis, MD 21403, (301) 267-6098.

WANTED: Apple II user interested in parameters needed to back up protected software using current copy programs such as Locksmith, Nibbles Away, etc. I am compiling a master list of parameters. Those who contribute may receive a copy. Philip McDermott, 1500 Audubon Parkway, Louisville, KY 40213, (502) 635-7867.

WANTED: Hewlett-Packard HP-IL digital cassette drive, HP-IL interface module, and HP-IL printer/plotter (HP 821 2A) all for HP-41C. Must be in good condition, reasonably priced. M. C. Akioglu, 120 Canterbury Lane, McMurray, PA 15317, (412) 237-2690.

FOR SALE: Software (in English and Spanish) for engineering, statistical analysis, process-control applications, as well as games and useful word processors for the VIC-20 (4K RAM, 22 column). José G. V. Humérez, casilla 525, Sucre, Bolivia, South America.

WANTED: To trade Visicalc and PFS File & Report programs for Apple III and to swap for same for use on Apple II Plus. Also, other programs to swap. Let's trade lists. G. M. Koellisch, 106 Reno Dr., Louisville, OH 44641.

FOR SALE: Heath H-8 computer, 32K RAM, serial/cassette interface board, extender board, Heath H-9 video terminal. Software: BUG-8, TED-8, HASL-8, Extended Benton Harbor BASIC. All schematics, assembly, and operation manuals. Also, EC-1100 BASIC programming course and EC-1108 Assembly Language course. Radio Shack CTR-41 cassette player, REmark magazine, all issues. Bill Ward, 3621 Lowden, Kalamazoo, MI 49008, (616) 345-2844.

FOR SALE: Several programs and games for Victor 9000 available in MS-DOS, dBASE II, Wordstar/Mailmerge/Spelling, Multiplan, Report Manager (Victorcal), Programmers Tool Kit, Graphics Tool Kit, BASIC Compiler, Pascal, and FORTRAN: \$100 to \$200. Bruce Glenn, Image Equipment, 90 Park Ave., New York, NY 10016, (212) 697-8606.

FOR SALE: Two disk drives. Tandem TM100-1, 5 1/4-inch (for IBM), SS/DD drive, no power supply or case: \$170 each. Jim Lovewell, 1490 East Juana, San Leandro, CA 94577, (415) 351-6207.

UNCLASSIFIED POLICY: Readers who have computer equipment to buy, sell, or trade or who are requesting or giving advice may send a notice to BYTE for inclusion in the Unclassified Ads section. To be considered for publication, an advertisement must be noncommercial (individuals or bona fide computer clubs only), typed double-spaced on plain white paper, contain 75 words or fewer, and include complete name and address. This service is free of charge; notices are printed once only as space permits. Your confirmation of placement is appearance in an issue of BYTE as we engage in no correspondence. Please allow at least three months for your ad to appear. Send your notices to Unclassified Ads, BYTE/McGraw-Hill, POB 372, Hancock, NH 03449.

Unclassified Ads

FOR SALE: An unused Apple II Language Card: \$130 or best offer. K. Sung, 0-11 Pine Grove, Ypsilanti, MI 48197, (313) 483-7998.

WANTED: Professional software for the dimensioning of heat-plate exchangers when given the desired temperature, sanitary warm water can supply, the needed temperature of the primary circuit, the dimensions and number of the plates, and the thermic coefficient of the exchanger. Also, software for chemical balance needed for ideal swimming pool-water conditions. M. Riccio, Lloyd & Limaro SA, Rue Dufour 34, CH-2500 Bienne 3, Switzerland; tel: (032) 42 43 66; Telex: 349 475.

WANTED: Apple software to trade. Send a list and SASE of your games or utilities software and I will send you mine. Ralph Boswell, 8 George Washington Dr., Titusville, NJ 08560.

FOR SALE: Wintek System, 32K RAM, refresh card, two serial and two parallel ports. Monitor in ROM, cassette interface at 300 to 2400 bps. BASIC in ROM, 8K open ROM slots. 8-slot motherboard, power supply. Wintek terminal, Setchell-Carlson monitor, modem, TSC cassette BASIC (extended), TSC Relocator, Wintek Editor/Assembler, and more: \$1350. February '80 through January '83 68000 Micro Journal. Make an offer. John Adams, 8303 Kenwood Rd., Cincinnati, OH 45236, (513) 793-2338.

WANTED: If you're building a digital synthesizer (like I am) or if you want to share ideas, let's start DSIG, Digital Synthesis Information Group. Shane Bouslough, Pond View Rd., RR2, Wading River, NY 11792, (516) 929-6436.

WANTED: S-100 components. IMSAI or Cromemco mainframe, Cromemco TUART, 16FDC, ZPU, 64KZ Rev. J, CCS 2066 RAM. Possibly interested in S-100 hard disk, 9-track 1600 BPI tape, and I/O boards. Gary Sanford, POB 1689, Lowell, MA 01853, (617) 263-2389 evenings.

FOR SALE: DEC LSI II homebrew system. KD II CPU with EIS/FIS, DLV II, 64K-bytes RAM, Unibus adapter, RK II disk interface with Diablo 33 disk drive. Also, second Diablo drive and all power supplies. Will run BASIC and FORTRAN under RT II: \$2000 or best offer. David Barr, 37 Ruthven Place, Summit, NJ 07901, (201) 582-3227 days.

FOR SALE: Texas Instruments 742 intelligent terminal with a Silent 700 ASR terminal, 80-column thermal printer, two built-in digital-cassette tape drives under full program control, 2K of programmable RAM, a built-in 1200-bps modem (requires a DAA phone company interface), and two serial RS-232C interfaces. Also, Assembler, mini Word Processor, utilities, manuals, digital-cassette tapes, and supplies included: \$500. Neal Fahrer, 5909 Blairstone Dr., Culver City, CA 90230, (213) 836-8615.

WANTED: Zorba owners who would like to start (or join) a user's group for Telcon's Zorba to explore its potential by exchanging information, ideas, advice, software, and a newsletter. Jeffrey Timm, 6J Aspirwood Way, Baltimore, MD 21237.

FOR SALE: Burroughs L5000 accounting machine in excellent condition. Printer has 25-inch carriage with 250 print positions and three feeds: one friction and two pin. Full alpha and numeric keyboards with 24 auxiliary subroutine keys. Built-in hard disk and paper-tape reader. Would consider trade for mini computer system or 77 David A. Livsey, POB 990, Escondido, CA 92025.

WANTED: Names and addresses of Superbrain users groups around the country that I may correspond with or join. Also interested in CP/M users groups using 5 1/4-inch disk formats. Want to sell: printer cable for Atari 850 interface to standard 36-pin parallel-printer port. Reasonable. L. David Paquette, 14 North Ridge, Ballston Lake, NY 12019, (518) 899-6376.

FOR SALE: New and used S-100 boards. Z80-based CPU boards with serial port and parallel port: \$120. 8K static RAM boards: \$40. Input/output boards with three serial and two parallel ports: \$95. L. Cobbletick, 192 River Valley Dr., Chesterfield, MO 63017, (314) 576-0957 nights or 569-2660 days.

FOR SALE: Memorex 5440 disk cartridges for Diablo series 40 disk drives or CDC Hawk disk drives. \$15 each or will trade. Blane Woodard, 4942 North Diversey, Whitefish Bay, WI 53217, (414) 963-1423 evenings.

WANTED: High school student/programmer seeking correspondence with owners of TRS-80 Color Computers to exchange programs and information. Glen Button, POB 536, Cheshire, CT 06410.

FOR TRADE: Large library of Apple software to trade. Send me a list with SASE of your programs and I'll send you mine. Wayne Reibold, 205 North Loraine Ave., Glendora, CA 91740.

A Popular Preview

The Product Preview of Hewlett-Packard's HP 150 proved to be the most popular article in BYTE's October issue. Staffers Phil Lemmons and Barbara Robertson will have to forfeit the \$100 prize. For his User's Column, "New Computers, Boards, Languages, and Other Tidbits," Dr. Pournelle won the \$50 prize. For third place, readers selected "An Interview: The HP 150's Design-team Leaders," also written by the authors of October's winning Product Preview. In fourth place is "The Unix Tutorial, Part 3: Unix in the Micro-computer Marketplace," written by David Fiedler. And Steve Ciarcia won fifth place with the second part of his Circuit Cellar project entitled "Build the Micro D-Cam Solid State Video Camera, Part 2: Computer Interfaces and Control Software." Congratulations to these authors.

Correspondence

Address all editorial correspondence to the editor at BYTE, POB 372, Hancock, NH 03449. Unacceptable manuscripts will be returned if accompanied by sufficient first-class postage. Not responsible for lost manuscripts or photos. Opinions expressed by the authors are not necessarily those of BYTE. Entire contents copyright © 1983 by BYTE Publications Inc. All rights reserved. Where necessary, permission is granted by the copyright owner for libraries and others registered with the Copyright Clearance Center (CCC) to photocopy any article herein for the flat fee of \$1.50 per copy of the article or any part thereof. Correspondence and payment should be sent directly to the CCC, 21 Congress St., Salem, MA 01970. Specify ISSN 0360-5280/83. \$1.50. Copying done for other than personal or internal reference use without the permission of McGraw-Hill is prohibited. Requests for special permission or bulk orders should be addressed to the publisher. BYTE® is available in microform from University Microfilms International, 300 North Zeeb Rd., Dept. PR, Ann Arbor, MI 48106 USA or 18 Bedford Row, Dept. PR, London WC1R 4EJ England.

BOMB BYTE's Ongoing Monitor Box

Article #	Page	Article	Author(s)
1	37	Build the Circuit Cellar Term-Mite ST Smart Terminal, Part 1: Hardware	Ciarcia
2	53	BYTE West Coast: Beyond the Word Processor	Lemmons
3	61	User's Column: Too Many Leads, or What in *;?#''? Goes First?	Pournelle
4	104	Reason and the Software Bus	Korns
5	122	A General-Purpose Robot-Control Language	Prendergast, Slade, Winkless, Mateosian
6	134	1984, the Year of the 32-bit Microprocessor	Mills
7	154	Memory Cards: A New Concept in Personal Computing	Jadrnicek
8	172	Computer-aided Design	White
9	213	Speech Recognition: An Idea Whose Time Is Coming	Eisenberg, Hill
10	226	Using Natural-Language Systems on Personal Computers	Winer, Winer
11	243	Portables—1984 and Beyond: Idea-Processing Software and Portable Computers	Banning
12	251	Beyond the Application Program: A Different Approach to Integrated Software	Skier
13	268	The Zenith Z-100	Holden
14	282	Pinball Construction Set	Barry, Jacobson
15	288	The TRS-80 Model 16B with Xenix	Haas
16	324	Naturallink to Dow Jones News/Retrieval	Gillette
17	339	The Vamp DVM-1 Computer/TV Interface Kit	Callamaras
18	349	The Einstein Compiler	Bates
19	354	The Basis 108	Wheeler
20	362	Bubbles on the S-100 Bus, Part 1: The Hardware	Maxwell, Ornstein
21	384	Mockingbird: A Composer's Amanuensis	Carter, Bonds
22	403	The VU68K Single-Board Computer	Bonds
23	417	Translating the SAS Language into BASIC	Bass
24	437	A Software Review Method That Really Works	Citron
25	442	Real-Time Clocks and PC-DOS 2.0	Broadwell

Reader Service

Inquiry No.	Page No.	Inquiry No.	Page No.	Inquiry No.	Page No.	Inquiry No.	Page No.
1	1 SUPER WAREHOUSE 443	83	COMPUPRO 277	161	FALCON SAFETY PROD. 150	239	MCGRW-HILL CES 352, 353
2	1ST NATIONAL COMPUTER 523	84	COMPUPRO 389	162	FIGURE-LOGIC BUS. EQUIP. 506	240	MEMTEK INC. 65
*	1ST PLACE SYSTEMS 445	85	COMPUSERVE 163	163	FIGURE-LOGIC BUS. EQUIP. 550	241	MET-CHEM INT'L CORP. 530
*	20TH CENTURY PLASTICS 424	86	COMPUSHACK 405	475	FLIP-IT 299	240	METRO SOFTWARE INC. 139
4	3R COMPUTERS 363	86	COMPUTER ACCESSORIES 181	164	FLOPPY DISK SERV. INC. 511	242	MFJ ENTERPRISES INC. 440
5	800 SOFTWARE 69	87	COMPUTER CHANNEL 245	165	FORMULA INT'L 520	243	MICRO AGE COMP STORES 93
490	A-SYSTEMS 439	88	COMPUTER CLASSIFIED 432	166	FORMULA INT'L 520	482	MICRO CONTROL SYS. 98, 99
456	A.S.T. RESEARCH 113	89	COMPUTER CONTINUUM 504	222	FREEDOM COMP. MART 509	246	MICRO MANAGEMENT SYS. 278
7	AB COMPUTERS 505	90	COMPUTER DISCOUNT PROD. 524	168	GENERAL TECHNOLOGY 205	247	MICRO MINT 425
8	ABC COMPUTER LTD 518	91	COMPUTER FOOD PRESS 516	169	GENIE COMPUTER CORP. 359	248	MICRODYNAMICS 514
9	ABC DATA PRODUCTS 238	93	COMPUTER INNOVATIONS 260	170	G&G ENGINEERING 79	249	MICROHOUSE 266
10	ACL INC. 276	94	COMPUTER MAIL ORDER 382, 383	170	GIFFORD COMP. SYS. 79	250	MICROLAND 518
11	ACTION COMPUTER 89	95	COMPUTER PLUS 215	171	GILTRONIX, INC. 510	251	MICROMAIL 522
12	ADDMASTER CORP. 506	96	COMPUTER POST INC. 515	293	GRAY MARKET, THE 500	480	MICROPRO 333
13	ADROIT ELECTRONIC INC. 550	97	COMPUTER PRICE CLUB 516	172	GREAT SALT LAKE COMP. 531	252	MICROPROCESSORS UNLTD. 502
14	ADV. COMP. PROD. 538, 539	96	COMPUTER SOFTWARE ASSOC. 512	173	GREAT SALT LAKE COMP. 532, 533	252	MICROSOFT CORP. 55, 170, 171, 255
*	ADV. DIGITAL CORP. 247	98	COMPUTER SOFTWARE STORE 328	174	GTEK INC. 296	253	MICROTAX 275
15	ADV. GRAPHIC ENGINEERING 512	455	COMPUTER TECHNOLOGY 394	*	H&E COMPUTRONICS 137	254	MICROTECH EXPORTS 221
16	ADV. SYS. CONCEPTS 470	101	COMPUTER TECHNOLOGY 504	176	H&M DISK DRIVE SERVICES 440	255	MICROWARE 75
*	ALF PRODUCTS, INC. 18	102	COMPUTER TECHNOLOGY 518	177	H.H.S. MICROCONTROLLERS 506	256	MILLER MICROCOMP.SERV. 447
474	ALPHA BYTE 304	99	COMPUTER WAREHOUSE 147	178	HANDWELL CORP. 95	258	MINI MICRO MART 161
17	ALPHA ENTERPRISES 550	99	COMPUTERFEST USA 186, 187	179	HANDWELL CORP. 526	259	MITEL 152, 153
488	ALPHA NUMERIC 439	103	COMPUTER-MATE INC. 250	181	HAYES MICROCOMP.PROD. 400, 401	260	MOUNTAIN VIEW PRESS 220
20	AM MICRO 396	104	COMPUTERS AND MORE 83	182	HEATH COMPANY 76	261	MTI SYSTEMS CORP. 232
21	AMDEK CORP. 52	105	COMPUTERS AND MORE 508	183	HEWLETT-PACKARD 264, 265	262	MUSYS CORP. 63
22	AMER. BUYING & EXPORT 298	106	COMPUTERS WHOLESAL 203	486	HEWLETT-PACKARD 441	262	MY SUPPLIER INC. 508
24	AMER. SQUARE COMP. 301	493	COMPUTRONIX 476	184	HITACHI 327	457	MYTEK 328
24	AMERICAN EXPRESS CO. 431	107	CONCURRENT CORP. 380	185	HOUSTON INSTR. DIV OF	471	NATIONAL INSTRUMENTS 209
*	AMERICAN TOURISTERS 97	107	CONLEY GRAPHICS 439	186	BAUSH & LOMB 60	263	NEBS COMPUTER FORMS 302
26	ANADEX 157	73	CONROY-LAPOINTE 210, 211	187	HUMAN DESIGNED SYS. 233	264	NEC HOME ELECTR.USA 14
27	ANN ARBOR TERMINALS 366	74	CONROY-LAPOINTE 210, 211	466	IBM CORP. 248, 249	265	NEC INFORMATION SYS. 280, 281
28	ANTEX DATA SYS. 428	75	CONROY-LAPOINTE 210, 211	129	IBM SSD 435	267	NETRONICS 448
29	APPARAT INC. 107	109	CONSOLINK 114	129	IMAGE COMPUTER 506	267	NETWORK CONSULTING INC. 77
485	APPLE COMPUTER INC. CII, 1	110	CONSOLINK 115	188	IN-SYNC 508	268	NETWORK CONSULTING INC. 207
30	APPLE COUNTRY LTD. 501	111	CONTINENTAL PRESS INC. 516	189	INCOMM 48	495	NEVADA COMPUTER 476
31	APPLEWARE INC. 514	333	CONTROL DATA 151	190	INDEPENDENT BUSN.SYS.INC. 361	*	NORTH HILLS CORP. 516
32	ARTIFICIAL INT'L. RESEARCH 516	112	CONTROL ELECTR. INC. 215	191	INTEGRAND 234	269	NORTH HILLS CORP. 516
33	ASHTON-TATE 303	114	CORONA DATA SYS. 74	190	INTERACTIVE MICROWARE 318	269	NORTHWEST DIGITAL SYS. 88
34	ASHTON-TATE 399	115	CORVUS SYS. INC. 129	192	INTERACTIVE STRUCT. 82	270	NRI SCHOOLS ELECTR.DIV. 257
35	ATARI SOFT 408, 409	116	COSMOS 239	193	INTERCONTRN. MICRO SYS. 231	270	O'HANLON COMP.SYS. 253
36	AVOCET 155	487	CRE WHOLESALE PROD. 439	194	INTERDATA SYSTEMS INC. 510	271	OASIS SYSTEMS 322, 323
37	B&B ELECTR. 506	417	CRE WHOLESALE PROD. 504	195	INTERTEC DATA SYS. 11	272	OCCO 302
38	BASF SYSTEMS 71	118	CREATIVITY UNLTD. 530	461	IPF 454	463	OMNISOFT 81
39	BAY TECHNICAL ASSOC. 259	119	CREMEMCO 5	467	IQ TECHNOLOGIES 402	273	ORA ELECTRONICS 519
40	BELLANGER RESEARCH ASSOC. 426	120	CRYPTRONICS INC. 330	197	J.C. SYSTEMS 279	273	ORANGE MICRO 28, 29
41	BELL, JOHN ENGR. 503	121	CUESTA SYSTEMS 514	198	JADE COMP. PROD. 542, 543	274	ORX SYSTEMS 306, 307
42	BG COMPUTR APPLICATIONS 502	122	CUSTOM COMP. TECH. 525	199	JADE COMP. PROD. 544, 545	276	OSBORNE/MCGRW-HILL 223, 224, 225
43	BHRT 212	123	DATA ACQUISITIONS SYS. 286, 287	200	JAMECO ELECTR. 534, 535	23	OZTECH 512
*	BINART TECHNOLOGY 550	357	DATA SPEC 429	201	JDR MICRODEVICES INC. 551	278	PACIFIC COMPUTERS 298
*	BORLAND INT'L. 183	124	DATA STORAGE SOLUTIONS 242	202	JDR MICRODEVICES INC. 552, 553	278	PACIFIC EXCHANGES 504, 506, 508, 512, 514, 518, 530, 550
46	BOTTOM LINE, THE 67	125	DATA STORAGE SOLUTIONS 242	203	JDR MICRODEVICES INC. 554, 555	279	PACIFIC INFOTECH CORP. 420
47	BROKER SOFTWARE SERV. 320	470	DATA TECH INDUSTRIES 357	204	JDR MICRODEVICES INC. 556	280	PAN AMERICAN ELEC. INC. 510
48	BUSINESS SOFTWARE 87	127	DATASOUTH COMP. CORP. 31	216	JEB SYSTEMS 126	281	PANASONIC IND. CO. 413
49	BUSINESS SOFTWARE 87	128	DELUXE COMP. FORMS 418	205	JUKI INDUSTRY OF AMERICA 313	282	PASOCOT 26
*	BYTE PUBL. BACK ISSUES 398	476	DIAMOND SFTW. SUPPLY 236	206	KADAK PRODUCTS 424	277	PC NETWORK 343
*	BYTE PUBL. INC. 479	276	DIGISOFT 299	207	KAYPRO 390	337	PC WARE INC. 240, 241
50	BYTEC HYPERION 72, 73	130	DIGITAL EQUIPMENT CORP. 336, 337	208	KELLY COMP. SUPPLIES 518	285	PEGASUS DATA SYS. 68
51	BYTEK COMP. SYS. CORP. 334	131	DIGITAL RESEARCH 432	208	KELLY COMP. SUPPLIES 530	287	PERCOM DATA 7
52	BYTEWRITER 136	*	DIGITAL RESEARCH COMP. 521	210	KENSINGTON MICROWARE 365	287	PHONE 1, INC. 25
53	C WARE 358	132	DIRECT SOFTWARE 371	212	KERN PUBLICATIONS 468	288	PJS 530
*	C-SYSTEMS 530	133	DISCOUNT SOFTWARE 118	213	KERN PUBLICATIONS 469	289	PRACTICAL PERIPH. 185
55	C.S.D. INC. 188	132	DISKS 'N THINGS 508	214	KEYTRONICS CORP. 103	472	PRACTICAL PERIPH. 292
383	CABLES UNLTD. 514	134	DISKWORLD 422, 514	469	KNAUFT CO. 508	473	PRACTICAL PERIPH. 294
46	CALIF. DATA CORP. 506	136	DISPLAY TELECOMMUNCTNS. 507	217	KNOWLEDGE SYS. 331	290	PRINCETON GRAPHIC SYS. 50, 51
*	CALIF. DIGITAL 540, 541	137	DMA 397	218	LABORATORY MICROSYS. 391	291	PRINTTEK 274
*	CALIF. MICRO COMP. 394	137	DOKAY COMP. PROD. INC. 536, 537	484	LANGLEY-ST. CLAIR 49	292	PRINTER STORE, THE 82
57	CDR SYSTEMS 512	138	DOW JONES SOFTWARE 345	218	LAWSON LABS 510	292	PRIORITY ONE 546, 547
*	CENTENNIAL COMP. PROD. 84, 85	139	DWIGHT CO., INC. 518	219	LEADING EDGE PROD CIII	294	PRO MICROSYSTEMS 512
497	CHAMPION SOFTWARE 273	140	DYNACOMP 514	220	LEXICOMP DATA SYS. 550	296	PROMETHEUS PRODUCTS 119
498	CHAMPION SOFTWARE 273	141	DYSAN CORP. 410	221	LIBERTY ELECTRONICS 218	297	PRYOR CORP. 22
58	CHANNEL CONNECTION 499	142	E.T.I. 92	499	LIBERTY GROUP 458	297	PURCHASING AGENT, THE 142
59	CHIPS & DALE 514	143	EAGLE SOFTWARE 420	483	LIGHT MACHINE CORP. 128	298	QUADRAM CORP. 20, 21
60	CHRISLIN IND. INC. 423	145	EASTERN ENTERPRISES 473	215	LIGO RESEARCH INC. 177	299	QUANT SYSTEMS 512
61	CLEO/COPLEY PRESS 309	146	ECOSOFT 246	223	LOGICAL DEVICES 80	301	QUIBE DISTRIBUTING 216, 217
62	CLEVELAND CODONICS 96	147	EDGE MICROSYSTEMS 329	224	LOGICAL DEVICES 516	302	QUIBE DISTRIBUTING 305
63	CMC, INT'L 30	489	EDUCATIONAL MICROCOMP. 439	225	LOMAS DATA PRODUCTS 235	303	RADIO SHACK CIV
65	COGITATE 516	148	ELCOMP 510	227	LOTUS DEVELOPMENT 111	388	RANA SYSTEMS 17
66	COLORADO COMP. PERIPH. 518	149	ELECTRADE CO. 516	228	LSI JAPAN CO. 510	307	RANA SYSTEMS 19
67	COLUMBIA DATA PROD. 189	150	ELECTRADE CO. 518	229	LYBEN COMP. SYS. 502	307	RELMS 444
68	COMMAND SERVICES CORP. 504	151	ELECTRONIC PROTECTION DEV. 36	230	LYBEN COMP. SYS. 504	308	ROCKY MTN. SOFTWARE 196, 197
69	COMMERCIAL BUSINESS SYS. 496	152	ELECTRONIC SPECIALISTS 320	231	LYCO COMPUTER 517	308	ROGERS LABS 508
70	COMMUNICATIONS ELECTR. 364	153	ELECTRONICS 450	232	M-H RECRUITMENT 446	309	RTL PROGRAMMING AIDS 506
71	COMP. COMPNTS. UNLTD. 527	153	ELLIS COMPUTING INC. 427	233	MA SYSTEMS 90	310	RYDEX INDUSTRIES CORP. 149
72	COMP. COMPNTS. UNLTD. 528, 529	154	EMERY AIR FREIGHT 319	234	MACMILLAN BOOK CLUBS 321	312	S-100 DIV. 696 CORP. 141
76	COMP. WHOLESALERS OF	155	EMPIRICAL RESEARCH GROUP 415	236	MACROTECH INT'L. 395	313	SAFEGARE 391
FREDERICK 475	19	ENGINEERING SPECIALTIES 506	459	237	MANX SOFTWARE SYS. 64	314	SAGE COMP. TECH. 421
* COMPAQ COMPUTER CORP. 12, 13	459	ENTER COMPUTER 109	460	237	MARITIME SOFTWARE 504	315	SCION CORP. 8
* COMPETITIVE EDGE 142	157	EXCEL 419	157	237	MARYMAC INDUSTRIES 510	316	SCOTSDALE SYSTEMS 127
78 COMPUPADD 502	158	EXCEL 449	158	238	MAXELL DATA PRODUCTS 34, 35	317	SCREENWARE 502
80 COMPUPADD 502	157	EXPOTEK 291	157	238	MAYNARD ELECTRONICS 33	317	SEATTLE COMP.PRODS. 416
81 COMPUPADD 502	158	EXTENDED PROCESSING 477	158	238	MCT 27	318	SEEQUA COMP. CORP. 167
82 COMPUPADD 502	159	EXXON OFFICE SYSTEMS 550	160	238	MC-P APPLICATIONS 463	320	SELECTONE CORP. COMP. PROD. 512
381 COMPUMEDIA 530	160	F.T.G. DATA SYSTEMS 518			MCGRW-HILL BOOK CO. 484, 465	321	SEMI DISK SYSTEM 285
						322	SENTINEL COMP. PROD. 24
						322	SILICON SPECIALTIES 32
						325	SLICER COMPUTERS 70
						326	SLR SYSTEMS 504
						327	SOFTCRAFT 222
						494	SOFTSMYTHRE SOFTWARE 476
						491	SOFTRENT 439
						458	SOFTWARE ARTS 338
						329	SOFTWARE BANC 229
						330	SOFTWARE BANC 201
						331	SOFTWARE FASHION 318
						332	SOFTWARE SERVICES 504

To get further information on the products advertised in BYTE, fill out the reader service card with your name and address. Then circle the appropriate numbers for the advertisers you select from the list. Add a 20-cent stamp to the card, then drop it in the mail. Not only do you gain information, but our advertisers are encouraged to use the marketplace provided by BYTE. This helps us bring you a bigger BYTE. The index is provided as an additional service by the publisher, who assumes no liability for errors or omissions. *Correspond directly with company.

Reader Service

Inquiry No.	Page No.	Inquiry No.	Page No.	Inquiry No.	Page No.	Inquiry No.	Page No.
334	SOLUTIONWARE CORP. 530	348	TAVA CORP. 283	360	TITAN TECHNOLOGIES 379	375	WANG ELECTR.PUB. INC. 91
335	SRX SYSTEMS 508	349	TAYCO BUSINESS FORMS 514	361	TRANSACTION STORAGE SYS. 271		WAREHOUSE SOFTWARE 370
462	STANDARD DATACOM 433		TDK ELECTRONICS 132, 133,	362	TRANSTAR 143	376	WASHINGTON COMP.SYS. 351
336	STAR MICRONICS 191		* TEKTRONIX INC. 58, 59	363	TRANSTAR 414	377	WCB COMPUTERS 510
501	STAR SOFTWARE SYS. 436	350	TEKTRONIX Y3-312 175	364	TRISTAR DATA-SYS. 118	378	WHITESMITHS LTD 145
502	STAR SOFTWARE SYS. 436	351	TELAUTOGRAPH CORP. 232	365	TSK ELECTR.CORP. 369	379	WILLIAMS, MARK CO. 138
478	SUN SOFTWARE 348	352	TELETEK ENTERPRISES, INC. 23	465	U.S. AIR FORCE 513	380	WINTEK CORP. 508
339	SUNNY INT'L. 498	353	TELTONE 86	367	U.S. MICRO SALES 548, 549		WOODWORKS 502
340	SUNOL SYSTEMS 381	354	TERMINAL DATA CORP. 510	368	U.S. ROBOTICS 57	382	WRITING CONSULTANTS 550
341	SUNTRONICS 500	492	TERMINALS TERRIFIC 360	368	UNIPRESS SOFTWARE INC. 300	384	WYSE TECHNOLOGY 169
342	SUPERSOFT 315	464	TEXAS COMPUTER SYS. 237	370	VIDEX 15	385	X COMP 199
343	SUPERSOFT 317		TEXAS INSTRUMENTS 120, 121, 311	371	VISUAL TECH, INC. 261	481	XEROX EDUC. 335
196	SWIG 195	355	TEXAS INSTRUMENTS 438	477	VISUAL TECH, INC. 346, 347		
	SYNCOM 386	356	THREE M COMPANY 297		VLM COMPUTER ELECTR. 530		
345	SYSTAT INC. 94	500	TINNEY, ROBERT GRAPHICS 200	372	VOTRAX 293		
346	TAB BOOKS 193	358	TITAN TECHNOLOGIES 375	373	VR DATA 295		
347	TATUM LABS 516	359	TITAN TECHNOLOGIES 377	374	WADSWORTH ELECTR.PUB.CO. 158		

*Correspond directly with company.

BYTE ADVERTISING SALES STAFF:

J. Peter Huestis, Advertising Sales Manager, 70 Main Street, Peterborough, N.H. 03458 Tel (603) 924-9281

NEW ENGLAND

ME, NH, VT, MA, RI
Paul McPherson, Jr. (617) 262-1160
McGraw-Hill Publications
607 Boylston Street
Boston, MA 02116

ATLANTIC

NJ (NORTH), NY, NYC, CT
Eugene Duncan (212) 512-2096
McGraw-Hill Publications
1221 Avenue of the Americas—39th Floor
New York, NY 10020

Dick McGurk (212) 512-3588

McGraw-Hill Publications
1221 Avenue of the Americas—39th Floor
New York, NY 10020

EAST

PA (EAST), NJ (SOUTH), MD, VA, W.VA, DE, D.C.
Daniel Ferro (215) 496-3833
McGraw-Hill Publications
Three Parkway
Philadelphia, PA 19102

SOUTHEAST

NC, SC, GA, FL, AL, TN
Maggie McClelland (404) 252-0626
McGraw-Hill Publications
4170 Ashford Dunwoody Road—Suite 420
Atlanta, GA 30319

MIDWEST

IL, MO, KS, IA, ND, SD, MN, WI, NB
Jack Anderson (312) 751-3740
McGraw-Hill Publications
Blair Building
645 N. Michigan Ave.
Chicago, IL 60611

GREAT LAKES, OHIO REGION

MI, OH, PA (ALLEGHENY), KY, IN, EASTERN CANADA
Dennis Riley (313) 352-9760
McGraw-Hill Publications
4000 Town Center—Suite 770
Southfield, MI 48075

SOUTHWEST, ROCKY MOUNTAIN

UT, CO, WY, OK, TX, AR, MS, LA
Alan Morris (214) 458-2400
McGraw-Hill Publications
Prestonwood Tower—Suite 907
5151 Beltline
Dallas, TX 75240

SOUTH PACIFIC

Southern CA, AZ, NM, LAS VEGAS
Page Goodrich (714) 557-6292
McGraw-Hill Publications
3301 Red Hill Ave
Building #1, Suite 222
Costa Mesa, CA 92626

Karen Niles (213) 480-5243, 487-1160
McGraw-Hill Publications
3333 Wilshire Boulevard #407
Los Angeles, CA 90010

NORTH PACIFIC

HI, WA, OR, ID, MT, NORTHERN CALIF, NV [EXCEPT LAS VEGAS], W. CANADA
David Jern (415) 362-4600
McGraw-Hill Publications
425 Battery St.
San Francisco, CA 94111

Bill McAfee (415) 964-0624

McGraw-Hill Publications
1000 Elwell Court—Suite 225
Palo Alto, CA 94303

WEST COAST SURPLUS AND RETAIL ACCOUNTS

Tom Harvey (805) 964-8577
3463 State St.—Suite 256
Santa Barbara, CA 93105

Post Card Mailings

National
Bradley Browne (603) 924-6166
BYTE Publications
70 Main Street
Peterborough, NH 03458

International Advertising Sales Representatives:

Mr. Hans Csokor
Publimedia
Relsnerstrasse 61
A-1037 Vienna, Austria

Mrs. Gurit Gepner
McGraw-Hill Publishing Co.
115 Yosephthal St.
Bat Yam, Israel
866 561 321 39

Mr. Fritz Krusebecker
McGraw-Hill Publishing Co.
Liebigstrasse 27C
D-6000 Frankfurt/Main 1
West Germany
72 01 81

Mrs. Maria Sarmento
Pedro Telxelra 8, Off. 320
Iberia Mart 1
Madrid 4, Spain
45 52 891

Mr. Andrew Karnig
Andrew Karnig & Associates
Kungsholsgatan 10
112 27 Stockholm, Sweden
08 51 68 70

Mr. Michael Sales
McGraw-Hill Publishing Co.
17 rue Georges Bizet
F 75116 Paris
France
720 33 42

Mr. Arthur Scheffer
McGraw-Hill Publishing Co.
34 Dover St.
London W1X 3RA
England
01 493 1451

Mr. Emilio Zerboni
McGraw-Hill Publishing Co.
Via Flavio Baracchini 1
20123 Milan, Italy
86 90 656

Seavex Ltd.
05-49/50 Tanglin Shopping Center
19 Tanglin Rd. Singapore 1024
Republic of Singapore

Seavex, Ltd.
Room 102, Yu Yuet Lal Bldg.
43-55 Wyndham St. Central
Hong Kong

Paul Ishii
McGraw-Hill Publications
Overseas Corp.
Room 1528
Kasumigaseki Bldg.
3-2-5 Kasumigaseki, Chiyoda-Ku
Tokyo 100, Japan

History will record as a profound irony that the most powerful word processing package ever created for the IBM® Personal Computer can be worked with two fingers.



It was created by Leading Edge®, specifically to take advantage of the power of the IBM PC, plus the simplicity that all that power ought to be able to give you—but didn't.

Until now, you could go for the simplicity, and end up with a somewhat glorified typewriter. Or you could go for the power, and go nuts performing dozens of commands to do even the simplest things.

But with Leading Edge Word Processing™ you get both.

You don't have to start with an ounce of understanding about word processing.

You don't even have to be a terrific typist. (Matter of fact, the worse you type, the more the help.)

So come along:

Hunt and peck your way into the future.



Leading Edge Products Inc., Headquarters and Retail Division, 225 Turnpike Street, Canton, Mass. 02021 (800) 343-6833 (617) 828-8150

*IBM is a registered trademark of International Business Machines Corporation.

Call Margie for the dealer nearest you.

Circle 219 on inquiry card.

Radio Shack Presents the Transportable TRS-80[®]

The New Model 4P Computer—From the World's Largest Computer Retailer



The Computer for Today's Upwardly Mobile Society

If you're headed for success, our newest TRS-80 can help you get there in record time. The Model 4P is a compact, disk-based desktop computer with a big difference: it has a handle. So wherever your work may take you, you can get a handle on scheduling problems, ever-changing sales projections, and last minute reports. It's like having your office with you on trips, at home—anywhere!

A Completely Portable, Self-Contained System

We don't sacrifice features for portability, either. The Model 4P comes standard with two 184,000-character disk drives and 64K internal memory. You also get a full 80-character by 24-line 9" display, an electric typewriter-quality keyboard with numeric keypad, and printer and communications interfaces. And you can add an extra 64K of memory, an internal modem or even external hard disk drives!

"Off the Shelf" Software

In addition to running the entire selection of TRS-80 Model III/4 disk software, you can add the optional CP/M Plus™ operating system to use thousands of additional ready-to-run programs.



Easy to Use, Easy to Tote

The Model 4P works anywhere there's AC. And when you're ready to move on, slip the keyboard into the hi-impact case, snap on the protective cover and go. It weighs just 26 pounds.

Like Every TRS-80, We Stand Behind the "4P" 100%

Tandy Corporation is a two-and-one-half billion dollar company with over 6,600 stores nationwide. That means software, service, leasing plans and friendly faces are always just around the corner.

Available Nationwide

Stop by your nearest Radio Shack Computer Center, participating store or dealer today and find out where Model 4P will take you.

Radio Shack[®]

The biggest name in little computers[®]
A DIVISION OF TANDY CORPORATION

Circle 303 on inquiry card.

TRS-80 Model 4P Computer

1799⁰⁰

26-1080

Commercial Lease Available
For Only \$65 Per Month
(Plus Applicable Use/Sales Tax)

Prices apply at participating Radio Shack stores and dealers.
CP/M Plus is a trademark of Digital Research.

