

Extra All-IBM Edition

BYTE
THE SMALL SYSTEMS JOURNAL®

Inside the IBM PCs

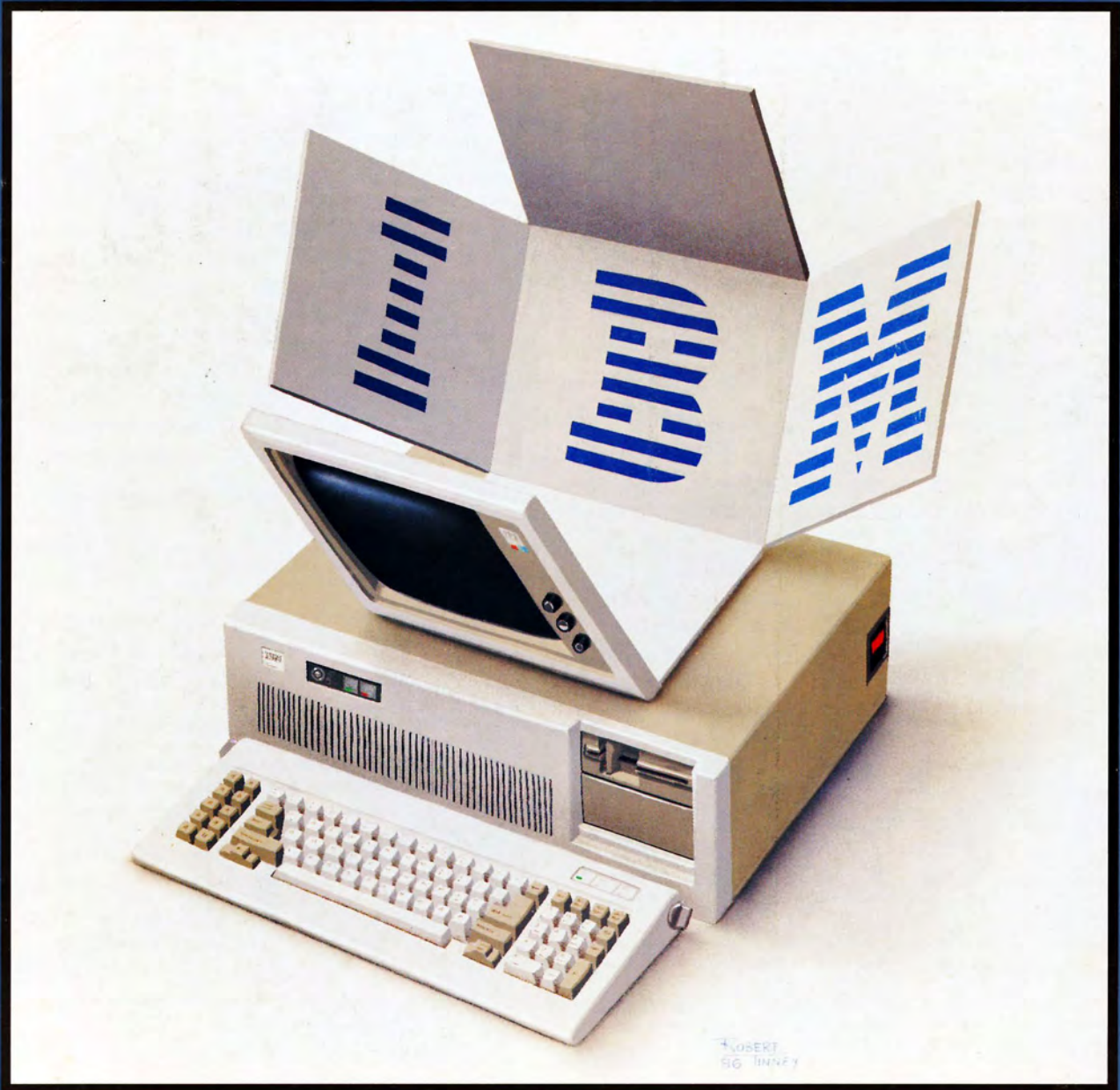

Third Annual Special Issue

EXTRA EDITION

BYTE

INSIDE THE IBM PCs

Volume 10, Number 11

Turbo GameWorks™

Also recently released, Turbo GameWorks is what you think it is: "Games" and "Works." Games you can play right away (like Chess, Bridge and Go-Moku), plus the Works—which is how computer games work. All the secrets and

strategies of game theory are there for you to learn. You can play the games "as is" or modify them any which way you want. Source code is included to let you do that, and whether you want to write your own games or simply play the off-the-shelf games, Turbo GameWorks will give hours of diversion, education, and intrigue. George Koltanowski, Dean of American Chess, and former President, United States Chess Federation, reacted to Turbo GameWorks like this, "With Turbo GameWorks, you're on your way to becoming a master chess player," and Kit Woolsey, writer, author, and twice Champion of the Blue Ribbon Pairs, wrote, "Now play the world's most popular card game—Bridge . . . even program your own bidding or scoring conventions." Suggested retail: \$69.95.



Turbo Graphix Toolbox™

It includes a library of graphics routines for Turbo Pascal programs. Lets even beginning programmers create high-resolution graphics with an IBM, Hercules,™ or compatible graphics adapter. Our Turbo Graphix Toolbox includes all the tools you'll ever need for complex business graphics, easy windowing, and storing screen images to memory. It comes complete with source code, ready to compile. Suggested retail: \$69.95.



Recognition for Borland International has come from business, trade, and media, and includes both product awards and awards for technical excellence and marketing. Borland was named "Company of the Year" by PC Magazine; Sidekick, the #1 best seller for the IBM PC, was named "Product of the Year" by InfoWorld; Turbo Pascal was selected one of PC Week's Top 10 Products for 1984; SuperKey won one of PC Magazine's "Best of 1985" awards; Rellex, The Analyst was recognized in the "Software Products of the Year" awards by InfoWorld; and Rellex and SideKick were both nominated for British Micro Awards in 1986.



Turbo Database Toolbox™

A perfect complement to Turbo Pascal, because it contains a complete library of Pascal procedures that allows you to search and sort data and build powerful database applications. Having Turbo Database Toolbox means you don't have to reinvent the wheel each time you write a Turbo Pascal program. It comes with source code for a free sample database—right on disk. The database can be searched by keywords or numbers. Update, add, or delete records as needed. Just compile it and it's ready to go to work for you. Suggested retail: \$69.95.



Technical Specifications:

TURBO PASCAL 3.0 Minimum memory: 128K; includes 8087 and BCD features for 16-bit MS-DOS and CP/M-86 systems. CP/M-80 version minimum memory: 48K; 8087 and BCD features not available

TURBO DATABASE TOOLBOX Minimum memory: 128K. CP/M-80 minimum memory: 48K. Requires Turbo Pascal 2.0 or later.

TURBO GRAPHIX TOOLBOX* Minimum memory: 192K. Requires PC/MS-DOS 2.0 or later, Turbo Pascal 3.0, and IBM CGA, Hercules Monochrome Card or equivalent.

TURBO TUTOR 2.0 Minimum memory: 192K. CP/M-80 version minimum memory 48K. Requires PC/MS-DOS 2.0 or later and Turbo Pascal 3.0.

TURBO EDITOR TOOLBOX* Minimum memory: 192K. Requires PC/MS-DOS 2.0 or later and Turbo Pascal 3.0.

TURBO GAMEWORKS* Minimum memory: 192K. Requires PC/MS-DOS 2.0 or later and Turbo Pascal 3.0.

TURBO PROLOG* Minimum memory: 384K.

REFLEX: THE ANALYST* Minimum memory: 384K. Requires IBM CGA, Hercules Monochrome Card or equivalent. Works with Intel's AboveBoard-PC and -AT; AST's RAMpage! and RAMpage! AT; Quadram's Liberty-PC and -AT; Tecmar's 640 Plus; IBM's EGA and 3270/PC; AT&T's 6300 and many others.

REFLEX WORKSHOP* Minimum memory: 384K. Requires Rellex: The Analyst. Two disk drives or hard disk recommended.

TURBO LIGHTNING* Minimum memory: 256K. Two disk drives required. Hard disk recommended.

LIGHTNING WIZARD* Minimum memory: 256K. Requires Turbo Lightning, Turbo Pascal 3.0 required to edit source code.

SIDEKICK* Minimum memory: 128K.

TRAVELING SIDEKICK* Minimum memory: 256K.

SUPERKEY* Minimum memory: 128K.

*For IBM PC, AT, XT, PCjr and true compatibles only, running PC/MS-DOS 2.0 or later.

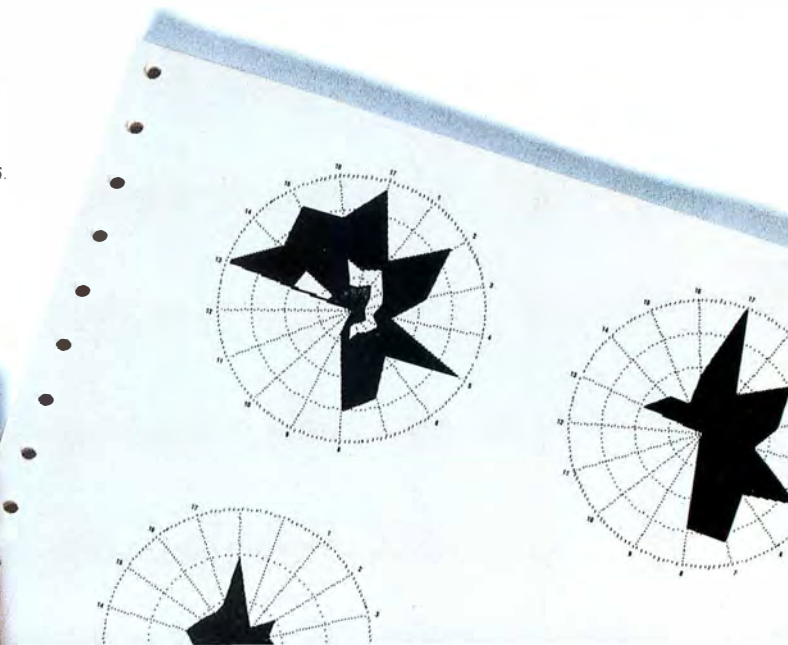



COMPLETELY
NEW VERSION!

Turbo Tutor® 2.0



Just released (July '86), the new Turbo Tutor can take you from "What's a computer?" on through to complex data structures, assembly languages, trees, tips on writing long programs in Turbo Pascal, and a high level of expertise. Source code for everything is included. New split screens allow you to put source text in the bottom half of the screen and run the examples in the top half. There are quizzes that ask you, show you, tell you, teach you. You get a 450-page manual—which is not as daunting as it sounds, because unlike many software manuals, it was not written by orangutans. (With our all "almost-free" upgrade, you can upgrade to Turbo Tutor 2.0 by sending us your master diskettes, proof of purchase, and \$10.00, which covers shipping and handling.) Suggested retail: \$39.95.

NEW SPECIAL!

Turbo Pascal® 3.0



"For the IBM PC, the benchmark Pascal compiler is undoubtedly Borland International's Turbo Pascal," says Gary Ray of PC Week. We and more than 500,000 other people around the world think Mr. Ray got that right.

Since launch, Turbo Pascal has become the *de facto* worldwide standard in high-speed Pascal compilers. Described by Jeff Duntemann of PC Magazine as the "Language deal of the century," Turbo Pascal is now an even better deal than that—because we've included the most popular options (BCD reals and 8087 support). What used to cost \$124.95 is now only \$99.95! You now get a lot more for a lot less: the compiler, a completely integrated programming environment, and BCD reals and 8087 support—all for a suggested retail of only \$99.95.

Borland's Business Productivity Programs:

Reflex: The Analyst™ Analytical database manager. Provides complete new look at data normally hidden by programs like 1-2-3™ and dBASE™. Best report generator for 1-2-3.

NEW! Reflex Workshop™ Important new addition to Reflex: The Analyst. Gives you 22 different templates to run your business right.

SideKick™ Complete RAM-resident desktop management includes notepad, dialer, calculator and more.

Traveling SideKick™ Electronic version of business/personal diaries, daytime organizers; works with your SideKick files; important professional tool.

SuperKey™ Keyboard enhancer. Simple macros turn 1000 keystrokes into 1. Also encrypts your files to keep confidential files confidential.

Borland's Electronic Reference Programs:

Turbo Lightning™ Works with all your programs and checks your spelling while you type! Includes 80,000-word Random House™ Concise Dictionary and 50,000-word Random House Thesaurus. Forerunner of Turbo Lightning Library.

Lightning Word Wizard™ Includes ingenious crossword solver and six other word challenges. If you're into programming, Lightning Word Wizard is also a development toolbox and the technical reference manual for Turbo Lightning.

Turbo Editor Toolbox™



Recently released, we called our new Turbo Editor Toolbox a "construction set to write your own word processor." Peter Feldmann of PC Magazine covered it pretty well with, "A 'write your own word processor'

program for intermediate level programmers, with lots of help in the form of prewritten procedures covering everything from word wrap to pull-down windows."

Source code is included, and we also include MicroStar, a full-blown text editor with pull-down menus and windowing. It interfaces directly with Turbo Lightning



to let you spell-check your MicroStar files. Jerry Pournelle of BYTE magazine said, "The new Turbo Editor Toolbox is the Turbo Pascal source code to just about anything you ever wanted a PC-compatible text editor to do." Suggested retail: \$69.95.





We frequently surprise people with inventive, imaginative software, and people frequently surprise us with the way they use it.

For example, you'll read on this page how Michael J. Watkins of the Petroleum Technology Center in Houston, Texas,

used Turbo Pascal® (and Turbo Graphix Toolbox™ and Turbo Tutor®) to cut down the tedium and time in creating Circular Performance Profile Charts (CPPCs).

We didn't know they existed, but you learn something new every day!

Applications like CPPCs might not fit your exact needs, but at the same time they might stimulate fresh ideas in your mind about how you can put Turbo Pascal and the Turbo Pascal family to work for you.

And thank you for your interest in and support for Borland International.

Philippe Kahn,
President, Borland International

Turbo Pascal deliberately programmed to go around in circles

Circular charts (or CPPCs) are used by Michael J. Watkins of the Petroleum Technology Center in Houston, Texas, to plot a single performance property for a large number of elastomers, which have elastic, rubber-like properties.

Mr. Watkins wrote us saying, "Because CPPCs condense a lot of data in one graphic, they can be very tedious and time-consuming to draw."

What he did to solve those problems was to write a Turbo Pascal program for IBM® personal computers to "generate these charts quickly and easily."

He used Turbo Pascal "because it has a companion set of very powerful graphics programs (Turbo Graphix Toolbox) which greatly simplifies the required programming."

Turbo Pascal is not a difficult language to use and can be easily learned by persons who can program in FORTRAN or BASIC. An excellent tutorial (Turbo Tutor) is available for the novice or experienced programmer. The Turbo Pascal products are also very moderately priced.



*"The computer is no better than its program."
Elting Morison, author of "Men, Machines and Modern Times"*

INSIDE STORIES!

- Turbo Pascal 3.0, already described by *PC Magazine* as "Language deal of the century," is now an even better deal than that, because we've included the most popular options (BCD reals and 8087 support). What used to cost \$124.95 is now only \$99.95!
- Completely new Turbo Tutor 2.0 now available. New software. New manual. New split screens. New quizzes. Only \$39.95. Upgrades available under Borland's "Almost-Free" upgrade plan. Details inside.

LATE NEWS!

- June/July Special Artificial Intelligence Issue of *The Micro Technical Journal* says, "Turbo Prolog looks like it's going to be a winner, for both the beginner and professional programmer."

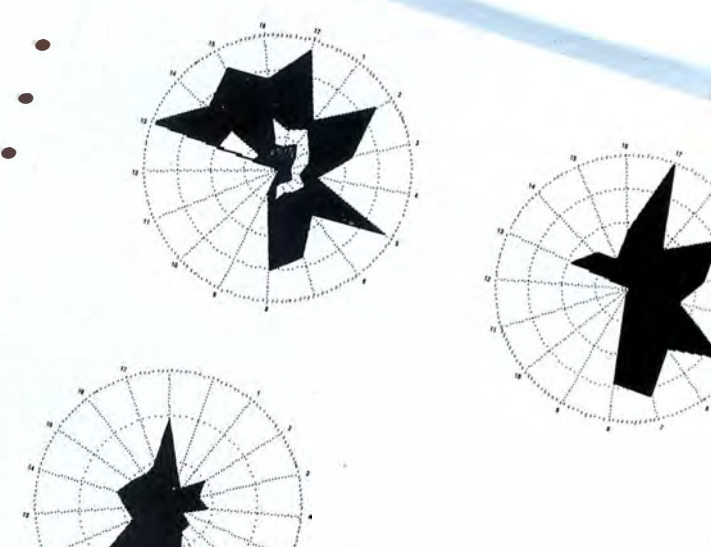

Step-by-step tutorial, demo programs with source code included!

Borland's new Turbo Prolog is the powerful, completely natural introduction to Artificial Intelligence

Prolog is probably one of the most powerful computer programming languages ever conceived, which is why we've made it our *second language*—and "turbo-charged" it to create Turbo Prolog."

Our new Turbo Prolog, the natural language of **Artificial Intelligence**, brings supercomputer power to your IBM® PC and introduces you step-by-step to the fascinating new world of **Artificial Intelligence**. And does all this for an astounding \$99.95.

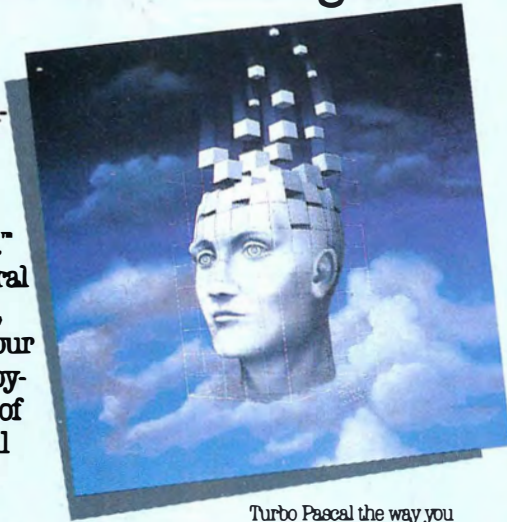

Turbo Prolog is to Prolog what Turbo Pascal® is to Pascal!

Our Turbo Pascal astonished everyone who thought of Pascal as "just another language." We changed all that—and now Turbo Pascal is the de facto worldwide standard, with hundreds of thousands of enthusiasts and users in universities, research centers, schools, and with professional programmers, students, and hobbyists.

You can expect at least the same impact from Turbo Prolog, because while Turbo Prolog is the most revolutionary and natural programming language, it is also a complete development environment—just like Turbo Pascal.

Minimum memory: 384K

"Turbo Prolog offers generally the fastest and most approachable implementation of Prolog.

*Darryl Rubin,
AI Expert*

Even if you've never programmed before, our free tutorial will get you started right away

You'll get started right away because we have included a complete step-by-step tutorial as part of the 300-page Turbo Prolog Reference Manual. Our tutorial will take you by the hand and teach you everything you're likely to need to know about Turbo Prolog and artificial intelligence.

For example: once you've completed the tutorial, you'll be able to design your own expert systems utilizing Turbo Prolog's powerful problem-solving capabilities.

Think of Turbo Prolog as a high-speed electronic detective. First you feed it information and teach it rules. Then Turbo Prolog "thinks" the problem through and comes up with all the reasonable answers—almost instantly.

If you think that this is amazing, you just need to remember that Turbo Prolog is a 5th-generation language—and the kind of language that 21st century computers will use routinely. In fact, you can compare Turbo Prolog to

Turbo Pascal the way you could compare Turbo Pascal to machine language.

You get the complete Turbo Prolog programming system for only \$99.95

You get a complete Turbo Prolog development system including:

- The lightning-fast Turbo Prolog incremental compiler and the interactive Turbo Prolog editor.
- The 300-page reference manual which includes the step-by-step Turbo Prolog tutorial.
- The free GeoBase™ natural query language database including commented source code on disk—ready to compile. GeoBase is a complete database designed and developed around U.S. geography. It includes cities, mountains, rivers, and highways, and comes complete with natural query language. Use GeoBase immediately "as is," or modify it to fit your own interests.

So don't delay—don't waste a second—get Turbo Prolog now. \$99.95 is an amazingly small price to pay to become an immediate authority—an instant expert on artificial intelligence! The 21st century is only one phone call away.

YES!

I want the best!

For credit card orders or the dealer nearest you
call (800) 255-8008
in CA call (800) 742-1133

Copies	Product	Price	Totals
___	Turbo Prolog	\$99.95	\$ _____
___	Reflex: The Analyst	149.95*	\$ _____
___	Reflex Workshop	69.95*	\$ _____
___	Reflex, Reflex Workshop	199.95*	\$ _____
___	Turbo Pascal 3.0 w/8087 & BCD	99.95	\$ _____
___	Turbo Pascal for CP/M-80	69.95	\$ _____
___	Turbo Database Toolbox	69.95	\$ _____
___	Turbo Graphics Toolbox	69.95	\$ _____
___	Turbo Tutor 2.0	39.95	\$ _____
___	Turbo Editor Toolbox	69.95	\$ _____
___	Turbo GameWorks	69.95	\$ _____
___	Turbo Lightning	99.95	\$ _____
___	Lightning Word Wizard	69.95	\$ _____
___	Turbo Lightning, Lightning Word Wizard	149.95	\$ _____
___	SideKick	64.95	\$ _____
___	Traveling SideKick	69.95*	\$ _____
___	SideKick, Traveling SideKick	125.00*	\$ _____
___	SuperKey	69.95	\$ _____
___	Outside USA add \$10 per copy		\$ _____
___	CA and MA res. add sales tax		\$ _____
___	Amount enclosed		\$ _____

Prices include shipping to all US cities.

Carefully describe your computer system:

Mine is: ___ 8-bit ___ 16-bit

I use: ___ PC-DOS ___ CP/M-80 ___ MS-DOS ___ CP/M-86

My computer's name and model is: _____

The disk size I use is: 3 1/4" 5 1/4" 8"

Payment: VISA MC Money order Check

Credit card expiration date: _____ / _____

Card # _____

NOT COPY PROTECTED BG15
****60-DAY MONEY-BACK GUARANTEE**

Name: _____

Shipping Address: _____

City: _____

State: _____

Zip: _____

Telephone: _____

COOs and purchase orders WILL NOT be accepted by Borland. Outside USA make payment by bank draft, payable in US dollars drawn on a US bank.

*Limited Time Offer until September 1, 1986.

**YES, if within 60 days of purchase you find that this product does not perform in accordance with our claims, call our customer service department and we will gladly arrange a refund.

Prices subject to change without notice.

Turbo Prolog 1.0 Technical Specifications

C Compiler: Incremental compiler generating native in-line code and linkable object modules. The linking format includes a linker and is compatible with the PC-DOS linker. Large memory model support. Compiles over 2500 lines per minute on a standard IBM PC.

Interactive Editor: The system includes a powerful interactive text editor. If the compiler detects an error, the editor automatically positions the cursor appropriately in the source code. At run-time, Turbo Prolog programs can call the editor, and view the running program's source code.

Type System: A flexible object-oriented type system is supported.

Windowing Support: The system supports both graphic and text windows.

Input/Output: Full I/O facilities, including formatted I/O, streams, and random access files.

Numeric Ranges: Integers: -32767 to 32767; Reals: 1E-307 to 1E+308.

Debugging: Complete built-in trace debugging capabilities allowing single stepping of programs.



4585 SCOTTS VALLEY DRIVE
SCOTTS VALLEY, CA 95066
(408) 438-8400 TELEX: 172373

Vive la différence



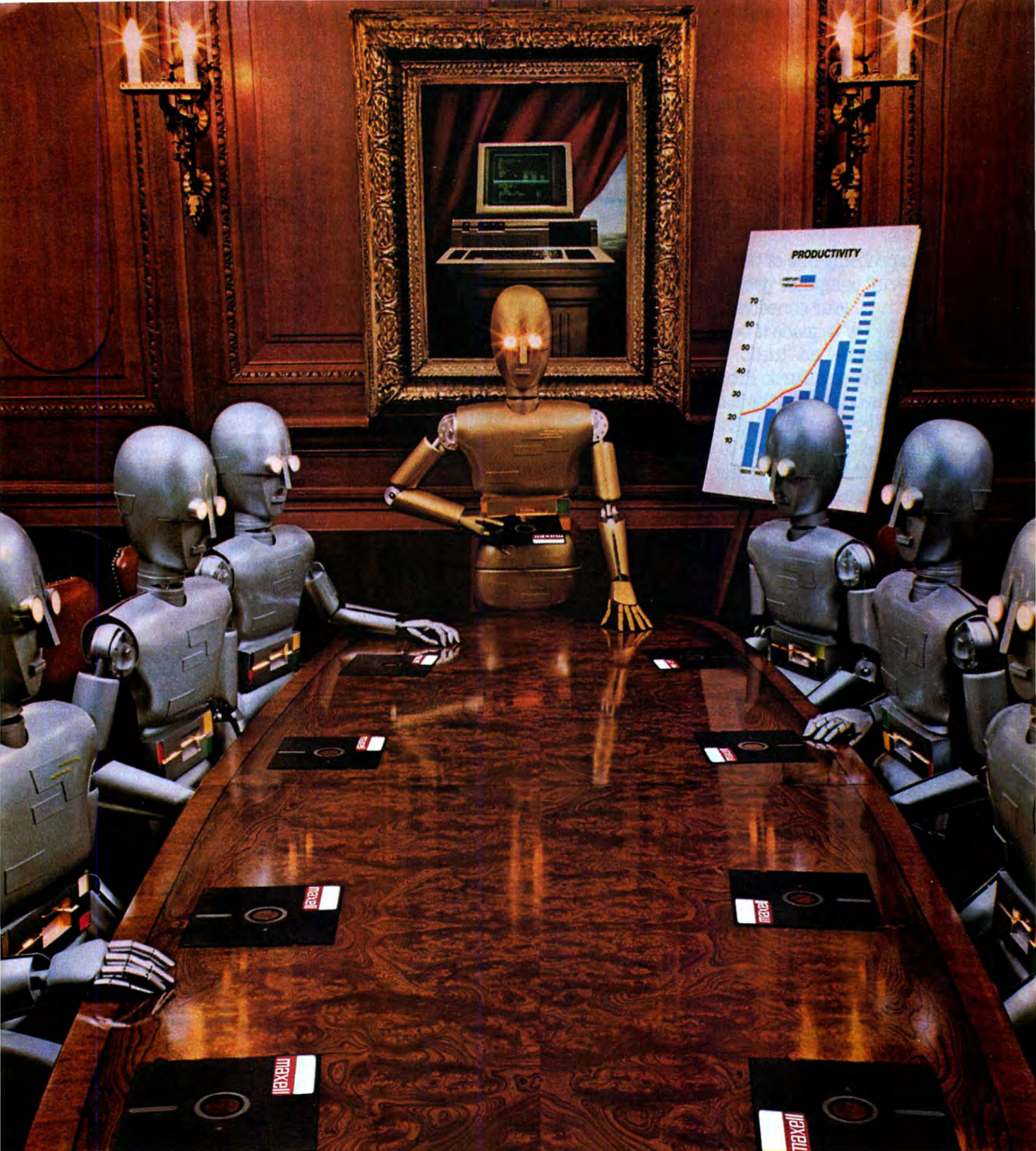

When computers get down to business, they move up to Maxell.

Maxell was first to provide you with a 5¼" high density floppy disk. Just another example of how we keep you a step ahead.



maxell
THE GOLD STANDARD

BYTE

Inside the IBM PCs

EDITORIAL: THE STRUGGLE FOR COMPATIBILITY *by G. Michael Vose*

6

WHAT'S NEW

11

BOOK REVIEWS

23

THE IBM RT PERSONAL COMPUTER *by Richard O. Simpson*

43

THE IBM PC CONVERTIBLE *by G. Michael Vose*

83

INTEL'S 80386 ARCHITECTURE *by Paul Wells*

89

VIRTUAL MEMORY, VIRTUAL MACHINES *by Jon Shiell*

110

A PROTECTED-MODE PROGRAM FOR THE PC AT *by Ross P. Nelson*

123

IBM PC ACCELERATORS *by Stephen S. Fried*

140

LOTUS/INTEL/MICROSOFT EXPANDED MEMORY *by Ray Duncan*

168

PERFORMANCE PROGRAMMING *by Joel Rosenblum and Dan Jacobs*

181

RAM-LOADABLE CHARACTER SETS FOR THE IBM PC *by Richard Wilton*

197

SPEEDING UP THE PC AT *by Brian K. Roemmele*

209

USING ASSEMBLY ROUTINES IN MS-FORTRAN PROGRAMS *by Mark Dahmke*

217

MEMORY MANIPULATIONS *by Alan R. Miller*

232

WRITING ASSEMBLY LANGUAGE INTERRUPT ROUTINES *by William J. Claff*

249

C VERSUS ASSEMBLY—C PLUS ASSEMBLY *by Tom Hogan*

267

BEST OF BIX

288

BYTE'S ONGOING MONITOR BOX

342

LISTINGS

FROM BIX PAGE 320

FROM BYTENET (617) 861-9764

ON DISK SEE INSERT CARD FOLLOWING PAGE 176

IN PRINT SEE INSERT CARD FOLLOWING PAGE 176

 BYTE (ISSN 0360-5280) is published monthly with one extra issue per year by McGraw-Hill Inc. Founder James H. McGraw (1860-1948). Executive, editorial, circulation, and advertising offices: One Phoenix Mill Lane, Peterborough, NH 03458, phone (603) 924-9281. Office hours: Mon-Thur 8:30 AM - 4:30 PM, Friday 8:30 AM - 1:00 PM, Eastern Time. Address subscriptions to BYTE Subscriptions, PO Box 590, Martinsville, NJ 08836. Postmaster: send address changes, USPS Form 3579, undeliverable copies, and fulfillment questions to BYTE Subscriptions, PO Box 596, Martinsville, NJ 08836. Second-class postage paid at Peterborough, NH 03458 and additional mailing offices. Postage paid at Winnipeg, Manitoba. Registration number 9321. Subscriptions are \$21 for one year, \$38 for two years, and \$55 for three years in the USA and its possessions. In Canada and Mexico, \$23 for one year, \$42 for two years, and \$61 for three years. \$69 for one year air delivery to Europe, 31,000 yen for one year air delivery to Japan, 15,600 yen for one year surface delivery to Japan, \$37 surface delivery elsewhere. Air delivery to selected areas at additional rates upon request. Single copy price is \$3.50 in the US and its possessions, \$4.25 in Canada and Mexico, \$4.50 in Europe, and \$5 elsewhere. Foreign subscriptions and sales should be remitted in U.S. funds drawn on a U.S. bank. Please allow six to eight weeks for delivery of first issue. Printed in the United States of America.

Address all editorial correspondence to the Editor, BYTE, One Phoenix Mill Lane, Peterborough, NH 03458. Unacceptable manuscripts will be returned if accompanied by sufficient first-class postage. Not responsible for lost manuscripts or photos. Opinions expressed by the authors are not necessarily those of BYTE. Copyright © 1985 by McGraw-Hill Inc. All rights reserved. Trademark registered in the United States Patent and Trademark Office. Where necessary, permission is granted by the copyright owner for libraries and others registered with the Copyright Clearance Center (CCC) to photocopy any article herein for the flat fee of \$1.50 per copy of the article or any part thereof. Correspondence and payment should be sent directly to the CCC, 29 Congress St., Salem, MA 01970. Specify ISSN 0360-5280/83 \$1.50. Copying done for other than personal or internal reference use without the permission of McGraw-Hill Inc. is prohibited. Requests for special permission or bulk orders should be addressed to the publisher, BYTE is available in microform from University Microfilms International, 300 North Zeeb Rd., Dept. PR, Ann Arbor, MI 48106 or 18 Bedford Row, Dept. PR, London WC1R 4EJ England.

Subscription questions or problems should be addressed to: BYTE Subscriber Service, P.O. Box 328, Hancock, NH 03449

MANAGING EDITOR, BYTE
FREDERIC S. LANGA**ASSISTANT MANAGING EDITOR**

GLENN HARTWIG

CONSULTING EDITORS

STEVE CIARCIA

JERRY POURNELLE

EZRA SHAPIRO

BRUCE WEBSTER

SENIOR TECHNICAL EDITORSJON R. EDWARDS, *Reviews*G. MICHAEL VOSE, *Themes*GREGG WILLIAMS, *Features***TECHNICAL EDITORS**

DENNIS ALLEN

RICHARD GREHAN

KEN SHELDON

GEORGE A. STEWART

JANE MORRILL TAZELAAR

TOM THOMPSON

CHARLES D. WESTON

EVA WHITE

STANLEY WSZOLA

ASSOCIATE TECHNICAL EDITORSCURTIS FRANKLIN, JR., *Best of BIX*MARGARET COOK GURNEY, *Book Reviews*BRENDA McLAUGHLIN, *Applications Software Reviews*,
San Francisco**COPY EDITORS**BUD SADLER, *Chief*

JEFF EDMONDS

FAITH HANSON

NANCY HAYES

CATHY KINGERY

PAULA NOONAN

WARREN WILLIAMSON

JUDY WINKLER

ASSISTANTSPEGGY DUNHAM, *Office Manager*

MARTHA HICKS

L. RYAN McCOMBS

JUNE N. SHELDON

NEWS AND TECHNOLOGYGENE SMARTE, *Bureau Chief, Costa Mesa*JONATHAN ERICKSON, *Senior Technical Editor, San Francisco*RICH MALLOY, *Senior Technical Editor, New York*CINDY KIDDOO, *Editorial Assistant, San Francisco***ASSOCIATE NEWS EDITORS**DENNIS BARKER, *Microbytes*CATHRYN BASKIN, *What's New*ANNE FISCHER LENT, *What's New***CONTRIBUTING EDITORS**JONATHAN AMSTERDAM, *programming projects*MARK DAHMKE, *video, operating systems*MARK HAAS, *at large*RIK JADRNICKEK, *CAD, graphics, spreadsheets*ROBERT T. KUROSAKA, *mathematical recreations*PHIL LOPICCOLO, *computers in medicine*ALASTAIR J. W. MAYER, *software*ALAN R. MILLER, *languages and engineering*DICK POUNTAIN, *U.K.*ROGER POWELL, *computers and music*WILLIAM M. RAIKE, *Japan*PHILLIP ROBINSON, *semiconductors***ART**NANCY RICE, *Art Director*JOSEPH A. GALLAGHER, *Associate Art Director*JAN MULLER, *Art Assistant*ALAN EASTON, *Drafting***PRODUCTION**DAVID R. ANDERSON, *Production Director*

DENISE CHARTRAND

MICHAEL J. LONSKY

VIRGINIA REARDON

TYPOGRAPHYSHERRY MCCARTHY, *Chief Typographer*

LEN LORETTE

DONNA SWEENEY

EXECUTIVE EDITOR, BIX

GEORGE BOND

SENIOR EDITOR

DAVID BETZ

ASSOCIATE EDITORS

TONY LOCKWOOD

DONNA OSGOOD, *San Francisco***MICROBYTES DAILY**DENNIS BARKER, *Coordinator, Peterborough*GENE SMARTE, *Bureau Chief, Costa Mesa*CATHRYN BASKIN, *Peterborough*JON ERICKSON, *San Francisco*MARTHA HICKS, *Peterborough*CINDY KIDDOO, *San Francisco*ANNE FISCHER LENT, *Peterborough*RICH MALLOY, *New York*LYNNE NADEAU, *Peterborough*DAVID NEEDLE, *San Francisco*WAYNE RASH, *Washington, DC***GROUP MODERATORS**DAVID ALLEN, *Applications*FRANK BOOSMAN, *Artificial Intelligence*LEROY CASTERLINE, *Other*MARC GREENFIELD, *Programming Languages*JIM HOWARD, *Graphics*GARY KENDALL, *Operating Systems*STEVE KRENEK, *Computers*BROCK MEEKS, *Telecommunications*BARRY NANCE, *New Technology*DONALD OSGOOD, *Computers*SUE ROSENBERG, *Other*JON SWANSON, *Chips***BUSINESS AND MARKETING**DOUG WEBSTER, *Director, (603) 924-9027*PATRICIA BAUSUM, *Secretary*DENISE A. GREENE, *Customer Service*BRIAN WARNOCK, *Customer Service*TAMMY BURGESS, *Customer Credit and Billing***TECHNOLOGY**CLAYTON LISLE, *Director, Business Systems Technology, MHIS*BILL GARRISON, *Business Systems Analyst*JACK REILLY, *Business Systems Analyst*LINDA WOLFF, *Senior Business Systems Analyst***ADVERTISING SALES**DENNIS I. RILEY, *Director of Sales and Marketing*SANDRA FOSTER, *Administrative Assistant***ADVERTISING/PRODUCTION (603-924-6448)**LISA WOZMAK, *Supervisor*LYDA CLARK, *Senior Account Coordinator*

MARION CARLSON

KAREN CILLEY

WAI CHIU LI, *Quality Control Manager*JULIE MURPHREE, *Advertising/Production Coordinator***MARKETING COMMUNICATIONS**HORACE T. HOWLAND, *Director (603-924-3424)*VICKI REYNOLDS, *Promotion Manager*LISA JO STEINER, *Marketing Assistant*STEPHANIE WARNESKY, *Marketing Art Director*SHARON PRICE, *Associate Art Director*WILBUR S. WATSON, *Operations Manager, Exhibits***RESEARCH**JULIE PERRON, *Market Research Analyst*CYNTHIA DAMATO SANDS, *Reader Service Coordinator***PLANNING AND DEVELOPMENT/PUBLIC RELATIONS**

(603-924-7255)

MICHELE P. VERVILLE, *Director*FAITH KLUNTZ, *Copyrights Coordinator***FINANCIAL SERVICES**PHILIP L. PENNY, *Director of Finance and Services*KENNETH A. KING, *Business Director*CHRISTINE LEE, *Assistant*VICKI WESTON, *Accounting Manager*LINDA SHORT, *D/P Manager*

MARILYN HAIGH

DIANE HENRY

VERN ROCKWELL

LISA TEATES

JOANN WALTER

PUBLISHER'S ASSISTANT

BEVERLY JACKSON

CIRCULATION (800-258-5485)LAURIE SEAMANS, *Assistant Manager*

SUSAN BOYD

LOUISE MENEGUS

AGNES E. PERRY

JENNIFER PRICE

JAMES BINGHAM, *Single-Copy Sales Manager*CATHY A. RUTHERFORD, *Assistant Manager*

CLAUDETTE CARSWELL

KAREN DESROCHES

PERSONNELCHERYL HURD, *Office Manager*PATRICIA BURKE, *Personnel Coordinator***BUILDING SERVICES/TRAFFIC**ANTHONY BENNETT, *Building Services Manager*

BRIAN HIGGINS

MARK MONKTON

RECEPTIONIST

DONNA HEALY



Officers of McGraw-Hill Information Systems Company: President: Richard B. Miller, Executive Vice Presidents: Frederick P. Jannott, Construction Information Group; Russell C. White, Computers and Communications Information Group; J. Thomas Ryan, Marketing and International, Senior Vice Presidents: Francis A. Shinal, Controller; Robert C. Violette, Manufacturing and Technology, Senior Vice Presidents and Publishers: Laurence Altman, Electronics Week, Harry L. Brown, BYTE; David I. McGrath, Construction Publications, Group Vice President; Peter B. McCuen, Communications Information, Vice President; Fred O. Jensen, Planning and Development.

Officers of McGraw-Hill, Inc.: Harold W. McGraw, Jr., Chairman; Joseph L. Dionne, President and Chief Executive Officer; Robert N. Landes, Executive Vice President and Secretary; Walter D. Serwatka, Executive Vice President and Chief Financial Officer; Shel F. Asen, Senior Vice President, Manufacturing; Robert J. Bahash, Senior Vice President, Finance and Manufacturing; Ralph R. Schulz, Senior Vice President, Editorial; George R. Elsinger, Vice President, Circulation; Ralph I. Webb, Vice President and Treasurer.

BYTE, BITE, and The Small Systems Journal are registered trademarks of McGraw-Hill Inc.

EDITORIAL AND BUSINESS OFFICE: One Phoenix Mill Lane, Peterborough, New Hampshire 03458, (603) 924-9281.

West Coast Offices: 425 Battery St., San Francisco, CA 94111, (415) 954-9718; 3001 Red Hill Ave., Building #1, Suite 222, Costa Mesa, CA 92626, (714) 557-6292. **New York Editorial Office:** 1221 Avenue of the Americas, New York, NY 10020, (212) 512-2000.

BYTEnet: (617) 861-9764 (set modem at 8-I-N or 7-I-E: 300 or 1200 baud).

Life's Tough Decisions.



THE CHOICES.

Remember when your biggest problem was no storage space in your wagon? No room for your boats, trains, cars, and planes. Your choice was to either get rid of some toys or get a bigger wagon.

Now your wagon has turned into an IBM PC-XT. Your boats, trains, and cars are now database, spreadsheet, and word processing files. But your choice for more storage is still about the same: either get rid of some "toys" or get a bigger "wagon."

GETTING A BIGGER WAGON.

Since every bit counts, you can now upgrade your computer with a CORE 43 MB half height drive and still give yourself room to grow. IBM's standard XT contains only a 10 or 20 MB full height drive, which filled up faster than you thought it would. Your PC-XT may even accommodate 2 CORE drives. That's 86 MB and a floppy all inside the box.

IBM PC-XT and IBM PC-AT are registered trademarks of International Business Machines, Inc.

A SIMPLE TRANSITION.

Installation is easy. Everything is supplied for you to install in less than 30 minutes. Have a drive already? Simply remove the old and slide in the new.

SHIFT INTO HIGH GEAR.

Our half height drives are the fastest in the world. With an average access time of less than 26 ms, these drives are 4-5 times faster than the standard XT (and more than 30% faster than an IBM PC-AT). Load, save, sort, and retrieve data in record time. Plus, they're one half the size! Ideal for networks and file servers, and they support both DOS and XENIX.



7171 N. Federal Hwy. Boca Raton, FL 33431
(305) 997-6055
Telex: 315 809 CORE INTL DEBE

Vectra is a registered trademark of Hewlett Packard.

Inquiry 76

NEVER GET STRANDED.

Our read/write heads unconditionally and automatically go to a safe landing zone and lock there on power off. Unlike the factory issue XT drive (and most others), our drives protect you from head crashes and lost data. They'll never leave you crying.

They're also fully shock mounted for your XT or even a portable computer.

THE ROAD TO SUCCESS.

CORE International is the world's largest supplier of high performance IBM PC-AT compatible drives. This high performance is now available in a half form factor for other compatibles including HP Vectra, Zenith, AT&T, and the entire Compaq line. All drives are backed by a one-year warranty in addition to a choice of on-site, local, or exchange maintenance services supported by CORE and other major maintenance companies.

Contact us directly or see your local CORE Authorized Dealer for details.

XENIX is a trademark of Microsoft, Inc.

THE STRUGGLE FOR COMPATIBILITY

The IBM Personal Computer, introduced in the fall of 1981, celebrates its fifth birthday this year. With the flattery quotient nearing 1.00, the folks in Boca Raton should be proud of their progeny as the homes and offices of customers around the world slowly fill with imitation PCs. 1986 is proving to be the Year of the Clone.

What makes building clones so easy? Why can anybody who feels like it put together a clone, rent a mailbox, and rake in a pile of cash?

The key to clone building is the use of standard parts and the availability of crucial system software, like Phoenix Technology's IBM PC-compatible BIOS and Microsoft's MS-DOS. While there are subtle incompatibilities from clone to clone, there are usually enough similarities from machine to machine to make most clones perform acceptably as copies of the PC. This is particularly true for application software written to make DOS and BIOS calls instead of directly addressing a machine's hardware.

Compatibility with the IBM PC has been a contraposition for IBM. Wide availability of machines that can all run the same software has prompted the creation of thousands of programs. The availability of this software has assured the sale of machines that will run all these great programs. IBM's problem has been that other companies can provide this now-standard computer more cheaply than IBM.

So the IBM PC created an archetype around which a flourishing industry has sprouted. Could this industry-building scenario work in reverse?

TOWARD A 32-BIT BUS STANDARD

This past spring, a group of hardware and software makers got together to

talk about creating a bus standard for extending the IBM PC AT's 16-bit bus to 32 bits. The extra 16 bits would accommodate the Intel 80386 microprocessor as the engine for new computers and peripheral devices designed to work with the new 32-bit bus. The name chosen for this new bus is Personal Computer Extended Technology (PCET).

The PCET bus makes possible the construction of personal computers and peripheral devices based on the Intel 80386 processor in the absence of a standard 80386 machine from IBM. Many people speculate that IBM will either be late with an 80386-based machine or build an 80386 machine that uses a proprietary operating system (or maybe both). In any case, the PCET bus circumvents IBM by establishing a standard bus around which other manufacturers can build 80386 machines. A half dozen 80386 machines using the PCET bus would establish a standard that might survive, regardless of actions taken by IBM.

Since the PCET bus is an extension of the PC AT bus, machines built around this bus could use existing graphics and memory-expansion cards and existing versions of MS-DOS—and thousands of existing application programs. The PCET bus provides a painless way to build "turbo" ATs—machines that function like an AT but at two to three times the speed.

Once an existing base of turbo ATs develops, software houses can create new operating systems—or adapt existing ones like UNIX—to tap the potential of the 80386. Hardware companies can build graphics and memory boards for a new class of workstations that are based on the 80386.

Thus, a whole new genre of clones

can be built, using standard, off-the-shelf parts along with adapted BIOS software and existing operating system and application programs. These new clones will actually predate the machine they are designed to replace! It seems that the personal computer world may take on an odd, ironic tilt.

PCET-bus-based machines may survive as a group only if IBM's 80386 machine is *not* an open-architecture machine. Tandy is gambling that IBM will make an 80386 machine that can be cloned. If this turns out to be the case, any company selling a PCET-bus computer should get in touch with an auctioneer.

The obvious question arises about whether or not people really need turbo ATs. Only 13 percent of the owners of IBM computers require the power of an AT. Maybe only 13 percent of AT owners will benefit from the power of a turbo AT. Even if this were the case, that would still create a niche for approximately 40,000 80386-based computers. But another problem is the issue of affordability. Is using an 80386 in a single-user machine a waste of hardware resources? Is it cost-effective?

Modifications are already available for Apple's Macintosh that permit the use of an MC68020 processor and MC68881 math coprocessor and the addition of up to 4 megabytes of RAM. These modifications, when coupled with a 1K- by 1K-pixel monitor, transform a Mac into a high-performance workstation. But the cost is high—\$7000 to \$9000.

Building similarly equipped turbo ATs may turn out to be just as expensive. At that price, buyers who need a full-fledged workstation (in contrast to the folks who want to run Lotus 1-2-3 faster) might look at Sun, Apollo,

(continued)

INCOMPARABLY COMPATIBLE

3.5" FLOPPY DRIVE FOR YOUR PC OR COMPATIBLE

Get 720K of Storage NOW
On all DOS 2.0 and above.

MANZANA produces a full line of 3.5" disk drive systems:

- Host-powered external drives
- Self-powered external drives
- Internal drives

All MANZANA systems come with 3FIVE™, our sophisticated but easy-to-use software package which allows you to read and write to most 3.5" formats including:

IBM PC Convertible, Toshiba T1100 & T3100, Zenith Z-181, Atari ST, DG/One, GridCase, Kaypro 2000, HP 110 & 150, Tandy 600, Datavue 23 & 24, Apricot, Sony M35 & SMC-2000

Most of our systems support popular copy programs facilitating transfer between 3.5" and 5 1/4" disks.



MANZANA . . . the Industry
Pioneer in 3.5" Peripherals

CALL OR WRITE FOR MORE
INFORMATION. In Canada, contact
Quay Computer Corp. at (416) 890-2041.
In U.K., call Systems Constructors at
0202-297315.

Come see us at Comdex/Fall
Booth 734 at the Bally Grand



MANZANA™
MicroSystems, Inc.

P.O. Box 2117
Goleta, CA 93118
(805) 968-1387

1-2-3 faster) might look to Sun, Apollo, DEC, or IBM's RT PC for more stable hardware and software.

The one application area that can potentially benefit most from 80386 performance is graphics. Intel's new microprocessor can permit the creation of workstations with a great deal of graphics power. But the trend in graphics processing is to offload graphics to its own processor, either custom-built, as in the Amiga, or off-the-shelf parts, like the Texas Instruments TMS34010. There is also the problem of the 16-bit EGA standard and how it can be adapted to a 32-bit environment.

TECHNOLOGY DRIVEN

Regardless of the *need* for 80386-based machines, technology has a way of evolving for its own sake. People need to find out what is possible, whether it be with airplanes or computers.

Therefore, the PCET-bus specification effort makes sense from a research and development point of view. It establishes a common starting ground for machine designs using a new processor.

The PCET-bus design goals seek to provide a high-speed bus for 32-bit memory and memory-mapped data transactions. The bus also needs to be flexible enough to permit 32-bit coprocessor cards to become alternate bus masters.

The PCET bus pipelines address and control information, making this information for a subsequent bus cycle available in the latter stages of the current bus cycle. The bus design calls for a default to two wait states but can be operated with one or no wait states by activating additional control signals.

Compatibility with the existing 16-bit PC AT bus is a must for the PCET bus to take advantage of existing graphics and memory standards. (An interesting outgrowth of the PCET-bus specification effort is that the committee first had to codify the AT bus.) A mix of 16- and 32-bit bus masters can drive the PCET bus to accommodate refresh, direct memory

access, and other tasks.

The memory map for the PCET bus shows the entire 4-gigabyte address space of the 80386 as being available to the bus, except the 640K-byte to 1-megabyte area reserved for ROM and video devices.

Mechanically, the PCET bus extends the data lines of the PC AT bus by 40 pins. The data lines on the RT PC bus, already 40 pins instead of 36 as in the AT, also get another 40 pins.

We still need to ask some legitimate questions about the PCET bus. Is it possible to achieve nearly the same 80386 performance on a 16-bit bus feeding a 32-bit cache? Since 85 percent of all CPU operations are read operations, caching operands may allow an 80386 to operate almost as fast with a 16-bit bus as it would with a 32-bit bus for some applications.

Another question about a 32-bit standard bus: What if companies ignore it and create their own bus? There have been widespread reports of 80386-machine projects at Compaq and Zenith that will feature proprietary 32-bit bus designs. The PCET bus, no matter how elegant its design, will fade away like the dodo if everyone ignores it.

ANOTHER ROUND

Regardless of the creation of the PCET bus, there will be new machines built around the 80386. The early machines will be expensive and will have no software to fully exploit their power. They may serve as a bridge from the current PC world to a future 80386-machine-based environment. These new machines will undoubtedly raise a different set of compatibility problems with the machines and software that preceded them.

But we'll buy them anyway.

—G. Michael Vose
Senior Technical Editor

Look for IBM-related conferences and special events on BIX starting in late October. Current plans call for a special event on "System Software for the 80386," plus conferences on the RT PC and the PC Convertible.

**SATELLITE
MODULES
NOW \$99**



The Most Powerful LAN Fits on a Disk.

Network Power. You knew that someday there would be a powerful LAN that didn't need old-technology network boards. It would be fast, easy to install, and run 99% of PC-DOS software. It would be expandable, provide remote access, password-protection, and enable you to use inexpensive terminals as workstations in a PC-DOS environment.

Dream no more, because the power is here.

Its name is LANLink™

A Software-Driven LAN Powerful Enough To Use RS-232 Ports for Network Communications. In development for over three years, LANLink™ represents the next generation of local area networks. All of the logic which has traditionally resided on network boards is on LANLink's Satellite and Server Diskettes.

No additional hardware is required. Inexpensive serial ports replace "Kilobuck" Network Interface Boards making installation costs one-third that of a board-driven network.

How To Configure a Smart Network...With Dumb Terminals, But Without Dedicated Servers. Boasting a wide variety of configurations, LANLink™ is most often set up as a "Star" having up to eight satellites connected to a central, nondedicated server. Larger networks can have multiple servers, supporting a total of 73 or more network users.

R-LAN™ (Remote-LAN) gives users the ability to interact with a LANLink™ network in real time via modem. Plus, if MultiLink Advanced™ is run on a Satellite, inexpensive dumb terminals can be used to access network disks, files, and programs.

THE SOFTWARE LINK, INC./CANADA 250 Cochrane Drive, Suite 12
Markham, Ontario L3R 6B7 CALL: 416/477-5480

LANLink™ MultiLink Advanced™ & R-LAN™ are trademarks of
The Software Link, Inc.

IBM, PC, & PC-DOS are trademarks of IBM Corp. WordStar 2000,
dBASE III, and Lotus 1-2-3 are trademarks of MicroPro, Ashton-
Tate, and Lotus Development Corp., respectively.

99% of PC-DOS Applications Run in a Totally-Transparent Network Environment. If you know DOS, you already know how to use LANLink™ COPY transfers files among users, and a 2-drive PC Satellite boots 1-2-3 from the Server's hard disk with the entry c:\lotus. Each satellite's access can be limited to specific disks, printers, and sub-directories. A wide variety of software including Lotus 1-2-3, dBASE III, and WordStar 2000 is fully compatible. LANLink™ has a collision-free data transfer rate which exceeds 115,000 BPS.

Power Up Your PCs Today. For complete details and the authorized dealer nearest you, call The Software Link TODAY. The LANLink™ Starter Kit is \$495 and includes modules for both a Server and a Satellite. For a limited time, 50 feet of shielded RS-232 cable will be included free of charge. Additional Satellite Modules are only \$195, each.

LANLink™ is immediately available and comes with a money-back guarantee. VISA, MC, AMEX accepted.

LANLink™



THE SOFTWARE LINK, INC.
Developers of LANLink™ and MultiLink Advanced™

8601 Dunwoody Place, Suite 632, Atlanta, GA 30338 Telex 4996147 SWLINK

CALL: 404/998-0700

Dealer Inquiries Invited



USE THE BRAINS YOUR IBM WASN'T BORN WITH.

Right at your fingertips in CompuServe's IBM® Forums.

In the **IBM New Users Forum** you'll swap ideas with other new PC users, learn to use Forum features, and pose even basic questions to PC experts.

Our **IBM Junior Forum** gives PCjr® users a reliable source for tips on software, hardware, telecommunications, games and other interests.

In the **IBM Software Forum** you'll trade tips with other IBM PC and AT users on utility software, word processing, DOS and other operating systems.

Visit the **IBM Communications Forum** for advice on the features and compatibility of communications software and hardware, PC Bulletin Boards, micro-mainframe interfaces and more.

The **IBM Hardware Forum** addresses hardware topics of all types, plus product updates and announcements.

Easy access to free software.

- Download first-rate, non-commercial, user-supported software and utility programs.
- Take advantage of CompuServe's inexpensive weeknight and weekend rates (when Forums are most active, and standard online charges are just 10¢ a minute).
- Go online in most major metropolitan areas with a local phone call.
- And receive a **\$25.00 Introductory Usage Credit** with purchase of your CompuServe Subscription Kit.

Information you simply can't find anywhere else.

Use the Forum *Message Board* to send and receive electronic messages, and pose specific questions to other IBM and compatible owners.

Join ongoing, real-time discussions in a Forum *Conference*.

Search our unparalleled Forum *Data Libraries* for free software, user tips, transcripts of online conferences and more.

Enjoy other useful services like:

- **Popular Computer Magazines**—electronic

editions, for your reading pleasure. Including Dr. Dobb's Journal and Computer Language.

- **Other CompuServe Forums**—supporting LOTUS® products like Symphony™ and 1-2-3.™ Borland International®, Ashton-Tate®, Digital Research®, MicroPro®, Microsoft® and other software. Also Pascal, Basic, C, Forth, Assembly and other programming languages.

All you need is your IBM or IBM-compatible computer and a modem ...or almost any other computer.

To buy your Subscription Kit, see your nearest computer dealer. Suggested retail price is \$39.95. To receive our free brochure, or to order direct, call 800-848-8199 (in Ohio, call 614-457-0802). If you're already a CompuServe subscriber, type GO IBMNET (the IBM Users Network) at any ! prompt to see what you've been missing.

CompuServe®

Information Services, P.O. Box 20212
5000 Arlington Centre Blvd., Columbus, Ohio 43220

800-848-8199

In Ohio, Call 614-457-0802

An H&R Block Company

Inquiry 66

IBM Introduces 80286-based XT

IBM's latest version of its PC XT, the Model 286, is based on an 80286 processor running at 6 MHz with no wait states and features more memory than earlier models of the XT and up to three internal drives.

Priced at \$3995, the Model 286 comes standard with 640K bytes of memory that can be expanded to 12.6 megabytes, a half-height 1.2-megabyte 5¼-inch floppy disk drive, a 20-megabyte hard disk drive, and a serial/parallel adapter. The machine has eight expansion slots, five of which can accommodate 16-bit boards. Internal storage options include a 3½-inch 720K-byte floppy disk drive (\$190), a second 5¼-inch floppy drive with a capacity of 1.2 megabytes (\$275), and a 5¼-inch floppy drive that can handle 360K bytes (\$225). The Model 286 also supports IBM's external 3½-inch floppy disk drive.

The computer uses a number of custom gate arrays to reduce chip count and board space requirements. Some of the chips are SIP (single in-line package), arranged vertically on the motherboard, thus further reducing the space requirements of the motherboard. The Model 286 has the same footprint as the IBM PC and XT.

According to the company, the machine's 80286 operates in real address mode for compatibility with the 8088 and in protected vir-



IBM's PC XT Model 286 runs on a 6-MHz 80286.

tual mode, which supports multitasking and enables the processor to address up to 16 megabytes of real memory and 1 gigabyte of virtual memory. The computer requires DOS version 3.2 or XENIX version 2.0.

The older 6-MHz PC AT will be phased out, the company says, but IBM will continue to sell the 8-MHz version of the AT. Contact IBM Corp., Information Systems Group, 900 King St., Rye Brook, NY 10573, (914) 934-4488.

Inquiry 550.

AT&T's 32-bit Digital Signal Processor

AT&T has developed the WE DSP32, a 32-bit single-chip digital signal processor with floating-point

capabilities. Applications for the chip include communications functions such as filtering, adaptive equalization, and echo canceling. The device can also be used for speech and image processing, as well as graphics simulation.

The chip has a clock rate of 16 MHz and executes its instruction cycle in 250 nanoseconds, or 8 million floating-point operations per second. On-chip memory consists of 2K bytes of ROM and 4K of RAM.

Software and hardware development tools that operate under MS-DOS and UNIX System V are available for use with the chip. A Support Software Library includes a high-level "C-like" syntax assembler and a simulator. A single-board development system permits real-time testing, debugging, and evaluation of hardware and software.

Sample OEM quantities of

the WE DSP32 chip cost \$175. Contact AT&T Technology Systems, 555 Union Blvd., Dept. 50AL203140, Allentown, PA 18103, (800) 372-2447.

Inquiry 551.

Object-oriented Programming Language

Actor is an object-oriented language that makes use of the Microsoft Windows interface. Because it's interactive, you can experiment at the keyboard with your programming ideas and watch the results.

The environment includes a workspace for communicating with the interpreter, a browser, an error manager, a window-based debugger, and a save facility. You can send messages to any object in the system to check status, change parameters, or learn about inherited behavior. A concurrent garbage collector is designed to free you from memory management duties. Actor contains classes that support list processing, pattern matching, parsing, and predicate logic.

The package sells for \$495 and comes with source code (except for the assembly language kernel), tutorial, reference manual, and demo program. Contact The White-water Group Inc., 906 University Place, Evanston, IL 60201, (312) 491-2370.

Inquiry 552.

(continued)

Two Removable-Cartridge Systems

Sysgen introduced the DuraPak, an internal storage subsystem with removable hard disk cartridges for IBM PCs, XT's, AT's, and compatibles. A single-drive, 15-megabyte DuraPak system sells for \$1295, which includes a controller and installation hardware. A dual-drive, 30-megabyte DuraPak sells for \$2095.

Each removable cartridge has a 15-megabyte capacity and measures 4¼ inches by 4¾ inches. For more information, contact Sysgen Inc., 47853 Warm Springs Blvd., Fremont, CA 94539, (415) 490-6770. **Inquiry 553.**

Data Technology's subsystem features 5¼-inch removable cartridges that can store 10 megabytes of data. The drive's average access time is 75 milliseconds, and its data transfer rate is 275K bytes per second. The cartridges consist of a flexible disk encased in a hard disk cartridge.

A single half-height subsystem retails for \$1195; a dual configuration sells for \$1995. The disks cost about \$39 each. For more information, contact Data Technology Corp., 2775 Northwestern Parkway, Santa Clara, CA 95051, (408) 496-0434. **Inquiry 554.**

System for Visual Artists

Time Arts, producers of the Lumena software for visual arts, has released another graphics package. EVA (Environment for Visual Art), based on a 512K-byte PC AT, combines raster and

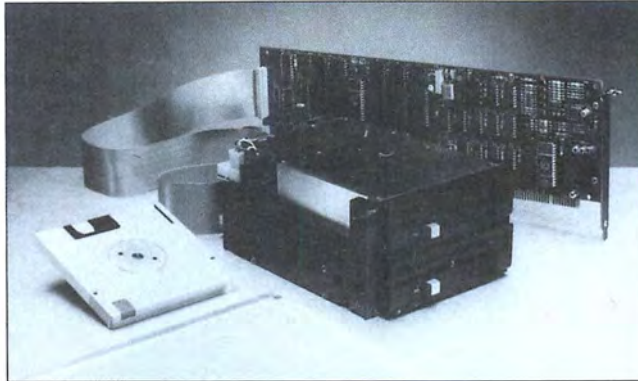

Sysgen's DuraPak uses 15-megabyte removable cartridges.

vector display technology and uses 32,000 on-screen colors. You can use the program to digitize images and then manipulate them with the AT. Time Arts says its package can also duplicate many of the video and film effects produced by more expensive systems.

With the digitizing tablet and pen, you have a selection of electronic brushes, colors, typefaces, and such capabilities as masking, automatic edge smoothing, texture rendering, and instant full-color tinting.

EVA uses two monitors: color for working with images, monochrome for keeping track of tools and system status. Images you develop on the 512 by 512 RGB screen can be increased to 2048 by 4096 resolution for direct transfer to a digital film recorder. With appropriate output devices, the system can also make its own color separations. 35mm slides, transparencies, video frames, tape sequences, and ink-jet, dot-matrix, and laser prints. Images can also be sent directly to Scitex graphics systems.

Pricing depends on output requirements, but the company says a complete sys-

tem can cost \$15,000. For more information, contact Time Arts Inc., P.O. Box 6476, 3436 Mendocino Ave., Santa Rosa, CA 95406-0476, (707) 576-7722. **Inquiry 555.**

3-D Engineering and Animation on PC AT

Renaissance Graphics unveiled real-time three-dimensional solid-modeling and animation add-on boards for the IBM PC AT. The Renaissance Graphics System (RGS) boards allow for fully animated 3-D shaded objects at a resolution of 512 by 512 pixels, 256 simultaneous colors from a palette of 16.8 million, and flicker-free 60-Hz display on the PC AT.

The system includes three 68000 microprocessors operating at 12.5 MHz, a 68881 math coprocessor, and two video frame buffers. The boards also have a TI 34061 video controller and a 192K-byte ROM with firmware routines. Among the system's capabilities are hidden line and surface removal, flat or smooth shading, selectable light source, and anti-aliasing. Its z-axis clipping, infinite zoom, and roam enable the viewer to travel around in 3-D space, going behind or inside moving objects.

The RGS is designed for

use with a high-resolution analog RGB monitor and will be bundled with a 3-D paint system. Standard NTSC, PAL, and SECAM video signals that can be genlocked (synchronized) to an external video source, along with film and slide recording, are also planned and will require additional hardware.

PC AT-based workstations using RGS boards will cost under \$20,000 and, according to the company, will run five times faster than competing systems costing \$60,000 or more. The recommended system includes an IBM PC AT with a 40-megabyte hard disk, high-resolution analog RGB monitor, and graphics tablet. The RGS cards, which are slated to be available in early 1987, occupy three slots in the PC AT. Contact Renaissance Graphics Inc., 1050 Walnut, Suite 325, Boulder, CO 80302, (303) 443-0191. **Inquiry 556.**

CP/M on IBM PCs

Micro Solutions' UniDOS software lets IBM PCs and compatibles run 8-bit CP/M programs without additional hardware. The package emulates a Z80 microprocessor and provides an environment compatible with CP/M 2.2. You can run a CP/M program from DOS by typing its name. The two types of programs can reside on the same disk.

UniDOS retails for \$69.95.

Contact Micro Solutions Inc., Software Division, 125 South Fourth St., DeKalb, IL 60115, (815) 756-3411. **Inquiry 557.**

(continued)

35mm Express™ business graphics software
FREE
Call 1-800-223-5231 for all details
California (213) 320-5700



Is the cost of presentation slides catching up with you?

Slides are a vital part of professional presentations. Unfortunately, the cost of having them prepared at slide houses is becoming prohibitive.

Bell & Howell has an alternative. We call it the Bell & Howell Color Digital Imager. It's a complete, in-house system that teams up with your PC to deliver professional quality slides quickly and confidentially. And because it's designed to work directly with Lotus 1-2-3®, WordStar®, and most popular business programs, there's no need to learn any new software.

But even more important, you can prepare slides inexpensively. In fact, compare us to slide houses and you'll find we can save you over 90% per slide. That means you can use slides in almost any presentation.

The Color Digital Imager includes software and film recorder. It lets you compose word slides, charts and graphs. Add a graphics tablet and you can draw free form graphics. And with an optional printer or plotter, you can even generate overhead transparencies or hard copies for pass-outs or leave behinds.

To find out how the Bell & Howell Color Digital Imager can put you way ahead of the game, write Bell & Howell, Quintar Division, 411 Amapola Ave., Torrance, California 90501. Or call (213) 320-5700. We'll send you sample slides, complete information and the name of your nearest dealer.



BELL + HOWELL

Inquiry 243

Seen at great presentations everywhere.

© 1985 Bell & Howell Company, Quintar Division. All rights reserved, 411 Amapola Ave., Torrance, California 90501 • Bell & Howell and Bell + Howell are trademarks of Bell & Howell Company. Lotus 1-2-3 is a registered trademark of Lotus Development Corp. WordStar is a registered trademark of MicroPro International Corp.

PC Convertible Add-ons

Alloy announced the StarBase subsystem, one of the first add-ons for the IBM PC Convertible. Priced at \$1995, StarBase-II is a combination 20-megabyte hard disk and 5¼-inch floppy drive with a parallel printer port. StarBase-III, a second model of the subsystem, also includes a 40-megabyte tape drive and sells for \$2495. Both units attach to the expansion connector on the rear of the computer. For more information, contact Alloy Computer Products Inc., 100 Pennsylvania Ave., Framingham, MA 01701, (617) 875-6100. **Inquiry 558.**

STB released a memory board, called the C-Ram 384, for the IBM PC Convertible. The C-Ram 384 plugs into a single slot and offers 384K bytes of CMOS RAM, expanding the portable's 256K base memory to 640K. The board connects directly to the IBM memory cards that come as standard equipment in the computer. The C-Ram 384 sells for \$495. Contact STB Systems Inc., 601 North Glenville, Suite 125, Richardson, TX 75081, (214) 234-8750. **Inquiry 559.**

Desktop Publisher

Studio Software has released a desktop publishing package called FrontPage for the IBM PC XT and AT. The program uses an icon-oriented display and comes with a font library and preformatted document layouts. Features include full hyphenation and justification, capability to mix type styles and sizes, and on-screen editing. You can import graphics files



The StarBase subsystem for the PC Convertible.

from spreadsheet, drafting, and drawing programs.

To use the software, you need at least 512K bytes of memory (640K is recommended), a math coprocessor, graphics card and monitor, and a laser printer (Apple LaserWriter, AST TurboLaser, HP Laserjet, or QMS PS 800). FrontPage has a suggested retail price of \$695. Contact Studio Software, 17862-C Fitch Ave., Irvine, CA 92714, (800) 821-7816; in California, (714) 474-0131.

Inquiry 560.

Five Graphics Modes on One Chip

NSI Logic announced a chip that emulates five graphics display adapters for the IBM PC. These include IBM's Monochrome Display Adapter (MDA), Color Graphics Adapter (CGA), Enhanced Graphics Adapter (EGA), and Professional Graphics Adapter (PGA), as well as the Hercules Graphics Card. Although several graphics boards are available that can emulate a variety of standards, the chip, called the EVC-315, is one of the first that features PGA emulation. In addition to these five modes, the chip supports a double-

scanning mode with a resolution of 640 by 400 pixels, which is compatible with software using the CGA's resolution of 640 by 200.

The EVC-315 chip also has a RAM-resident character generator that can store 256 characters (expandable to 512 or 1024 characters) with a maximum size of 32 by 8 pixels. It can drive monitors at bandwidths from 15.75 kHz to 38 kHz and, the company claims, it has a high graphics throughput.

Available to OEMs, the chip costs \$65 per unit in a minimum quantity of 10,000. Contact NSI Logic Inc., Cedar Hill Business Park, 257-B Cedar Hill Rd., Marlboro, MA 01752, (617) 460-0717.

Inquiry 561.

Internal CD-ROM Drive from Panasonic

Panasonic announced a half-height CD-ROM disk drive that fits internally in IBM PC-compatible computers. The Model SQ-DI drive can be installed in the computer's floppy or hard disk slot and can access up to 540 megabytes of data from a CD-ROM disk. With the addition of an SCSI port, a single computer can access as many as eight CD-ROM drives.

The drive provides a maximum access time of 650

milliseconds and a data transfer rate of 1 megabyte per second. The unit also has a built-in audio interface; the interface card for the IBM PC has a stereo port that can be connected to a standard stereo set.

The internal drive is priced at \$1495; an external standalone version (SQ-DI01) is also available and costs \$1795. Contact Panasonic Industrial Co., One Panasonic Way, Secaucus, NJ 07094, (201) 348-7000.

Inquiry 562.

LAN Tester

The Smart LAN Performance Test program is a standardized test package that enables users to compare LANs in a simulated working environment. Innovative Software says test results measure throughput as well as the productivity levels you can anticipate in actual usage. The menu-driven package can be used on any LAN operating system compatible with IBM NETBIOS and DOS CALL 3.1 or later.

The tester chooses the application to be run on each workstation and the level of usage. The application runs in a loop on each station until stopped by the tester. After each workstation is "busied out," the tester can have Smart LPT perform timed tests. Smart LPT can be run on a single PC to establish a baseline timing for comparison. Results can be printed in a bar chart or spreadsheet.

The Smart LPT costs \$49.95. Contact Innovative Software Inc., 9875 Widmer Rd., Lenexa, KS 66215, (800) 438-7627; in Kansas, (913) 492-3800.

Inquiry 563.

(continued)

Feast your eyes...

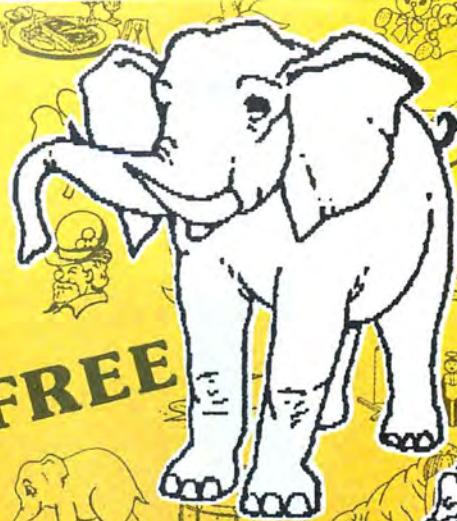

Introducing FONTASY[®] ART FOLDERS

Imagine using these eye-catching pictures in your own sales flyers, office signs, newsletters, and greeting cards. It's like having an in-house artist for just pennies a sketch.

You can select from hundreds of beautiful illustrations, drawn by professional artists and converted by camera to high-quality computer graphics. Most are the size of the four large pictures you see above (up to 2 by 4 inches on an IBM or Epson printer). We photo-reduced the rest to show you more of this incredible collection.

HOW IT WORKS

Each folder contains about 100 professionally-drawn pictures. To use ART FOLDERS you need FONTASY Version 2, an IBM PC, XT, AT or true compatible with 256K of memory (512-640 recommended for full page composition), an IBM or Hercules graphics board, and a dot matrix or HP LaserJet printer. Browse through ART FOLDER pictures, choose the ones you like, and make them bigger or smaller. Then, combine them with FONTASY's superb typefaces to produce stunning, custom visuals in minutes. For more information on FONTASY, please see back issues of this magazine or call us for a free catalog.

Inquiry 238

ART FOLDERS are available in these popular categories:
 #1 — Holiday #4 — Food
 #2 — Sports, Recreation, Music #5 — Animals & Plants
 #3 — Attention-Getters #6 — Home & Office

Each folder is just \$29.95, and unlike old-fashioned clip art, you can re-use these ART FOLDERS forever!
 To order FONTASY and ART FOLDERS, call now:

1-800-824-7888, operator 669 (orders only)

For further information and same day shipping, call: (818) 765-4444

PROSOFT.

7248 Bellaire Ave
 Box 560
 No. Hollywood, CA 91603-0560

1	2	3
4	5	6

ART FOLDER #'s
 \$29.95 each
 FONTASY \$69.95
 Ca. Sales Tax
 Shipping
 TOTAL

Name _____ Company _____
 Address _____ Telephone _____
 City, State, ZIP _____
 Visa/MC _____ Exp. Date _____
 Computer _____ Memory _____ Printer _____
 Terms: M/C, Visa, checks. Please add \$3.00 shipping and handling in U.S. or Canada, \$20.00 overseas, \$2.00 for C.O.D., and sales tax in Calif.



from the QINT/SQL database.

QINT/SQL needs 640K and a hard disk. Single-user price is \$995; multiuser versions start at \$1395.

QINT also sells a set of fifth-generation tools to work with QINT/SQL: QINT/TINA, a package that automates Nijssen's Information Analysis Methodology, a stepwise approach to data analysis based on semantic modeling concepts. TINA takes you through the necessary steps with a graphical interface and integrates and validates the components of the final Information Structure Diagram. TINA for micros is \$5000.

Contact QINT Database Systems Corp., 125 Roberts Rd., Waltham, MA 02154, (617) 891-3377. Inquiry 568.

Tandon Announces Line of PCs

After years of selling personal computers under other manufacturers' labels, Tandon has announced a line of computers that it will sell through retailers under its own label.

The XT-compatible models, called the PCX series, share the same capabilities and features as the IBM PC XT except that they include a parallel port as standard. A system with two floppy disk drives and 256K bytes of memory costs \$1295. A

14-inch amber monochrome monitor lists for \$190, and a display adapter card, which can display either text but no graphics on a monochrome display or color graphics on an RGB monitor, lists for \$90. A serial port costs about \$100.

The AT-compatible models, called the PCA series, are identical to the IBM PC AT except that they feature a dual-speed 80286 processor



The Transpac portable hard disk drive for IBM PCs.

that runs at 6 or 8 MHz with one wait state. In addition, the operating system for these models can access disk drives that are larger than 32 megabytes, the limit for most MS-DOS-based systems. The PCA with a 1.2-megabyte floppy and 512K bytes of memory costs \$2195, without a monitor. The PCA is also available with 20- and 40-megabyte hard disk drives for \$2695 and \$3595, respectively. Total system cost for a 20-megabyte unit with monitor and serial port is \$3075. For more information, contact Tandon Corp., 20320 Prairie St., Chatsworth, CA 91311, (818) 993-6644.

Inquiry 569.

WHERE DO NEW PRODUCT ITEMS COME FROM?

The new products listed in this section of BYTE are chosen from the thousands of press releases, letters, and telephone calls we receive each month from manufacturers, distributors, designers, and readers. The basic criteria for selection for publication are: (a) does a product match our readers' interests? and (b) is it new or is it simply a reintroduction of an old item? Because of the volume of submissions we must sort through every month, the items we publish are based on vendors' statements and are not individually verified. If you want your product to be considered for publication (at no charge), send full information about it, including its price and an address and telephone number where a reader can get further information, to New Products Editor, BYTE, One Phoenix Mill Lane, Peterborough, NH 03458.

Portable Hard Disk

The Transpac from Microcomputer Memories is a portable 3½-inch hard disk drive that connects via cable to IBM and compatible computers. The unit has its own controller and uses the computer's power supply. Its average access time is 65 milliseconds.

The drive weighs less than 3½ pounds and measures about 2½ by 4 by 6 inches. Prices are \$595 for a 10-megabyte model and \$895 for a 20-megabyte model. For more information, contact Microcomputer Memories Inc., 6855 Vine-land Ave., Chatsworth, CA 91605, (818) 700-8000. Inquiry 570.

Fiber-Optic Ethernet Connections

Codenoll Technology introduced two fiber-optic Ethernet connections for the IBM PC, XT, AT, and compatibles that operate at a rate of 10 megabits per second. According to the company, the use of fiber optics permits throughput five times greater than that of broadband systems and two and a half times greater than that of twisted-pair systems. The connections, each of which comes on a plug-in board, contain a 2000-meter fiber-optic Ethernet Transceiver.

The Codenet-3051 Fiber Optic Ethernet PC Connection is compatible with 3Com products and costs \$995. The Codenet-3061 Fiber Optic PC Network Adapter Card, which sells for \$1195, is compatible with Sytek products and IBM's NETBIOS. For more information, contact Codenoll Technology Corp., 1086 North Broadway, Yonkers, NY 10701, (914) 965-6300. Inquiry 571.

PC-based Protocol Analyzer

FELINE (Frederick Engineering's Dataline Monitor/Protocol Analyzer) is a general-purpose data communications protocol analyzer on a board that plugs into an IBM PC or compatible computer. Priced at \$1595, the board features multiple protocols, bit error rate testing, full-screen graphics presentation, and data analysis. FELINE comes with software, an RS-232C interface pod, and a carrying case. Contact Frederick Engineering Inc., 54 Cessna Court, Gaithersburg, MD 20879, (301) 926-6772. Inquiry 572.

LOOKING FOR THE BEST VALUE IN PC/AT COMPATIBLES?



INTRODUCING THE \$1495 A★STAR™

Looking for a lower priced, higher quality PC/AT compatible than our new A★Star™ is like looking for a needle in a haystack. You're more apt to come up with a case of hayfever.

A★Star gives you features you won't get from *any* other vendor. Not IBM. Not Compaq. Not even those foreign manufacturers. Features like a 220 watt power supply, eight *available* expansion slots and "network ready" multi-user operation. All for only \$1495. And that price includes a 1.2MB diskette drive, 512KB memory, a fixed disk/diskette drive controller, a tactile feedback keyboard (you'll love it!) and a 6/8MHz switch/software selectable 80286 CPU.

Best of all, A★Star is quality built right here in America by Wells American Corporation - an American Stock Exchange manufacturer. So now you

can buy with confidence from a vendor you can trust, just like you've trusted IBM. And you'll get a genuine, top quality product (not a cheap imitation) for a price even less than those "questionable" mail order clones. And if that's not enough, it's all money-back guaranteed!

The \$1495 Wells American A★Star.™



**A PC/AT FOR ONLY \$1495?
THAT'S NOTHING TO SNEEZE AT!**

(Hurry! This offer *is* limited.)

- I'm tired of sneezing! Have someone call me immediately to take my order.
- A★Star sounds terrific. Tell me more.

Name: _____

Company: _____

Phone: _____

Address: _____

City: _____

State: _____ Zip: _____



Wells American
303/796-7800 • TWX 510-601-2645
Jleveland • West Columbia, SC 29169

Two Megabytes of Memory for \$398

The Breakthru/PC, a plug-in board for IBM PCs and compatibles, provides 2 megabytes of memory and conforms to the Lotus/Intel/Microsoft Expanded Memory Specification. The board sells for \$398 with 2 megabytes of RAM or \$150 without RAM.

Bundled with the board are RAM disk and print spooler utilities, as well as diagnostic software and a setup program for changing the configuration of expanded memory. The company claims that the board performs bank switching 15 percent faster than Intel's Above Board and 25 percent faster than AST's RAM-page. Contact Vericomp, 8825 Aero Dr., Suite 210, San Diego, CA 92123, (619) 277-0400.

Inquiry 564.

Productivity Tool

Profit Technology announced Breakthrough!, a productivity package that has knowledge databases and idea stimulants.

The program is divided into three sections: Interface and Work, Thought Triggering and Amplification, and Tools and Utilities. In the Interface and Work section, the user can use eight different text-editing environments. The section includes a 220,000-word thesaurus. In the Thought Triggering and Amplification section, you can access a preprogrammed database, which includes menu selection, word triggers, and five flashing windows. The Tools and Utilities section includes a biorhythm generator, a program customizer, and a report generator.

ProView, the windowing/



A screen from Profit Technology's Breakthrough! package.

applications manager, is a clone of IBM's TopView and enables you to run 250 programs simultaneously through its multitasking capability.

Breakthrough! costs \$822 and requires an IBM PC, XT, AT, or compatible with 512K bytes of RAM, two floppy disk drives, a monochrome monitor, and PC-DOS or MS-DOS 2.0 or higher. Profit Technology recommends using an IBM EGA, a color monitor, and a hard disk. For more information, contact Profit Technology Inc., 39 Broadway, New York, NY 10006, (212) 809-3500.

Inquiry 565.

Hewlett-Packard's DraftPro Plotter

The DraftPro from Hewlett-Packard is an eight-pen plotter designed for PC-based computer-aided design. The plotter, which sells for \$5400, produces color output on architectural and engineering C- and D-size and metric A1- and A2-size paper, vellum, or film.

Compatible with most

computers, the DraftPro is supported by CAD packages such as AutoCAD and VersaCAD. It features a pen speed of 15 inches per second, a 0.001-inch addressable resolution, and 0.2 percent linear accuracy. The plotter's pen-sorting capability enables the device to draw a full buffer of vectors for one color before proceeding to another color, which reduces plot time.

An RS-232C interface and HP-GL support are standard; an HP-IB interface and Japanese kanji character set are available as options. For more information, contact Inquiries Manager, Hewlett-Packard Co., 1820 Embarcadero Rd., Palo Alto, CA 94303, (800) 367-4772. **Inquiry 566.**

Pop-up Outliner, Pop-up Calculator

Popular Programs has two new RAM-resident packages for IBM PCs and work-alikes: an outline processor and an equivalent of Hewlett-Packard's 12C calculator.

Pop-Up Partner, an idea/outline processor, is designed to help you organize

information as lists. It uses pull-down menus and comes with outlines that serve as desktop tools (e.g., a phone book, calendar, and expense tracker). The "paragraph" feature lets you write while in the middle of an outline; anything you've written in Partner can be copied in a word-processor or spreadsheet document with a couple of keystrokes.

Partner takes up 99K bytes. It sells for \$99.97.

Pop-Up PC-12C Calculator emulates HP's hand-held financial calculator and has the same programming features. It costs \$69.95.

Both Pop-Ups run on the IBM PC line under any version of DOS. For more information, contact Popular Programs Inc., 135 Lake St., Suite 180, Kirkland, WA 98033, (206) 822-7065.

Inquiry 567.

Relational Database Compatible with SQL

QINT/SQL, a relational database system compatible with IBM's Structured Query Language/Data System and Database 2, is designed primarily for users of PCs in an environment where SQL/DS or DB2 is installed on IBM mainframes. The package enables you to access and manipulate mainframe data from a PC and to prototype systems on the micro and then migrate them to the bigger machine.

With the QINT/Application Development Tool, you can build customized end-user applications that utilize a database. ADT can work on several sets of rows of a table simultaneously. Calculations and system values can be shown on the same screen as data retrieved

(continued)

Multiuser & LAN Solutions

For IBM PC/XT/AT

Now!



"We weren't using our PC/AT effectively until we connected Kimtron terminals."
Dr. Ed Generazio
NASA

MULTIUSER

KT-7/PC² PC Work-a-like Terminal
 Compatibility: Multilink Advanced³, PC-Slave/16⁴, PC-Slave¹²
 Display: 80 x 25, IBM PC character set, PC look-a-like attributes, 14" green or amber
 Keyboard: AT style std. IBM scan/ASCII codes. 5161/AT style opt.
 Pages of memory: 1 std. 2 or 4 opt.
 Communications: 2 bi-directional RS-232C serial (data & printer) ports
 Operating systems: works with PC-DOS¹, MS-DOS⁵, QNX⁶, UNIX⁷, XENIX⁵, THEOS⁸, PICK⁹, and Concurrent DOS¹⁰.
 Retail price: \$695.00
QUARTET² 4-port I/O card, RS-232C
 Retail price: \$299.00

LAN

K-Net² Local Area Network
 Software Compatibility: IBM's **NetBIOS¹**, Token-Ring¹, PC Network¹, Novell's Advanced Netware¹¹, Kimtron's K-Net²
 Access Method: CSMA/CD
 Topology: Distributed Bus
 Data Rate: 1 million bps (baseband)
 Cable: Twisted-pair/phone wire
 Distance: Up to 4000 ft.
 Addressable users: Up to 255
 Physical: Half-sized card
 Operating systems:
 PC-DOS¹/MS-DOS⁵ 2.0 or later
 Dedicated file server: **Not needed**
 Multiuser solutions supported:
 Multilink Advanced³, PC-Slave/16⁴, PC-Slave¹²
 Other features: message communication and print spooling
 Retail price: \$395.00

WORKSTATIONS

KW-1 8088, 4.77 MHz, 256 Kbytes
 Retail price: \$995.00
 KW-2 8088-2, 8 MHz, 256 Kbytes
 Retail price: \$1,195.00
 KW-3 80286, 6 or 8 MHz, 256 Kbytes
 Retail price: \$1,995.00
 All the above include: AT style keyboard, 8 slots, built-in K-Net² with remote boot. Upgradeable to "complete" PC. Monitors, video boards, additional memory, and other keyboard layouts are also available.
(800) 828-8899
(408) 436-6550 (In CA)
 1705 Junction Ct., Bldg. #160
 San Jose, California 95112



Trademarks: ¹IBM ²Kimtron ³Software Link ⁴Alloy ⁵Microsoft ⁶Quantum ⁷Bell Labs ⁸THEOS Software ⁹PICK Technologies ¹⁰Digital Research ¹¹Novell ¹²ADC
 © Copyright 1986 by Kimtron Corp.

Intel announce

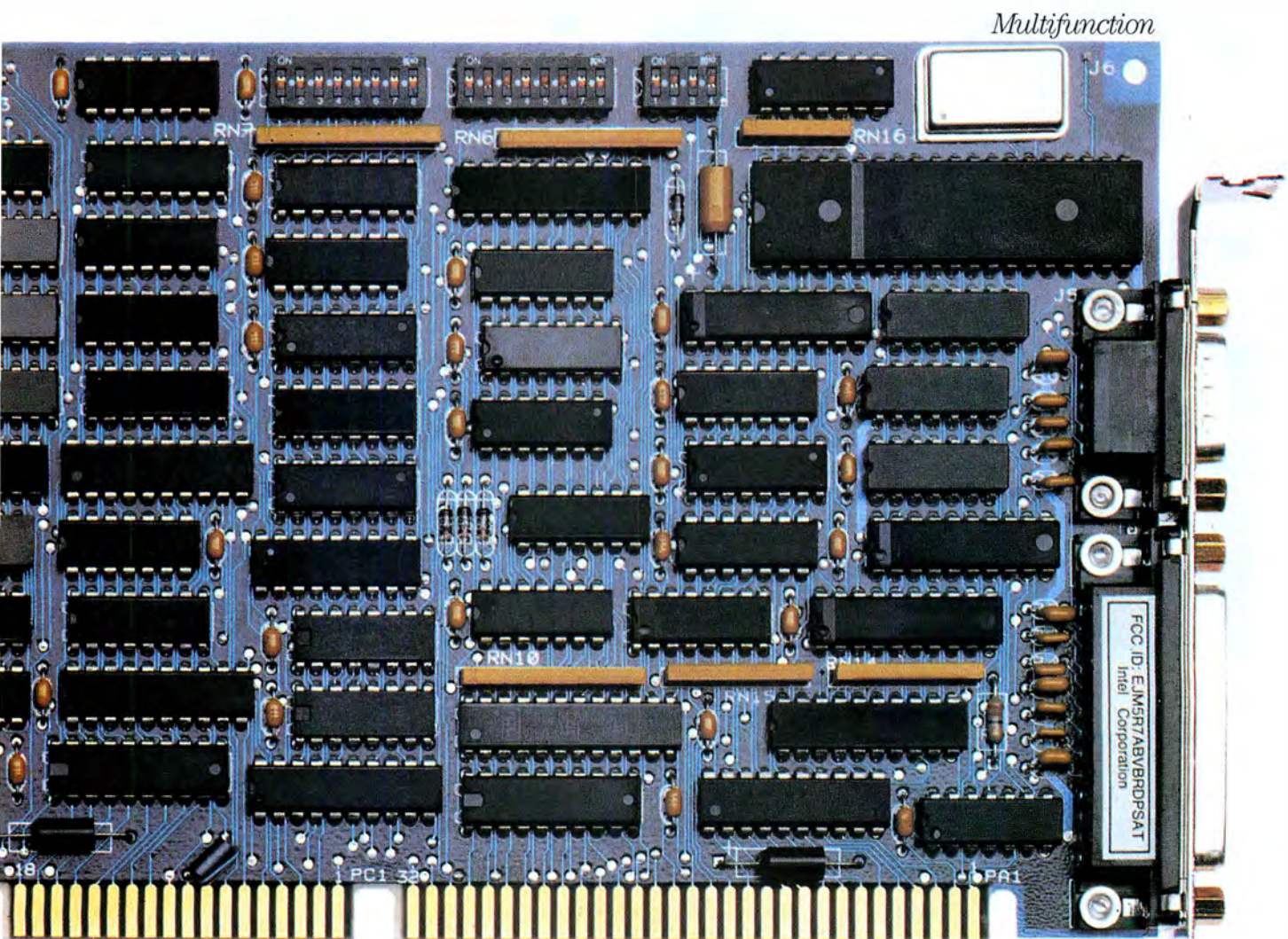

Look who's joined forces.
Expanded memory, and multifunction features for your AT.

Introducing Intel's Above™ Board PS/AT.

Like our Above Board /AT, PS/AT gives you expanded memory—which meets the Lotus®/Intel/Microsoft® spec, conventional memory—up to 640K, and extended memory—capable of supporting protected mode operating systems.

But unlike Above Board /AT, PS/AT gives you all that memory *plus* serial and parallel ports, print buffer, and RAM disk.

All packaged into a single slot. And all guaranteed to run at 8MHz.

PS/AT not only supplies all the memory you need, it's supported by some of the most popular software. Including 1-2-3®, Symphony™, Framework II™, SuperCalc®, Ready!,™ and Auto CAD™.

ces a merger.

Expanded Memory

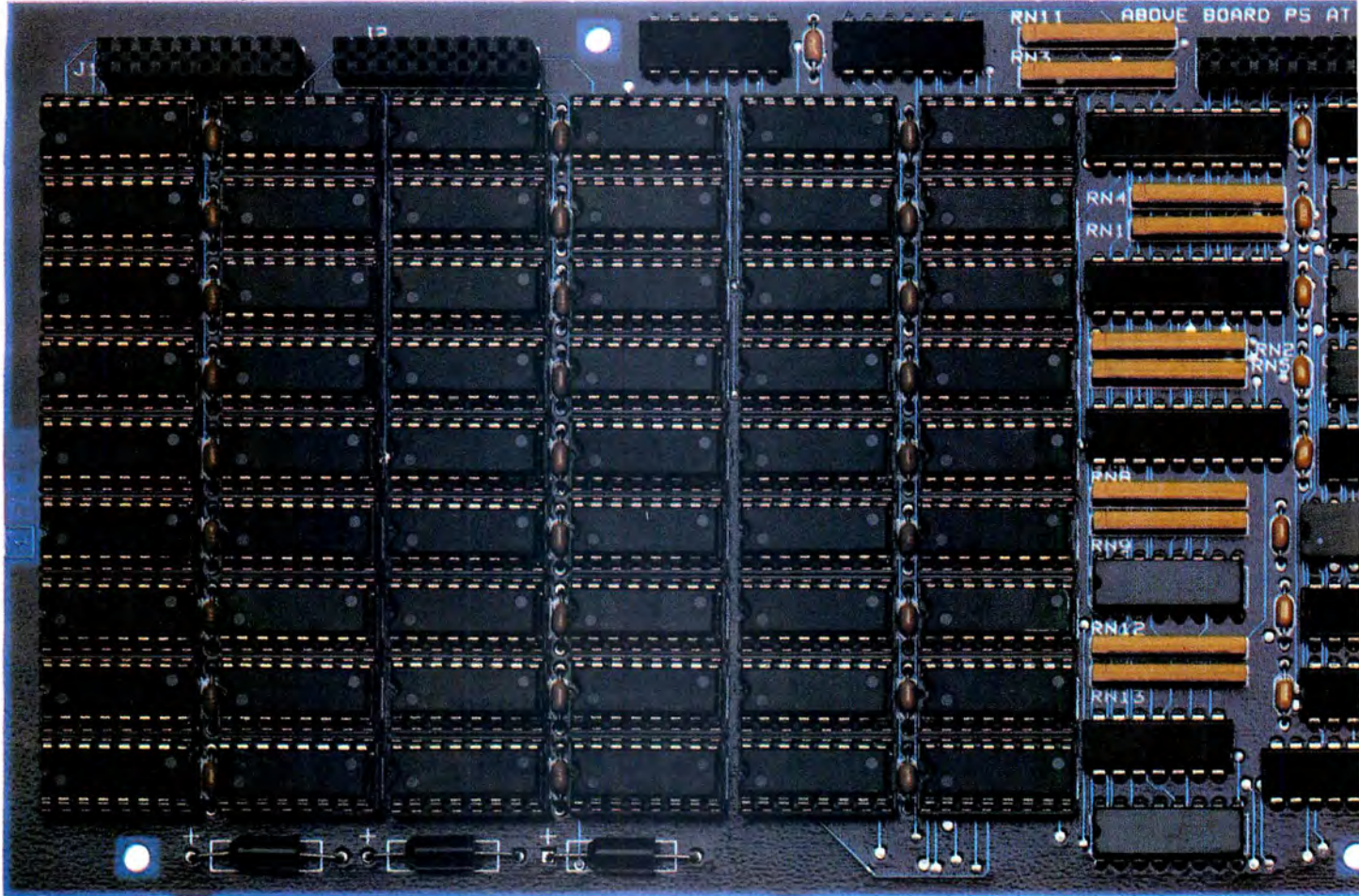

And it's supported by somebody else, too. Us. With a free hotline, 5-year warranty—just what you'd expect from the company who cast the standard in expanded memory.

And if you're still on the fence, try this on for size:

Buy an Above Board, and we'll throw in a special offer for a free copy of Microsoft® Windows.

Lotus is a registered trademark of Lotus Development Corporation. Microsoft is a registered trademark of Microsoft Corporation. 1-2-3 is a registered trademark of Lotus Development Corporation. Symphony is a trademark of Lotus Development Corporation. Framework II is a trademark of Ashton-Tate. SuperCalc is a registered trademark of Computer Associates International. Ready! is a trademark of Living Videotext, Inc. AutoCAD is a trademark of Autodesk, Inc. Above is a trademark and Intel a registered trademark of Intel Corporation. © 1986 Intel Corporation.

For details call (800) 538-3373. So buying an Above Board PS/AT not only means one less board to buy. For a short time, it also means one less software program to buy. Proof that it pays to consolidate.

intel®

VERSANET. VERY, VERY VERSATILE.



CTC SYSTEM'S VERSANET™ PRODUCT FAMILY ENABLES APPLICATIONS FROM MULTI-USER, MULTI-TASKING TO PC LAN NETWORKING AND GENERAL PURPOSE I/O CONTROL FOR IBM PC, XT AND AT.®

Our Versanet™ family of data communications products can fill your needs today and tomorrow. Versanet products support a large number of multi-user/multi-tasking operating systems including Concurrent PC DOS®, PC-DOS®, Xenix® and Unix®. They can let you port up to eight RS232C devices, or as few as four. They can deliver user-programmable on-board intelligence to free microprocessor resources. They can even increase RS232C device transmission distance up to 100% at any baud rate.

And our support of RS232C protocols is complete. For example, we provide TXD, RXD, DTR, DSR, CTS, RTS, RI and DCD. That means full modem handshaking and support of virtually all serial I/O devices.

The Versanet family was designed intelligently, too. Like requiring only 8 I/O addresses *per board* vs. the 8 *per port* other

boards require. Like using VLSI Technology to reduce cost and raise reliability. And like offering a hardware fingerprint mechanism to prevent software piracy and allow polling the number of Versanet boards in the chassis.

Versanet boards also come with a connector housing for easy interface to I/O devices external to the PC.

Best of all, these products are proven. We've been shipping for over a year to companies, as big as AT&T and as small as a dream.

Let Versanet products help make your dream. They're very, very versatile. For more information call (408) 725-0501. Or write CTC Systems Inc., 10311 S. De Anza Blvd., Suite 4, Cupertino, CA 95014.



CTC SYSTEMS, INC.

ADVANCED MS-DOS

Ray Duncan
 Microsoft Press
 Redmond, WA: 1986
 468 pages, \$22.95

**TECHNICAL TOPICS FOR THE IBM PC FAMILY
 OF MICROCOMPUTERS: An Annotated
 Bibliography of Recent Books**

ADVANCED MS-DOS

Reviewed by John D. Unger

If you are a programmer who needs to interface software and hardware with MS-DOS, *Advanced MS-DOS* by Ray Duncan will guide you. You can learn how to use MS-DOS interrupts and their associated functions so your application programs can do file I/O and write to the screen, or you can figure out how to access peripherals quickly and efficiently.

Given the title and subject matter of the book and its author's expertise, you might expect *Advanced MS-DOS* to be difficult to read, but that's not so. Duncan's informal style is carried over from his regular columns in *Dr. Dobbs' Journal of Software Tools*. The opening chapter on the history of MS-DOS, for instance, reads like a good biography. *Advanced MS-DOS* exemplifies how a highly technical book can be both informative and readable.

READER REQUIREMENTS

To benefit from this book, you should be able to understand the 8086 assembly language programs that are liberally sprinkled throughout the text as examples. If you have already worked through a good introductory book on 8086 assembly language programming—such as *Assembly Language Primer for the IBM PC & XT* by Robert Lafore (New American Library, 1984)—you will be able to launch yourself into a higher level of assembly language programming with *Advanced MS-DOS*.

Duncan uses C-language programs as examples to explain how to interface high-level programs with MS-DOS functions. But because he is basically an assembly language programmer, he emphasizes writing efficient assembly language code either as stand-alone programs or as functions or procedures to be linked to other high-level language programs. Many of the programs are useful not only as examples but also as the basis of a library of valuable MS-DOS utility and programming tools.

Unless you enjoy typing in endless lines of source code and then searching for syntax errors and other self-induced bugs, you may want to take advantage of the companion disk to *Advanced MS-DOS*. This disk contains the assembly and C-language source code for all the example programs described in the book. Also included are ready-to-run, executable versions of these same examples.

Although Duncan recommends using the latest versions of the Microsoft Macro Assembler, MASM version 4.0, and Linker, LINK version 3.05, to assemble and link the source code, I had no problems using MASM version 1.25 and LINK version 2.01 on an AT&T 6300. The .EXE and .COM programs ran perfectly.

The disk also includes utility and example programs that do not have source code listings in the book but that illustrate topics the author discusses. This disk is a great timesaver for those who will actually use the example programs; an order blank for the disk is included in the book.

APPEARANCE AND ORGANIZATION

The layout of *Advanced MS-DOS* is both handsome and helpful. The example programs and fragments of source code are printed in a reverse-video effect with black characters on a light brown background. This makes the code listings stand apart from the text without interfering with their readability.

The material is divided into four sections. The first and largest describes the MS-DOS system services on a category-by-category basis. Section 2, a complete reference guide to all the MS-DOS interrupts, is more than you would expect from a typical programmer's reference manual. Included with the description of how to load the proper registers to call a specific function are notes about the "nonstandard" behavior of the function and how it behaves under different versions of MS-DOS. This is clearly an added bonus of the author's expertise. Every function's description includes a short assembly language example program that can serve as invaluable code fragments when you're writing your own programs to call functions. Two final, shorter sections are reference guides to the special interrupts in the IBM PC ROM BIOS and to the Lotus/Intel/Microsoft expanded memory specifications.

HIGHLIGHTS

One factor that distinguishes *Advanced MS-DOS* from a technical reference manual is the way in which the author treats nonstandard methods of accessing system services. Duncan explains the "correct" and most portable method for accessing an operating system service. He also demonstrates how to use less portable, hardware-dependent methods when speed (rather than portability or compatibility with future versions of the operating system) is the driving force. This approach makes the book more valuable than a mere transliteration of a manual. The author's effectiveness as a programmer adds real merit to these explanations, providing insights into how to accomplish your programming tasks most efficiently.

A chapter on accessing MS-DOS's file- and record-manipulation functions is one of the book's highlights. Because of the historical ties between CP/M and MS-DOS, two methods of controlling files exist in MS-DOS. Duncan provides an in-depth discussion of file management first by comparing the file control block (FCB) and file han-

(continued)

ACCESS TO FULL MEMORY, STRUCTURE, COMPATIBILITY WITH GW- & PC-BASICA, AND WITH THE POWER AND FLEXIBILITY OF C OR PASCAL



BetterBASIC runs existing GW-BASIC/PC-BASICA programs on IBM PCs and true clones yet gives you structure and access to full memory. BetterBASIC has more than 150 statements in addition to the standard Microsoft syntax. There is optional 8087/80287 math chip support. The Runtime System creates stand-alone EXE files. Call us or ask your local dealer for . . .

**Better
BASIC™**

1-800-225-5800

In Canada, call 416-469-5244

Summit Software Technology, Inc.™
106 Access Rd. Norwood, MA 02062

BetterBASIC is a registered trademark of Summit Software Technology, Inc. IBM PC is a registered trademark of International Business Machines Corp. Microsoft is a registered trademark of Microsoft Corp.

dle methods of file access and then by explaining why he recommends the latter method.

The author devotes an entire chapter to programming for the character I/O devices, such as the video display, keyboard, printer, and serial port. He discusses the pros and cons of using three distinct methods of video display control on MS-DOS and PC-DOS microcomputers.

One example, from the chapter that discusses the MS-DOS EXEC function, presents a program for a simple, table-driven command interpreter shell that overlies COMMAND.COM. This program is designed as a model that can be expanded to provide a customized user interface for special applications. Two parallel listings of the program are presented, one written in C and the other in assembly language. The functions and procedures in the two listings are similar enough to enable the reader to compare and contrast the two versions of the program.

A WORTHY REFERENCE

Advanced MS-DOS is a good example of what a technical reference manual should be. Because my interest is in graphics programming, however, I wish that the author had addressed efficient use of the Enhanced Graphics Adapter functions. But because that is mainly a hardware-dependent problem, its lack of coverage does not detract from the book or its intention.

Clearly, Duncan's strengths include a style that is at once easily read, a thorough coverage of the subject matter heretofore unknown, and the frequent use of examples in the form of assembly language programs and code fragments. *Advanced MS-DOS* contains a great deal of valuable information that I know I will frequently refer to.

John D. Unger (P. O. Box 95, Hamilton, VA 22068) is a geophysicist for the U.S. Government who also writes graphics programs in assembly language and C for microcomputers.

TECHNICAL TOPICS FOR THE IBM PC FAMILY:

An Annotated Bibliography

Compiled by Donald Evan Crabb

This collection of book annotations, intended as a follow-up to those that appeared in BYTE's last IBM Special Issue (Fall 1985), covers several recently published books on technical topics addressing the IBM PC, XT, PCjr, AT, and compatible computers. The books, all softcover, are divided into three sections: hardware issues, PC/MS-DOS and related operating systems issues, and programming. This bibliography reflects availability and bias and cannot be considered inclusive.

HARDWARE ISSUES

This topic is a catchall for books that cover the hardware design and architecture of the PC, including such issues

(continued)

STATGRAPHICS®

NOW!
Faster. More Procedures.
Improved Data Management!

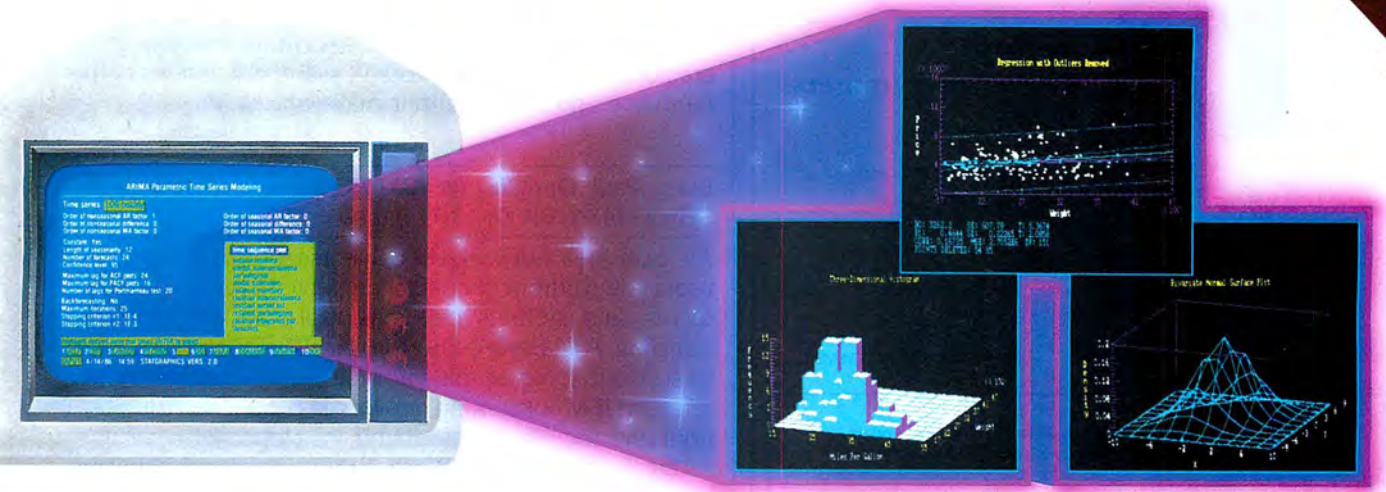

Powerful Statistics, Sophisticated Graphics In One Complete Software System

STATGRAPHICS from STSC is simply the most complete and powerful statistical software available for your PC. STATGRAPHICS integrates powerful statistics with high-resolution color graphics—in one single software system—to give you an extraordinarily powerful analytical environment.

"[STATGRAPHICS] is unusually complete as software systems go in terms of statistical capabilities."
(PC Week)

With more than 250 statistical and mathematical procedures, STATGRAPHICS offers you the power and precision of mainframe software—right on your PC. All the tools you need for comprehensive statistical analysis: ANOVA, complete regression analysis, experimental design, quality control procedures, multivariate techniques, nonparametric methods, and extensive forecasting and time series analysis, including Box-Jenkins.

"I've found STATGRAPHICS to be one of the most complete and easy-to-use statistics programs that I have come across."

(Whole Earth Software Catalog)

All this statistical power is even more valuable with STATGRAPHICS' unique interactive environment. STATGRAPHICS is completely menu-driven so you can get into your statistical analysis work quickly and be productive right from the start. You can easily go back and forth between your numerical and graphical analysis—change variables as many times as you want—and see the effect immediately.

You can also enter and access data easily. STATGRAPHICS has a full-screen data editor and interfaces with standard ASCII files, Lotus® 1-2-3® and Symphony® worksheets, and dBASE® files.

"Verdict: [STATGRAPHICS is] a model PC software system which will set standards for PC statistical software."

(PC User Magazine)

STATGRAPHICS offers you a wide variety of graphics capabilities to help you visually analyze your data—more options and more sophistication than any other PC statistical software. Included are histograms, two- and three-dimensional line and surface plots, scatter plots, time sequence plots, quality control charts, as well as bar and pie charts. STATGRAPHICS supports a wide range of graphics boards, printers, and plotters.

For the most complete, advanced statistical graphics software system available, order STATGRAPHICS today. To order, contact your local dealer. If they don't have it, tell them to call STSC toll-free.

(800) 592-0050

In Maryland or Canada call (301) 984-5123.

STATGRAPHICS—the best overall choice!

	Integrated Statistical Graphics	Direct Lotus & dBASE Interfaces	Menu-Driven	Minimum Hardware Required	Helpline Support	U.S. Suggested Retail Price
STATGRAPHICS	✓	✓	✓	Dual Floppy Disk	✓	\$795*
SPSS/PC+™	NO	NO	NO	10 Meg Hard Disk	✓	\$1385
SAS/PC	NO	NO	✓	20 Meg Hard Disk	✓	\$2700+ Annual Maintenance Fee

STSC

Inquiry 272

Available nationally through Softsel and distributors worldwide. Dealer inquiries welcome.

*International prices slightly higher. STATGRAPHICS, SAS, and dBASE are registered trademarks of Statistical Graphics Corporation, SAS Institute Inc., and Ashton-Tate, respectively. Lotus, 1-2-3, and Symphony are registered trademarks of Lotus Development Corp. PLUS*WARE and SPSS/PC+ are trademarks of STSC, Inc. and SPSS Inc., respectively.

A PLUS*WARE™ PRODUCT



for Turbo Pascal Programmers

turboMAGIC™ turns your ideas into state-of-the-art programs.

Your productivity increased, or **your money back!**

Let your imagination run wild! It's easy with turboMAGIC. Input forms. Report forms. Help windows. Pop-up menus. Pull-down menu systems. And more! turboMAGIC will turn 15 minutes of your time into code that would take you hundreds of hours to write. Whether you're a professional or just a beginner, you need turboMAGIC.

It's **POWERFUL!** It's **FLEXIBLE!** It's **FAST!** It's **MAGIC!**

MAGICscreens. A revolutionary breakthrough! Screens update automatically to show relationships among fields. Dependent values change and unneeded fields disappear before your eyes. You get easy-to-read screens.

MAGICwindows. For truly flashy programs! Pop-up windows at the touch of a key. And when necessary you'll scroll within framed windows for help or data entry.

MAGIChelp. Everywhere! Get automatic bottom-line help and a help window for each field of input forms. And you'll have a help window for each option of a menu. You have more than 200K of context-sensitive help in turboMAGIC!

MAGICkeylines. A class act! At the touch of a key the bottom line changes to remind you of your full, customized function-key setup.

All this magic and more is in turboMAGIC. Put it in your programs too! turboMAGIC makes it easy. Here's how:

Full-Featured Editor - WordStar-like. Absolutely the best!

- Arrows ● repeat ● color ● box (automatic turns/intersections)
- Block ● reformat ● color ● move ● copy ● read ● write
- Centers ● current page ● line ● text in a box
- Colors ● menu selection ● all systems supported ● no flicker
- Graphics ● menu selection of extended ascii characters
- Printing ● customized graphics character translation ● fonts

Flexibility - never before seen in a code generator!

- Up to 66 lines in a form.
- Full WordStar-like editing for input forms.
- Your form image stored either in a typed constant or in a picture file. turboMAGIC can even combine several picture files into one.
- Field types galore: *numeric* (bounds checking) ● *date* (validity check) ● *character* (you can specify the legal input set) ● *string* (fill character, case conversion, justification, and a picture facility that lets you add your own format elements) ● *boolean* ● *male/female* ● *yes/no* ● *dollar amount* ● *social security* ● *telephone* ● *zip code* ● *numeric with automatic increment* ● *menu* (your options appear at the top of a key). You want more types? turboMAGIC lets you add your own.

Free Bonus! We'll give you an impressive screen/printer installer for the programs you create with turboMAGIC. And we'll also send you some valuable demo programs FREE!

Wouldn't you like some magic? Order turboMAGIC today. Only \$99.00. You have nothing to lose with our 30-day full money-back guarantee. CALL NOW! 1-800-225-3165 (Outside Alabama, orders only) or 205-342-7026 (VISA & MC welcome, no PO, no COD)

Requires: Turbo Pascal 3.0 and an IBM PC/XT/AT or compatible 256k RAM minimum

Not copy protected.



Sophisticated Software Inc.
6586 Old Shell Road
Mobile, AL 36608 (205) 342-7026

Trademarks:
Turbo Pascal — Borland International
WordStar — MicroPro International

as connecting your PC to a variety of external devices, how to design the hardware and software interfaces that are necessary, how to network PCs, and discussions of the hardware and software that make up the PC.

Berry, Paul. *Operating the IBM PC Networks*. Berkeley, CA: Sybex, 1986. \$19.95. 363 pages.

As local area networks become more important to PC users, the plethora of conflicting network topologies, protocols, and systems becomes more and more mind-boggling. Paul Berry's *Operating the IBM PC Networks* helps to sort out some of this information for both the newly released IBM Token Ring network (a baseband configuration) and the older broadband PC Network.

This handbook should prove very useful to LAN users of either network, as well as to potential network customers. It covers information for network administrators, end users, and network consultants. The introduction to LANs is helpful, and the 14 chapters that follow cover most of the important aspects of the two networks in detail. Topics include how to set up and run the equipment, how to automate network usage for end users, how to start and restart the networks, how to use electronic mail over the LAN, how to manage shared resources and disks, and how to optimize the network performance.

The book's only drawback is that it limits coverage to PC Network and IBM Token Ring. I'd like to see similar handbooks for some of the other network systems crowding the market.

Byers, TJ. *Inside the IBM PC AT*. New York: McGraw-Hill, 1985. \$19.95. 309 pages.

If you can ignore its enthusiastic narrative style, TJ Byers' *Inside the IBM PC AT* will reward you with comprehensive technical information about the AT. The author covers all the important hardware and software aspects of the AT in detail for experienced PC users and programmers.

Byers provides descriptions and illustrations to help novice AT users get their machines up and running, but the heart of the book lies in the technical discussions of PC-DOS, custom programming, and AT hardware.

Eggebrecht, Lewis C. *Interfacing to the IBM Personal Computer*. Indianapolis, IN: Howard W. Sams & Co., 1985. \$16.95. 246 pages.

If you're about to attempt to interface a variety of devices to your PC and want to find out just what general issues are entailed, *Interfacing to the IBM Personal Computer* is a good place to start. Unfortunately, this reference handbook doesn't present specific interface designs, so much of its practical utility is lost. However, it does provide general information about interfacing the PC, details about the PC

(continued)

A complete list of things to know about 2400 bps modems.

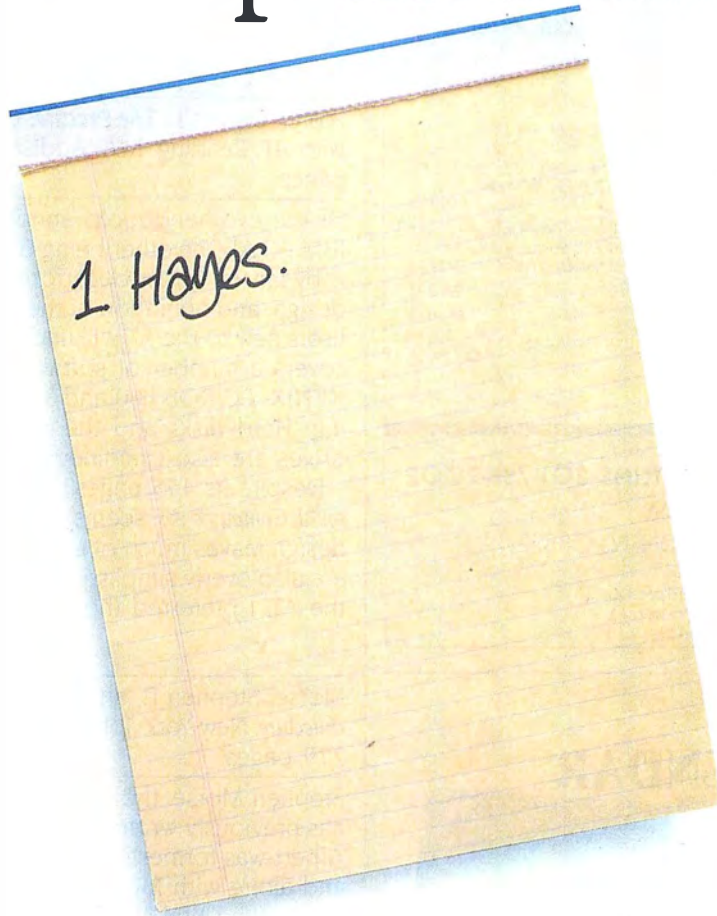

Now that you've memorized that, here's a partial list of why a Hayes® Smartmodem 2400™ is best for you.

1. The Hayes Smartmodem 2400 allows you to communicate with the vast installed-base of 300,1200 and 2400 bps "Hayes-compatible" modems. The Hayes Standard "AT" Command Set allows you to use Smartcom II® and other software that communicates.

2. Through synchronous/asynchronous technologies, the Smartmodem 2400 permits your PC to access mainframes, minis, and on-line services previously inaccessible through asynchronous-only modems.

3. The Hayes Smartmodem 2400 is efficient...it pays for

itself in just 4 hours of annual use over long distance.

4. The technology of the Smartmodem 2400 allows you to transfer volumes of files with confidence across the city or



across the ocean using Bell and CCITT standards.

5. The new Smartmodem 2400B™—a plug-in board for the IBM PC and compatibles—allows synchronous and asynchronous communication through the same Com port.

6. You will also get the Hayes standard 2-year limited warranty and the opportunity to extend the warranty to 4 years.

Best of all...you get Hayes. And that's all you ever really have to know!

For more information or technical specs, contact your authorized Hayes dealer. Or Hayes directly at (404) 441-1617.

Hayes Microcomputer Products, Inc., P.O. Box 105203, Atlanta, Georgia 30348.



Hayes®

Say yes to the future with Hayes.

The Ultimate In Printer Sharing

For \$200 per port, PC users can link and share printers—any type (laser, plotter, line, letter quality, dot matrix) using any application software, running on any kind of PC. PrintDirector provides:

- an ideal solution for sharing expensive peripherals, especially laser printers, among two to twenty PCs
- printing without waiting—up to one megabyte automatic print buffering and concurrent I/O for serial and parallel ports
- automatic installation and operation—should never even have to use the manual

PrintDirector is an immediate solution for today's user needs that can also become a server in a larger network tomorrow.

PrintDirector

Digital Products, Inc., 108 Water Street, Watertown, MA 02172
617-924-1680 Outside Massachusetts, Call 1-800-243-2333

Inquiry 86

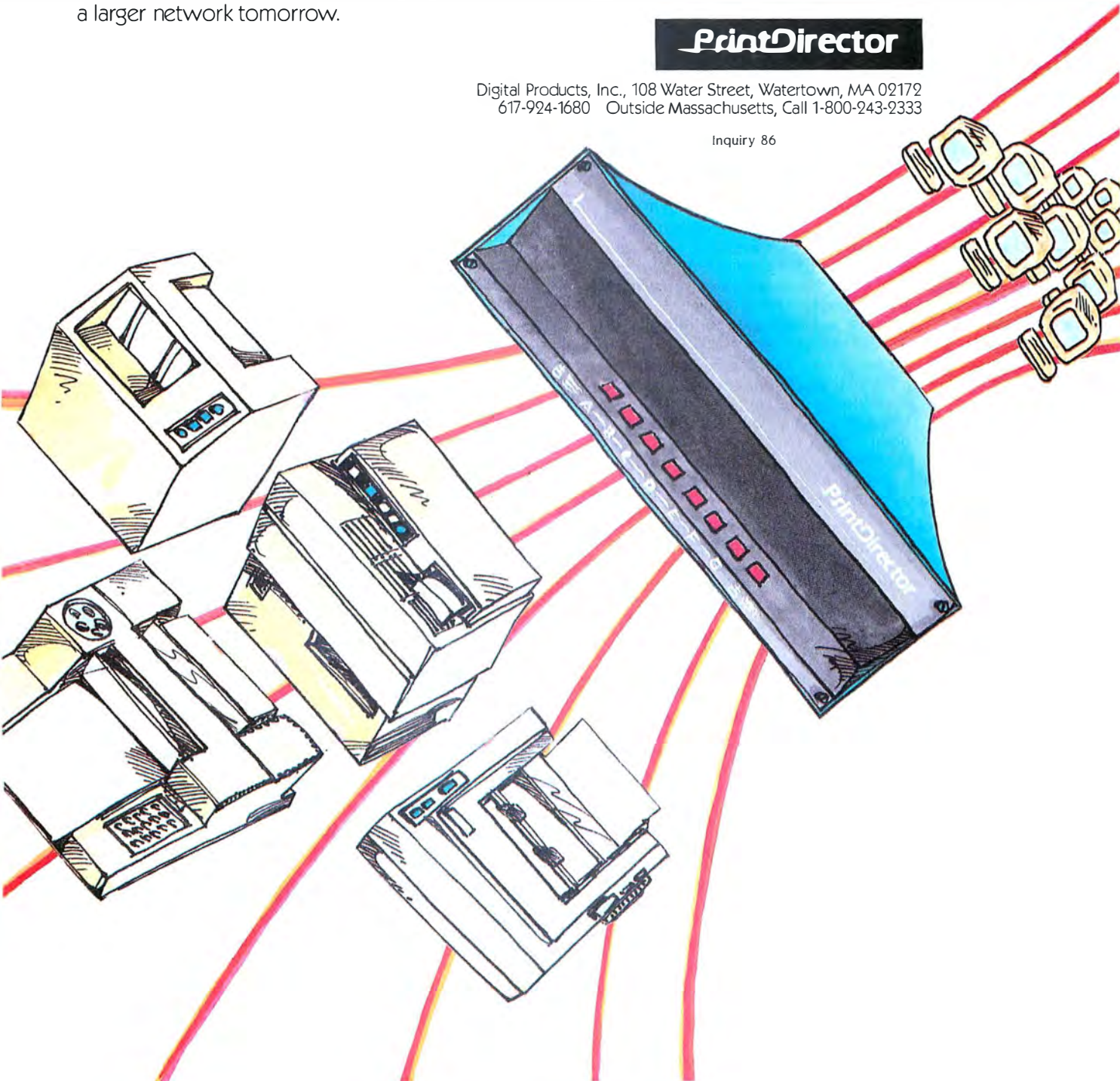

Letter Perfect

Now! Full Feature, 20 CPS,
Letter Quality Printer only \$279.95

For those who need a Daisy Wheel Printer, our Daisy 1120 has it all. To start with, it has a front control panel with indicators for Pitch Selection which allows for 10, 12 or 15 pitch or Proportional Space printwheels. There is a Select (Online) button with indicator and a Line Feed button. You can also set Top-of-Form or Form Feed with the touch of a button. Other indicators include Power and Alarm. The built in 2K buffer allows a page or two of concurrent printing and use of your computer for the next job. To really take advantage of your printer's optional features, the automatic Cut Sheet Feeder eliminates tiresome single page handling and the adjustable Tractor Feed option handles all continuous form paper. Best of all the Daisy 1120 is quiet: only 58 dB.



Total Compatibility The Daisy 1120 uses 96 character Diablo® compatible printwheels. At 15 pitch you can print 165 columns—a must for spreadsheets.

The Daisy 1120 uses the Diablo Hytype II® standard ribbon cartridges, also universally available.

Not only is the hardware completely compatible, the control codes recognized by the Daisy 1120 are Diablo 630® compatible (industry standard). You can take advantage of all the great features of your word processing package and automatically use superscripts, subscripts, automatic underlining, boldface and doublestrike.

The printer has a set of rear switches which allow the use of standard ASCII, as well as foreign character printwheels. Page length can be set to 8, 11, 12, or 15". The Daisy 1120 can also be switched to add automatic line feed.

Try the Daisy 1120 for 2 weeks. If you are not satisfied we will issue a prompt refund. 1-year parts and labor warranty is included.

The Bottom Line Arotek Daisy 1120 (Order #1120) \$279.95 w/standard Centronics parallel interface. 2K buffer, ribbon and printwheel. Shipping in cont. US is \$11. UPS Blue is \$24

Options: Compare our prices!

Auto Cut Sheet Feeder (#1110) \$185. Shipping \$7.
Bidirectional Tractor Feed (#1112) \$75. Shipping \$5.
Interfaces for most computers are available—call.

ORDERING INFORMATION California residents add 6% tax. All prices are cash prices — VISA and MC add 3% to total. We ship the next business day on money orders, cashier's checks, and charge cards. A 14-day clearing period is required for checks. Prices subject to change—CALL. Dealer inquiries invited

For information call 805/987-2454
TO ORDER CALL TOLL FREE
1 (800) 962-5800 - USA (8-8 PST)
1 (800) 962-3800 - Calif.

Or send order to:



APROTEK DEPT. BY

1071-A Avenida Acaso, Camarillo, CA 93010

BOOK REVIEWS

80286 chip (DOS versions 1.1, 2.0, 2.1, 3.0, 3.1, 3.2, etc.). The books in this section are user's guides for DOS, written from the point of view of the serious PC user who wants more technical and practical information about the operating system and a DOS reference that's easy to use.

DeVoney, Chris. *Using PC-DOS*. Indianapolis, IN: Que Corporation, 1986. \$21.95. 519 pages.

Chris DeVoney's *Using PC-DOS* is an interesting combination of a PC-DOS tutorial, a PC-DOS advanced guide, and a PC-DOS reference handbook. The material is familiar, of course, but the structure and explanations of this book help set it a step above the ordinary. The book could also serve as a textbook for a course on using DOS.

It's easy to read, and it covers all the DOS commands and usage that it should. The command reference section is particularly handy. Along with Wolverton's book (below), it's my favorite DOS handbook, primarily for its clarity and writing style.

Kamin, Jonathan. *MS-DOS Power User's Guide*. Berkeley, CA: Sybex, 1986. \$19.95. 397 pages.

If you use your PC for more than a few hours a day, this is a useful book. Jonathan Kamin lists batch programs, BASIC programs, display screens, macro files, and assembly language programs, all of which are carefully designed to help you get more out of your PC. For example, you can configure your system using a chapter on writing CONFIG.SYS and AUTOEXEC.BAT files. If you want to customize the screen colors on your display, just refer to the chapter on customizing your screen and keyboard.

MS-DOS Power User's Guide contains valuable information about the PC and DOS. Undocumented commands and hard-to-find technical details abound. Much of what Kamin presents is available elsewhere, especially in the Peter Norton books (see last year's IBM bibliography), but the organization here is half the reason for buying the book. Kamin has made it easy to find the technical trickery you need to make your PC jump through hoops.

King, Richard Allen. *The MS-DOS Handbook*, 2nd edition. Berkeley, CA: Sybex, 1986. \$19.95. 339 pages.

The MS-DOS Handbook is really two reference books in one. Richard King divides his text into a programmer's handbook and a user's handbook. The programmer's handbook discusses the detailed specifications of disk and file operations, keyboard control, monitor and port control, and memory management of MS-DOS. King also includes full descriptions of all operating system functions needed to write MS-DOS programs, including good programming examples.

The user's handbook includes information on EDLIN,

(continued)

Control Systems

ARTIST[™] Series

A Family of High Performance
Graphic Display Controllers

*Introducing
New Prices*

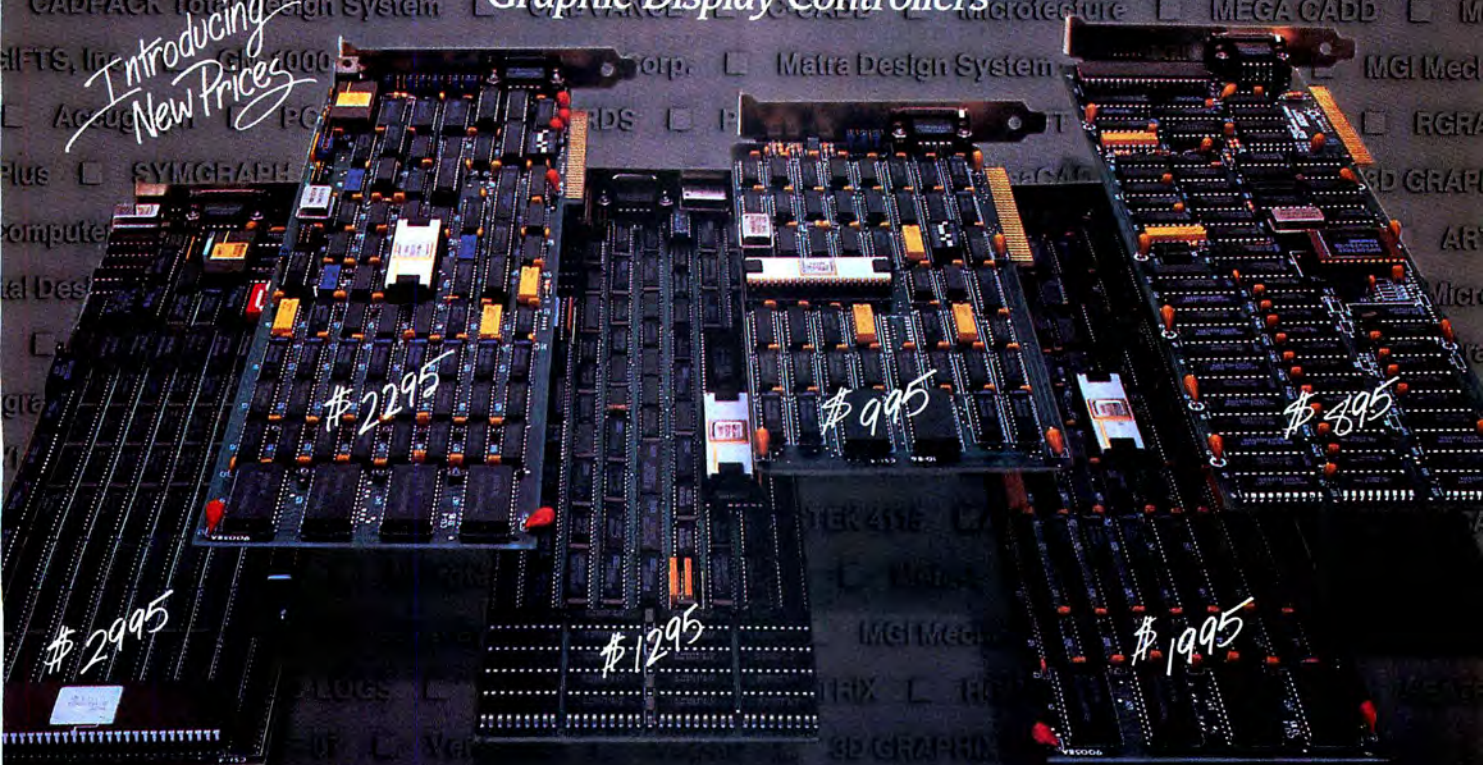

ARTIST 10 [™]	ARTIST 1 PLUS [™]	ARTIST Transformer [™]	ARTIST Monochrome [™]	ARTIST 1 [™]	ARTIST 2 [™]
1024 x 1024 256 Colors 64MHz	1024 x 1024 16 Colors 64 MHz	640 x 480 16 Colors 30 MHz	1024 x 768 4 Shades 64 MHz	1024 x 768 16 Colors 40 MHz	640 x 400 16 Colors 24 MHz

54 Software Products to Back Us.

3D—Shaded
Images

Architectural
CAD

Graphic
Art

Mechanical
CAD

Electronic
CAD

Business
Graphics

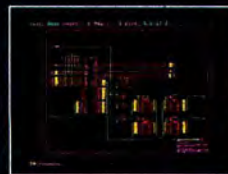

Personal Designer
Software
by Computervision

CADVANCE
by CalComp

ARTBRUSH
by Control Systems

AutoCAD
by Autodesk

RGRAPH
by APTOS Systems

Speaker Support
PLUS
by Meta-4, Inc.

Call Toll Free for Sales and Service
1-800-826-4281
in Minnesota call
612-631-7800



2675 Patton Road
P.O. Box 64750
St. Paul, MN 55164

ACTOR debut in one month.

There's a better way to program coming in October.

It's like an advanced research system. Instead of data structures and procedures, it uses active objects. But it produces finished, useful programs. Not experiments.

It's easy to optimize, and it has a new way to reclaim unused memory. As a result, it runs so fast on microcomputers, it's good even for real-time control.

And it's built around Microsoft® Windows, which help when you write your programs. And when other people use them.

It's called ACTOR™, and it will perform like nothing you've ever seen. To find out more about it, just call.

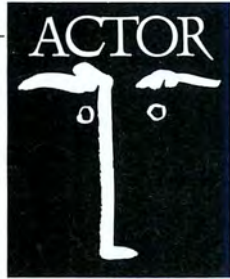

The Whitewater Group®

906 University Place, Evanston, IL 60201
(312) 491-2370

BRING YOUR HARD DISK BACK UP TO SPEED WITH H.D. TUNEUP!

The harder you work, the more files you put on your hard disk, the faster DOS works to fragment those files. Fragmented files make you wait longer for file loads and saves. **H.D. Tuneup** rearranges the data on your hard disk for the fastest possible file i/o times. Your disk will speed along like new.

*“Much better than Disk Optimizer™
- Philadelphia, PA*

Requires IBM PC/XT/AT compatibility, DOS 2.x or higher and at least 196K. Hard disks up to 32mb may be tuned, along with most 5.25" diskettes.

ONLY \$39.95 + \$3.00 shipping (US/Canada)

SofCap Inc.
P.O. Box 131

Cedar Knolls, NJ 07927

Visa (201) 386-5876 MasterCard

If you want the absolute best possible performance from your hard disk:

TUNE IT UP WITH H.D. TUNEUP

DOS files, how to configure the system, batch processing, monitors, serial ports, and more.

The MS-DOS Handbook contains a good discussion on the issues of software compatibility, offers a guide to the different versions of MS-DOS. This is a useful book, especially for its programmer's handbook discussions. The novice material is neither as useful nor as detailed.

Siechert, Carl, and Chris Wood. *The Power of Running PC/DOS*. Portland, OR: Management Information Source, 1986. \$22.95. 386 pages.

The Power of Running PC/DOS is really a handbook for the latest versions of DOS (3.0, 3.1, and 3.2). It can be used equally well by novices and experienced PC users. Siechert and Wood cover familiar ground in their PC setup instructions, DOS command references, directory structures, and DOS utility programs. The book also includes a number of useful BASIC programs that you can type in and run.

It's clearly designed, easy to read, and contains useful examples. Overall, though, it's a bit thin; other books mentioned cover the same material in greater detail.

Wolverton, Van. *Running MS-DOS*, 2nd edition. Redmond, WA: Microsoft Press, 1985. \$21.95. 423 pages.

This book is simply the definitive handbook of PC-/MS-DOS. It has been expanded and improved to cover the newer releases of MS-DOS. *Running MS-DOS* is written for both novices and experienced users. Carefully structured, it contains copious examples and is a model of expository clarity. Van Wolverton's new edition fixes some mistakes of the first edition, adds new material, and explains all the commands and techniques users need to know about managing files and disks, creating custom commands, automating the execution of frequently used commands, managing a hard disk, and manipulating the screen display, printer, and telecommunication devices.

PROGRAMMING

The IBM PC and its compatibles work with a variety of high-level programming languages (through PC-/MS-DOS and CP/M-86): BASIC (interpreted and compiled), Pascal, FORTRAN, COBOL, LISP, and C. Also, the PC can be programmed effectively with 80xxx assembly language. The books listed here teach some technical aspects of high-level or assembly language programming on the PC.

Busch, David D. *Program Your IBM PC to Program Itself!* Blue Ridge Summit, PA: Tab Books, 1986. \$12.95. 145 pages.

Though the title sounds strange, *Program Your IBM PC to Program Itself!* delivers on its promise. David Busch has

(continued)

MASTERING THE SYSTEM.

Announcing the next generation of MicroComputer Accessories!



The MicroConsole Control Module

THE MICROCONSOLE™ REMOTE CONTROL CENTER

Complete power control and protection—and more!—with a remote control panel compact enough to rest on the top edge of a keyboard—or anywhere you want it!

This isn't another big switch box under the monitor. We got it all together by taking it apart. The MicroConsole actually consists of two separate wire-connected modules—the Control Module and the Power Module.



The Control Module, a wired-remote control panel, stays close at hand on the keyboard or desktop. It features membrane-type on/off switches for five components and peripherals, with fail-safe Master and CPU switches—plus a calculator and digital clock! The slim, compact Control Module sits on the keyboard or stands alone on its own detachable feet.

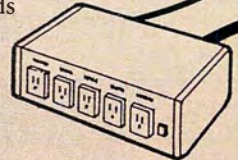

The Power Module stays on the floor and keeps messy cables out of the way. It provides outlets for five components and peripherals, with full three-path surge protection and telephone line conditioning for your modem.



The Static Clear



The Surge Protector

THE STATIC CLEAR Dissipator w/LCD Display

Seeing-is-believing static protection. Before touching your computer, touch the Static Clear. When the lightning bolt on the LCD display fades, you know *for sure* that harmful static has been dissipated.

THE SURGE PROTECTOR Power Strip

The best-designed and best-priced power strip available! Six outlets with full three-path surge protection and a circuit breaker switch with an indicator light. There's a slot for wall hanging and a retaining clip for organizing cables. Neat!

**affordable IBM® compatible
COMPUTER SYSTEMS**

XT SYSTEM 2-BASIC

FCC approved

Includes:

- Flip-top XT-type case • Power supply • 640K motherboard with 256K on board

No. 98888

\$233

XT SYSTEM 3-BASIC TURBO

FCC approved

Includes:

- Flip-top XT-type case • Power supply • 640K turbo motherboard with 256K on board.

No. 98999

\$293



**—SUGGESTED ADD-ONS—
(system 2 & 3)**

- Monochrome graphic printer No. 99010 **\$75**
- (2) Qume floppy drives No. 93140 **\$190**
- Magnavox green monitor No. 96710 **\$87**
- Floppy drive controller No. 92260 **\$29**
- K-150L keyboard No. 90130 **\$45**
- **Total—System 2 plus Add-Ons \$659**
- **Total—System 3 plus Add-Ons \$719**

SmarTeam Modem



103/212A—Operates at 300 Baud & 1200 Baud
• Hayes Compatible
• Auto Answer, Dial & Redial

Uses RS 232-C Connector
No. 91990

\$159.00

MAGNAVOX Color Monitor



• RGB High Resolution
• 13" diagonal
• 640 Dots/H-240 lines/80 column

No. 97890

\$298.00

Avatex 1200 Modem

- Auto Answer, Dial & Redial
- FCC Approved
- PC TALK III Software included
- Automatic Self Test on Power-Up

COMPARE AT \$199.00

No. 97070 **\$87.00**



Keyboards

- K-134 IBM® Type Keyboard Caps and Num Lock FCC approved No. 51515 **\$76.00**
- K150M XT Keyboard—looks like AT, has big return key & LED indicators FCC approved No. 99020 **\$59.00**

ADD-ON BOARDS FOR IBM® COMPATIBLE SYSTEMS

FCC approved

Monochrome Graphic Printer Board

- Built in Parallel Printer Port • Text; 25 line x 80 column • Graphics: 720x348 resolution • TTL High Resolution Output

No. 99010 **\$75.00**

Multi I/O Card

- Built-in Floppy Controller that can drive 2 floppy drives • Two RS 232 Serial Adapters • Timer Port • Parallel Printer Port • Joystick Adapter

No. 96770 **\$79.00**

Multifunction Board

- Expandable to 384K RAM • Serial Port, Game Port • Parallel Printer Port • Clock Calendar w/Battery Backup • Software, Manuals and Cables

No. 92290 **\$75.00**

RS 232 Serial Board

- 1 Serial Port • 2nd Port optional

No. 92310 **\$27.00**

Parallel Printer Card

- Also may be used as I/O Port

No. 92700 **\$21.00**

Color Graphics Board

- RGB and Composite Port • Light Pen Interface • Graphics: 320x200 (color); 640x200 (BW) • Text: 25x80

No. 92280 **\$65.00**

Floppy Disk Controller

- Drives 2 internal drives • Includes cable
- IBM PC compatible

No. 92260 **\$29.00**

PLUS A HUGE SELECTION OF CABLES & ACCESSORIES!

THE WHOLESALE OUTLET

DEPT BY, 1 INTERSTATE AVENUE, ALBANY, NY 12205

518-459-7883 (NYS Res.) Customer pays freight & \$3.75 handling FOB Albany, NY. Non-credit card orders shipped UPS, C.O.D.(cash). Minimum order \$25.00. Some items not as pictured. Prices subject to change. IBM®, PC, XT, AT are registered trademarks of International Business Machines, Inc.

assembled a collection of 19 BASIC programs that will save you a lot of time and effort. Included are programs that display graphics screens for presentations, create the skeleton for database programs, check programs for spelling mistakes or incorrect punctuation, provide screen editing, count the words in your document or program, redefine function keys, and design custom screens.

Each program is listed in full (a disk containing the programs is available for \$24.95), and a useful description is also provided. The book assumes that you are a PC BASIC programmer and are familiar with PC-DOS.

Campbell, Joe. *Crafting C Tools for the IBM PCs*. Englewood Cliffs, NJ: Prentice-Hall, 1986. \$21.95. 434 pages.

Just like Stevens's book discussed below, *Crafting C Tools for the IBM PCs* provides examples and tips for making programming tools. This book is also a C-language reference handbook, as well as a handbook for Intel 8088 assembly language and for PC-DOS. The emphasis here is more on using a combination of C and assembly language to perform such tasks as calling DOS and ROM BIOS routines, handling interrupts and screen cursor management, processing the PC's function keys, reading and setting the default drive and directory path, changing a file's time and date stamp and reading the system clock, and creating screen windows and pop-up menus. Although Joe Campbell's book has a wider reach and is easier for less experienced programmers to read than Al Stevens's *C Development Tools for the IBM PC*, novices should probably stay away. The book has a solid structure, with good use of examples. If you know C programming well and are going to use it frequently, put this book on your shelf, along with Stevens's.

Miller, Alan R. *Assembly Language Techniques for the IBM PC*. Berkeley, CA: Sybex, 1986. \$22.95. 358 pages.

Assembly Language Techniques for the IBM PC helps you use and adapt assembly language utility programs for your PC. It is structured around a powerful library of assembly language macros that are discussed, explained, and dissected. Alan Miller has developed programs utilizing these macros and he teaches readers how to use them. Miller's book is written in a manner designed to teach you how to use the material presented—and it does a good job.

Miller's treatment of the subject is fairly comprehensive: He covers the ROM BIOS (both versions 2 and 3); PC-DOS (versions 2 and 3); and the system debugging program, DEBUG. The primary focus, however, is on the collection of macros and programs he has assembled that should run on PCs and ATs. These programs handle screen, port, and keyboard control, as well as memory management and disk I/O. A particularly useful program example shows

(continued)

Interoffice Memo.

A single MaynStream™ backs up
all the PCs in your office,
file by file!



Protecting Files: Top Priority.

Hard drive users learn fast how indispensable tape backup really is. But equipping each of your PCs with its own backup system is a costly way to go. That's why we developed the MaynStream, our lightning-quick, *file-by-file* tape backup. When you've backed up one PC, just detach the MaynStream's Quick-Release Cable and snap it onto any other PC equipped with a low-cost MaynStream controller. Simple menus will guide you through another backup in seconds. And restoring data is just as easy. So when your hard drive forgets to treat your files like your business depends on them, the MaynStream remembers.

Other Powerful Systems for the PC.

Backup That Won't Back Down.



The MaynStream is small, lightweight, and big on performance features. Its rugged design and convenient carrying handle make multi-PC backup a breeze. And talk about fast! Backup takes just 3 minutes* for the average 10MB drive (that's file-by-file, and it's still faster than the now antiquated image mode technology)! The MaynStream uses handy data cassettes small enough to slip into your shirt pocket. Available in 20 and 60 MB models.



MaynStream internal, available in both 20MB and 60MB models.

MaynStream 60Q internal, available in 60MB model.

MaynStream portable, available in both 20MB and 60MB models.

MaynStream 60Q portable, available in 60MB model.

Transport Plus™ portable combination 20MB hard drive and 20MB tape backup.

Transport™ 20MB portable hard drive.

All Maynard systems are backed by our 1-year warranty.

Sold at the finest computer stores. Contact your local dealer or write to us today for product information.

 **Maynard Electronics**
Shaping tomorrow's technology.

460 E. Semoran Blvd., Casselberry, FL 32707 305/331-6402

Inquiry 186

*Actual time: 2min/57sec. Total files backed up: 376 consisting of 10,002,432 bytes. Computed on IBM PC with 512K memory and one 10MB hard disk drive. Your actual backup time may vary. IBM PC is a trademark of International Business Machines.

TOTAL CONTROL with LMI FORTH™



For Programming Professionals: an expanding family of compatible, high-performance, Forth-83 Standard compilers for microcomputers

For Development: Interactive Forth-83 Interpreter/Compilers

- 16-bit and 32-bit implementations
- Full screen editor and assembler
- Uses standard operating system files
- 400 page manual written in plain English
- Options include software floating point, arithmetic coprocessor support, symbolic debugger, native code compilers, and graphics support

For Applications: Forth-83 Metacompiler

- Unique table-driven multi-pass Forth compiler
- Compiles compact ROMable or disk-based applications
- Excellent error handling
- Produces headerless code, compiles from intermediate states, and performs conditional compilation
- Cross-compiles to 8080, Z-80, 8086, 68000, 6502, 8051, 8096, 1802, and 6303
- No license fee or royalty for compiled applications

For Speed: CForth Application Compiler

- Translates "high-level" Forth into in-line, optimized machine code
- Can generate ROMable code

Support Services for registered users:

- Technical Assistance Hotline
- Periodic newsletters and low-cost updates
- Bulletin Board System

Call or write for detailed product information and prices. Consulting and Educational Services available by special arrangement.

LMI Laboratory Microsystems Incorporated
Post Office Box 10430, Marina del Rey, CA 90295
Phone credit card orders to: (213) 306-7412

Overseas Distributors.

Germany: Forth-Systeme Angelika Flesch, Titisee-Neustadt, 7651-1665

UK: System Science Ltd., London, 01-248 0962

France: Micro-Sigma S.A.R.L., Paris, (1) 42.65.95.16

Japan: Southern Pacific Ltd., Yokohama, 045-314-9514

Australia: Wave-onic Associates, Wilson, W.A., (09) 451-2946

you how to expand the PC's usable memory beyond 640K (to 704K) by using the 64K-byte block of memory normally left unaddressed by DOS.

To use the material presented by Miller, you should have experience as a high-level and assembly language programmer. You'll also need a PC with at least two disk drives, 256K bytes of RAM, the Microsoft or IBM assembler, a linker program, and a debugger. If you have the requisite hardware, software, and programming experience, *Assembly Language Techniques for the IBM PC* will reward you with a straightforward discussion of the technical problems and solutions involved in assembly language macro programming on the PC.

Scanlon, Leo J. *80286 Assembly Language on MS-DOS Computers*. New York: Prentice-Hall Press, 1986. \$21.95. 316 pages.

Leo Scanlon's *80286 Assembly Language on MS-DOS Computers* can be used by both novice and experienced high-level language programmers who want to learn the Intel 80286 instruction set and assembly language programming on computers using it. The book starts with a brief introduction to binary and hexadecimal arithmetic, moves quickly to the fundamentals of assembly language programming, and then covers macro assemblers and how to build macro libraries.

The author uses plain English. His discussion includes useful programs and segments as illustrative tools. He also covers the SYMDEB debugger, the EDLIN line editor, and all the LINK utilities. He even throws in a discussion of how to program the Intel 80287 math coprocessor chip.

The program examples are so useful that you may well use them after you've finished the book. They include high-precision arithmetic programs, sorting programs, and code conversions.

Stevens, Al. *C Development Tools for the IBM PC*. New York: Prentice Hall Press, 1986. \$22.95. 240 pages.

Not designed for the novice C programmer, *C Development Tools for the IBM PC* provides the experienced C programmer with a group of important development tools designed to assist in creating real applications. C language tools that support the development of on-line, interactive software systems on the PC are the province of Stevens's book. The book is really a tutorial workshop for tools such as file management, sorting, indexed data management (using B-trees), screen forms management, and menu management.

The author supplies the examples themselves, with thorough discussions of their purpose and use and the history of their development. It is full of technical details that will help you design and code programs of sound structure and proper syntax. If you are going to be doing

(continued)

How to put Ferrari speed and Mack Truck capacity into a PC

without available slots.



Install the Dream Board in place of your multifunction card.

Chugging along in an overloaded, underpowered PC without room to expand? Need the increased power and memory of an AT™ without sacrificing your current software library or DP budget?

Problem solved:

The Univation Dream Board!

- A PC accelerator board that triples the speed of your PC,
- Plus an EMS RAM board with up to 2 megabytes of high-speed RAM for your most complex Lotus™ spreadsheets and CAD operations,

- Plus a full-featured multifunction card with serial and parallel ports, clock/calendar, RAM Disk, Print Spooler, Disk Cache, and a speed selection switch that maintains 100% PC software compatibility.

All in ONE SLOT

That's the dream come true. If your PC, XT, Compaq™ Portable, or 100% compatible is full, simply replace your single application multifunction card with the Dream Board. You'll retain all your multifunction features while adding incredible speed and power. **With slots to spare!**

Planning to buy a new PC? The Dream Board is the ideal multifunction board. It provides the speed and power of an AT at a fraction of the cost.

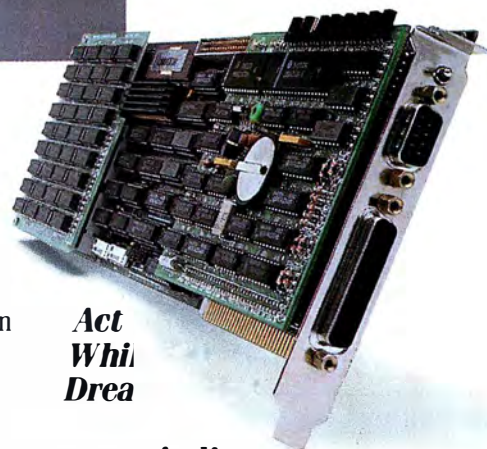

**Act
Whi
Drea**

your mind!

You need the power and the slots. The Dream Board is the answer! Call Univation today. Representatives are waiting to answer your questions and fill your order. Stop traveling in the slow lane. **Move into the passing lane today!**

Outside California Call:

(800) 221-5842

 **UNIVATION**
System Solutions for Business

1231 California Circle
Milpitas, CA 95035
(408) 263-1200

Inquiry 289

serious (e.g., production) programming on the PC, XT, or AT in C, keep this handbook nearby.

Troy, Douglas A. *Complete C Language Programming for the IBM PC*. Boston, MA: Little, Brown and Company, 1986. \$24.95. 505 pages.

When you start to read *Complete C Language Programming for the IBM PC*, you may forget that you are reading a book about programming a PC. Not because there aren't copious references to the PC—there are. Not because there aren't examples of specific PC implementations—there are. Not because there aren't discussions of C language compilers for the PC—they are here also. It's the tone and orientation of the book that might throw you. There's no doubt that this book is written by a systems analyst who's had a lot of experience designing and coding C programs on larger computers. Discussions of program development, design, and coding are written in a way that bespeaks a large systems analysis orientation.

Is this approach effective? Surprisingly, yes. In fact, the book does an excellent job of teaching C programming on the PC. I would have liked to see specific discussions of C compilers incorporated into examples in the text (rather than relegated to an all-too-brief appendix), since the differences in performance and implementation are much greater among compilers than Troy admits. But that's a small complaint. This book will teach you the C language with the proper emphasis on good programming style, including top-down design and structured development methods. Troy uses two application programs, a calculator and a stock-portfolio system, to teach C. They are developed and refined with each chapter as more of the C language is revealed. *Complete C Language Programming for the*

IBM PC assumes that you have solid programming experience on the PC with another language—Pascal would be helpful.

OTHER SOURCES

Several sources exist for readers to research for further information relating to specific topics on IBM PCs. Although the sources that follow are general and include other aspects and machine-specifics, they can be very instructive.

Bowker, R. R., and Company. *Bowker's 1985 Complete Sourcebook of Personal Computing*. New York: R. R. Bowker Company, 1985. \$19.95. 1050 pages.

Brand, Stewart, ed. *The Whole Earth Software Catalog for 1986*. Garden City, NY: Quantum Press/Doubleday, 1985. \$17.50. 224 pages.

Char, Carlene, ed. *Computer Book Review*. Honolulu, HI: Maeventec, 1986. \$20 for 12 issues.

Couger, J. Daniel. *Computing Newsletter for Schools of Business: Bibliography*. Colorado Springs, CO: University of Colorado, 1986. \$4 annual issue.

Sammett, Jean E., ed. *ACM Guide to Computing Literature*. New York: Association for Computing Machinery, 1986. \$60 annual issue.

Sammett, Jean E., ed. *Computing Reviews*. New York: Association for Computing Machinery, 1986. \$60 for 12 issues. ■

Donald Evan Crabb is the Director of Instructional Laboratories and a lecturer (The University of Chicago, Department of Computer Science, Ryerson Hall 260, 1100 East 58th St., Chicago, IL 60637). His articles and reviews have appeared in several magazines.

DataSaver® Standby UPS

90 Watt. The original micro-UPS that brought standby AC power to Apple users in 1980. Still the POWER SOLUTION for serious applications of the MAC, small micros, and portables. Model 9012060 \$350. FCC(15A&B).

400 Watt. Now, POWER PROTECTION and MASTER CONTROL for full-size micros. Filters electrical noise/spikes and provides up to 10 minutes of AC power for the AT and supermicros. Model 40012060 \$695. UL-E101268.

200 Watt. This DataSaver standby UPS offers compact, cool and quiet line conditioning and backup power to PC, XT, and COMPAQ markets. Data and hardware are protected. Model 20012060 \$495. CSA-LR51253.



Cuesta Systems Corporation
3440 Roberto Court
San Luis Obispo, California 93401

© 1986. Made with pride in the U.S.A.
805/541-4160 TLX:4949381 CUESTA
Dealer, VAR, & OEM inquiries invited.

Circuit-Board-Artwork Software: \$895. And guaranteed.

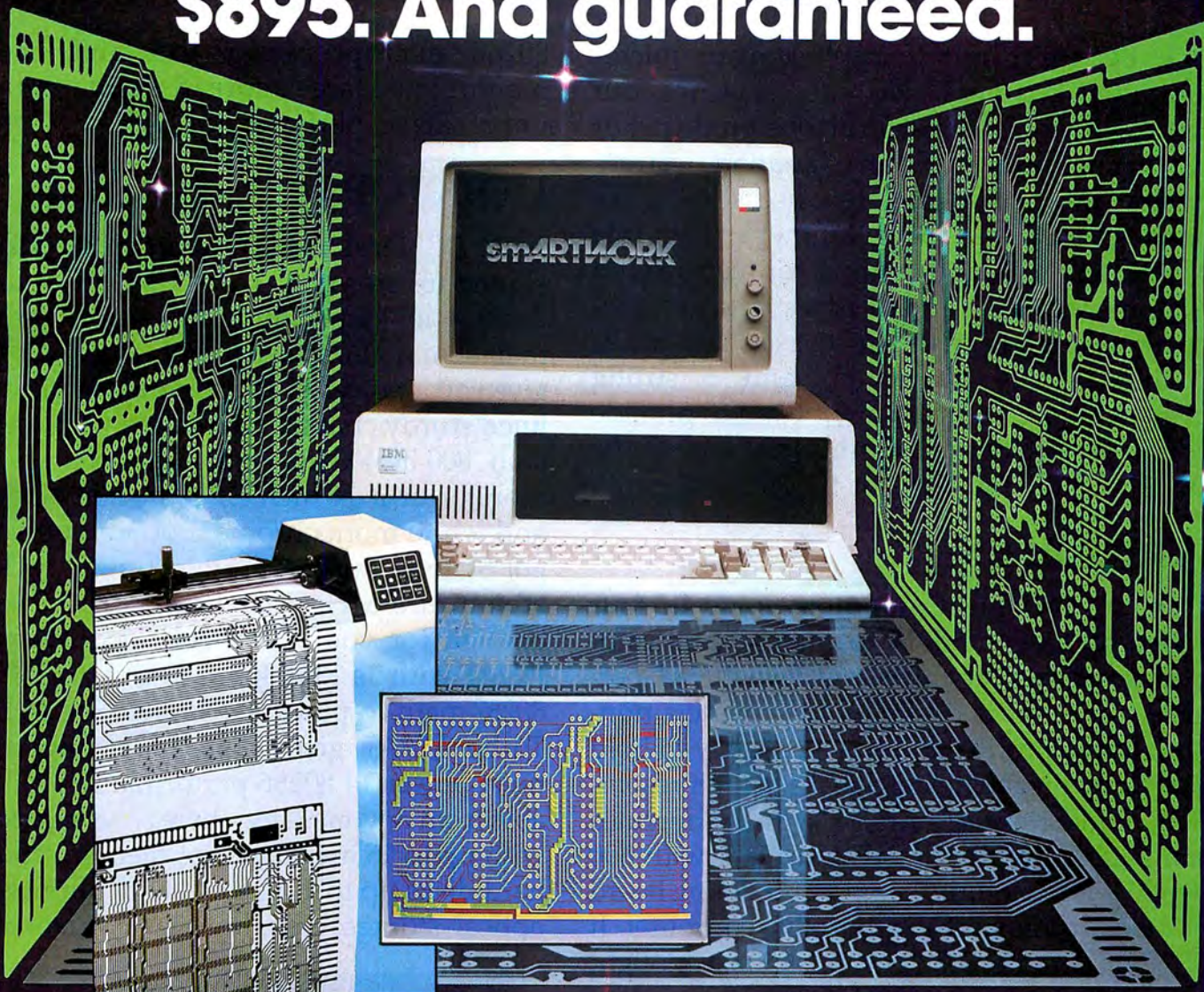

smARTWORK® lets the design engineer create and revise printed-circuit-board artwork on the IBM Personal Computer. You keep complete control over your circuit-board artwork—from start to finish.

And smARTWORK® is reliable. When we couldn't find a package that was convenient, fast, and affordable, we created smARTWORK® to help design our own microcomputer hardware. We've used it for over two years, so we know it does the job.

That's why we offer every design engineer a *thirty-day money-back no-nonsense guarantee*.

smARTWORK® advantages:

- Complete interactive control over placement and routing
- Quick correction and revision
- Production-quality 2X artwork from a pen-and-ink plotter

- Prototype-quality 2X artwork from a dot-matrix printer
- Easy to learn and operate, yet capable of sophisticated layouts
- Single-sided and double-sided printed circuit boards up to 10 x 16 inches
- Multicolor or black-and-white display

System Requirements:

- IBM Personal Computer, XT, or AT with 320K RAM, 2 disk drives, and DOS Version 2.0 or later
- IBM Color/Graphics Adapter with RGB color or black-and-white monitor
- IBM Graphics Printer or Epson FX/MX/RX series dot-matrix printer
- Houston Instrument DMP-41 pen-and-ink plotter
- Microsoft Mouse (optional)

The Smart Buy

At \$895, smARTWORK® is proven, convenient, fast — *and guaranteed*. Call us today. And put smARTWORK® to work for yourself next week. Try it for 30 days at absolutely no risk. That's smart work.

Wintek Corporation Inquiry 308
1801 South Street
Lafayette, IN 47904-2993
Telephone: (317) 742-8428
Telex: 70-9079 WINTEK CORP UD



In Europe contact: RIVA Terminals Limited,
Woking, Surrey GU21 5JY ENGLAND,
Telephone: 04862-71004, Telex: 859502

"smARTWORK"; "Wintek" and the Wintek logo are registered trademarks of Wintek Corporation.

OFFICE AUTOMATION

Tech PC, we're out to capture your micro-computer business. No one matches our diverse line of high performance products, or our comprehensive system of support, warranty, and third party maintenance service options. Tech PC is a large Southern California computer design and manufacturing firm with computer research and design specialists, production engineers, technical assistance staff, qualified sales personnel, and a strong management and investment team to provide you with state of the art products, state of the art reliability, and state of the art economy.

PORTABLES

Tech PC Portable Computers come in four different base models to match your computing needs. Our entry level **Tech PC/XT** portable computer is designed to provide a non-obstructive profile, and has a capacity to hold two thirty megabyte hard disks, a high resolution monochrome monitor with a Hercules compatible graphics card to drive it with 800 by 400 lines resolution, and never before heard of 6 expansion slots in a portable computer. If 4.77 MHz of Intel 8088 power isn't fast enough, try our **Turbo 4.77 to 8 MHz** 8088-2 or optional NEC V-2 microprocessor based portable machine. Designed to increase speed up to 170 percent of a standard PC/XT, **the Tech PC/AT and Tech Turbo PC/AT portable units are state of the art in portable performance.** The 80286 microprocessor based units can be fitted with up to 240 megabytes of high speed voice coil hard disk technology, and with the Turbo AT's 10 MHz math co-processor socket and 10 MHz

80286 microprocessor the unit can manipulate large spreadsheets with unparalleled performance.

DESKTOPS

Tech PC Desktop Computers are designed for survival. The **XT's** leave your desktop looking comfortably empty with their slim non-obtrusive profile; The **AT's** give you a powerful presence with a clean lined sturdy chassis. Combined with a 14 inch, 800 by 400 line amber monochrome monitor or a 14 inch, 1280 by 800 black and white monochrome monitor you've got **State of the Art** staring straight back at you. If 8 MHz 80286 power isn't fast enough for you... try the **Tech Turbo PC/AT** with its 10MHz 80286 and 10 MHz 80287 math co-processor socket. The **Tech Turbo PC/AT** gives you the **strongest, most powerful** 80286 performance available from anyone, anywhere... available with up to 16 megabytes of memory and hard disks up to 1 gigabyte with our new optical storage disk, the Tech Personal

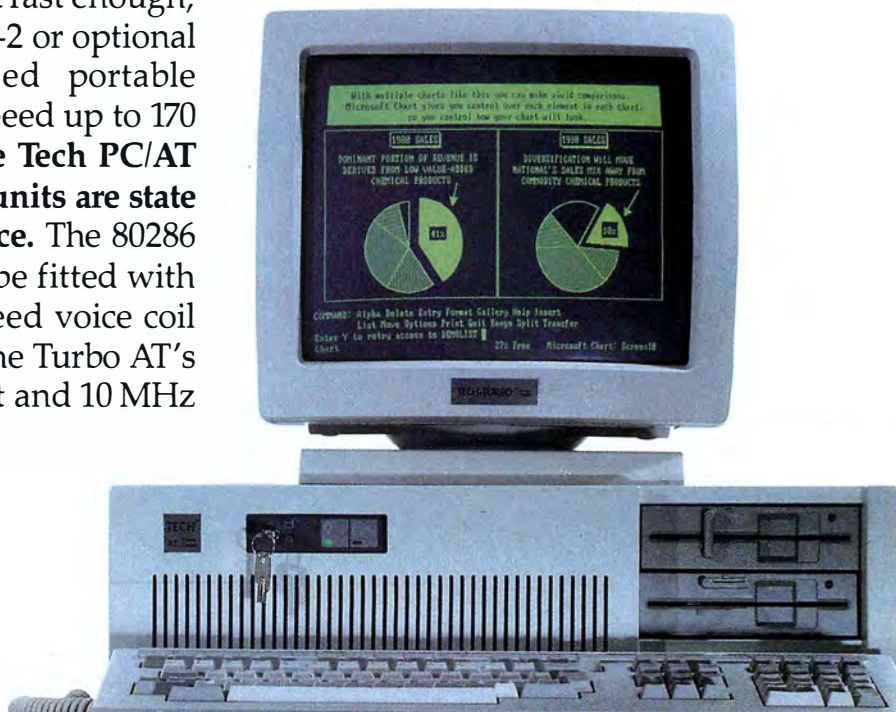

Computer Desktops represent the cutting edge of desktop microcomputer technology.

Tech Personal Computers, Inc. is a full service manufacturer of Micro Computer Products and offers a complete line of Desktop, Portables and Multi-User Computer Systems as well as an accessory line of over one hundred enhancement products. **Tech Personal Computers, Inc.** are all backed by a full one year warranty with additional maintenance coverage and extended maintenance contracts available through Momentum Service Corp. For more information concerning hundreds of MSC Service Centers throughout the United States, contact **Tech Personal Computers, Inc.** at (714) 754-1170.



OFFICE ON LOCATION

DESKTOPS

- TECH PC/XT DESKTOP**\$ 529
Options:
- Tech PC/XT with 20MB Hard Disk\$ 979
- Tech PC/XT with 20MB Hard Disk, Monochrome Monitor, Hercules® Compatible Mono/Graphics Card\$1179
- TECH TURBO PC/XT DESKTOP**\$ 629
Options:
- Tech Turbo PC/XT Desktop with 20MB Hard Disk \$1079
- Tech Turbo PC/XT 20MB Hard Disk, Monochrome Monitor, Hercules® Compatible Mono/Graphics Card\$1279
- TECH PC/AT DESKTOP**\$1399
Options:
- Tech PC/AT with 20MB Hard Disk\$1799
- Tech PC/AT with 20MB Hard Disk, Monochrome Monitor, Hercules® Compatible Mono/Graphics Card\$1999
- TECH TURBO PC/AT DESKTOP**\$1599
Options:
- Tech Turbo PC/AT Desktop with 20MB Hard Disk \$1999
- Tech Turbo PC/AT with 20MB Hard Disk, Monochrome Monitor, Hercules® Compatible Mono/Graphics Card ..\$2199

PORTABLES

- TECH PC/XT PORTABLE**\$ 899
Options:
- Tech Turbo PC/XT Portable with 20 MB Hard Disk\$1349
- Tech Turbo PC/XT Portable with 1200 Baud Internal Hayes Compatible Modem and 20 MB Hard Disk\$1549

- TECH TURBO PC/XT PORTABLE**\$ 999
Options:
- Tech Turbo PC/XT Portable with 20 MB Hard Disk ...\$1449
- Tech Turbo PC/XT Portable with 1200 Baud Internal Hayes Compatible Modem and 20 MB Hard Disk\$1649
- TECH PC/AT PORTABLE**\$1799
Options:
- Tech PC/XT Portable with 20 MB Hard Disk\$2199
- Tech PC/XT Portable with 1200 Baud Internal Hayes Compatible Modem and 20 MB Hard Disk\$2399
- TECH TURBO PC/AT PORTABLE**\$1999
Options:
- Tech PC/XT Portable with 20 MB Hard Disk\$2399
- Tech PC/XT Portable with 1200 Baud Internal Hayes Compatible Modem and 20 MB Hard Disk\$2599

All TECH PC PORTABLES available with tape backups, hard disks up to 1 gigabyte, networking systems, and hundreds of other hardware and software accessories.

TECH PC

714/754-1170

2131 South Hathaway, Santa Ana, California 92705
Telex 272006 Answer Back - TECH FAX: 71415568325

Microprocessor Development Dreams Come True!

On-Line Help menus,
Command Glossary,
and Word List.

Windows can be used
to view source files,
previous traces,
and more.

Symbol translation
or source code
line display.

Screen displays scroll off
into history buffer –
can be viewed later.

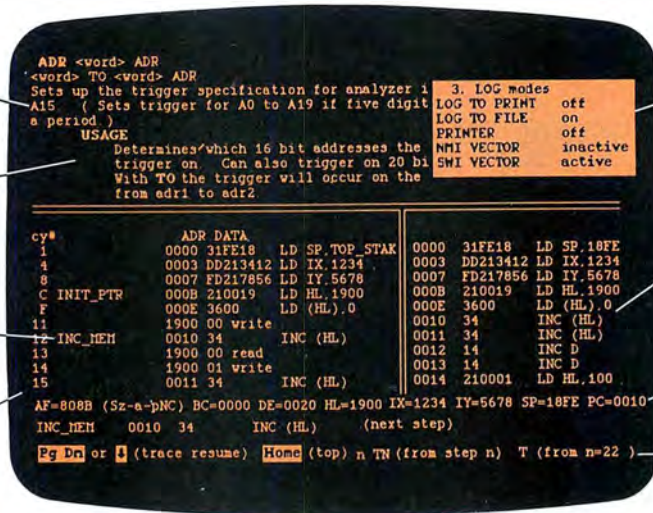

Pop-up Mode
Selection panel
called by soft key.

Disassembly of code
in memory can be
compared with trace in
adjacent window.

Symbolic debug
register display.

Context sensitive
prompt line.

NEW UniLab II™: FOUR INSTRUMENTS IN ONE!

Here are all the development tools you ever dreamed of integrated into one PC-controlled system:

- An Advanced 48-Channel Bus State Analyzer
- An 8/16-Bit Universal Emulator
- A Built-In EPROM Programmer
- An Input Stimulus Generator

The synergy of these instruments that were designed together to work together saves you time and money. All UniLab II commands and menus are seamlessly integrated into a single, super-efficient working environment.

An Integrated Software Environment, too!

Imagine being able to split your screen and look at real-time program traces and the source code that produced them at the same time! Then go to the On-Line Help or pop-up Mode Panels instantly.

If you see something on a trace that doesn't look like last time, you can hold it in one window while you scroll back through your previous displays.

If you set a breakpoint and single-step you can then go back to using the analyzer without missing a beat. You can even execute a DOS batch file from UniLab to edit, assemble, and link, then automatically load the new program and symbol table. UniLab uses the full power of the PC.

Find bugs fast with Hardware-assisted Debugging

The traditional way to look for bugs is to single-step through suspect parts of the code until you catch it in the act. This requires a lot of guessing and wasted time.

With UniLab's built-in analyzer you eliminate the guesswork. Just describe the bug symptom as a trigger, and let the UniLab hardware search

for it as your program runs in real time. UniLab will show you a trace of the program steps leading up to the symptom, almost like magic.

A friendly user interface

UniLab lets you use commands or menus – or a mixture of both. An on-line manual, soft-key help screens, a glossary of commands and their parameters, with full-screen writeups are also at the ready.

Reconfigure for any 8 or 16-bit processor in seconds

Thanks to our unique approach to emulation, changes between processor types require only cable and diskette changes. At last count, we specifically support over 120 microprocessors.

Bonus! The built-in EPROM Programmer and Stimulus Generator are simply icing on the cake.

Affordable capability

How much does all this superior capability cost? A lot less than our less able competitors, and probably a lot less than you expect. Our products are sold with a Money Back Guarantee, and our crack team of Applications Engineers is standing by if you need help. Get the full story on the amazing UniLab II and how it can liberate your development projects, today.

ACTION COUPON

Send me info on UniLab II and your No-Risk 10-Day Evaluation!

Name: _____ Title: _____
Company: _____
Address: _____
City: _____
State/ZIP: _____
Tel.: _____ Ext. _____

UniLab II™
Universal Development Laboratory



Orion Instruments, Inc.

ORION

702 Marshall Street
Redwood City, California 94063

CALL TOLL FREE: 1-800-245-8500

In California (415) 361-8883

THE IBM RT PERSONAL COMPUTER

Inside IBM's RISC processor and memory management unit

BY RICHARD O. SIMPSON

BACK IN 1975 the IBM Research Division began a project to investigate the utility of simple but very high speed computer hardware in a practical computer system. This system became known as the 801 Minicomputer—"801" because the project was located in Building 801 of the IBM T. J. Watson Research Center in Yorktown Heights, New York, and "minicomputer" because the machine was envisioned as being less expensive and physically much smaller than the mainframes of the time.

People who observed noticed that programs running on complex high-performance machines spent most of their time performing only very simple instructions, such as Load, Store, Branch On Condition, and Add. A good deal of the control logic of a complex machine exists for the instructions that require multiple cycles and for the complexities of memory operands that cross page boundaries and therefore could cause a page fault partway through an instruction's execution.

A stripped-down machine, one that is simpler than the IBM System/370, for example, could be made faster if it didn't have to deal with complex but statistically seldom-used operations. The goal of the 801 computer project was to produce a machine that executed programs at a sustained rate of one instruction per machine cycle.



To achieve this rate, the instructions could not be very complex. All arithmetic and logical instructions were defined to operate on the contents of registers; there were no instructions like Add To Memory or Move Memory To Memory. Only simple addressing modes such as base plus displacement and base plus index were provided so that effective address calculation could be executed in a single cycle.

Operations that would inherently take multiple cycles—such as Multiply—were not provided. Instead, a single-cycle Multiply Step instruction was provided. In addition, provisions were made for very efficient linkage to a subroutine that would build the complex Multiply function out of the

primitive Multiply Step instructions.

OPTIMIZING THE COMPILER

The level of the instruction set of the 801 was comparable to the microcode level of more traditional machines. As a result, more 801 instructions were needed to perform a given function than, for example, IBM System/370 instructions. The size of the programs was not a problem. Memory costs were decreasing, and any product based on the 801 would more than likely be a virtual memory system. However, if an 801 program were a great deal longer than the equivalent program for a traditional

machine, it would take longer to execute even at only one cycle per instruction.

The solution was a highly optimizing compiler to shorten an 801 program by eliminating redundant calculations, moving calculations out of

(continued)

Richard O. Simpson holds B.S. and M.E.E. degrees from Rice University and is a member of IBM's Advanced Engineering/Scientific Development organization in Austin, Texas. Since 1981 he has been involved in the architectural definition of ROMP and its memory management unit and more recently in the definition of the IBM RT Personal Computer. He can be contacted at IBM Corporation, Advanced Engineering/Scientific Development, 11400 Burnet Rd., Austin, TX 78758.

loops, performing calculations at compile time, and eliminating unnecessary loads and stores. The compiler and the language it compiled were named PL.8; the language is a system-programming dialect of PL/1, and the ".8" refers both to 801 and to the fact that the language was originally PL/1 with those features not useful for sys-

tem programming (about 20 percent) removed.

The design of the 801 went through several iterations. An early version had sixteen 24-bit registers and a mixture of 2-byte and 4-byte instructions. (The registers were 24 bits wide to simplify construction of a prototype from discrete logic.) The final design

had thirty-two 32-bit registers and only 4-byte instructions. Restricting the instruction format to only one size simplified instruction decoding enough so that the machine's cycle time could be reduced.

The instruction set of 801 was specified in conjunction with the design of the PL.8 compiler. Instructions were included based on the needs of the compiler rather than the perceived needs of an assembly language hand-coder. The high-level language was to be the programming interface, through the PL.8 compiler or other compilers.

The designers provided many general-purpose registers because it is easy for a compiler to manage such a large set and it makes for more efficient code by eliminating most "spill" code requirements. The shift in design from 16 to 32 registers was based on compiler studies, which showed that the extra registers were worth the extra hardware cost.

MEMORY BANDWIDTH

Each 801 instruction was one word (32 bits) long, aligned on a word boundary in memory. The width of the data path to and from memory was also 32 bits. Since about 30 percent of the dynamic instruction mix was Load and Store instructions, the memory interface had to supply an average of 1.3 words per machine cycle. To maintain this rate the 801 had separate caches for instructions and data, each of which could handle one word per cycle.

A load from the cache took two cycles altogether. In a form of delayed branch called Branch With Execute, the instruction physically following the branch was always executed regardless of the branch condition. This gave the instruction cache an additional cycle in which to supply the branch target.

These efforts to keep throughput high were successful. Executing instructions on the 801 was somewhat like drinking from a fire hose. The sustained execution rate was around 15.1 million instructions per second at a

(continued)

If only research were always this simple



There's no need to shop here, there and everywhere in an attempt to put together the system you need for processing images that require scientific analysis. And there's no need to waste time and run risks by buying from several different and potentially incompatible vendors.

Almost as fast as you can say microscopy, CORECO will provide the system you need as well as the support and the security that come from dealing with a computer-vision company that has built its reputation for quality systems by developing its own software AND hardware. The two go together like bacteria and culture.

CORECO's Image Analyzer is a user-friendly, menu-driven program that runs on the CORECO Oculus 200 frame grabber board. This software lets you:

- digitize images • archive images • edit and annotate images • enhance images • process images • assign pseudo colors to images

- output images on a dot matrix printer • and much more, including image enhancement through color manipulation.

And all this at a surprisingly affordable price.

EXCELLENCE IN MACHINES THAT SEE



COMPUTER-VISION
PRODUCTS AND SUPPORT

Tel.: 514-651-3100 (Canada and Europe)
1-800-361-4997 (USA)
Telex: 05-25-134 MTL ATTN: CORECO

Aztec C ... The Best C

Frees the genius in you

You've got a great idea . . .

. . . you're ready to write your programs.

You don't want to be sidetracked by all the paperwork. With Manx Aztec C and the ingenious **make** function, your creative processes won't get bogged down in program administration and housekeeping. Manx Aztec C has the most sophisticated, hardworking program administrator available to you. Once you've described your project, adding new features or enhancements is simple. You never have to concern yourself with the repetitive, tedious task of rebuilding your systems.

The development process moves quickly. Compiles, assemblies, link edits . . . all finish in record time.

Manx Aztec C is the fastest, most efficient C development system in the industry. Benchmarks show it . . . reviews commend it . . . users praise it.

You're ready to test the program. You're ahead of schedule. The Manx Aztec C Source Level Debugger shows you the exact C language statement giving you a problem. You fix the problem quickly . . . you're still ahead of schedule.

You've got some time for fine tuning. The Manx Aztec C Profiler examines your program, tells you where the slow spots are and validates your test procedure. A few changes and it's exactly what you wanted.

You've made it!

Aztec C is available for MS-DOS/PC DOS. Call for details on Macintosh, Amiga, Apple II, CP/M-80, CP/M-86, TRS-80, ROM and others.

To order, or, for information

Call Today

1-800-221-0440

**In NJ or outside the USA call
(201) 542-2121**

30-day satisfaction guarantee. Special Discounts are available to professors, students, independent developers, and on a "trade-in" basis. Site licenses.

" . . . a superb linker, a profiler, an assembler, and a set of development utilities are only the beginning of this package . . . performed admirably on the benchmarks, with short compile times and the best link times in this review . . . includes the most professional make utility . . . documentation is clear and complete. There is no doubt that this is a valuable and powerful programming environment." **Computer Languages Feb. '86**

" . . . execution times are very good, close to the best on most tests . . ." **PC Tech Journal Jan. '86**

" Easily one of the fastest compilers overall . . . library provides a lot of flexibility . . . generates small .EXE files." **Dr. Dobbs Journal Aug. '85**

C'Prime (Compiler, Assembler, Linker)	\$ 99.
Aztec C 86-d Developer's System	\$299.
Aztec C 86-c Commercial System	\$499.
PC ROM (8086, 68000, 8080, or 6502)	\$750.

Third Party Software for Aztec C: HALO, PHACT, C-tree, PRE-C, Windows for C, PC-lint, PANEL, Greenleaf, db Vista, C-terp, Plink-86, FirsTime, C Util Lib, and others.

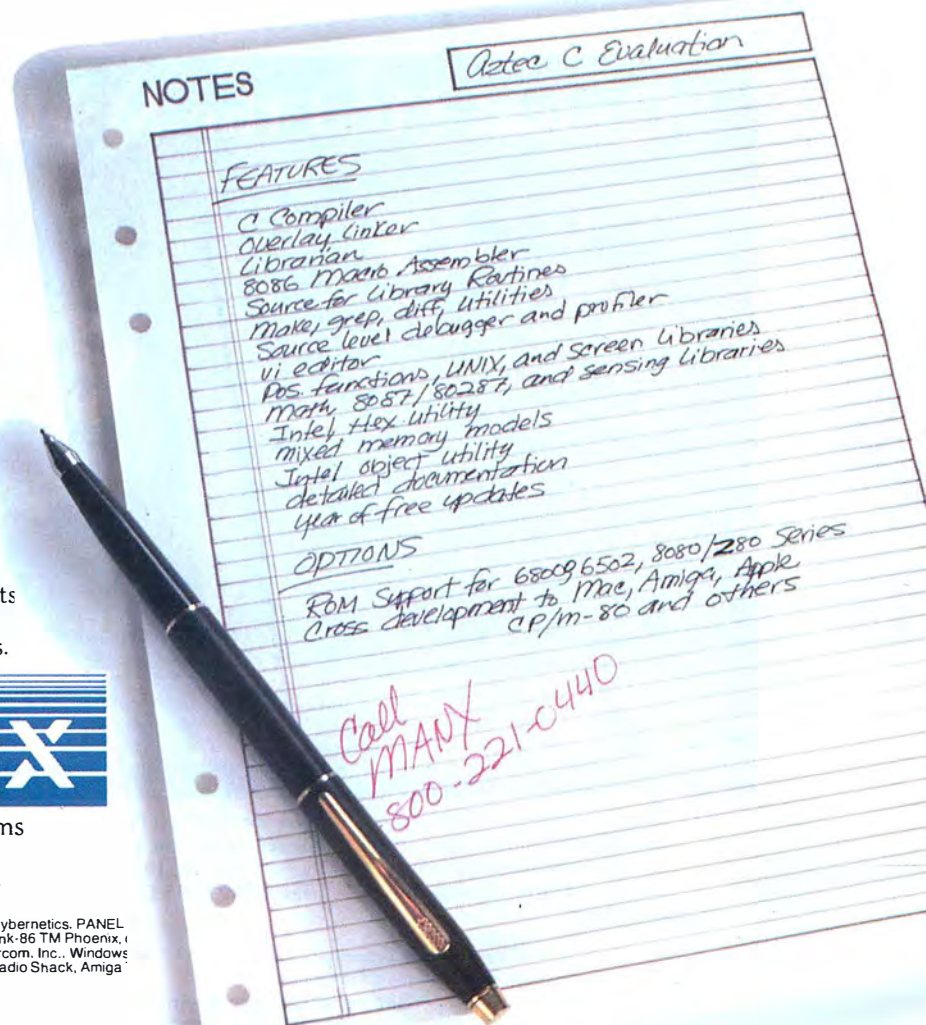

MANX

Manx Software Systems
One Industrial Way
Eatontown, NJ 07724

MS is a registered TM of Microsoft, Inc., CP/M TM DRI, HALO TM Media Cybernetics, PANEL Roundhill Computer Systems, Ltd., PHACT TM PHACT Assoc., PRE-C, Plink-86 TM Phoenix, Vista TM Rama Corp., C-terp, PC-lint, TM Gimpel Software, C-tree TM Faircom, Inc., Windows C TM Creative Solutions, Apple II, Macintosh TM Apple, Inc., TRS-80 TM Radio Shack, Amiga Commodore Int'l.

cycle time of 63 nanoseconds, or about 1.1 cycles per instruction.

Other research groups outside IBM reached the same conclusions regarding rapid execution of simple instructions. The term RISC (reduced instruction set computer) was coined by a group at Berkeley that built a machine with a very simple instruction set. Another group at Stanford devised a machine (MIPS) in which simple operations were executed in parallel in a pipeline, with the compiler responsible for keeping conflicting operations from being scheduled simultaneously.

EVOLUTION OF ROMP FROM THE 801

After the definition of the 801, a project began in the IBM Office Products Division. Its goal was to apply what had been learned on the 801 project to a new microprocessor for use in IBM products. This processor became

ROMP, an acronym for Research/OPD Micro Processor.

Most project code names in IBM are changed each year or two, but ROMP was appealing enough that it stuck with the project through the announcement and release of the IBM RT Personal Computer in early 1986. [Editor's note: In the interest of consistency, the term RT processor is used throughout this article to describe the RISC chip. The acronym ROMP is used only where reference is made to the forerunner of the RT processor, the Research OPD/Micro Processor.] As a microprocessor for a product rather than a minicomputer in a research project, from the start ROMP had different goals from the 801. The 801 strove to maintain the maximum execution speed consistent with its single-cycle-per-instruction design philosophy regardless of hardware cost. Thus the 801 had simpler hardware than, for example, the IBM Sys-

tem/370, but it still had two high-speed caches and multiple internal buses. These were not appropriate for the RT processor, which was to be a single-chip microprocessor.

The cost/performance ratio was important for the RT processor, and two caches were out of the question for a single-chip computer under design in the late 1970s. The lack of cache could not be made up by simply providing very fast memory, again for cost reasons. The RT processor design evolved from a complex set of trade-offs involving hardware cost, machine cycle time, overall throughput, and the amount of logic that could be fitted onto one VLSI chip.

COMMON PHILOSOPHY

The RT processor and the 801 have the same architectural foundation. Both are true general-register ma-

(continued)

"Quick! Find the MS-DOS® Disk."

You just experienced one of the benefits of CenTech Color Diskettes. They're easy to find.

Locate everything from MS-DOS® to Accounts Receivable; and do it at the speed of color.

Designed, engineered and manufactured in the U.S.A. to specifications and standards that exceed those developed by the industry.

Ask for CenTech Premium Color Diskettes by name at your dealer, or become a dealer. Call toll free: (800) 255-3999, or write CenTech, 185 Cottage Avenue, Sandy, Utah 84070. Telex 499-6093 CENTK

CenTech is a registered name of Cenna Technology, Inc. MS-DOS is a registered name of Microsoft Corporation



© 1986 Cenna Technology, Inc. See us at Comdex booth #M1338. The Colorful Solution to Data Organization™

SOLUTIONS!

POWER

The Power to Run Z-80 software on a PC!

Never before has it been easier, or more affordable to add the power of Z-80 compatibility. Plug this half size card in your PC, XT, AT or compatible and within minutes you will be running the most powerful CP/M software available including the most popular

assemblers, compilers, word processors, spreadsheets, etc.

Included with each Z-80 card is our incredible RUN/CPM™ emulation software which will allow your PC to emulate 100's of popular CP/M computers, such as "Kaypro," "Osborne," "Morrow," etc. Your CP/M programs will run up to 300% faster, with full color, and you can run them from your PC's hard disk or "RAM" disk, and run MS-DOS background programs such as Borland's "Sidekick" on top of your CP/M programs. RUN/CPM™'s amazing disk emulation feature will actually allow your PC's floppy drives to Directly READ, WRITE and FORMAT over 165 different CP/M disks, offering you the utmost in data disk compatibility. The RUN/CPM software and Z-80 Co-processor are the perfect solution to bringing the power of the Z-80 to the PC. Call today and order the most affordable Z-80 Co-Processor ever!

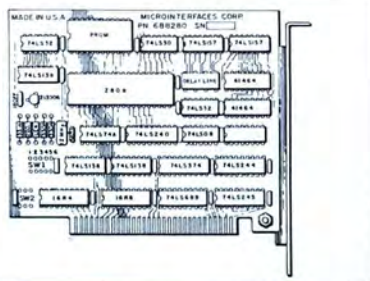

Z-80 Co-processor \$199.95

**Fast!
Hard
Disk
Back
Up.**

Quiksave™ is the solution to all of your hard disk back up needs. Quiksave's incredible speed will allow you to back up 10 megabytes of data in only 10 minutes! Because Quiksave backs up data on to standard floppy diskettes, there is no need for an expensive tape drive system. Best of all, Quiksave comes with 20 "Free" pre-formatted floppy disks,* so you can start backing up your valuable hard disk data immediately. Don't risk costly data loss, order Quiksave™ today and rest assured.

*Enough disks to backup 10 Megabytes of data on most systems.

COMPATABILITY

Run INTEL® on a PC



QUIKSAVE
ONLY \$99.95

SPEED Backup 10 Megabytes in 10 Minutes

Transform an IBM PC, XT, AT, or compatible into an "Intel" Micro Development System, capable of running 8 bit ISIS-II, and 16 bit ISIS-III (UDI) software while remaining 100% MS-DOS compatible. MICRUN 80, our 8 bit ISIS-II Interface is priced at \$495 and includes the above pictured Z-80 card plus all necessary software for running 8 bit Intel software on PC's and AT's. MICRUN 86, our 16 bit Interface is \$450 and does not require hardware. MICRUN 80 and MICRUN 86 are the solutions to Intel compatibility on a PC.

Call to Order, or for more information.
All products come with a 30 Day Money Back Guarantee.

1-800-637-7226



MICRO INTERFACES

6824 N.W. 169th Street

Miami, Florida 33015

(305) 823-8088

Telex 5106004680 MICRO INTER CO.

Inquiry 322 for INTEL on PC's. Inquiry 323 for RUN/CPM.

RUN/CPM is a registered trademark of Micro Interfaces Corporation; Sidekick is a registered trademark of Borland International; Kaypro is a registered trademark of the Kaypro Corporation. Intel is a registered trademark of the Intel Corporation; CP/M is a registered trademark of Digital Research; Z-80 is a registered trademark of Zilog Corp.; Quiksave is a registered trademark of Micro Interface Corp.

chines in which all computation is done on quantities in registers, and no distinction is made between computation on data and addressing arithmetic. Any register can hold a data quantity or a base address. In both machines the movement of data to and from memory is separated from computation by the use of explicit

Load and Store instructions. Most instructions execute in a single cycle. The memory addressing model for each is a simple, linear, byte-space addressed by a 32-bit quantity.

DESIGN DIFFERENCES

The two machines could not be the same, however, because of the trade-

offs discussed above. The most pervasive change was the removal of the two caches. The lack of cache affected everything from the instruction set to the number of registers to page-fault handling.

All 801 instructions were one word long, which made for simple instruction decoding. The 32-bit format allowed room for multiple fields used to hold register numbers (each 5 bits long). The typical instruction specified two source registers and a destination register.

These three-address instructions made for efficient code because it was not necessary to copy one register to another to avoid destruction of one of the operands. The use of all 4-byte instructions means that the CPU's memory bandwidth requirements are greater than one word per cycle. Thus if the RT processor, without caches and with a memory bus width limited to 4 bytes, had implemented the 801 instruction set directly, it could never have achieved a rate of one instruction per cycle.

To reduce the RT processor's memory bandwidth requirements, a 2-byte instruction format was introduced. The instruction set was a mixture of 2-byte and 4-byte instructions with the short format predominating in the dynamic mix. The average instruction length is about 2.5 bytes (versus exactly 4 for the 801). Because about 30 percent of instructions are for loading or storing, the overall bandwidth requirement is about 3.7 bytes per instruction. A memory subsystem that could supply 4 bytes per cycle could keep up with the RT processor's bandwidth requirement.

The 2-byte format couldn't accommodate three 5-bit register fields plus a reasonable size op code, so the instructions were made two-address and the register field size was cut from 5 bits to 4. Consequently, the RT processor uses only 16 general registers (the 801 uses 32).

PRACTICAL COMPLEXITY

To make subroutine linkage as efficient as possible for the RT processor,

(continued)



Buy an FT-156 light pen and PXL-350 Hi Res Light Pen Board from FTG and get Microsoft Windows™ - **free!**

It's a tidy \$99 savings, plus you get the tools you need to take advantage of power Windows. Gathering your software together under a consistent, graphical interface is what Windows does best. Manipulating graphical software is what our light pen and board do best. Windows gives you a whole set of desktop management applications. The FT-156 and PXL-350 let you use them easily, quickly, and efficiently. And our product delivers single-pixel resolution for your graphics.

SPECIAL PACKAGE PRICE*

FT-156/PXL-350 standard configuration board/Windows (IBM PCs, PC-XT, PC-AT and most compatibles).....	\$349
FT-156/PXL-350 expanded configuration board/Windows (AT&T 6300 and COMPAQ computers).....	\$379

Use our toll-free numbers to order or get more information about FTG's products.



(714) 995-3900
(800) 962-3900
(800) 972-3900 (Calif.)

10801 Dale St., Suite M-2, P.O. Box 615, Stanton, CA 90680 Telex: 887840

*Offer expires October 31, 1986 and is void where prohibited, taxed, or restricted by law. Offer redeemable only through FTG Data Systems.

Ven-Tel clears the path to 2400 baud.

Trying to install a 2400 baud modem in your PC can make you feel like you're trying to get through a maze.

With most 2400 baud modems, you'll wade through pages of documentation... only to learn that you must set dozens of parameters and reconfigure your software. Even buy all new software.

Ven-Tel 2400 baud modems eliminate the barriers. Just plug one in, and you're ready to transmit your data twice as fast. Using whatever

software you're using today.

Choose Ven-Tel 2400 baud modems in either our convenient desktop, or Half Card™ internal, versions. Each requires minimal installation and will automatically connect with 1200/300 baud modems and services. And each is available with or without X.PC error correction built-in.

Like all of our PC products, Ven-Tel 2400 baud modems are backed by a free *five-year* warranty.

No other major

manufacturer even comes close.

So when you decide to shift into high gear, do it with a Ven-Tel 2400. We give you the speed you want—without making you work for it.

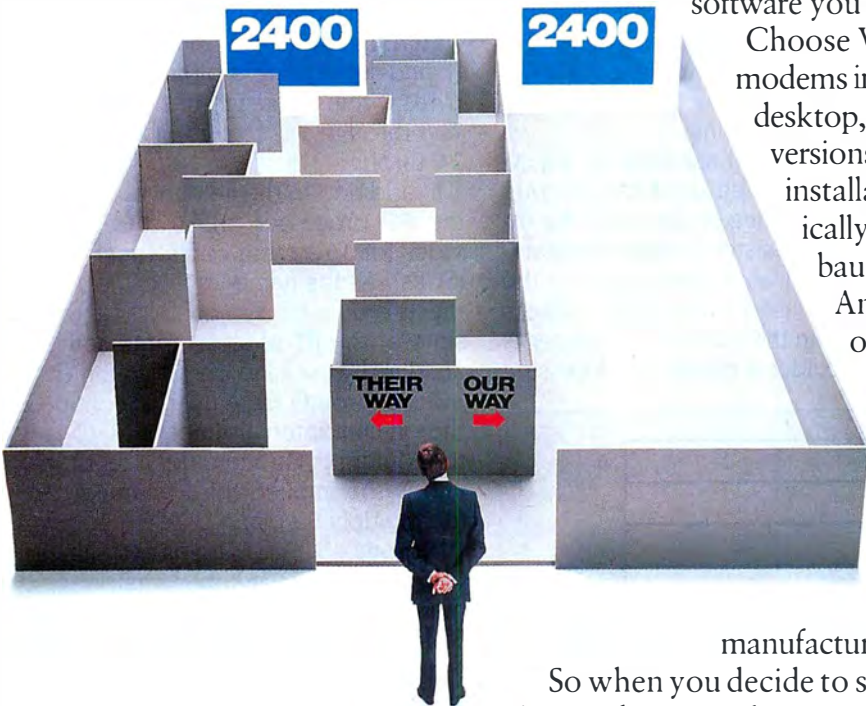

Ven-Tel

Modems

Our free 24-page booklet, "How to Select The Correct Modem," contains specific information about our full line of Ven-Tel 1200 and 2400 baud modems. To request your copy, call 800-538-5121. In California, call 408-727-5721.

instructions that load and store a series of registers were introduced. These were not needed on the 801, where a string of individual Load or Store instructions would execute at maximum speed, but they are handy on the RT processor because they allow the entire memory bandwidth to be used for transferring data.

These instructions are complex in comparison to the other single-cycle instructions. They require multiple cycles and must have the ability to handle cases in which a page fault occurs in the middle of the sequence of loads or stores. To provide for this type of instruction and allow other instructions to take multiple cycles (such as the infrequently used Divide Step), the RT processor was designed as a microcoded engine. (By contrast, the 801 was hard-wired.)

A microprogram is executed for each RT processor instruction, but for most of the instructions the microprogram is exactly one step long (most instructions take only one

cycle). The microprograms for the more complex instructions take as many cycles as necessary. Microcode is also used for such housekeeping tasks as CPU checkout and register initialization after power-on reset.

RT PROCESSOR PROGRAMMING MODEL

The RT processor registers visible to the programmer are shown in figure 1. There are sixteen 32-bit general-purpose registers, numbered 0 through 15. Bits are numbered left to right (high-order to low-order), 0 to 31. This left-to-right numbering scheme is used consistently throughout the RT processor architecture, including memory addressing.

All the general registers are equivalent and can be used for any purpose, addressing or data, with the exception of register 0. When register 0 is specified as a base register, the value 0 is used as the base address rather than the contents of register 0. This provides a means of addressing

absolute locations in low memory without requiring that a base register be loaded or that some special direct-addressing mode be provided. This use of register 0 is exactly like that of the IBM System/370.

Each register holds a 32-bit word. Arithmetic is performed using two's-complement notation on the full 32-bit register contents. There are provisions for dealing with short integers (halfwords) and single bytes, both in memory and in the general registers. Some instructions treat the upper half (bits 0 through 15) or lower half (bits 16 through 31) of a register individually, and some deal with the individual bytes within a register (bits 0 through 7, 8 through 15, 16 through 23, and 24 through 31).

In addition to the general registers, the RT processor architecture provides for 16 system control registers (SCRs). As the name implies, most of these are used for controlling the state of the RT processor, but some are directly useful to the programmer. SCRs 6 through 8 are used to control the on-chip interval timer. SCR 10 is the Multiplier/Quotient (MQ) register and is the implied third operand of the Multiply Step and Divide Step instructions. SCR 11 holds Machine Check Status, which reports hardware malfunctions, and Program Check Status, which reports exceptions such as traps, page faults, and illegal operations.

The Interrupt Request Buffer, SCR 12, controls interrupts generated directly by software. SCR 13 is the Instruction Address register (IAR), or program counter. Machine state information, such as virtual address translation on/off, privileged versus unprivileged state, and interrupts enabled/disabled, is kept in SCR 14, the Interrupt Control Status register.

The Condition Status (CS) register (SCR 15) reflects the results of arithmetic operations, comparisons, and other tests. Not all of the 16 SCRs in the architectural scheme are implemented, and of those that are, only SCRs 10 (the MQ) and 15 (the Condition Status bits) are of interest to the

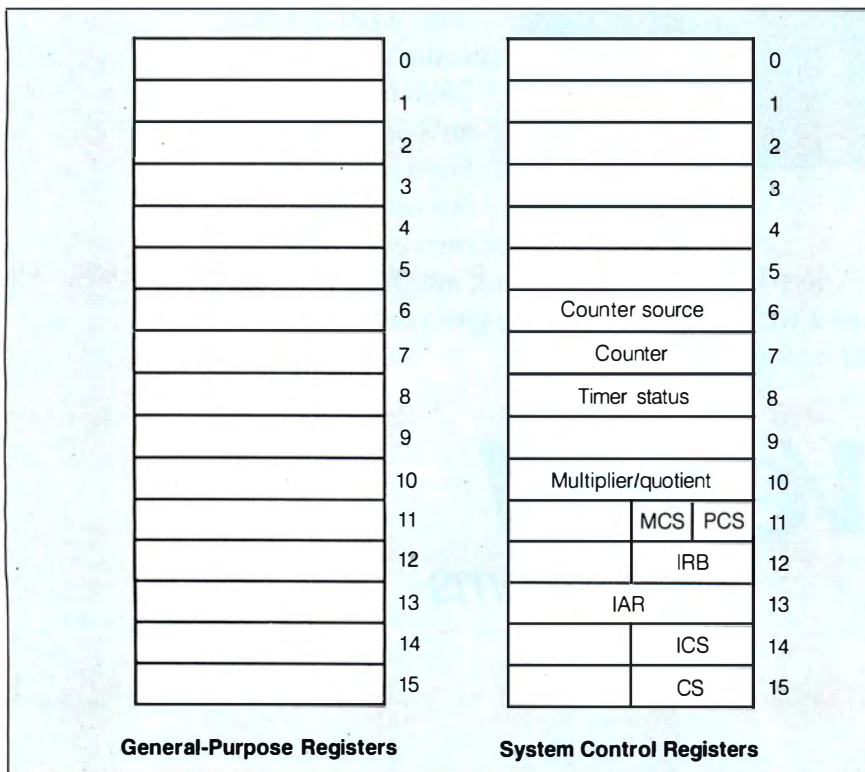

Figure 1: A model of the RT processor registers. All figures in this article are © copyright International Business Machines Corporation, 1986.

(continued)

MIX C COMPILER



C FEVER *catch it!*

It's becoming an epidemic . . . everyone is switching to C! First there were a few hackers, then came the college students, next the major software houses, and now the rest of the programming world. Programmers everywhere are infected with the desire for SPEED, POWER, and PORTABILITY.

It's time to face the inevitable. You're going to catch the fever too! When you do, give us a call. We've got the best cure—an illustrated guide to the C language, plus a complete program development system. Everything you need to master the C programming language . . . all at a price that's less than the cost of a book!

But don't let this price fool you. Our system is powerful; it compiles twice as fast as the others, is completely standard, and it's very easy to use. Most C compilers are designed for wizards. We have designed ours for you!

What do you get for a mere \$39.95?

- A 450 Page book filled with sample programs, plus . . .
- A fast, standard, full featured C compiler that supports all data types and the latest features like bit fields, enumerations, structure assignment, and passing/returning structures.
- A fast linker that loads separately compiled files, searches libraries, and builds an executable program.
- An extensive library of more than 170 functions (including the standard C functions and the computer specific functions that provide direct access to the operating system and BIOS).
- Tools that allow you to optimize your programs for minimal space or maximum speed.

Works on all MSDOS/PCDOS and all CP/M Z80 COMPUTERS! (Not Copy Protected!)



Incredible Value
\$39.95 With 30 Day
 AT ONLY
Money-Back Guarantee

Operators are standing by . . . Please use this Number for ORDERS ONLY!

CALL TOLL FREE FOR RUSH ORDER DELIVERY!

1-800-523-9520

IN TEXAS, PLEASE CALL TOLL FREE 1-800-622-4070

For Technical Support Please call 1-214-783-6001

MIX Software, Inc. / 2116 E. Arapaho / Suite 363 / Richardson, Texas 75081

Or contact our Worldwide Distributors direct in:

Canada: Saraguay Software 1-416-923-1500 Switzerland: DMB Communication CH-1-825-53-29
 Australia: Techflow 047-586924 France: Info/Tech 1-43-44-06-48

Split Screen Text Editor

an Incredible Value \$29.95 (Not Copy Protected!)
 AT ONLY Works on all MSDOS/PCDOS and CP/M Z80 Computers

Our high powered editor is great for editing high level languages. **It works just like Micropro's Wordstar**, but macros allow you to create your own custom editor, and the split-screen feature lets you edit two files at the same time.



The MSDOS/PCDOS version is loaded with special features:

- Execute any DOS command or RUN other programs from the editor.
- Quickly edit files as large as 300,000 characters.
- Compile MIX C programs directly from memory. The editor automatically positions the cursor to the first error in your program.



ASM UTILITY \$10
 an Incredible Value AT ONLY

Call assembly language routines from your C programs. The ASM utility works with Microsoft's MASM or M80 assembler. Macros make it easy! Works just as if you were calling a C function, and you can even call C functions from assembly language. Lots of useful assembly language functions are included as examples.

RUSH REPLY ORDER FORM!

SPECIAL OFFER!

Buy both for an even greater value!

SAVE \$14.95 Off Our Regular List Price!

Limited Time Only \$54.95
 C Compiler & Text Editor

Please check method of payment:

Check Money Order MasterCard/VISA

Your Card #: _____

Expires _____

Shipping Charges: (No charge for ASM Utility)

In the U.S.A.: Add \$5.00 per Order.

In CANADA: Add \$10.00 per Order.

OVERSEAS: Add \$10.00 per Text Editor.

Add \$20.00 per C Compiler. Add \$30.00 for combined C Compiler and Text Editor.

Operating System: (Check one)

CP/M Z80 MSDOS/PCDOS

Specify Your Computer Name _____

Specify Disk Format _____

NAME _____

Telephone A/C (_____) _____

Street _____

City _____

State _____

Country _____ ZIP _____

MDX software 2116 East Arapaho Suite 363 Richardson, Texas, 75081

Ask about our Volume Discounts! Call 1-214-783-6001

Description	Quantity	PRICE	Total Order
Split-Screen Text Editor	_____	\$29.95	\$_____
C Compiler	_____	\$39.95	\$_____
C and Text Editor (Special)	_____	\$54.95	\$_____
ASM Utility	_____	\$10.00	\$_____
Texas Residents Add 6.125% Sales TAX			\$_____
Shipping Charges (See at Right)			\$_____
TOTAL OF YOUR ORDER:			\$_____

application programmer. The value in the program counter (IAR) is not normally needed directly. Most branches are implicit relative to the IAR, and the value in the IAR is supplied in a general register automatically by the Branch And Link instructions.

MACHINE STATES

The RT processor has both a privileged state and an unprivileged state. All instructions are valid in privileged

state. Instructions that deal with protected SCRs or that can directly modify the machine state or the state of the virtual addressing or memory protection hardware are not allowed in unprivileged state. In either privileged or unprivileged state, the virtual addressing and memory protection mechanism can be enabled (virtual mode) or disabled (real addressing mode).

Normally, the operating system runs

all application code in unprivileged state with virtual addressing and protection turned on, while parts of the operating system itself run in real addressing mode.

When an interrupt occurs, the current state of the processor (the contents of SCRs 13, 14, and 15) is saved at a specified address in low memory. The saved data is referred to as PS, for processor status. The address at

(continued)



The word processor that Talks* to you.

- Proofread text accurately.
- For the IBM PC® and compatibles.
- Hear your keystrokes.

Part of the *work station of the future* from the verbal experts at:

Computer Conversations
 Columbus, Ohio 43202
 2350 N. Fourth Street
 (614) 263-4324



**Works with Votrax & other synthesizers*

Inquiry 67

You already own a computer that can talk.

Now let it.

Meet the Votrax Family of Voice Products.

- ★ **P.C. Dial/Log**
 Televoice management system
 Digitizes your voice
 Saves and sends voice messages
 Auto answer/Auto dial
 Call store and forward
 Message distribution
 P.C. to P.C. communication
 For IBM-PC, XT, AT and compatibles
- ★ **Votalker IB & AP**
 Board level speech synthesizers
 Unlimited vocabulary
 Text-to-speech software
 Voice mode selection switch
 Speech filter selection switch
 For IBM-PC, XT, AT and compatibles
 For Apple II, IIE, II Plus and compatibles
- ★ **SC-01 - SC-02**
 Phonetic speech synthesizer chips
 Unlimited vocabulary



- ★ **P.S.S. & T.N.T.**
 Stand-alone speech synthesizers
 Unlimited vocabulary
 Text-to-speech
 Paralle/RS-232 compatible
 Exception word table
 On-board music chip
 Adaptable to most computers
- ★ **Votalker C-64**
 Plug in speech synthesizer
 Unlimited vocabulary
 Text-to-speech
 Rate, volume and pitch control
 Three speaking modes
 Free trivia game
 For Commodore C-64/128
- ★ **Software Developers Welcome**
- ★ **Dealers and Distributors Welcome**

Now you can upgrade almost any personal computer and make it more powerful than ever, by giving it the power of speech.



1394 Rankin, Troy, Michigan 48063
 1-800-521-1350
 In Michigan 313-588-0341
 For a voice demonstration call
 313-588-2926

GET SERIOUS



...ABOUT ANALYZING YOUR DATA.

You might be spreading your spreadsheet a little too thin. Or maybe you're starting from scratch. But if you're serious about data analysis, you're ready for SPSS/PC+™ — a full software family that brings you six high-powered ways to complete any data analysis task.

Enter it. SPSS/PC+ Data Entry™ takes the effort out of entering and correcting data.

Analyze it. The SPSS/PC+ Base Package provides a powerful array of statistical and reporting procedures.

Examine it. SPSS/PC+ Advanced Statistics™ lets you get more serious with your data.

Table it. SPSS/PC+ Tables™ produces presentation-ready tables instantly.

Chart it. SPSS/PC+ Graphics™ featuring Microsoft® Chart creates show-stopping graphs and charts.

Map it. SPSS/PC+ Mapping™ featuring MAP-MASTER™ — our latest option — creates maps where vast amounts of data can be summarized and presented in one, simple picture.

SPSS/PC+ products are being put to productive use by serious fact finders in business, government and education. For countless purposes such as market research, Wage and salary studies. Survey analysis. And quality control. Plus each product is superbly documented and supported by SPSS Inc., a leader in statistical software for nearly 20 years.

So if you're serious about data analysis, step up to SPSS/PC+. For details, contact our Marketing Department.

CALL 1/312/329-3630

SPSS inc.

SPSS Inc. • 444 North Michigan Avenue, Suite 3000 • Chicago, Illinois 60611

In Europe: SPSS Europe B.V. • P.O. Box 115 • 4200 AC Gorinchem, The Netherlands • Telephone: +31183036711 • TWX: 21019

SPSS/PC+ runs on IBM PC/XT/ATs with hard disk. Contact SPSS Inc. for compatible microcomputers. SPSS/PC+, SPSS/PC+ Data Entry, SPSS/PC+ Advanced Statistics, SPSS/PC+ Tables, SPSS/PC+ Graphics and SPSS/PC+ Mapping are trademarks of SPSS Inc. for its proprietary computer software. Chart and Microsoft are trademarks of Microsoft Corporation. MAP-MASTER is a trademark of Decision Resources.

© 1986, SPSS Inc.

Table 1: *The RT processor's complete instruction set.*

LOADS, STORES

Mnemonic	Bytes	Cycles	Instruction
L	4	1-6	Load
LS	2	1-6	Load Short
LH	4	1-6	Load Half
LHS	2	1-6	Load Half Short
LHA	4	1-6	Load Half Algebraic
LHAS	2	1-6	Load Half Algebraic Short
LC	4	1-6	Load Character
LCS	2	1-6	Load Character Short
LM	4		Load Multiple
ST	4	2-6	Store
STS	2	2-6	Store Short
STH	4	2-6	Store Half
STHS	2	2-6	Store Half Short
STC	4	2-6	Store Character
STCS	2	2-6	Store Character Short
STM	4		Store Multiple
TSH	4	1-6	Test And Set Half

COMPUTATION, REGISTER TRANSFER

Mnemonic	Bytes	Cycles	Instruction
ABS	2	2	Absolute
A	2	1	Add
AI	4	1	Add Immediate
AIS	2	1	Add Immediate Short
AE	2	1	Add Extended
AEI	4	1	Add Extended Immediate
CAL	4	1	Compute Address Lower
CAL16	4	1	Compute Address Lower, 16-bit
CAS	2	1	Compute Address Short
CAU	4	1	Compute Address Upper
CA16	2	1	Compute Address, 16-bit
C	2	1	Compare
CI	4	1	Compare Immediate
CIS	2	1	Compare Immediate Short
CL	2	1	Compare Logical
CLI	4	1	Compare Logical Immediate
CLRBL	2	1	Clear Bit Lower
CLRB	2	1	Clear Bit Upper
CLZ	2	1	Count Leading Zeros
D	2	3	Divide Step
DEC	2	1	Decrement
EXTS	2	1	Extend Sign
INC	2	1	Increment
LIS	2	1	Load Immediate Short
M	2	4	Multiply Step
MC03	2	1	Move Character Zero From Three
MC13	2	1	Move Character One From Three
MC23	2	1	Move Character Two From Three
MC33	2	1	Move Character Three From Three
MC30	2	1	Move Character Three From Zero
MC31	2	1	Move Character Three From One
MC32	2	1	Move Character Three From Two

(continued)

which the PS is stored depends on the type (machine check, program check), or I/O level number, of the interrupt. A new PS is then automatically loaded from a location specific to the type or level of interrupt, and processing continues. This new PS specifies (presumably) privileged state, real addressing mode, interrupts disabled, and the address of the interrupt handling routine.

At the conclusion of an interrupt handler, the interrupted program is resumed via a Load Program Status instruction that reloads the saved PS and thus restores the original state. General registers and SCRs other than 13 through 15 are not saved automatically; such saving and restoring must be done by the interrupt handler.

INSTRUCTION SET

The term RISC applies to the RT processor more in the concept of simple one-cycle instructions than in the actual size of the instruction set. The RT processor has 118 instructions (the Berkeley RISC-1 had 31). The concept is that if a machine has a certain data flow and an ALU that can perform certain functions, then all the operations those resources can perform that are useful to the compiler are exposed as instructions. This results in some instructions that might not be the first choice in a machine designed for assembly language programming (example: shift left paired immediate plus 16), but the functions they perform are called for by the compiler often enough to warrant their inclusion.

The RT processor's 118 instructions can be divided into six major categories. There are 17 load/store variations, 73 computation and register transfer instructions, 16 branching instructions, 3 traps, 7 system control instructions, and 2 I/O instructions. The complete instruction set is listed in table 1.

There are load instructions for full-words (32 bits), halfwords (16 bits, padded on the left with 0s to 32 bits when loaded), algebraic halfwords (16 bits, sign-extended to 32 bits when

(continued)

Btrieve®

The Programmer's Choice.

Whether you're a programming pro or just beginning, there's one thing to remember when developing applications: Btrieve.

The Btrieve file manager is an alternative to all those DBMSs that promise ease of use—but deliver something far different. Like languages that take weeks to master. Performance that fizzles instead of sizzles. Programs that won't network. Of course you can write applications with these "revolutionary" packages. But someday you'll wish you hadn't.

If you know a programming language, you already have what it takes to build better applications. All you need is Btrieve.

Btrieve is the programmer's choice for file management. But you don't have to be a professional programmer to use it. With Btrieve loaded in your PC, your programs can use simple subroutine calls to retrieve, store and update records.

Btrieve has built-in security features and the ability to handle four billion byte files. And there are no royalties on Btrieve applications.



SoftCraft

P.O. Box 9802 #917
Austin, Texas 78766
(512) 346-8380 Telex 358 200

Suggested retail prices: Btrieve, \$245; multi-user Btrieve, \$595; Xtrieve, \$245; multi-user Xtrieve, \$595 (for report generation, add \$145 single-user and \$345 multi-user). Available from SoftCraft and selected distributors. Requires PC-DOS or MS-DOS 2.X, 3.X, Xenix. Btrieve is a registered trademark and Xtrieve is a trademark of SoftCraft Inc.

Inquiry 257

Multi-user versions for LANs and Xenix.

When your applications need to connect you to the industry's most popular LANs: IBM PC Network, Novell Advanced Netware, or any DOS 3 network. Btrieve is also available for Xenix and multitasking operating systems such as MultiLink Advanced, Microsoft Windows and IBM Topview.

Help is just a phone call away. Need technical support? You've got it! Btrieve users receive 30 days of unlimited phone support at no charge. This "Direct Connect" policy is renewable for a full year at low cost. And try SoftCraft's free bulletin board for technical tips, seven days a week.



Thorough documentation, easy implementation. Getting started with Btrieve is easy: the manual is packed with step-by-step instructions and examples of every Btrieve function in BASIC, Pascal, COBOL and C.

B-tree based for high performance. Performance is all-important, especially as your database grows. That's why Btrieve implements the b-tree file structure—the most efficient data access method known. With Btrieve your applications run fast.

Database queries, report writing. Add Xtrieve™ to your Btrieve applications for a fully-relational DBMS. Xtrieve's menu-driven interface lets you look up information easily—without programming. Add our report writer option to produce custom reports and forms.



Interfaces to C, BASIC, Pascal, COBOL. Don't waste time learning a proprietary language! With Btrieve you can use the language you know best—and immediately begin programming the right way. Over 15 language interfaces are available.



Fault tolerant. Btrieve insures against database disasters. Two levels of fault tolerance guarantee data integrity during accidents or power failures—no extra programming required.

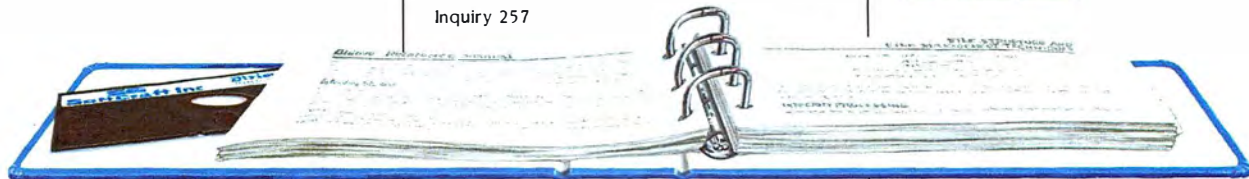

Mnemonic	Bytes	Cycles	Instruction
MFTB	2	1	Move From Test Bit
MFTBIL	2	1	Move From Test Bit Immediate Lower
MFTBIU	2	1	Move From Test Bit Immediate Upper
MTTB	2	1	Move To Test Bit
MTTBIL	2	1	Move To Test Bit Immediate Lower
MTTBIU	2	1	Move To Test Bit Immediate Upper
N	2	1	AND
NILO	4	1	AND Immediate Lower Extended Ones
NILZ	4	1	AND Immediate Lower Extended Zeros
NIUO	4	1	AND Immediate Upper Extended Ones
NIUZ	4	1	AND Immediate Upper Extended Zeros
O	2	1	OR
OIL	4	1	OR Immediate Lower
OIU	4	1	OR Immediate Upper
ONEC	2	1	One's Complement
S	2	1	Subtract
SIS	2	1	Subtract Immediate Short
SE	2	1	Subtract Extended
SF	2	1	Subtract From
SFI	4	1	Subtract From Immediate
SETBL	2	1	Set Bit Lower
SETBU	2	1	Set Bit Upper
SL	2	1	Shift Left
SLI	2	1	Shift Left Immediate
SLI16	2	1	Shift Left Immediate Plus 16
SLP	2	1	Shift Left Paired
SLPI	2	1	Shift Left Paired Immediate
SLPI16	2	1	Shift Left Paired Immediate Plus 16
SR	2	1	Shift Right
SRI	2	1	Shift Right Immediate
SRI16	2	1	Shift Right Immediate Plus 16
SRP	2	1	Shift Right Paired
SRPI	2	1	Shift Right Paired Immediate
SRPI16	2	1	Shift Right Paired Immediate Plus 16
SAR	2	1	Shift Algebraic Right
SARI	2	1	Shift Algebraic Right Immediate
SARI16	2	1	Shift Algebraic Right Immediate Plus 16
TWOC	2	1	Two's Complement
X	2	1	Exclusive-OR
XIL	4	1	Exclusive-OR Immediate Lower
XIU	4	1	Exclusive-OR Immediate Upper
BRANCHING			
Mnemonic	Bytes	Cycles	Instruction
BALA	4	5-7	Branch And Link Absolute
BALAX	4	5-7	Branch And Link Absolute With Execute
BALI	4	5-7	Branch And Link Immediate
BALIX	4	5-7	Branch And Link Immediate With Execute
BALR	2	5-7	Branch And Link Register
BALRX	2	5-7	Branch And Link Register With Execute
BB	4	*	Branch On Condition Bit Immediate
BBX	4	*	Branch On Condition Bit Immediate With Execute
BNB	4	*	Branch On Not Condition Bit Immediate
BNBX	4	*	Branch On Not Condition Bit Immediate With Execute
BBR	2	*	Branch On Condition Bit Register
BBRX	2	*	Branch On Condition Bit Register With Execute

(continued)

loaded), and bytes (8 bits, padded on the left with 0s to 32 bits when loaded). A Load Multiple instruction loads from 1 to 16 registers from consecutive words in memory. For each of these there is a corresponding store instruction.

Simple base-register plus constant-displacement addressing modes are provided. More complex modes (base plus index register, for example) are constructed by the compiler from the primitive instructions. The 73 computational instructions include all of the ordinary integer arithmetic, logical, and shift instructions, plus a group of address computation and register transfer instructions.

In general, the arithmetic instructions set the Condition Status bits according to their result, while the address computation instructions do not. In some cases the only difference between an arithmetic instruction (Add, Add Immediate) and an address computation instruction (Compute Address, Increment) is whether the Condition Status is affected. This gives the compiler more freedom to rearrange and optimize computations.

There are two classes of conditional branches: jumps, which are 2-byte branches, relative to the contents of the IAR; and branches, which are generally 4 bytes and can be either branch absolute, branch relative (to the IAR), or branch register (via an address in a register). The branches have a traditional form and a delayed-branch form, which is referred to as Branch With Execute. Conditional branches, or jumps, test the value of one of the bits in the Condition Status register. Unconditional branches are done by testing a particular bit in the CS register that is permanently zero. Subroutines are called using Branch And Link instructions that place the address of the instruction following the branch in a general register. Subroutine returns are via a Branch Register instruction that branches to the address saved by the call.

The trap instructions provide an efficient way to test array indexes, case-statement values, and the like, against

(continued)

THIRD GENERATION PROGRAMMERS FROM GTEK

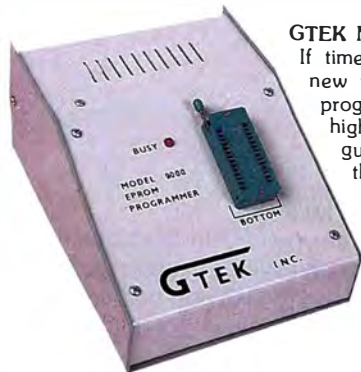

GTEK MODEL 9000 (E)EPROM/MPU PROGRAMMER
If time is money, then let us save some for you. The new model 9000, using its quick pulse algorithms, can program a 2764 in 10 seconds. The 9000 offers higher performance than the competition has even begun to think about. Baud rates to 57,600. Supports thru 1024K standard, 8 meg worldwide parts with adapter, Cypress proms, mpu's. NO personality modules. As with our other programmers, RS-232, ASCII data formats, and flexible handshaking make the model 9000 compatible with virtually any computer. Introductory price \$749.

MODEL 7228 (E)EPROM/MPU PROGRAMMER The standard by which other other programmers are judged. With thousands in the field, the time proven 7228 has become our most popular programmer. Intelligent algorithms standard. Programs a 2764 in one minute. Supports devices thru 512K, mpu's, eeproms, cmos. NO personality modules. Price \$599



MODEL 7956 GANG (E)EPROM/MPU PROGRAMMER

The 7956 can program eight 2764's in one minute using intelligent algorithms. Standard support thru 512K, eeproms, cmos, mpu's. A must for production environments. Available in stand alone only configuration for \$979 or with RS-232 interface for \$1099

MODEL 7128 (E)EPROM/MPU PROGRAMMER The programmer that won't die. Thousands manufactured since 1982. Supports thru 256K. **PRICE REDUCED** to \$389 including free PGX communications software, a \$95 value.

MODEL 705 Motorola 68705 family programmer. Transfers object code to 28 and 40 pin mpu's. Single key stroke operation. \$299

MODEL 7324 PAL PROGRAMMER The 7324 has a built-in compiler. It supports 20 and 24 pin pals by MMI, NATIONAL, and TI, including the new shared product parts 20S10, 20RS10, 20RS8, 20RS4. It operates stand alone or via RS-232 with PALX communications package. Functionally tests parts after programming and securing. External compilers are supported thru JEDEC and AHS object formats. \$1499

MODEL 7322 Same as 7324 but no stand alone capability. \$1249

UTILITY PACKAGES

PGMX High Speed Communications Package. For IBM PC, AT and compatibles. Bi-directional data rates to a scorching 57600 bps. Provides flexible manipulation of Intel Hex files, both 8 and 16 bit formats, and binary files. Use with model 9000. \$149

PGX Utility Package. For PCDOS, CPM, TRSDOS, ISIS, MSDOS. Use with 9000, 7956, 7228, 7128. \$95

PALX Utility Package. Provides communication, download of Palasm source, JEDEC and AHS object files to models 7324, 7322, 7316 pal programmers. \$95

CROSSASSEMBLERS and SIMULATORS

You name the cpu, we've got the assembler. Simulators allow target software development and testing on your computer. Versions available for PCDOS, MSDOS, CPM. . Start at \$250

ERASERS—We stock both Ultra Violet Products and Spectronics for your selection.

MODEL	CHIPS	TIMER	LAMP	PRICE
DE4	8	N	Tube	\$80
PE14T	9	Y	Tube	\$139
C25	25	Y	Grid	\$350
C50	50	Y	Grid	\$600

ACCESSORIES

CABLES—serial	\$30, parallel	\$30, custom	Call For Quote
MODEL 481/482/483	8048 family adapters		\$98
MODEL 511/512	8051 family adapter		\$174
MODEL 755/756	8755 adapter		\$135

SPECIAL REQUIREMENTS? Call Us For A Quote On Custom OEM Programmers.

Run CPM Software on Your IBM or IBM Compatible



Call GTEK's CPM Hotline 1-601-467-9019

If you are a CPM user who wants to convert to MSDOS or PCDOS or a PC user who would like access to the thousands of CPM programs in existence, here is the perfect solution to the problem: CPMulator from GTEK. CPMulator is the only field proven emulator which emulates the complete Z-80 instruction set. Terminal attribute emulation is Televideo, Lear Siegler, or the ANSI standard. CPM .COM programs reside under PCDOS and are executable under PCDOS as well as 8086 programs.

Comes complete with COPYCPM, a disk conversion utility which allows transferring data and programs to and from 54 different CPM disk formats. Free CPM utility programs are also included.

For speed use the 8080 CPMulator along with the NEC V20 or V30 chip.

PRICE REDUCED

Z80 CPMulator, DR5PC-EMZ80 . . .	\$ 99.00
8080 CPMulator, DR5PC-EMV205 \$	99.00*
Z80, 8080 CPMulator, DR5PC-EMZV205	\$149.00*
*Requires NEC V20 or V30.	
NEC V20 (5Mhz)	\$ 12.00

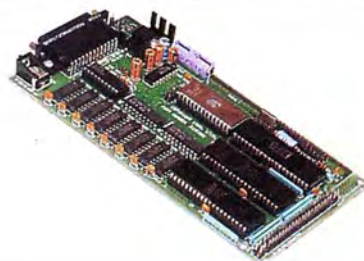

Single Board Computer Model 2010

- 64 to 256K bytes data or program ram.
- Use 2764 or 27512 eeprom or eeprom program memory.
- Uses single ended 9V @ 500 ma supply.
- Use 8031, 8032, 8751, 8752 mpu.
- 40 bit programmable I/O lines.
- Expansion interface connector.
- Baud rates to 57,600 baud.
- Built in 5 volt regulator.
- Built in rom monitor.
- Small — 3.5 x 7 inches.
- 8052AH basic option.

ONLY \$299.00 WITH MANUAL

MODEL 8014 PRINTER BUFFER/SWITCH OK is \$99, 128K is \$339, and 256K is \$399



Development Hardware & Software
P.O. Box 1346, Bay St. Louis, MS 39520 U.S.A.
(601) 467-8048; TELEX 315814 (GTEK UD), INC.

GTEK, PALASM, CPM, MS-DOS, PC-DOS, ISIS, TRSDOS, & CPEmulator are registered trademarks.

Mnemonic	Bytes	Cycles	Instruction
BNBR	2	*	Branch On Not Condition Bit Register
BNBRX	2	*	Branch On Not Condition Bit Register With Execute
JB	2	*	Jump On Condition Bit
JNB	2	*	Jump On Not Condition Bit
* Conditional branches and jumps take 1 cycle if unsuccessful (fall through) 5-7 cycles if successful			
TRAPS			
Mnemonic	Bytes	Cycles	Instruction
TGTE	2	2	Trap If Register Greater Than Or Equal
TLT	2	2	Trap If Register Less Than
TI	4	2	Trap On Condition Immediate
SYSTEM CONTROL			
Mnemonic	Bytes	Cycles	Instruction
LPS	4	12-16	Load Program Status
CLRSB	2	4	Clear SCR Bit
MFS	2	2	Move From SCR
MTS	2	3	Move To SCR
SETSB	2	4	Set SCR Bit
SVC	2	16-20	Supervisor Call
WAIT	2		Wait
INPUT/OUTPUT			
Mnemonic	Bytes	Cycles	Instruction
IOR	4	1	Input/Output Read
IOW	4	2	Input/Output Write

upper and lower bounds. Such instructions perform a logical (unsigned) comparison of a register against an immediate value, or against another register, and cause an interrupt if the specified trap condition "springs."

For arrays with a lower bound of zero, a single trap instruction will catch positive indexes greater than the upper bound and all negative indexes (negative values appear to be large positive values in unsigned comparisons). For nonzero lower bounds an additional add or subtract instruction must precede the trap. The compiler subjects such trap code to the same optimizations as all the rest of a program's computations. As a result,

bounds checking for a language like Pascal can be done very efficiently.

The system control instructions perform low-level hardware operations, such as resetting interrupt requests, manipulating the contents of the privileged SCRs, and loading new program status. One system control instruction, Supervisor Call (SVC), is provided for use by unprivileged state code, to switch to privileged state in a controlled manner. SVC causes an interrupt and passes a 16-bit code to the Supervisor Call Interrupt Handler; the operating system then interprets the code as a request for some specified service, performs the requested action, and resumes the pro-

gram via Load PS.

There are two I/O instructions that transfer 32-bit values between general registers and the I/O bus, but most I/O is memory-mapped and is done using the normal Load and Store instructions. Control of the address translation hardware in the MMU is done by privileged state programs using the I/O instructions directly.

BASIC DATA TYPES

The fundamental unit of memory is the 32-bit word, and all memory operations involve 32-bit words. The words are further subdivided into halfwords and bytes. Memory is addressed by byte address, and words and halfwords are required to be on appropriate boundaries. That is, a word address must be a multiple of four, and a halfword address must be a multiple of two. Such alignment requirements make for faster execution and simplify the handling of page faults.

Loading a 4-byte word that crosses a word boundary would require two memory operations rather than one, while the corresponding Store would require two read-modify-write cycles rather than one simple write. If such a misaligned word also crosses a page boundary, then it's possible that a page fault or protection exception could occur partway through a memory operation. Such complexities are handled for Load Multiple and Store Multiple, but they are not warranted for the very heavily used Load and Store instructions.

Signed two's-complement integers can occupy words or halfwords. These halfwords will be sign-extended to fullword quantities when loaded into a general register. Individual bytes can also be loaded and stored but when loaded are extended on the left with 24 zero bits. Thus bytes can naturally hold small unsigned integers as well as characters.

Individual bits cannot be addressed in memory directly but can be manipulated in the general registers once a byte, halfword, or fullword has been loaded. In addition to the normal complement of logical and shift in-

(continued)

TANDY® Better Again™

The New Tandy 3000 HL

Four times the power
of the IBM® PC/XT
...for less.

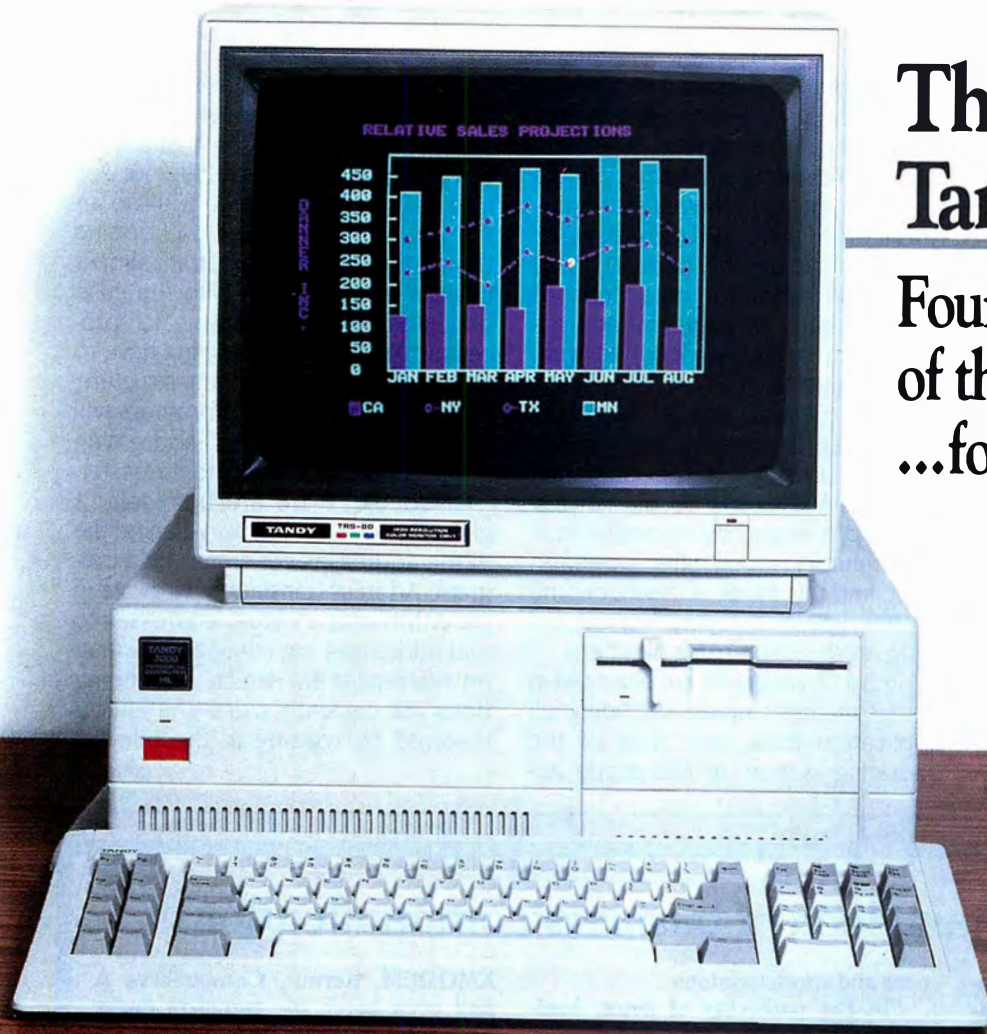

The Tandy 3000 HL isn't just compatible with IBM's PC/XT—it's better. Better because of its new 16-bit microprocessor that lets you process twice the data of IBM's older, 8-bit design. Better because it has nearly twice the clock speed of the PC/XT.

Better because you get more for less: only \$1699.

The Tandy 3000 HL's 512K RAM lets you run the software that you've grown accustomed to—at a much higher speed for greater efficiency. And you can expand with hard disk drives, modems, and more.

The high power and low price of the Tandy 3000 HL make it perfect for offices requiring several workstations. And the ViaNet local area network can bring your 3000 HLs together with your existing MS-DOS based computers. Users and departments can be more efficient.

Plus, the American-made Tandy 3000 HL is backed with total support, including our leasing, service and training plans.

Get the facts today, and you'll agree: the Tandy 3000 HL (25-4070) is your basic building block for total office automation.

Available at over 1200
Radio Shack Computer Centers and at
participating Radio Shack stores and dealers.

Radio Shack®
COMPUTER CENTERS
A DIVISION OF TANDY CORPORATION

Send me an RSC-17 Computer Catalog.

Mail To: Radio Shack, Dept. 87-A-976
300 One Tandy Center, Fort Worth, TX 76102

Name _____

Company _____

Address _____

City _____

State _____ ZIP _____

Phone _____

Price applies at Radio Shack Computer Centers and participating stores and dealers. Monitor sold separately. IBM/Registered TM International Business Machines Corp. MS-DOS / Registered TM Microsoft Corp. ViaNet/TM ViaNetix, Inc.

structions, there are two instructions (Move To Test Bit, Move From Test Bit) that allow individual bits to be moved between registers or into the Condition Status register and thus affect a conditional branch directly.

Quantities larger than fullwords, such as character strings, are not operated on directly by the RT processor hardware but are treated as sequences of words or bytes. Character strings do not normally have any boundary alignment requirements.

Floating-point quantities handled by the IBM RT Personal Computer's floating-point unit have alignment restrictions as required by the floating-point hardware. Floating-point values are not processed directly by the RT processor.

MEMORY MODEL

The RT processor's memory model is extremely simple, and intentionally

so. Memory is addressed at the byte level, with bytes numbered from left to right. Any quantity (byte, halfword, fullword) loaded from memory into a register appears in the register exactly as it did in memory; bytes are never reversed. The memory address of any instruction, primitive data item, or data structure is always the address of its leftmost (high-order) byte, without exception.

In real memory mode, addresses are treated as byte numbers in the range of 0 to $2^{24}-1$. The maximum real memory size is 16 megabytes. The RT processor begins execution in real memory mode after power-on reset, and this mode is used by some of the low-level operating system code, such as interrupt handlers.

Almost all programs are executed in virtual memory mode, including all application code and most of the operating system. In this mode ad-

resses are again simply byte numbers, but with an extended range: 0 to $2^{32}-1$, thus spanning 4 gigabytes.

A program sees virtual memory as a large, linear byte-space with no arbitrary boundaries or overlapping segments. This is an important simplification and contributes to the ease of generating code for the RT processor. The compiler doesn't have to worry about whether a data structure, a stack frame, or even a program will fit within some restricted addressing range covered by a segment register.

Of course, there are not really 4 gigabytes of main memory behind the 32-bit addresses generated by a program. Address translation hardware in the MMU maps virtual addresses to real addresses, signaling a page fault on references for which a mapping does not currently exist. The fault is resolved by reading in the relevant

(continued)

MEX-PC: the chameleon of business communications!

Under never ending deadline pressures, a major metropolitan newspaper's greatest challenge is to achieve lightning speed without compromising quality. Personal computers can help meet that challenge — but only if the software is easy to learn and simple to use.

Enter **MEX-PC**, the Modem EXecutive for Personal Computers.

Thanks to its dynamic script file processor — virtually a complete, internal programming language — **MEX-PC** allows turnkey systems developers to build fully automated, custom communications applications, either stand-alone or integrated, and completely transparent to users.

"When a reporter or editor chooses the Communications Menu from our database's Main Menu, he doesn't even know he's leaving the database management system and entering a modem program," reports TRF Media Systems, which has integrated **MEX-PC** into several of its database designs for newspaper busi-

ness and sports sections.

"In the gathering of news, business sections often send and receive financial data to and from a wide variety of sources — each of which uses different parameters, protocols, baud rates, log-on sequences, etc. If we used a typical modem software, it would take newspapers months to teach every staff member how to get data from each individual source, crunch the numbers and send it to the editing system.

"With **MEX**, they just choose a data source from the menu. The software does all the rest ...

"**MEX** is a marvelous tool for integrated systems development."

In addition to the most powerful ASCII text-capture and text-send capabilities available anywhere, **MEX-PC** provides full implementation of such popular protocols as

XMODEM, **Kermit**, **CompuServe A** and even batch file transfers under **Ymodem** and **Modem 7**. Plus, it easily can be installed to drive all popular modems — regardless of Hayes compatibility — or for high-speed direct serial links.

That kind of flexibility — coupled with sophisticated terminal emulation, remote capabilities and competitive site licensing — is quickly making **MEX-PC** the standard for integrating communications into software systems developed under **MS-DOS**, **TurboDos** and **CP/M** operating systems.

If efficient communications interfaces are important to your system design, discover what smart developers and MIS managers everywhere already know: When it comes to custom data communications applications, the only choice is **MEX-PC**.

For a copy of our free brochure describing **MEX-PC** or for answers to questions about site licensing, call 1-800-NITEOWL (414-563-4013 in Wisconsin) or write NightOwl Software, Route 1, Box 7, Fort Atkinson, WI 53538. Dealer inquiries welcome.



Now Available!

FIVE NEW MODELS

SHARE PRINTERS AND BUFFER PRINT JOBS WITH ONE VERSATILE UNIT

Print Master from BayTech is an intelligent printer controller that connects between your computers and printers. It allows you to share one printer automatically, contend for multiple printers automatically, or switch between several printers by sending a simple code, not by changing cables. Plus, Print Master's generous built-in buffer spools data until your printers can receive it.

Because Print Master is a very flexible device, you can set it up to fit your application, even if your application changes.

YOU SET UP THE IN-OUT PORTS

You configure Print Master's ports for any combination of printers and computers by answering questions from easy-to-follow menus. For example, with the ten port Print Master, nine computers can share one printer, eight computers can share two printers, seven computers can share three printers, and so on, to one computer which can share nine printers. You can also menu-select the disconnect time-out, form feeds, etc. and on serial models, the configuration of individual ports to translate for printers and computers using different configurations.

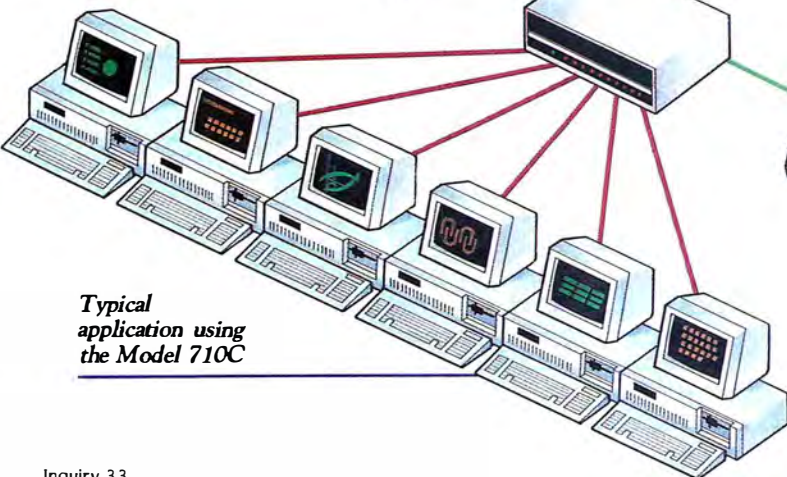

Typical application using the Model 710C

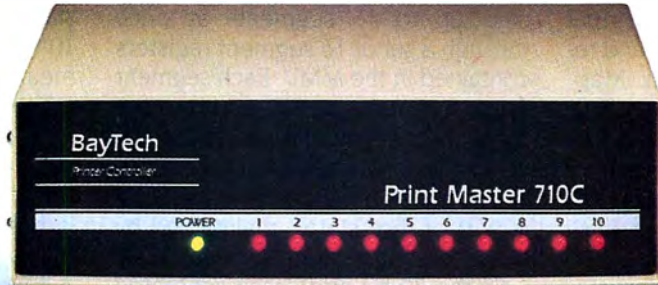

512K OR ONE MEGABYTE BUFFER KEEPS YOU WORKING INSTEAD OF WAITING

Since Print Master can accept data faster than your printer (up to 19.2KB serial or 5,000 characters per second parallel), you can send a print job to Print Master's standard 512K buffer and then go on to another project. All users connected to this common pool buffer, and they can be doing it simultaneously, even if no printer is available. Data is stored in the buffer until it can

be sent on a first-job-in first-job-out basis to the selected printer. If you need more memory than 512K, Print Master is optionally available with one megabyte buffer.

If several users are sharing one printer, printer sharing via Print Master is completely automatic. There are no codes to send. You simply perform your normal print operation. If you are sharing several identical printers, connection is also

automatic. Again, you perform your normal print operation and are connected to the next available printer on a first-come-first-serve basis. Print Master will send data to all printers simultaneously to keep your printers running at full capacity.

If you are sharing several different printers, such as a laser-jet, a dot matrix and a plotter, and you wish to select a specific printer, you do your normal print routine and also send a printer select code (which you can define yourself) before the first characters of your data. The data is then routed to the selected printer. It's that easy.

PARALLEL, RS-232C OR RS-422A MODELS

706A (6 parallel ports), \$795
706C (6 serial ports), \$795
708C (8 serial ports), \$895
710C (10 serial ports), \$995
706D (4 parallel/2 serial), \$795
708D (6 parallel/2 serial), \$895
706E (4 serial/2 parallel), \$795
708E (6 serial/2 parallel), \$895
710E (8 serial/2 parallel), \$995
708F (4 serial/4 parallel), \$895
710F (6 serial/4 parallel), \$995
All above models have standard 512K buffers.
Additional 500K buffer, \$249
RS422A for distances up to 4,000 feet now available on some models.

WANT DETAILS?

Call or write BayTech at P.O. Box 387, Highway 603, Bay Saint Louis, Mississippi 39520, USA. Telex 910-333-1618. Phone 601-467-8231 or

800-523-2702



BAY TECHNICAL ASSOCIATES, INC.
DATA COMMUNICATIONS PRODUCTS

page from disk or creating an empty page on first reference (perhaps first writing out some other page to make room in memory), updating the virtual address mapping information, and restarting the faulting program. Mapping is done on a per-page basis, with page sizes of either 2K bytes or 4K bytes. Page size is fixed at system initialization (the operating system for the IBM RT PC uses 2K-byte pages).

Virtual memory is organized into large segments, and each segment is composed of a collection of pages (see figure 2). Segment sizes can range up to 2^{28} bytes, or 256 megabytes. The pages of a segment are related in some way. A segment may make up a file in the file system, it may be all the computational (local) memory of a running program, or it may be all the executable code loaded for a particular task.

Each segment in active use is assigned a 12-bit number called a segment ID, or SID. A program can access up to 16 segments at once through a set of 16 segment registers contained in the MMU. Each segment register contains an SID, and the contents of the segment registers (i.e., the collection of names of segments to which a task has been given access) is part of the "state," maintained by the operating system, for each task.

Of the 32-bit addresses generated by a program, bits 0 through 3 (the high-order 4 bits) select one of the segment registers (0 through 15), and bits 4 through 31 specify an offset within the segment. Address translation is performed on the combination of the 12-bit SID from the selected segment register and the 28-bit offset. A 40-bit virtual address is formed by concatenating the SID and the offset.

The virtual addressing range is therefore 2^{40} bytes, or 1 terabyte (one terabyte = 1024 gigabytes; tera- is the standard prefix denoting a factor of 10^{12} , from the Greek *teras*, which means "monster").

The loading of the segment registers is restricted to privileged state programs, but via an SVC an application can cause any segment, to which it has been granted access, to be mapped using any segment register. A task may access many more than 16 segments by reloading the segment registers. Segments can be shared among tasks merely by loading the same SID value into a segment register for each task. Since the translation is done on the 40-bit address rather than the 32-bit address, it does not matter that a shared segment is mapped using, say, segment

(continued)

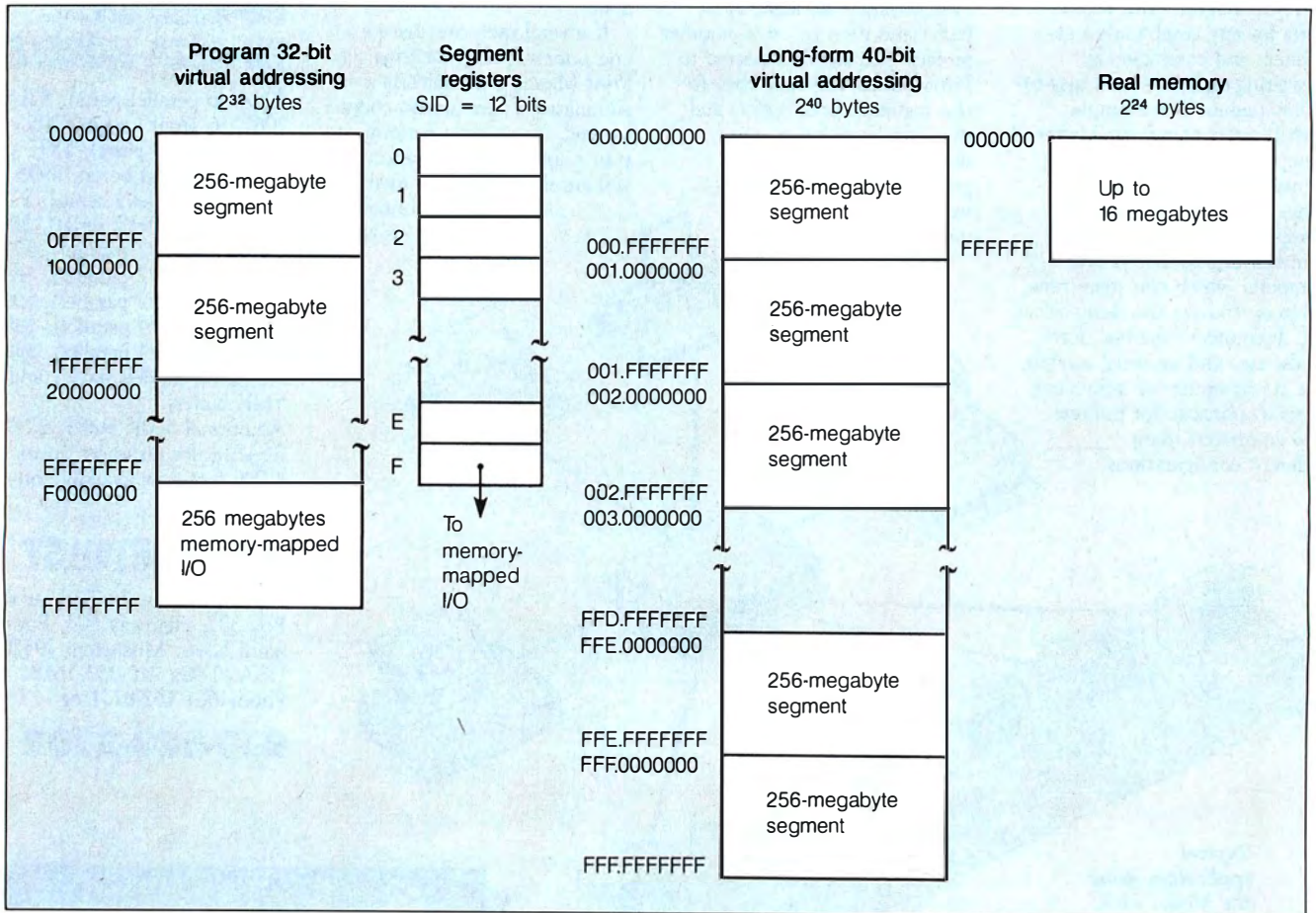

Figure 2: A model of RT processor memory addressing.

Mark Williams

Now the biggest name
in C compilers comes in a size
everybody can afford.

Let's C.[™]
\$75

Introducing Mark Williams' \$75 C compiler. Want to explore C programming for the first time? Or just on your own time? Now you can do it in a big way without spending that way. With Let's C.

This is no little beginner's model. Let's C is a powerful programming tool, packed with all the essentials of the famous Mark Williams C Programming System. The one chosen by Intel, DEC, Wang and thousands of professional programmers. The one that wins the benchmarks and the reviewers' praise:

Mark Williams Let's C

- For the IBM-PC and MS-DOS
- Fast compact code plus register variables
- Full Kernighan & Ritchie C and extensions
- Full UNIX[™] compatibility and complete libraries
- Small memory model
- Many powerful utilities including linker, assembler, archiver, cc one-step compiling, egrep, pr, tail, wc
- MicroEMACS full screen editor with source
- Supported by dozens of third party libraries
- Upgradeable to C Programming System for large scale applications development

Let's C Benchmark Done on an IBM-PC/XT, no 8087.
Program: Floating Point from BYTE, August, 1983.

Exec Time in Seconds

Let's C	134.20
MS 3.0	347.45

"Let's C is a thoroughly professional C environment loaded with tools and programming utilities. It is also another fine Mark Williams Co. product."
—Christopher Skelly, Computer Language Magazine, Feb. 1986

And now for more big news. Get our revolutionary csd C Source

Debugger for just \$75, too. You can breeze through debugging at the C source level ignoring clunky assembler code.

Affordable, powerful, debuggable. Mark Williams Let's C is the big name C compiler at a price you can handle. Get your hands on it now.

Use this coupon or charge by calling toll-free:
1-800-MWC-1700. In Ill. call 312-472-6659.

Mark Williams Let's C

Please send me:

_____ copies of Let's C and _____ copies of csd (C Source Debugger) at \$75 each. (Ill. residents add 7% sales tax.)

Check Money Order Visa, MasterCard or American Express

Name _____

Address _____

_____ State _____ Zip _____

Card # _____ Exp. Date _____

Signature _____ BYIBM

 **Mark Williams Company**

1430 West Wrightwood
Chicago, Illinois 60614

Try It. Then Buy It. PC-Write.™

A fast, full-featured word processing package for only \$16. Complete. You get a quick reference guide and tutorial on disk, 45 help screens, choice of function keys or menus, mail merge, spelling check, advanced formatting, and support for over 350 printers including the HP LaserJet Plus.

Try *PC-Write* for only \$16. Then register for \$89 to get:

- o Latest diskette pair
- o Hardbound manual
- o Two updates
- o Phone support
- o Newsletter

Plus, your registration fee supports our development of new *PC-Write* features.

Shareware means you can freely copy and share the *PC-Write* diskette.

Register only if you decide to use it. No risk!

Byte
IBM Issue

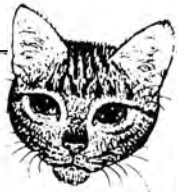

Now? Version 2.7

with built-in spelling checker, checks spelling as you type or afterward, guesses correct word. [We wrote this ad in August, and we expect 2.7 is ready now.]

**Order *PC-Write* Today.
Satisfaction Guaranteed.**

Quicksilver™

(206) 282-0452

219 First N. #224y
Seattle, WA 98109



Table 2: Protection conditions associated with a virtual page.

Page Key	Type of Page	SR Key	Load	Store
00	Key 0 fetch-protected	0	Yes	Yes
		1	No	No
01	Key 0 read/write	0	Yes	Yes
		1	Yes	No
10	Public read/write	0	Yes	Yes
		1	Yes	Yes
11	Public read-only	0	Yes	No
		1	Yes	No

register 12 in one task and segment register 7 in another, as long as both tasks use the same SID.

For each segment, one of two types of memory protection can be specified. A bit in each segment register tells whether the associated segment is normal or special. For normal segments, protection is at the page level. Access rights to each page can be specified as read/write, read-only, or no-access, depending on a segment-key bit in the segment register and two page-key bits in the page table entry. Operating system programs normally run with the segment-key bit = 0, while applications run with the segment-key bit = 1. (Table 2 shows the various protection conditions associated with a virtual page.)

A finer-grained type of protection is available for special segments. Pages of special segments are divided into 16 "lines" of 128 bytes each (for 2K-byte pages) or 256 bytes each (for 4K-byte pages). Read-only or read/write access can be granted on an individual "line" basis, per task.

This type of protection is intended for use by sets of tasks that share a data segment and that need hardware assistance in controlling access to shared data items smaller than a page. Special segments require more effort on the part of the operating system because more manipulation of the page table is involved.

THE MEMORY MANAGEMENT UNIT

The MMU performs the address translation and memory protection opera-

tions described above. It is the "physical memory" controller for the RT processor as well. All requests for memory read or write go through the MMU, including requests from the RT processor proper and from direct memory access I/O devices. Each request is distinguished (by a control line during the bus transfer) as real, which requires no translation, or virtual, which requires translation and memory protection checking.

SEGMENT REGISTERS

The 16 segment registers described in the memory model reside in the MMU. Address and data transfers to and from the MMU are 32 bits wide. The 32-bit virtual addresses are expanded to 40 bits in the MMU by stripping off bits 0 through 3 and using them to select one of the segment registers. The resulting 40-bit address is then translated to real, and the real address is used to drive the memory arrays. The contents of the segment registers can be read and written by the operating system using the RT processor's I/O instructions.

INVERTED PAGE TABLE

Conceptually, address translation is performed by looking up the virtual page number (the high-order bits of the 40-bit virtual address) in a table, finding the associated real page number, and substituting the real value for the virtual one. Since the pages are fixed in size (all 2K bytes or all 4K bytes) and must reside in memory on a boundary that is a

(continued)

TEST OF STRENGTH:

PC/FOCUS gives Micro Managers the muscle for future growth and expansion.

Frankly, there are many capable DBMS's available in today's PC marketplace.

But only PC/FOCUS has the extra capabilities you need to support your growth and expansion. Decision support capabilities like business graphics, statistical analysis and spreadsheet. Application portability to VAX/VMS, WANG/VS, AT&T UNIX and IBM mainframe environments. Even built-in micro-to-mainframe links for data transfer!

So when you select your PC DBMS, make sure it's the one that "rings the bell!" PC/FOCUS.

For details, call the IBI office nearest you or write to Donald Wszolek, Dept. 110, Information Builders, Inc., 1250 Broadway, New York NY 10001.

PC/FOCUS

Information Builders, Inc.

World Headquarters: New York City, U.S.A., (212) 736-4433
Toronto, Canada: (416) 364-2760 • London, England: 903-6111

One language. One solution.

Inquiry 139

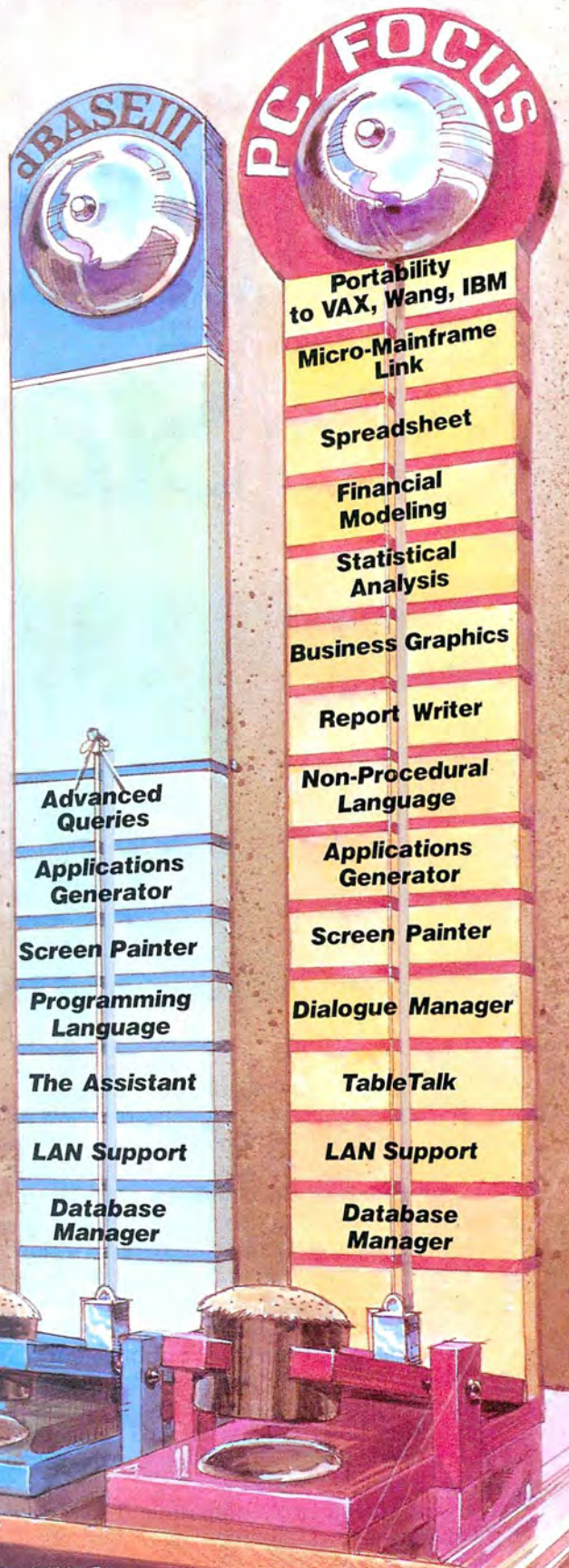

dBase III is a trademark of Ashton-Tate.
AT&T UNIX is a trademark of AT&T Corp.
WANG/VS is a trademark of Wang Laboratories, Inc.
VAX/VMS is a trademark of Digital Equipment Corp.
IBM is a trademark of International Business Machines Corp.

AST Sets The Multifunction Standard.

MULTIFUNCTION PRODUCTS

SIXPAKPLUS

Single-Slot Multifunction Enhancement Product for the IBM PC, XT and IBM PC-Compatibles

Offering up to 384Kb of Memory, with a Serial Port, a Parallel Port, Clock/Calendar and an Optional Game Port

DESQview
Software Included
SIDERICK

AST
RESEARCH INC.

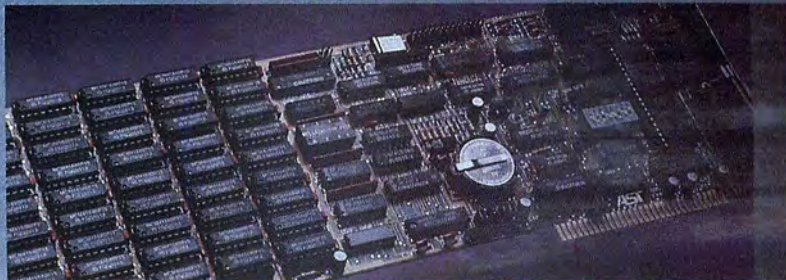

First there was SixPakPlus®...the single most popular PC enhancement product in history. Now AST makes the best even better. SixPakPremium™ sets the new standard for multifunction PC enhancement.

Expanded Memory and More I/O. The new standard includes up to two serial ports, a parallel port, optional game port and battery-backed clock/calendar. And we've beefed up the memory, giving you up to 2 megabytes of conventional and/or enhanced expanded memory.

Intelligent Memory.™ We dubbed our enhanced expanded memory *Intelligent Memory*. Intelligent, because it combines full Lotus®/Intel®/Microsoft® EMS compatibility with new, exciting capabilities. Capabilities no ordinary EMS board can match!

Guaranteed EMS Compatible. Test our Premium Guarantee. If within ninety days of purchasing a



SixPakPremium, you find an EMS software package incompatible with it, we'll either establish compatibility or buy you a comparable EMS board of your choice.*

More Capability Than Ordinary EMS. SixPakPremium, together with its DESQview™ software—included at no extra cost, lets you organize up to nine standard PC applications at a time in your Intelligent Memory. And DESQview is compatible with hundreds of the most popular PC applications.

FastTask.™ The End Of Workflow Interruptions. Simply load all the applications you use during the course of the day into your Intelligent Memory once in the morning. It's that easy.

Now you're ready to FastTask. That's what we call the ability to move instantly from application to application. There's no fussing with diskettes or closing

*Applies to boards purchased after 9/1/86. Valid only in U.S.A. Some additional restrictions apply. For complete details write to AST Research, Attn. M.C.G. SixPakPlus registered and SixPakPremium, Intelligent Memory, FastTask, Premium Guarantee and SuperPak trademarks AST Research, Inc. IBM registered trademark International Business Machines Corp. DESQview trademark Quarterdeck Office

Again.

MULTIFUNCTION PRODUCTS

SIXPAK PREMIUM™

AST
RESEARCH INC.

Enhanced EMS Multifunction Board for the IBM PC, PC-XT and Compatibles

Offering Up To 2 Megabytes of Expanded Memory, Two Serial Ports, Parallel Port, Battery-Backed Clock/Calendar, Game Port, SuperPak™ Utility Software, And DESQview™ Multitasking/Windowing Software.



down one application to open another.

It's easy to transfer data between applications like Lotus 1-2-3® dBASE®II and WordStar®. And you can create windows to view applications,



*SixPakPremium:
The New Multifunction*

We've included utilities for RAM disks and print spoolers. And our easy-to-comprehend documentation makes installing and using SixPakPremium fast and easy.

Call (714) 863-1480 For Your FREE Intelligent Memory Booklet! Or send the attached coupon to AST Research, Inc., 2121 Alton Avenue, Irvine, California 92714-4992, Attn. M.C.

Yes, send me AST's Intelligent Memory Booklet.

Name _____

Title _____

Company _____

Address _____

City _____ State _____ Zip _____

Phone (_____) _____

Number of PCs _____

BB059B2SPP
IBM/86

Send to: AST Research, Inc., 2121 Alton Ave.
Irvine, CA 92714-4992, Attn. M.C.

AST
RESEARCH INC.



Systems. Lotus, 1-2-3 registered trademarks Lotus Development Corp. Intel registered trademark Intel Corp. Microsoft registered trademark Microsoft Corp. dBASE registered trademark Ashton-Tate. WordStar registered trademark MicroPro International Corp. Copyright © 1986, AST Research, Inc. All rights reserved.

Future technologies will permit the addition of architectural enhancements.

multiple of that size, the low-order bits of the virtual address reflect an offset within the page and are not used in the translation. The virtual page number is the high-order 28 or 29 bits of the 40-bit address, depending on page size.

In traditional translation schemes such as that of the IBM System/370, the page table is organized by virtual address. That is, the virtual page number is used directly as an index into a one- or two-level table to obtain the real page number. As virtual storage becomes very large and as the number of independent tasks supported increases, such tables can become unwieldy because the overall table size is proportional to the amount of virtual storage supported by the operating system.

The RT processor uses an inverted page table instead, an approach first used on the IBM System/38. The table is organized by real address with the contents of each entry being the cor-

responding virtual address. The table's maximum size is therefore one entry per real page rather than one entry per virtual page. Only a fixed percentage of the machine's real memory is required for the inverted page table regardless of the amount of virtual storage in use.

If the page table entries are in order by real address, how can a virtual-to-real translation be done quickly? It would seem that a sequential scan of the page table would be required, comparing the virtual address with each table entry until a match is found. On the average, half the table entries would have to be checked.

The RT processor avoids this sequential search by using a hashing technique to quickly find an entry for a given virtual address (see figure 3). The 28- or 29-bit virtual page number is "hashed" into a number in the range of 0 to $n-1$, where n is the number of pages of real memory. Thus the range of 2^{28} or 2^{29} virtual page numbers is quickly reduced to one-of- n congruence classes. For each congruence class there is a chain of entries threaded through the inverted page table. Each entry on a given chain is for a real page whose virtual page number hashes to the same congruence class (i.e., a "hash collision").

Translating from virtual to real, then, requires only a simple hash operation (just an exclusive-OR) followed by a sequential search of the entries on the hash chain. This technique works well

if the hash chains are very short compared to half the total number of entries in the table. In fact, the average chain length is between one and two entries, so that only a few memory accesses are required to find the real entry for a virtual page. The worst case, of course, would occur if all the virtual pages in the system wound up on the same hash chain, but the chances of that happening are exceedingly remote.

TRANSLATION LOOK-ASIDE BUFFER

Regardless of page table organization, no system in which performance is a goal can afford to go to the page table in main memory for each and every translation. In the MMU, a cache of recently used translations is kept in a translation look-aside buffer, or TLB. This is a two-way, set-associative table with 32 total entries. Each entry contains a virtual page number, its corresponding real page number, and memory protection information for the page.

One of 16 congruence classes is selected by using the low-order 4 bits of the virtual page number. For that class, two comparisons are made, in parallel, against the remainder of the virtual page number. If a match is found, the translation can be completed immediately. If no match is found in the TLB, the page table must be searched and the TLB updated.

Hit ratios of address translation caches are typically very high, much higher than those of data caches, for example. The hit ratio for the TLB is about 99.5 percent. As a result, address translation is normally completed within a single cycle. When the TLB does miss, translation is usually extended by only 8 to 11 cycles while the TLB is reloaded.

HARDWARE IMPLEMENTATION

The RT processor and its MMU are each implemented as single VLSI chips. With a cycle time of 170 nanoseconds, the sustained execution rate of the RT processor on a typical mix of instructions in the IBM RT PC is ap-

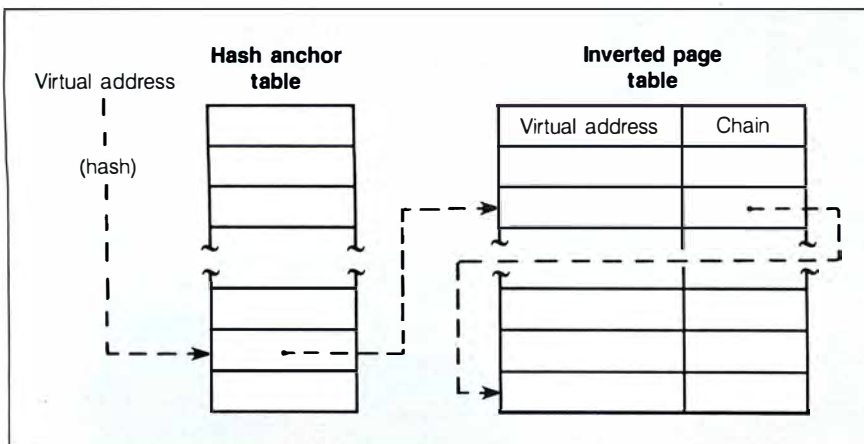

Figure 3: RT processor hash anchor table and inverted page table.

(continued)

Speed is of the essence. The C. Itoh ProWriter® C-310/C-315.

If there's anything to that old "time is money" adage, the C-310 and wide-carriage C-315 are the smart buys. Because at up to 300 cps, they're a third faster than other printers in their class—printers like the Epson FX-85®, Okidata 292® and IBM ProPrinter®.

And with features like Auto Paper Loading, a built-in push/pull tractor, and bottom paper feed, you'll spend more time printing and less time fussing with your printer.

The Maserati of printers.

Nationally syndicated computer columnist Peter McWilliams is a man who knows his printers. And when he called the C-310 "... the Maserati of printers," he meant there was a lot more to it than just speed.

Of course, the C-310/315 smokes through draft printing at about 100 cps faster than the competition. But with a graphics resolution of 240 x 216, it's exceptionally crisp in the



curves and corners of pie charts and bar graphs. And because it's switch selectable between Epson FX-85 and IBM ProPrinter control codes, it will run on the most popular business software available.

Yet despite all this performance, the C-310/315 features advanced sound insulation to make printing as smooth and quiet as riding in a Rolls-Royce.

True letter quality.

If you're in business—and who isn't?—the C-310/315's best feature may be the one-button, front-panel selection of letter quality print with up to 27 dots of vertical makeup.

You get quality that rivals expensive office typewriters. And with the C-310/315's color option and plug-in font cartridges, you can express yourself in seven vivid colors and a variety of different typefaces.

Total support.

Because it's from C. Itoh Digital

Products, the C-310/315 is backed by a full one-year warranty on parts and labor, with Authorized Service Centers available nationwide.

More importantly, it's backed by the \$90 billion worldwide trading company C. Itoh & Co., Ltd.

So you can depend on C. Itoh to be there when you need them.

Fast track.

As you can see, there's a lot more to the C-310 and wide-track C-315 than unbridled speed. They are also exceptionally smooth, efficient, intelligently designed and, frankly, made for the discriminating business that knows the difference between "cost" and "value."

We can't promise that buying a C. Itoh C-310/315 will shorten your climb to the top. But it will get

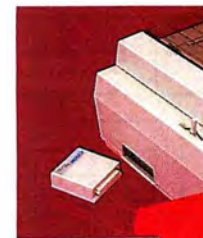

you out of the office faster.

Upgrade.



C. ITOH

C. Itoh Digital Products, Inc.

19750 South Vermont Avenue, Suite 220
Torrance, California 90502

Telephone: (213) 327-2110 or (800) 423-0300

Epson FX-85 is a registered trademark of Epson America, Inc.
Okidata 292 is a registered trademark of Oki America, Inc. IBM
ProPrinter is a registered trademark of International Business
Machines Corporation.

Inquiry 51 for End-Users.
Inquiry 52 for DEALERS ONLY.

proximately 2 million instructions per second. The peak execution rate, which is reached in sections of normal compiled code where register-to-register operations predominate, is one instruction per cycle:

$$\frac{1 \text{ instruction}}{1.7 \times 10^{-7} \text{ seconds}} = 5.88 \text{ MIPS}$$

PIPELINES

There are two levels of pipelining in the implementation of the RT processor (see figure 4). First, the execution of instructions is done by a four-stage pipeline that overlaps instruction fetch, instruction decode and operand fetch, execution, and result storeback. At a higher level, memory operations (Load, Store, Instruction-

Fetch) are pipelined so that several memory operations can be in progress at once and so that the processor need not wait for the completion of a memory operation before executing subsequent instructions. In the current version of the RT processor, instruction fetching is pipelined, but loads and stores are not (in virtual memory mode) so that precise page-fault interrupts can be presented.

In the low-level pipeline, the first stage is unique in that it proceeds asynchronously with the rest of the stages. That is, the instruction fetch mechanism is usually fetching a word that is several instructions beyond the one currently entering decode.

The instruction fetch unit in the RT processor tries to keep its 4-word buf-

fer full by fetching the word at the next sequential address, incrementing its pointer by 4, and repeating this until all 4 words are full. If a branch occurs, the execution unit resets the instruction fetch unit's pointer to the branch target address and marks the four buffer entries "empty." The instruction fetch unit then starts fetching the new instruction stream.

The other three stages of the pipeline run in lockstep. In the first stage, a prefetched instruction is decoded and the contents of registers that it uses as source operands are fetched from the register file. Two registers can be read from the file and two written simultaneously. The first (usually the only) microcode word for the instruc-

(continued)

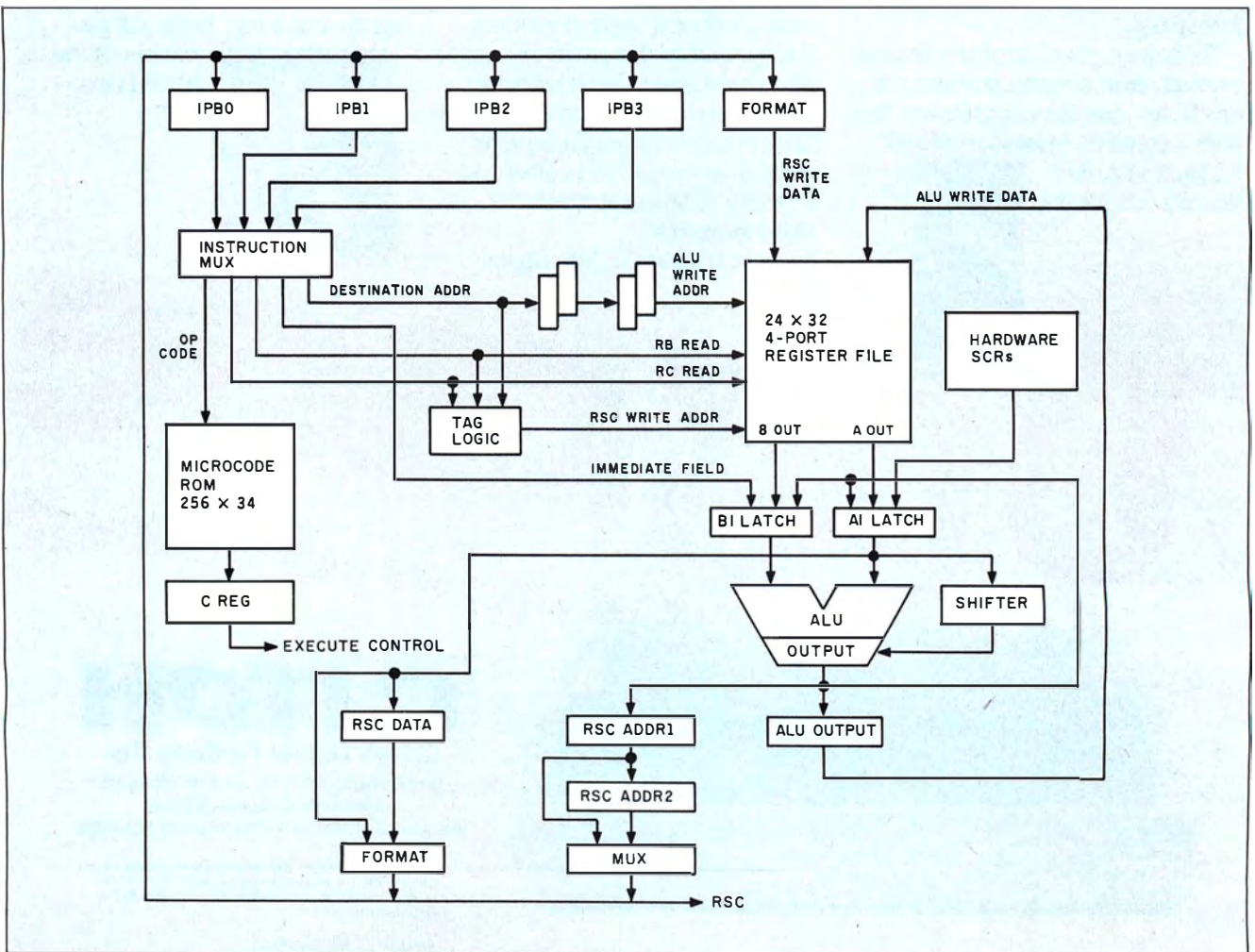

Figure 4: A data flow block diagram of the RT processor.

AT jr. NOW \$599.



FREE! A \$185.00 VALUE.
With any order of \$1,000 or more, AMT will send you, absolutely FREE, a *Micro* brand dress wristwatch. Finest precision Japanese quartz movement. Specify male or female size.

LAUGH, CLONE, LAUGH! Who would guess that our AT jr. has more on the ball than his big brother?

AT jr. not only delivers fantastic features at fabulous prices, but gives you **top quality** in design, components, materials, and construction!

And for reliability, every AT jr. is burned-in at the factory prior to shipment.

No IBM® compatible system gives you more capability and value for your dollar than our incredible AT jr.:

AT jr. \$599. This feature-packed model is based on an Intel 8088-2 (or NEC V20-8) CPU, running at 4.77 MHz or 8 MHz, selectable; handles PC DOS®, MS DOS®, XENIX®, and other operating systems, plus a full range of IBM-compatible software.

The standard system has a "0" wait state on memory, and operates many times faster than the IBM PC/XT®. Offers 640 KB of RAM on

the motherboard; 360 KB floppy disk drive; eight expansion slots; LED indicator for the turbo mode; AT-style keyboard; 135-watt integral power supply; and security key lock. Optional features include a 40 MB hard disk (38 ms), EGA, and an 8087-2 math co-processor.

LAP TOP. \$1699. AMT's compact Lap Top system gives you full IBM compatibility in less than 12.2 pounds of high-powered computer.

Features an 80C86 microprocessor, giving you twice the speed of IBM's lap top; 640 KB of memory; two 720 KB, 3.5-inch disk drives; an 80-by-25 LCD display with 640 x 200 resolution; RGB and printer ports; and a 1200 baud internal modem, optional.

AMT-286. \$1199. AMT's top-of-the-line AT system outperforms the IBM PC AT® at a fraction of the

price. Tagged "Best Priced" by PC Week, March 1986 issue.

Our phenomenal AT has a 16-bit Intel 80286 CPU running at 8 MHz (10 MHz or 12 MHz optional); 640 KB of RAM, expandable to 1 MB; 1.2 MB floppy disk drive; accommodations for 20, 30, or 40 MB hard disk drive; a socket for an Intel 80287 math co-processor; and a "0" wait state on memory, optional.

DON'T WAIT—CALL NOW

Pick up your phone now and get full details or place your order.



AMERICAN MICRO TECHNOLOGY

14751-B Franklin Avenue

Tustin, California 92680

Phones: (714) 731-6800;

in LA call (213) 477-6320;

in Bay area call (415) 490-7967

TWX 5106003265 AMT USA

*Prices and availability subject to change without notice. Dealer inquiries accepted.

®Registered Trademarks—IBM, IBM PC, IBM PC/XT, IBM PC AT, PC DOS: International Business Machines Corporation; MS DOS, XENIX: Microsoft.

tion is fetched simultaneously with the operand registers. The micro-coded design of the RT processor does not slow down execution because the microword fetch is overlapped with the fetching of the operands.

In the next stage the decoded instruction is executed using the previously fetched register contents. In the last stage the results of the execution are stored back into the register file or are sent out to memory if this is a Store instruction. In addition, the

register file is bypassed when an instruction uses the results of the preceding instruction. The output of the ALU is fed back around to be the input on the next cycle. In the normal course of events the instruction fetch unit will have fetched instructions far enough ahead so that the decoder does not have to wait. There will then be three instructions in process: one in decode, one in execution, and another in storeback so that the throughput is one instruction per cycle (see figure 5).

Multicycle instructions such as Divide Step spend several cycles in execution, thus delaying the instructions that follow them. In addition, it may not be possible to start execution of an instruction if one of the registers it uses is the target of a previous Load instruction that is not yet complete.

PACKET-SWITCHED MEMORY BUS

A Load instruction may not have been completed due to the pipelining of the memory interface. Since the RT

(continued)

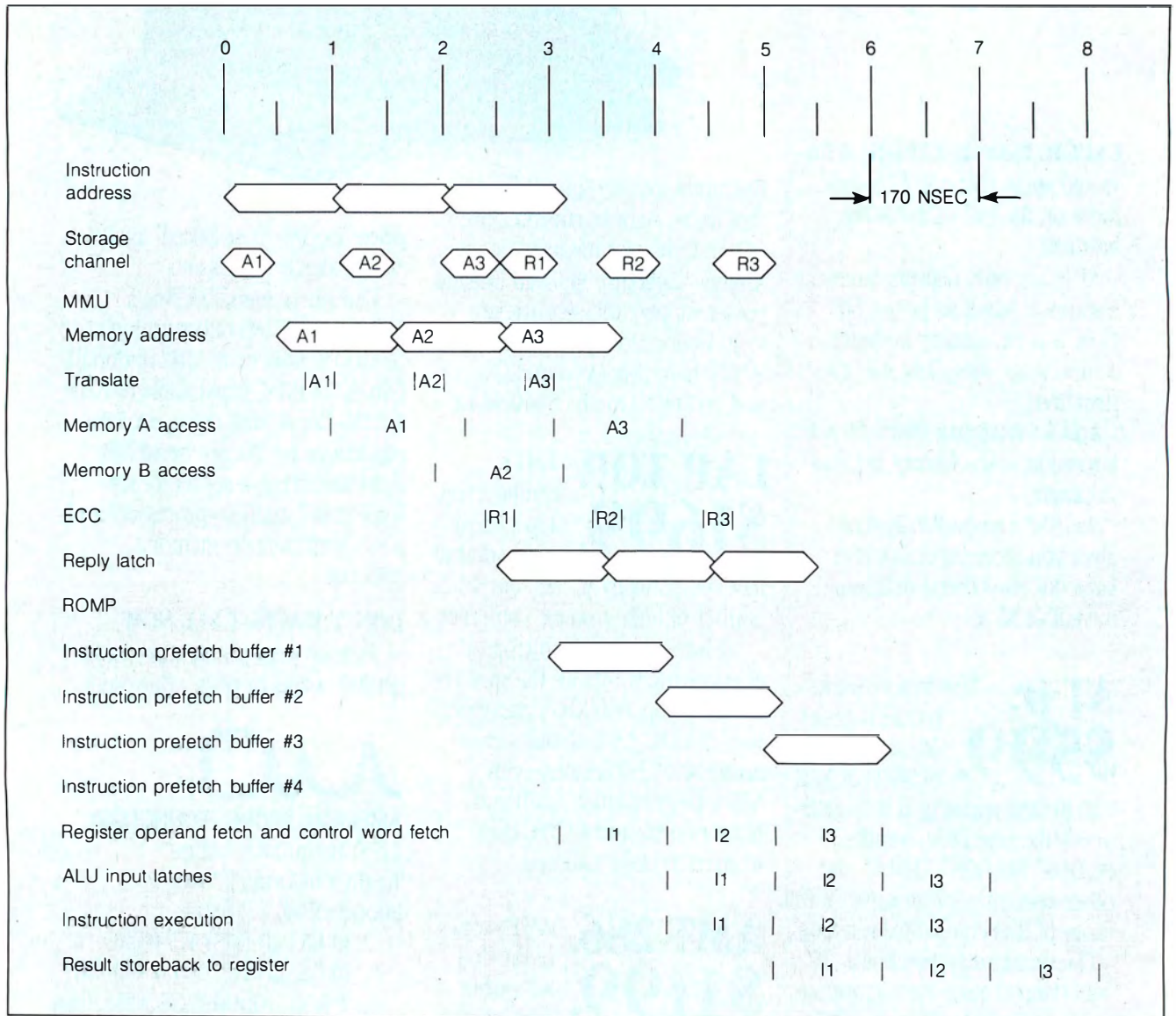
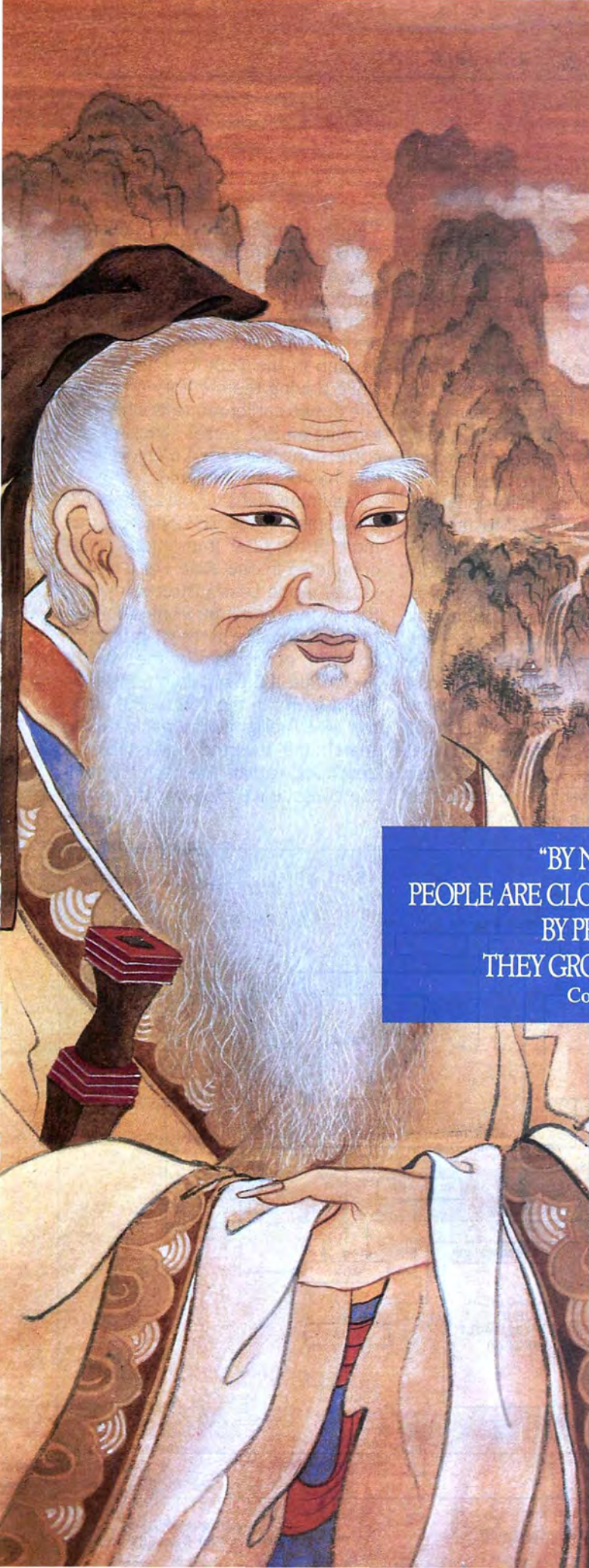

Figure 5: Three 32-bit instructions. Note the timing overlap in memory access, instruction prefetch, operand fetch, and storeback to registers.



"BY NATURE,
PEOPLE ARE CLOSE TO EACH OTHER;
BY PRACTICE,
THEY GROW FAR APART."

Confucius



ITT helps a growing company work together.

Today's leading business computers deliver tremendous power to individuals. One business microcomputer—the ITT XTRA™ XL—can join those individuals together in high-performance multi-user or network office environments.

ITT XTRA XL. The missing link.

Link multiple ITT XTRA XL computers together in a powerful network or use one ITT XTRA XL as a shared processor licensed for up to 16 users with 32 available ports. Connect your existing IBM-compatibles to a cost-effective LAN. Take full advantage of multi-user and networking technology today and far into the future with ITT XTRA XL's versatile, modular design.

Today's connectivity tool.

Other computers claiming connectivity do so at the cost of performance and speed. Not the ITT XTRA XL.

It combines the powerful Intel 80286 main processor with a separate processor for terminal management. It runs DOS or XENIX operating systems, fea-

tures zero-wait-state memory access, and up to 144 megabytes of very fast disk storage.

And you get all this astonishing performance for far less than the cost of the ITT XTRA XL's nearest competitors.

A family of solutions.

The ITT family of microcomputers provides high performance, compatibility and uncompromising answers for your business applications. The ITT XTRA for entry-level efficiency. The ITT XTRA XP for demanding single-users. The ITT XTRA XL for multi-users and networks. Your ultimate computer solu-

tion is just a phone call away. Call (800) 321-7661. In California, (800) 368-7300.

ITT
BUSINESS COMPUTERS

©1986, ITT Information Systems.

IBM is a registered trademark of International Business Machines, Inc. Intel 80286 is a registered trademark of Intel Corporation. XENIX and MS DOS are registered trademarks of Microsoft Corporation.

processor's main memory does not run as fast as a cache, it would be time-consuming to wait for each Load or Store operation to end before beginning the next operation. To allow multiple memory operations to be in progress at once and to gain maximum use of interleaved (multibanked) memory, a packet-switched bus was defined between the RT processor, the MMU, and the I/O controller.

This bus is known as the ROMP storage channel, or RSC (unfortunately, a nested acronym). The RSC runs synchronously with the RT processor cycle, with two RSC cycles per processor cycle. The standard RT processor cycle time in the IBM RT PC is 170 nanoseconds (the RSC runs at 85 ns/cycle). Even-numbered RSC cycles are used to transmit addresses from the RT processor or from DMA I/O to the MMU, while odd-numbered cycles are used to transmit data.

Each transfer is 32 bits wide. In each processor cycle, therefore, both a memory request (address) and a unit

of data (a word loaded or stored) can be transferred, for a net throughput of

$$\frac{4 \text{ bytes}}{1.7 \times 10^{-7} \text{ sec.}} = 23.5 \text{ megabytes/sec.}$$

The address and data portions of the cycle are not necessarily related. In the first half of a processor cycle (i.e., in the even-numbered RSC cycle), the processor may send out an address for a load or instruction fetch, while in the second half (odd-numbered RSC cycle) the MMU may respond with the data for an earlier request. Requests are not necessarily responded to in order, depending on whether the required memory bank is busy when the MMU processes the request. To keep the outstanding requests straight, each request (address) has an associated tag, a 5-bit value that tells who owns the request (RT processor or I/O controller) and what should be done with the response when received (sent to the instruction fetch unit or to a general register).

Further pipelining occurs within the MMU (see figure 6). We have seen that several memory requests can be outstanding at once. The MMU overlaps operations for the various requests—performing address translation (lookup in the TLB) for one request while driving the memory arrays for one or two earlier requests while performing an ECC (error checking and correction) check for a memory read that has been completed.

Assuming that a virtual address has a mapping in the TLB, which is true most of the time, translation can be completed in one cycle. For a typical virtual mode Load instruction in the RT PC, the total time from execution of the instruction in the RT processor to return of the data by the MMU is five cycles. If the required translation is not found in the TLB (a TLB miss), the MMU takes additional cycles to search the inverted page table as described earlier. The hash chain for the congruence class for the virtual

(continued)

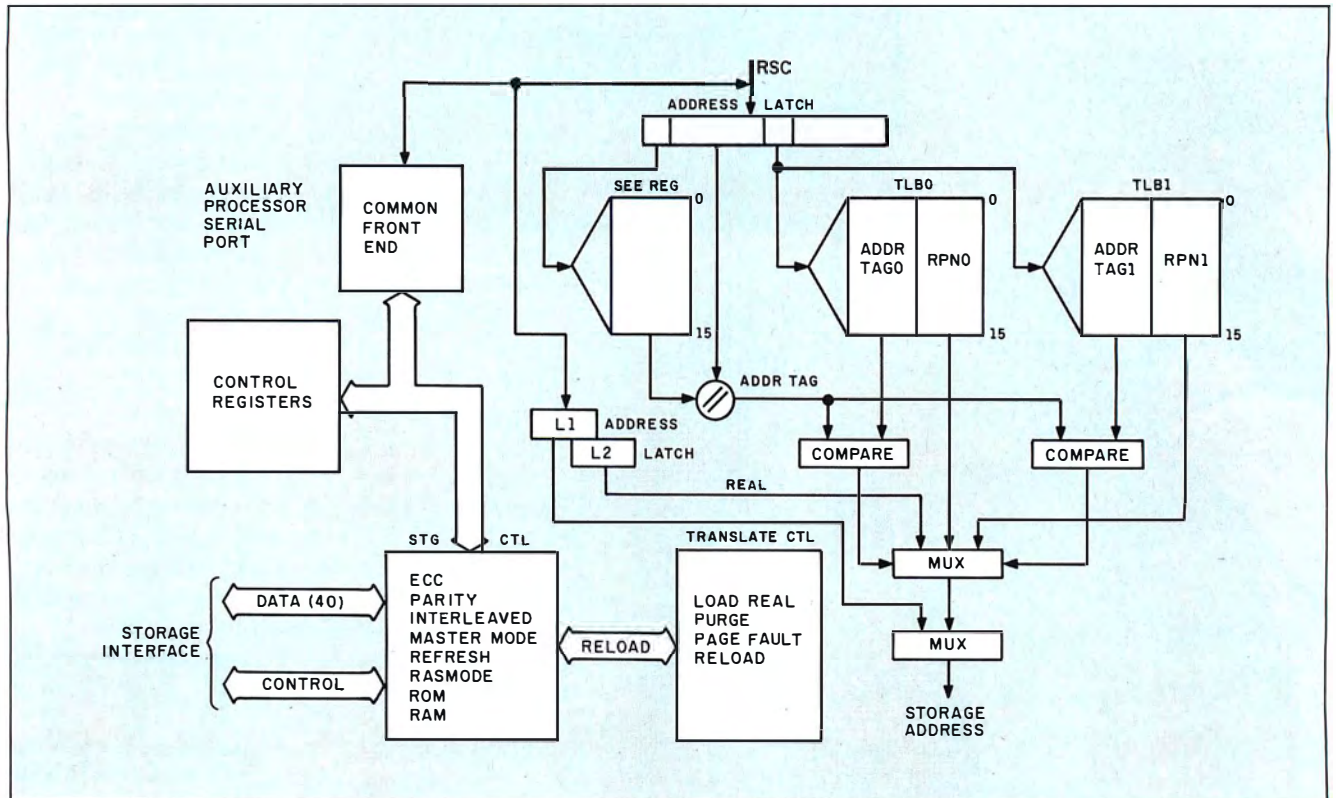
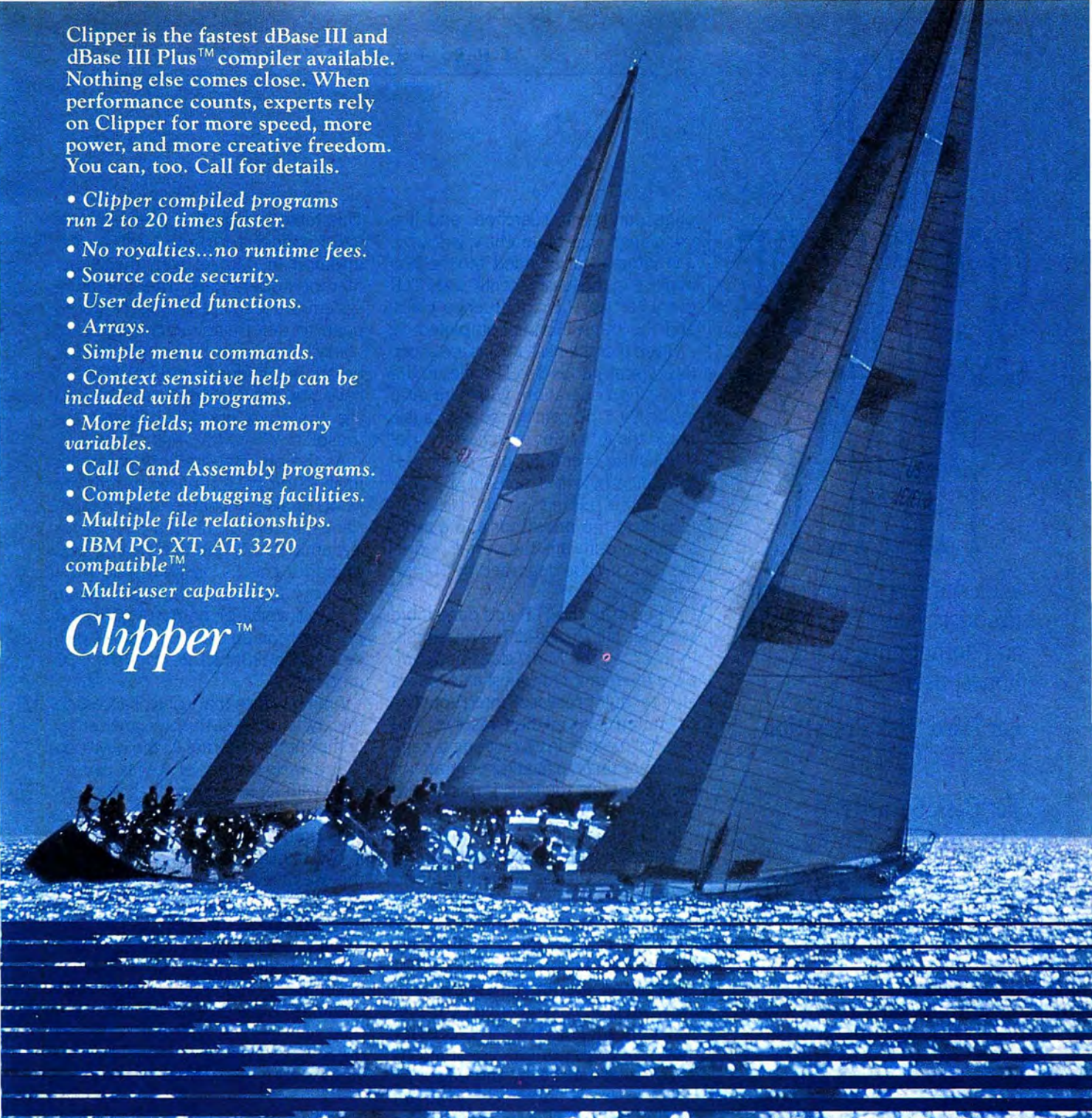

Figure 6: RT processor memory management unit data flow.



Clipper is the fastest dBase III and dBase III Plus™ compiler available. Nothing else comes close. When performance counts, experts rely on Clipper for more speed, more power, and more creative freedom. You can, too. Call for details.

- *Clipper compiled programs run 2 to 20 times faster.*
- *No royalties...no runtime fees.*
- *Source code security.*
- *User defined functions.*
- *Arrays.*
- *Simple menu commands.*
- *Context sensitive help can be included with programs.*
- *More fields; more memory variables.*
- *Call C and Assembly programs.*
- *Complete debugging facilities.*
- *Multiple file relationships.*
- *IBM PC, XT, AT, 3270 compatible™.*
- *Multi-user capability.*

Clipper™

CLIPPER. THE dBASE COMPILER.
A WINNING PERFORMANCE EVERY TIME.



Nantucket™

Nantucket Corporation
5995 South Sepulveda Boulevard
Culver City, California 90230
(213) 390-7923
Outside California call toll-free:
1-800-251-8438

dBase, dBase III, and dBase III Plus are trademarks of Ashton-Tate, Inc.
IBM PC, XT, AT, and 3270 are trademarks of International Business Machines Corporation.
Clipper and Nantucket are trademarks of Nantucket Corporation.

STOP SOFTWARE PIRACY

With our Copy Protection Products. They really work and do not burden the honest user. . .

For Hard Disk Protection

- HDCOPY

For Disk Security

High Level Security

- PADLOCK II DISK
- SAFEGUARD DISKS
- COUPON DISKS

Low Level Security

User Installable Protection

- PC-PADLOCK

The market is filled with copy protection products which burden the user or simply don't work. We have over 1500 satisfied software firms utilizing our systems. The high-level fingerprint has not required an update in over 2 years.

Why should your valuable data or useful software program become available in the Public Domain?

Call or write for more information.



GLENCO ENGINEERING INC.

SERVING THE SOFTWARE INDUSTRY

3920 Ridge, Arlington Hts., IL 60004
(312) 392-2492 Telex 493-7109

page number is searched, and if a matching page table entry is found, it is automatically loaded into the TLB in place of the least recently used TLB entry for its TLB congruence class, and the translation is completed.

Given that the hash chains are short, this typically adds 8 to 11 cycles to the translation operation. With a hit ratio in the 99.5 percent range, this automatic page table search only degrades the overall RT processor performance by a few percent. By contrast, if the TLB miss resulted in an interrupt to the processor and a table search by software, the overall performance could be degraded by 30 percent or more.

When both the TLB and page table searches fail, the result is a page fault. In this case the MMU does not complete the memory request and causes a page-fault processor interrupt. The operating system then resolves the fault by reading in or creating a page and restarting the faulting program (or by terminating the task, if this access is really an error).

Instruction fetch requests, which are interleaved with Load/Store requests from the instruction stream, can also cause page faults. The MMU translates these requests in the same way and reports page faults to the processor, but the processor does not generate an interrupt unless the faulting word is actually needed by the instruction stream. The RT processor therefore does not process spurious page faults caused by the eager instruction fetch unit fetching ahead beyond the end of a page, when the instruction stream will actually branch before crossing the page boundary.

If the translation is successful but the memory protection bits for the page don't match the type of request, then an interrupt similar to a page fault is generated. The operating system can change the protection status of the page and restart the program, or it can terminate the task in the case of an addressing error.

To assist the operating system in selecting pages for replacement, the MMU maintains a table of reference and change bits for each real page.

This table is stored in a small static RAM connected to the MMU and is updated in parallel with the actual memory operations. The operating system can read these "flags" for each page to determine which pages are "dirty" and must be written to disk before being reused and which pages have not been referenced at all and are therefore good candidates for reuse.

As the physical memory controller in an RT processor-based system, the MMU is also in charge of such mundane matters as hidden refresh for dynamic RAMs and performing ECC or parity checks on data read from memory. Either ECC (40 bits wide, on a 32-bit word) or parity (1 parity bit per byte) can be used with the RT processor. (The IBM RT PC uses the ECC mode.)

Timing values that control access to the dynamic RAM arrays are set by components external to the MMU, so that a wide variety of RAMs can be used with an RT processor-based system. The IBM RT PC uses 150-ns access time memory chips interleaved in two banks. The MMU also supports the use of read-only memory in addition to RAM. On the IBM RT PC the initial RT processor checkout program begins executing from ROM. This program initializes the RAM, reads in a larger initialization program from disk, branches to the program in RAM, and then switches the ROM out of the addressing space, causing all further execution to be from RAM.

THE FUTURE

Improvements to the RT processor system and RT processor's MMU could come from two sources: technological advances over time and architectural enhancements. RISC architectures like that of the RT processor scale well as technology improves. With smaller dimensions of VLSI geometry come both increased density and faster clock times. Since most RT processor instructions require only one cycle, a reduction in the cycle time translates directly into increased execution speed.

(continued)

Slash development time

Easy does it with
your PC and our HPPC Instruments.

Easy to set up — HP PC Instruments are easy to install. Simply connect instruments and accessories and load the software; you're up and running in a few hours. They're easily controlled with the HP Vectra PC (below); the IBM PC, PC/XT or PC/AT; the AT&T PC 6300; or other selected compatibles over the HP PC Instruments Bus (PCIB).

Easy to debug — Soft front panels (oscilloscope display shown below) let you see the status of all instruments in the system at a glance. And you can switch easily between panels and your BASIC program for simple program debugging.

Easy to use — Soft front panels (oscilloscope display shown below) let you enter much of your program with a mouse or touchscreen which means less data entry for you. And the system software generates the major portion of your program at the touch of a key. Add your own touches to customize and you're done. Result: You can generate complete test programs in days instead of weeks.

Easy to afford* — PC Instruments are inexpensive. You can buy and use as many, or as few, as you need.

4½ Digit Digital Multimeter: \$700
50MHz Digital Oscilloscope: \$1500
5MHz Function Generator: \$1500
100MHz Universal Counter: \$900
Relay Multiplexer: \$700
12 bit Dual Voltage DAC: \$800
16 bit Digital I/O: \$700
Relay Actuator: \$700
20 Volt Power Supply: \$900
PCIB Interface: \$500
HP-IB Interface: \$400
Optional System Power Unit: \$400
ASYST™ Scientific Software⁺:
\$1695-\$2495

Easy to combine with HP-IB — For optimum price and performance, mix and match traditional HP-IB instruments, like the voltmeter below, with any of the PC modules. Add PC modules to traditional instruments, and vice-versa. And control everything with the same BASIC program.

Free technical assistance — Call the PC Instruments Support Hot-Line at (201) 627-2500. Talk to an engineer about how PC Instruments can automate your testing. And request technical literature and a free demo disc that simulates system operation. Or call your local HP sales office listed in the white pages of your telephone directory. Ask for the Electronic Instruments Department.

*Prices are U.S.A. list prices only.

+ASYST™ Scientific Software is a trademark of Macmillan Software Co., a div. of Macmillan, Inc.



**HEWLETT
PACKARD**

Inquiry 125

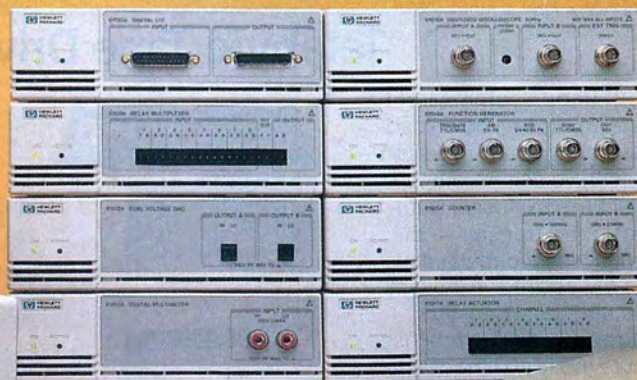
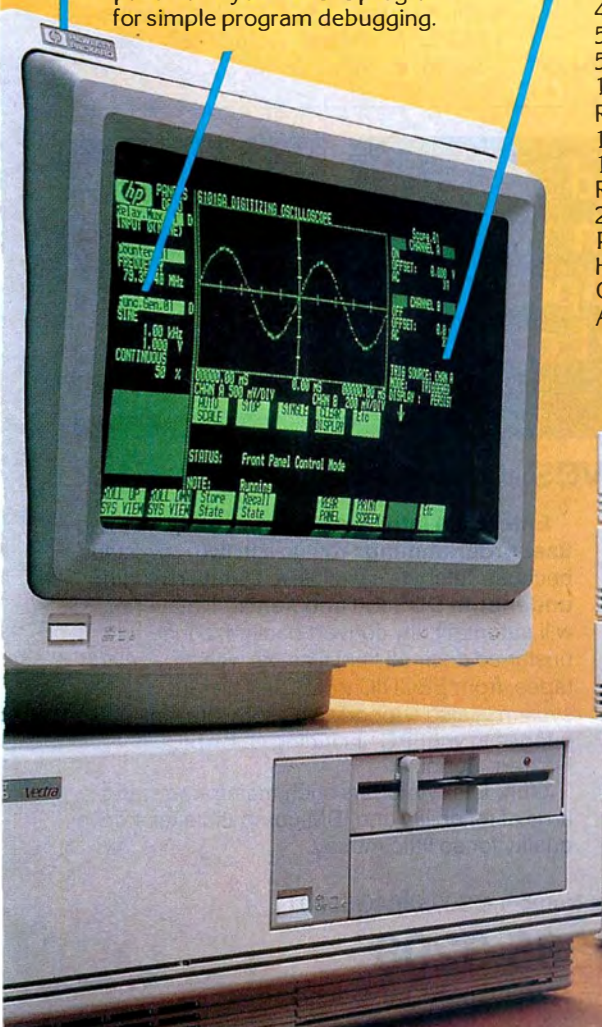

HP-IB 3478 Voltmeter

*Normal throughput
is one instruction
per processor cycle.*

The greater density available in future technologies will permit the addition of architectural features that had to be omitted from the current RT processor and MMU. Probably the most obvious enhancement would be the restoration of one or both of the caches from the original 801 design. Additional silicon space would also permit the inclusion of functions that do not fit the RISC paradigm of one cycle per instruction but that have proven (by measurement of significant running code) to be very useful for enhanced performance.

The MMU's virtual memory map-

ping functions permit the operating system to create a one-level store in which objects traditionally considered to be disk files become simply arrays of data structures in virtual memory. I/O operations on such a file, instead of being explicit reads and writes, are implicit and are handled by the Paging Supervisor. This can be much more efficient as well as being far easier to program than the traditional access methods. Increases in memory size and cache size will mean that programs traditionally thought of as I/O-bound may become processor-bound. These programs will benefit even more from a faster processor.

For both areas, pure technological speedup and additional functions, the architecture of the RT processor provides an extensible base for the future.

BIBLIOGRAPHY

IBM Corporation (various authors). *IBM RT*

Personal Computer Technology, form number SA23-1057. Available through IBM branch offices. This book consists of more than two dozen papers on various aspects of the RT processor, MMU, and the IBM RT PC. "RT Processor/MMU Implementation" on pages 57-65 is of particular interest.

Hennessy, John, Norman Jouppi, Steven Przybylski, Christopher Rowen, Thomas Gross, Forest Baskett, and John Gill. "MIPS: A Microprocessor Architecture." *Proceedings of the 15th Annual Microprogramming Workshop*, SIGMICRO '82, 1982, pages 17-22.

Markoff, John. "RISC Chips." *BYTE*, November 1984, pages 191-206.

Patterson, David A., and David R. Ditzel. "The Case for the Reduced Instruction Set Computer." *Computer Architecture News*, October 15, 1980, pages 25-33.

Patterson, David A. "Reduced Instruction Set Computers." *Communications of the ACM*, January 1985, pages 8-21.

Radin, George. "The 801 Minicomputer." *SIGPLAN Notices*, April 1982, pages 39-46. ■



**Nothing Should
Come Between
Mainframe Mag Tapes
and Your dBASE or Lotus
Except**

Telebyte Tape Drives

TDX Mag 9-track 1/2" Tape Systems from Telebyte provide faster, error-free downloading of mainframe data into your PC. You control the start-stop tape drive either from the keyboard or with Telebyte's exclusive Dataverter software for faster file transfer — the equivalent of a 720,000 bit/second datalink.

Telebyte TDX tape drives are available at either 45 or 75 ips, feature dual density (800/1600 bpi) storage and back up processed files at 2 MB/minute (up to 10 times faster than other 9-track drive systems) as a bonus.



Enter data into dBASE® and Lotus® with no user programming. You do it in two easy steps because Telebyte's exclusive **Dataverter runs under both DOS 2.0 and Xenix.™** Dataverter will automatically convert packed, zoned and unsigned decimal field files, as well as labeled tapes, from EBCDIC to ASCII. The tape system is also supported by software languages in your PC, including C, BASIC, Fortran, Cobol, etc.

Only Telebyte offers such mainframe standards of reliability and IBM-compatible tape drive quality for so little money.

TELEBYTE
TECHNOLOGY, INC.

GSA Contract Number GS00K86AGS5301

1-800-835-3298

Telebyte Technology, Inc. • 270 E. Pulaski Road • Greenlawn NY 11740 • (516) 423-3232

dBASE® is a registered trademark of Ashton-Tate, Inc.; Lotus® is a registered trademark of Lotus Development Corporation; IBM® is a registered trademark of International Business Machine Corporation; Xenix™ is a registered trademark of MicroSoft.

Why Kaypro?

Here are eight reasons to choose the KAYPRO PC.

1. Non-Obsolete Design

It's a snap to update vital system components – right down to the microprocessor.

2. IBM Compatibility Guaranteed*

Only Kaypro guarantees IBM compatibility – and gives you three times the IBM standard memory – with the KAYPRO PC's 768KB RAM.

3. 12-Month Warranty

A one year parts and labor warranty is standard.

4. Included Software: WordStar... Plus

Every KAYPRO PC comes standard with WordStar, MS-DOS 3.2, GW BASIC, K-Desk, PolyWindows, CorrectStar, MailMerge, and more.

5. Two Speeds For Fast Processing

Zip along at 4.77MHz – or zoom with 8.0MHz.

6. Both IBM Video Standards... Plus

Get maximum software compatibility with IBM monochrome and CGA video standards – and Hercules emulation – built in.

7. IBM PC AT-style Keyboard

Just like the expensive IBM PC AT – complete with tamper-proof keylock.

8. Made in the USA

Few IBM PC or XT compatibles can make this claim.

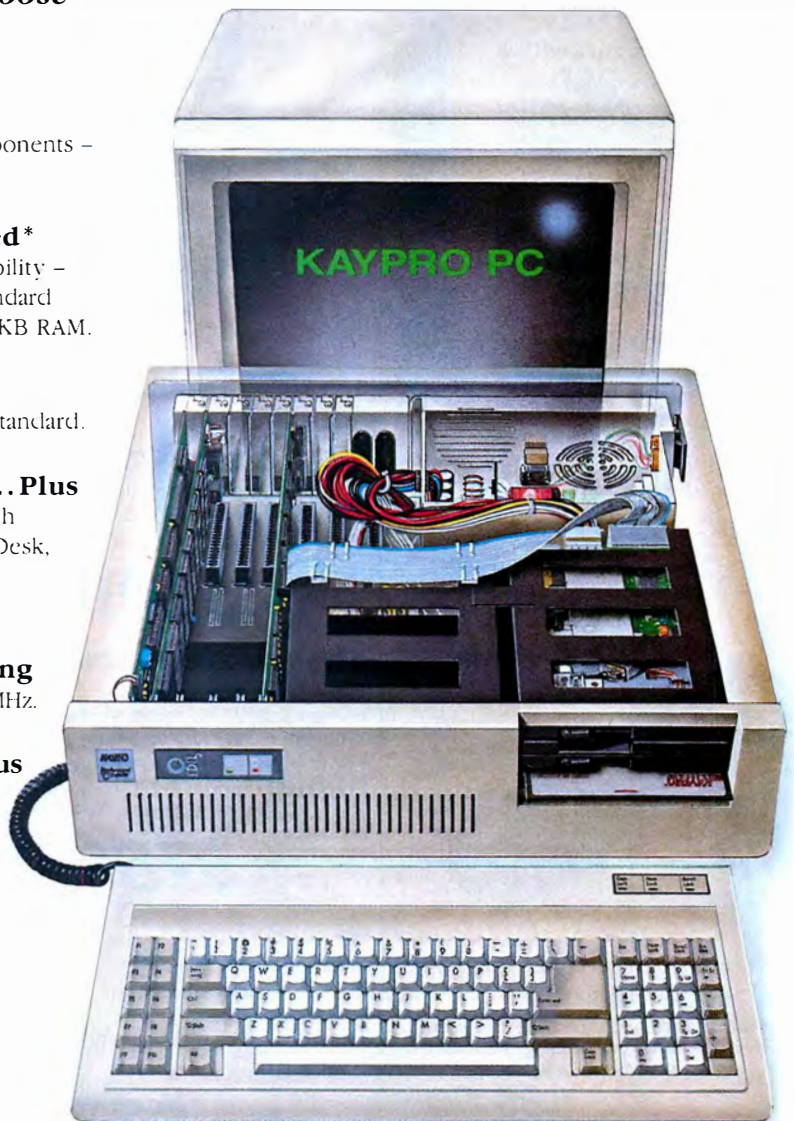

Suggested retail price: \$1595.

Visit us at Comdex

Booth #1280

KAYPRO[®]
CORPORATION

Innovators of Electronic Products for Over 34 Years

For the dealer in your area, call tollfree 1-800-4-KAYPRO (1-800-452-9776) or 1-619-481-4300.

Trademarks: IBM and AT are trademarks of International Business Machines, Inc.; Hercules, Hercules Computer Technology, WordStar, CorrectStar, MailMerge, MicroPro International; GW BASIC, Microsoft, Inc.; PolyWindows, POLYTRON; K-Desk, Kaypro Corporation. *For the first 90 days after purchase, Kaypro assures that any major IBM-compatible business software will run on the KAYPRO PC or they will grant a trade-in credit toward the purchase of an IBM PC. Trade-in for IBM PC is available only through original Kaypro dealer, and IBM suggested retail price applies.

Simply put: THE™ highest quality and best value in computer products anywhere.

THE™ commitment to our customers is compatibility, quality, value, service and support

THE™ backs every product with a 45 DAY MONEY BACK GUARANTEE

and a FULL 1 YEAR PARTS AND LABOR WARRANTY

THE™ MULTI 384

This multi-function card features 0-384K memory, a parallel printer port, a serial port for communications, a clock/calendar with battery backup, and a software bonus that includes RAMdisk and other utilities. Retail \$90.00

\$67.00*
Special Wholesale Price



BEST BUY
Functional Clone of AST™ SixPackPlus

THE™ COLOR CARD

100% compatible with the IBM™ colorcard with display modes of 80x25 alphanumeric and 320x200 graphic. Retail Price \$75.00

Special Wholesale Price **\$60.00***

THE™ 576K MEMORY +

Supports 0-576K of available memory and is compatible with all IBM™ PC's. Retail \$46.25

Special Wholesale Price **\$35.00***

THE™ PRINTERFACE

Supports all text and graphics features and is fully compatible with third party software. Retail Price \$23.13

Special Wholesale Price **\$18.50***

THE™ MODEMS

100% Hayes compatible

THE™ 1200 COM EXTERNAL

This self-testing 1200 BPS modem comes with auto answer, auto dial, auto redial and a built-in speaker. Retail Price \$161.25*

Special Wholesale Price **\$129.00***



THE™ 1200 COM INTERNAL

Features auto answer, dial and redial, with a built-in speaker, RS 232-C serial port and PC Talk III. Retail Price \$148.75

Special Wholesale Price **\$109.00***

THE™ 2400 COM EXTERNAL

Eight times the speed of a 300 BPS unit makes this 2400 Baud modem truly affordable, and we've made it truly compatible. With auto answer, auto dial, auto redial, and a built-in speaker with volume control. Retail Price \$346.25

Special Wholesale Price **\$259.00***

THE™ H720 MONO

This monochrome graphics card with printer port features 100% IBM™ and Hercules™ compatibility, at a fraction of their prices. Retail Price \$91.25

\$73.00*



BEST BUY
Functional Clone of Hercules Graphics Card

A \$120.00 VALUE!

ADAM OSBORN'S PAPERBACK SOFTWARE

- Paperback Writer
- Paperback Speller
- Numberworks Spreadsheet

All three for only... **\$32.00***

With the purchase of a PC+



THE™ 20MB HARD DISK

Featuring a half-height IBM™ PC compatible internal 20MB disk drive, controller card, connecting cables and installation manual. Retail \$458.75

Special Wholesale Price **\$357.00***

THE™ MULTI I/O

Feature for feature, THE™ matches the AST™ I/O + and comes up a winner, with serial/parallel and game ports standard, (a second serial port optional), a clock/calendar, RAMdisk and print spooler. Retail Price \$75.00

\$60.00*



BEST BUY
Functional Clone of AST™ I/O +

THE™ EGA PLUS

With 256K standard this 100% IBM™ EGA and Hercules Graphics compatible card is ideal for high resolution graphics display of Microsoft™ Windows, Lotus™ and AutoCAD™. Retail Price \$283.75*

Special Wholesale Price **\$220.00***

*All Items Subject to Availability—Prices Subject to Change
TM—Registered Trademarks of IBM Ast Research/
Microsoft/Hercules/Hayes

THE™

Thompson, Harriman and Edwards
Computer Products Company Ltd.

THE™ PC + COMPUTER

THE™ PC + is compatible with all business, professional and personal software written for the IBM™ PC. It will also enhance your productivity with its ability to switch to an 8 megahertz clock rate, enabling you to run your software twice as fast as the IBM™ PC. THE™ PC + also comes standard with an "AT" style keyboard, correcting the inefficiencies found by IBM™ on their regular PC keyboard. 256K standard (640K optional) on the mother board will allow you to run memory intensive programs such as Lotus 1-2-3, DBase III and Framework without adding extra memory cards. Plenty of power, with a 135 Watt source and lots of room for expansion with 8 card slots is also standard. Base unit includes: 256K RAM, Computer with One 360K 5¼" Floppy Drive, Dual Turbo Clock Speed, 8 Expansion Slots, 135 Watt Power Supply, "AT" Style Keyboard, Full 1 Year Warranty and 45 Day Money Back Guarantee!
Retail Price \$586.25*

Special Wholesale Price
\$444.00*
(Monitor Not Included)

All THE products in this special sale are offered thru

PC Network

*All prices in this ad are wholesale—PC Network Members pay wholesale + 8% and shipping.

CALL TOLL FREE B3NY

(800) 621-SAVE

In Illinois (312) 280-0002

**THE MOST INCREDIBLE
LIMITED TIME OFFER IN
COMPUTER HISTORY, FROM
THE™ and PC NETWORK...**

THE™ PC

**256K RAM,
IBM™ PC
compatible,
360K 5.25"**

**Disk Drive,
Turbo Speed,
"AT" Style
Keyboard**

Special Wholesale Price

\$444.00*

\$469.00* for 640K System

Products Company Ltd.

Dealer Inquiries Call THE™ at (312) 642-9626
319 West Ontario Street, Chicago, Illinois 60610

PC NETWORK

BUY HARDWARE AND SOFTWARE AT WHOLESALE + 8%, AND GET 14-30 DAY SOFTWARE RENTALS†...

Listed below are just a few of the over 30,000 products available at our EVERYDAY LOW PRICES!
The Network carries products for Apple, IBM, CP/M and most other popular computer families.

OUR ROSTER INCLUDES SOME OF THE MOST IMPORTANT NAMES IN INDUSTRY

AT&T	General Motors
Barclays Bank	Gillette
Bell & Howell	Hewlett Packard
Citibank	Hughes Aircraft
Columbia University	IBM
Exxon	ITT
Farm Bureau Insurance	Kodak
General Electric	Yale University

Plus 150,000 satisfied consulting firms, small businesses, governments, schools and value minded individuals.

GAMES & EDUCATIONAL SOFTWARE

(Please add \$1 shipping and handling for each title ordered from below.)

Wholesale	Wholesale	Wholesale
Bluechip Millionaire, Oil Baron or Tycoon \$28.99*	Mouse Systems PC Paint-Turn your PC into a Color Macintosh 559.95*	
Broderbund Ancient Art of War 22.75*	Pinpoint Publishing Micro Cookbook 21.00*	
Broderbund Lode Runner 17.25*	Scarborough Master Type 18.75*	
Comprehensive Intro to Personal Computing 30.00*	Sierra On-Line King's Quest II 24.75*	
Davidson Math Blaster, Word Attack! 21.50*	Spectrum Holobyte GATO 23.99*	
Epyx Winter Games/Temple Apathi/Summer Games II 20.00*	▶ Spinnaker Alphabet Zoo, Kinder Comp 15.25*	
Hayden Sargon III 24.75*	▶ Story Machine, Face Maker, Hey Diddle Diddle, Rhymes & Riddles	
Individual The Instructor 24.50*	▶ Spinnaker Delta Drawing or Most Amazing Thing 20.75*	
▶ Infocom Zork I or Witness... Tiny 20.00*	Sublight Night Mission Pinball 20.00*	
▶ Infocom Deadline or Suspended 24.00*	Sublight Jet 27.50*	
Microsoft Flight Simulator \$27.00*	TimeWorks Evelyn Wood Dynamic Reader 41.00*	
Mindcape The Mist: First Blood Pt. 2/or View to a Kill 21.00*		

BUSINESS SOFTWARE

(Please add \$2.50 shipping and handling for each title ordered from below.)

ANSA Paradox \$445.00*	MicroPro Wordstar 2000 \$209.00*
▶ Ashton-Tate DBase III+ 365.00*	MicroPro Wordstar 2000+ 259.00*
▶ Ashton-Tate Framework II 365.00*	MicroRim R Base 5000 215.00*
Borland Reflex 64.00*	MicroRim R Base System V 339.00*
Borland SideKick (Protected) 26.00*	Microsoft C Compiler 215.00*
Borland Turbo Pascal 35.00*	Microsoft Word—Latest Version 3.0 202.00*
Borland Turbo Pascal 8087 53.00*	Microsoft Multiplan 98.00*
Borland SuperKey 34.50*	Might Ability 55.00*
Breakthrough Software Time Line 2.0 203.00*	Monogram Dollars & Sense 85.00*
Central Point Copy II PC 16.25*	Mosaic The Twin 75.50*
Computer Associates Supercalc IV 239.95*	▶ Multimedia Multimedia (Latest Version) 270.00*
Computer Associates Super Project Plus 239.95*	Multimedia Multimedia Advantage 180.00*
Digital Research Gem Draw 73.00*	▶ Meca Managing Your Money 92.00*
Electronics Energraphics 145.00*	Nantucket Clipper DBase III Compiler 350.00*
FGS Fastback 85.00*	Norton Commander 36.00*
Funk Software Sideways 32.00*	Norton Utilities 3.1 43.00*
Harvard Harvard Total Project Manager 245.00*	Open Systems AVR INV G/A P/Ver. 3.X ea. 395.00*
Hayes Smartcom II—New VT 100 Emulator 68.00*	Power Base Power Base 200.00*
Human Edge The Management Edge 45.00*	RoseSoft ProKey Version 4 65.00*
Human Edge The Sage's Edge or Mind Prober 24.00*	Satellite Software Word Perfect 160.00*
Infocom Cornerstone 70.50*	Software Group Enable 293.00*
Litetree Volkswriter III 126.00*	Software Publishing PFS: File, Write, Graph 68.00*
Living Videotext Think Tank 87.00*	Software Publishing PFS: Report 64.00*
Lotus Lotus 1-2-3 280.00*	

HARDWARE

(Please add shipping and handling charges found in Italics next to price.)

COMPLETE SYSTEMS	MULTIFUNCTION CARDS
Apple Macintosh/Apple IIc/IIe CALL (38/34)	▶ AST SixPakPremium™ w/6K \$315.00* (2.50)
AT&T 6300 PC CPU2 \$1,775.00* (38/34)	▶ AST SixPakPlus™ with 64K 139.00* (2.50)
640K/2 Floppy/1 Serial/1 Parallel/Mono Monitor 1,810.00* (41.26)	▶ AST I/O Plus II™ 120.00* (2.50)
COMPAQ Hard Disk 20MB 1,910.00* (41.26)	▶ AST Advantage for AT 325.00* (2.50)
Compaq Floppy 20MB w/256K 1,807.00* (39/33)	▶ Orchid Conquest 220.00* (2.50)
COMPAQ DeskPro 1,807.00* (39/33)	▶ Orchid Tiny Turbo 286 420.00* (2.50)
Hard Disk 20MB w/256K 1 Floppy 1,025.00* (22.14)	▶ Tecmar Captain Multifunction Card 6K 109.00* (2.50)
▶ IBM PC Base System 1,025.00* (22.14)	▶ THE™ 576K Memory + Board w/OK 35.00* (2.50)
2 DS/DD FD-360/256K 1,337.00* (28.88)	▶ THE™ Multi 384 A functional clone 67.00* (1.62)
▶ IBM PC Professional 1,337.00* (28.88)	
20MB Hard Disk	
IBM PCAT All Configs CALL	
IBM PCAT Base Unit 2,875.00* (60.37)	
1.2MB Floppy w/256K	

DISK DRIVES & CONTROLLERS

IOmega Bernoulli Box/Dual MP Drives \$1,710.00* (36/94)	
▶ PC Network 10MB Internal 1/2 Height 299.00* (6.46)	
▶ PC Network 10MB Tape Backup 340.00* (9.48)	
Same Unit used in Compaq's DeskPro 495.00* (10.69)	
PC Network 20MB Tape Backup 495.00* (10.69)	
Hill Height w/Controller 75.00* (1.68)	
▶ PC Network Hard Height DS/DD Drive 438.00* (9.40)	
Tandon 20MB Hard Card 438.00* (9.40)	
▶ THE™ 20MB Hard Disk Hard Disk 735.00* (15.88)	
▶ THE™ 20MB 20MB Hard Disk 357.00* (7.93)	
Autoboot Drives by Seagate or Microscience	

MEMORY CHIPS

All chips guaranteed for life.

▶ 64K Memory Upgrade Kits (9 chips) \$7.75* (1.00)	
▶ 64K Dynamic Ram Chips (Each) 1.00* (1.00)	
▶ 256K Dynamic Ram Chips (Each) 2.90* (1.00)	
▶ 128K AT Mother Board Chips (Each) 5.50* (1.00)	
▶ Intel 8087 Co-Processor 99.50* (2.15)	

MODEMS

▶ Hayes Smartmodem 2400 \$525.00* (5.00)	
Hayes Smartmodem 1200B with new Smartcom II VT 100 Emulator 315.00* (2.50)	
Hayes Smartmodem 1200 340.00* (5.00)	
Prometheus Pmodem 1200 247.00* (6.00)	
U.S. Robotics Courier 2400BPS Modem 345.00* (5.00)	
U.S. Robotics Password 172.00* (2.50)	
ALL THE™ MODEMS ARE 100% HAYES COMPATIBLE	
▶ THE™ 1200 Com External 119.00* (2.58)	
▶ THE™ 2400 Com External 253.00* (5.54)	
▶ THE™ 1200 Com Internal w/Free PC Talk III 109.00* (2.50)	

MONITORS

Amdek Video 310 A Amber TTL Monitor \$130.00* (3.00)	
Amdek Color 600 High Res RGB Monitor 365.00* (7.88)	
Amdek Color 722 NEW! Enhanced 424.00* (9.16)	
Magnavox Amber IBM Type TTL Monitor 79.00* (5.00)	
Magnavox 14" RGB Color Monitor 640x240 275.00* (5.00)	
NEC JC-1401 Multisync RGB Color Monitor 480.00* (10.37)	
Princeton HK-12 RGB Monitor 365.50* (7.98)	
Princeton HK-12E VGA or EGA Monitor 388.00* (5.00)	
Princeton MAX-12E 138.00* (5.00)	
Supports Either Mono or RGB Cards	
Taxan 630 High Res RGB Monitor 383.00* (8.27)	
Taxan 640 Highest Res (720x400) 439.00* (8.27)	
Currently Available—Works with Persyst BOB Card	

VIDEO CARDS

Hercules Color Card w/Parallel Port \$126.00* (2.50)	
Hercules Monochrome Graphics Cards 162.00* (2.50)	
Paradise Autoswitch EGA 336.00* (2.50)	
Orchid Turbo EGA Card 250.00* (2.50)	
Quadram Quad EGA + 323.00* (2.50)	
▶ THE™ EGA Plus w/256K and printer port 227.00* (2.50)	
▶ THE™ H730 Mono Graphics w/parallel port 73.00* (2.50)	
100% Hercules Compatible!	
▶ THE™ Color Card 100% IBM Compatible 60.00* (2.50)	

ACCESSORIES AND SUPPLIES

▶ Brand Name DS/DD Diskettes \$7.95* (1.00)	
Guaranteed for Life/Not Generic	
▶ DS/DD Bulk Pack Special ea. \$4*	
Guaranteed for Life!	
▶ PC Network Replacement 130 Watt IBM-PC, 78.00* (2.70)	
Power Supply—Gives you PC (Old or New) the same capacity as an XT. Good for adding tape drives (without need for a piggyback unit) and large capacity disk drives.	
SMA PC Document Keyboard Templates ea. 9.99* (1.00)	
for Lotus/DBase/Multimedia and others	
Sony DS/DD Diskettes 15.95* (1.00)	
WP Printer Paper per 2600 Sheets 17.00* (1.00)	
Microline Perfs (invisible when torn)	

†RENT BEFORE YOU BUY—Members are eligible to join the NETWORK'S Business and Game Software Rental Libraries to evaluate products for a full 14 (Regular) or 30 (VIP) days to see if they meet your needs. And the NETWORK'S rental charges are far less than other software rental services—JUST 20% OF THE MEMBER WHOLESALE PRICE. We feature over 1,000 available titles in IBM/Apple/Mac and CP/M.

PRINTERS

Epson

FX 286

132CPS/200CPS Letter Quality Printer

\$440.00*

FX-85 80COL/160CPS 355.00*
LQ-800 180COL/60CPS Par 519.00*
LQ-1000 180COL/60CPS Par/Ser NLQ 699.00*

TOP BUSINESS PROGRAMS FOR THE IBM™ PC/XT/AT

LOTUS 1-2-3 \$280.00*
ASHTON TATE DBASE III \$365.00*
SATELITE BUSINESS WORD PERFECT \$180.00*

COMPLETE SYSTEMS

(Optional local warranty service available in most major metro areas)

IBM PC BASE SYSTEM

IBM PC w/256K Floppy Drive Controller 2 Double Sided Double Density Disk Drives Mix and Match with your Favorite Monitor and Printer!

\$1,025.00*

CUSTOM CONFIGURATIONS WELCOME



IBM PC HARD DISK SYSTEM

IBM PC w/256K Floppy Drive Controller 1 Double Sided Double Density Disk Drive Half Height Hard Disk

w/20MB
\$1,337.00*

CALL FOR LATEST IBM ANNOUNCEMENT!

PORTABLE HARD DISK SYSTEM

256K/1Floppy/20MB Hard Disk



\$1,910.00*

DESKPRO SYSTEM

256K CPU/1 Floppy/Hard Disk



\$1,999.00* w/30MB
\$1,807.00* w/20MB

64K IBM PC E

Lifetime Guarantee!

Set of 9 150/200ns

\$7.75*



256K Set of 9 \$26.10*
128K For the AT 35.10*

INTEL™ Math Co-Processors

8087 5Mhz \$99.50*
8087 8Mhz 161.00*
80287 5Mhz/8Mhz 197.00*

DISKETTES

Guaranteed for Life!

Brand Name Diskettes available in boxes of 10, or in bulk packs of 50

\$7.95*
Bx.

\$6.95*
Bx. 10 Box 50



New from THE™

**THE™
20MB
HARD DISK
CARD**

\$375.00*



**1/2 Height 360K
DS/DD Floppy
Disk Drive
\$75.00***



**THE™ 20 + 20
20MB Hard Disk
20MB Tape Backup
\$735.00***



**THE™ 20MB
Hard Disk Kit
\$357.00***

*Members pay 8% above this wholesale price plus shipping.

CALL TOLL FREE 1-800-621-SAVE (orders and memberships)

In Illinois call (312) 280-0002 Validation Code: B3Y6

Customer Service and Order Status (312) 280-1567

TM & R—Registered Trademarks of IBM/COMPAQ/APPLE/AST Research/Lotus/Multimate/IOmega/Hayes/Hercules

Inquiry 228

PC NETWORK

SEE WHY OVER 150,000 HAVE JOINED MAKING US THE NATION'S #1 SOURCE FOR EVERYTHING IN COMPUTING

- **Our 600 Page Wholesale Catalog**
Over 30,000 products priced at Wholesale + 8%. Anything you will ever need at a Consistent low price.
- **Quarterly Catalog Updates**
Your Catalog is never obsolete! Keep on top of the newest products and latest price changes.
- **The Printout**
Our newsletter gives you fantastic specials along with unbiased analysis of new products and industry trends.
- **10 Day Returns on any Hardware!!**
If you don't like any hardware product—for any reason—return it for a refund.
- **1000 + Title Rental Library**
14 to 30 day rentals on over 1000 different titles. Try before you buy!!
- **Size, Strength and Stability**
The Network has over 150 employees, 45,000 square feet of office and warehouse space, inventory valued in excess of \$15,000,000 and is ranked the largest computer product supplier in the nation! Our commitment is to serve our customers and our 90% repeat business rate is proof!!
- **OnLine™ Bulletin Board**
Download "Freeware" from the nation's largest single concentration of Public Domain software available! Get tied into the nation's largest technical information network! Place orders, get tech support or contact customer service from the Network's OnLine, not just a bulletin board but a complete customer information network.

CALL TOLL FREE
1-800-621-S-A-V-E

(Orders—Membership and Advice!)

In Illinois call (312) 280-0002

Your Membership Validation Number

B3Y6



You can validate your membership number and, if you wish, receive your first money-saving order over the phone by using your VISA, MASTERCARD or AMERICAN EXPRESS. Our knowledgeable sales consultants are on duty Mon.-Fri. 8:00 to 7:00PM, SAT. 9:00AM to 5:00 PM CST.

PERSONAL COMPUTER NETWORK

320 West Ohio
Chicago, Illinois 60610

Call now... Join the PC NETWORK and start saving today!
Customer Service and Order Status (312) 280-1567
8:30AM to 4:30 PM, Mon.-Fri. CST



PC NETWORK • MEMBERSHIP APPLICATION

YES! Please enroll me as a member in the PC Network™ and send my catalog featuring thousands of computer products, all at just 8% above DEALER WHOLESALE PRICES. I will also periodically receive "THE PRINTOUT," a special up-date on merchandise at prices BELOW even those in my wholesale catalog, and all the other exclusive money-saving services available to Members.

3Y6

I am under no obligation to buy anything. My complete satisfaction is guaranteed. Please check (✓) all boxes that apply:

- | | |
|--|---|
| <p>Basic Membership
with optional 14 Day Evaluation.</p> <p><input type="checkbox"/> One-year membership for \$8</p> <p><input type="checkbox"/> Two-year membership for \$15 (Save \$1)</p> <p><input type="checkbox"/> Business Software Evaluation Library for \$25 add'l. per year—with 14-day returns</p> <p><input type="checkbox"/> Games Software Evaluation Library for \$10 add'l. per year</p> | <p>Special V.I.P. Membership*
with optional 30 Day Evaluation.</p> <p><input type="checkbox"/> One-year membership for \$15</p> <p><input type="checkbox"/> Two-year membership for \$25 (Save \$5)</p> <p><input type="checkbox"/> BOTH Business and Game Software Evaluation Libraries for \$30 add'l. per year—with 30 day returns</p> <p>*V.I.P. members may receive advance notice on limited quantity merchandise specials</p> |
|--|---|
- Bill my credit card: VISA MasterCard American Express

Account Number:

Exp. Date: _____
mo. year

Check or money order enclosed for \$_____

Name: _____

Address: _____

City: _____ State: _____ Zip: _____

Telephone (): _____

My computer(s) is: IBM PC IBM-XT IBM-AT Apple II
 Macintosh Other _____

Signature: _____ (Signature required to validate membership)

This Breakthrough Just Broke Through. Again.



When the Leading Edge® Model "D"™ Personal Computer was first introduced, it stunned the world by being the first and only IBM®-compatible to come with more standard features than the IBM PC at about half the price.

It's been over a year since then. We think it's time to stun the world again.

Since the Model "D" already comes with dual-drives, high-resolution monochrome monitor, monochrome and color graphics output, parallel and serial ports, and free word processing software, there was only one thing to add: memory. So we beefed it up to **512K** (expandable to 768K on the motherboard).

But there was something to drop. The price. We reduced it to **\$1295**.

Then we added a 30MB fixed-disk version of the Model "D" and priced it at **\$1995**, including word processing with spelling correction and a Lotus 1-2-3® look-alike spreadsheet.

And to make sure nobody would be left unstunned this time around, we created the Leading Edge Information System™ — a Model "D" Personal Computer with a built-in 1200 baud Hayes®-compatible modem and communications software — and priced it at an incredible **\$1495**. It also comes with word processing with spelling correction and a Lotus 1-2-3 look-alike spreadsheet.

Of course, every system comes with a 15 month warranty, a full-year longer than IBM's, and easy-to-use instruction manuals.

So if you missed it last time, don't this time. Breakthroughs like this don't happen too often. Call **1-800-USA-LEAD** for more information and a dealer near you.

Leading Edge Hardware Products, Inc.
225 Turnpike Street, Canton, MA 02021
1-800-USA-LEAD in Massachusetts (617) 828-8150



Leading Edge is a registered trademark and Model "D" and Model "L" are trademarks of Leading Edge Products, Inc. IBM is a registered trademark of International Business Machines Corp. Hayes is a registered trademark of Hayes Microcomputer Products, Inc. Lotus is a registered trademark of Lotus Development Corp.

THE IBM PC CONVERTIBLE

*A portable that offers many different options
and up to 512K bytes of memory*

BY G. MICHAEL VOSE

Editor's note: The following is a BYTE product description. It is not a review. We provide an advance look at this product because we feel that it is significant. We plan to provide a complete review in a subsequent issue.

IBM'S PC Convertible looks like a portable computer complete with a movable handle but feels more like a transportable computer, such as the Compaq. Packed in its optional carrying case, the PC Convertible and battery pack weigh over 15 pounds, a little over one-half the weight of a Compaq. The machine offers up to 512K bytes of memory, 1.4 megabytes of on-line disk storage, and a readable 80-column by 25-line liquid-crystal display, as well as IBM PC compatibility.

The Convertible's many options include a parallel/serial adapter, a portable printer, a monochrome and color display adapter, a 9-inch monochrome or 13-inch color monitor on its own pedestal, 128K-byte memory upgrades, and an internal 110/300/1200-baud modem. These options can increase the Convertible's base price from \$1995 to as much as \$3000.

IBM supplies some bundled software with the Convertible, including several notebook-like applications for note-taking, phone-number files, and the like. However, the Convertible uses 3½-inch disks, so obtaining other



software for the machine presents a problem.

MACHINE INTERNALS

A CMOS version of Intel's 8088 microprocessor powers the PC Convertible. Driven by a 33 percent duty-cycle crystal similar to the IBM PC's, this 14.31818-MHz oscillator's frequency is divided by three to drive the 80C88 at 4.77 MHz. The 80C88's internal circuitry is static, eliminating the need for refresh clock cycles for its on-chip registers, counters, and latches. The 80C88's clock-cycle time is 210 nanoseconds and the Convertible's main-memory cycle is 840 ns, while the I/O cycle is 1.05 microseconds.

The Convertible uses a system timer compatible with the Intel 8253 Pro-

grammable Interval Timer, and it provides two programmable channels. The base timing resolution for a timer channel is 840 ns. The interrupt controller on the Convertible duplicates the functions of the Intel 8259 Programmable Interrupt Controller. This interrupt controller provides nine interrupt levels, one of which is nonmaskable. The system clock, interrupt controller, and other devices (keyboard controller, audio controller, and I/O controller) reside on the motherboard in a VLSI gate-array chip. Another gate array houses the disk and printer interface circuitry, time-of-day clock, and system timer. All the Conver-

tible's circuitry, including a total of five gate arrays, resides in just 19 surface-mounted chips on the machine's motherboard (see photo 1).

The Convertible's standard 256K bytes of nonparity-checked RAM resides on two small removable circuit boards located just under the machine's keyboard. To add an additional 256K bytes of RAM to the machine, you plug two similar 128K-byte boards alongside the existing ones for a total of four boards. The Convertible's static RAM features 256K by 1-bit chips. *[Editor's note: Peripheral manufacturer STB Systems has already announced a 384K-byte*

(continued)

G. Michael Vose is a senior technical editor for BYTE (One Phoenix Mill Lane, Peterborough, NH 03458).

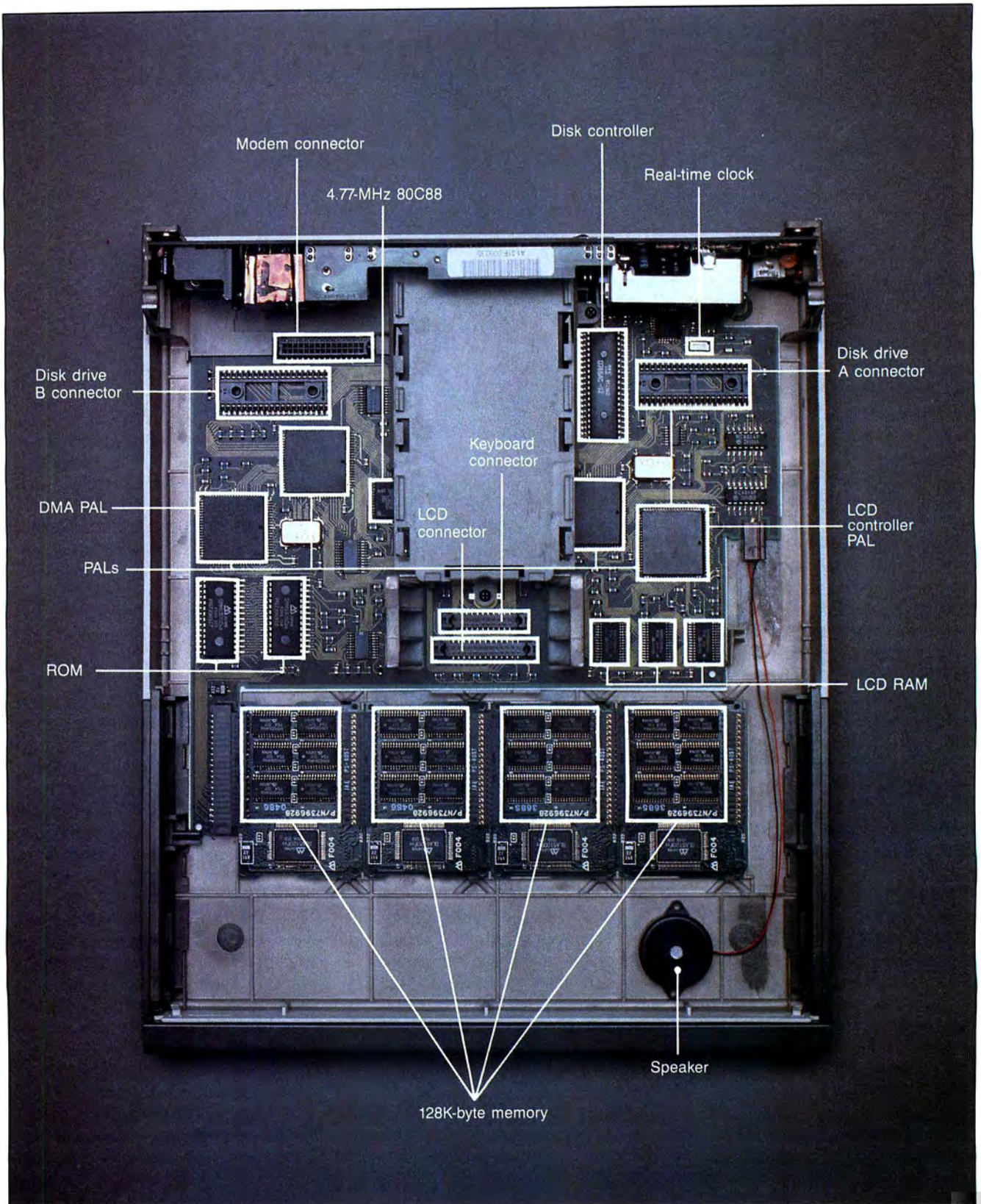

Photo 1: The sparsely populated PC Convertible main circuit board and 128K-byte memory boards.

expansion board that lets the Convertible use a full 640K bytes of RAM; see the *What's New* item on page 14.]

Two 32K-byte ROMs contain the PC Convertible's on-board system software. The machine's resident BASIC uses 32K bytes and the POST (power-on self-test) and BIOS routines occupy the other 32K bytes in separate 24K and 8K segments.

The two 3½-inch disk drives in the PC Convertible offer formatted storage of 720K bytes per disk. The disks used by these drives store data at 135 tracks per inch (80 tracks per side) and can be accessed by the drives at 6 milliseconds track to track. The maximum data-transfer rate is 250K bytes per second. The NEC μ PD765 floppy-disk controller manages the I/O control of the disk drives.

The Convertible's DMA (direct memory access) controller is compatible with the Intel 8237 programmable DMA controller and regulates the movement of data from memory to I/O devices without involving the microprocessor. Since the Convertible's static RAM requires no refreshing, the DMA controller does not support refresh; therefore, it supports three DMA channels instead of four (as in the IBM PC) and uses five clock cycles (1.05 μ s per byte) for every DMA data transfer. The 16-bit control registers in the DMA controller require the use of a page register to develop the 20-bit addresses possible within the Convertible's 1-megabyte addressable memory. The DMA controller does not support memory-to-memory data transfer, cascading, or automatic initialization.

To beep error messages or to play music, the Convertible uses a small speaker on the motherboard controlled by an audio controller that receives its signals from the system timer and the I/O controller.

The LCD measures 3¾ inches high by 10¾ inches wide (see photo 2). It displays 25 lines of 80 characters at a resolution of 640 by 200 pixels. The LCD disconnects from the Convertible's system unit via a 20-pin male/female edge connector for the convenience of users who elect to use an

optional monochrome or color display. The LCD is not backlit but is adjustable for accommodating ambient room light. The aspect ratio of the LCD differs from standard CRT devices by about 20 percent.

The LCD controller uses an interface similar to that of the Motorola 6845 CRT controller, and thus allows the operation of programs written to use the IBM monochrome display adapter or the IBM color/graphics display adapter. The LCD controller has its own 16K bytes of video RAM and uses either the main font (the IBM PC character set) or an alternate font to display up to 256 characters per font.

The keyboard on the Convertible is similar at first glance to the PCjr keyboard—function keys in a row across the top, a small function key on the bottom left, and a cluster of cursor keys on the bottom right. However, the similarity to the PCjr ends here. The Convertible has 78 keys on a keyboard with a surprisingly solid feel for such a small device (see photo 3). The Convertible keyboard generates all the scan codes recognized by the IBM PC BIOS and includes an Alternate key and a Control key.

SUPPLYING POWER

There are four ways that a PC Convertible can get electricity: an AC adapter, a battery pack, a battery charger, or an automobile adapter that plugs into an automobile ciga-

rette lighter. You can use the battery charger only to charge the batteries, not to run the computer. The AC adapter and the automobile adapter will run the Convertible and charge the battery pack at the same time. The AC adapter uses 90- to 265-volt, 50/60-Hz electrical-source power.

The battery pack supplied with the PC Convertible has eight nickel-cadmium cells and, when fully charged, can power the machine for 6 to 10 hours depending on the installed memory and the use of disk drives and attached peripherals. If the battery-pack power gets low, an icon that looks like a flashlight battery blinks in the upper right corner of the screen to warn you to correct the problem. Recharging the Convertible's battery is a 12- to 14-hour process after you see a low-power warning.

To preserve power, the Convertible will power down if there is no disk or keyboard activity for two minutes. During its power-down operation, it saves a variety of information about the state of the machine at the time of shutdown.

OPTIONAL HARDWARE

Since the PC Convertible has no external connectors for serial or parallel printers, the serial/parallel adapter is an important option. IBM gets away with making these ordinarily indispensable outputs optional by offering

(continued)

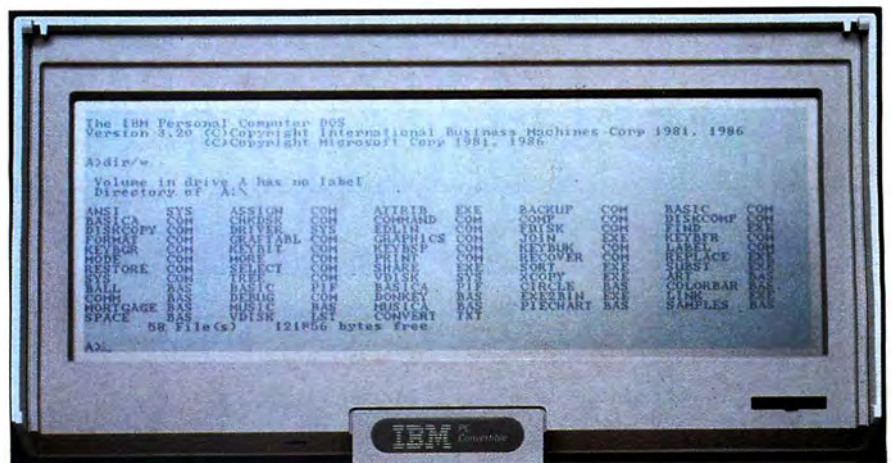

Photo 2: The PC Convertible's LCD screen.

a low-power, thermal-transfer, serial dot-matrix printer that attaches to the Convertible's system bus. However, many users will elect to use their own printers rather than buy another one, and those users must buy the adapter. The serial/parallel adapter attaches to the back of the Convertible, connecting to the 72-pin system bus. The system bus is brought out on the other side of the adapter so that you can still attach other peripherals to the computer.

The serial/parallel adapter differs slightly from the IBM PC's in the way that it implements the functions of the PC's asynchronous communications adapter. The Convertible's BIOS contains routines that allow control of local power on the serial adapter. Additionally, the maximum data-transfer rate of the serial/parallel adapter's serial port is 9600 baud.

Another important Convertible option is the internal modem. This modem was not available for my use, so I have to take IBM's word that it actually exists. According to IBM, this modem is an auto-answer, auto-dial device that supports tone or pulse dialing. It supports full-duplex operation at 110, 300, or 1200 baud, conforming to the frequency specifications of the Bell 103A or 212A standards. The modem is not Hayes-compatible.

The PC Convertible printer runs off either the computer's battery pack or separate AC power. Weighing in at 3½ pounds, it prints unidirectionally at 40 characters per second in one pitch (10). The printer uses a 24-pin, thermal-transfer, nonimpact, dot-matrix print head that requires either thermal paper, a thermal-transfer ribbon and thermal-transfer paper, or

high-quality (20-pound or less) plain paper. Supporting condensed, double-wide, and emphasized print modes, the printer will underline text and can print sub- and superscripts.

OTHER OPTIONS

For LCD haters, IBM offers several display options including monochrome, color, and TV (RF modulator) adapters. IBM also sells a 9-inch monochrome or 13-inch color monitor attached to its own tiltable pedestal for use with the Convertible. The distance between the bottom of the pedestal and the CRT is sufficient to slide the Convertible neatly between the two. The monochrome and color monitors run only on AC power, so you'll be stuck with the LCD at the beach unless you have a long extension cord.

The CRT display adapter supports these direct-drive or composite monitors: the PC Convertible monochrome and color displays, the IBM PCjr color display, the IBM PC color display, or a standard TV set (using the IBM PCjr connector for TV). You can also use any IBM-compatible monitor with the Convertible. Since you'll have to be close to an AC outlet to use a monitor, IBM specifies that you must use the AC adapter to operate the Convertible when the CRT display adapter is connected to the computer. I used the machine without the AC adapter with no apparent ill effects, but I'm sure IBM advises against this practice to avoid quickly draining the battery.

My favorite option for the PC Convertible is the carrying case. It is made of canvas with lots of foam padding, and its design reminds me of a military flak jacket (its color is a conservative gray.) This carrying case will lend an air of strategic importance to your portable computing.

PC CONVERTIBLE SOFTWARE

The PC Convertible uses PC-DOS 3.2 to manage its hardware resources. Since it is a fully IBM PC-compatible computer (assuming, as IBM insists, that applications software makes BIOS and DOS calls only), the Convertible will run any IBM PC software.



Photo 3: The PC Convertible case and keyboard.

However, the availability of your favorite software on 3½-inch disks could be a problem. At BYTE we use the Manzana MDP3A disk drive with accessory package software (\$495 from Manzana, 935 Camino del Sur, Isla Vista, CA 93117, (805) 968-1387) to transfer software to the 3½-inch format for test purposes. I copied my favorite word-processing program onto a formatted 3½-inch PC Convertible disk and used it to write this article. I reformatted the disk after I copied the article back to a 5¼-inch disk.

Concurrent with the Convertible's debut, IBM announced two versions of a 3½-inch stand-alone disk drive for use with all the computers in the PC family. The availability of this drive (which requires PC-DOS 3.2) makes porting non-copy-protected software to the 3½-inch format less of a problem.

If you cannot acquire software on 3½-inch disks, you can still use a PC Convertible. The Convertible comes with an applications disk that contains a note writer, a scheduler, a phone list, a calculator, and some help files and utilities.

The note writer lets you create, save, and print notes up to six pages (12,000 characters) in length. You can adjust the left and right margins, do block moves or copies, and display a directory of existing notes. You cannot adjust line spacing or delete blocks.

The scheduler lets you set up a calendar of daily, weekly, or monthly appointments. You can set an audible alarm and mark appointments with an asterisk to remind you of important dates. You can even print out your weekly or daily schedule. You can set up the schedule profile with any start and end time and specify the time increment from 5 to 60 minutes.

The phone list lets you create and store name, address, and phone-number files. The program will even auto-dial numbers in the file if you have an internal or external modem attached to your Convertible.

The calculator adds, subtracts, multiplies, divides, figures percent-

ages, and prints a log of your calculator operations.

The utilities supplied with the Convertible, called tools, mostly assign standard DOS functions such as FORMAT, ERASE, and DISKCOPY to the function keys for single-keystroke invocation.

CONCLUSIONS

In BYTE, product descriptions give readers a first look at hardware or software prior to an in-depth product review. Therefore, I will make no judgments about the PC Convertible other than to say that it was easy to set up, add optional equipment to, and use to write this article. The machine worked without any failures during the few days I used it. I found the LCD to be readable for short stretches; however, I used the monochrome display for my longer text-composition stints. I like the keyboard as well as that of any portable computer I've tried. The layout of the Convertible's disk drives is attractive and useful.

How compatible is the PC Convertible? IBM makes no secret of the fact that the BIOS microcode is not identical to that of other IBM PC models. Programs that bypass the BIOS and directly access the hardware of IBM PCs might not run correctly on the Convertible as a result.

Many of the Convertible's incompatibilities are subtle. For example, the LCD can display reverse video but not high-intensity text. Another subtle incompatibility is the machine's static RAM; since the RAM needs no refresh, there are more microprocessor cycles available for any set period of time, making the processor appear to run faster. This apparent speed increase can affect programs that use timing loops for delays.

If you plan to write software for the PC family and want to have your program check to see if it is running on a Convertible, you can read the value in memory location FFFF—a hexadecimal value of F9 means the machine is a Convertible.

Editor's note: See the editorial on page 6 for a discussion of some other IBM PC-family compatibility issues. ■

TURBO PROGRAMMERS—

... CUTS DEBUGGING FRUSTRATION.

TDebugPLUS is a new, interactive symbolic debugger that integrates with Turbo Pascal to let you:

- **Examine and change variables** at runtime using symbolic names—including records, pointers, arrays, and local variables;
- **Trace and set breakpoints** using procedure names or source statements;
- **View source code** while debugging;
- **Use Turbo Pascal editor and DOS DEBUG commands.**

TDebugPLUS also includes a special MAP file generation mode fully compatible with external debuggers such as Periscope, Atron, Symdeb, and others—even on programs written with Turbo EXTENDER.

An expanded, supported version of the acclaimed public domain program TDEBUG, the TDebugPLUS package includes one DSDD disk, complete source code, a reference card, and an 80-page printed manual. 256K of memory required. Simplify debugging! \$60 COMPLETE.

TURBO EXTENDER™

Turbo EXTENDER provides you the following powerful tools to break the 64K barrier:

- **Large Code Model** allows programs to use all 640K without overlays or chaining, while allowing you to convert existing programs with minimal effort; makes EXE files;
- **Make Facility** offers separate compilation eliminating the need for you to recompile unchanged modules;
- **Large Data Arrays** automatically manages data arrays up to 30 megabytes as well as any arrays in expanded memory (EMS);
- **Additional Turbo EXTENDER tools** include Overlay Analyst, Disk Cache, Pascal Encryptor, Shell File Generator, and File Browser.

The Turbo EXTENDER package includes two DSDD disks, complete source code, and a 150-page printed manual. Order now! \$85 COMPLETE.

TURBOPOWER UTILITIES™

"If you own Turbo Pascal, you should own TurboPower Utilities, that's all there is to it." Bruce Webster, **BYTE Magazine**

TurboPower Utilities offers nine powerful programs: Program Structure Analyzer, Execution Timer, Execution Profiler, Pretty Printer, Command Repeater, Pattern Replacer, Difference Finder, File Finder, and Super Directory.

The TurboPower Utilities package includes three DSDD disks, reference card, and manual. \$95 with source code; \$55 executable only.

ORDER DIRECT TODAY!

- **MC/VISA Call Toll Free 7 days a week.**
800-538-8157 x830 (US)
800-672-3470 x830 (CA)
- **Limited Time Offer!** Buy two or more TurboPower products and save 15%!
- **Satisfaction Guaranteed** or your money back within 30 days.

For Brochures, Dealer or other Information, PO, COD—call or write:

3109 Scotts Valley Dr., #122
Scotts Valley, CA 95066
(408) 438-8608
M-F 9AM-5PM PST

The above TurboPower products require Turbo Pascal 3.0 (standard, 8087, or BCD) and PC-DOS 2.x or 3.x, and run on the IBM PC/XT/AT and compatibles.

BE A HERO!

CALL!
PURCHASING
ORDER
20

INTERCOMPANY MEMO

TO: A.L. Walters
Director of MIS

FROM: George Schnyder *GW*
Sr. Systems Analyst

SUBJECT: Review and summary of tape back-up systems.

Attached is the report on tape back-ups that you requested. In summary, the T-33e is the tape back-up that I recommend.

Model T-33e Highlights

- Can back-up 30 megabytes.
- Meets our quality standards.
- Provides best price performance, \$795 suggested retail.
- Portable—runs off the floppy port, requires no installation.
- Has the software features of the more expensive competition (file by file or mirror image back-up).
- Compact, 3 1/2" width—No footprint.
- Self Diagnostics—Full LED instrumentation.
- Runs off our Novell network.

I would like to move ahead quickly and install the initial units by month's end.
Please advise!

Great job! Go for it! A.L.W.

Peachtree Technology, Inc.

3120 Crossing Park, Norcross, Georgia 30071, Telephone (404) 662-5158 Sales (404) 662-5556

INTEL'S 80386 ARCHITECTURE

The 80386 combines pipelined architecture, segmentation, and paging in a multitasking environment

BY PAUL WELLS

WITH A SUSTAINED performance of 3 to 4 million instructions per second, the 80386 CPU surpasses the speed of many current superminicomputers and matches the mainframes of only 10 years ago. The chip's full 32-bit architecture furnishes a high degree of parallelism and an extremely fast local bus. Hardware-supported multitasking and protection mechanisms push system performance and integrity further into the mainframe range.

The 80386 is designed to handle mainframe-size applications with typically large integers, data structures, and large numbers of programs. The 80386 can address 4 gigabytes of physical memory and supports virtual memory, a capability pioneered on mainframes.

MEMORY CAPACITY

Virtual memory allows the use of programs and data structures larger than the actual physical memory, and the 80386's 64-terabyte (2^{46} bytes) virtual memory capacity lets the processor accommodate even the largest programs and data structures.

The 80386 gives designers a wide choice of memory models from which to choose: flat physical addressing, flat demand-paged, or a fully segmented protected model. This versatility and combination of both segmentation and paging traces its origins to mainframe systems like the

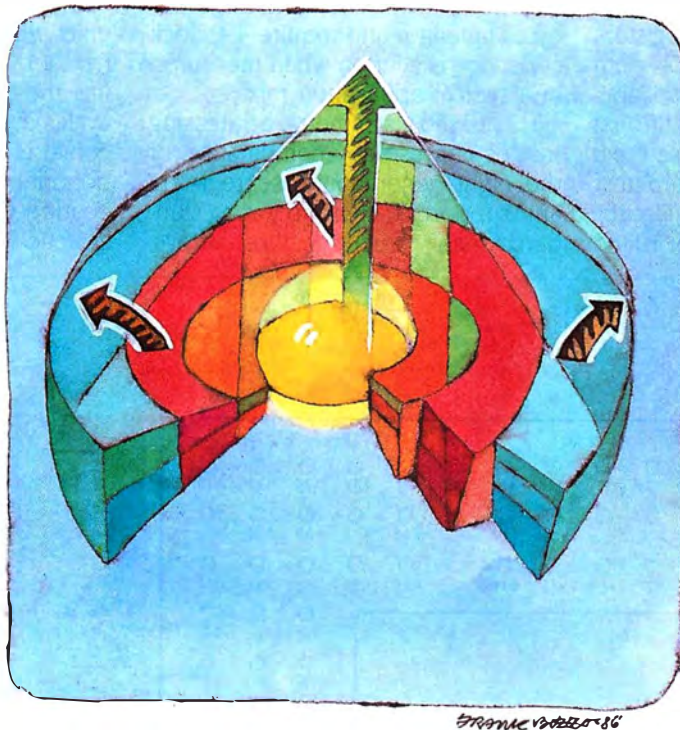

FRANK BOZZO '86

Control Data Cyber 180 and the IBM 360/67.

The 80386 provides object code compatibility with programs created for Intel's iAPX processor family: 8088, 8086, 80186, 80188, and 80286. Moreover, the 80386's virtual 8086 facilities let MS-DOS-based 8086 programs run concurrently with programs written for 32-bit operating systems, with each program operating as a separate task in a protected multitasking framework.

HARDWARE IMPLEMENTATION

The 80386 is manufactured using Intel's CHMOS III process, combining the high performance of HMOS with the low power dissipation of CMOS. Double metal layers and 1.5-micron

lithography allow a chip density of more than 275,000 transistors. The chip is available in 12- and 16-megahertz versions and is housed in a 132-lead ceramic pin-grid array (PGA), a package designed for compactness and high reliability (see figure 1).

32-BIT ARCHITECTURE

The 80386 includes a full complement of 32-bit registers and 32-bit-wide internal data paths. You can use eight general registers interchangeably as accumulators, for arithmetic and logical operations, or as addressing registers or data registers. Each register can be used for 32- or 16-bit values, and four of

them can be split into pairs of 8-bit registers. A 32-bit flags register contains processor-control flags and records the results of logical and arithmetic instructions. A 32-bit instruction pointer controls instruction fetching.

Six 16-bit segment registers implement memory segmentation. When you add the 80387 numeric coprocessor, eight 80-bit floating-point registers are available for numeric computations. The operating system uses a number of system registers, which are invisible to the application pro-

(continued)

Paul Wells is the technical marketing manager for Intel and can be contacted at Intel Corporation, 3065 Bowers Ave., Santa Clara, CA 95015, (408) 987-8080.

*The 80386 is
partitioned into a
six-stage pipelined
architecture.*

grammer, for initialization, system management, exception handling, and multitasking. Six debug registers allow the setting of code or data breakpoints for previously unavailable debug capabilities. An additional register supports the 80386 self-test capability, which lets the chip test more than half its transistors. (Figures 2a, 2b, 2c, and 2d illustrate the 80386

CPU registers in detail.)

The principal data types are 8-, 16-, and 32-bit integers and ordinals; packed and unpacked decimals; near and far pointers; and strings of bits, bytes, words, and dwords.

A complete set of instructions, including bit-manipulation instructions, implements the processing of these data types. The 80386 instruction set is a superset of 8086 and 80286 instructions. Instructions average 3.1 bytes in length and require 4.4 clock cycles for execution when measured in a typical application mix.

The 80386's symmetric addressing modes can use any combination of the eight general-purpose registers and support efficient access to standard data structures like arrays,

records, arrays of records, and records containing arrays.

OPTIMIZING FOR SPEED

The 80386 is partitioned into a six-stage pipelined architecture (see figure 3). Each processor's six functional units can work independently and in parallel with the others, enabling the chip to overlap execution of multiple instructions. The bus unit carries out bus transactions for other units, while the prefetch unit reads the next 4 bytes of the instruction stream into the prefetch queue when idle bus cycles are available. The decode unit converts each instruction to its component microinstructions, and the execution unit executes these microinstructions.

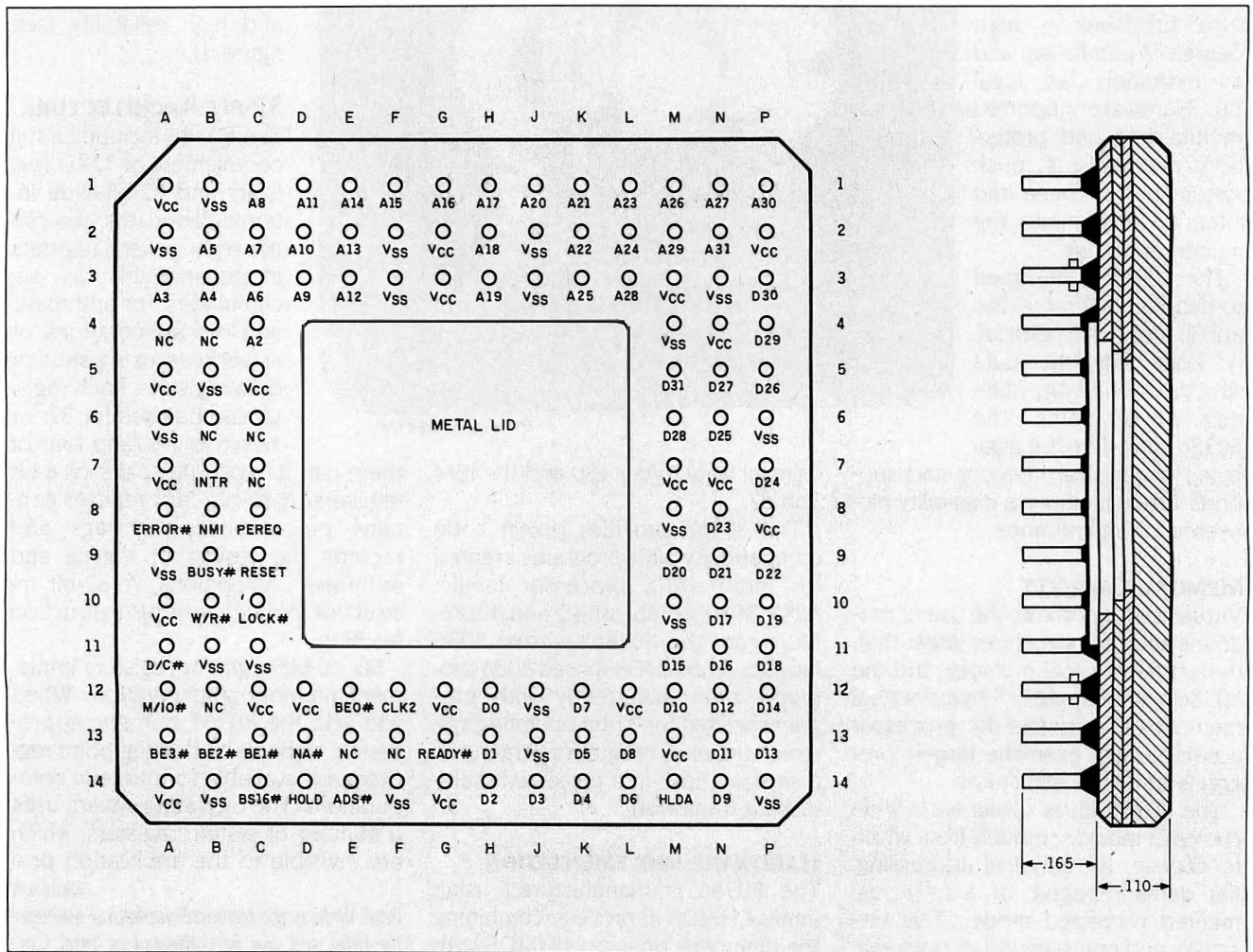

Figure 1: PGA package and pin-out of the 80386 processor.

The paging and segmentation units are also part of the pipeline. Together, these constitute the processor's memory management unit, which speeds up the address-translation process. By operating in parallel with other CPU activities, the on-chip MMU avoids the wait states associated with off-chip memory management and allows virtual-to-physical address translation with little effective delay.

The 80386 execution unit can sum two 32-bit registers in 2 clock cycles, while the multiply/divide hardware uses an advanced early-out algorithm to perform 32-bit multiplications in from 9 to 42 clocks (the exact number of clocks depends on the number of significant digits). A 64-bit barrel shifter can perform shifts of 1 to 64 bits in a single clock cycle.

The 80386 local bus achieves an overall throughput of 32 megabytes per second at 16 MHz, employing separate 32-bit data and address lines. The bus can complete an address-to-data-bus cycle in only two clocks, enabling very fast access to cache memory. Alternatively, a control feature can be used to pipeline the address from one cycle with data from the previous cycle, giving a three-clock latency appropriate to inexpensive dynamic RAMs. While the address-to-data-bus cycle increases to three clocks, address outputs and data inputs continue at a frequency of two clocks, avoiding any degradation of the processor's high bandwidth.

CACHE STRATEGY

Although a number of microprocessors feature on-chip code and data caches, their average size is about 256 bytes (too small to provide significant performance benefits). The 80386 is optimized for off-chip caching, providing a two-clock access to arbitrarily large caches. Such caches can be designed for hit rates in the 90 to 99 percent range, whereas on-chip code and data caches typically reach hit rates of only 20 to 30 percent, thus providing minimal performance benefits.

Dynamic bus sizing allows transfers

of 16- or 32-bit data. This allows arbitrary combinations of 16- and 32-bit memory subsystems, connection to 16-bit buses like Intel's Multibus I, and compatibility with 16-bit peripheral devices. The processor can change the bus size during any bus cycle, and the mechanism is completely trans-

parent to the application programmer.

PERFORMANCE

Pipelining, the on-chip MMU, a fast local bus, and the processor's compact code contribute to a fast
(continued)

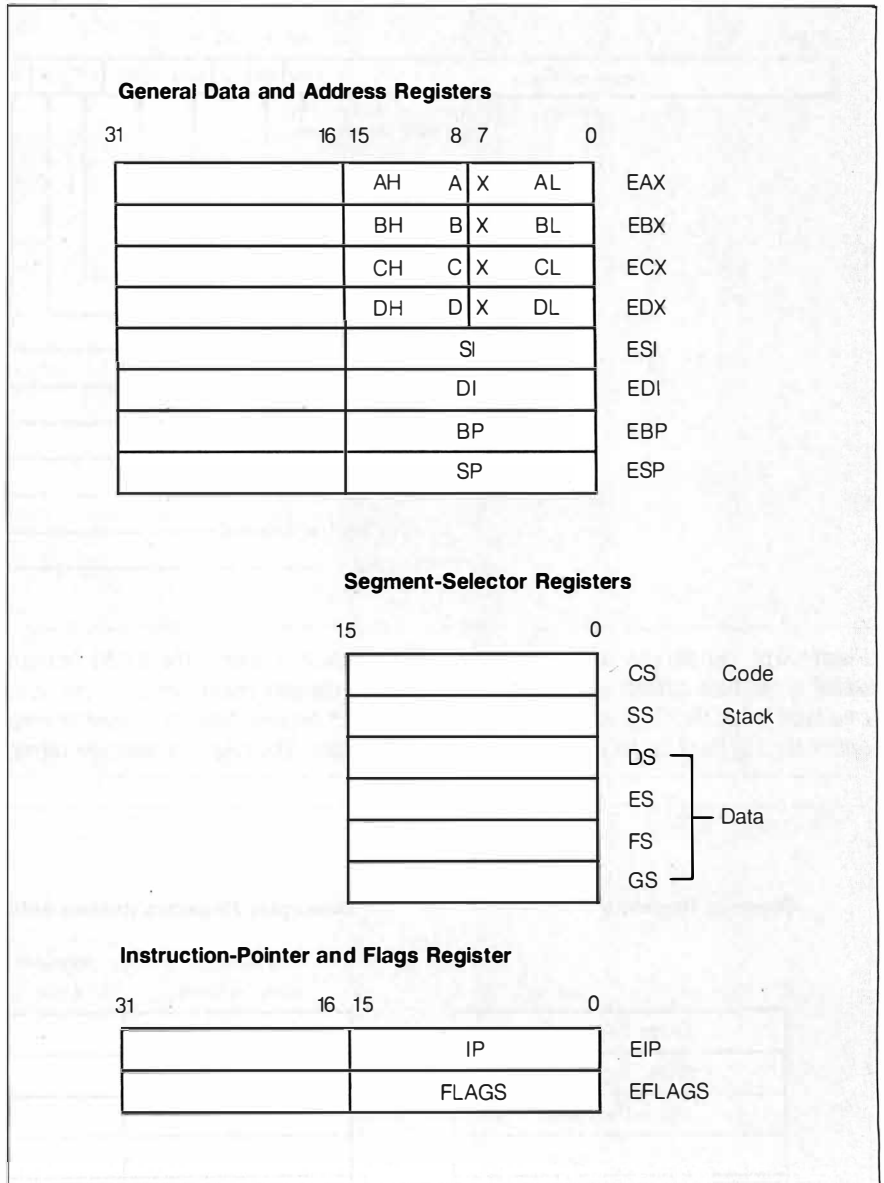

Figure 2a: The 80386 CPU general data and address registers. The least significant 16 bits of the registers can be accessed separately using the two-letter register names (AX, BX, etc.). The 8-bit operations can access the individual bytes of the 16-bit registers using the byte names (AL, AH, BL, BH, etc.). The lower 16 bits of the instruction-pointer register and flags register (EIP and EFLAGS) are named IP and FLAGS and are used for 8086 and 80286 emulation.

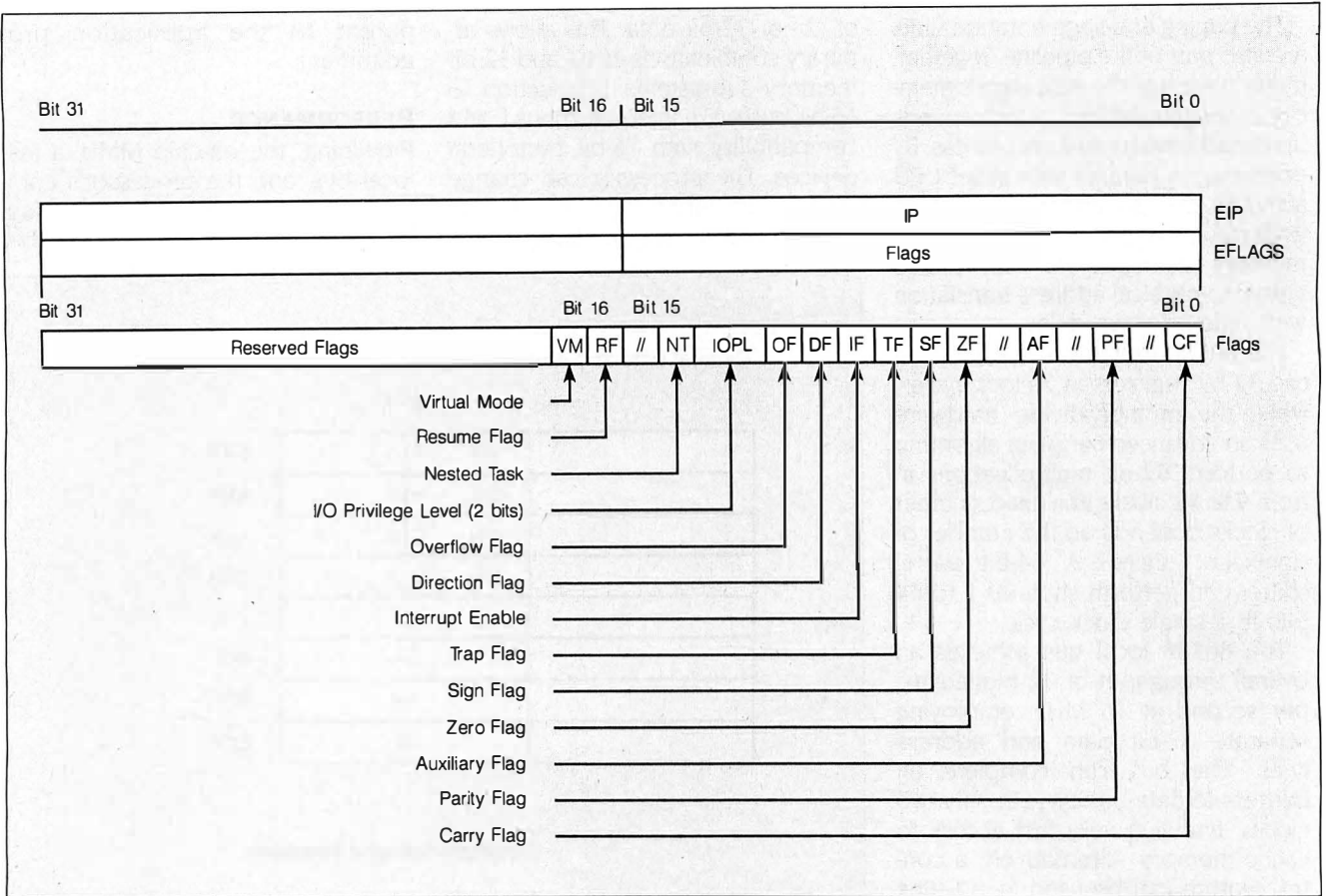

Figure 2b: The 80386 instruction-pointer and EFLAGS registers. The 32-bit instruction-pointer register holds the offset (to be added to the base address of the current segment) for the next instruction to be executed. EFLAGS-register bit VM enables 8086 emulation when the CPU is in protected mode. The RF (resume flag) bit is used in conjunction with debug-register breakpoints. It causes the bug fault to be ignored on the next instruction. The other 16 flags are common to 8086 and 80286 modes.

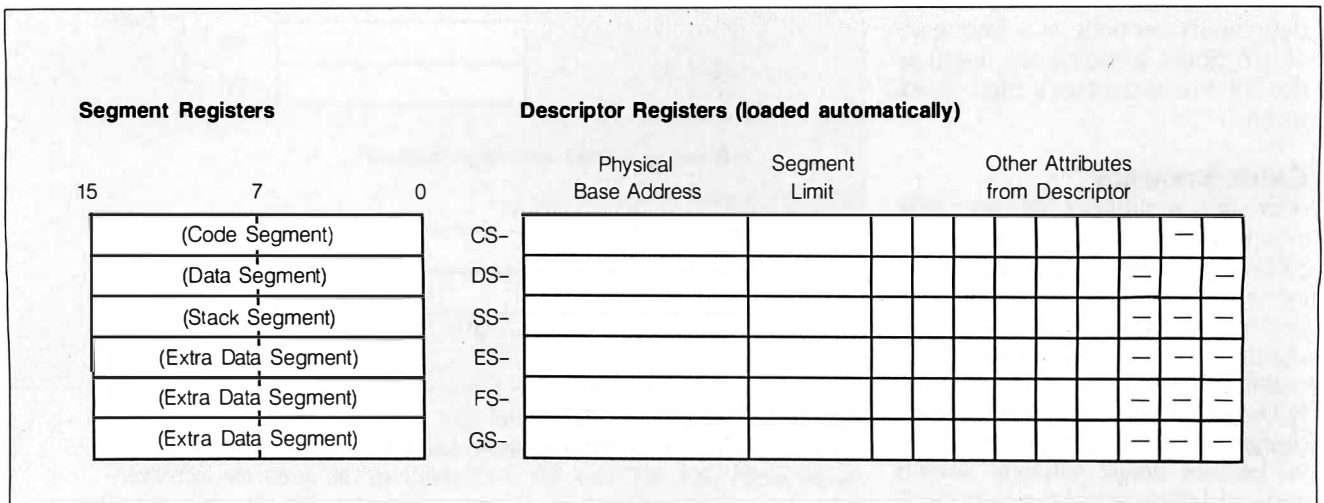

Figure 2c: The 80386 segment registers. The 16-bit segment registers hold the selector values to the currently addressable memory locations. Real address mode segments can be 1 byte to 2^{16} , or 64K bytes in size. Protected-mode addressing allows segments of 1 byte to 2^{32} bytes, or 4 gigabytes, in size.

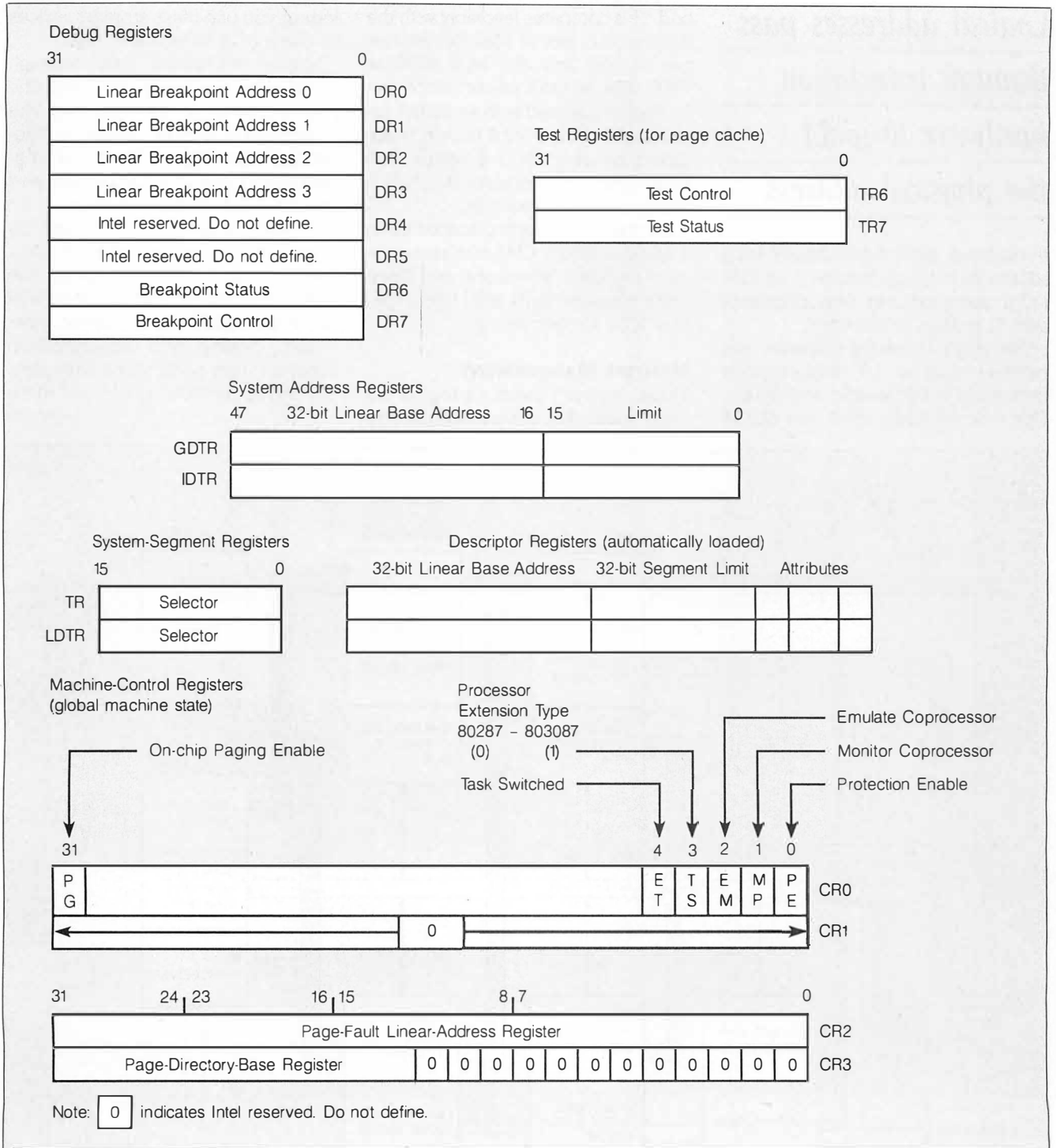

Figure 2d: Ancillary 80386 registers. Debug-control register DR7 is used to set the breakpoints. Debug-status register DR6 holds the current state of the breakpoints. The four special system-address registers are used to reference tables or segments required by the 80286/80386 protected mode. They are named GDTR (global-descriptor-table register), IDT (interrupt descriptor table), LDT (local descriptor table), and TSS (task-state segment). Control register 0 (CR0) holds the machine-status word. Control register 2 (CR2), the page-fault linear-address register, holds the 32-bit linear address that caused the last page fault. Control register 3 (CR3), the page-directory base-address register, holds the physical base address of the page-directory table.

Logical addresses pass through translation hardware to yield the physical address.

throughput. Recent benchmark tests set the 80386's performance at 3.64 MIPS, averaged over 14 applications and 31 million instructions.

The chip's interrupt response has been clocked at 3.7 microseconds from event to first handler instruction. Other benchmarks show the 80386

executing at 6133 Dhrystones per second. This compares favorably with the VAX-11/780's rate of 1662 Dhrystones per second and the VAX 8600 at 7000. The 80386's performance can be further boosted with an 80387 coprocessor (attaining 1.8 million Whetstones per second) or a Weitek 1167 floating-point coprocessor (4.0 million Whetstones per second).

All Intel results were obtained using a 16-MHz 80386 CPU and zero-wait-state memory. Whetstone and Dhrystone measurements used Intel's revision X.02 C compiler.

MEMORY MANAGEMENT

Virtual memory defines a logical address space that can exceed the size

of the actual physical address space, letting you use mass storage devices in place of a large RAM array.

Logical addresses pass through translation hardware to yield the physical address (see figure 4). The large logical address space is subdivided into units of allocation, segments or pages, that can be swapped into and out of main memory from secondary storage devices to provide a task with necessary code or data. Swapping is performed under the management of the operating system and is transparent to the application.

Both paging and segmentation schemes have particular advantages. The 80386 provides a choice of these

(continued)

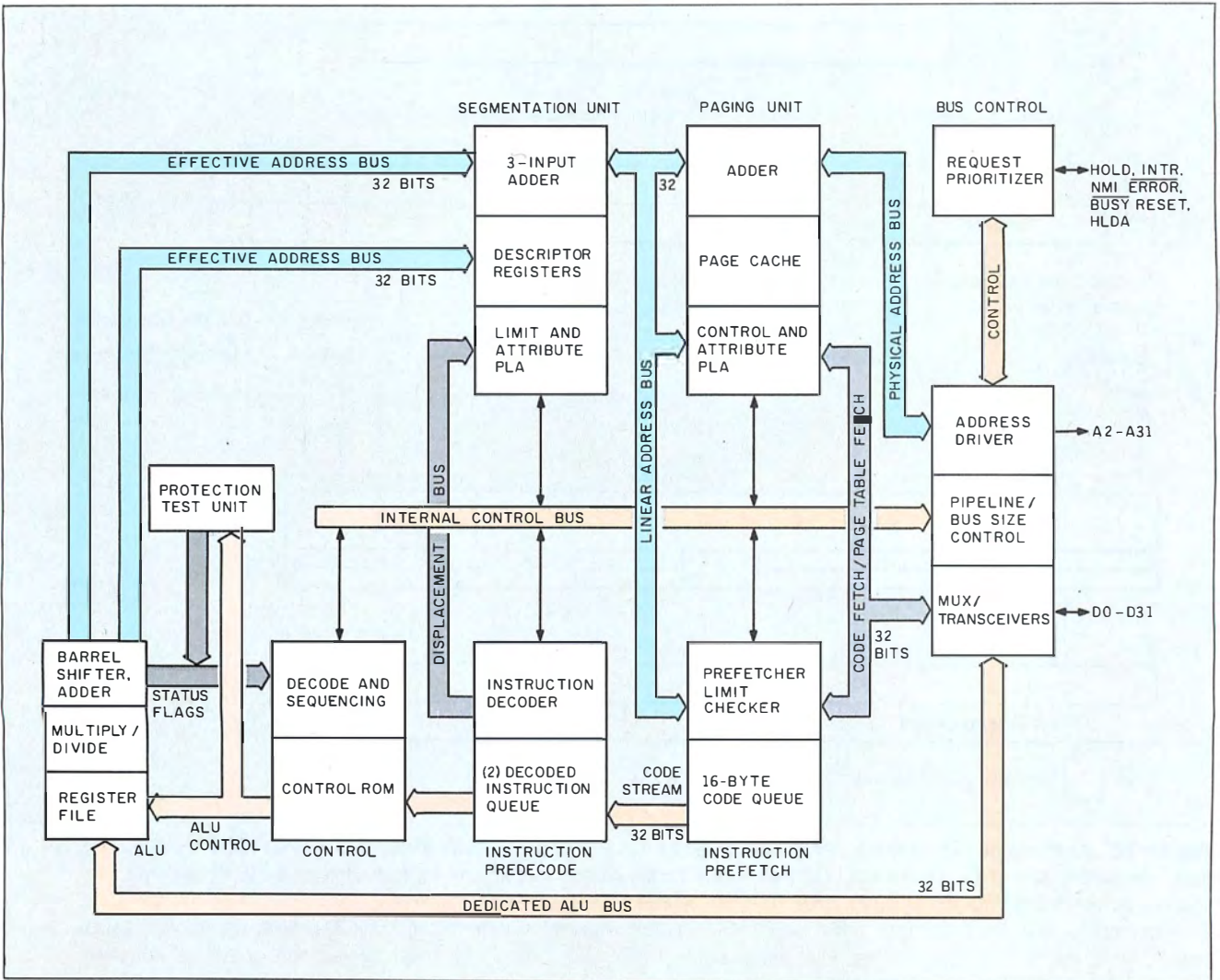

Figure 3: The 80386 CPU pipeline architecture.

For \$295 you can draw your own conclusions.

Drafix 1. The first high performance CAD software everyone can afford.

Low-cost, high performance computer-aided design & drafting (CAD) software is finally available for use on your PC.

There's never been a professional CAD package so complete at such a low cost.

Drafix 1 from Foresight Resources.

Only \$295.

Powerful, full-featured second generation CAD software.

Drafix 1 offers all of the capabilities you expect to find in packages costing \$2,000 or more.

This is not simply a souped-up paint package. Drafix 1 is a breakthrough in design that organizes sophisticated CAD functions into smooth, fast operations. All of the drawing, designing and editing functions that designers demand from a serious CAD tool are included in Drafix 1.

A breakthrough in screen design and visual user interface.

Drafix 1 features the best organized screen design ever devised. Very simply, it displays all the information you need, all of the time.

The entire menu hierarchy is displayed constantly. There's no need to memorize commands or search for menus.

Snap-mode options are continually shown on the left screen border and can be selected "on the fly" by either pointer device or a single keystroke. Roll-down screens provide quick access to the virtually unlimited drawing, display and editing options.

And it's all controlled by a versatile three-button mouse, or digitizer, with on-screen prompts so each button function is clearly defined.

AutoCAD® compatible for easy expansion.

If you or someone in your company already uses AutoCAD, Drafix 1 offers an inexpensive way to add to your capability.

The optional Drafix 1/AutoCAD file exchange utility permits transfer of drawings between Drafix 1 and AutoCAD.

It's the perfect, low-cost alternative for increasing your drafting and design capacity.

Unbelievable low bundle prices.

To get you up and running we offer two special hardware bundles — all the equipment you need at prices you won't believe.

Get Drafix 1 with your choice of Torrington's Manager Mouse or the LOGIMOUSE™ C7 for just \$395.00.

Or get Drafix 1 with the SummaSketch 12" x 12" digitizer tablet with stylus for just \$650.00.

Order today. Take advantage of our 30-day, money back guarantee.

We're so certain you'll like the performance and versatility of Drafix 1 you're welcome to try it risk free for 30 days. If you're not completely satisfied, return it to us for a full refund.

Find out just how good CAD software can be. For only \$295.00.

Use our toll-free number and any major credit card to order your copy of Drafix 1 today.

SPECIFICATIONS

Code specifications	Attributes
Lattice: C-language	Break/Divide
Halographics	Fill/Erase/Trim
Floating point/database	Stretch
Compressor support	Erase
PC DOS/MS-DOS 2.1 or later	Explode symbols & polygons
Drafix 1 Features	Mask
Items	Repace
Lines	Merge
Pl markers	Region/select
Arcs & circles	Wangmap
Notetext	
Polygons & ellipses	
Symbols/individual & nested	
Item attributes	
16pen colors	
255Layers	
8 Linetypes	
12 font fonts	
32 Pl markers types	
Screen Display	
Zoom/Pan/Fill	
8 Save Views	
Slidebar/view	
Grid/offset	
Metric & English Standards	
Engineering (decimals/fractional)	
Architectural (ft/in)	
Project drawing info.	
Numerical input	
Keyboard/cursor	
Absolute/Relative/Point	
Snap Modes	
Gridpoint	
Endpoint	
Nearest	
Intersect	
Onitem	
Quadrant	
Target	
Accelerator	
Transform/Copy	
Move	
Rotate	
Scale	
Mirror	
Align	
Modify/Edit	
Attributes	
Break/Divide	
Fill/Erase/Trim	
Stretch	
Erase	
Explode symbols & polygons	
Mask	
Repace	
Merge	
Region/select	
Wangmap	
Auto hatching, polygon fill	
AutoDimension	
Linear/Horizontal/Aligned	
Angular	
Dia/Radius	
Leader/Notes	
Ordinate	
Chain & Baseline	
Calculations	
Coordinates	
Distance & angle	
Area & perimeter	
ItemMasking	
Hardware	
Computers	
IBM PC XT AT and compatibles	
AT&T 6300 Plus	
Zenith	
System Requirements	
— 512K RAM	
— RS-232C Comport	
— Mouse or digitizer	
— Coprocessor recommended	
Graphics Displayboards	
IBM VGA EGA and compatibles	
Hercules and a wide range of graphicsboards	
Digitizers & Locators	
IBM PC AT and device supported	
Plotters	
All popular plotters (1/4 C size) supported	
— Size plotter option available	
Printers	
All popular laser and dotmatrix printers supported	

Order Now! Call Toll-Free!
1-800-231-8574,
Ext. 150

- Drafix 1 CAD Package \$295
 Drafix 1 with Mouse \$395
 Torrington _____
 LOGIMOUSE _____
 Drafix 1 with SummaSketch tablet \$650
 AutoCAD File Exchange Utility \$ 95

Dealer inquiries welcome

Check, money order, Visa
and MasterCard accepted

FORESIGHT
RESOURCES CORP.™

932 Massachusetts
Lawrence, KS 66044
913/841-1121

AutoCAD is a trademark of Autodesk Inc.
IBM PC/XT/AT are trademarks of the IBM Corp.
SummaSketch is a trademark of Summagraphics Inc.
Manager Mouse is a trademark of Torrington Company

Inquiry 320 for End-Users.
Inquiry 321 for DEALERS ONLY.

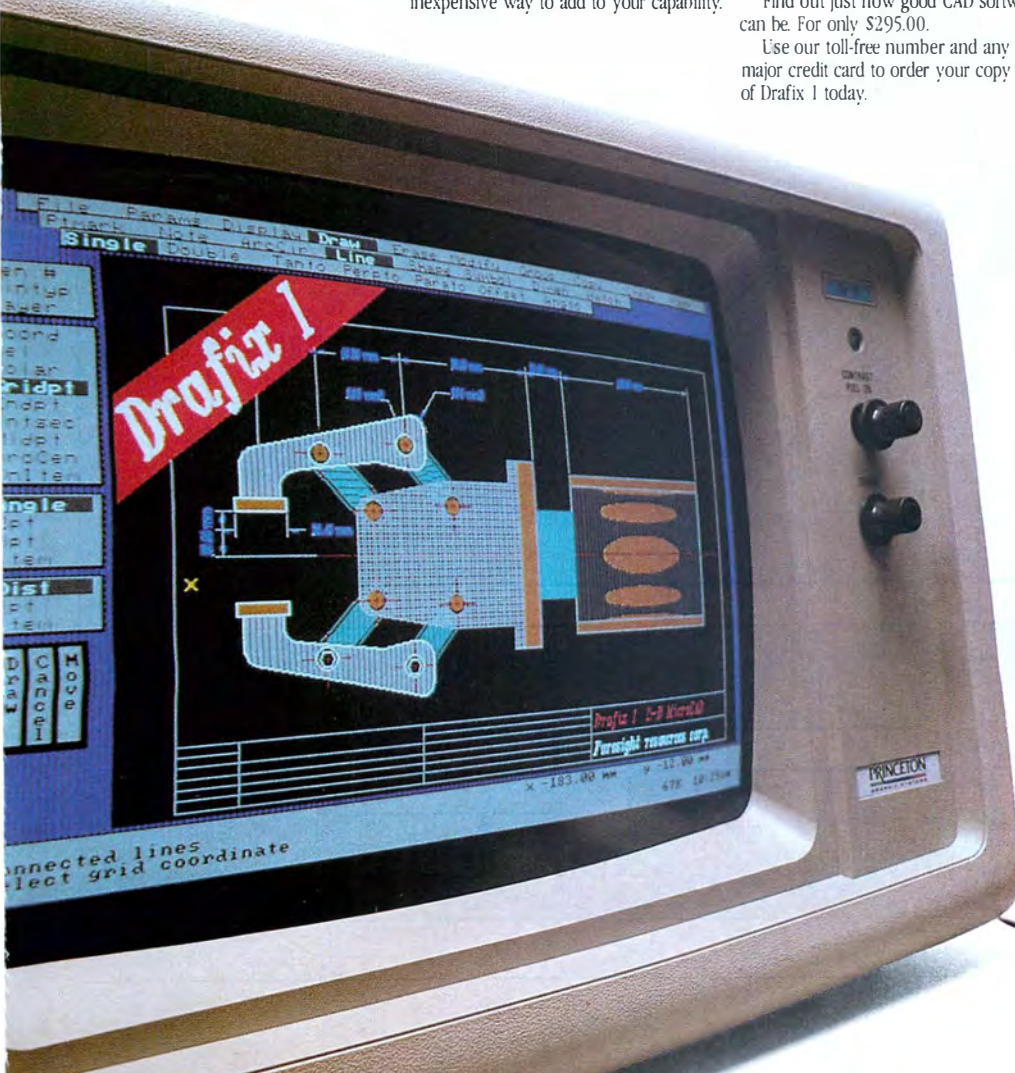

two major memory models, to be used alone or in combination. System designers can choose the model best suited to their specific application. In the simplest case, designers can elect not to employ virtual memory. They can group all addresses in a single segment, equivalent in size to

the entire physical memory (up to 4 gigabytes). Addresses are organized in a linear, unstructured array. No MMU translation is required, and the logical address is precisely equivalent to the physical address. Such flat memory organizations are often preferred in embedded real-time sys-

tems like industrial controllers and private branch exchanges.

SEGMENTATION

In segmented models, logical memory is subdivided into segments of variable length (see figure 4). Each code (continued)

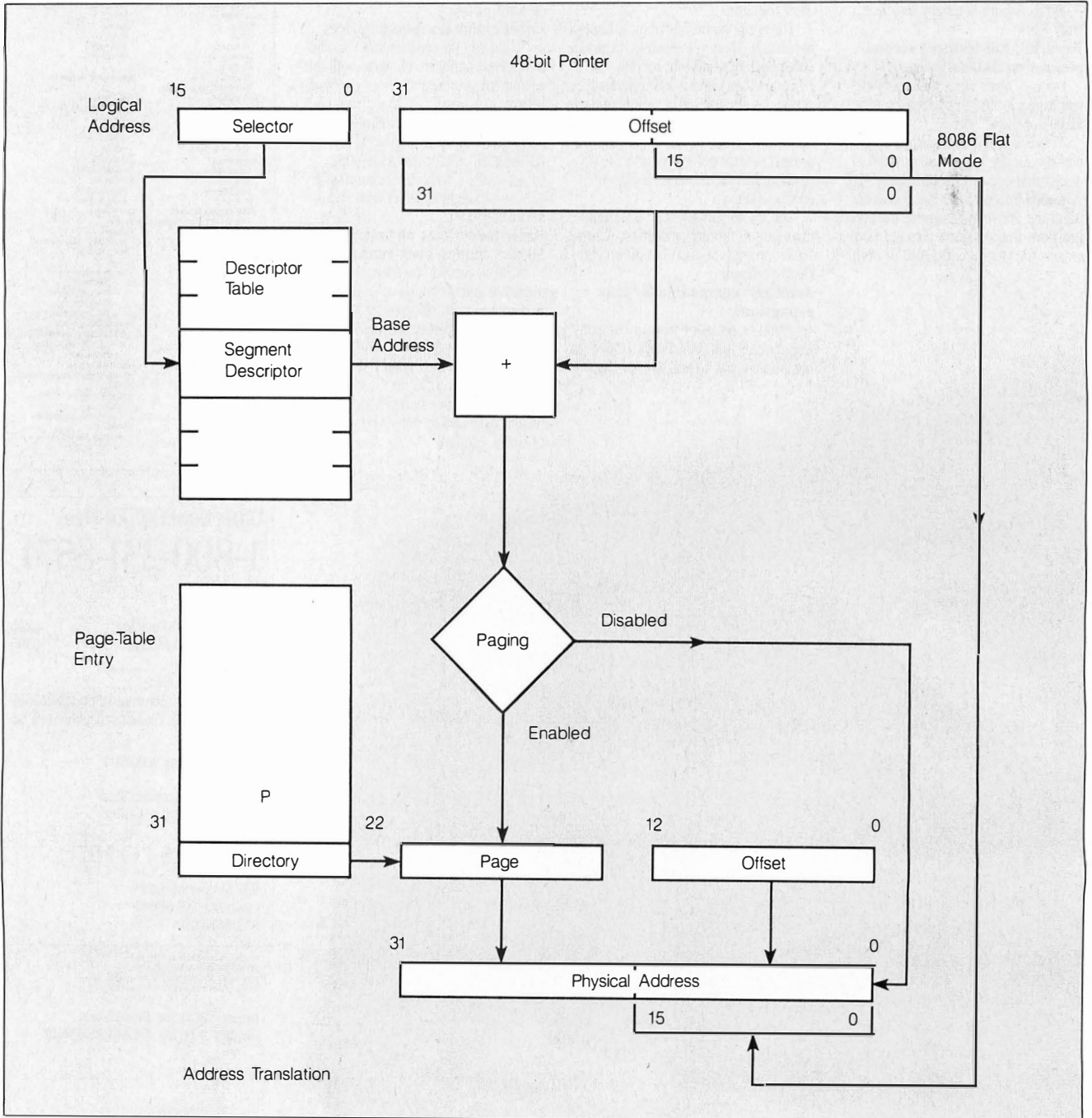

Figure 4: 80386 address translation.

IT'S EASY TO WIN WHEN YOU BUY THE REFEREE™

With Referee, you make the rules.

If you use desktop organizers, spell checkers, keyboard enhancers or other RAM-resident programs you may have already discovered the horror of "RAM Cram."

RAM Cram occurs when resident programs compete with each other (and with applications programs) for control of your keyboard or other computer resources. It's a fierce competition that can cause your computer to lock up completely. Then you pay the penalty—in lost time and lost data.

Referee, by Persoft, is a new type of software that puts you in total control of your RAM-resident programs.

And that puts Referee in a league all its own. You can create your own RAM Teams™ for specific applications programs. Team Superkey™ and Sidekick™ with Lotus 1-2-3™. Or call in Prokey™ and bench the others when you switch to dBASE III™.



Load all the programs you need at the beginning of your workday. Referee automatically activates and deactivates the ones you need according to your set of rules. Instantly. Invisibly. You can also use Referee to unload programs from memory—even those with no unload option of their own.

Referee's Sideline™ menu enables you to control RAM-resident programs from within an applications program!

deal for integrated packages like Symphony™. You can use a keyboard enhancer with the spreadsheet module. Or deactivate it, enter the word processing module and activate your favorite spell checker. It's easy. And you never have to back all the way out of the program!

Referee puts an end to RAM-resident program conflicts. At \$69.95, it solves a very big problem for a very small price.

It's easier to win with the Referee on your side. For more information, and for the dealer nearest you, contact: Persoft, Inc., 465 Science Drive, Madison, WI 53711, (608) 273-6000—Telex 759491.

Referee™

persoft

© Copyright 1986 Persoft, Inc. All rights reserved.
Referee, Sideline, and RAM Teams are trademarks of Persoft, Inc.
Sidekick and Superkey are registered trademarks of Borland International, Inc.
Lotus 1-2-3 and Symphony are registered trademarks of Lotus Development Corp.
Prokey is a trademark of RoseSoft, Inc.
dBASE III is a registered trademark of Ashton-Tate.

Visit Booth #8624
Hilton Pavillion West
COMDEX/Las Vegas

SYSTEMS IMPLICATIONS OF THE INTEL 80386

BY BILL NICHOLLS

What is a "systems" point of view? Briefly stated, it is the evaluation of a component's performance while it is part of a functioning system. This is a real-world view of performance, since no component operates without some interface to other equipment. Evaluation of a new processor must therefore be done in light of current and future demands on the whole computer system.

CLASSIFYING THE 80386

Classification of a processor is not one-dimensional. The primary dimensions are speed, architecture, and technology. In these broad terms, the 80386 is fast in operation (12- to 16-megahertz processor timing), complex in architecture (large instruction set, levels of protection, and virtual memory support), and current in technology (CHMOS).

How does the 80386 compare to other processors, small and large? Clearly, the 80386 is a microprocessor because of its implementation on a single chip. But do its characteristics qualify it as a mainframe? Certainly its speed is more than adequate for that classification. But while the architecture is as complex as some mainframes, it is incomplete in the area of I/O paths.

The 80386 can perform a number of direct I/O functions of various types and sizes. However, each element transferred requires the execution of one or more instructions to perform

the transfer. Low-speed I/O can be done this way using interrupts, but high-speed I/O requires interrupts to be locked out and the chip dedicated to one peripheral device. This is acceptable only in some dedicated systems, not in general-purpose systems.

The inability to perform I/O while continuing to compute separates the 80386 from a full mainframe classification. Clearly, other chips can perform that function, and the combination of those chips and an 80386 is functionally equivalent to a mainframe.

Given a proper I/O design and adequate memory size and speed, the 80386 would compare closely in performance to an IBM Model 4341-1 or 4341-2, depending on a number of factors. The higher instruction-execution rate of the 80386 would be offset by the more powerful instructions of the 4341. Memory and I/O bandwidth would also have to be evaluated for specific designs. In capability, however, the 80386 could perform at the level of an IBM 4341. The major differences in performance would depend on how the 80386's I/O subsystem compared to the 4341's I/O subsystem and the use of special 4341 instructions.

HIGH-PERFORMANCE HARDWARE

In this context, high performance means maximizing system performance relative to the design objective without excessive cost. For systems with the same processor, different

design objectives will lead to different performance levels due to the economic choices made.

The primary requirement for a high-performance 80386 system is adequate memory bandwidth. Bandwidth as measured in megabytes per second is an important number. However, bandwidth that is not carefully matched to the processor cycle is usually wasted.

Some additional bandwidth is required for I/O. For example, an 80386 with a 12.5-MHz clock tick (25-MHz crystal) requires an 80-nanosecond memory access for zero wait states and 160 ns for one wait state. With a zero-wait-state memory, the processor is internally (CPU) limited; with a one-wait-state memory, it is bus-limited. If a processor is bus-limited, I/O cycles on the bus will interfere with processor execution, causing some reduction in processing capacity. For designs like single-user computers, this is probably acceptable. For large multiuser systems, it means trading off memory cost against performance gains that are important but hard to justify.

Until recently, there was no easy way to match a fast processor to slower memory speeds without loss of performance. The typical solution was to use a small but fast cache memory and a larger but slower main memory. The added complexity and cost removed this technique from the personal computer market. The 80386 offers a method for adding this performance boost.

Using an external pin called *next address*, the designer can have the processor output the next address before the current memory cycle is finished. This enables the address to be decoded for the next memory access to happen concurrently with the current memory data cycle. This is called pipelined mode access.

Table A shows the trade-off between processor clock speed, wait states, and required memory-access time. The Bus Cycles Available column shows the percentage of the bus that can be used

Table A: The differences in processor clock speed, wait states, and memory-access times for the Intel 80386.

Processor Clock	Access Mode	Memory 0 ws	Access 1 ws		Bus Cycles Available	
			0 ws	1 ws	0 ws	1 ws
12.5 MHz	2-cycle	80 ns	160 ns	27%	14%	
	2-pipe	160 ns	240 ns	21%	11%	
16 MHz	2-cycle	45 ns	107 ns	27%	14%	
	2-pipe	108 ns	170 ns	21%	11%	

Note: 2-cycle is the standard memory access; 2-pipe is the 2-cycle pipelined mode of access.

by I/O before interference with the processor is certain. Below that level, I/O interference is small.

Another way to enhance large-system performance is with banked memory, a technique used in large mainframes. The basic system can be delivered with a single bank of memory. As the system grows in the field, a second bank of memory could be added so that sequential addresses would then alternate banks. This bank alternation works for both I/O and processor access. Large mainframes may use up to 16-way bank interleave, but multiprocessor microcomputers will probably need no more than 4-way banked memory for higher performance.

FAST I/O

Fast I/O is not well supported in the 80386. An external direct memory access is required. With the complexity of addressing in the 80386, even simple DMA can be awkward. A single I/O command can refer to data that spans over page boundaries and is relocated in noncontiguous real memory addresses. Thus, the operating system must first test for this condition and split one logical I/O operation into more than one physical I/O operation, then schedule and coordinate the physical I/O operations, and finally notify the calling program when done. In addition to adding significant overhead, it also complicates error recovery.

A second type of DMA, "smart" DMA, is now available. It can perform multiple operations as a single logical I/O operation and relieve the processor of substantial overhead. Large-scale systems have had this feature, *scatter read/gather write*, for some time. This means the DMA chip can read a physical record from scattered locations and gather scattered data to write as a single record. These features are incorporated in the Intel 82258 DMA chip.

In addition to a powerful DMA capability, the hardware must support higher transfer rates than the current

5 megabits per second. Multiple transfers on different channels at the same time must also be supported. Both of these requirements can be met with the 82258, which can support four high-speed channels with a maximum throughput of 16 megabytes per second. The 82258 can also operate as three high-speed channels and one multiplexed channel supporting 32 subchannels at up to 30k bits per second each.

Few programs will be able to fully utilize an 80386, even with fast I/O. One way to use the available time is to run multiple programs or tasks. Multitasking divides the processor's time in slices and allocates one slice to each task, switching rapidly between tasks to give the illusion of continuous operation. Some tasks may slow down compared to running alone, but overall throughput increases up to a point.

That point is determined primarily by the operating system overhead in performing its primary services: I/O control and task switching. More tasks, more I/O, or shorter time slices increase the overhead. When the increase in overhead exceeds the improvement in throughput, system performance begins to degrade. If the processor provides fast methods for I/O processing and task switching, a system with a well-designed operating system will reach a higher level of throughput before system performance degrades.

The Intel 80386 processor has fast task switching in its instruction set. A single instruction will totally switch tasks including registers and environments in 17 to 20 microseconds. This is an order of magnitude faster than processors without this instruction and significantly reduces overhead in support of multitasking. Interrupts can use task switches or, for fastest response, calls that execute in 3 microseconds but do not switch task environments.

Bill Nicholls is president of, and a software engineer at, BGW Systems Inc. (16714 Meridian S. Suite 200, Puyallup, WA 98373).

and data module (such as file buffers, program variables, and so on) can be assigned a different segment. Since each module has its own logical memory address space, it is easy to implement schemes that protect individual modules, share them selectively between tasks, and manipulate them separately or together. Segments in the 80386 can be any size up to 4 gigabytes (enough for the largest code and data modules), with a maximum of 16,000 segments per task.

This is how the 80386 implements segmentation. The logical address used by the application consists of a 16-bit segment selector and a 32-bit offset into the selected segment. The selector references a segment descriptor held in a table that the operating system maintains. The 64-bit descriptor contains the segment's 32-bit base address and limit (length), together with swapping information and protection parameters like privilege level, access rights, and segment type. In addition, the descriptor's present bit tells the processor whether the desired segment is present in memory or needs to be swapped in from disk.

The segment's base address, obtained from the descriptor, is added to the offset to give a linear address. The linear address is then passed through the paging unit to yield the physical address unless paging is disabled, in which case the linear address is the physical address.

The processor automatically maintains descriptors for the current segment in an on-chip cache, minimizing the need to index memory-based descriptor tables. The cache-resident segment descriptor is replaced automatically with a new one whenever a new segment selector is loaded into a segment register. Programs can address up to six segments at a time: a code segment, a stack segment, and up to four data segments.

PAGING

While segments vary in size and map well to programming constructs, pages are small blocks of fixed size

(continued)

The page-table entry includes attributes like present, rights, accessed, and dirty.

(4K bytes in the 80386). Paging simplifies swapping algorithms by providing uniform units of allocation and relocation. Thus, while segmentation can be used to structure the logical address space, paging can be used to manage the physical memory.

The paging system uses a 32-bit linear address. The upper 10 bits of the address index a 1024-entry page-table directory to obtain a page-table address (see figure 5). The middle 10 bits of the linear address are added to the page-table address to get a page-table entry that describes the

target page. The final 12 bits of the linear address are added to the page address to generate a 32-bit physical address.

Just as the processor's segmentation mechanism caches segment descriptors, the paging unit supplies an on-chip associative cache containing mapping information for the 32 most recently used pages. The cache, called a translation lookaside buffer (TLB), has a hit rate of 98 to 99 percent, minimizing the performance impact of enabling the paging system.

The page-table entry includes attributes like present, rights, privilege level, accessed, and dirty. The accessed bit is set automatically whenever a page is read or written. The dirty bit is set whenever a page is written. By monitoring accessed and dirty bits, the operating system can implement a variety of page-replacement algorithms, like least recently used (LRU) approximation algorithms. No

other microprocessor provides both dirty and accessed bits.

COMBINING PAGING AND SEGMENTATION

Although it is possible to use paging or segmentation alone, the 80386 also lets designers combine the advantages of both models, providing a powerful capability.

The application programmer employs segmentation to implement data sharing, software protection, and multitasking, while paging provides the underlying physical memory management. The segmentation/paging combination was first used by Control Data and IBM mainframes and is also employed by UNIX System V, which allots each task a segment for code and a segment for data and the stack.

When the two memory management organizations are used together in the 80386, linear addresses pro-

(continued)

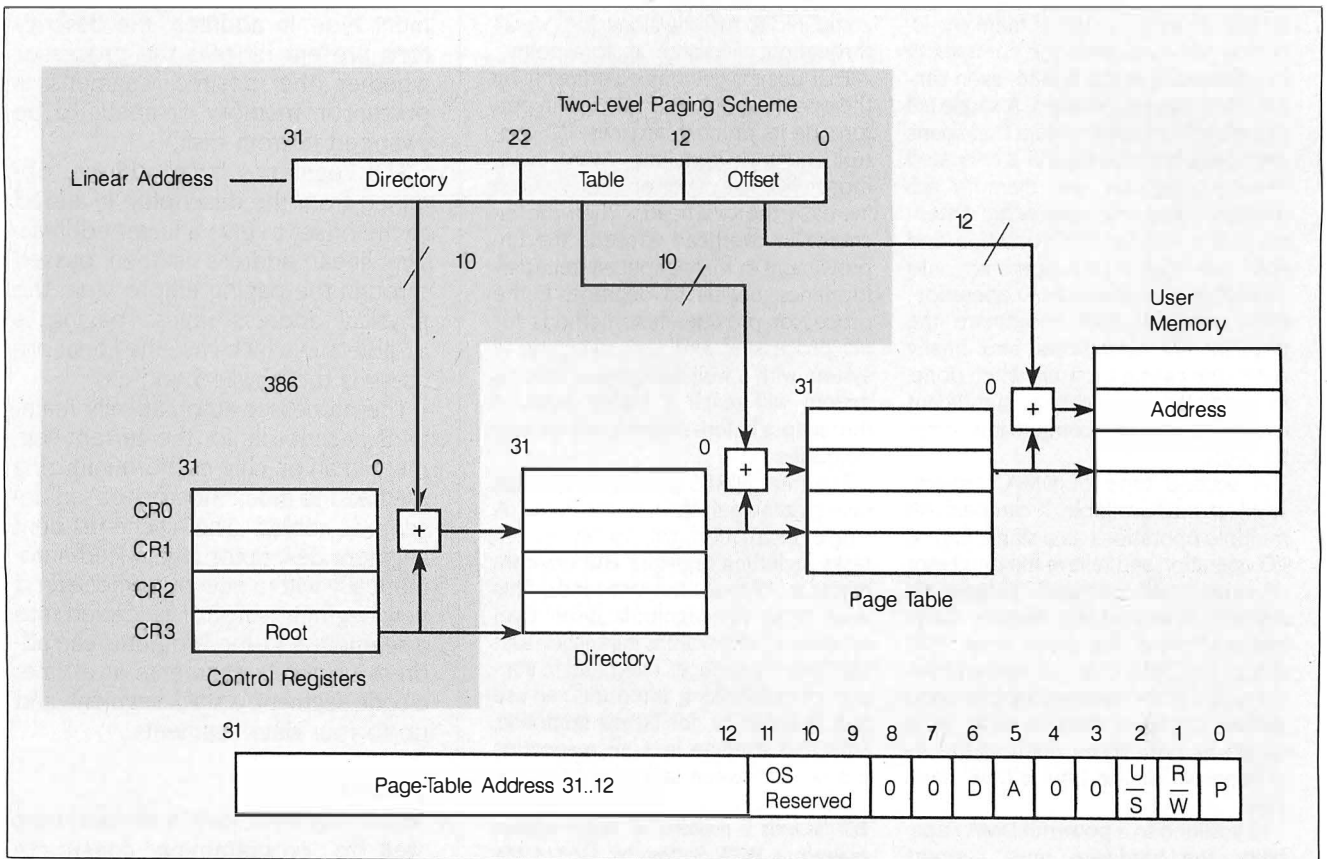

Figure 5: 80386 paging system.

We've gone to great widths to make you look good.



Introducing New **SIDEWAYS™** Version 3.

Sideways has always been the favorite way to print nearly everything that's too wide for a printer. Not surprising.

It's quick. It's easy. And it makes clean, one-piece printouts as wide as you like. So you get spreadsheets that really spread out. Pert charts that peer far into the future. All kinds of extra-wide reports without staples, glue or tape.

But now Sideways Version 3 goes even further.

Especially for 1-2-3™ and Symphony.®

Now you can make short work of those wide 1-2-3 spreadsheets. No need to make print files. Just highlight a range and print right from your worksheet file using familiar Lotus-like menus.

Mix bold, underlined and expanded type, all on the same page. Print through or skip over perforations. Make the finest extra-wide printouts this side of typesetting.

Using Symphony? Sideways chimes right in to print any worksheet you've loaded without ever leaving your Symphony session.

No matter what software you use.

Spreadsheets, databases, word processors, project planners. Whatever you use, you'll get more out of new Sideways.

Choose from nine different type sizes, from "minuscule" to "mammoth." Print bold, underlined or expanded – whatever your software can create. Even foreign language and line-drawing characters. Plus, there are so many ways to adjust margins, spacing and page size, it stretches the imagination.

Sideways Version 3 for the IBM® PC and all popular dot-matrix printers. Available now at computer dealers nationwide. Or directly from Funk Software with your check, Visa or Mastercard.

At just \$69.95 a copy, you'll never want for width again.



Funk Software, 222 Third Street, Cambridge, MA 02142. Phone (617) 497-6339.

© 1986, Funk Software, Inc. Sideways is a registered trademark of Funk Software. Lotus, 1-2-3 and Symphony are registered trademarks of Lotus Development Corp.

ANTHROCART.™

MOBILE...

A key reason why people like the AnthroCart. Share your hardware. Move it around. Take it room to room or floor to floor.

AnthroCart. High-tech furniture for high-tech equipment. Space saver. Compact. Rugged.

The AnthroCart is designed to move. Designed so your workspace is as slick as your hardware.

Call us: 800-325-3841



*Supports up to 150 lbs.
All steel frame construction
5½ square foot footprint*



**Anthro Corporation
Technology Furniture**

3221 NW Yeon St.
Portland, OR 97210

Anthro Corporation is a wholly owned subsidiary of Tektronix, Inc. Anthro is a registered trademark of Anthro Corporation.

duced by the segmentation unit are passed through the paging mechanism to generate the final physical address. Overall, this multistage address-translation facility is fast, due to the on-chip translation caches and the pipelining of memory management functions. Translation from logical to physical address typically requires only one and a half clocks. From the user's perspective, the effective delay is zero clocks since translation is performed on-chip, overlapped with other processor activities.

PROTECTION HARDWARE AND SOFTWARE

An additional benefit of the 80386's on-chip MMU is an array of protection mechanisms that operating systems can selectively employ, including separation of task address spaces, typed segments, access rights for segments and pages, and segment-limit checking.

A frequent and insidious problem occurs when an erroneous task violates the address space of another task and overwrites code or data. In this way, bugs can propagate through a system and be nearly impossible to track. The 80386 protects task address spaces by assigning them to different segments and/or separate page directories and page tables. Segment-descriptor tables prevent unwarranted access by other tasks.

In addition to isolating tasks from one another, the processor provides a ring-protection mechanism that can guard low-level software both from bugs in overlying layers and from intentional tampering at the application level. Each segment descriptor and page-table entry has a field that defines the segment's and page's privilege level, ranked from 0, the most privileged level, to 3, the least trusted. Programs at a given level can access data and code only at the same or a numerically higher level (see figure 6).

Segment descriptors hold not only privilege information but also the segment limit (references to the segment must fall within the limit, preventing

(continued)

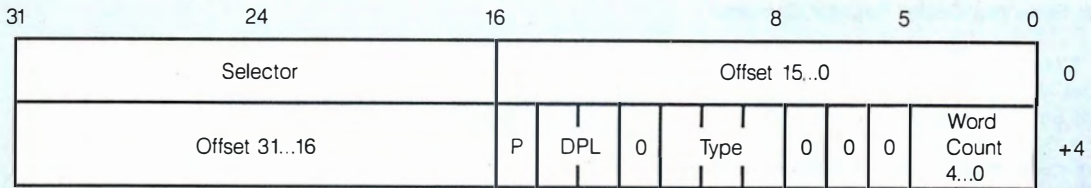

Gate Descriptor Field

Name	Value	Description
Type	4	286 call gate
	5	Task gate (for 286 or 386 task)
	6	286 interrupt gate
	7	286 trap gate
	C	386 call gate
	E	386 interrupt gate
	F	386 trap gate
P	0	Descriptor contents are not valid
	1	Descriptor contents are valid

DPL—least privileged level at which a task may access the gate. WORD COUNT 0–31—the number of parameters to copy from caller's stack to the called procedure's stack. The parameters are 32-bit quantities for 386 gates and 16-bit quantities for 286 gates.

Destination Selector 16-bit selector Selector to the target code segment or Selector to the target task-state segment for task gate

Destination Offset offset 16-bit 286 32-bit 386 Entry point within the target code segment

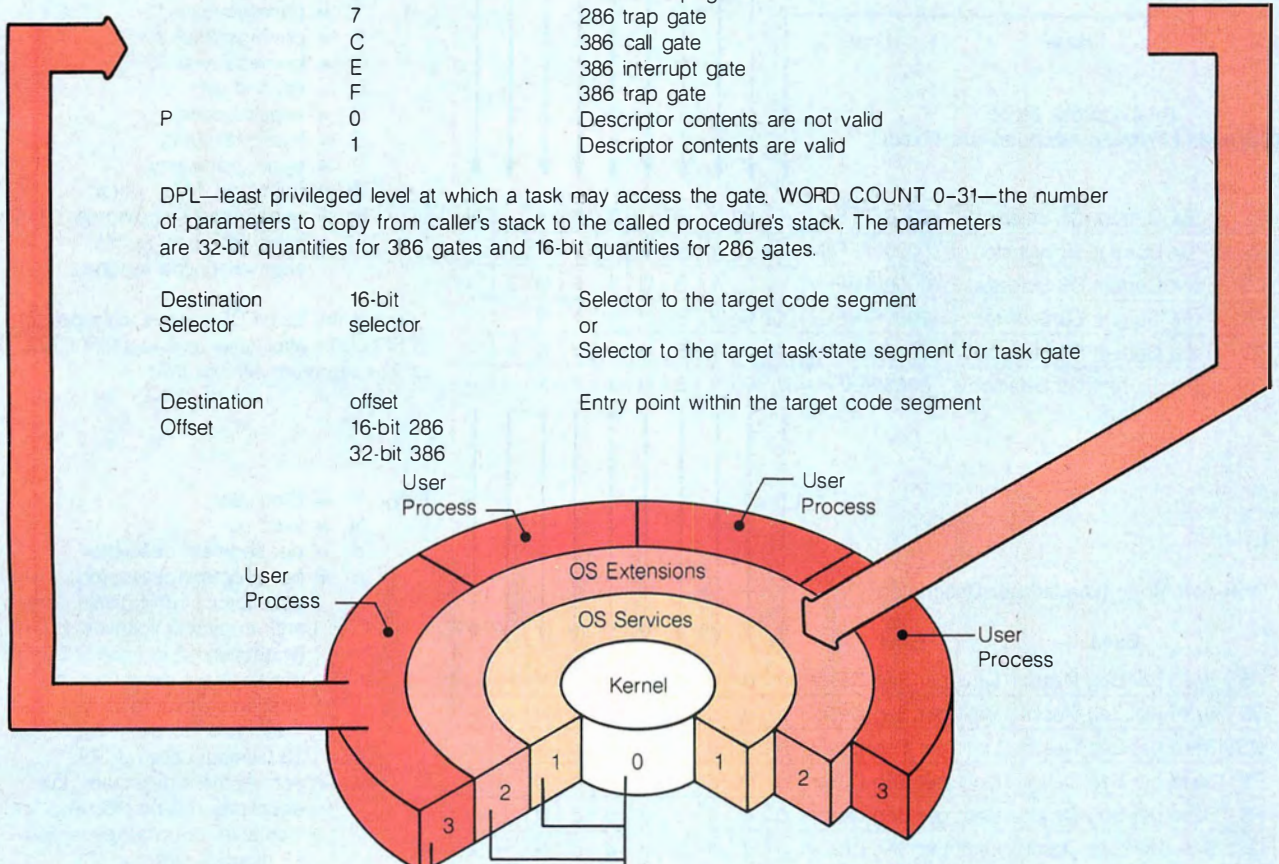

Segment Descriptor

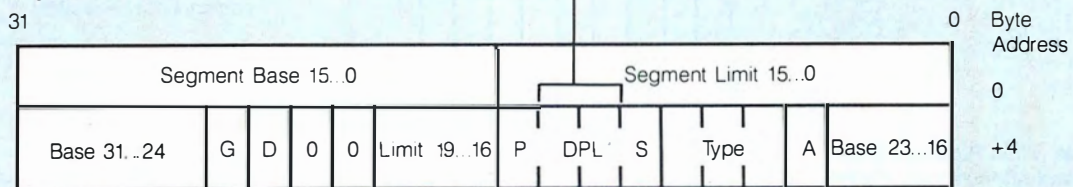

- Base Base address of the segment
- Limit The length of the segment
- P Present Bit 1=Present 0=Not Present
- DPL Descriptor Privilege Level 0–3
- S Segment Descriptor 0=System Descriptor 1=Code or Data Segment Descriptor
- Type Type of Segment
- A Accessed Bit
- G Granularity Bit 1=Segment length is page granular 0=Segment length is byte granular
- D Default Operation Size (recognized in code segment descriptors only) 1=32-bit segment 0=16-bit segment
- 0 Bit must be zero (0) for compatibility with future processors

Figure 6: Four levels of protection.

Segment Descriptor-Cache Register Contents

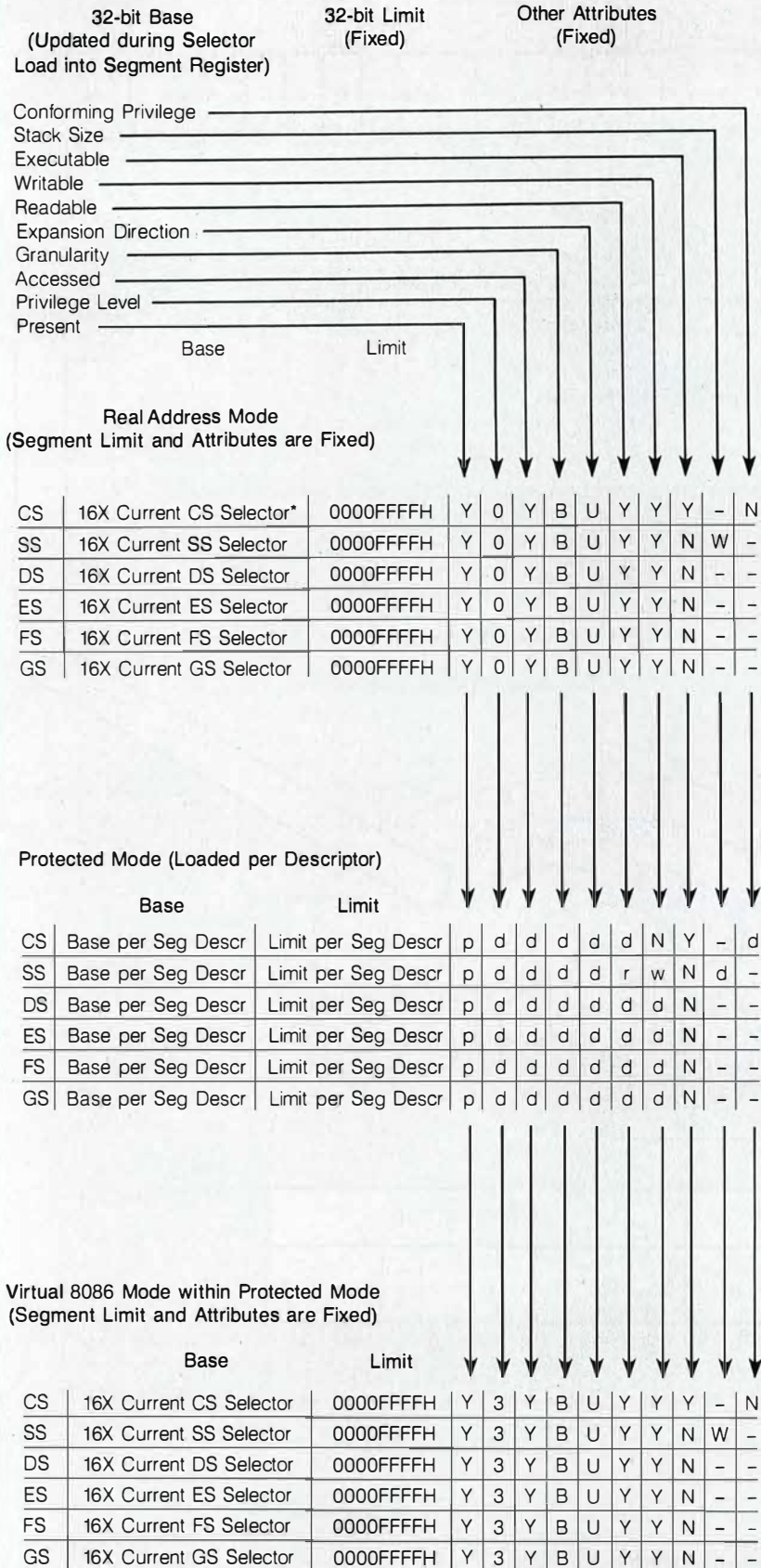

Key: Y = yes
N = no
0 = privilege level 0
1 = privilege level 1
2 = privilege level 2
3 = privilege level 3
U = expand up
D = expand down
B = byte granularity
P = page granularity
W = push/pop 16-bit words
F = push/pop 32-bit dwords
- = does not apply to that segment-cache register

*Except the 32-bit CS base is initialized to FFFFF000H after reset intersegment CALL or intersegment JMP, or INT).

Key: Y = fixed yes
N = fixed no
d = per segment descriptor
p = per segment descriptor; descriptor must indicate "present" to avoid exception 11 (exception 12 in case of SS)
r = per segment descriptor, but descriptor must indicate "readable" to avoid exception 13 (special case for SS)
w = per segment descriptor, but descriptor must indicate "writable" to avoid exception 13 (special case for SS)
- = does not apply to that segment-cache register

Key: Y = yes
N = no
0 = privilege level 0
1 = privilege level 1
2 = privilege level 2
3 = privilege level 3
U = expand up
D = expand down
B = byte granularity
P = page granularity
W = push/pop 16-bit words
F = push/pop 32-bit dwords
- = does not apply to that segment-cache register

Figure 7: Segment-descriptor registers.

such common errors as stack overflow and array subscript errors); segment type, such as code or data (thus catching an attempt to overwrite code, for example); and access rights, such as read-only.

Thus, a spectrum of protection schemes is possible, ranging from no protection to a four-level hierarchy that separates the operating system kernel, residing at level 0, from the operating system services at level 1, custom operating system extensions at level 2, and applications at level 3. (Figure 7 shows segment-descriptor-register contents for real address, protected, and virtual 8086 modes of operation.)

Of course, it is necessary to let applications at low privilege levels make occasional calls, like disk I/O requests, to more protected levels. To handle cases such as this, the operating system can define entry points called gates. Gates contain the logical addresses of entry points and a set of attributes.

MULTITASKING

The 80386 was designed for high-throughput multitasking, in which each task sees only its own execution context and is unaware of other tasks running concurrently. The operating system switches the processor from one context to another, interleaving tasks in accordance with a scheduling policy.

Several data structures, transparent to applications, are defined to support the operating system, principally the task-state segment (TSS). The TSS holds the state of tasks, including processor-register values and data such as scheduling priority, address-space definitions, descriptors, and page-table-directory base. Values held in the 80386 task register point to the running task's TSS.

Because task switching can be frequent, the 80386 provides special high-speed hardware to support this operation. In response to a jump instruction with a special address, the processor automatically stores the state of one task and loads the state of another (at a speed roughly 10

times as fast as software-controlled multitasking).

SOFTWARE COMPATIBILITY

The 80386 supplies binary code compatibility with all previous 8086-family software applications. You can port operating systems and programming tools directly to the new processor

without recompilation or assembly.

For 8086 programs, the processor provides virtual 8086 mode, which establishes a task-selectable protected 8086 environment within the multitasking framework. In this environment, 8086 tasks can take advantage of the 80386's protection and paging

(continued)

CUSTOMIZE YOUR KEYBOARD

YOUR SINGLE SOURCE FOR KEYBOARD ENHANCEMENTS

- Keytop Kits Supporting Most Software
- Touchdown™ Keytop Expanders
- Custom Printed Keytops for Keyboards, Switches, Membranes, and Tablets
- FlexShield™ Keyboard Protectors
- Do-it-yourself Keytop Imprinting
- Custom Key Imprinting
- Function Key and Keyboard Templates
- Keystopper™ Individual Key Lockouts

Hooleon CORPORATION

Keyboard Accessories are our ONLY Business

For information call (602) 634-7515 or write P. O. Box 201, Dept. B, Cornville, AZ 86325

C & PASCAL PROGRAMMERS

Blaise Computing provides a broad range of programming tools for Pascal and C programmers, with libraries designed for serious software development. You get carefully crafted code that can be easily modified to grow with your changing needs. Our packages are shipped complete with comprehensive manuals, sample programs and source code.

C TOOLS PLUS

\$175.00

NEW! Full spectrum of general-purpose utility functions; windows that can be stacked, removed, and accept user input; interrupt service routines for resident applications; screen handling including EGA 43-line text mode support and direct screen access; string functions; and DOS file handling.

PASCAL TOOLS/TOOLS 2

\$175.00

Expanded string and screen handling; graphics routines; easy creation of program interfaces; memory management; general program control; and DOS file support.

VIEW MANAGER

\$275.00

Complete screen management; paint data entry screens; screens can be managed by your application program; block mode data entry or field-by-field control. Specify C or IBM/MS-Pascal.

ASYNCH MANAGER

\$175.00

Full featured asynchronous communications library providing interrupt driven support for the COM ports; I/O buffers up to 64K; XON/XOFF protocol; baud rates up to 9600; modem control and XMODEM file transfer. Specify C or IBM/MS-Pascal.

Turbo POWER TOOLS PLUS

\$99.95

NEW! Expanded string support; extended screen and window management including EGA support; pop-up menus; memory management; execute any program from within Turbo Pascal; interrupt service routine support allowing you to write memory resident programs; schedulable intervention code.

Turbo ASYNCH PLUS

\$99.95

Complete asynchronous communications library providing interrupt driven support for the COM ports; I/O buffers up to 64K; XON/XOFF protocol; and baud rates up to 9600.

RUNOFF

\$49.95

NEW! Text formatter written especially for programmers; flexible printer control; user-defined variables; index generation; and general macro facility. Crafted in Turbo Pascal.

EXEC

\$95.00

Program chaining executive. Chain one program from another even if the programs are in different languages. Shared data areas can be specified.

ORDER TOLL-FREE 800-227-8087!



BLAISE COMPUTING INC.

2560 Ninth Street, Suite 316 Berkeley, CA 94710 (415) 540-5441

The I/O privilege level is used to control interrupt enabling, disabling, and system calls.

mechanisms, while running non-privileged 8086 instructions directly at roughly 16 times the speed of an 8086. If the 80386 operating system you are using supports virtual memory, you can swap 8086 tasks just like any other tasks.

VIRTUAL 8086 MODE

In virtual 8086 mode (activated by the VM86 flag in the flags register), the 80386 presents 8086 operating systems and applications with a virtual machine (the 80386 looks and acts just like an 8086 to the application program). Segment-register semantics are the same as in the 8086.

The total address space of the 8086 is 1 megabyte. Addresses generated by virtual 8086 tasks will all fall within the first megabyte of the 80386 linear address space. In order to assign each task a separate address space, paging is used to relocate the linear address spaces to different areas of the physical address space.

Many 8086 programs were designed for single-tasking environments, and many use I/O and interrupt control in a manner inappropriate for multitasking systems. The 80386 therefore provides mechanisms to selectively trap and manage this I/O and interrupt activity.

I/O PRIVILEGE LEVEL

The I/O privilege level (IOPL) is used to control interrupt enabling, disabling, and system calls. The I/O-port permission map selectively controls access to I/O ports. Memory-mapped devices can be managed using page-level protection attributes. The software module that manages these

operations is called a virtual machine monitor.

With the exception of interrupts and system calls, all 8086 application instructions execute directly on the 80386 at full CPU speed. And since the 80386 is a proper superset of the 80286 architecture, the 80386 runs 80286 applications unchanged. Because the virtual 8086 mode is selectable on a per-task basis and the execution of 16-bit 80286 code is selectable on a per-segment basis, the 80386 can run 8086 applications, 80286 applications, and 32-bit 80386 applications concurrently in a protected multitasking environment.

MULTIPLE EXECUTION ENVIRONMENTS

Taken together, the 80386's flexible memory management architecture, multitasking, protection, and virtual 8086 mode open a vast range of design options. Most striking is the ability to host multiple concurrent-execution environments. Numerous applications, written for different operating systems and different memory management schemes, can run under a 32-bit operating system. An 80386-based system using a UNIX System V kernel could simultaneously support 16-bit 8086 MS-DOS applications running in virtual 8086 mode; XENIX-based 16-bit 80286 applications using segmentation and paging; code ported from linear UNIX environments, like Berkeley 4.2, running in a paged linear model; and UNIX System V applications using segmentation and paging. Despite their diversity, such tasks could coexist, each in its own protected address space. The operating system could switch between environments in the space of a single instruction.

Future 80386 applications might include multiuser microcomputers running mainframe-size programs at mainframe speeds, engineering workstations executing sophisticated UNIX CAE programs concurrently with popular MS-DOS office-automation packages, and 80386-based superminicomputers for on-line transaction processing. ■

Canon presents your personal print shop.

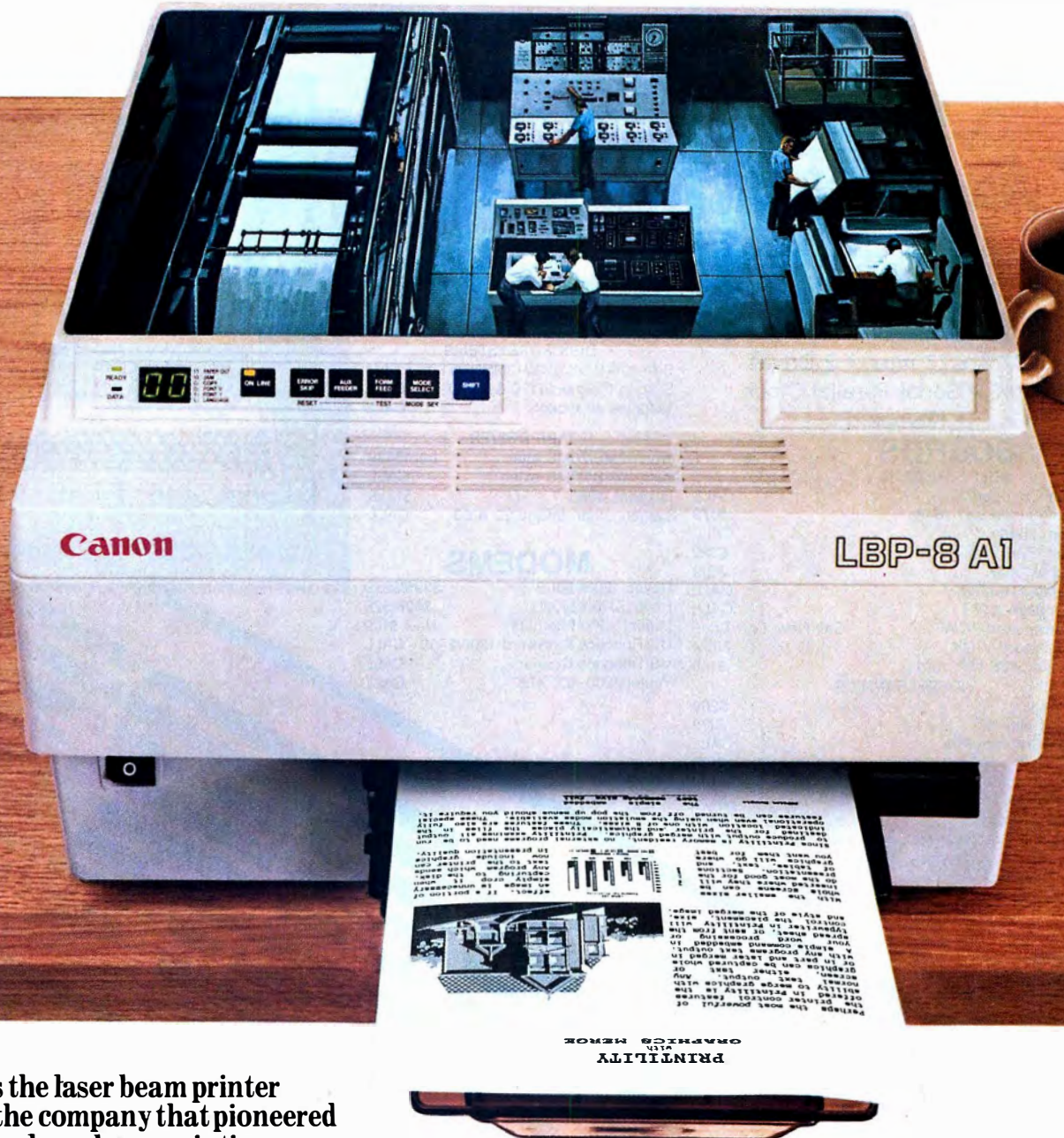

Here's the laser beam printer from the company that pioneered desktop laser beam printing.

From the shortest memo to the longest report, the Canon LBP-8 A1 makes everything you print look hot off the presses. Your output will look so professional you'll think it came from a print shop.

The LBP-8 A1 is incredibly fast, producing copy at a rate of 8 pages per minute, and because it's non-impact, it prints so quietly that you'll hardly know it's working.

This versatile printer lets you use a wide range of plug-in fonts. And Canon's replaceable cartridge

system makes it virtually maintenance-free.

To set up your own personal print shop, get the Canon LBP-8 A1, or the LBP-8 A2 with full graphics capability. You're sure to make a favorable impression with everything you print. To learn more about Canon's advanced laser beam printers as well as the complete line of wire dot matrix and bubble-jet printers, call 1-800-453-3307. (In Utah, 1-800-662-2500.)

Canon
PRINTERS
Printouts that stand out.

Canon U.S.A., Inc., Printer Division, P.O. Box 619865, Dallas/Fort Worth Airport, Texas 75261. © 1986 Canon U.S.A., Inc. Printility is a product of Metro Software Inc.

Complete Systems Shipped Overnight



TURBO XT \$799

- 4.77 & 6.77 mhz • 2 Drives
- 640K • Serial Parallel Clock
- Keyboard

BOARDS

MULTIFUNCTION

Quadram Quadport AT	CALL
Quadram Quadboard 384K	\$179
Quadram Liberty	CALL
Quadram EMS Plus	\$329
AST Sixpak 384K	\$219
AST Sixpak Premium	CALL
AST Rampage XT/AT	CALL
AST Ramvantage PC/AT	Call New, Low Price
Thesis Fastcard V OK	New!
Ram Board 512K half card	\$169

VIDEO/GRAPHICS

AST Preview	\$289
Hercules Color	\$179
Hercules Graphics Plus	CALL
IBM Color	\$198
IBM Monochrome	\$198
Quadram EGA	\$375
Color Card w/par.	\$129
Monochrome Graphics Herc. comp. w/parallel	\$149

NETWORK

Orchid PCNET	CALL
Quadram Quadnet IX	CALL

EMULATION

AST 5251 mod 11/12	CALL
DCA IRMA	CALL
Forte Data 3278	CALL

MASS STORAGE

FLOPPY DRIVES

Half Height 360K (bl/grey)	\$98
Half Height 1.2MB (gry)	\$147
Tandon TM100-2	\$125
Toshiba Half Height	CALL

INTERNAL HARD DRIVES

All hardware drives complete with controllers, mounting hardware & instructions. All are formatted, tested & have 1 year warranty.

Seagate 10MB	\$399
Seagate 20MB	\$499
Seagate 30MB	CALL
Seagate 20MB for AT	\$599
Seagate 30MB for AT	\$729
Priam 40MB/60MB for AT	\$1395/1595
Priam 40MB/60MB for AT	\$1425/1625

DISK CARDS

CMS 10MB/20MB	\$499/699
Hardcard 10MB/20MB	CALL
Mountain 10MB/20MB	CALL

DISK SUBSYSTEMS

Bernoulli Box 20MB/40MB	New Low Prices
Sysgen Flatpak 20/20 & 20/60	CALL
Tallgrass all models	CALL

TAPE DRIVES

Irwin 10MB/20MB inter.	from \$499
Irwin 10MB/20MB exter.	CALL
Tallgrass 4060	\$1349
Sysgen Smart Image 20 & 60	CALL

MODEMS

Hayes 1200/1200B	\$395/\$329
Hayes 2400/2400B	\$596/526
Migent 1200 Internal	New \$109
US Robotics Password 1200/2400	CALL
US Robotics Courier	CALL
Ventel 1200 w/XTALK	CALL



AT&T 6300

\$1899

- AT&T Monochrome Display
- 2 Drive • 640K • Complete

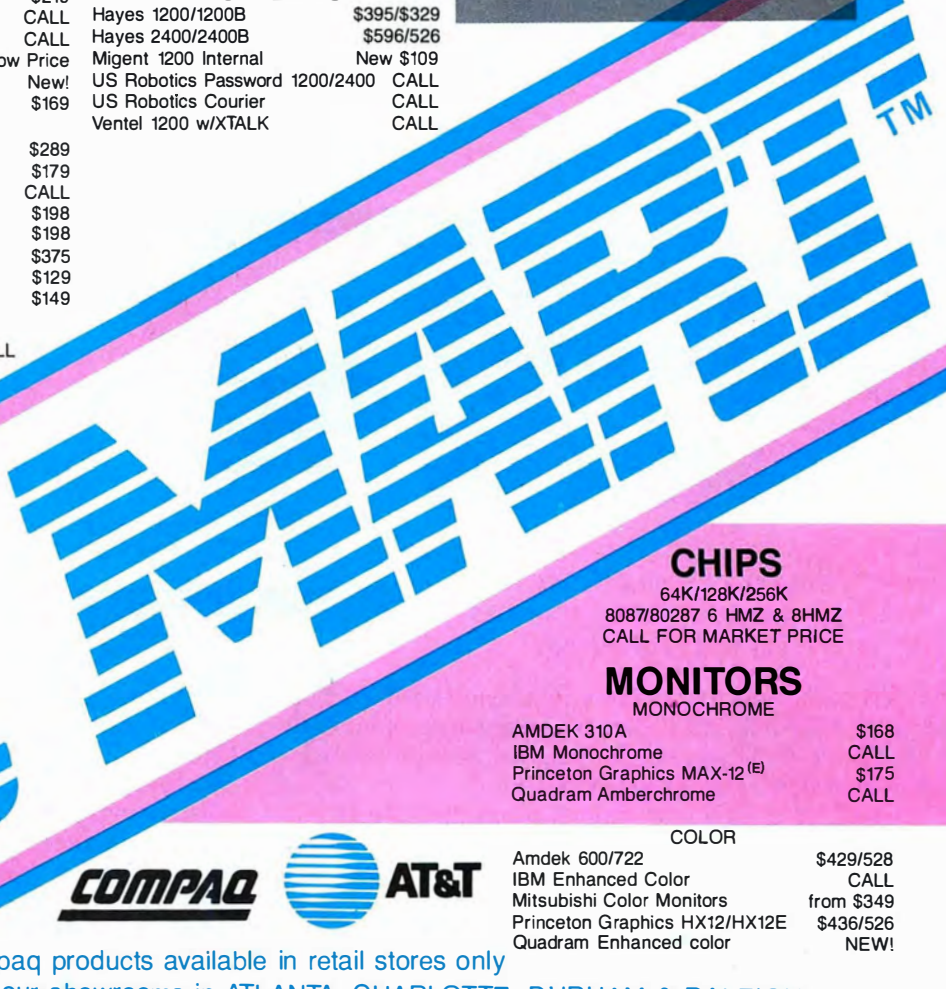

CHIPS

64K/128K/256K
8087/80287 6 HMZ & 8HMZ
CALL FOR MARKET PRICE

MONITORS

MONOCHROME

AMDEK 310A	\$168
IBM Monochrome	CALL
Princeton Graphics MAX-12 ^(E)	\$175
Quadram Amberchrome	CALL

COLOR

Amdek 600/722	\$429/528
IBM Enhanced Color	CALL
Mitsubishi Color Monitors	from \$349
Princeton Graphics HX12/HX12E	\$436/526
Quadram Enhanced color	NEW!

COMPAQ



AT&T

Compaq products available in retail stores only

Visit our showrooms in ATLANTA, CHARLOTTE, DURHAM & RALEIGH.

The Oldest Computer Store in the South • Since 1975



***TURBO AT 286 \$1899**

- 6/8 mhz • 640K • 1-2 MB Floppy
- Serial Parallelport Clock
- AT Keyboard
- 20MB drive

1-800-241-0286

SUPPLY HOUSE

PC Mart Diskettes box	\$18
case	\$159
Maxell Diskettes box	\$28
case	\$258



Personal Computer Centers

1485 Northeast Express NE

Atlanta, GA 30329

INFORMATION

1-404-634-5995

SOFTWARE

Ashton Tate Framework II	Call
Andrew Tobias Managing Your Money	\$129
Ashton Tate dBase III Plus	Call
Borland Sidekick	\$39
Borland Turbo Pascal w/BCD & 8087	\$79
Borland Turbo Lighting	\$65
Borland Prolog	Call
Borland Superkey	\$49
Borland Reflex	\$69
Clipper dBase Compiler	CALL
Computer Associates IUS	CALL
Acting Series	from \$299
Decision Resources Chartmaster	\$239
Decision Resources Signmaster	\$189
Decision Resources Diagrammaster	\$259
Digital Research Gem Draw Collection	CALL
Digital Research Gem Collection	CALL
Easy CADD	CALL
Funk Software Sideways	\$48
Harvard Total Project Manager	CALL
Hayes Smartcom II	\$89
IBM Displaywriter III	\$369
Lattice C-Compiler	\$298
Lifetree Volkswriter Deluxe	\$169
Microsoft Windows	\$79
Microsoft Word 3.0	CALL
Microstuff XTalk XVI	\$109
MultiMate latest	CALL
Multimate Advantage	CALL
Norton Utilities	\$59
Open Systems Accounting Series	CALL
Prodesign II CAD software	CALL
Rosesoft Prokey	\$99
Satellite Software Wordperfect 4.1	CALL
Software Publishing Co PFS Series	from \$79
Sorcim Supercalc III	\$219

PRINTERS

DOT MATRIX

Brother HR1509	\$398
Brother 2024L	CALL
Brother Twinwriter 5 Dot Matrix & Letter Quality	CALL
Epson LX-86	CALL
Epson FX-85/FX-286	CALL
Epson LQ-800/LQ-1000	CALL
IBM ProPrinter	\$425
Okidata 182	\$239
Okidata 192/193	\$385/525
Okidata 292/293	CALL
Okidata 2410	CALL
Toshiba 321/341/351	New Low Price!
Toshiba 351 Color	CALL

LASER/LETTER QUALITY

Brother HR15 XL	CALL
Brother HR25/HR35	\$568/\$798
Corona LP300 Laser	\$2395
Epson DX20/DX35	CALL
IBM Quietwriter II	\$1,259
Quadram Quadlaser	In Stock

PLOTTERS

Houston Instruments	CALL
IO Line Plotters	CALL
all models available for quick delivery	

Miscellaneous

Mousesystems PC Mouse w/paint	\$139
Microsoft Mouse serial/bus	from \$129
Keytronics 5151/5153	CALL
Keyboards for PC and AT	from \$69
Quadram Microfazer 8K	\$129
Quadram Microfazer II	CALL
Tripplite Isobar	from \$45
Tripplite UPS 400	CALL
Curtis Protectors	from \$29

*Monitor Not Included

IBM®
AT Enhanced \$3495

- 6 mhz • 1-2 MB Floppy • 512K
- 20 MB Drive • Serial Parallel Clock

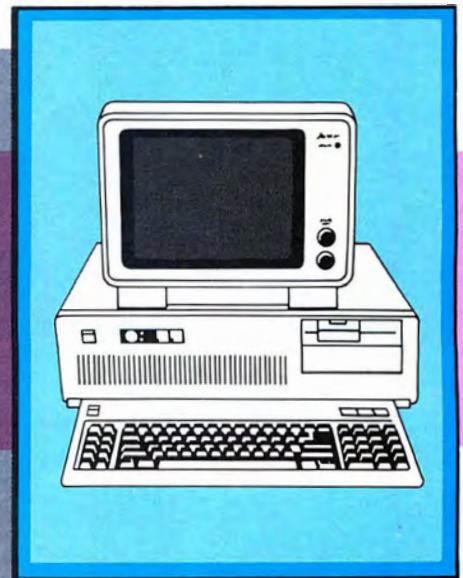

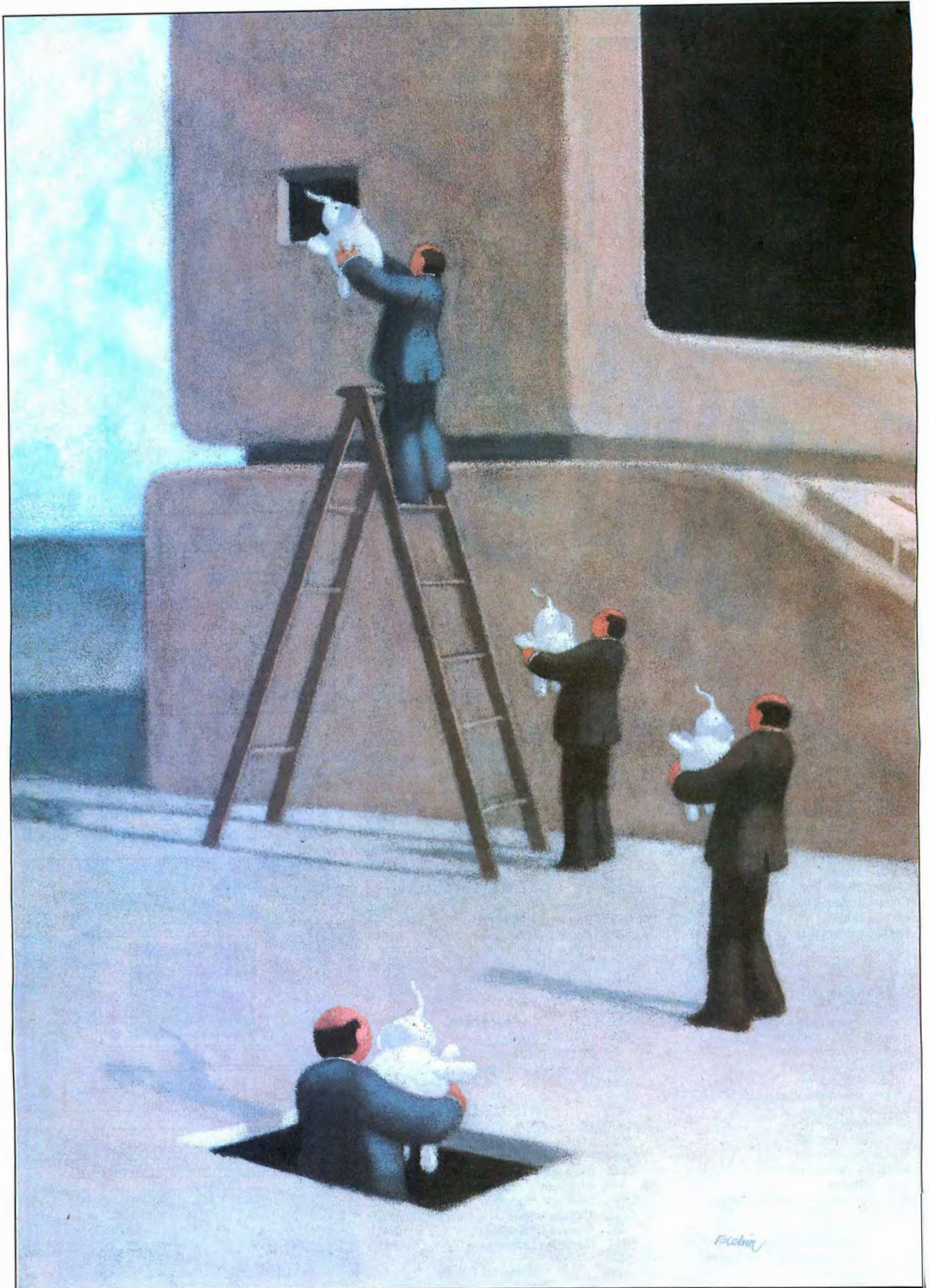

VIRTUAL MEMORY, VIRTUAL MACHINES

*The 80386 offers virtual memory capabilities
with memory protection*

BY JON SHIELL

VIRTUAL MEMORY is a method for making the amount of memory that a program uses independent of the actual amount of RAM in the machine. In virtual memory systems, the disk memory effectively becomes the main memory, and the RAM becomes a temporary holding area for code and data that the processor is currently using. With virtual memory, the programmer doesn't care how much RAM (hereafter called *real memory*) the machine has. In fact, the program has no way of knowing how much real memory the system has. Instead, the program cares only about how big the virtual address space is.

The 8086 (which does not support virtual memory), the 80286, and the 80386 in real mode have a real address space of only 1 megabyte. The 80286 in protected mode has a virtual address space of 1 gigabyte and a real address space of 16 megabytes. The 80386 in protected mode has a virtual address space of 64 terabytes and a 4-gigabyte real address space. For comparison, IBM's latest mainframe architecture, 370/XA, can have virtual address spaces that add up to 128 terabytes and a real address space of 2 gigabytes. The 80286's 1-gigabyte virtual address space is composed of 16,000 segments of 64K bytes each. The 80386's 64-terabyte virtual address space is composed of 16,000 segments of 4 gigabytes each. [Editor's note: The latest version of the 80386 is BI.]

Virtual memory systems must provide hardware support for the translation of the virtual (or logical) addresses into real (or physical) addresses. During the translation, the hardware must be able to recognize

those portions of code and data that are not resident in real memory. Such recognition is commonly called a *fault*. An interrupt must notify the operating system that such portions are needed and must be brought into real memory from the disk (see figure 1).

A virtual memory system must also be able to handle the situation where either the next instruction that is to execute or data that the current instruction needs is not resident. In such cases, the hardware has to fault to the operating system, which then brings in the required code or data. Then the operating system must be able to resume execution of the program at the instruction where the fault occurred without the fault being visible to the program. In other words, the instructions must be *restartable*.

A couple of ways exist to make an instruction restartable. For those instructions that write a single result, you can have the instruction issue all its accesses before it attempts to write the result. For more complex instructions that store multiple results, you have two options. The instruction has to either test all result locations to make sure they are resident before it actually stores to any of them or it must be interruptible: It must save enough state information to be able to resume execution at the point at which it was stopped.

VIRTUAL MEMORY SCHEMES

There are three kinds of virtual memory (VM) schemes. Segmenting schemes break memory into variable-length units called *segments*. Paging schemes divide memory into fixed-length units called *pages*. Finally, the hybrid scheme (like that in the 80386)

uses variable-length segments that are divided into pages.

In virtual memory schemes, you have a trade-off between the amount of real memory in the system and the amount of virtual memory that it can support with reasonable performance. Typically, what you need is enough real memory to hold the working sets of a significant fraction of the programs that you want to run. Having less than this amount of real memory causes a tremendous increase in disk I/O due to paging or segment swapping. (Swapping of pages is called *paging*. Bringing something from a disk to real memory is a page-in operation; moving something from real memory to a disk is a page-out operation.) When the system reaches the point where a large amount of its time is spent paging in and paging out instead of executing programs, it is said to be *thrashing*.

The 8086/8088 microprocessors cannot implement virtual memory because they don't have the required address-translation hardware on-chip and they don't support an off-chip memory management unit. The only memory management that they can perform is overlays, which require that the program explicitly manage its own swapping of resident and disk code and data. Almost all big MS-DOS programs use overlays: Lotus 1-2-3 and WordStar are two examples. DOS provides explicit support for overlays via a DOS function call. Overlays have certain disadvantages. First, an individual section of an overlay can be

(continued)

Jon Shiell is a system architect and micro-programmer. He can be reached at P.O. Box 61195, Sunnyvale, CA 94088.

The presence of these fields means that the 8086 method of doing simple 32-bit arithmetic for addressing structures bigger than 64K bytes doesn't work in protected mode. A couple of methods that will work are detailed in listing 1. Also note that the 80286's segments—like the 8086's—can be from 1K to 64K bytes long. However, the 8086 segments start on a 16-byte boundary; thus, the segment number can overlap the apparent offset (see figure 3). The 80286's segment numbers do not overlap the offset values, so they appear on 64K-byte boundaries in the virtual address space.

Intel has solved this 8086 addressing compatibility problem in the 80386 by providing an 8086 virtual machine mode that I will discuss in more detail later. In this mode, even though the machine is running in protected mode, the 80386 uses 8086-type selector and addressing.

The 80286 (used in the IBM PC AT and its clones) implements virtual memory at the segment level, that is, by swapping whole segments. Thus, address translation in the 80286 consists of remapping segments from one spot within the virtual address space into another within the real memory (see figure 4). This is done by providing a P-bit (present bit) in the segment descriptor that indicates whether or not the segment is present in real memory. When software attempts to load a segment register with a descriptor whose P-bit is 0, the hardware takes an interrupt of type 11 or, for stacks, interrupt type 12 (see table 1).

This interrupt lets the operating system fault handler load this seg-

ment into real memory, possibly overwriting a current segment. If the segment to be overwritten has been modified since being brought in from disk, the operating system will write the modified segment out to disk before overwriting it. Once the required segment has been brought in, the fault handler can return to the interrupted program, letting the program continue operation without knowing anything happened. The instruction pointer that is saved on the stack points to the first byte of the faulted instruction. This facilitates restarting the interrupted program from the fault handler via the IRET (interrupt return) instruction.

THE 80386 VM SCHEME

The 80386 overcomes the addressing compatibility problems between the

80286 and 8086 by implementing both of their addressing modes as well as its own 32-bit native addressing mode. There is no specific 80286 compatibility mode. Instead, each time the 80386 switches between tasks, it specifies the mode of its target program (see figure 5) via the TYPE and D bit fields of the code-segment descriptor. Unlike the method used for 80286 compatibility, 8086 mode is explicitly specified by the VM bit in the processor's FLAGS register.

In addition to the segment-level protection provided by the 80286, the 80386 provides page-level protection when paging is used. Since the 80386 first performs segment translation, followed by page translation, it is possible to have two or more small segments share a single page. In this

(continued)

Listing 1: Pseudocode example of address arithmetic in 80286 protected mode.

Adding a displacement of 16 bits or less: (offset in DX, displacement in AX)
Add new displacement to DX.

If carry-out then

Move DS into BX.

Add '0008'x to BX. (add 1 to index field)

Move BX back into DS.

Adding a displacement of more than 16 bits: (offset in DX, displacement in BX:AX)

Add new displacement to DX. ($DX \leftarrow DX + AX$)

Add carry-out to BX.

Left-shift BX by 3. (align with index field)

Move DS into CX.

Add CX to BX. (add displacement high to index field)

Move CX back into DS.

80386 handling of displacements of up to 32 bits

in native mode: (offset in EDX, displacement in EAX)

Add EDX, EAX

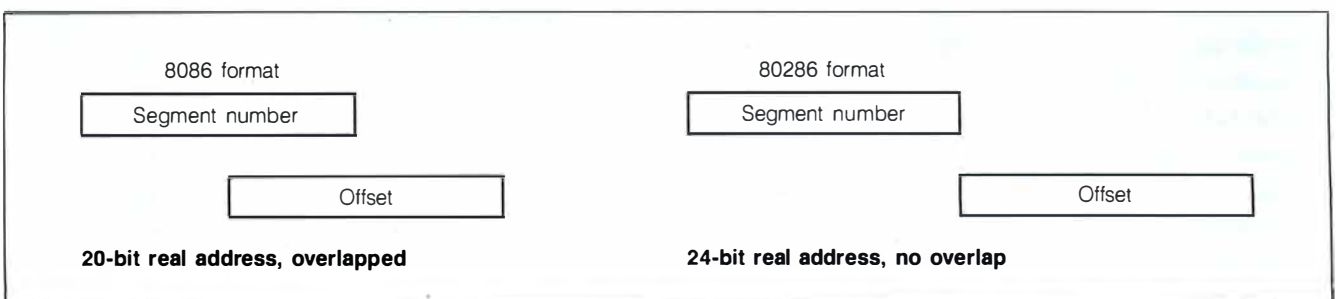

Figure 3: Differences in address translation between the 8086 and 80286.

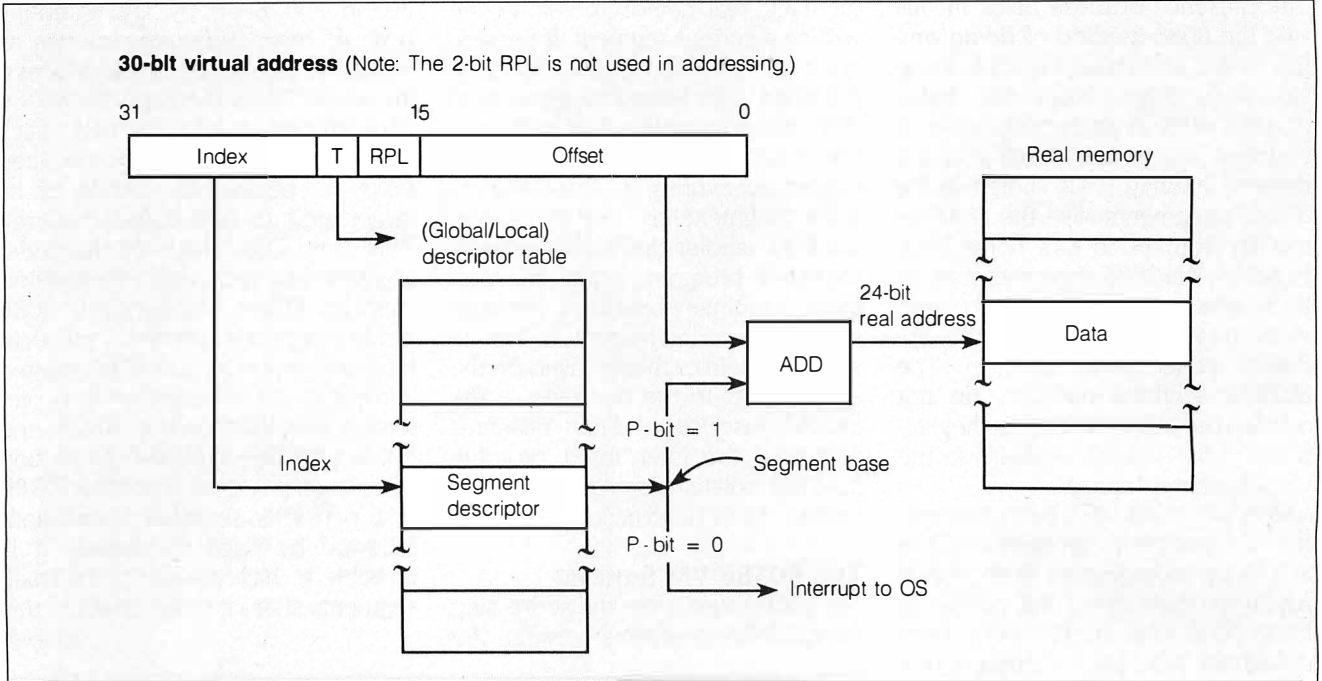

Figure 4: 80286 virtual address translation.

Table 1: 80386 interrupt vectors.

Function	Interrupt Number	Instruction That Can Cause Exception	Return Address Points to Faulting Instruction
Divide error	0	DIV, IDIV	Yes
Debug exception	1	Any instruction	Yes
NMI interrupt	2	INT 2 or NMI	No
1-byte interrupt	3	INT	No
Interrupt on overflow	4	INTO	No
Array bounds check	5	BOUND	Yes
Invalid op code	6	Any illegal instruction	Yes
Device not available	7	ESC, WAIT	Yes
Double fault	8	Any instruction that can generate an exception	
Invalid TSS	10	JMP, CALL, IRET, INT	Yes
Segment not present	11	Segment-register instructions	Yes
Stack fault	12	Stack references	Yes
General protection fault	13	Any memory reference	Yes
Page fault	14	Any memory access or code fetch	Yes
Coprocessor error	16	ESC, WAIT	Yes
Intel reserved	17-32		
2-byte interrupt	0-255	INT n	No

case, the page-level protection would not be used. Note that the operating system can still use the paging scheme for memory management; however, care must be taken to ensure that the page is swapped out only when all the segments in the page are not in use.

The 80386 VM scheme implements virtual memory via mainframe-style paging schemes using two-level translation tables. The first level, pointed to by CR3 (control register 3), is the page-directory table containing from 1 to 1024 page-directory entries of 4 bytes each. Each of these PDEs points to a page containing page-table entries of 4 bytes each, for up to 1024 pages. Each PTE contains the address of a 4K-byte block in real memory called a *page frame*. Thus, a PDE points to PTEs describing up to 4 megabytes of real memory. Both the PDT and each page table will not exceed one page (4K bytes) in length and are aligned on page (4K-byte) boundaries. Also, the pointer in CR3 and the pointers within the PDEs and PTEs are real addresses, not virtual addresses. If they were not real addresses, you would run the risk of your page tables being paged out, effectively hanging the system.

Figure 6 shows the format and contents of a PTE. The accessed and dirty bits of a PTE are used for memory management. The OS will use the accessed bit to keep track of how often a program uses a page and the dirty bit to tell whether the page must be copied out to the disk before the new page overwrites it. The standard method of tracking a program's page use is to have the operating system periodically clear the accessed bit of all pages a program has in real memory and then check, after a certain period, which pages have their accessed bits set. This information, collected over a period of time, tells which pages a program is currently using. This set of pages is called the program's *current working set*. Also, a P-bit indicates to the processor whether this page is present in real memory. If the bit is off, the processor takes a page fault to the operating system so

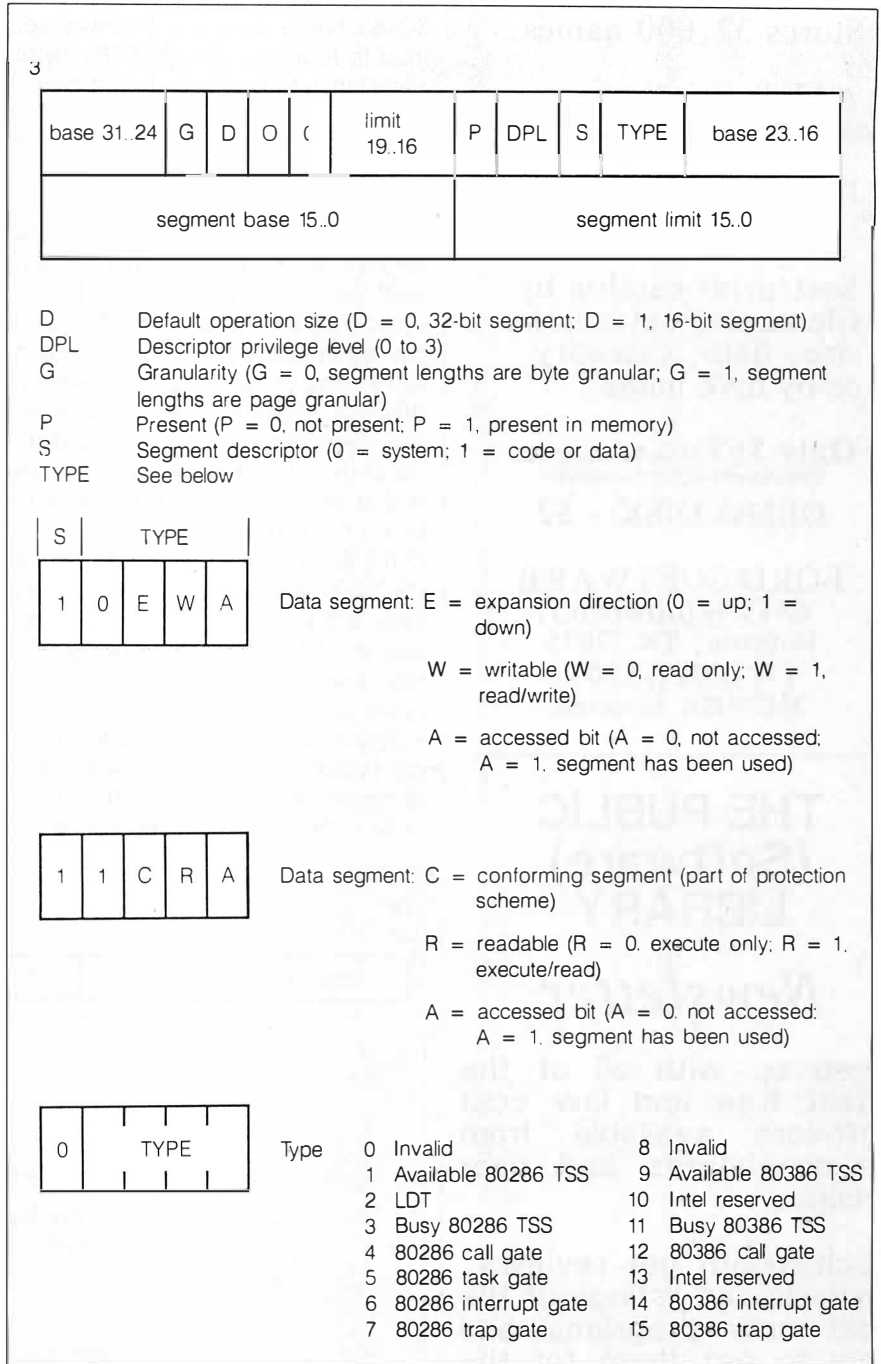

Figure 5: 80286/80386 segment-descriptor format.

it can bring in the page from disk. The process of bringing in a page when a program faults on it is called *demand paging*.

The translation of virtual addresses requires two accesses—the first to get the PDE and the second to get the PTE—for each access done by the

program. Rather than run at less than one-third of its potential speed, the 80386 uses an on-chip address cache called a translation-lookaside buffer. This cache, unlike a "normal" cache, returns a PTE—instead of a data word—when given an address. The

(continued)

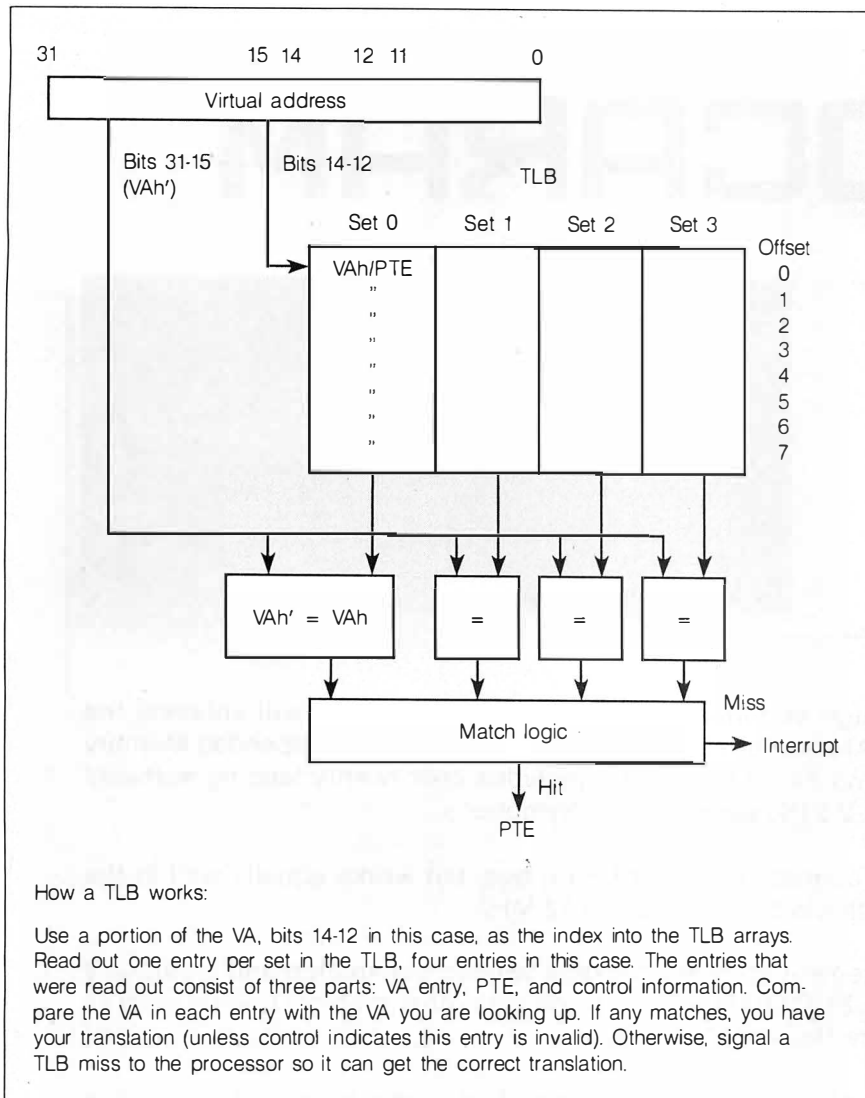

How a TLB works:

Use a portion of the VA, bits 14-12 in this case, as the index into the TLB arrays. Read out one entry per set in the TLB, four entries in this case. The entries that were read out consist of three parts: VA entry, PTE, and control information. Compare the VA in each entry with the VA you are looking up. If any matches, you have your translation (unless control indicates this entry is invalid). Otherwise, signal a TLB miss to the processor so it can get the correct translation.

Figure 7: Sample diagram for a 32-entry translation-lookaside buffer.

far), the DMA unit doesn't know about paging and the processor must set up each page transfer separately. In the second way, the DMA unit knows how to handle a string of real addresses and counts that point to each page that I/O is to address and specify the number of bytes to be moved. Finally, the DMA unit itself can use virtual addressing, in which case it must be given a translation table address in addition to a starting address and count. Of course, the pages that I/O will be addressing should be locked.

An 80386 running in 8086 virtual machine mode treats segment descriptors as the 8086 does: They are

simple 16-bit integers that are multiplied by 16, then added to the 16-bit offset to get a 20-bit virtual address. Unlike the 8086, the 80386 then performs page translation on the address. Thus, the 1-megabyte address space of an 8086 program is split into 256 4K-byte pages. Using paging to remap the address space permits the sharing of pages that are not written to. This reduces the real memory required to support multiple 8086 virtual machines. Also, the host operating system can use the remapping function to provide page-level protection for the guest operating system.

(continued)

PARALLEL PROCESSING FOR THE PC!

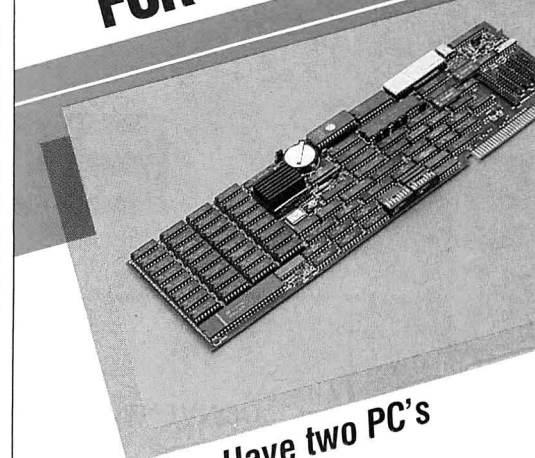

Have two PC's in one!

Run two applications independently!

Add the I-Bus IQ188 Parallel Processor to your system and have a computer within a computer. The IQ188 has its own 7.35 MHz 80188 processor, BIOS, ST-506 hard disk controller, 1 Megabyte dual-ported RAM, 2 serial ports, a parallel port and a clock/calendar. It runs on its own copy of your PC/MS/DOS operating system and communicates with the PC through shared memory.

The IQ188 includes all the software utilities you need to get up and running with your programs. Once you've used the I-Bus Parallel Processor, you'll never be without it!

- Run dBASE™ sorts in the background while analyzing 1-2-3™ spreadsheets on the PC!
- Assemble or compile applications in the background while editing in the foreground!

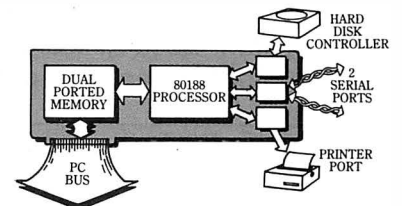

1-2-3 is a trademark of Lotus Development Corp. dBASE is a trademark of Ashton-Tate, Inc.

Call today for details:
(800) 382-4229 in Calif. (619) 569-0646

I-BUS
The Full Service PC Bus Company

9235 Chesapeake Dr., San Diego, CA 92123
(619) 569-0646 Telex: 910 240 0290

**EMS
ABOVE BOARD
COMPATIBLE**

A low cost mid-size card
for oversize jobs

BOCARAM™

CONVENTIONAL
FULL-SIZE
MEMORY CARD

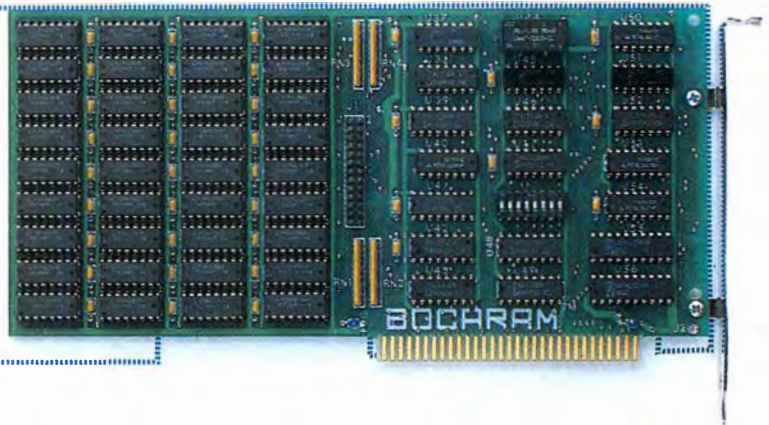

BOCARAM is a low-cost high performance EMS memory board that will enhance the power of your PC. BOCARAM conforms to the Lotus/Intel/Microsoft Expanded Memory Specification whose growing list of supporters includes over twenty leading software manufacturers like Lotus 1-2-3 (Release 2.0) and Symphony.

BOCARAM is designed to connect to a PC/XT 8 bit bus, but works equally well in the PC-AT and compatibles with clock speeds up to 12 MHz.

A versatile memory management software package speeds installation and provides a RAMdisk and print spooler. BOCARAM will co-reside with other memory boards such as Intel's Above Board or Boca Research's MEMEK.

The Boca Research family of memory and graphic add-on products is available from a growing network of dealers. All products are supported by a qualified technical support staff. Boca Research products are designed and manufactured in the U.S. to meet the highest standards of quality control. All products are protected with a one year warranty.

Suggested Retail Prices

256K	\$245.00
1Meg	395.00
2Meg	740.00

For additional information
call your Boca Research
dealer or contact us
directly at:

Specifications

Board Size:	4.25 X 8.5 inches
CPU Speed:	4.77 to 12 MHz.
RAM Chips:	150 ns 256K



6401 CONGRESS AVENUE, BOCA RATON, FLORIDA 33431

(305) 997-6227

Registered Trademarks:
IBM PC/XT/AT, INTEL, ABOVE BOARD, LOTUS, MICROSOFT

V I R T U A L M E M O R Y

WHY NO 80386 VIRTUAL MACHINE?

One reason the 80386 cannot "virtualize" itself is the asymmetric behavior in its instruction pairs, such as PUSHF and POPF. PUSHF saves the REAL flag values in protected mode. POPF will not cause a general-protection exception in protected mode. Even if an attempt is made to alter the I/O privilege level or interrupt flag* bits without sufficient privilege level, no interrupt will occur for an unauthorized alteration attempt: it is simply ignored.

Consider the attempt to virtualize XENIX-286 under the current 386 architecture. The XENIX kernel may use the POPF instruction to alter the current IF bit. This works in native 286 mode (no VM). Under VM, the hardware will not allow the change, and no notification will occur (via a general-protection exception) that an attempt to alter the IF bit was made. As far as the host CP is concerned, the guest XENIX OS is still able to receive interrupts from the outside. If XENIX is in the middle of altering a critical area where interrupts can't be tolerated (such as stack changes or modifying the global-descriptor table) and the host CP has no way of knowing its guest's state, the interrupt is passed to XENIX at the wrong time, causing the guest to crash.

A similar problem exists with the task-register load and store instructions (LTR/STR). Again, consider the attempt

to virtualize XENIX-286. It's normal for XENIX to store its current task register during preparation for a task switch (many operating systems do this). In the current 386 architecture, if XENIX attempted to load the task register, this would cause a GP exception and appropriate simulation by the CP could be done. However, when XENIX stores its task register (which has been virtualized), no GP exception occurs, and the real (CP) task register is stored. If XENIX had stored the TR with a value, say, of 21F (a XENIX task-register value), the LOAD might return a value of IC (the real CP value). Any internal bookkeeping XENIX was doing that depended on LTR/STR being a matched set is destroyed, and bugs will result.

The final problem with virtualizing the 80386 relates to addressing problems. Part of the difficulty is that the CP must share the same address space with the guest. The other part of this problem deals with interrupts: For a virtual machine interrupt, the address that you transfer to is a virtual address. This causes the following problem when attempting to run an 80386 virtual machine. Say that a guest OS is using linear address 8000000 for some control information. Suppose that the host CP also uses that address for some purpose. Due to the nature of the 80386, the host CP cannot set up the page tables to prevent this, and data is overwritten.

It is even possible to support virtual expanded memory.

VIRTUAL MACHINES

A virtual machine is the extension of the concept of virtual memory to an entire machine, including I/O devices and privilege levels, so that a program can't tell that it doesn't have a real machine—in this case an 8086—to itself. A virtual machine lets multiple operating systems (which may be incompatible) run concurrently with no modification or conflict. A program

running in a virtual machine sees whatever memory and I/O the host operating system desires, not the amount of memory in or the I/O devices of the real machine. It is important to note that a virtual machine is not an emulator, nor is a virtual machine as efficient as a real machine.

Why use virtual machines in the first place? Because this permits an 80386 system to run multiple PC-DOS programs unmodified in what appears to be their native environment. Thus, the

(continued)

THE BOARD LEVEL PC BUS BY I-BUS.



We Speak Systems.

Get your dedicated system to market *months* sooner with the PC Bus or PC-AT Bus. The full board-level, passive backplane implementation by I-Bus lets you plug together system components from hundreds of PC Bus manufacturers, and directly execute software developed on and for the IBM® PC and PC-AT.

I-Bus has 4 CPU cards with up to 256K of on-board EPROM space for dedicated applications, and with PROMDISK, you don't even need to produce ROMable code. We have the most complete line of system packaging for the PC/PC-AT Bus, too. All you add are your favorite PC expansion cards for your application.

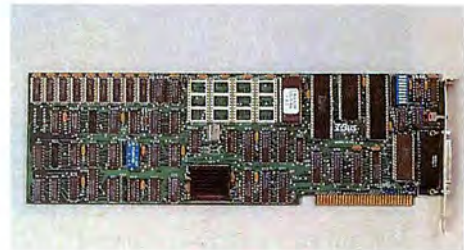

If you're into systems, I-Bus speaks your language.

Call TOLL FREE:
(800) 382-4229 In Calif. (619) 569-0646

I-BUS

The Full Service PC Bus Company

9235 Chesapeake Dr., San Diego, CA 92123
(619) 569-0646 Telex: 910 240 0290

Still the only integrated scientific analysis, graphics, and data acquisition software.

ASYST™



Macmillan's widely-acclaimed ASYST™ Scientific Software still offers more built-in capabilities than any other PC software. Its unique interactive programming environment includes such functions as FFT, smoothing, integration, differentiation, curve fitting, statistics, differential equations, and matrix and polynomial operations. And all functions are supported by sophisticated graphics, such as error bars, scatter plots, and axonometric plotting.

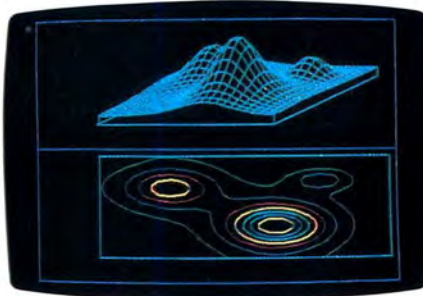

ASYST's extensive function set provides the building-blocks that let you assemble scientific applications—fast. RS-232 and optional A/D and

GPIB/IEEE-488 support offer interface versatility you just can't get from other products. And all hardware support integrates seamlessly with the full range of ASYST capabilities.

Free technical support. 60 days of free technical support help you design, set up, and fine-tune the perfect system. Ongoing support is available at a nominal cost.

**30-Day No-Risk Offer.
CALL 1-800-348-0033.**

In New York state, (212) 702-3241.

Ask for technical literature, including performance benchmarks.

Macmillan Software Co.

An affiliate of Macmillan Publishing Company
630 Third Avenue, New York, NY 10017

need to modify existing programs so that they run in protected mode is avoided. This ability to run multiple operating systems lets the 80386 run an 8086-type UNIX or CP/M-86 at the same time, in addition to the native-mode user interface.

To support multiple virtual machines, a control program (CP) actually manages the real machine's resources (real memory, I/O, privilege levels). The CP creates and handles multiple virtual machines, distributing the real machine resources in an orderly fashion. The CP is not an operating system: It is a layer of software that mediates requests from the operating system to the hardware.

For a processor to support virtual machines, all instructions that would let a program be able to tell that it is running in user mode must be privileged. Access to some facilities, such as I/O and timers, must be restricted. There must be no possibility of a conflict between a guest address space and the host operating system's address space. This becomes especially evident when you attempt to run a copy of the CP in a virtual machine.

While the current 80386 supports virtual 8086 machines, it does not support virtual 80286 and 80386 machines. This is due to problems in handling the PUSHF and POPF instructions and the store-system-register instructions (STR, SGDT, SLDT, SMSW) and to the fact that the address to which an interrupt transfers control is a virtual address using the local-descriptor tables and global-descriptor tables at the time the interrupt occurred. (For additional information, see the text box "Why No 80386 Virtual Machine?" on page 119.) While the lack of ability to run a virtual machine other than an 8086 is a real limitation, it doesn't seem to be a fatal flaw. Intel might fix this in a later release of the chip.

The 80386 CP invokes an 8086 virtual machine by performing a task switch where a program's task-state segment has the 8086 virtual mode bit (bit 17) set in its copy of the EFLAGS register. Virtual 8086 programs run at the lowest privilege level,

so to utilize specific privileged instructions, the I/O permission-level field in the EFLAGS register and the I/O permission bit map (located in the task-state segment) must also be set up. Now any interrupt or exception causes the 80386 to switch back into protected mode (native 80386 mode) before invoking the handler pointed to by the interrupt-descriptor table. Thus, the routines that are invoked must be 80386 native-mode routines. In most cases, these routines will emulate the operation requested by the virtual machine—for example, an OUT instruction—then return to 8086 virtual mode via an IRET instruction.

When the 80386 runs in virtual 8086 mode, it does address generation like an 8086 but the 20-bit address that is produced is a virtual address. The page-translation hardware then translates the virtual address into a page number and a starting offset within that page. This lets the 80386 CP use a page-level protection "below" the guest operating system, so that elements such as ROM can be emulated (just mark the page "read-only"). This same method lets the host share portions of memory between multiple virtual machines. So while the 8086 virtual machine can't use the segment-level protection that is available to both 80286 and 80386 mode programs, the 80386 CP can use protection at the page level to enhance real memory utilization of the guest machines.

THE WRAP-UP

Virtual memory lets you run a program even if your system doesn't have enough real memory. It also makes multitasking much safer by providing the ability to isolate tasks from one another. The virtual machine mode will protect your investment in 8086 software while providing a relatively painless method of entrance to virtual memory, multitasking, and the 80386 itself. If Intel corrects the inability of the 80386 to "virtualize" itself and the 80286, the same path provided for 8086 software will be available for 80286 software such as XENIX and protected-mode DOS. ■

SQUEEZED FOR SLOTS?



I-Bus Expansion Chassis for IBM PC, PC/XT, PC-AT, Compaq, and other compatibles!

If you want the most from your PC but you've run out of places to put your add-on cards, an I-Bus Expansion Chassis is the right solution. Choose our popular 6-slot mini-chassis or the larger 12-slot chassis with room for two half-height drives. Both come fully tested, complete with power supply and interface. (The interface card requires one slot in your PC.) Prices start at \$795.

They're ideal for portable PC's: a new quick-release 18" or 48" cable lets you leave the chassis (and all the connections to its cards) in place while removing the PC for travel. Or the reverse: move an expansion chassis with special-purpose cards from PC to PC in labs or test facilities.

There's no special addressing or software required to access expansion cards, and *no added wait states* for memory access. I-Bus expansion chassis works with all add-on cards—including display, memory, networking, communications and disk drive cards.



Call today TOLL FREE:
(800) 382-4229 in California (619) 569-0646

I-BUS
The Full Service PC Bus Company

9235 Chesapeake Dr., San Diego, CA 92123
(619) 569-0646 Telex: 910 240 0290

THE NEW FACE FOR YOUR PC

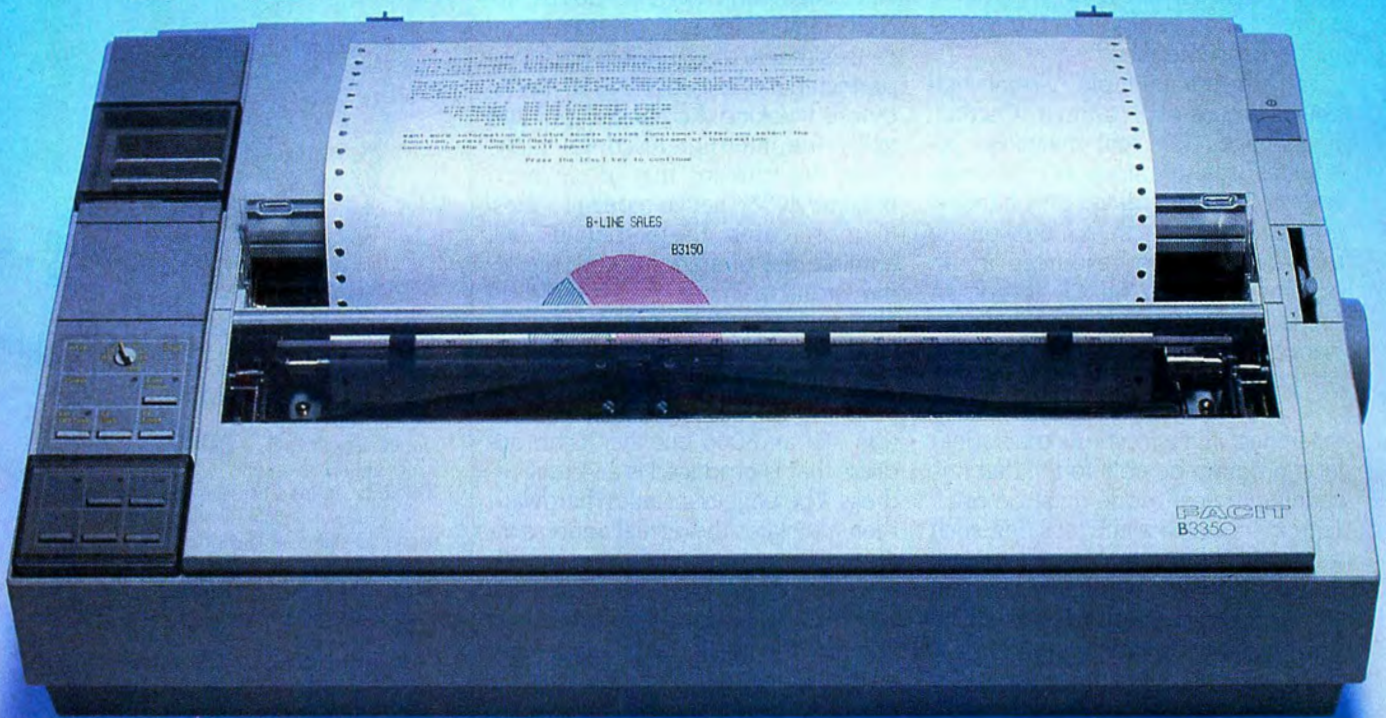

The new generation Facit B-line matrix printers not only provide all the printout options your office requires. They also give you extraordinarily easy access to these features.

Such as when you want to change from high throughput draft to perfect NLQ – just flick the rotary switch on the front panel. When you want to change font style – just plug in a new font card. When you need to change from continuous forms to cut sheets – the printer loads the paper for you.

And while the beauty of the B-line concept improves the impression made by your PC, the attractive design and low noise level make the printers perfect for every office environment, too.

FACIT

Inquiry 324

Head Office: Facit AB, S-17291 Sundbyberg, Sweden. Phone: 46 8 764 30 00.
USA: Facit Inc. P.O. Box 334, Merrimack, NH 03054. Phone: (603) 424-8000

Check out the facts below and go for a test drive at your nearest Facit representative.

- B3100: 80 columns, 128 lines/minute* (250 cps)
 - B3150: 136 columns, 128 lines/minute* (250 cps)
 - B3350: 136 columns, 109 lines/minute* (200 cps), 18-needle printhead for 100 cps NLQ
 - Rotary switch for fast print quality selection
 - Easy operation with soft set-up in national language
 - Extensive paper handling – push/pull tractor, tear-off, automatic loading of single sheets. Optional single or double bin sheetfeeder
 - Low noise key
 - Facit, IBM Proprinter and Epson FX/JX emulations
 - Parallel and serial interfaces
 - 4-color option
 - Extra fonts by means of plug-in card
- * 80 col, 10 cpi.

IBM and Epson are reg. trademarks

AUSTRALIA: EAI Electronics Associates Pty Ltd., 427-3322. AUSTRIA: Ericsson Information Systems GmbH, 0222-613 641. BELGIUM: Ericsson S.A., 02-243 82 11. CANADA: Facit Canada Inc., 416-825-8712. CYPRUS: LBM (Lillytos) Ltd 516 46 34. DENMARK: Facit A/S, 02-63 33 11. FINLAND: OY Facit, 90-420 21. FRANCE: Facit S.A., 1-4780 7117. GREAT BRITAIN: Facit 0634-40 20 80. GREECE: Computer Application Co. Ltd., 01-671 97 22. HONGKONG: Gilman & Co. Ltd., 5-893 00 22. ICELAND: Gisli J. Johnsen HF, 354-64 12 22. INDIA: Forbes Forbes Campbell & Co. Ltd., 22-20 48 081. IRELAND: Ericsson Information Systems Ltd., 75 30 93. ITALY: Facit Data Products S.p.A., 039-63 63 31. JAPAN: Electroflux (Japan) Ltd., 03-479-7570. KOREA: True Trading Co. Ltd., 2-783-3855-7. THE NETHERLANDS: Facit B.V., 3480-21784. NEW ZEELAND: Northrop Instruments and Systems, 501-801, 501-219. NORWAY: Ericsson Information Systems A/S, 02-35 58 20. PORTUGAL: Regisconta Sarl, 1-56 00 91. SINGAPORE: Far East Office Eqpts Pte Ltd., 745 82 88. SPAIN: Perifericos S.A., 4-57 90 81. SWEDEN: Ericsson Information Systems Sverige AB, 08-28 28 60. SWITZERLAND: Ericsson Information Systems AG, 01-82159 21. USA: Facit Inc., (603) 424-8000. WEST GERMANY: Ericsson Information Systems GmbH, 0211-61090.

A PROTECTED-MODE PROGRAM FOR THE PC AT

A program that lets you tap the 80286's power by using its native mode

BY ROSS P. NELSON

THE COMPUTER industry usually ties new-generation hardware to the older hardware by making it compatible with existing software. To take advantage of the machine's newer features, you must write software for its native mode. Such is the case with the IBM PC AT's central processor, the Intel 80286, which runs software written for the 8086/8088 processors.

Due to lack of operating system support, very little software has appeared for the 80286's native mode, called the protected virtual address mode, leaving the processor's power largely untapped in current microcomputer systems. Ironically, appli-

cations programs that adhere to a few simple rules will run unmodified in the native mode, but only if you dramatically modify the operating system. I've written a program, `PM_ATEXE`, that places an IBM PC AT in its protected mode and provides a base for future expansion and experimentation with the protected mode in the 80286. [Editor's note: `PM_ATEXE`, `PM_AT.ASM` (the source code for `PM_ATEXE`), and `PROTECT.INC`, a module for the program, are available on disk, in print, and on BIX. See the insert card following page 176 for details. Listings are also available on BYTEnet. See page 4.]

PROCESSOR OVERVIEW

In the 8086 emulation mode (which is equivalent to the standard operat-

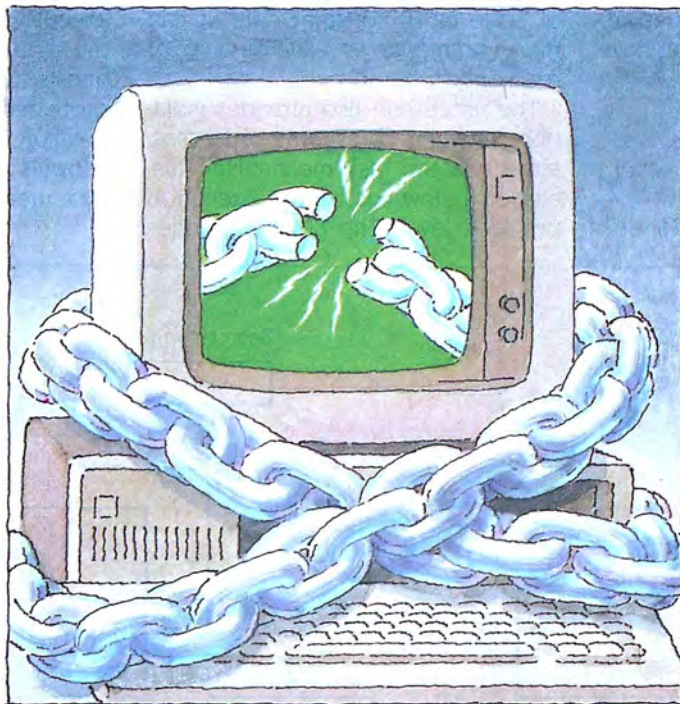

ing modes of the 8088, 8086, 80188, and 80186), the 80286 has one type of system object, the segment. The processor grants access to a segment when a value is loaded into a segment register. The processor then allows direct access to the 64K-byte block of memory beginning at location $\langle \text{value} \rangle \times 16$.

In protected mode, the processor views the system much the same as an operating system would. The processor "knows" about objects other than memory segments. Each object is referenced by a descriptor, which contains information about the object. When the system is in protected mode, the value loaded into the segment register does not point to the object itself, but to a table of descrip-

tors where the object is described. From that table, the physical address and size of the object (assuming it is a memory segment) are extracted. Memory segments can range from 1K to 64K bytes in size, and the processor verifies that every memory access is within the bounds of the segment size (see figure 1).

In addition to segments, the 80286 works with descriptor tables, task segments, and gates. A particular type of descriptor is used to reference each object (see figure 2). The processor uses descriptors to ensure that system security is not violated. To prevent a valuable program from being disas-

sembled, the processor would use an execute-only descriptor for the code segment; any program that tried to read that segment as data would fail.

The 80286 requires two tables of descriptors whenever the system is running in protected mode: the global descriptor table (GDT) and the interrupt descriptor table (IDT). A number of local descriptor tables (LDTs) can also exist. LDTs are associated with the 80286 task implementation. The GDT and LDTs contain descriptors for code and data segments. The IDT is analogous to the 8086 interrupt vector table and contains special code descriptors known as gates.

(continued)

Ross P. Nelson (1821 Ashmeade Ct., San Jose, CA 95125) is a systems programmer.

In 80286 parlance, the 16-bit value loaded into the segment register is called a selector. A selector accesses a system object by selecting the descriptor for the object. A selector has three components: the table indicator (TI), which selects either the GDT or the currently active LDT; the desired descriptor within the table (Index); and a requested privilege level (RPL). Normally, the RPL is the same as the operating privilege of the currently executing code. The 16 bits that are loaded into the segment register have the following format:



TI = 0 / GDT, TI = 1 / LDT

For example, the processor interprets the value 13A1 hexadecimal in a segment register as a request to access descriptor 274 hexadecimal in the GDT with a privilege of 1.

PROTECTION

In protected mode, as the name implies, the 80286 is concerned with system integrity. It makes every effort to ensure that the flow of execution is well behaved. To prevent corruption of code or of constant data, it can mark segments as execute-only or read-only.

The processor also provides isolation between coresident processes, either via the task mechanism (discussed below) or by the execution privilege level. The 80286 provides

four levels of security, numbered from 0 (most secure) to 3 (least secure). A program may access any descriptor with a descriptor privilege level that is numerically equal to or higher (less secure) than its own execution level. Typically, operating system code executes at the most privileged levels, and the applications execute at less privileged levels.

This arrangement presents a problem when an application attempts to execute subroutines that are part of the operating system, such as I/O requests. The code segments should be protected from corruption, but less privileged applications should still be allowed access. The 80286 provides two mechanisms to deal with this

(continued)

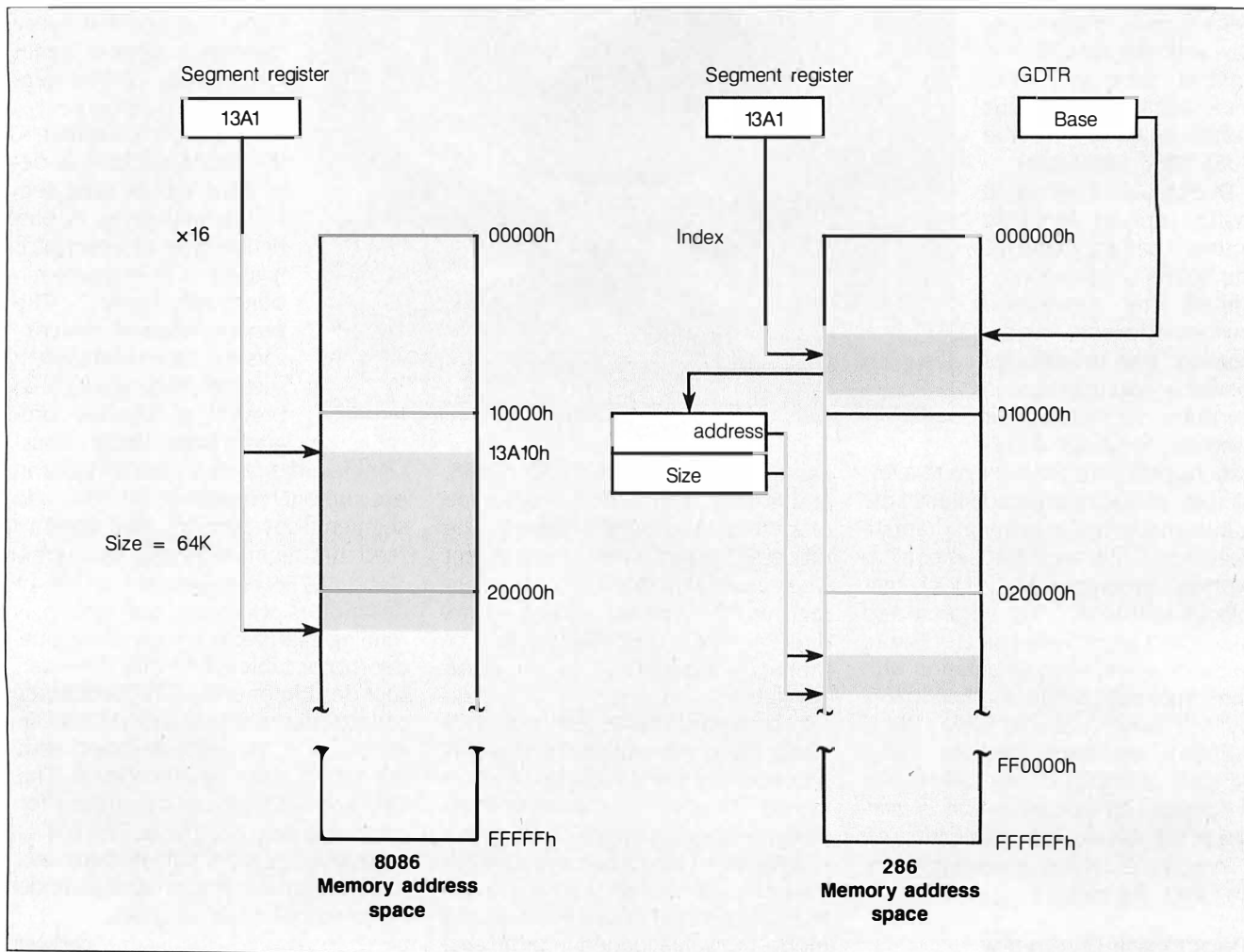

Figure 1: Direct addressing of real-address mode versus the indirect addressing of protected mode.

QUALITY: an American achievement.



AMERICAN 286-A™ PERFECT SYSTEM

AUTHORIZED DISTRIBUTOR AND SERVICE CENTERS:

California Micro, Inc.
Los Angeles, CA (800) 792-6500

Imagine Computers
Goleta, CA (800) 344-2964

PC Land, Inc.
Tustin, CA (714) 730-6723

Computer Professionals
Lakewood, CO (303) 232-4009

Computer Peripheral Warehouse, Inc.
Deerfield Beach, FL (305) 481-2170

PC Distributor
Orlando, FL (800) 624-3250

The Super Source
Norcross, GA (800) 241-8579

Mid America
Carmel, IN (317) 846-3101

CPU Distribution, Inc.
Burnsville, MN (612) 894-9153

Asibem, Inc.
Bluespring, MO (816) 229-2442

Computer Wholesalers
Lincoln, NE (402) 466-1962

Micro Configuration East, Inc.
Brooklyn, NY (718) 941-2512

Microsef
Oklahoma City, OK (405) 787-4354

Power House Sales
Sioux Falls, SO (605) 335-7181

American Computer Distributing
Chattanooga, TN (615) 870-1073

Columbia Data Systems, Inc.
Columbia, TN (615) 381-4650

Inter-Micro Distributor, Inc.
Alberta, Canada (403) 438-3997

Paris Sud Electronique Composant
Paris, France (1) 69.20.66.99

MAJOR DEALERS:

Computerland of Whittier
Whittier, CA (213) 945-8321

Elek-tek, Inc.
Chicago, IL (312) 677-7660

Inacomp Computer Center
Columbus, OH (614) 431-2230

Inacomp Computer Center
Saginaw, MI (517) 790-1360

Executive Business Machines
Hickory, NC (704) 324-9035

Purchasing a compatible is a wise decision. You can find powerful systems at competitive prices without compromising quality.

The American 286-A™ (formerly American AT) is an IBM AT® compatible with a proven record in reliability. The four-layer motherboard ensures low noise and minimal interference. It passes IBM's diagnostics test with flying colors. Supported by only the best, the American 286-A uses major national brand components for data storage units.

The American 286-A offers unprecedented compatibility. Supporting all popular business and education applications and networking systems, the American 286-A emulates IBM operations.

And, the American 286-A won't leave you stranded. We back the American 286-A with a 12 month warranty on parts and labor.

System characteristics:

- 6MHz/8MHz switchable clock speeds.
- Up to 3.5 Mb memory expandable.
- Includes MS-DOS® 3.1 software and system manual.
- Enhanced chassis design.
- 12 month limited warranty on parts and labor.
- Reliable 4-layer motherboard.
- Socket to support the 80287 math co-processor.
- Eight I/O expansion slots.
- AT/XT switchable keyboard.
- 1.2 Mb diskette drive with controller.
- Color or monochrome graphics card.
- Serial/parallel interface card.
- 33 Mb (formatted) fixed disk drive with 40 ms access time.
- 20 Mb tape backup.
- American Mouse with free Compu-Brush graphics program.
- FCC approved; class 15J, part B.

See us at  **COMDEX/Fall '86** November 10-14, 1986

American
COMPUTER & PERIPHERAL, INC.

Corporate Office: 2720 Croddy Way, Santa Ana, CA 92704 USA • Tel: (714) 545-2004 • Fax: (714) 545-2146
Northeastern Office: 830 Busch Court, Columbus, OH 43229 USA • Tel: (614) 846-5433 • Fax: (614) 846-7656

*IBM AT and MS-DOS are trademarks of International Business Machines and Microsoft Corporations, respectively.

*Effective October 1, 1986. Subject to Intologic Trace geographic restrictions and regulations.

Inquiry 14 for End-Users. Inquiry 15 for DEALERS ONLY.

problem. The first is the conforming code segment, used when the shared code does not need to access restricted elements of the system, such

as hardware I/O ports. Libraries of routines that perform data conversion between ASCII and binary or floating-point, for example, could take advan-

tage of conforming segments.

The other mechanism is a descriptor called the gate, which provides a

(continued)

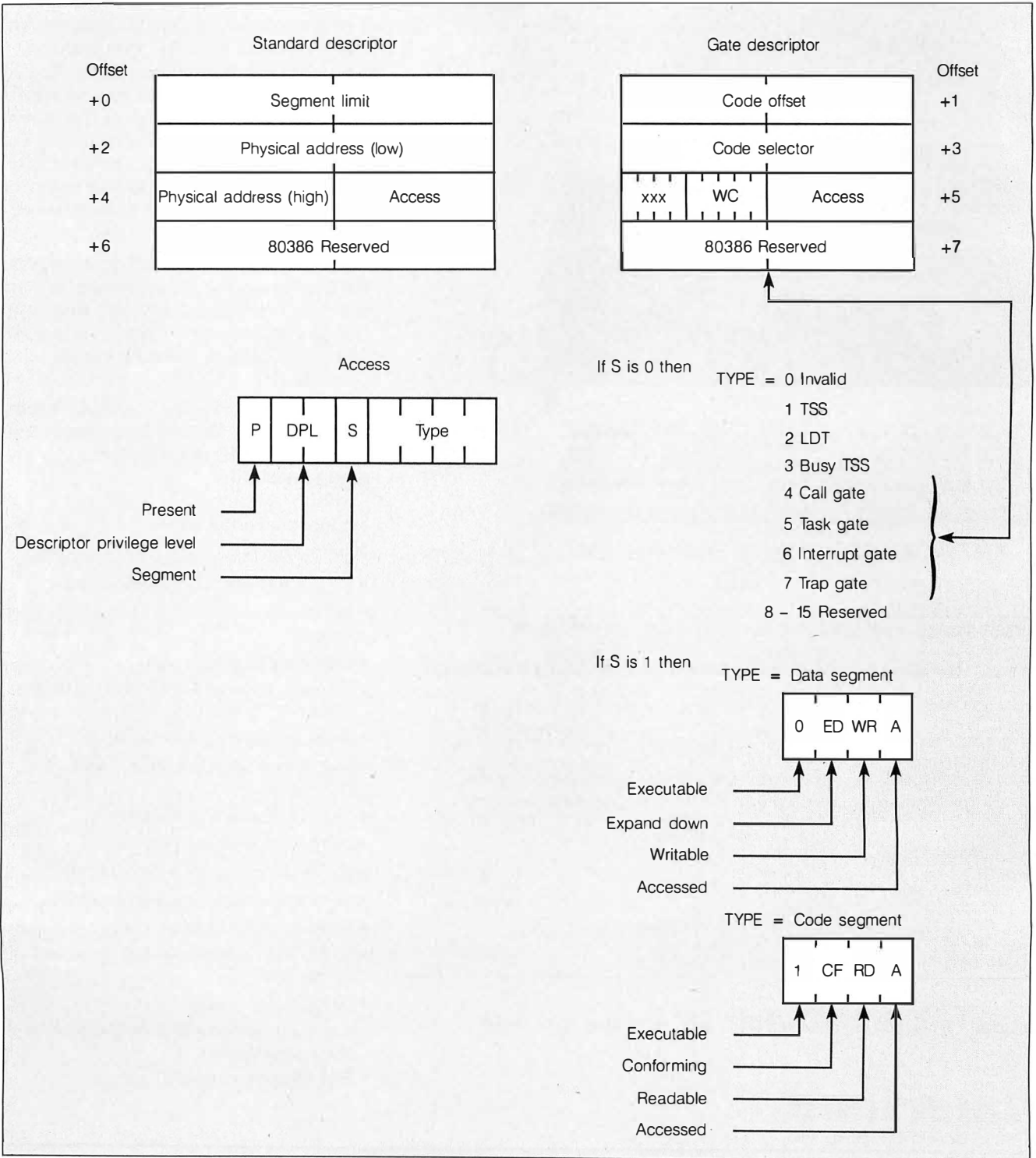

Figure 2: The format of a descriptor.

DD: Two Ctrl and Alt keys for ambidextrous access.
IBM: Same

DD: Positive-tactile, firm-feel keys.
IBM: Same.

DD: Extra-wide, easy-to-find Return key.
IBM: Changed sizes again by shrinking their Return key.

DD: Dedicated Function Control keys.
IBM: Same.

DD: Caps, Num and Scroll Lock indicator lights.
IBM: No lights on their XT.

DD: Isolated Escape key.
IBM: Same.

DD: 12 Function keys for increased automatic operation.
IBM: Same.

DD: Separate dedicated Numeric Pad with enlarged Enter key, four Arithmetic Function keys.
IBM: Same.

DD: Enlarged Backspace and Shift keys
IBM: Same

DD: Switch-selectable compatibility with IBM, PC, XT, AT, PCjr, AT&T and all compatibles.
IBM: Enhanced keyboard runs only on their new XT's, AT's and ignores their installed base which probably includes you.

DD: Separate Cursor and Screen Control keys.
IBM: Same.



Here it is... DATADESK'S TURBO-101 ENHANCED KEYBOARD for the 10 million PC users IBM just ignored!

IBM just announced their new redesigned "standard" keyboard for personal computers. There's only one problem: *it won't work on your IBM computer if it was purchased prior to June 1986 or on any PC compatible purchased at any time!*

Not to worry. Our new Turbo-101 Enhanced Keyboard gives you the layout and enhancements of the IBM with some logical improvements (see above photo). And it works on your existing PC, XT, AT, PCjr, AT&T, Epson and virtually all compatibles!

Get Borland's Turbo Lightning for Free!

To really turbocharge your productivity, we are including, free-of-charge, Borland's red-hot Turbo Lightning software with each keyboard. Now, when using SideKick, WordPerfect, Microsoft Word, 1-2-3 or most popular programs, our Turbo-101 Keyboard will check your spelling as you type, gives you instant access to Random House's 80,000-word Concise Dictionary and 60,000-word Thesaurus and much, much more! "Lightning's good enough to make programmers and users cheer, executives of other software companies weep," says Jim Seymour of PC Week. Sold separately, Turbo Lightning retails for \$99.95!



The Only Alternative
datadesk™
INTERNATIONAL

7650 Haskell Ave., Van Nuys, CA 91406 (818) 780-1673

Turbo-101 is a trademark of DataDesk International. Turbo Lightning is a trademark of Borland International. IBM and IBM AT are registered trade-marks of International Business Machines, Inc.

Inquiry 82

The Turbo-101 is the best data entry tool since the pencil!

For users of spreadsheets like 1-2-3, the Turbo-101's separate cursor controls and numeric keypad makes entering numeric data into cells and moving from cell to cell as natural as moving your fingers. And for word-processing, the 'Selectric' typewriter layout makes the Turbo-101 as easy to use as a pencil; and with the extra large Enter, Shift & Control Keys, you'll make so few mistakes, you won't even need an eraser!

Up to now, DataDesk International may be one of the best kept secrets, but here's what's being said about our first end-user Keyboard/Borland software bundle:

"DataDesk Intl. has designed a sturdy and handsome keyboard that has tactile response...is the hardware bargain of the year" says Charles Humble, Oregonian Jan 86

"This keyboard is neat to type on and feels solid. It has tactile feedback keys...I can type much faster on it." Test Drive Scorecard: DataDesk-10 Key Tronics-9 Teleconnect Magazine May 86

"Who Can Pass Up a Deal? Department. Talk about an aggressive product!" John C. Dvorak, InfoWorld Mar 86

"In addition to incorporating every improvement IBM designed into their advanced AT keyboard, it solves all of the problems exhibited by their regular PC/XT keyboard...it's a great bargain!" PC Productivity Digest May 86

"The best part of the keyboard is the way it feels. It's ideal! And fast. I've never worked on a keyboard with a nicer touch." Business Computer Digest Aug 86

"It's a good keyboard. Good feel: the keys have tactile feedback. No mush at all. This is about as good a keyboard deal as you're likely to find...I have absolutely no hesitation in recommending the model PC8700." Jerry Pournelle, Byte Magazine, Sept 86.

credit card orders

call (800) 826-5398

in CA call (800) 592-9602

SPECIAL OFFER!
ONLY \$149.95* FOR BOTH
KEYBOARD & SOFTWARE
Includes 30-day money back
guarantee and 1 year full warranty.

To prove that we don't ignore you or your pocketbook, you get our Turbo-101 Enhanced Keyboard and Borland's Turbo Lightning for an astounding \$149.95* No, you didn't read it wrong. During this amazing Introductory Offer you get both keyboard and software for less than most software programs by themselves! Now, if you're still feeling ignored, you can always do what you-know-who wants you to do...and buy a new computer to get their keyboard!

*Price does not include adaptor cables required by certain compatibles • A limited offer—price subject to change without notification

**BOTH TURBO-101 ENHANCED™
KEYBOARD AND BORLAND'S TURBO
LIGHTNING™ SOFTWARE FOR ONLY:
\$149.95* LIMITED
OFFER**
Plus \$10 Shipping & Handling.
California Residents
Add \$9.75 Per Unit Sales Tax

NO. UNITS: _____
PAYMENT: VISA MC CHECK
AMOUNT ENCLOSED: \$ _____

Enter ←

NAME: _____ STATE: _____ ZIP: _____
ADDRESS: _____
CITY: _____ COMPUTER TYPE: _____
PHONE: _____ EXP: _____
VISA MC NO.:

passageway to a more privileged execution level. It does this with an additional level of indirection. A gate has a privilege level that is separate from the privilege level of the code segment to which it points (see figure 3). For example, a call gate that has a descriptor privilege level of 3 could point to a code segment with a descriptor privilege level of 0. This means that any executing code segment could issue a call through the gate because 3 is the least privileged level. Since the gate points to a level-0 segment, the 80286 would change the privilege of the currently executing task to level 0 to match the new segment. Thus, the application runs at a higher privilege level, but only while executing the operating system's secure code. It then returns to its original level after the return instruction.

The 80286 architecture also provides interrupt and trap gates for

handling hardware and software interrupts.

The notion of a task is built into the 80286 architecture. Loosely defined, a task is a set of segments required to perform a particular series of operations. The 80286 creates this union of segments with the help of two descriptors, the task-state segment and the LDT.

It is often helpful to think of tasks as separate programs executing on their own individual microprocessors. The task-state segment provides a good simulation of this notion, since each task-state segment holds a copy of all the machine registers used by the task. Because in most cases a single processor handles all the tasks in a system, the operating system switches between the tasks, executing one for a period of time, then another. In this way, a multitasking system appears to be running many programs concurrently. When a task-switch

operation is performed on the 80286, the current values of all the registers are stored in the task-state segment of the executing segment; the registers are then loaded from the task-state segment of a new task, which begins execution based on the new value of the instruction pointer.

The segment descriptors in the task's LDT are available only to that task; another task cannot access them. This isolation provides an excellent form of protection.

THE PROTECTED-MODE PROGRAM

My program, PM__AT, places the IBM PC AT into protected mode and provides support scaffolding for further experimentation with protected mode. The program illustrates various features of the 80286's native mode and includes examples of fault handlers, conforming code segments, gates, and task switching.

I wrote the program using the IBM Macro Assembler version 2.0. Since this product was designed for the 8086 family of processors, it does not support some features of protected mode. In some cases, I have resorted to programming tricks to provide a reasonable approximation of the missing features.

The PROTECT.INC listing contains a set of macros that let the user assemble 80286 protected-mode instructions. The 80286's instruction set contains two kinds of enhancements over the 8086 family: the addition of new instructions such as PUSH <data> and ENTER, and the protected-mode instruction set. The IBM Macro Assembler version 2.0 supports the first group of new instructions but not the second. When you include PROTECT.INC, macros simulate the unsupported op codes such as LGDT and ARPL.

TABLES

Three macros help build the descriptor tables. Each segment in the program is defined with either a memory-segment (MSEG) or a system-segment (SSEG) macro. These two macros

(continued)

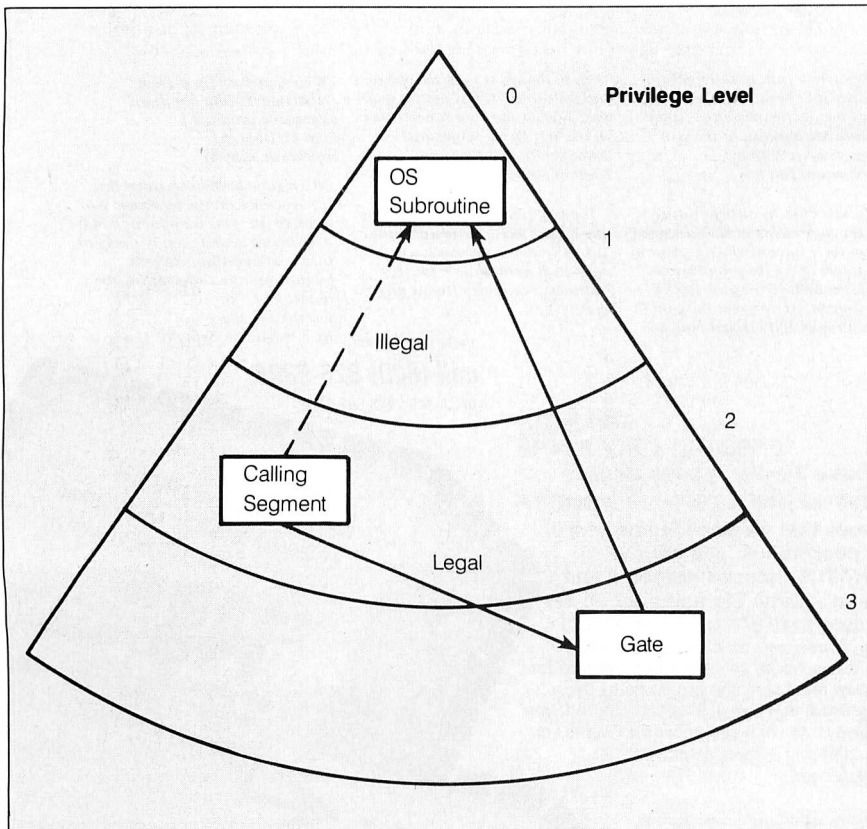

Figure 3: A call gate that has a descriptor privilege level of 3 but points to a code segment with a descriptor privilege level of 0.

- GOOD Product Knowledge
- FREE Technical Support
- Warranty & Return Policy

800
382-3888



**YOU'VE
FOUND US**

NITRO MICROSM

**THE LOGICAL
ALTERNATIVE
To Your Mail Order
NEEDS....**



**ORDER TOLL
FREE
800-382-3888**

Add 2% shipping and handling on all orders.

NO SALES TAX
No surcharge on Visa or MasterCard. All items subject to availability and price change. All hardware and software will be repaired or replaced at our discretion within warranty period of manufacturer.



Hours: Eastern
Mon.-Fri. 10 a.m.-7 p.m.
Saturday 11 a.m.-5 p.m.

QUICK SHIP DELIVERY SERVICE

Inquiry 138

COMPUTERS

AT&T
6300 128K 1 Drive \$1589
6300 256K 2 Drives \$1699
6300 640K 20MB \$2298
6300 PLS 512K 20MB \$3790
All AT&T Systems Include: CPU,
Monochrome Monitor, Keyboard
and MS-Dos

NITRO MICRO

PC II 640K 1 Drive 1.77/AMHz \$ 695
286 640K 1.2MB Drive 8MHz \$1395
Enhanced 286 640K 30MB \$1995

Panasonic

Business Partner 256K 1 Drive \$ 978
Business Partner 256K 2 Drives \$1098
Business Partner 286 512K \$1978
Sr. Partner 256K 1 Drive \$1098
Sr. Partner 256K 2 Drives \$1329
Sr. Partner 256K 10MB \$1998
Executive Partner 1 Drive \$1798
Executive Partner 2 Drives \$1870
Executive Partner 10MB \$2695

QUADRAM

Quadview 640K 1 Drive \$1396

AMIGA

AMIGA Computer System \$1039

SHARP

PC-7000 384K 2 Drive Portable \$1139

TELEVIDEO

Telecat 512K 20MB Harddisk \$1979
Tele286 Model 1 512K 1.2MB Drive \$1949
Tele286 Model 2 512K 1MB Fixed \$2829

TOSHIBA

1100 512K 3.5" Drive \$1548
1100 Plus 640K Dual 3.5" Drives \$1749
3100 640K 3.5" Drive 10MB Fixed \$5369

ZILION

ZFL-171-42 256K 2 Drive Port. \$1688
ZF-148-41 256K 1 Drive \$ 935
ZF-148-42 256K 2 Drives \$1094
ZF-158-41 256K 1 Drive \$1289
ZF-158-42 256K 2 Drives \$1399
ZF-158-43 256K 20MB Harddisk \$1849
ZF-241-81 1T 512K 1.2MB Drive \$2396
ZF-241-82 1T 512K 20MB Fixed \$3079

MODEMS

AST

Reach 1200 Card w/Crosstalk \$ 359

AT&T

4112 1200 Card w/Softcall \$ 329
4000 1200 External \$ 314

EVEREX

300/1200 Internal \$ 139

Hayes

1200B Internal w/Smartcom II \$ 339
2400B Internal w/Smartcom II \$ 539
Smartmodem 300 External \$ 136
Smartmodem 1200 External \$ 355
Smartmodem 2400 External \$ 589

PROMETHEUS

Promodem 1200B Internal \$ 228
Promodem 1200B w/Mite \$ 254

QUADRAM

1200 Internal w/Crosstalk \$ 289
2400 Internal w/Crosstalk \$ 448

VENTEL

1200 Halfcard w/Crosstalk \$ 326
2400 Halfcard w/Crosstalk \$ 428
PC 1200 External \$ 319
PC 2400 External \$ 428

WATSON

Watson 1200 Data/Voice \$ 344

INTERNAL BOARDS

AST

SIXPACK 64K w/Sidekick \$ 167
SIXPACK 384K w/Sidekick \$ 199
SIXPACK PREMIUM 512K \$ 358
Advantage 1.5MB \$ 678
Advantage 3MB \$ 997
5251-11 Package \$ 588
5251-12 Package \$ 525

DCA

IRMA \$ 759

DIGIGRAPHICS

Extend Series 384K \$ 149

EPSON

Monochrome Board \$ 95
Color Video Board \$ 109

EVEREX

Edge \$ 269
Graphics Edge \$ 298
Mini-Magic Card 384K \$ 118

HERCULES

MonoGraphics Card \$ 189
Color Card \$ 149

INTEL

PC Above Board 2MB \$ 638
AT Above Board 2MB \$ 649

MOUNTAIN

RACECARD 286 Halfcard \$ 469

NITRO MICRO

Monographic Card w/Parallel \$ 99
Color Graphics Card w/Parallel \$ 98
Parallel Printer Adapter \$ 39
Parallel/Serial Adapter \$ 59
7-PAK OK Pac/Ser/Clock/Game \$ 99

ORCHID

Tiny Turbo 286 \$ 439

QUADRAM

EGA+ Video Card \$ 384
Quadcolor I \$ 208
Quadboard 384K \$ 229
QuadSprint \$ 436
QuadLink \$ 349

SIGMA

Color 400 Video Card \$ 462

STB

Chauffeur \$ 259

TSENG LABS

EVA EG 1 Adapter \$ 319

UNIVATION

TurboCharger 9.5 MHz 384K Card \$ 379
Dream Board 512K EMS Turbo \$ 539

MONITORS

AMDEK

300G Green \$ 119
300A Amber \$ 128
310A Monochrome Amber \$ 155

EPSON

Monochrome Monitor \$ 109
RGB Color Display \$ 388

NEC

MultiSync HiRes Monitor \$ 538

PGS Princeton Graphic Systems

Max 12E Monochrome \$ 159
HX-12 Color Display \$ 419
HX-12E HiRes Color \$ 525
SR-12 HiRes Color \$ 539

TAXAN

121 Green monochrome \$ 139
122 Amber monochrome \$ 148
630 RGB Color \$ 428
640 RGB Color \$ 488

ZILION

1230 Green composite \$ 99
1220 Amber composite \$ 99

DRIVES

MEGA

Half Height 10MB \$1319
Half Height 10-10 \$1966
Half Height 20MB \$1752
Half Height 20-20 \$2498

IRWIN MAGNETICS

10MB Tape Backup Internal \$ 462
20MB Backup Internal AT \$ 566
10MB Tape Backup External \$ 655

MAYNARD

10MB ONBOARD Hardcard \$ 588
20MB ONBOARD Hardcard \$ 689

MOUNTAIN

20MB Drivecard \$ 769

PLUS DEVELOPMENT

10MB Hardcard \$ 499
20MB Hardcard \$ 639

SEAGATE

10MB Internal w/count \$ 409
20MB Internal w/count \$ 439
30MB Internal AT \$ 668
20MB External w/count \$ 538

PRINTERS

CITIZEN

MSP-10 160 cps \$ 289
MSP-15 160 cps 132 col \$ 389
MSP-20 200 cps \$ 329
MSP-25 200 cps 132 col \$ 488
Premiere 35 Daisysheet 35 cps \$ 469

DATA PRODUCTS

8012 180 cps \$ 288
8022 180 cps wide \$ 454
8052 200 cps color \$1079
8072 200 cps color \$1432

EPSON

LX-86 120 cps \$ 218
FX-85 160 cps \$ 349
FX-286 200 cps 132 col \$ 549
LQ-800 11.0 200 cps \$ 528
LQ-1000 11.0 200 cps 132 col \$ 688
LQ-2500 321 cps \$1089
DX-10 1.0 10 cps \$ 228
DX-20 1.0 20 cps \$ 312
DX-35 1.0 35 cps \$ 559
EX-800 30 cps \$ 529

HEWLETT PACKARD

LaserJet \$2298
LaserJet Plus \$2919
ThinkJet \$ 398
7475A Plotter 6 Pen \$1348

OKIDATA

182 IBM Parallel \$ 219
183 Wide IBM Parallel \$ 369
192 IBM Parallel \$ 349
193 Wide IBM Parallel \$ 489

OTC

700 700 cps \$1419

Panasonic

1091 120 cps \$ 248
1092 180 cps \$ 329
1592 180 cps \$ 439
1595 240 cps \$ 588

QMS

Kiss Laser Printer \$1698
BIG KISS Laser printer \$2389
Post Script 800 Laser Printer \$4688

QUADRAM

Buffer 8K Par-Par \$ 138
Buffer 64K Par-Par \$ 165
Buffer 128K Par-Par \$ 198

TOSHIBA

P321 Parallel \$ 479
P341 Parallel \$ 788
P351 Parallel & Serial \$1032

ORDER TOLL FREE **800-382-3888**

P.O. Box 90200
Indianapolis, IN
46290-0200

NITRO MICROSM

create assembler variables that contain information necessary for building a descriptor. A third macro, the descriptor (DSCRIP) macro, builds a descriptor from the variables when given the name of a segment. The DSCRIP macro also accepts an optional export name that is used as a selector for the descriptor. This trick

works because the format of a level-0 GDT selector is equivalent to the index multiplied by eight. Since each descriptor takes up 8 bytes, the byte offset of the descriptor equals the index times eight.

The GDT begins with the line
 DESCRIP <0, 0, 0, 0>

which builds the first GDT entry via the DESCRIP data structure. The system can never access descriptor 0 in the GDT; therefore, it is null. Descriptors 1 through 7 are set up to meet the requirements of the INT 15h function call. Descriptor 8 provides a task-state segment for the initialization code. The INT 15h protocol does not require the creation of a task, but a task fault will occur at the first task switch if the task register has not been loaded.

The next four descriptors are for the portion of code that I call the MiniBIOS. The MiniBIOS handles the hardware interrupts and provides screen-handling routines similar to those normally found in the standard ROM BIOS; however, the ROM functions will not execute correctly when the processor is in protected mode. When you invoke the MiniBIOS functions (via a trap gate at INT 30h), the privilege of the executing task is set to 0 for the duration of the function.

The next nine descriptors point to the fault handlers I have implemented. As you add new code to the system, it is inevitable that at some point a routine will fail. The handlers that are a part of PM__AT will indicate the type of fault and the location in the program where the fault occurred. The descriptors provide code, data, and task segments for the fault-handling code. The last of these descriptors is initially unused but available for the fault-handling routines to modify as needed.

The next two descriptors provide access to a library of ASCII/binary-conversion routines. The first descriptor, shlib__code, is a level-0 conforming code segment. Programs with a lower privilege can gain access to this code via the CALL__ GATE descriptor, which has a privilege level of 3. Since the code segment is conforming, the privilege of the calling task does not change when executing the code in shlib__code.

The next descriptors provide the system-level descriptors for a second task to illustrate the 80286's task-switching capabilities.

(continued)

Scan'n Cut'n Paste PC

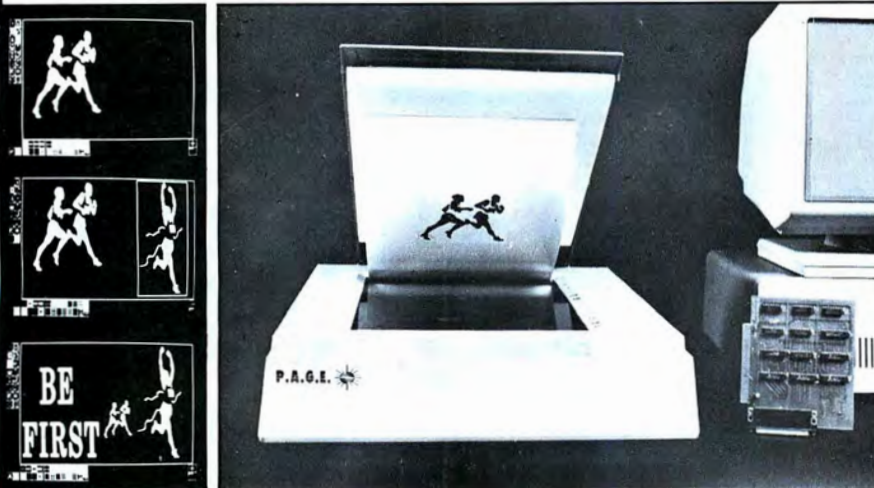

New P.A.G.E. Scanner gives your blind PC the eyes it needs.

Introducing the missing link. The big leap that gives your PC the eyes it needs to capture and enhance existing artwork.

The new P.A.G.E. Scanner takes any photo, flat art, magazine or book and converts them into digitized images. Now you can turn, invert, enlarge, reduce, mirror and even reverse any image, with resolution to 300, 240, 180 or 100 dots per inch, matching laser printer quality.

The possibilities for image manipulation are incredible. There's a zoom feature for fat bit (single pixel) editing, even at a maximum resolution of 90,000 dp sq in.

Hardware Features

- Scans to four resolutions, 100, 180, 240 or 300 dpi.
- Line or halftone.
- Flat bed—easy manipulation of originals.
- Scans books and other dimensional objects.
- 1/2-card interface for IBM PC™, XT™, AT™ and compatibles.
- Compatible with most graphics cards.
- Compatible with most pointing devices.
- Compact and lightweight—15" W x 19" D x 5" H.

- Compatible with most popular dot matrix and laser printers.
- Data file compression saves valuable disk space.
- Runs in virtual page to maximize memory.
- Requires 256K minimum; 640K for high resolution.

Software Features

- Icon driven.
- 20 fonts with text manipulation.
- Grids, filled and unfilled circles, ellipses and boxes, pencil and airbrush, scissors, draw, paint, cut and paste and rubberstamp.
- And even an undo function to instantly correct slip ups.

P.A.G.E. SCANNER

complete with interface, software, cables and user guide.

Just **\$2,995⁰⁰**

Financing available to qualified buyers. Terms: Major credit cards, checks or money orders. Add sales tax in N.J. Order yours now and give your blind PC the eyes it needs. Call (201) 647-3678 ext. 40. Or send your order to:

P.A.G.E. 
 Printing And Graphic Enhancement
 150 Mt. Bethel Road, Dept. B2
 Warren, NJ 07060

IBM, PC, XT and AT are trademarks of International Business Machines Corporation. Dealer and OEM inquiries invited.

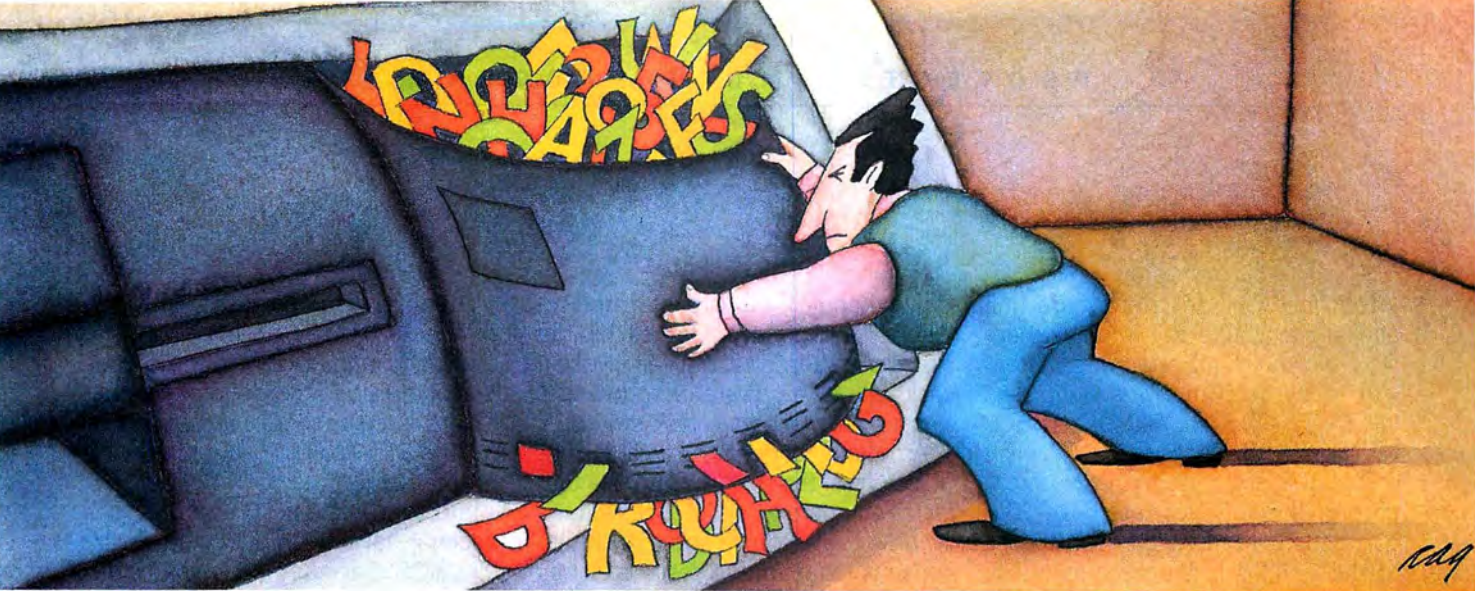

PROBLEM: Handling your need for more megabytes, without spending megabucks on a new drive.

THE SOFTLOGIC SOLUTION: Cubit™

Now get up to twice the capacity from all your storage media.

You know what happens. The more you use your computer, the more information you create. And the faster you fill up your disk.

The 10MB drive that once seemed enormous is now jammed with important files. That 20MB that should have lasted years is crowded in a matter of months.

Of course you could keep buying bigger hard drives. Or you could get Cubit and get the maximum storage space from the drives you already have.

What is Cubit?

In brief, Cubit is an advanced software tool that automatically reduces the number of bytes required to store a file, then converts the file back to its original size when retrieved. Some programmers call this effect "data compression," others, "disk expansion." Either way, the result is the same.

Here's how it works. When Cubit compresses a file, it first compares each word to its massive English word dictionary. Words that match are reduced to a predetermined code of just one, two or three bytes each. It then saves the abbreviated version to disk. Decompression works just the opposite.

To accommodate other words and symbols, Cubit uses two more compression techniques. One assigns new, shorter codes to unusual words. Another compresses according to the frequency of character strings in non-text data. So no matter what kind of files you create, Cubit ensures maximum space savings.

Best of all, you'll be using the same fast, reliable data compression techniques used on mainframe computers for decades.

How much disk space will you save?

Because the vast majority of data created on PC's is standard ASCII text—letters, numbers and other English language symbols—we've optimized Cubit for word processing and database files. With these, you'll get a minimum of 50% expansion on up to a full 100% or more.

At the same time, you can expect a significant 30% to 50% improvement with other kinds of data. Including

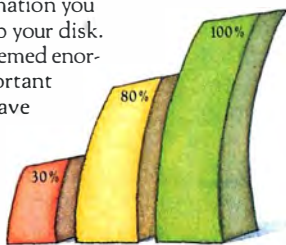

With Cubit, you'll get as much as 100% compression on data files, effectively doubling the storage capacity of all your magnetic media.

graph and image files, even binary data.

And Cubit works just as well with floppies and tape cassettes as it does with hard disk drives.

Run Cubit where you want, when you want.

Maybe you'll want to use Cubit for all your files, or maybe just some. So Cubit lets you specify exactly which files to work on and which ones to leave alone.

In RAM resident mode, Cubit works quickly and invisibly, compressing and decompressing right from within any program you run. Or use Cubit's powerful file management mode. It supports wild-card and global file names, and addresses sub-directories up to thirty levels deep.

Save time and money, as well as disk space.

A compressed file is a smaller file. So with Cubit, back-ups

take less time, as well as less space. And communicating compressed files means significant savings on phone line charges.

Any way you look at it, Cubit will pay for itself in no time. And that's especially true now.

Special limited time offer.

Buy Cubit now and you'll save even more. Because for a limited time, you can buy Cubit at the special introductory price of just \$49.95*. But hurry. This special price won't last long.

Ask for Cubit at your computer dealer. Or order directly from SoftLogic Solutions by calling 800-272-9900 (603-627-9900 in NH), or mail in the coupon below.

Special pricing is available when you buy Cubit along with other SoftLogic products including DoubleDOS, Software Carousel and Disk Optimizer. Ask for details.



Cubit™ \$49.95*

YES! Please send me _____ copies of Cubit at this special introductory price.

Name _____

Company _____

Address _____

City _____ State/Zip _____

Check Enclosed VISA MC AMEX

Card # _____ Exp. Date _____

Signature _____

SoftLogic Solutions, Inc.
530 Chestnut Street
Manchester, NH 03101
800-272-9900
(603-627-9900 in NH)

**SOFTLOGIC
SOLUTIONS**

Call today: 800-272-9900

*plus \$5.00 shipping and handling.

The final four descriptors are null and are available for future expansion. Normally, an operating system will provide functions such as `CREATE_TASK`, `ALLOC_SEGMENT`, and `FREE_SEGMENT`, which create new descriptors or free up entries in the GDT for later use. The operating system would have access to the GDT as if it were a standard data segment (via descriptor 1). Obviously, this sort of access to the GDT must be limited to only the most secure portions of the operating system.

The GDT requires the physical starting address of the segment as a part of segment descriptors. The assembler places the 16-bit (real address mode) segment address in the prototype GDT. A subroutine in the program's initialization portion adjusts all the addresses, multiplying them by 16. It assumes all data resides in the first 1 megabyte of memory.

The IDT contains a set of gates that point to the routines that handle interrupts and faults. It contains only trap, interrupt, or task gates. Trap

gates handle software-interrupt requests, and interrupt gates handle hardware interrupts. You can invoke a task gate by hardware or software; it causes an immediate task switch.

As defined under DOS, the interrupt structure of the PC AT resembles that of the standard PC or XT. Unfortunately, IBM chose to use some of the interrupts that Intel designated as reserved. In the AT, this causes a conflict between the way DOS wants to use the interrupts and the way the processor wants to use them. In my program, I followed the Intel specification and allocated the first 32 interrupts for exceptions and fault handling, mapping the hardware interrupts to vectors 32 (20 hexadecimal) and above (see table 1).

Descriptors 0 through 31 handle processor faults. All these gates are interrupt gates except for 8, 10, and 12, which are task gates. Task gates are required because the failures that cause these interrupts are so serious that the processor must load an entirely new machine state to continue running.

The hardware interrupts are found at vectors 20 to 2F hexadecimal. The change from the DOS vector locations is accomplished by programming the 8259A interrupt controller. In the PC AT, the BIOS call `INT 15h` takes care of this detail.

Interrupt vectors 30 and 31 hexadecimal have been allocated to the MiniBIOS. Since `INT 30h` provides display services, its privilege level is set to 3 so that any task may request its services.

The last page of the program contains an LDT for the second task. The code and data segments for the second task are in the LDT rather than the GDT. When an LDT is used for each task, the GDT will contain only a task-state segment and an LDT descriptor for the task. The descriptors for the code and data segments need not appear in the GDT.

INITIALIZATION

After MS-DOS loads `PM_AT`, execution begins at the label `START`. The program then calls the subroutine `ADJUST_ADDR` to fix up the physical addresses in the GDT and LDT, converting them from 16-bit real address mode segments to 24-bit physical addresses. It then calls the ROM BIOS to request protected mode.

The PC AT BIOS provides a function (code 89 hexadecimal of `INT 15h`) that places the processor into protected mode. To do this, it loads the GDT and IDT base registers, programs the 8259A interrupt controller with the hardware vector locations, and frees up the A20 address bit. (Due to a design oversight at Intel, the 80286 occasionally generates addresses beyond 1 megabyte. The PC AT includes hardware to force the A20 bit to 0 while running in emulation mode.) It then sets the protected-mode bit in the machine status word (MSW) register of the processor and returns to the calling program.

PROTECTED-MODE EXECUTION

The only setup required after the program returns from the `INT 15h` call is

(continued)

Table 1: *The interrupt vector mapping used in PM_AT contrasted with DOS.*

Vector	Function	DOS Equivalent
00	Divide fault	0
01	Trap (single step)	1
02	NMI	2
03	BRKPT (INT 3)	3
04	Interrupt on overflow	4
05	Bound interrupt	
07	80287 not available	
08	Double fault	
09	80287 segment overrun	
10	Invalid TSS fault	
11	Not present fault	
12	Stack fault	
13	General protection fault	
16	80287 error	
17 . . . 31	Reserved	
32	Timer	08
33	Keyboard interrupt	09
35	Com port 1	11
36	Com port 2	12
37	Printer 2	13
38	Floppy disk	14
39	Printer 1	15
40	Real-time clock	
45	80287 request	
46	Hard disk	

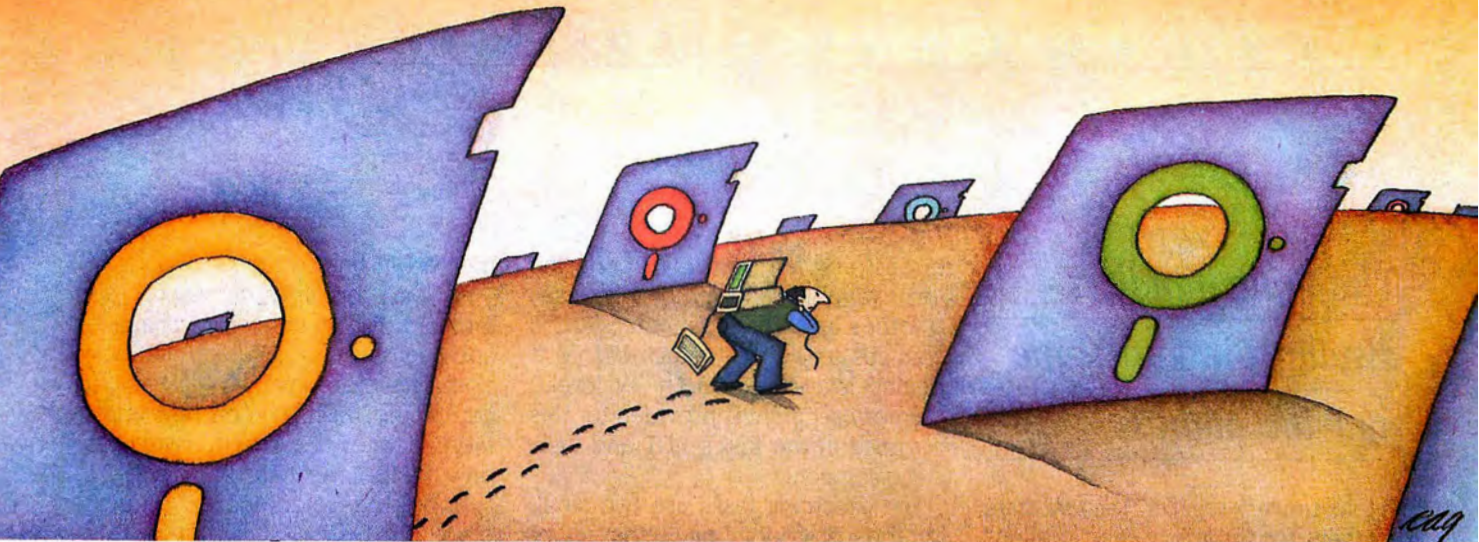

PROBLEM: There's just no easy way to move from one software program to another.

THE SOFTLOGIC SOLUTION: Software Carousel

Now you can keep up to 10 programs loaded and ready to run.

Hard to believe, but some people are happy with just one kind of PC software. Well, this is not a product for them.

But if you're someone who depends on many packages, all the time—someone who'd use several programs at once if you could, well now you can. With Software Carousel.

Why call it "Software Carousel"?

In some ways, Software Carousel works like the slide projector you're used to. You load a handful of pictures, view one at a time, then quickly switch to another. A simple idea, with powerful possibilities for computing.

Here's how it works. When you start Software Carousel, just tell it how much memory you have, load your software and go to work.

Need to crunch numbers? Switch to your spreadsheet. Need your word processor? Don't bother saving your spreadsheet file. Just whip over to your document and do your work. Snap back to your spreadsheet, and it's just like you left it.

With up to ten different programs at your fingertips, you'll have instant access to your database, communications, spelling checker, spreadsheet, word processor, RAM resident utilities, languages, anything you like.

Reach deep into expanded memory.

This could be the best reason ever for owning an expanded memory card, like the Intel Above Board, AST RAMpage, or any

card compatible with the L/I/M Extended Memory Standard.

Software Carousel puts programs into this "high-end" memory for temporary storage when they're not in use. And switches them back out when you want them. It's fast, efficient, and easy.

If you want, Software Carousel will even use your hard drive for swapping. Just allocate a portion for storage, and go to work.

Sidekick, Superkey and Ready. All at the same time.

You know what happens if you try loading two or more RAM resident utilities at once. You get crashed keyboards, frozen screens, all kinds of interference between programs fighting for control.

With Software Carousel, you can have as many accessories and utilities on-tap as you want. Just load different ones in different Carousel partitions. Since they can't see each other, they can't fight.

The easy way to maximize PC power.

With all this power, you might think Software Carousel is complicated and difficult to use. Not so. Set it up once, and it will remember forever. Better still,

Carousel will look for the programs you use most often, and optimize them for the quickest access.

You can spend a lot more money, and still not get the convenience and productivity increase of Software Carousel.

The way we see it, there are certain things you have the right to expect from your computer. Access to your software is one of them. And at our special introductory price of just \$49.95*, Software Carousel is the best way to get it.

But hurry. This price won't last long.

Order today at 800-272-9900 (603-627-9900 in NH) or send the coupon below.

Special combination pricing is available for the purchase of Software Carousel and other SoftLogic products, including Cubit, DoubleDOS and Disk Optimizer.

	4X	8X	12X	16X
Word Star	Green	Green	White	White
	Yellow	Yellow	Yellow	Yellow
	Red	Red	Red	Red

With Software Carousel running in RAM, you can load a program and retrieve a file up to 15 times faster. Test conducted on an IBM XT.

Software Carousel \$49.95*

YES! Send me _____ copies of Software Carousel at the special introductory price of just \$49.95*.

Name _____

Company _____

Address _____

City _____ State/Zip _____

Check Enclosed VISA MC AMEX

Card # _____ Exp. Date _____

Signature _____

SoftLogic Solutions, Inc.
530 Chestnut Street
Manchester, NH 03101
800-272-9900
(603-627-9900 in NH)

SOFTLOGIC
SOLUTIONS

Call today: 800-272-9900

*plus \$5.00 shipping and handling.

The fault handlers display the fault type and the address.

to load the task register. The task-state segment for the initial task contains no data but must be present for a task switch to occur.

Program execution is very simple. The program beeps once to let you know all is well, clears the interrupt-register masks, enables interrupts, and goes into a loop. The main task prints the number of clock ticks that have occurred since interrupts were enabled. It then invokes a second task, which merely displays a message and returns. The program loops until you generate a keyboard interrupt; it will then halt and reset the system.

The second task runs at privilege level 3, the way most applications would in a standard operating system. Its execution privilege level is determined by the privilege of its code-segment descriptor found in the task's LDT. When it invokes the display services via INT 30h, however, its execution privilege is changed to level 0 for the duration of the call. To prevent an

errant program from corrupting the local variables and return addresses of the level-0 code, the 80286 changes to a level-0 stack before it begins level-0 execution. A level-0 memory segment is provided for this purpose in the task's LDT and task-state segment.

The executing tasks use two small libraries of code. One is the set of routines that does ASCII/binary conversion. They are located in a conforming code segment, and any task can call them via the CALL_EX macro. This macro takes an export name and a privilege level and creates a FAR call to the object. It can be used with any export segment or gate. The other set of routines provides display services and is part of the Mini-BIOS. Since these routines require access to hardware, they will execute at privilege level 0 and are invoked via the gate at interrupt 30h.

The ASCII/binary-conversion library is located in the shlib_code segment. This library provides the following 16-bit conversion functions: ASCII hexadecimal to binary, binary to ASCII hexadecimal, ASCII signed integer to binary, binary to ASCII signed integer, ASCII unsigned integer to binary, and binary to ASCII unsigned integer. The actual calling sequences are docu-

mented in the code.

PM_AT provides a set of rudimentary display utilities for character and line output and cursor manipulation. These are invoked via the trap gate at INT 30h. The current implementation of the program supports only the IBM monochrome display. To support the color adapter, you replace the DEV_MONO literal with DEV_COLOR. To prevent snow on the display, a color implementation should also loop and wait for a retrace before writing any characters to the display.

FAULT HANDLERS

If you use this program as a basis for your own experiments with protected mode, the fault handlers are important. Whenever the 80286 detects a violation of its protection rules, it issues an interrupt that will vector through the IDT to the appropriate fault-handling routine. My fault handlers display the fault type and the address of the instruction that caused the fault. They will also display the fault code for the "general protection" fault and other faults that provide an error code. The format of the address is <selector>: <offset>. You will have to extract the selector's index

(continued)

WINMODEM	M-II MOUSE	WINNER 909	MOUSE BOX	MOUSE STICK
 <p>*** 2 YEAR WARRANTY</p> <p>1200/300/110 103/212A</p>	 <p>NEW</p>		 <p>GAMEPORT SERIAL PORT</p> <p>TO JOYSTICK</p> <p>NEW</p>	
<p>*1200HC FULLY HAYES COMPATIBLE AUTO/DIAL ANSWER MANUAL CONTROL SEPARATE PHONE JACK \$189</p> <p>*SECURITY 1200HC SECURITY MODEM (ALL 1200HC FEATURE ANSWER SECURITY (DIAL BACK) OUTDIAL SECURITY SPEED DIAL TABLE BATTERY BACK UP MEMORY HELP MENU ON-LINE \$249</p>	<p>M-II MOUSE FEATURE SELECTABLE FUNCTION FOR BOTH MICROSOFT & PC; MOUSE SYSTEM COMPATIBLE. ALSO BOTH 2 SYSTEM DRIVER SOFTWARE INCLUDE \$79</p>	<p>WINNER 909 JOYSTICK EASY ADJUSTABLE CENTER RETURN OR FREE FLOATING 3 FIRE BUTTON STEEL PIVOT W TRIM ADJUSTMENT 360 DEGREE CURSOR MOVEMENT IBM PC, PCjr, APPLE IIe, IIc, II+, IIx, AVAILABLE \$29</p>	<p>MOUSE BOX FEATURE CONVERT YOUR JOYSTICK AS A CONTROLLER FOR ALL MICROSOFT MOUSE SYSTEM SOFTWARE & MOST MOUSE SYSTEM SOFTWARE (IF USE W MOUSESTICK WILL RUN ALL) WHILE STILL KEEP THE JOYSTICK FUNCTION \$45</p>	<p>MOUSESTICK A SET OF MOUSE BOX & SPECIAL JOYSTICK THAT CAN BE USED WITH IBM PC & COMPATIBLES FOR ALL GAMES JOYSTICK MICROSOFT, MOUSE SYSTEM SOFTWARE 3 BUTTON WILL ACT EXACTLY AS PC MOUSE 3 BUTTON \$71.5</p>
 <p>CONTRIVER Technology Inc.</p>		<p>CANADA OFFICE: 1025 CLARK DRIVE VANCOUVER B.C. CANADA V5L 3J9 TEL: 604-2519925 TLX: 04-51112 CONTRIVER FAX: 604-2511510</p>	<p>USA OFFICE: 3241 MACKENZIE PLACE FREMONT CA 94536 U.S.A.</p>	<p>WARRANTY: 2 YEAR FOR MODEM, 1 YEAR FOR JOYSTICK, MOUSE, BOX. SHIPPING: ADD 2% FOR FREIGHT.</p>
<p>***SEE US COMDEX FALL #1441 IN MGM</p>		<p>DEALERS & MANUFACTURE REP. INQUIRY WELCOMED IN U.S CALL: 1-800-6635159 IBM, APPLE, HAYES, MICROSOFT, PC MOUSE ARE REGISTERED TRADEMARKS.</p>		

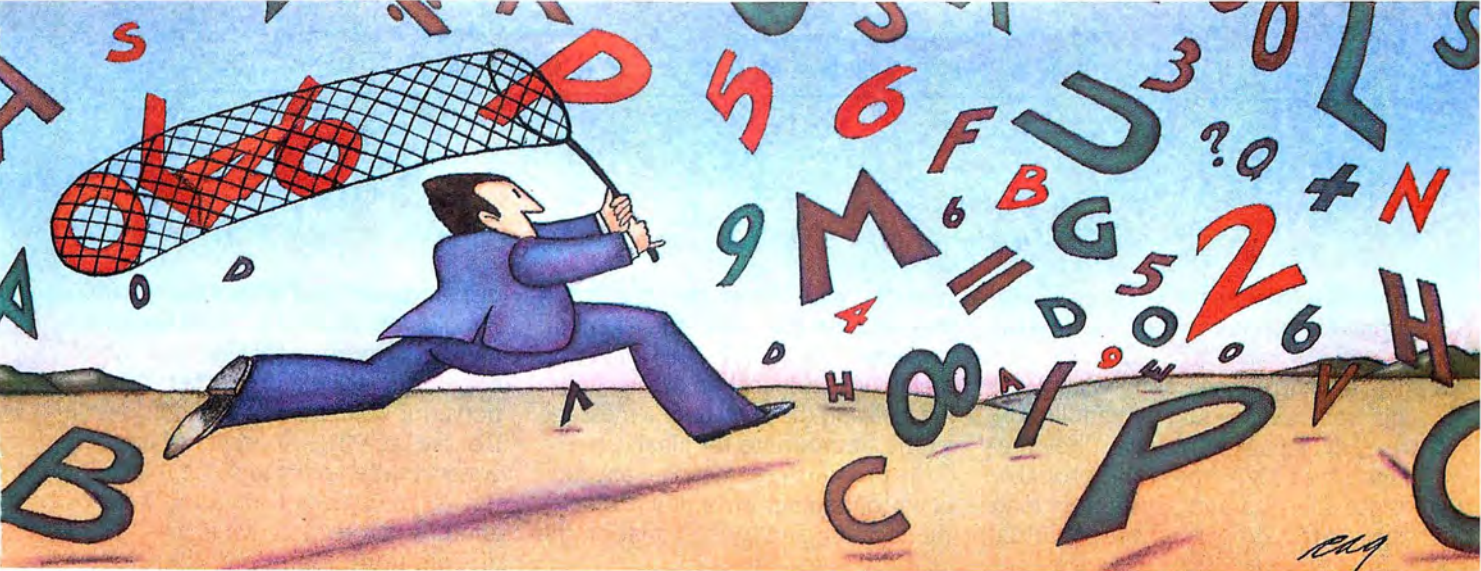

PROBLEM: The more experience your hard disk has, the harder it has to work.

THE SOFTLOGIC SOLUTION: Disk Optimizer™

Your hard disk will run faster when it's not chasing around after files.

Remember the old days when your hard drive was new? Remember that smooth, fast slick performance? Those quick retrievals, rapid saves, lightning-like database sorts?

Well ever since, DOS has been doing its best to slow your hard drive down. Not by slowing down the motor, but by breaking your files up into pieces. Storing different chunks in different places. Data files, programs, overlays and batches that started out in one seamless piece are now scattered all over.

Loading is slower.
Sorting is slower.
Retrieving, backing-up.
Everything takes longer because your disk has to work harder.

Problem is, it's something that happens so gradually you may not notice the difference. At least, not until you see the dramatic improvement after using Disk Optimizer.

File fragmentation—It's a problem you can see.

Watch your hard drive the next time it reads or writes a file. Each "blip" of the LED means the drive-head is moving to another place on the disk—either to pick up or lay down another chunk of data.

And the truth is, head movement takes time. Far more time than actual reading and writing. What's worse, all this head movement causes extra wear and tear that can shorten the life of your drive.

Disk Optimizer—Tunes up your disk by cleaning up your files.

Disk Optimizer works by finding all the scattered pieces of your files and putting them

back together where they belong. Next time your drive reads it, there's just one place to look.

And the results are often dramatic. Reading and writing times may be cut by as much as two thirds. Database sorts that used to take hundreds of head moves now proceed quickly and efficiently. And since head movement is now at an absolute minimum, your disk drive will lead a longer, more productive life.

Analyze, scrutinize, optimize.

Before you optimize, you'll probably want to analyze. So Disk Optimizer shows you, in percentages, how much fragmentation has taken place—on the entire disk, in individual directories, or for groups of files you specify using global or wildcard names.

Plus, there's built-in data security that lets you assign passwords to as many files or file groups as you want.

And the File Peeker gives you an inside look at the structure of files. It's a great way for non-programmers to learn more about computers, and a powerful tool for professionals who want to analyze the contents of their disks.

Get your hard drive back in shape—at a special low price.

When you think about it, it's simple. The longer you

own your hard drive, the more you come to depend on it. But the longer you wait to get Disk Optimizer, the less performance you'll have.

And the less chance you'll have to buy Disk Optimizer at the special introductory price of just \$49.95*.

That's a small price to pay to get back the speed you depend on. But it's a price that won't last long.

Ask for Disk Optimizer at your computer dealer.

Or order today by calling SoftLogic Solutions at 800-272-9900 (603-627-9900 in NH), or send the coupon below.

Special combination pricing is available when you buy Disk Optimizer along with other SoftLogic products like DoubleDOS, Software Carousel and Cubit.

Ask for details.

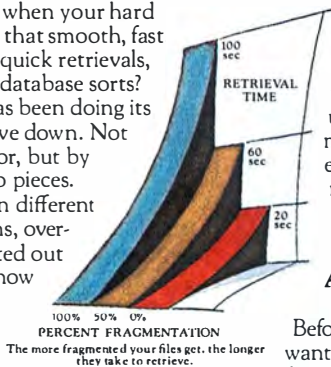

Disk Optimizer \$49.95*

YES! Please send me _____ copies of Disk Optimizer at this special introd _____ e.

Name _____

Company _____

Address _____

City _____ State/Zip _____

Check Enclosed VISA MC AMEX

Card # _____ Exp. Date _____

Signature _____

SoftLogic Solutions, Inc.
530 Chestnut Street
Manchester, NH 03101
800-272-9900
(603-627-9900 in NH)

SOFTLOGIC SOLUTIONS

Call today: 800-272-9900

*plus \$5.00 shipping and handling.

portion to determine which code segment was executing when the fault occurred.

In a complete operating system, the different faults would be handled differently. For example, the "not present" fault (INT 11h) would probably cause the operating system to load the referenced segment from virtual

memory and restart the instruction that caused the fault; the "general protection" fault (INT 13h) would normally cause termination of the offending task and the logging of a message to the appropriate terminal.

My program assumes that any fault is a programmer error. It will display the location and type of fault on the

display, pause, and reboot the system. Should you attempt to make the fault handlers more sophisticated, you might run across two other conditions: double fault and shutdown. Double fault (INT 8) occurs when the system is attempting to process a fault but is prevented from doing so by another protection violation. The double-fault handler, therefore, should be an isolated task that makes as few assumptions as possible. Should the processor detect another violation while attempting to handle the double-fault condition, it will give up entirely and shut down. The PC AT includes hardware that detects the shutdown status on the bus and resets the processor.

SUGGESTIONS FOR EXPANSION

To understand all the complex interactions of the protected mode, you will almost certainly need Intel's *iAPX 286 Programmer's Reference Manual*. This manual includes a pseudocode description of the processor microcode for instructions such as INT or CALL FAR. Unfortunately, in the latest edition (1985), some of the steps are missing. However, after you've worked with the processor for a while, you should get a feel for the types of operations being carried out.

The next logical step in developing the code is adding a keyboard driver. After you get this working, you will have a small interactive system to build on and could add a debugger/monitor. This would let you recover more gracefully from certain errors rather than reset the system.

The complexity of the native-mode 80286 is an order of magnitude greater than that of the previous generation of microprocessors. But as powerful support for secure multitasking operating systems, it will be much appreciated by designers of the next generation of operating systems. ■

BIBLIOGRAPHY

- iAPX 286 Operating Systems Writer's Guide*. Intel Corporation, 1983.
- iAPX 286 Programmer's Reference Manual*. Intel Corporation, 1985.
- IBM PC AT Technical Reference*. IBM Corporation, 1984.

Expand Your Horizons

Messenger 1200
Aicon

\$149

with the Messenger 1200™ modem

- Gain access to information sources and electronic services
 - Bulletinboards
 - Instant news and stock information
 - Electronic Mail
 - Banking and Brokerage Services
 - Travel Reservations
- Micro to micro communications
- Micro computer networking
- Upgradeable to 2400 Baud
- 100% Hayes compatible
- Bell 105/212A compatible
- 300/1200 Baud operation
- Hayes "AT" command set
- Auto dial (pulse or tone)/auto answer
- Voice and data communications
- Switched or leased line operation
- Asynchronous and synchronous capability
- Communications software included
- Full 1 year warranty
- 30 day money back guarantee

(818) 709-6581

Aicon
SYSTEMS

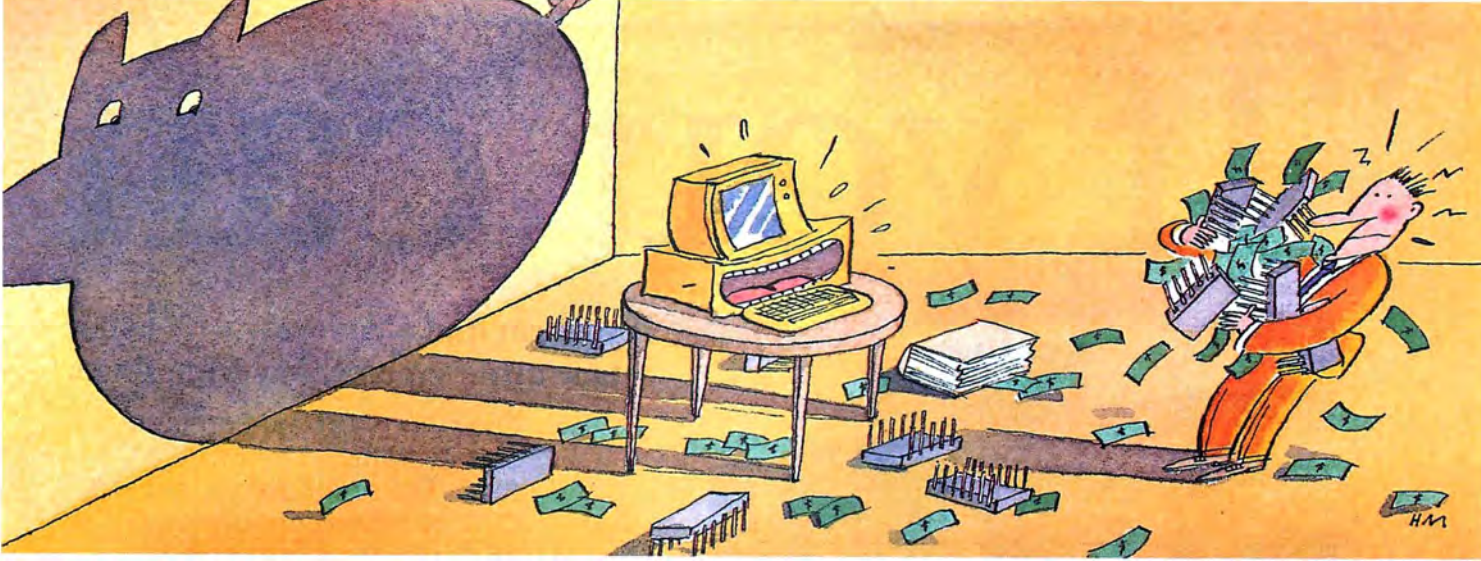

PROBLEM: Most concurrent processing systems take everything you've got, and give back very little.

THE SOFTLOGIC SOLUTION: DoubleDOS™

True multitasking that's quick, painless and powerful.

A lot of people had the same simple idea – make a PC environment where your computer does one thing in the background while you work on something else in the foreground. Problem is, the way some people designed their systems, they're just not simple at all.

Look at products like TopView™ or Windows™. Not only do they cost a fortune, they take gobs of RAM and half a lifetime to learn. Worse yet, they don't even run much software. And what they do run is slow.

So why not get DoubleDOS instead? It's the easy, economical, memory-efficient system that runs all your PC programs, and runs them two at a time.

With DoubleDOS, you can sort a database at the same time you write a memo. Print a spreadsheet while you update accounting. In fact, do almost any two things you want with the software you already have. Best of all, DoubleDOS is fast and simple to use. So you'll be running it in a matter of minutes.

Here's all you need to know to run DoubleDOS.

Unless you know all about .PIF files, interrupt vector swaps and the like, you won't exactly breeze through the set-up procedures for TopView and Windows. Not like DoubleDOS. Just tell it how to divide your memory, and that's it. You're ready to load and run your software right from that familiar DOS prompt.

Say you've started a sort routine in dBASE. Instead of waiting for it to finish, just press "Alt-Esc." Your dBASE screen instantly disappears, and up comes another DOS prompt. Simply load another program and go to work. Meanwhile, dBASE crunches away off-screen.

Press "Alt-Esc" again and dBASE pops back on while your other program continues in the background. Switch back and forth all you want.

Your programs load and run exactly as they would ordinarily. No lost features. No cramped,

clumsy windows. No complex menus and new commands. Just "Alt-Esc."

Multitasking in the fast lane with DoubleDOS.

Aside from what it does, the best part of DoubleDOS is what it doesn't do. And that's slow your computer to a crawl.

In contrast to systems like TopView that permanently divide CPU time between the foreground and background, DoubleDOS constantly evaluates the processing requirements of each program it's running. With DoubleDOS, the program that needs more power, gets it. So all your work gets done faster.



\$49.95 DoubleDOS \$99.00 Windows \$175.00 TopView

DoubleDOS costs less and consumes less RAM than other well-known systems.

Can over 50,000 DoubleDOS owners be wrong?

If you're too busy trying to get work done to suffer through the debugs, updates and fuzzy standards of other concurrent software systems, try DoubleDOS. It comes to you thoroughly field-tested and work-proven by thousands of satisfied users.

So why pay more? Especially when you can have the full power of proven multitasking software for just \$49.95* Look for DoubleDOS at better computer dealers everywhere, or order direct by calling SoftLogic Solutions today at 800-272-9900 (603-627-9900 in New Hampshire). Or send the coupon below.

You'll save even more when you buy DoubleDOS along with other SoftLogic products, including Disk Optimizer, Software Carousel and Cubit. Ask for details.

DoubleDOS \$49.95*

YES! Please send me _____ copies of DoubleDOS at just \$49.95* each.

Name _____

Company _____

Address _____

City _____ State/Zip _____

Check Enclosed VISA MC AMEX

Card # _____ Exp. Date _____

Signature _____

SoftLogic Solutions, Inc.
530 Chestnut Street
Manchester, NH 03101
800-272-9900
(603-627-9900 in NH)

**SOFTLOGIC
SOLUTIONS**

Call today: 800-272-9900

*Plus \$5.00 shipping and handling.
TM signifies manufacturer's trademark.

“If you can



EVEREX Streaming Tape Family

If you can find a company with better tape achievements, buy from them:

- Over 30,000 streaming tape sub-systems, ½ height, 5¼” form factor industry standard QIC 24 recording format, QIC-36 hardware interface and largest installed customer base worldwide.
- Over 100,000 industry standard streaming tape controllers in the field.
- The first company to release QIC-02 IBM-compatible software drivers to the OEM community.
- The first company to release an internal 5¼” half-height IBM compatible tape subsystem.
- The first company to release file-by-file retrieval from a mirror-image backup.

If you can find better streaming tape software, buy it:

User Interface

- Menu driven.
- Multiple windows (nestable and movable).
- Context sensitive on-line help.
- File selection from directory listing or command line.
- Constant tape status display.
- Menu driven hardware configuration guide.

Tape Functions

- Multiple tapes allowing unlimited backup capacity.
- Multiple datasets for multiple backups on the same tape.
- Tape sequence management recorded on the tape.
- Programmable messages.
- File-by-file and image backup on the same tape.
- Installation program.

Functionality

- Physical image backup/restore of local disks.
- Logical image backup/restore of local or remote disks.
- File backup from any local or remote disk of any file size.
- File restore from image backup or file backup.
- Allows wildcards for selection of files.
- Automatic scheduler for unattended backups.
- Backup across networks (using logical image or file-by-file).
- Real time clock display.
- Backup any disk whether formatted for DOS or not
- Escape to DOS while in backup/restore operation.



Automatic Scheduler

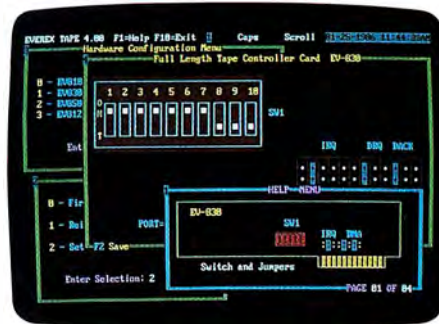

Nestable, Movable Windows

find...



Backup with Multiple Datasets

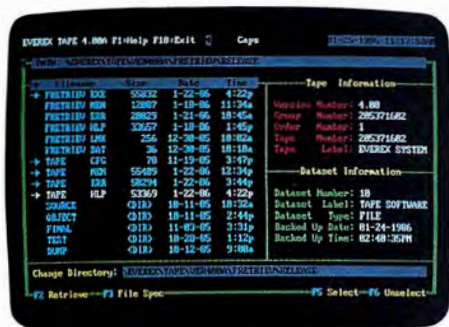

Multiple Tape Restores

If you can find a streaming tape with better performance and system characteristics, buy it:

Performance

- File-by-file operations near streaming speed.
- Dynamic adjustment to disk and system speeds.

System Characteristics

- Hardware identification provides software integrity.
- External systems can be shared with many users.
- Same software for all types of tape drive, controller, and computer system configurations
- External systems uses a shielded round cable with a D-connector for tangle-free, easy connect and disconnect.
- Hardware read-after-write data verification.
- Track 0 seek to insure tape interchangeability.
- Original controller manufacturer.
- Industry standard QIC-24 tape format.
- Industry standard QIC-36 interface.
- Industry standard QIC-02 commands.
- Tape does not require pre-formatting.
- Available in 20MB, 60MB, and 100MB drive capacities.

...buy it!"

EVEREX Excel Streaming Tape.

For the name of your nearest EVEREX dealer or more information, call us. Remember... We are EVER for EXcellence.



Excel Stream 20 Internal



Excel Stream 60 Internal



Excel Stream 60 External 1/2 Height



Excel Stream 20 External



Excel Stream 60 External



Excel Stream 60-8 External



1-800-821-0806 1-800-821-0807 (in CA)

48431 Milmont Dr., Fremont, CA 94538

Inquiry 92 for End-Users. Inquiry 93 for DEALERS ONLY.

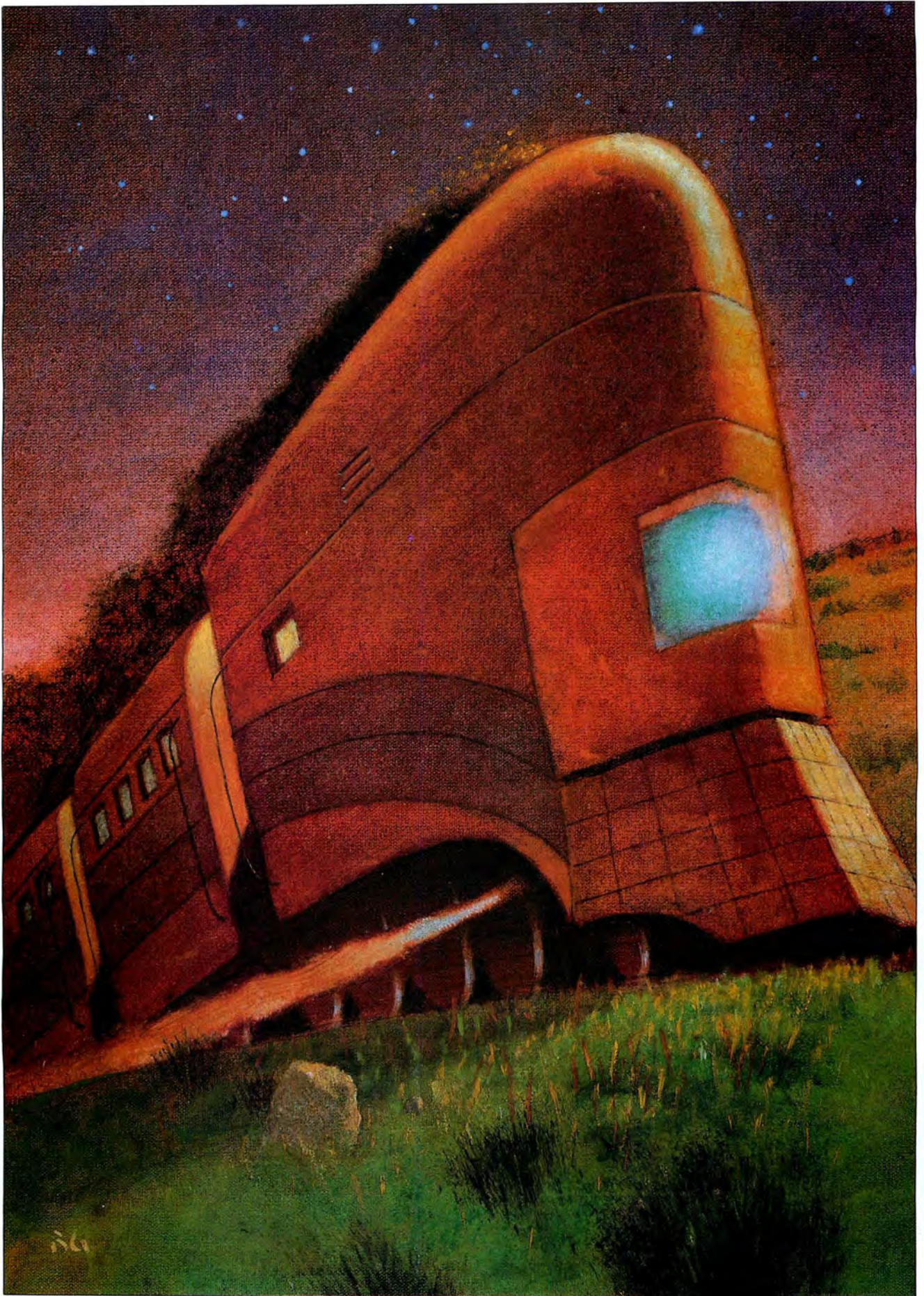

IBM PC ACCELERATORS

*The theory of operation of three kinds
of speedup boards for PCs*

BY STEPHEN S. FRIED

EXPANSION BOARDS are available that can speed up your IBM PC or XT. These accelerator boards cost from \$149 to \$2000 and can result in increased system throughput of 50 to 350 percent (i.e., system speedups of 1.5 to 4.5 times). Some accelerators claim to be better than this, but, for average programs, a speedup factor of 4.5 is the best that can be expected with the average IBM PC. Since a number of accelerators convert your machine into a device that performs as well as or better than the AT, I have included the AT in this article for comparison purposes. Also, the AT has the advantage of running at a number of different speeds. However, in many ways, accelerators are clearly superior to the AT. For example, many of them will be more compatible with your existing hardware and software than the AT: many have faster numerics than the AT, and most eliminate the need to upgrade to 16-bit expansion boards.

Unfortunately, deciding which accelerator to buy can be difficult. For the most part, you must make the decision on your own or with the advice of a friend who has already made such a purchase. Accelerator technology is over the heads of most retailers and does not help them sell new machines. Speeding up an existing machine can involve the use of motherboard boosters, coprocessor accelerators, or emulator accelerators with or without cached memory.

This article will clarify how accelerators work, help you understand how to compare accelerator speed and compatibility, and give you an idea about what type of accelerator does or does not suit your needs. I'll

start off with an intuitive discussion of what an IBM PC-compatible accelerator is, followed by a description of the system constraints within which any accelerator must work and of the three classes of accelerators in today's market.

WHAT IS AN ACCELERATOR?

An IBM PC-compatible accelerator is a hardware product that runs at least MS-DOS applications faster than your original IBM PC. Some, but not all, accelerators will run other operating systems and applications that use the hardware directly. I have already suggested that at least two classes of accelerators exist: those that run MS-DOS only and those that run all PC applications. I will show that there are actually three classes and that the division is dictated by the hardware interface between the CPU on the accelerator and the PC's motherboard.

To perform in the total system environment, the accelerator must provide some mechanism for the CPU on the accelerator to communicate and manage its own devices and those on the system board. These devices include memory on the accelerator, motherboard, or in the I/O channel; the DMA controller on the motherboard; and cards in the I/O channel, such as hard disk controllers and graphics adapters.

The typical accelerator contains a clear dichotomy: Most accelerators speed up because they have internal 16-bit data buses instead of the 8-bit bus that is standard on the PC. This means that the accelerator must be able to operate in two modes: 16-bit and 8-bit. For the devices on the motherboard or in the I/O channel to

function properly, the accelerator's CPU must access them in a manner that makes the motherboard think they are being controlled by an 8088 running at 4.77 MHz. Three approaches will placate the motherboard: leaving an 8088 behind to manage the motherboard, emulating the 8088 with a faster CPU on the accelerator, or ignoring the rules and speeding up the motherboard in the hope that your motherboard is much better than the one IBM designed in 1981. I will refer to these three approaches as coprocessing, emulating, and motherboard boosting.

COMPATIBILITY

Compatibility is a more important issue than speed, and I will treat it first. The accelerator that runs 99 percent of your software three times faster will always be a better buy than the accelerator that runs 85 percent of your software four times faster. This is because the cost of a system's software is often much greater than the cost of the hardware and often cannot be replaced at a reasonable price. Having made a large investment in software that works, people are normally reluctant to sacrifice an old machine for a newer one unless the newer one will run the installed software base.

An accelerator can attempt to achieve four levels of compatibility: source code level, operating system level, object code level, and PC hardware level. The first two levels, source

(continued)

Stephen S. Fried is principal scientist and vice president of R&D at MicroWay Inc. (POB 79, Kingston, MA 02364), which produces 87BASIC and 87BASIC Inline.

and operating system, normally go together and do not require a particular hardware configuration to achieve. For example, it is easy to port UNIX applications written in C among different processors that run UNIX. As a result, many of the minicomputer vendors who have mature products that run under UNIX have chosen coprocessor

boards that run UNIX (better than the 80286) for their ports to the PC market. This strategy is probably based as much on greed as speed, since the code that runs on these boards is worthless without the hardware and the vendors don't sell you their personalized accelerator without the software. As another example, in

the early days of the PC, I easily ported applications written in Microsoft BASIC that ran on my TRS-80 over to my PC. While this definitely increased the speed of my applications, I could not move all of them because many of the best were written in assembly language.

To run programs written in assembly language, an accelerator has to use a CPU that is object-level-compatible with the original used in the PC. It turns out that it is possible to translate 8080 (Z80 is a superset of the 8080) assembly code to run on the 8088, but it is not possible to run 8080 object code on an 8088 (the machine-level encoding of the instructions is different). The object-level differences between the 8088 and the 8080, 6502, and 68000 have spawned a market for coprocessor boards that run your old programs on your new machine. For an accelerator to run 8088 code, it must contain an object-level-compatible (or machine-level-compatible) processor. Examples of processors that are object-level upward-compatible with the 8088 include the Intel 80186, 8086, 80286, and 80386, and the NEC V20 and V30.

The NEC V20 and V30 can switch back into modes that can also run Z80 object code. Had they appeared in 1981, they could have changed the course of microcomputer history and extended the economic life cycle of CP/M-80. The 80386 does some similar tricks within the Intel family. Like the 80286, the 80386 boots up in an 8086 object-compatible mode called real address mode. Unlike the 80286, it can switch over to a virtual 8086 mode in which it can run one or more 8088 or 8086 programs that have their own private virtual address space. However, in its pure 32-bit mode, the 80386 is not object-compatible with the 8088. This feature indicates recognition of the importance of object-level upward compatibility from the microprocessor vendors themselves. As VLSI designs get more dense, it becomes possible to guarantee the future suc-

(continued)

See us at
Riviera Hotel

7/11 '86

R-8031

For Your IBM PC

THE Intelligent Grammar and Style Checker

RightWriter is a new tool to help you produce lean, powerful BUSINESS WRITING. RightWriter uses advanced artificial intelligence technology to flag errors in GRAMMAR, STYLE, USAGE, and PUNCTUATION. RightWriter is the first office automation package aimed at producing better writing, not more writing.

- **Messages are Inserted** directly into text to point out possible errors and problem areas.
- **Easy to Use** — only one command to learn, your word processor does the rest.
- **Works with Leading Word Processors** — including WordStar®, Volkswriter®, PFS:write®, MultiMate®, WordPerfect® and others.
- **Readability Index** — measures the reading grade level of the document using the D.O.D. standard Flesch-Kincaid formula.
- **Uncommon Word List** — lists misspelled, slang, and uncommon words.
- **Recommends** — never decides. RightWriter is a writing aid. The final decision is always left to you.

...RightWriter is an idea whose time is long overdue."

Phil Wiswell — PC Magazine

"RightWriter is an excellent, low-cost, eye-opening software package..."

Inside Word Management

"The documentation is among the best I have seen."

Jim Pile, Soft Sector

Price \$95.00

Available from your local dealer or:
DECISIONWARE, INC./RightSoft Division
2033 Wood St. • Suite 218
Sarasota, FL 33577

**Call Toll Free 1 (800) 992-0244,
In Florida 1 (813) 952-9211**

Add \$4 for shipping and handling.
VISA & MASTERCARD accepted
30 Day Money Back Guarantee

HAUPPAUGE

Is Getting A Fast Reputation.



HAUPPAUGE started earning a fast reputation with their 87 Math Pak, the combination of an 87 chip and 87 Software Pak that's been accelerating PC math since 1982.

Next came their racy 287 FAST/5, a math coprocessor module with its own 5MHz clock, speeding up PC/AT math by 25%. (Pictured above.)

Now, Hauppauge Unveils the 287 FAST10...

Our newest math coprocessor for the PC/AT, the 287 FAST10 moves out at 10MHz—more than doubling the speed of each floating point math operation. The FAST10 accelerates AutoCad, 1-2-3, Symphony, Turbo Pascal, Framework and more. The FAST10 also runs in PC/AT compatibles including the Compaq Deskpro 286, Sperry PC/IT and most 286 accelerator boards.

...And the 87 Software Pak Version 6.2

Designed to steal the heart of programmers, the 87 Software Pak supports IBM's BASIC Compiler 1.0 and 2.0, and Microsoft's QuickBASIC, executing math-intensive programs up to 20 times faster! The 87 Software Pak also performs FFT's and Matrix operations. For example, a PC (or PC/XT) with an 87 Chip and 87 Software Pak can perform a 512-point complex FFT in just 1.1 seconds. What's more, a PC/AT with a FAST10 inverts a 25 by 25 element matrix in under 1 second.

HAUPPAUGE Math Coprocessors

- 287 FAST10, 10MHz math coprocessor for PC/AT and compatibles \$469
- 287 FAST8 8MHz math coprocessor for PC/AT and compatibles ... \$379
- 287 Chip PC/AT math coprocessor —runs at 4MHz in the old model IBM PC/AT and 5.33 MHz in the new model PC/AT \$219

- 87 Chip Math coprocessor for IBM PC, PC/XT and compatibles \$129
- 87-2 Chip Math coprocessor for 8MHz PC compatibles \$195

HAUPPAUGE Math Coprocessor Paks

- 87 Software Pak V.6.2 Math coprocessor software support for IBM BASIC Compiler 1.0, 2.0 and Microsoft's QuickBASIC. Plus, Matrix and FFT support, one year of free updates, complete source code and "8087 Applications and Programming" \$180
- 87 QB PAK Math coprocessor support for Microsoft QuickBASIC and IBM BASIC Compiler \$ 99
- Recalc+ Math coprocessor support for 1-2-3 version 1A \$ 95
- HFT+ Complete Hayes Fourier Transform Package \$125

The 287 FAST10 Doubles Your PC/AT's Math Speed! Help your PC/AT get a fast reputation with Hauppauge's new 287 FAST10. Call today, or contact your local computer dealer to learn more about Hauppauge's racy product line. And ask for "87 Q & A," our free booklet on math coprocessors.

Hauppauge Computer Works, Inc.

358 Veterans Memorial Highway,
Commack, New York, USA 11725
516-360-3827 • TELEX: 262939-HCW

Hauppauge ("Ha-pog")

Inquiry 120

We acknowledge the following registered trademarks: 1-2-3 and Symphony: Lotus Development Corporation; AutoCad: AutoDesk, Inc.; IBM: PC, PC/AT, PC/XT; Compaq: Deskpro; Sperry: PC/IT; Texas Instruments: Business Pro; Ashton-Tate: Framework

England: Dataflex 01 543 6417 • Germany: Rein Electronik 02153 /733-0 • Netherlands: Intra Electronics 040-838009

cess of new products by incorporating older designs as subsets. Thus, an activity that used to be relegated to the OEM is now relegated to the micro-processor merchant.

Object-level compatibility is not all that is needed to guarantee that all programs will work. Accelerators exist that are object-compatible but will not run programs that use the PC's hardware directly; they are not compatible at the PC-hardware level. From a practical viewpoint, the difference between a PC-hardware-compatible accelerator and an object-compatible accelerator is that an object-level accelerator will run any well-behaved MS-DOS application, while a PC-hardware-compatible accelerator will run any operating system or application that controls the hardware in the machine directly. Clearly, the PC-hardware level of compatibility is the ultimate and will run the broadest

range of your existing applications.

Because there are special situations where object-level compatibility can have big payoffs, I must be cautious about simply blacklisting object-level-compatible accelerators as incompatible. The very aspects that make them only partially compatible can sometimes result in increased processing power. However, you must carefully weigh this increase against the fact that they will never work with all your software. The coprocessor class of accelerators is normally object-level-compatible, while emulators and motherboard boosters are object-level-compatible and PC-hardware-level-compatible.

COPROCESSOR BOARDS AND ACCELERATORS

The first class of accelerators is the oldest. Its members leave the 8088 intact and provide a second processor

on an expansion card that fits into the I/O channel. Because those accelerators have two active processors, they occasionally exhibit some parallel execution or coprocessing, hence the name. "Co" can also imply that either processor can control the system bus.

Coprocessors don't necessarily accelerate; their most common job is to run code from a previous generation of machines on a new machine. For example, the IBM RT PC will be available with an 80286 coprocessor card that will let it run normal PC programs. This will let RT owners break out of their engineering applications long enough to run off a few worksheets with Lotus 1-2-3, for example. Another example of a coprocessor that was developed to ease the transition to the original PC is the Baby Blue, which could run CP/M-80 programs.

Today the most popular PC copro-
(continued)

FREE SHIPPING ON ORDERS OVER \$100

LEADING EDGE

1200B	Model "L" Modem	\$ 139.00
LE	Word Processor	CALL

HEWLETT-PACKARD

HP110	Portable w/Lotus™ 1-2-3™	\$ 1295.00
2225B	Thinkjet Printer	\$ 379.00
7440A	8-Pen Plotter	\$ 969.00
9114A	710K Disc Drive	\$ 625.00
82143A	Thermal Printer	\$ 295.00
82161A	Cassette Drive	\$ 423.50
82162A	IL Printer	\$ 346.50
82164A	IL/RS-232 Interface	\$ 227.15
92285A	Laser Jet Toner (Black)	\$ 87.95
92286A	Font Cartridge	\$ 173.25

HEWLETT PACKARD

HP-11C	Scientific	\$ 41.95
HP-12C	Financial	\$ 73.95
HP-15C	Scientific	\$ 73.95
HP-16C	Computer Science	\$ 87.95
HP-41CV	Scientific	\$ 130.95
HP-41CX	Scientific	\$ 187.95
HP-71B	Handheld Computer	\$ 389.95
New	CMT 32K RAM for 71B	\$ 139.00
HP-18C	Business Consultant	\$ 130.95

AST

SixPakPlus	w/64K RAM	\$ 149.00
SixPakPlus	w/384K RAM	\$ 209.00

TERMS:

- Liberal Return Policy
- Free Shipping on orders over \$100 (Continental U.S.)
- NO ADDITIONAL CHARGE for credit cards
- MD residents add 5% sales tax
- Credit references required for open account
- Allow 2 weeks for personal checks
- C.O.D.'s - cash, money order, bank or certified check

COMPUTERS

Xerox PC-6064

IBM™/AT&T compatible

Monitor • 2 - 360K drives • 8086 processor • 256K RAM

\$1695

Sharp PC7000

XT Portable

25 line LCD • Detachable Keyboard • 320K RAM • 8086 • 2-360K Floppy Drives

\$1295

Toshiba T-1100 +

IBM™ convertible/compatible

• 2 - 720K 3 1/2" Drives • 80C86 processor • CRT, Serial, Parallel Ports • 25 line LCD • 640K RAM

\$1795

PRINTERS

Xerox/Diablo

D-25	25cps Daisywheel	\$ 499.00
635	55cps Daisywheel	\$ 1060.00
4045CP	Laserprint/Photocopier	\$ 4295.00

Okidata

ML182	120cps Dot Matrix	\$ 219.00
ML192	160cps Dot Matrix	\$ 309.00
OK 20	Color Dot Matrix	\$ 189.00
ML193	160cps Wide Carriage	\$ 499.00
ML292	200cps Dot Matrix	\$ 515.00
ML293	200cps Wide Carriage	\$ 669.00

Brother

M1109	100cps Friction/Tractor	\$ 189.00
M1509	180cps Wide Carriage	\$ 369.00
HR-10	10cps Daisywheel	\$ 249.00
HR-15XL	17cps Daisywheel	\$ 299.00
HR-35	36cps Daisywheel	\$ 739.00
2024L	200cps & NLO	\$ 650.00
Twinriter 5	Daisywheel & Dot Matrix	\$ 815.00

Panasonic

KXP1091		\$ 239.00
---------	--	-----------

*Limited Quantities

Smith Corona

Fastext	80cps Dot Matrix	\$ 99.00
---------	------------------	----------

Epson

LX-90	100cps & NLO Dot Matrix	\$ 229.00
FX-286	200cps Dot Matrix	\$ 539.00

New LQ-800, LQ-1000. CALL
FX-85, AP-80, LX-80
DX-10, DX-20, DX-35. CALL

Toshiba

P321	24 Pin-head/216cps	\$ 479.00
------	--------------------	-----------



CAPITAL MICRO
P.O. BOX 29639
WASHINGTON, D.C. 20017



(800) 544-4442
IN MARYLAND
(301) 565-3595

We have 100's of Software and hardware items in stock. Shipments on almost all items within 24 hours!



SPECIAL
WORD PERFECT
\$195

Call for programs not listed

Technical & Other Info. (602) 246-2222

TOLL-FREE ORDER LINE 1-800-421-3135

FREE! UP TO \$100 SOFTWARE FREE!

With every purchase over \$100.00 you can select one of the following MS/DOS diskettes at no charge. Please indicate choice(s). 1. Blueberry I - 54 basic utility programs includes printer select, graphic generation, etc. **Retail value \$10. 2.** Blueberry II - includes a banner generator, a label maker and a checker game (requires graphics card). **Retail value \$10. 3.** Print Select program - Assembly language program to select different type fonts, etc., or make your printer function as a correctable typewriter - perfect for envelopes, notes, etc. Adaptation modules for popular printers included and capability to adapt to any printer. **Retail value \$40. 4.** Deposit Program Compiled DBase to list and total cash, check, bank card for bank deposit and keeps history - Developed for our corporate use - Super Program! (source code available). **Retail value \$40.** Select an additional diskette for every additional purchase of \$150 or purchase over \$500 and receive all four at no charge.

DATA BASE MANAGERS	
Clipper.....	\$334
Clout 2.....	117
Condor III.....	310
Knowledgeman II.....	290
Nutshell Filer.....	59
Powerbase 2.2.....	212
PFS: File.....	76
Q&A.....	Call
Quickcode.....	138
Quickreport.....	138
Revelation.....	445
R: Base System V.....	332
WORD-PROCESSING	
Easy.....	88
Leading Edge w/Merge/Spell.....	75
Microsoft Word.....	252
Multimate Advantage.....	Call
Peachtext 5000.....	145
PFS: Write.....	76
Volkswriter 3.....	139
Webster Spellcheck.....	37
Wordstar.....	162
Wordstar Propac.....	233
Wordstar 2000.....	233
Wordstar 2000+.....	278
SPREADSHEET	
Microsoft Multiplan.....	108
PFS: Plan.....	76
Spreadsheet Auditor 3.0.....	82
Supercalc 4.....	Call
VP Planner.....	49
ACCOUNTING	
BPI AP, AR, PR, GA.....	299 ea.
Cyma.....	Call
Dac Easy Accounting.....	39
Managing Your Money.....	94
INTEGRATIVE	
Ability.....	59
Enable.....	312
Smart Software.....	Call
COMMUNICATION PROGRAMS	
Crosstalk.....	89
Remote.....	89
Smartcom II.....	83
GRAPHICS	
Chartmaster.....	205
Energraphics 2.0.....	269
In-A-Vision.....	249
Microsoft Bus Mouse.....	106
Microsoft Chart.....	164
Microsoft Serial Mouse.....	119
Newsroom.....	33
PC Mouse W/DR Halo II.....	106
Printshop.....	33
Signmaster.....	132
PROJECT MANAGER	
Harvard Total Project.....	262
Microsoft Project.....	219
Super Project Plus.....	239
Timeline 2.0.....	209

EDUCATIONAL	
Flight Simulator.....	\$28
Turbo Tutor.....	20
Typing Tutor III.....	Call
LANGUAGES	
Lattice C Compiler.....	242
Microsoft C Compiler.....	249
Microsoft Fortran.....	195
Microsoft Macro Assembler.....	84
Microsoft Pascal Compiler.....	166
Microsoft Quick Basic.....	55
Ryan McFarlan Fortran.....	305
Ryan McFarlan Cobol.....	479
Turbo Pascal w/8087 + BCD.....	55
UTILITIES	
Carbon Copy.....	115
Copy II PC.....	19
Copywrite.....	39
Desqview.....	55
Double Dos.....	27
Fastback.....	85
Microsoft Windows.....	55
Norton Commander.....	37
Norton Utilities 3.1.....	49
PC Tools.....	19
Prokey 4.0.....	70
Sidekick.....	31
Sidekick (unprotected).....	47
Sideway 3.1.....	36
Superkey.....	39
Traveling Sidekick.....	39
XTree.....	27
ACCESSORIES	
Copy II PC Board.....	75
IBM 135 watt power supply.....	59
Mini Micro Parallel Print Buffer.....	69
Masterpiece.....	88
Masterpiece Plus.....	113
INCREDIBLE VALUE	
Nationally advertised boards for IBM PC and most compatibles at give away prices.	
Keyboards (similar to 5151).....	\$79
Monochrome Board w/printer port (similar to Hercules Graphics).....	\$79
Expansion Board 0 to 576K.....	\$42
Multifunction Board w/game port (similar to AST six pack).....	\$79
Four Drive Floppy Controller.....	\$39
Color Card w/o printer port.....	\$69
Color card w/printer port.....	\$79
HARD DRIVES	
Bernoulli 20 MB w/cont.....	2077
Filecard 20 MB.....	555

Maynard 20 MB Hard Card... Call	
Seagate 20 MB Int. w/cont... \$385	
Seagate 30 MB Int. w/cont... 479	
Seagate 30 AT Int... Call	
PRINTERS	
CANON LASER.....	1939
CITIZEN	
MSP-10.....	285
MSP-15.....	385
MSP-20.....	325
Premiere 35 Daisywheel.....	469
EPSON SPECTACULAR	
Hurry - Call us now for special low, low pricing on the following Epson printers:	
FX86.....	FX286
LQ800.....	LQ1000
EX800.....	EX1000
LX86.....	LQ2500
Pricing good through December 31, 1986.	
NEC	
NEC P5XLP.....	1126
NEC P7 Parallel.....	635
NEC 8850.....	1098
NEC P6 Parallel.....	455
OKIDATA - Call on all models	
PANASONIC	
1091.....	235
1092.....	299
1592.....	425
KXP3151.....	399
STAR MICRONICS	
LV1210.....	179
NB15.....	975
NX10.....	232
SG15.....	365
SR15.....	585
TOSHIBA	
P351.....	969
P341.....	768
P321.....	Call
MONITORS	
AMDEK 310A.....	142
AMDEK 600.....	395
Magnovox Color RGB.....	Call
Multitech Color RGB.....	259
Princeton Max 12.....	159
Samsung TTL Amber.....	72
Samsung TTL Green.....	70
EGA MONITORS	
AMDEK 722.....	505
NEC Multisync.....	Call
EGA BOARDS	
Everex Enhancer EGA.....	235
Paradise Auto Switch EGA Card.....	359
Quad EGA Plus.....	365
STB EGA Plus.....	Call
Vega Video.....	Call

RAM	
64K 150NS (set of 9).....	\$11.50
256K 150NS (set of 9).....	30
256K 200NS (set of 9).....	39
MODEMS	
Everex 300/1200.....	120
Hayes 1200.....	Call
Hayes 1200B.....	Call
U.S. Robotics Courier 2400.....	359
U.S. Robotics Passwd. 1200.....	180
BOARDS	
AST Advantage.....	329
AST Premium.....	359
AST Sixpac (384K).....	Call
Hercules Color Card.....	145
Hercules Graphics +.....	182
Intel Above Boards.....	Call
J Lazer (Tall Tree).....	Call
J Ram III (Tall Tree).....	179
J Ram III AT (Tall Tree).....	Call
STB Chauffeur.....	185
STB Mono.....	155
COMPUTERS	
ABBOTT TURBO PC	
IBM Compatible Computer, 4.77 or 7.47 key selectable, AT style keyboard, 640K, dual drive, 135 watt power supply.....	
	\$599
or with 20 MB Seagate Harddrive.....	
	\$970
6 month limited warranty	
Corona PC.....	Call
Multitech 900 Accel	
IBM AT Compatible, 512K, expandable to 1 MB on the mother board, one 1.2 MB drive, 195 watt power supply, MS/DOS 3.1, clock, 6 or 10 MHz key selectable, soft white monitor, AT style keyboard, 1 year TRW warranty.....	
	Call
Multitech Turbo	
IBM Compatible Computer, 256K, dual drives, 8 MHz, ports-parallel-serial-clock, 5151 type keyboard, graphics board (similar to Hercules), mono monitor DOS 3.1, 6 month national warranty.....	
	Call
Sharp Portable.....	Call
TERMS: Add 3% for C.O.D. orders. Shipping on most software is \$5.00. AZ orders +6.7% sales tax. Personal check - allow fourteen (14) days to clear. We accept purchase orders from authorized institutions for 1.5%. All returns are subject to our approval. There will be a 20% restock fee. Minimum phone order \$50.	

No Charge for Master Card or Visa

TOLL-FREE ORDER LINE 1-800-421-3135

WAREHOUSE DATA PRODUCTS

2701 West Glendale Ave. • Phoenix, AZ 85015



Hours 7 A.M. to 5:30 P.M. M.S.T. - Mon. thru Fri.
Saturday 10:00 A.M. to 3:00 P.M.

cessor products are those that let alternate sophisticated operating systems and processors run in the AT. The operating system that drives most of these coprocessor boards is UNIX, and the processors of choice for this job include the IBM 370 on a board, the Motorola 68000/68020, and the National Semiconductor 32032. The key to three of these coprocessor boards is that they let minicomputer software developers move their UNIX applications to the AT. At a recent CAD/CAE show, I saw at least five \$30,000 electronic-design packages, each of which ran on the AT and came with its own \$6000 accelerator. While some argument can be made that the C implementations on some of the minis are more powerful than those available on a PC, I don't think the work involved in porting these applications to UNIX on the coprocessor boards was much more involved than

a C port straight to an AT.

When a coprocessor board uses a processor that is object-level-compatible with the 8088, I call it a coprocessor accelerator. This type of accelerator offers two advantages over a conventional PC. First, the boards have two processors; the original 8088 stays in place to handle I/O tasks, while the on-board coprocessor is available for CPU-bound tasks. Because the 8088 is not removed, a coprocessor accelerator is slightly easier to install than an emulator. Second, since the I/O interface between the CPU on the accelerator and the 8088 is nonstandard, the cards will usually work only with MS-DOS-compatible software that does not use the hardware directly. Since your nonstandard architecture is going to force you to write an operating-system-interface layer, it pays to add other nonstandard features such as increased

system memory. I am not familiar with all the benefits of all the boards on the market, but these nonstandard benefits appear to include increases in DOS memory and the ability to run several coprocessor cards in the same PC.

Faster I/O is not usually a result of installing a coprocessor accelerator. I/O ought to be faster in this type of accelerator and is when the bottleneck in an application is the time spent by the operating system handling I/O calls. However, this is rarely the case. Operating systems such as MS-DOS spend a small proportion of their time in the OS as opposed to the hardware driver. On the other hand, sophisticated multiuser and real-time operating systems often bog down in the layers of the OS. Unfortunately, these operating systems rarely run on coprocessor accelerators, so this

(continued)



BACKUP YOUR SOFTWARE WITH LOCKSMITH/PC™.

You needn't feel helpless when a copy-protected program disk fails. Keep on working... with backups. LOCKSMITH, the original backup/copy program that took the Apple world by storm, is now available for the IBM/PC and compatibles.

LOCKSMITH/PC features:

- Backup protected software
- FAST unprotected disk backup
- HARD DISK support
- Disk, track and sector utilities
- File and directory utilities
- Easy to use
- Fast mass-duplication for software developers
- Create "protected" diskettes
- Repair damaged disks
- Map disk & file allocation
- Compare files
- Easy-to-use tutorial
- Examine/modify sector data
- File encryption/decryption

Don't get caught with your hands tied. Order LOCKSMITH/PC today.



LOW INTRODUCTORY PRICE \$79.95
for IBM/PC, PC/XT, PC jr and compatibles.
LOCKSMITH/PC is **NOT** copy-protected.
Available from your computer dealer or directly from:



Alpha Logic Business Systems, Inc.
4119 North Union Road
Woodstock, IL 60098
(815) 568-5166



©Alpha Logic Business Systems, Inc. 1985
Locksmith and Locksmith/PC are registered trademarks of Alpha Logic Business Systems, Inc.

YOUR #1 CHOICE Technoland™

5830 E. Washington Blvd.
City of Commerce, CA 90040

We used to be PC 1,
We're still your #1 Choice!

**Order Toll Free :
(800) 222-3978**

In California : (213) 724-2781
Technical Support : (213) 724-1684
Customer Service : (213) 724-1685

Basic System

- 8088-2 CPU — Runs at 4.77 or 7.4 MHz
- 640K RAM
- 360K Half-Height Floppy Drive w/Controller
- Runs All Major PC-DOS Software
- AT™ Style Keyboard
- 135 Watt Power Supply
- System Manual
- MS-DOS 3.10
- Full 18 Month Warranty



\$659



AT™ System

- 80286 Processor (Switchable 6/8 Mhz)
- 512K RAM (1 024K Optional)
- 1.2 MB Half-Height Floppy Disk Drive
- Floppy/Hard Disk Controller Card
- Clock/Calendar w/Battery Backup
- Runs All Major PC-DOS Software
 - 200 Watt Power Supply
 - AT™ Style Keyboard
 - System Manual
 - MS-DOS 3.10
- Full 18 Month Warranty

\$1259

Monochrome System

- Basic System Plus . . .
- Monochrome Graphics Adapter
- 12" TTL Monochrome Monitor

XT **\$859**
AT **\$1459**

Color System

- Basic System Plus . . .
- Color Graphics Adapter
- 13" RGB Color Monitor (640 x 200)

XT **\$1059**
AT **\$1659**

EGA System

- Basic System Plus . . .
- Enhanced Graphics Adapter
- 13" High-Res RGB Color Monitor (640 x 350)

XT **\$1339**
AT **\$1939**

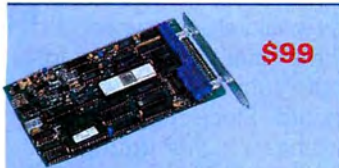

\$99

Turbo Speed Hard Disk Controller

- 1:1 Interleave Lets Hard Drive Run at Full Speed
- Up To 6 times Faster Than Standard Controller
- No Hardware Setup Required

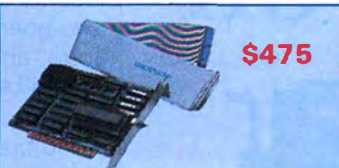

\$475

Tiny Turbo Card

- High-Speed Accelerator for PC and PC/XT
- Replaces 8088 with 80286
- Socket for 80287 on Board
- Short Card



\$148

Hayes Compatible Modem

- 300 & 1200 BPS
- Short Card
- Fully Hayes Compatible

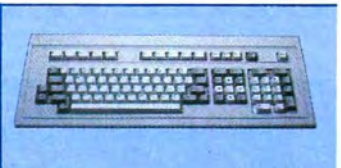

\$79

Enhanced Keyboard

- Separate Cursor & Numeric Pads
- Keys in Standard Locations
- LED Status Indicators
- Keytronic 51 51 Compatible

Citizen High Speed Dot Matrix Printer

MSP-20 (80 Column) **\$329**
MSP-25 (136 Column) **\$489**

- 200 CPS Draft / 50 CPS NLQ
- IBM, Epson Compatible
- Centronics Parallel Interface



\$169

AT Multifunction Card

- Expandable to 3 MB — 1.5 MB on Board, 1.5 MB on Piggyback Board (OK Installed)
- Supports 64K & 256K RAM Chips
- Parallel, Serial and Game Ports

AT Mini I/O Card **\$89**

- Parallel, Serial and Game Ports



\$139

XT Multifunction Cards

- 384K RAM
- Optional FDC
- Parallel, Serial and Game Ports
- RAM Disk & Printer Spooler Software

XT Mini I/O Card **\$89**

- Parallel, Serial and Game Ports



\$90

135 Watt Power Supply

- XT Compatible
- UL Recognized (UR)
- Extra Power for Hard Drives

Hard Disk Kit

- 20 MB - **\$399**
- Boots from Hard Disk
- Instruction Manual
- Cables & Mounting Hardware
- Hard Disk Controller



Hard Disk Card

20 MB — **\$408**

- 3 1/2" Hard Card
- Easy Installation
- Formatted and Tested
- Boots From Hard Disk
- IBMXTCompatible

Expansion Box

\$150

- Room for 3 Half-Height Drives
- 120 Watt Power Supply
- 5 Slot Bus

Host Bus Interface Cards w/Cable - **\$119**

\$119



"IBM's Brother" Monochrome Monitor

- IBM Lookalike **\$119**
- 12" Screen
- Amber or Green



Mono-Graphics Adapter

- Hercules™ Compatible
- Parallel Port

\$99

High Resolution RGB Color Monitor

- 13" Screen **\$339**
- 640 x 200 Resolution
- RGB — 16 Colors



Color Graphics Adapter

- 80 x 25 Character Text Mode
- 640 x 200 Dot Graphics Mode
- Fully IBM Compatible

\$89

EGA Compatible Color Monitor

- 31" mm Dot Pitch
- 13" Screen **\$449**
- 640 x 350 Resolution
- RGB — 16 Colors



EGA Card

- EGA, CGA, MDA & Hercules™ Compatible
- Flicker-Free Display
- Short Card - Add \$10

\$249

AT Type Hard Disk Drives

- 20 MB - **\$549**
- 30 MB - **\$629**
- 40 MB - **\$759**
- Boot from Hard Disk
- Instruction Manual
- Cables & Mounting Rails
- Works w/AT Hard Disk Controller



Floppy Disk Drive

- Half-Height
- DS/DD — 360K
- Name Brands — TEAC, Panasonic, Mitsubishi, Sanyo, Etc.



\$90

Fast Tape Backup

20 MB — **\$449**
60 MB — **\$725**

- Easy Loading Tape Reels
- Responds to Standard DOS File Handling Commands
- Cables, Mounting Hardware and Tape Cartridge Included
- Software Included

Technoland's Policy:

We accept MasterCard and VISA (no surcharge), money order, cashier's check, personal check (please allow 10 days to clear), company/institutional PO's and wire transfers. We pay shipping (UPS ground — faster shipping available at additional charge) in continental US. We pay applicable sales tax.

Any items bought from Technoland (including software if unopened) may be returned for a full refund within 30 days of the date it was shipped if for any reason you are not 100% satisfied. All Technoland products carry Technoland's one year limited warranty; some products also carry manufacturer's warranty. Selected Technoland products may carry additional warranties. Warranty policy requires that you submit proof of purchase and obtain an RMA number from us by telephone.

IBM, Hercules, Compaq, ATT, Panasonic, TEAC, Mitsubishi, ARC, Sanyo, Western Digital and Seagate are trademarks of their respective companies. MS-DOS is a trademark of Microsoft Corporation. IBM PC, IBM XT and IBM AT are trademarks of IBM Corporation.

Quantity Discount Available!

Ask Us About Our "Order It Today, Use It Tomorrow" Special

30 Day Money-Back Satisfaction Guarantee

California Residents — We'll Pay Your Sales Tax!

benefit is not realized in practice. The usual reason that I/O is slow is slow I/O devices. I will show this in the benchmarks, where the range in I/O throughput varies over a factor of 60 to 1 in going from RAM disks to floppies.

When really fast I/O devices are used, coprocessors lose ground with

respect to emulators. This is the result of the fact that they use the relatively slow 8088 for I/O, whereas the emulator uses its on-board 8086 or 80286 for I/O. A novel installation I was involved in recently used an emulator accelerator to speed up motherboard I/O by effectively replacing a PC's 8088 with an 8086. It also

used an Orchid Turbo board with an 80186 that accelerates CPU-intensive activities. While this installation worked, I am not convinced that the combination is any better than a straight 8086 board running with a RAM BIOS that speeds up the ROM I/O routines by moving them to 16-bit RAM. A simple analysis of the situation reveals that, since MS-DOS is single-threaded, there would be no parallel processing of I/O with CPU-bound activities. Consequently, the two boards would alternate back and forth, and the total time to do a job would be the sum of the time taken by each board. Since the 9.54-MHz 8086 board has a higher throughput than the 8-MHz 80186 on the Orchid Turbo, my guess is that an 8086 board by itself would have run as fast or faster than the combined installation.

The main benefit of coprocessor accelerators, the possibility of achieving concurrent I/O, is also their biggest drawback. The key to leaving the 8088 behind on the system board is a software layer that translates calls that would normally go to the ROM BIOS into commands that now have to be shipped to the system board's 8088. As long as you are running MS-DOS applications that avoid direct manipulation of the hardware, all is fine. However, any time an application or new operating system attempts to directly control the hardware, a problem arises: The coprocessor board has a different architecture than the original machine and responds differently to hardware commands. Operating systems such as XENIX, RTOS, UCSD p-System, and Concurrent DOS, and operating environments such as Window, DESQview, DoubleDOS, and GEM are all examples of programs that have to directly control the hardware and will not work with a coprocessor unless the interface layer between the board and the 8088 is rewritten for each application. Reworking this interface turns out to be an incredibly expensive task and is the reason why popular coprocessor boards such as the Orchid Turbo, Pfaster-286, and

(continued)

BREAKTHROUGH



Thinking about building a multi-user dial-up application, but concerned about the high cost of a superminicomputer or mainframe?

Consider the GALACTICOMM BREAKTHROUGH, a 16-channel modem card for the IBM PC/XT, PC/AT, and compatibles. Now, using this card together with the SOFTWARE BREAKTHROUGH object library, you can easily put together high performance multi-user applications at minimum cost.

The software is the key

- Special interrupt-driven I/O method eliminates 92% of the interrupt overhead of conventional designs
- DOS-bypass subroutines to access all modem functions (e.g. accept a call, place a call, send/receive ASCII data, send/receive DTMF data, check modem status, set baud rate and parity, and much more)
- Assembly language automatic pending-input channel-scanning and circular/linear buffer management
- Supports up to 64 channels (4 BREAKTHROUGH circuit cards) simultaneously at 1200 baud on the PC/AT
- Port stacking technique allows direct addressing of each modem while consuming only 2 PC ports per card
- All PC-DOS compatible, bindings exist for most popular languages, not copy-protected, no royalties

The hardware is incredible

- The XECOM 1201 is the modem module described in Steve Ciarcia's November 1985 Circuit Cellar column
- Each modem module is complete, USART to DAA, 212A compatible, FCC registered and ready to run
- Adapters available for direct connection via 16 RJ-11's, or a single RJ-21X mass telephone connector
- Port stacking technique allows direct addressing of each modem while consuming only 2 PC ports per card
- DIP-switch selectable port-group addressing on any even boundary in the range from 200H to 3FEH

The applications are limitless

- Multi-user bulletin boards and EMAIL systems
- Multi-user real-time teleconferencing
- Multi-user customer order entry networks
- Multi-user online expert systems
- Multi-user classified advertising services
- Multi-user database search & retrieval systems
- Multi-user interactive adventure games
- Multi-user sales information inquiry systems
- Multi-user online educational services
- Multi-user "simulated CB-radio" networks

For some free sample time on a PC/XT running the GALACTICOMM BREAKTHROUGH, dial (305) 922-3901 during business hours. Have your modem ready to go online in originate mode at 300 or 1200 baud: 7 data bits, even parity, 1 stop bit.

GALACTICOMM
 GALACTICOMM, Inc., 11360 Tara Drive, Plantation, FL 33325 (305) 472-9560

Tickle Your Palette.



Only AT&T Truevision™ products satisfy your craving for vivid television-quality graphics.

We have six frame capture-and-display boards that are changing PC graphics forever. Each takes up a single slot in your PC and captures images from a video source in real time, in real color.

How many colors? Up to 16.8 million. And that's not sweet talk. It's Truevision™.

Take Your Pick.

Choose the one that's best suited for your application. Grab our Truevision Image Capture Board, for only \$1,295. It offers 256 x 240 pixel resolution and 32,768 colors.

Or for higher resolution choose from the Truevision Advanced Raster Graphics Adapter (TARGA) series. Providing up to 512 x 482 pixel resolution and as many as 16,777,216 colors. For those with more sophisticated tastes,

TARGA 32 includes overlay and 128 levels of mix for blending live video and stored images.

Need a board that only displays? We have that, too. Our 256 x 240 pixel Video Display Adapter with Digital Enhancement (VDA/D). Only \$695.

Just add one of our boards to any AT&T PC 6300, PC 6300 Plus, IBM PC, XT, AT, or plug compatible. Suddenly you have a system that allows you to work with TV-quality images, in living color or black and white. Images captured in real time from NTSC composite video or analog RGB sources. Images captured in real color, not the painted-over pseudo-color others are offering.

Truevision captures it all in real time: 1/60 second per field or 1/30 second per frame.

Crave More?

Combine our boards with Truevision Image Processing Software (TIPS) and now you can modify, enhance, merge and manipulate the captured images. Superimpose text and graphics. Air-brush, anti-alias, blend, tint, and magnify. Or create your own colorful graphics from scratch.

The AT&T Truevision family of imaging products. They're changing the way personal computers see things. Grab some and satisfy your craving for high color resolution graphics.











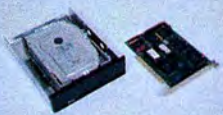



To order or find out more, please write or call AT&T Electronic Photography and Imaging Center, 2002 Wellesley Boulevard, Indianapolis, IN 46219. **1-800-858-TRUE.**



AT&T
The right choice.

Truevision is a trademark of AT&T. IBM is a registered trademark of International Business Machines Corporation. Truevision design and development by JWHKLACAARAKCCCCBHHBJKSJSSJAW. Inset: Unretouched photo of TARGA 24 image, manipulated with TIPS software. © 1986 AT&T

8 YEARS OF GUARANTEED QUALITY & SERVICE

<p>PC HARD DISK KITS 20 MEGABYTES IS20 \$429 30 MEGABYTES IS30 \$525</p>			<p>PC/AT HARD DISK KIT 80 MEG HARD DISK FREE SCSI PORT IS80-S \$1995</p>
<p>PC, AT & TANDY 1000 HARD DISK CARD 30 MEG HARD DISK PCWD-30 \$795 TWD-30 \$795</p>			<p>HIGH CAPACITY AT/XT HARD DISK KIT 250 MEGABYTES WITH SCSI PORT IS250S \$4995</p>
<p>PC, AT & TANDY 1000 HARD DISK CARD 21 MEG HARD DISK FREE SCSI PORT THC-21 \$675 PCHC-21 \$675</p>			<p>PORTABLE FLOPPY DRIVE CAPACITY: 720K MF720P \$295</p>
<p>PC, AT & TANDY 1000 HARD DISK CARD 20 MEG HARD DISK PCWD-20 \$479 TWD-20 \$479</p>			<p>SCSI HOST ADAPTER CARD CONNECTS YOUR PC TO 7 OTHER DEVICES SCSI-1 \$190</p>
<p>TAPE BACKUP 40 MEG INTERNAL MT40 \$595 40 MEG PORTABLE MT40P \$695</p>			<p>TANDY 1000 MULTI-FUNCTION CARD SERIAL PORT DMA CONTROL CLOCK 512K TMF-1 \$269</p>
<p>TAPE BACKUP 60 MEG INTERNAL MT60 \$795 60 MEG EXTERNAL MT60E \$895</p>			<p>CALL FOR OUR FULL LINE OF HALF CARDS COLOR GRAPHICS MEMORY CARD FLOPPY CONTROLLER CALL</p>
<p>LASERBANK 2000 2 GIGABYTE LASER DRIVE CALL</p>		<p>WITH ALL HARD DRIVES DIRECT/ASSIST \$49.95 R/ASSIST \$49.95 LIGHT SPEED \$79.95 CACHE/ASSIST \$49.95</p>	<p>FREE</p>
<p>LASERBANK 400 200 MEGABYTES LASER DRIVE CALL</p>			<p>DATA TOWER 1 GIGABYTE HARD DISK SYSTEM CALL</p>

PCelevator work only with MS-DOS and applications that avoid controlling the hardware.

EMULATOR ACCELERATORS

The second class of accelerators requires that you remove the 8088 on your motherboard using a simple tool and replace it with a 40-pin plug that is connected to the accelerator, which you then install in the I/O channel. This type of board normally includes a 16-bit CPU and the circuitry required to let the 16-bit CPU mimic the 8088 using the 40-lead ribbon cable that plugs into the 8088 socket. Since this process is usually called processor emulation, I refer to this class as emulator accelerators.

There are at least three types of emulators on the market. These can be distinguished by the type of memory that resides on the accelerator and include no memory, 16-bit cached memory, and 16-bit true memory. Cards are available that provide a combination of cache and pure memory. From the viewpoint of speed, the more pure memory a board has, the faster it will run. Whatever type of memory is used, the processor on an emulator has to be an 8088 object-compatible (8088, 8086, 80186, 80286, V20, or V30) device that is capable of running at a clock speed greater than 4.77 MHz.

The classic emulator accelerator gets most of its speed by the increase in data-bus bandwidth between the CPU and the memory resident on the accelerator. Simply stated, the 8086 is hooked directly to a 16-bit memory bank on the accelerator via a 16-bit data bus. This bus is twice as wide as the 8-bit data bus on the motherboard and is running at twice the clock speed. Multiplying the increase in width (two) by the increase in frequency (two) gives a data-bus bandwidth increase of four.

Unfortunately, the accelerator has to communicate occasionally with the motherboard through the 40-lead cable that plugs into the 8088 socket. All communication with the motherboard requires that the 8086's 16-bit

(continued)

ORDER LINE 800 228-0891

0986

Inquiry 189

305 677-8333



1 YEAR WARRANTY, 30 DAY MONEY BACK GUARANTEE

Micro Design International, Inc.

6985 University Boulevard, Winter Park, Florida 32792



Seal of Approval

Lotus certifies ATI's Graphics Solution

ATI's "Small Wonder" Graphics Solution has never been slow to pick up compliments, particularly in the area of multi-mode flexibility. Much of the credit for this is due to ATI's use of advanced technology. Therefore it's not very surprising that Lotus - the world's leader in software - has certified the "Graphics Solution" for 132 x 44 monochrome spreadsheets and 640 x 200 7 color graphics so you can see more spreadsheet and sharper, more colorful graphs on 1-2-3 (2.0) and Symphony (1.1).

At ATI, we think we've developed a better graphics card. It just might surprise you how much better. Call us at **(416) 477-8804** for more information.



LOTUS CERTIFIED 132x44 MONOCHROME SPREADSHEETS

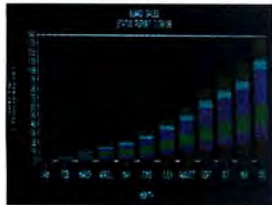

LOTUS CERTIFIED 640x200 HIGH RESOLUTION COLOR/GRAPHICS



COLOR SOFTWARE ON MONOCHROME MONITOR IN 16 SHADES



ASHTON-TATE FRAMEWORK II 4 COLORS, 640x200 ON DESKTOP 16 COLORS, 640x200 GRAPHICS

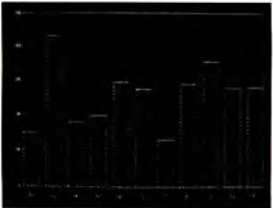

HERCULES COMPATIBLE MONOCHROME GRAPHICS



PLANTRONICS COMPATIBLE HIGH RESOLUTION 16 COLORS

DISTRIBUTORS

F.A. COMPONENTS
 NY (718) 507-1444, outside NY (800) 847-4148
 IN (219) 432-8540, outside IN (800) 331-7567
 SC (803) 288-2422, outside SC (800) 845-2747
 WA (800) 321-6012, outside WA (800) 426-1412
SAI America - MD (301) 459-2100, outside MD (800) 638-9579
Compuserve - CAN (416) 477-8088
EMJ Data - ONT (800) 265-7212, outside ONT (800) 837-2444
Electronic Marketing Specialists
 S.CA (714) 832-9920, (818) 708-2055, (619) 560-5133
 N.CA (408) 245-9291, UT (801) 268-9866
 CO (303) 745-0745, AZ (602) 840-8855
 WA (206) 575-0223

NOW! ATI ALSO HAS DRIVERS FOR ASHTON-TATE FRAMEWORK II

*Trademarks: Lotus, 1-2-3, Symphony, - Lotus Development Corporation; Framework II - Ashton-Tate Inc.; PC Paintbrush+ - Z-Soft Inc.; IBM - International Business Machines Inc.; Hercules - Hercules Computer Technology Inc.; Plantronics - Plantronics Enhanced Graphics Corp.



THE GRAPHICS SOLUTION

FEATURES

- Hercules Compatible Monochrome Graphics
- Runs Color/Graphics Software on Monochrome Monitor in 16 Shades Without Pre-Boot Drivers
- High Resolution Color/Graphics
 - 320 x 200 16 Colors
 - 640 x 200 4 Colors
 - 640 x 200 16 Colors
- IBM Compatible Color/Graphics
- 132 Columns in Either Color or Monochrome
- Lotus Certified Drivers for 132 Columns and 640 x 200 High Resolution Color/Graphics
- Drivers for 640 x 200 High Resolution 16 Colors on Framework II
- Parallel Port and Serial Port Optional
- 2 Year Warranty
- \$299 Suggested Retail

Small Wonder From



450 Esna Park Dr.
 Markham, Ontario, Canada L3R 1H5
 TELEX 06-966640 (CMC - MKHM)

Technology you can Trust.

*This Lotus logo is used by permission of Lotus Development Corporation.

The Graphics Solution has successfully passed compatibility testing with 1-2-3 (2.0) and Symphony (1.1) on an IBM PC-XT with PC-DOS 3.1. The Graphics Solution must be installed.

requests be converted into two 8-bit requests to the motherboard. This is done by a combination of buffers and latches—controlled by the main accelerator logic—that idles the 8086 for sixteen 9.54-MHz clock cycles while it generates two 8-cycle I/O requests to the motherboard. These requests are synchronized with the PC 4.77-MHz clock, which interprets them as two normal 4-cycle requests. The control circuit must also generate 8088 status signals whose job is to keep the PC motherboard asleep during 9.54-MHz operation and turn it on during emulation cycles.

All normal I/O cycles need servicing and include memory reads and writes, I/O reads and writes (to ports), and DMA requests made by the DMA controller on the PC's motherboard. DMA requests can be complicated. You can't boot a PC unless it has memory on its motherboard, so you have to leave some memory in the

PC's motherboard. Also, the DMA controller on the motherboard will see this memory in the normal course of events. This brings up an interesting situation.

What happens if the DMA controller does a read of memory in the case where that memory resides both on the motherboard and on the accelerator? The answer is that, unless both the 8- and 16-bit memories contain the same information, there will be a battle over the bus and the board that has the stronger drivers will win. Two techniques exist for eliminating this conflict. Whenever you write to an address that is populated on the motherboard and the accelerator, you do a simultaneous write to both. This will result in a small reduction in speed for programs that write frequently to low memory; you can almost eliminate it if you limit low memory to 64K bytes or fill it up with a utility such as a RAM disk.

The other solution is to duplicate the four DMA high address bit registers that the PC has on its motherboard with a similar set of registers on the accelerator and then write a phony value into the registers on the motherboard that points to an address for which the motherboard has no RAM. Without proper DMA control, neither your floppies nor your hard disk will work. If the emulator accelerator you purchase does not have a DMA test program, you could be asking for trouble. Make sure you test system DMA if possible and, if you cannot, start off with floppies only or back up your hard disk.

Whenever the speedup board reads or writes to the motherboard or I/O channel, the data-bus bandwidth falls back to that of the PC's original 8088. However, in most programs the number of emulation cycles that have to be run is very small. To help reduce this count, many emulators have a feature that maps the highest 64K-byte bank of memory on the board into bank F of the 8086 address space. After this is done, a software routine moves the contents of the motherboard ROMs to RAM. This typically results in a factor of three speed increase in interpreted BASIC programs and some I/O, especially screen I/O. Of course, this technique also reduces the amount of 16-bit memory available for DOS from 640K to 576K bytes, but it is usually worth it. In cases where memory is dear, it is possible to place a bank on another board in the I/O channel or buy an emulator that can be populated over 640K bytes.

Figure 1 shows the memory-mapping scheme for a 1-megabyte accelerator that I designed. This board uses a 16-bit register to control how memory is mapped. When a bit in the register is on, the corresponding bank will reside on the 8-bit side of the machine. When a bit is off, the bank is on the accelerator. For example, if all the bits are off, all the memory in the system is on the accelerator.

This brings up an intriguing question: What prevents this system from

(continued)

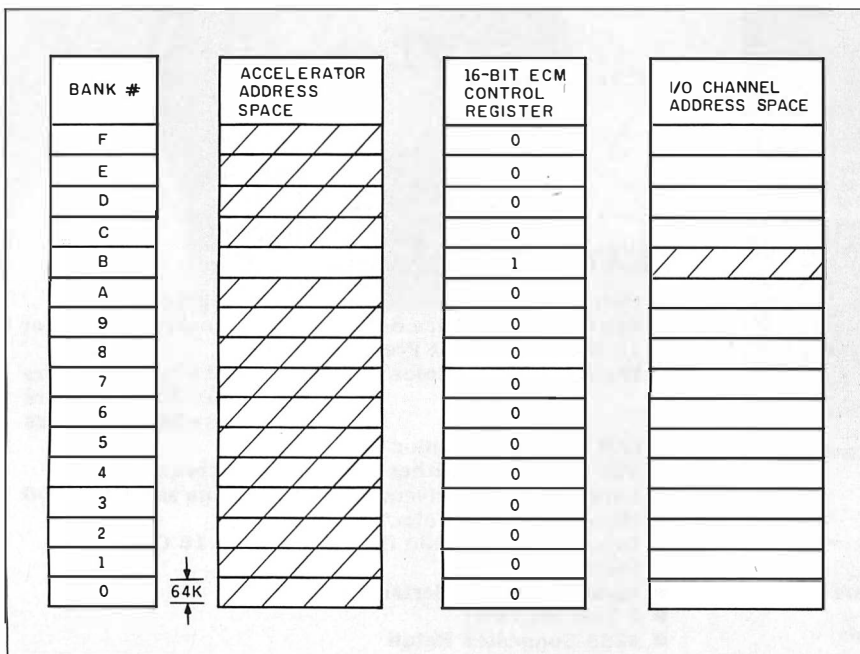

Figure 1: Extended Conventional Memory uses a 16-bit register to partition the 8086's address space from that of the I/O channel. Each register bit controls whether a corresponding 64K-byte bank of the address space is on board the accelerator or in the I/O channel. The register in this figure shows the state of the machine when a 1-megabyte DOS partition has been interrupted to read or write to a graphics adapter that is addressed through bank B. If an Enhanced Graphics Adapter were being written to, the driver would have to switch both banks A and B. (The cross-hatched areas indicate currently active banks.)

A GREAT DEAL JUST FELL INTO YOUR



This is the one you've been waiting for. The remarkable new BONDWELL 8.™ At \$1595.00 retail, it is the lowest priced IBM compatible lap-sized portable computer on the market today.

It's a great deal for a small price. With built-in features that include 512K RAM, 720K 3½" drive, modem, back-lit LCD display, parallel and serial

ports, composite and RGB outputs, real time clock and AC adapter.

High performance value. It's what you expect from Bondwell's entire line of desktop, transportable, and lap portable computers.

Order your BONDWELL 8 today at (415) 490-4300. Don't let a great deal slip through your fingers.



ONE BETTER

running with a DOS that has 1 megabyte available to it? The answer is: not very much. The key is a little software routine that traps screen I/O requests to the ROM BIOS and swaps the graphics-adaptor memory in and out as needed (i.e., turns on bank B by writing to the memory-control register with bit B set on). You also must change the value of the DOS memory size byte (in low memory) and then call for reboot with INT 19h. I make this sound a little easier than it is. You also have to worry about resizing DOS back to 640K or 704K bytes, moving

hard disk drivers out of the way, overwriting BASIC, and so on. However, all these problems are surmountable and result in a DOS that has 1016K bytes available to it. In fact, the only memory not available is the 8K bytes taken up by the ROM BIOS in high memory.

I call this technique Extended Conventional Memory (ECM). (Figure 2 shows the block diagram of an accelerator incorporating ECM.) It works well with applications generated by existing FORTRAN, BASIC, and C compilers that do not address the

screen directly (i.e., that use DOS or INT 10h). Since most applications compiled by end users fall into this category, this board is a useful partial solution to the memory squeeze play. However, ECM will work only with applications like Lotus 1-2-3 and large memories if the screen drivers are modified to swap bank B before and after every screen operation. In the case of Lotus 1-2-3 and most products that have separate screen drivers, this job is not a big one. Fortunately, if a product does not work with ECM and it does not pay to patch it, you can

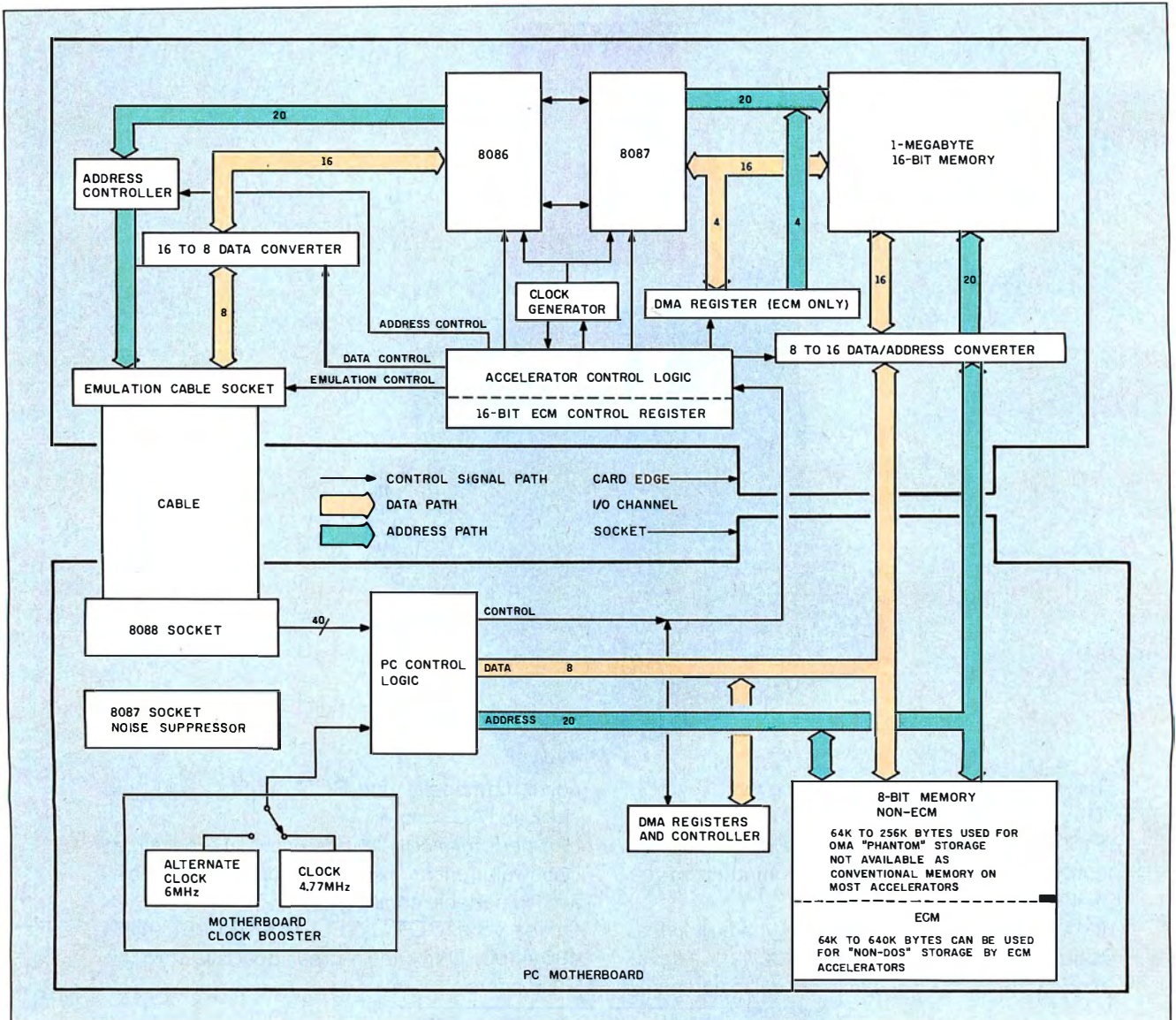

Figure 2: The block diagram for an accelerator board design incorporating the Extended Conventional Memory scheme.

always reboot the board to a 640K- or 704K-byte machine. The memory-control register also makes it possible to use the memory on your motherboard and in your I/O channel for I/O utilities such as RAM disks, print spoolers, and disk caches.

Another popular form of emulator uses cached memory instead of real memory. Cached memory is composed of fast static RAMs and is usually small. The theory behind cached memory is to save money on fast RAM by using a small, very high speed cache for tight program loops. In normal practice, this means placing a small cache inside the processor itself. For normal accelerators, there is no cost issue involved in buying faster RAM. The same 150-nanosecond devices that work on your motherboard at 4.77-MHz work fine on a 9.54-MHz 16-bit accelerator.

What is the issue then? First, duplicating existing RAM. Some people like to think that the 256K to 640K bytes that they paid dearly for two years ago is still worth something. The second issue is space. It is possible to build a half-size accelerator without going to semicustom chips if you use a cache instead of true RAM. As an advocate of true RAM, I believe that having all your memory set up as 16 bits instead of 8 guarantees that all CPU operations speed up at a reasonable incremental cost. The 36 chips that make up a megabyte these days cost about \$80 as compared with six 55-ns static RAMs that cost \$42. The other benefit of a megabyte of RAM on an accelerator is that you can do other things with it, like ECM.

I will now examine how cache is used in an emulator. The theory is simple: Well-written programs spend 90 percent of their time in 10 percent of the code. If this code is mostly in a small fast memory that has to be updated only when you pass out of the hot code (the 10 percent that runs the most), you have a cost-effective way of building a system that minimizes the use of expensive fast RAM. The 90 percent/10 percent principle for programs reads a little differently at the machine level. What typically hap-

pens is that a small number of routines that are several hundred bytes long become the hot areas. The key to designing a cache is to figure out where these areas are, keep them in the cache, and go to slower system memory only when other information needs to enter the processor.

This is easier said than done. In practice, you don't examine a program to decide what to cache and what not, but you build a machine that automatically brings information into the cache whenever it is needed but is not already in the cache. In this way, the sections of a program that are hot will end up in the cache because they repeat (i.e., if the cache is long enough, they will still be in the cache from the previous access).

Caching is accomplished via elegant schemes, one of which is called a write-through cache. An 8K-byte write-through cache is composed of three parts: a linear array of static RAM that is organized as 4096 sixteen-bit words, 4096 tag bytes, and logic that is capable of comparing the tag bytes with the address bus to determine whether the cache contains the data of interest. The entire 1-megabyte address space of the processor is mapped onto this 8K-byte area using a simple technique.

When the 16-bit processor on the accelerator accesses a word, the lowest 12 bits are used to index into the tag array, and the 8-bit value of the tag is then compared against the highest 8 bits on the address bus. A match means that the 16 bits of data in the cache at the index location are valid and the processor is passed these bytes. This is called a cache hit. If the tag does not agree with the address bus, the value in the cache is incorrect and that causes an 8088-emulation cycle that reads 16 bits of data from the motherboard. When this information comes up, it is simultaneously read into the processor and the cache, and the tag for the address in question is changed. Any write from the processor to memory automatically writes to both the cache and the motherboard; this is the write-through. In this scheme, the data-bus

bandwidth between the processor and cache memory is 100 percent for repeat reads of the cache. Memory reads that miss the cache and writes run at the speed of the 8088.

For the 7.2-MHz 80286 cache board used in the benchmarks, the data-bus bandwidth between the processor and the cache was 6 times that of the 8088 in a PC. Assuming that the cache were to be hit 5/6 of the time (82 percent), this would result in an overall bandwidth that was three times that of a PC. Simply stated, the misses that happen 1/6 of the time take as long to execute as the hits, since the misses run 6 times slower. This doubles the execution time, which effectively halves the data-bus bandwidth. As I will show below, the cache's no-wait-state memory is so fast that it is mostly wasted. Only about 5 percent of the instructions in a no-wait 80286 system are limited by the data bus, while nearly 66 percent are limited in a no-wait-state 80286 or 8086 system. What this means is that the high-speed data-bus bandwidth is less than 6.0, which implies that programs that hit only 82 percent of the time speed up less than 3 to 1.

The final emulator-type accelerator has no memory on it at all. The idea is simple: Increase the speed of register instructions only. This type of device is best described as an 8087 accelerator, as the 8087 is the only component that spends many more cycles on the average executing than it does reading the bus. These devices involve little logic and a small increase in speed; they plug directly into the 8088 only.

Most emulators are PC-hardware-compatible. The main compatibility problems are the result of hardware that is being driven with software that contains timing loops. For these devices, it is necessary to either slow the board up or patch the drivers. The other problem is software that knows it is on a PC and can't find an 8087 (because the system has an 80287) but knows the 8087 toggle is set to on. The best example of this problem was an early version of the Intel

(continued)

Above Board that did not take kindly to 80287s on accelerators in PCs. Another incompatible accelerator is the ECM. As long as it is running in the ECM mode, it works with all software that obeys the rules IBM set down with PC-DOS. When an application disobeys those rules, the board must be reset with software to the 640K bytes that most software expects. Clearly, it helps to have a firm grounding in the operation of both PCs and DOS to overcome the challenges that running at high speed produces.

MOTHERBOARD ACCELERATORS

The third class of accelerators is the simplest. Its members provide an alternate clock frequency for the 8088 on your motherboard (or your AT), upgrade the 8088 to an 8088-2 or NEC V20, or do both. Lately, this

group of products has become more sophisticated. One product lets you control the processor's speed by a switch and software, while another inserts wait states during I/O cycles, thus discriminating between I/O cycles and internal CPU cycles. Without wait states, it is possible to run some motherboards up to 8 MHz.

The motherboard boosters come in a number of forms. The key to their use is the PC's 8284 clock chip that is socketed in about 60 percent of the machines that IBM built. The principle is simple: Remove the chip and plug in a board that pipes new clock signals down onto your motherboard. Of course, you might not have a socket. The solution is to have a reputable repair person replace your chip with a socket. The latter is easy to do yourself, if you know what you

are doing. The risk is that you might have to replace your motherboard, a \$200 expense. If you want to get the best performance from your motherboard, buy one that is guaranteed to work at 8 MHz and is socketed. This eliminates having to remove 200-ns RAM chips from your old PC motherboard, and motherboard accelerators run faster with clones than they do with IBM motherboards.

The main problem with the inexpensive clock-upgrade approach is that it can extend the system components out of their rated timing specifications. While it is possible for the system to run at speeds above specification, it will probably be more prone to intermittent failures and crashes. In addition, it is often a hit-or-miss business figuring out exactly how far above specification a particular PC is capable of running. The uncertainty results from the fact that a PC is a real-time system, and it is possible to have rare combinations of events occur that overextend the system. On the positive side, a PC performs 200,000 to 500,000 operations per second and, except for unusual events, it should not take it long to explore its operating-phase space.

The motherboard accelerator route, if you pursue it with care, can be the most cost-effective form of acceleration. It is important to buy an accelerator that you can slow down with software or that comes with its own device drivers for the floppy and hard disks. My experience shows that, up to 6.7 MHz, your machine will either run or crash. If it crashes, you have an early PC or one built with marginal components. Above 6.7 MHz, the speed of RAMs and the quality of your floppy and hard disk controllers starts to become critical. Above 7.4 MHz, you will definitely have to slow up when you do I/O to your storage systems. This is most easily accomplished with a resident driver that traps requests to INT 13h, slows the accelerator to 4.77 MHz, waits for the I/O to complete, and then speeds back up. With such a driver, it is possible to run some motherboards up to 8 MHz. My experience shows that

Table 1: Results from runs of the Performance Index benchmark on several different accelerator boards.

Components of the PI Benchmark

Machine	Numeric Data		Data Bus		Register			Disk	
	Processor								
	1	2	3	4	5	6	7	8	9
PC 4.77	1.0	1.0	1.0	1.0	1.0	1.0	1.0	1.0	1.0
PC V20/8	1.71	1.71	1.71	1.70	3.59	5.51	1.77	1.0	1.0
PC2	2.06	2.08	4.05	4.02	2.00	2.03	2.74	.72	.76
PC2 V30	2.11	2.26	4.09	4.06	4.25	6.70	2.79	.77	.77
PC2 12	2.65	2.80	5.17	5.17	2.56	2.54	3.53	.74	.74
AT 6/4	.72	.94	3.27	3.34	3.46	7.74	2.53	3.03	1.1
AT 6/8	1.06	1.54	3.27	3.34	3.46	7.75	2.54	3.03	1.1
AT 6/10	1.15	1.77	3.27	3.34	3.46	7.75	2.54	3.03	1.1
AT 8/8	1.23	1.68	4.50	4.54	4.73	10.9	3.41	3.14	1.1
AT 8/10	1.37	1.98	4.50	4.46	4.78	10.9	3.44	3.90	1.1
PC 7/8	1.2	1.61	4.58	.99	3.19	9.1	2.18	3.0	1.0
PC 7/10	1.47	2.00	4.57	.98	6.00(b)		1.92(b)	3.2	3.9
					3.24	9.6	2.15		
					6.00(b)		1.92(b)		

Legend:

Machine	Processor	MHz	NDP	MHz
PC 4.77	8088	4.77	8087	4.77
PC V20/8	V20	8.0	8087	8.00
PC2	8086	9.54	8087	9.54
PC2 V30	V30	9.54	8087	9.54
PC2 12	8086	12.00	8087	12.00
AT 6/4	80286	6.00	80287	4.00
AT 6/8	80286	6.00	80287	8.00
AT 6/10	80286	6.00	80287	10.00
AT 8/8	80286	8.00	80287	8.00
AT 8/10	80286	8.00	80287	10.00
PC 7/8	80286	7.20	80287	8.00
PC 7/10	80286	7.20	80287	10.00

IBM motherboards top out at 7.4 MHz and good-quality clones run up to 8 MHz.

The motherboard-acceleration technique has one advantage over the coprocessor and emulator techniques: It speeds up motherboard operations, including DMA, which is not affected by the other two classes of accelerator. No matter what technique you use for accelerating, you will have some motherboard operations that detract from overall speed, so picking up the motherboard speed is a good way to bring up the system's slowest activities. When combined with an emulator or coprocessor, the motherboard accelerator forms a hybrid system that improves the performance of all the components, including the accelerator.

Using this technique, I have boosted a motherboard to 6 MHz and run a 9.54-MHz 8086 accelerator at 12 MHz. At this speed, the 8086 outperforms an 8-MHz 80286 in all but two benchmarks (see table 1). The 12-MHz 8087 on this board beats an 8-MHz 80287 by over a factor of two for the most common operations. Not all accelerators can be boosted with this technique. The two that I have successfully boosted required design changes to run at the higher speed.

For speeding up word processors or running 8087-bound applications, the motherboard accelerator is an exceptional buy. An 8-MHz V20 system does numerics faster than an 8-MHz AT and generally increases throughput by 70 percent for only \$149 (\$298 if you need to replace your old 8087).

BENCHMARKING ACCELERATORS

People buy accelerators because they want to spend less time waiting for results. Unfortunately, most are not in a position to try a number of accelerators running with their specific applications before they buy. At this point, you might be wondering if there is a simple universal benchmark comparing all accelerators and predicting the relative speed of these boards running any application. Such a benchmark cannot exist because most PC applications fall into one of

at least five different categories and, since it takes at least four measurements to gather even basic information, one benchmark could never do.

The five categories are number-bound, mass-storage-bound, data-bus-bandwidth-bound, integer-register-bound, and bound by two or more of the four processes. A sixth type of instruction, which grossly distorts many of the published benchmarks, is dominated by integer multiplies and divides; I have not included it as a category because it plays such a limited role in real programs. This is documented in my BYTE article "The 8087/80287 Performance Curve" (*Inside the IBM PCs*, Fall 1985).

In that article, I showed that for a particular accelerator running an 8086, one-third of the instructions were bound by the internal processor throughput, which is proportional to clock speed (and which I therefore call clock-bound or register-bound), and two-thirds were bound by how fast the processor could fetch new instructions (data-bus-bandwidth-bound). In particular, I found that a 9.54-MHz 8086 runs three times faster than a 4.77-MHz 8088 and that this speed could be derived using a simple theory that can be summarized as follows: The average of the speedups (two for clock-bound instructions and four for data-bus-bandwidth-bound instructions) equals the average speedup, three. In this article, a similarly interesting principle applies when there are more than two processes determining the speedup of an application: The overall increase in speed is equal to the average of the slowest and fastest processes that comprise 10 percent or more of the total instructions. This principle could be thought of as taking the average of significant extremes and throwing out processes that rarely occur.

Before I present my benchmark and findings, I want to examine a famous benchmark that reviewers and manufacturers everywhere use but which often yields anomalous results: SI by Peter Norton. This benchmark, which is part of Norton's SysInfo utility, can over- or underestimate the average

speed of a board by as much as 100 percent. The best example is the 9.54-MHz 8086 accelerator. SI usually yields a value of 2 for this processor, which, to take the benchmark literally, would imply that a 9.54-MHz 8086 is only twice as fast as a 4.77-MHz 8088. Since that is exactly equal to the increase in clock speed, an innocent application of SI generates the false conclusion that there is no benefit in going from an 8-bit to a 16-bit data bus. I know for a fact that a 9.54-MHz 8086 runs three times faster than a 4.77-MHz 8088 when executing typical applications and that all this fuss over 16- and 32-bit data buses is for real. This also tells me that SI is composed of 100 percent clock-bound operations, which is why it scales with clock speed when run on an 8086.

The NEC V20 and V30 speed up a number of clock-bound operations, such as integer multiplies, divides, and string operations. For typical applications, it is reasonable to expect a 5 to 15 percent increase in speed from the NEC V-series processors over their Intel counterparts; you can occasionally get up to a 40 percent increase when performing floating-point arithmetic without an 8087.

So what happens when I replace the 9.54-MHz 8086 with a 9.54-MHz V30? I get a jump in SI results from 2.0 to 4.0. Where SI underestimated the 8086's performance, it now overestimates the V30's performance. If SI were a true index of system speed, it would read about 3.1, not 4.0, for a V30 running at 9.54 MHz. The interesting fact that I have uncovered in SI is that it is bimodal: On the 8086 it is clock-bound, while on the V30 it becomes data-bus-bandwidth-bound. I came to this conclusion without the aid of a debugger, but I suspect from an examination of the pure benchmarks that make up PI benchmarks that SI is partially made up of block moves and integer arithmetic, two rarely used operations in compiler-generated code.

Finally, SI acts strangely on some compatibles, and it is possible to get

(continued)

speedups like 101 or different values every time you run the benchmark. In general, I would divide any advertised SI claim for an 80286 machine in half, as the benchmark was inflated by a factor of two in the first place by its sole use of operations that are rarely used and are among the slowest in the 8088 repertoire. If the manufacturer of an 80286 board claims it is 6.6 times faster than a PC, the estimate is probably based on SI, and 2.7 to 3.3 is a much better estimate. This rule does not hold for 8086 boards, which actually run faster than SI by 50 percent. In conclusion, for a benchmark to be meaningful, it must sample the mainstream of processor activities in the user's applications and it must be documented.

THE ACCELEROMETER PI

By now, I hope that you are convinced of at least three things. First, a number

of underlying processes come into play in a system. Also, an understanding of what those processes are is fundamental to using benchmarks for making system measurements. Finally, benchmarks that measure pure processes can be useful in predicting what happens in complex real-world situations. Toward that end, I designed a suite of benchmarks to measure the pure processes that go on in object-compatible Intel accelerators.

My accelerometer is called PI (see listing 1), which stands for Performance Index. It was my intention to create a program that would let users design their own complex benchmarks from a number of pure ingredients that I built into PI. The results of running PI on a number of different machines are in table 1. *[Editor's note: The Performance Index benchmark, PI.BAS, and several associated files are available on disk, in print, and on BIX. See the insert card*

following page 176 for details. Listings are available on BYTEnet; see page 4.]

PI is composed of nine standard benchmarks and two alternates that measure interesting properties of cache cards or 80286 cards with no wait states. There are four groups of benchmarks: numeric, data-bus-bandwidth-limited, register- or clock-bound, and disk-bound.

INTERPRETING THE RESULTS

Benchmarking accelerators using the PI benchmarks resulted in two points of interest: the data-bus bandwidth of the PC and that of the AT. At 4.77 MHz, an average PC clock cycle takes 210 ns, and it takes four cycles to perform a memory read or write; that is, it takes 840 ns to move a byte over the 8-bit-wide bus that results in a data-bus bandwidth of 1.19 megabytes per second. This pure band-

(continued)

“Occasionally, a utility comes along that makes a programmer's life much easier. SOURCE PRINT™ is such a program. It contributes to the programmer's job by organizing code into a legible format and by helping to organize the documentation and debugging processes.”

— PC Magazine Sept. 16, 1986

C, dBASE, BASIC, Pascal, and Modula-2 programmers: SOURCE PRINT turns source code into a complete document.

The **Index (cross-reference)** lists every occurrence of each variable, function, and procedure — by page and line, and by calling function or procedure. **Structure outlining** draws lines around your nested structures. **Automatic indentation** based on nesting level keeps your listings and source code uniform. **Nesting errors** are flagged — especially useful in dBASE and BASIC. **Multistatement BASIC lines** can be split for readability.

Informative **page headings** are generated. You can save time and paper by selecting routines for listing, and you can **extract** routines to form a new source file.

Source Print™



Comprehensive Formatting Tool
For IBM PC, AT, XT, Compatibles
Not copy protected. **\$139.00**
30-day money-back guarantee. +\$5 S/H

License for use on a single computer.
Add \$5.00 shipping/handling. Within CA add sales tax.
MC, Visa, AmEx accepted. Immediate delivery.

Aldebaran Laboratories Inc.
3339 Vincent Road, Pleasant Hill, CA 94523 (415) 930-8966

The **easy-to-use menu** includes directory scrolling. You can even search for files containing a given string.

You can get the power of SOURCE PRINT for just \$139. SOURCE PRINT handles up to 50 input files and up to 60,000 lines of source code. You also get an automatic **table of contents** and **boldface keywords**.

Order today by phone or mail.
800-257-5773 800-257-5774 (CA)
Or see your local dealer.

NEW- Special value for programmers with programs of 1000 lines or less.

COMPACT SOURCE PRINT
COMPACT SOURCE PRINT gives you all listed features except keyword boldfacing & table of contents. It works on **\$55.00** up to 1000 lines of source code. +\$5 s/h



SOURCE PRINT is a trademark of Aldebaran Labs, Inc.
dBASE is a trademark of Ashton Tate.

"USER-FRIENDLY" REDEFINED.

Now you can Control and Protect your PC Resources and make them a lot friendlier at the same time.

TheEMCEE will reduce your cost of support, increase productivity and protect your sensitive data from being viewed, altered or deleted by unauthorized users.

It will not allow access to your hard disk via a control break or a boot from A.

When you engage TheEMCEE, it brings a host of feature presentations to the show:

- **Advanced Menus**
- **System Log**
- **Network Compatibility**
- **Encryption Security**
- **Password Security**
- **Enhanced DOS**
- **Optional File Manager**

TheEMCEE takes the "oops" out of personal computing.

Instead of getting a blank screen with a DOS prompt when you turn on your machine, you get your own system of menus.

You define the menus, the user prompts, passwords, system log and encryption features, even the color, with lots of on line help there to assist you.

And you can control user access to any item on any menu using up to 99 levels of password protection for any selection.

Then, with a few keystrokes you can run any program, command, batch file, menu or hidden item.

Access files and programs in other directories or on other directories or on other drives.

If you are a user, TheEMCEE automates and simplifies your system.

If you have the responsibility for corporate PC's, TheEMCEE is the applications manager you have been looking for.

It lets you set up a friendly interface that reduces support, and at the same time provides the control and protection you need.

Now, wouldn't you like to have TheEMCEE direct your show?

And it's all yours for just \$49.95 with a money-back guarantee—what could be friendlier than that?

TheEMCEE, because it's a three ring circus in there.

\$49⁹⁵

(800) 423-9147

(213) 457-1789

TheEMCEE™
YOUR APPLICATION MANAGER.™

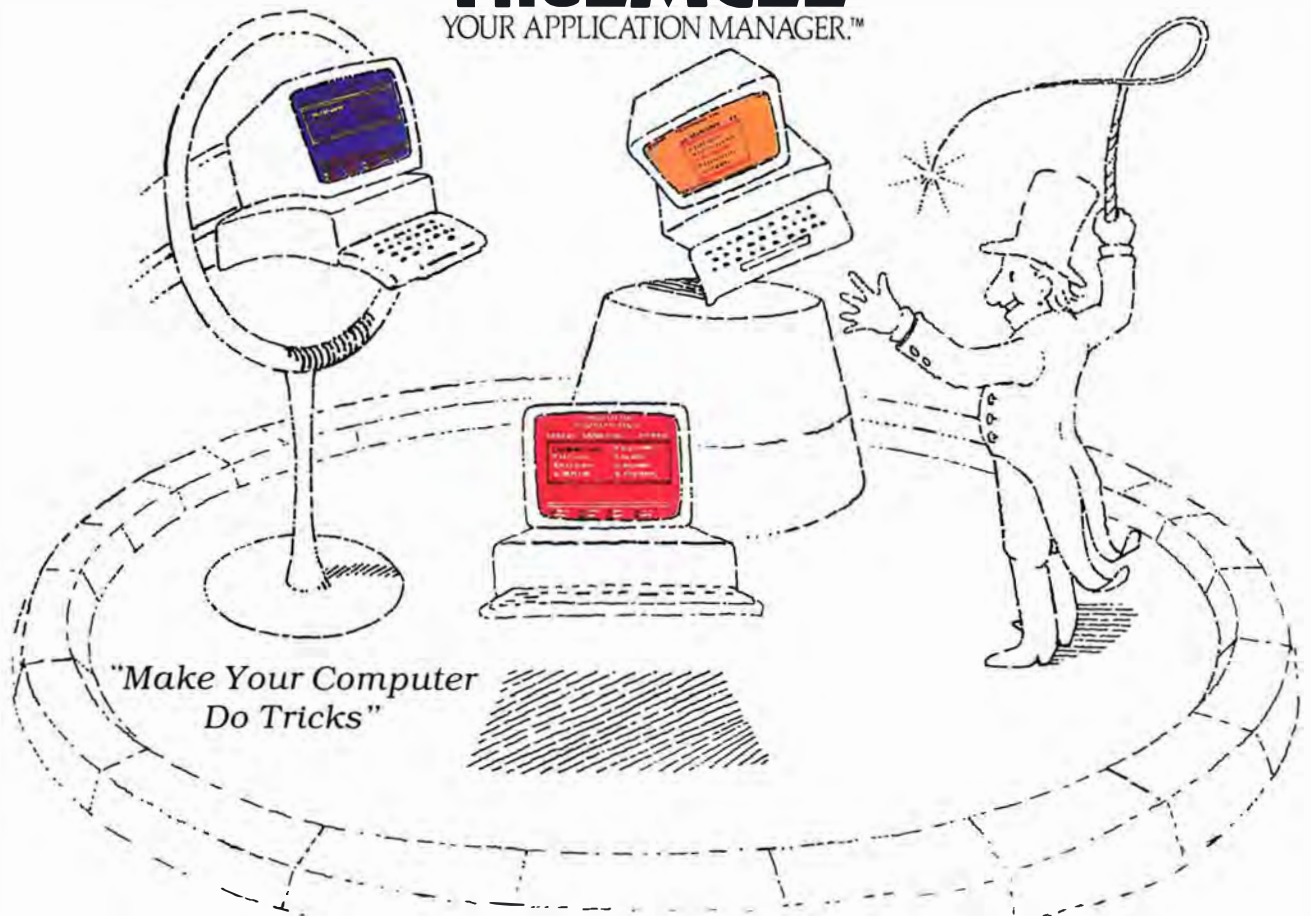

COMMAND
Software Systems

Malibu, CA

Listing 1: The Performance Index benchmark main program. This IBM BASIC Compiler (version 2.00) program calls several assembly language routines to perform the actual benchmarks. The program uses the object module TIME100 to perform the timing function.

```

10 REM PI.BAS -- Performance Index Benchmark Program
20 REM Copyright (C) MicroWay, Inc., 1986
30 REM MicroWay, Inc. PO Box 79 Kingston MA 02364 (617) 746-7341
40 REM
50 REM Does not use Numeric Coprocessor (8087 or 80287). See PI87.BAS for
60 REM a similar program which does use the Numeric Coprocessor.
70 REM Compiled with IBM BASIC Compiler V2.00 (/O switch). Linked with
80 REM assembly language subroutines:
90 REM DBB4 DBBCACHE DBB16 CB4 CB16 IA XFER TIME100
100 REM
110 DEFINT A-Y
120 DIM NAME$ (11), SECTION$ (11), ZF (11), ZP (11)
130 DIM DSRC (10249), DDEST (10249)
140 COMMON DSRC (), DDEST (), SPC1!, SPC2!, SPC3!, SVA!, SVB!
150 DEF FNS# (X$) = 60# * (60# * VAL (MID$ (X$, 1, 2)) + VAL (MID$ (X$, 4,
2))) + VAL (MID$ (X$, 7, 2)) + .01# * VAL (MID$ (X$, 10, 2))
160 LINES$ = "" : FOR I = 1 TO 69 : LINES$ = LINES$ + CHR$ (205) : NEXT I
170 PRINT CHR$ (201); LINES$; CHR$ (187)
180 PRINT CHR$ (186); " MicroWay Performance Index
Program "; CHR$ (186)
190 PRINT CHR$ (200); LINES$; CHR$ (188)
200 PRINT " Copyright (C) MicroWay, Inc., 1986."
210 PRINT " (This version does not use the Numeric Coprocessor)"
220 PRINT
230 DATA 0.6013,0.5607,0.6,0.6,0.595,0.589,0.62,0.6,0.6,0.6064,0.6064
240 DATA " 1"," 2"," 3"," 4"," 5"," 6"," 7"," 8"," 9"," 10"," 11"
250 DATA "Floating point -- arithmetic "
260 DATA "Floating point -- Savage (transcendentals) "
270 DATA "Data bus bound -- 4K bytes of instructions "
280 DATA "Data bus bound -- 4K bytes of register moves "
290 DATA "Data bus bound -- 16K bytes of instructions "
300 DATA "Clock bound -- 4K byte block moves "
310 DATA "Clock bound -- 16K byte block moves "
320 DATA "Integer multiply and divide "
330 DATA "Subroutine calls and stack operations "
340 DATA "Disk I/O -- sequential read from random file "
350 DATA "Disk I/O -- sequential write to random file "
360 DATA 25,25,11.111111,11.111111,11.111111,8.333333,8.333333,0,0,0,0
370 CALL TIME100
380 FIRSTTIME = 1
390 FOR I = 1 TO 11 : READ ZF (I) : NEXT I
400 FOR I = 1 TO 11 : READ SECTION$ (I) : NEXT I
410 FOR I = 1 TO 11 : READ NAME$ (I) : NEXT I
420 FOR I = 1 TO 11 : READ ZP (I) : NEXT I
430 MAXWRITES = 20 : MAXREADS = 20
440 GOTO 570
450 REM *** Create file so that reads will have something to work on
460 REM *** and so that writes will not have to create new records.
470 IF MAXWRITES > MAXREADS THEN MPUT = MAXWRITES : ELSE MPUT = MAXREADS
480 OPEN "TEMP.TMP" FOR RANDOM AS #1 LEN=2048
490 FIELD #1, 2048 AS S$
500 T$ = "" : FOR I=0 TO 1023 : T$ = T$ + MKI$ (256 * RND (I)) : NEXT I
510 LSET S$ = T$
520 FOR I = 1 TO MPUT : PUT #1, I : NEXT I : CLOSE #1
530 PRINT "Please enter percentage of benchmark devoted to each operation."
540 FOR I = 1 TO 11
550 PRINT "Section ";SECTION$ (I);" ";NAME$ (I);": "; : INPUT "", ZP (I)
560 NEXT I
570 ZT = 0 : FOR I = 1 TO 11 : ZT = ZT + ZP (I) : NEXT I
580 IF ZT > 99.5 AND ZT < 100.5 THEN GOTO 640
590 PRINT : PRINT "Caution: percentages total "; ZT;
600 INPUT " Adjust to 100% ? ", ADJ$ : PRINT : ADJ$ = LEFT$ (ADJ$, 1)

```

(continued)



The data you'll have to depend on tomorrow could depend on the disk you choose today.



BASF QUALIMETRIC™ 5.25" FLEXYDISKS®. CERTIFIED 100% ERROR-FREE AND WARRANTED...

F O R E V E R

```

610 IF ADJ$ = "Y" OR ADJ$ = "y" THEN GOTO 630
620 IF ADJ$ = "N" OR ADJ$ = "n" THEN GOTO 660 : ELSE GOTO 600
630 IF ZT = 0! THEN GOTO 840
640 Z100 = 1# / ZT : FOR I = 1 TO 11 : ZP (I) = ZP (I) * Z100 : NEXT I
650 ZT = 100# : GOTO 670
660 FOR I = 1 TO 11 : ZP (I) = .01 * ZP (I) : NEXT I
670 PRINT "Section          Description          Performance
Index"
680 PRINT "=====
=====
690 ZTET = 0# : FOR J = 1 TO 11
700 ZITER = 60# * ZP (J) / ZF (J)
710 ITER = INT (ZITER) : IF ZITER - ITER > .1 THEN ITER = ITER + 1
730 ON J GOSUB 930,970,1000,1010,1020,1030,1040,1050,1060,1070,1140
740 ZET = FNS# (B$) - FNS# (A$)
750 IF ITER <> 0 THEN ZET = ZET * ZITER / ITER : ELSE ZET = 0#
760 PRINT " ";SECTION$ (J);" ";NAME$ (J);" ";
770 IF ZET = 0 THEN PRINT " ----" : GOTO 790
780 PRINT USING "###.##"; ZF (J) * ZITER / ZET
790 ZTET = ZTET + ZET
800 NEXT J
810 PRINT : PRINT "Performance index for entire benchmark is ";
820 IF ZTET = 0 THEN PRINT "not meaningful." : GOTO 840
830 PRINT USING "###.##"; .6# * ZT / ZTET
840 PRINT
850 INPUT "Would you like to run again, specifying the section weights
yourself? ", MORE$ : MORE$ = LEFT$ (MORE$, 1)
860 IF MORE$ = "Y" OR MORE$ = "y" THEN GOTO 900
870 IF MORE$ = "N" OR MORE$ = "n" THEN GOTO 880 : ELSE GOTO 840
880 IF FIRSTTIME > 1 THEN KILL "TEMP.TMP"
890 END
900 PRINT : FIRSTTIME = FIRSTTIME + 1
910 IF FIRSTTIME = 2 THEN GOTO 450 : ELSE GOTO 530
930 A$ = TIME$ : FOR I = 1 TO ITER : ZA# = 0# : FOR K = 1 TO 114
940 ZB# = (ZA# + 1#) * (ZA# + 2#) / (ZA# + 3#) + (ZA# + 2#) * (ZA# + 3#) /
(ZA# + 1#) + (ZA# + 3#) * (ZA# + 1#) / (ZA# + 2#)
950 NEXT K : NEXT I : B$ = TIME$ : RETURN
970 A$ = TIME$ : FOR I = 1 TO ITER : ZA# = 1# : FOR K = 1 TO 9
980 ZA# = TAN (ATN (EXP (LOG (SQR (ZA# * ZA#)))))) + 1#
990 NEXT K : NEXT I : B$ = TIME$ : RETURN
1000 A$ = TIME$ : FOR I = 1 TO ITER : CALL DBB4 : NEXT I : B$ = TIME$ :
RETURN
1010 A$ = TIME$ : FOR I = 1 TO ITER : CALL DBBCACHE:NEXT I: B$ = TIME$ :
RETURN
1020 A$ = TIME$ : FOR I = 1 TO ITER : CALL DBB16 : NEXT I : B$ = TIME$ :
RETURN
1030 A$ = TIME$ : FOR I = 1 TO ITER : CALL CB4 : NEXT I : B$ = TIME$ :
RETURN
1040 A$ = TIME$ : FOR I = 1 TO ITER : CALL CB16 : NEXT I : B$ = TIME$ :
RETURN
1050 A$ = TIME$ : FOR I = 1 TO ITER : CALL IA : NEXT I : B$ = TIME$ :
RETURN
1060 A$ = TIME$ : FOR I = 1 TO ITER : CALL XFER : NEXT I : B$ = TIME$ :
RETURN
1080 IF ITER = 0 THEN A$=TIME$ : B$=A$ : RETURN
1090 OPEN "TEMP.TMP" FOR RANDOM AS #1 LEN=2048
1100 FIELD #1, 2048 AS S$
1110 A$ = TIME$
1120 FOR K = 1 TO ITER : FOR I = 1 TO MAXREADS : GET #1, I : NEXT I : NEXT K
1130 B$ = TIME$ : CLOSE #1 : RETURN
1150 IF ITER = 0 THEN A$=TIME$ : B$=A$ : RETURN
1160 OPEN "TEMP.TMP" FOR RANDOM AS #1 LEN=2048
1170 FIELD #1, 2048 AS S$ : LSET S$ = T$
1180 A$ = TIME$
1190 FOR K = 1 TO ITER : FOR I = 1 TO MAXWRITES : PUT #1, I : NEXT I : NEXT K
1200 B$ = TIME$ : CLOSE #1 : RETURN

```



The data that can fit in your
pocket today can have an
impact on what goes into
your pocket tomorrow.



BASF



BASF QUALIMETRIC™ 3.5" MICRO FLEXYDISKS.® CERTIFIED 100% ERROR-FREE AND WARRANTED.

FOR EVER

width is degraded by the DMA controller, which runs 7 percent of the time refreshing memory, resulting in an actual bandwidth of 1.10 megabytes per second.

On the other hand, the AT has a 16-bit bus and a cycle time at 6 MHz of 167 ns. Its 80286 normally takes only two cycles to perform a memory

operation, but in the AT it was set up with a single wait state, resulting in a total memory-fetch time of 500 ns. The rate of 2 bytes every 500 ns is the same as 4 bytes every microsecond or 4 megabytes per second. In the case of the AT, only 5.3 percent is lost to refresh, resulting in a net bandwidth of 3.78 megabytes per second.

Dividing these rates yields a PI for the AT in this department of 3.44, which is close to the 3.27 actually observed for the AT running at 6 MHz in table 1. The experimental difference could be attributed to inaccurate information from IBM on the refresh overhead, loop overhead, or system-background operations, such as timer-interrupt routines. Using the same benchmark on the 9.54-MHz 8086 accelerator running on a PC, I got 4.02, which agrees well with the 4.0 I would expect upon doubling the data-bus width and frequency.

I obtained this benchmark using an assembly language subroutine that did a large number of fast-running 8086 operations. By definition, any operation whose binary machine code takes longer to fetch from memory into the processor than it does to run will end up producing a data-bus-bandwidth-limited situation (i.e., the speed of the sequence is controlled by how fast you can fetch in op codes). The criterion of which operations are data-bus-bandwidth-limited is an easy one, but it is also machine-dependent. The PC takes four cycles to fetch a byte; therefore, any operation whose instruction is a byte long must execute in less than four cycles. Two byte-long instructions must execute in less than eight cycles, etc. The AT takes three cycles to fetch a word, and the criterion for a 2-byte instruction is that it take three cycles to execute to remain under the fetch time. When I apply this reasoning to a cached board with no wait states, I come to the conclusion that very few of the instructions are bus-limited, for I must be able to execute byte-long instructions in one cycle (there are none) and word-long instructions in two cycles. As a result, I rewrote the data-bus-limited benchmark so it would work with no-wait-state 80286 boards. Listing 2 shows the code stream of the original benchmark.

Listing 2's sequence of instructions was repeated to build a 4000-byte-long sequence that was then called as a subroutine. These instructions are all bus-limited for an 8088, 8086, or

(continued)

“With Watson, I can make 50 cold calls a day without picking up the phone.”

Paul Gilpin
Independent insurance agent
Burlington, MA

While Paul Gilpin is out servicing clients, his Watson is doing something every agent hates: making cold calls. Watson automatically dials prospects, delivers a high-quality, digitally recorded sales message, and records responses. And impressive sales results. A multi-purpose voice processing option for IBM PC, XT, AT, and compatibles, Watson has a base price of \$498.

For an ear-opening demo on how Watson can help you manage business communications better, dial 1-800-6-WATSON. In Mass., (617) 651-2186.



Watson™

Natural MicroSystems Corporation

Watson is a trademark of Natural MicroSystems Corp. IBM PC, XT and AT are trademarks of International Business Machines Corp.

This is BEFORE LETTRIX.
This is AFTER LETTRIX.



Teach Your Printer Some Manners with

LETTRIX

"Most users will be on their knees giving thanks for all of the new print features Lettrix provides for less than \$100."
*Peter Lewis
The New York Times*

Are you embarrassed to have your dot-matrix print seen in public? With LETTRIX you get well-groomed, letter-quality text directly from your current software. Without buying a new printer. LETTRIX gives your software the social graces of five size options, the flexibility of 21 sharper fonts (including Greek, Cyrillic, and Hebrew), a plethora of formatting options, even the ability to design your own types. LETTRIX resides in memory and

can be used at will, without the pampering needed to make "Font," "Print" or "Paint" programs work. Equally at ease with 1-2-3 or dBase, WordStar or WordPerfect, Multimate or Microsoft Word, LETTRIX mingles comfortably with

most DOS software. Best of all, LETTRIX is a pleasure to talk to, since it understands your own software's formatting commands - and lets you add new ones as well. For instance LETTRIX can add boldfacing, italics, underlining, and the typefaces below to a 1-2-3 spreadsheet or a dBase report. LETTRIX requires an IBM PC, PC Jr., XT, AT or compatible running PC-DOS (2.0 or later) or MS-DOS (2.11 or later) and occupies 60kb of RAM memory.

LETTRIX sharpens dot printing from most software in 20 typefaces:

- | | |
|--|--|
| Roman
Park Avenue
SHADOW
Courier
BANKER
Gothic
Español
Français
Русский
Ελληνικός
עברית | Broadway
WESTERN
Old English
ABCDEF GHIJK
Art Deco
Engraved
OUTLINE
Prestige
Folio
ORATOR
OCR-A |
|--|--|

Yes, I want to teach my printer some manners. Please send me _____ copies of LETTRIX at \$98.50 each with your ten-day money-back guarantee. My printers are:

- Star
- Panasonic
- AT&T 473, 474
- Okidata (IBM Graphics Configuration)
- Epson MX, RX, FX, LX, JX
- IBM Graphics Printer, Proprinter

I am paying by: ● VISA ● MasterCard ● Check ● C.O.D.

Call toll-free: (800) 351-4500
In Connecticut: (203) 624-0000
to order or to request our free print sample.

Hammerlab Corporation
938 Chapel Street
New Haven, CT 06510
Hammerlab accepts corporate, institutional, and governmental purchase orders by mail.

Listing 2: The assembly language code for the data-bus-bandwidth benchmark.

Op code		Number of bytes	Number of cycles
XOR	AX,AX	2	3
XOR	DX,DX	2	3
ADD	AX,DX	2	3
ADD	AX,DX	2	3
SUB	AX,DX	2	3
SUB	AX,DX	2	3
CLC		1	2
CLD		1	2
NOP		1	3
NOP		1	3

80286 with one wait state but are not bus-limited for a no-wait-state 80286. To reexamine the bus limit in this card, I replaced this 10-byte sequence with a 10-byte sequence of

```
MOV AX,BX
```

which obeys the criterion. Then I labeled this benchmark 3b. It takes a cached board at 7.2-MHz two cycles or 277 ns to read in a word. The same process in a PC takes eight cycles or 1680 ns. The ratio of these times is 6.06, which agrees very well with the value of 6.0 for the cache board. In the process of creating this benchmark, I have also learned that only one kind of instruction, interregister moves, is bus-limited in the cached board.

The data-bus-bandwidth benchmark teaches us a lot about 80286 machines. As the data bus goes from one wait state to no wait states, the data-bus activity starts to dry up. Watched on a scope in a six-line loop, the processor performs a flurry of fetches and then goes into an idle state for quite a while as the program works its way back to the bottom of the loop. From a designer's point of view, this means that a no-wait-state board does not exhibit the optimal distribution of data-bus speed to register speed. If memory fetches are done consistently faster than register-bound operations and fast memories cost a lot of money, you would do just as well with slower-speed memories that provide the needed instructions just as the register-bound operations complete. Put in other terms, I think the IBM one-wait-state approach might be

near optimal for 80286 machines that are not bogged down with DMA cycles, and the hoopla about no-wait-state memories could very well be a lot of nonsense.

This idea is also highlighted in the *iAPX 286 Hardware Design Manual*, which points out that with no wait states the bus is idle 75 percent of the time, versus 90 percent with one wait state. This document also states that the main beneficiary of no-wait-state memories is block moves. Block moves get used primarily in I/O-intensive applications such as RAM disks and disk caches. It is unlikely that the added speed they represent would make much of an impact on typical single-user applications, although they might make a difference in multiuser operating systems. Unfortunately, when run in protected mode on an 80286, these operating systems will become more register-speed-dependent (a feature of protected mode); that would again argue against ultra-fast memories to improve overall throughput.

CONCLUSION

Accelerators have been available for the IBM PC for three years. They are a cost-effective method to either speed up or extend the architecture of the computer. Extended architectures range from adding new CPUs to increasing the memory available for MS-DOS 3.0. Three types of accelerators were discussed in this article. Of these, the emulator approach is the most compatible and reliable and the route that provides the largest benefit-to-cost ratio for the average

user. Speedup factors of two to three can be obtained using emulators for as little as \$500, depending on the amount of 16-bit memory that the board contains. For most users, a \$500 accelerator that triples the speed of everything from word processing to FORTRAN applications is more than a good deal, it's addicting; users get mad if they have to put the original 8088 back in.

Accelerators that give more than a 3 to 1 increase in speed also suffer from increased incompatibility and installation problems. I found that going from 9.54 MHz to 12 MHz quadrupled the number of problems I had with emulator installations. If you are contemplating an 8086 emulator that runs faster than 9.54 MHz or an 80286 cached emulator that runs faster than 7.2 MHz, it's a good idea to make sure that the product in question has a provision for running at slower speeds as well. Software-controlled speed is a real benefit at the highest speeds: It is easy to trap the hardware interrupts that control specific devices in the PC and thereby tailor the accelerator to the slow I/O boards or a poor DMA controller on an older motherboard.

The users of accelerators have a tendency to cluster around certain type of products. Individuals running intensive, floating-point-bound problems end up with 8086/8087-based emulators, and these have a tendency to get a reputation for being math-only accelerators, which they are not. Individuals who are doing word processing or program development have recently been heading toward the 80286 cache boards. For I/O-bound applications such as code development, the I/O software utilities that come with an emulator often contribute as much to the speed as the increase in CPU throughput. The factor of two to four that a disk cache adds to hard disk access speed drowns out any difference between the 8086 and the 80286. Finally, there is the support issue. Good support direct from the manufacturer is more critical with accelerators than with any other type of add-in card. ■

Unforgettable.



Disc drives should never forget one thing:
your important information.

At Seagate, we build our drives to protect
your data against all mishaps. And we put
each drive through a series of grueling tests
to make sure it doesn't forget.

That's why quality-conscious customers
have bought more than 3 million of our
5 1/4" hard disc drives.

So the next time you're looking for a new
computer, disc memory upgrade or add-on,
ask for Seagate by name.

It's all you need to remember.

Seagate Technology, 920 Disc Drive,
Scotts Valley, CA 95066. 800-468-DISC.
In California, 800-468-DISK.

 **Seagate**



LOTUS/INTEL/MICROSOFT EXPANDED MEMORY

This version of bank-switched memory provides a uniform software interface to all applications regardless of hardware differences

BY RAY DUNCAN

THE LOTUS/INTEL/MICROSOFT Expanded Memory Specification (EMS) 3.2 is a functional definition of a bank-switched memory-expansion subsystem made up of hardware expansion modules and a user-installable, resident driver program specific for those modules.

Bank switching is a technique whereby the central processor can make one of many *logical* memory pages available for access in a window at a predetermined physical address. It's somewhat like bringing one card to the top of the deck where you can read it.

Bank-switched memory is hardly a new idea. It has been used on Apple and 8080/280 S-100 bus computers since the early days of microcomputing to overcome the addressing limitations of the 8-bit processor. For the IBM PC, Tall Tree Systems has been selling a bank-switched memory board called JRAM with electronic disk and print spooler software for several years. But the LIM EMS version of bank-switched memory is a step ahead: It provides a uniform software interface to all applications, regardless of the differences in the underlying hardware. LIM EMS is not, however, the only memory-expansion subsystem available. See the text box "The AST Enhanced EMS" on page 170.

From a hardware standpoint, EMS allows you to install as much as 8 megabytes of expanded memory in a system. This expanded memory is available to application software in 16K-byte logical pages, which are mapped for access onto one of four 16K-byte physical pages. These physical pages exist in a contiguous 64K-

byte area called the *page frame*. You can configure the location of the page frame to avoid conflict with other hardware options, but it always resides above the MS-DOS/PC-DOS main memory area (0K to 640K bytes).

Expanded memory should not be confused with *extended* memory. Extended memory is IBM's term for the memory at physical addresses above 1 megabyte that an 80286 microprocessor can access in protected mode. Current versions of MS-DOS run the 80286 in real mode (8086-emulation mode), where extended memory is not directly accessible.

The EMS installable driver, called the Expanded Memory Manager (EMM), provides the hardware-independent interface between application software and expanded-memory hardware. The EMM comes as an installable character device driver that links into the operating system by adding a DEVICE line to the CONFIG.SYS file.

Internally, the EMM is divided into two major sections: the driver and the manager. The driver mimics some of the actions of a real device driver; it includes initialization and output-status functions and a valid device header. The manager is the true interface between application software and the expanded-memory hardware. The EMM provides several classes of services:

- Status of hardware and software modules
- Allocation of expanded-memory pages
- Mapping logical pages into the physical page frame

- Deallocation of expanded-memory pages
- Support for multitasking operating systems
- Diagnostic routines

Application programs communicate with the EMM directly via software interrupt 67h. MS-DOS is not involved. However, Microsoft Windows (which runs on top of MS-DOS) makes heavy use of expanded memory, if it is present, for program swapping. It seems reasonable to expect that future multitasking versions of MS-DOS and other operating systems for the 8086/88 family may do the same.

USING EXPANDED MEMORY

Expanded memory is a system resource and must be treated like one. Application programs must acquire, use, and release expanded memory in a manner that doesn't cause problems for other programs that are trying to use it.

Before you use expanded memory, you must determine that the EMM is present in the system. There are two approved methods of testing for the existence of the EMM.

The first method is to issue an open request (interrupt 21h, function 3Dh) using the device name of the EMM driver: EMMXXXX0. If the open succeeds, either the drive is present or there is a file on the default drive by that name. To rule out a duplicate file-

(continued)

Ray Duncan is the founder and president of Laboratory Microsystems Inc. (P. O. Box 10430, Marina del Rey, CA 90295). An M.D., he is also a columnist for Dr. Dobb's Journal and the author of Advanced MS-DOS (Microsoft Press).

The ultimate time saving
input device for IBM PC!

KEYPORT 60

60 Programmable
Function Keys!

Polytel's programmable multifunction keypad, the KEYPORT 60, is your key to one-finger pushbutton software.



The KEYPORT 60 by Polytel is your
Productivity Booster—one keystroke
instead of many!

- ★ Every key fully programmable
- ★ Label the keys so you never forget which key does what
- ★ Ideal for entering repetitive commands with a single touch.
- ★ No need to memorize hard-to-remember command sequences.
- ★ Includes ready-to-go templates for DOS, WordStar, Lotus 1-2-3, and BASIC.
- ★ Runs on IBM PC, XT, AT, and compatibles
- ★ Connects to game port—leaves your other ports free
- ★ Does not interfere with normal operation of regular keyboard.
- ★ 60-day money back guarantee—no risk to you.

★ ★ ★ ★ Price—\$139 ★ ★ ★ ★
(add \$6 shipping for each Keyport)

— SPECIAL OFFER —
Game port included!
A \$45 value!

To order, call Polytel at

1-800-245-6655

In California, call **1-408-730-1347**

Or send \$145 check or money order to:

Polytel Computer Products Corp.
1250 Oakmead Parkway, Suite 310
Sunnyvale, California 94086

In the UK and Scandinavia, contact

Electrone Ltd.
Haywood House, High Street
Pinner, Middlesex HA5 5QA
Tel: 01-429-2433



VISA, MasterCard & American Express
cheerfully accepted!

THE AST ENHANCED EMS

AST Research has also formulated and announced a bank-switched memory subsystem specification. The Enhanced Expanded Memory Specification (EEMS) is upward-compatible with LIM EMS version 3.2 but technically more complex.

EEMS differs from EMS in two important ways:

- In EMS, the 64K-byte page frame is located *above* the 640K-byte MS-DOS area and is used to map four different 16K-byte logical pages into physical memory simultaneously. In EEMS, as many as 64 logical pages can theoretically be mapped into physical memory at once. Practically speaking, on a typical IBM PC under MS-DOS, about 15 logical pages simultaneously mapped into memory is probably the upper limit. (This is the memory above the 640K-byte MS-DOS area minus the addresses occupied by system ROMs and video buffers.)
- In EMS, logical pages cannot be bank-swapped into the 640K-byte memory area controlled by MS-DOS, making it difficult to use expanded memory for paging executable code. In EEMS, logical pages can be mapped into physical memory anywhere in the

microprocessor's address space, making it possible for specially designed multitasking operating systems to use expanded memory for very fast switching between processes.

AST's EEMS redefines the software interfaces between the EMM and the application program (see table 2) only slightly. It extends function 5 (Map Memory) to allow physical page numbers larger than 3 and adds function 33 to allow applications to obtain a list of all the physical page addresses. For upward compatibility with EMS, EEMS requires that the first four physical 16K-byte pages be contiguous.

Although EEMS is more sophisticated than EMS and has considerably more potential if properly used by an operating system designed to exploit all its features, to date it has received little support from other PC software and hardware developers. Currently, the only commonly available programs that use EEMS are Quarterdeck Systems' DESQview and Digital Research's Concurrent DOS XM. The only other manufacturer of EEMS hardware, Quadram, has reported delays in designing a board that is simultaneously EMS- and EEMS-compatible.

name on another drive, you issue a get-output-status request via the IOCTL (input/output control) function (interrupt 21h, function 44h); the status returned in register AL will be 0FFh if the driver is present and 0h if not. Either way, you should then close (interrupt 21h, function 3Eh) the handle obtained from the open so the system can reuse it. (See listing 1.)

The second method is to use the address found in the vector for interrupt 67h to inspect the device header of the presumed EMM. If the EMM is present, the name field at offset 0Ah of the device header will contain the string EMMXXXX0. This approach is nearly foolproof and avoids the relatively high overhead of an open. However, it is somewhat less "well behaved" since it involves inspecting memory that does not belong to the application. (See listing 2.)

After establishing that the EMM is present, a typical application follows this general sequence to use expanded-memory resources:

1. Check the operational status of the EMM (EMS function 1).
2. Check the version number of the EMM (EMS function 7) to make sure that all the services that the application needs are available.
3. Obtain the segment of the page frame that the EMM uses (EMS function 2).
4. Allocate the desired number of expanded-memory pages (EMS function 4). If the allocation is successful, the EMM returns a *handle* that the application then uses to refer to the expanded-memory pages that it "owns." This is analogous to opening a file and using a handle for any

(continued)

Listing 1: *Testing for the EMM via the MS-DOS open and IOCTL functions.*

```

mov ah,3dh          ;function 3Dh = open.
mov al,0           ;mode = read-only.
mov dx,seg emm_name ;DS:DX = addr of name
mov ds,dx         ;of Expanded Memory Manager.
mov dx,offset emm_name
int 21h          ;transfer to MS-DOS.
jc emm_absent    ;open failed, driver absent
                 ;or no more handles.

                 ;open succeeded, make sure
                 ;it was not a file.
mov bx,ax        ;BX = handle for EMM.
mov ah,44h      ;function 44h = IOCTL.
mov al,7        ;subfxn 7 = get outp. stat.
mov cx,0        ;CX = bytes to read.
mov dx,offset emm_buff ;DS:DX = dummy buffer addr.
int 21h        ;transfer to MS-DOS.
push ax        ;save code from IOCTL.
               ;close file or device
               ;to reclaim handle.
mov ah,3eh      ;function 3Eh = close.
int 21h        ;BX still contains handle.
jc close_failed ;jump if error on close.
pop ax        ;now look at status code
or al,al      ;returned from IOCTL.
jz emm_absent ;if status = "not ready"
               ;then it was a file, not
               ;the expected EMM driver.

emm_present:    ;driver is present.
.
emm_absent:     ;driver absent, or no
.               ;more handles available.
.
close_failed:  ;error on close.
.

emm_name       db 'EMMXXXX0',0 ;device name for Expanded
                 ;Memory Manager
emm_buff       dw 0             ;dummy buffer for IOCTL call

```

Listing 2: *Testing for the EMM by inspecting the name field in the driver's device header.*

```

emm_int        equ 67h          ;Expanded Memory Manager
                 ;interrupt vector.
.
.
mov ah,35h     ;DOS function 35h =
mov al,emm_int ;get interrupt vector
int 21h       ;into ES:BX.
               ;assume ES:0000 points
               ;to the base of the EMM.
mov di,10     ;ES:DI = addr of name
               ;field in Device Header.
mov si,seg emm_name ;let DS:SI = addr of
mov ds,si     ;guaranteed driver name
mov si,offset emm_name ;for EMM.
mov cx,8      ;length of name field.

```



```

        cld
        repz cmpsb      ;compare strings.
        jnz emm_absent ;strings didn't match.
;
emm_present: ;driver present.
;
emm_absent: ;driver absent.
;
emm_name db 'EMMXXX0',0 ;device name for Expanded
;Memory Manager.

```

Listing 3: The sector mapping routine from the EMSDISK.ASM program. This is an example of a program mapping its internal records onto the EMS 16K-byte logical pages.

```

;
; Map into memory a logical "disk" sector from the EMS
; pages allocated to the EMSDISK.
;
; Called with: AX = logical sector number
;
; Returns: CY = clear if no error
;           AX = offset within EMS page frame
;           AX,CX,DX destroyed
;
;           CY = set if EMM mapping error
;           AX,CX,DX destroyed
;
map_sec proc near
        mov dx,0 ; divide sector no. by sectors
        mov cx,sec_per_page ; per page, to get EMS page number
        div cx ; now AX=EMS page,DX=rel. sector
        push dx ; save remainder
        mov bx,ax ; BX <- EMS page number
        mov ax,4400h ; map function, phys. page=0
        mov dx,emm_handle ; process ID for EMSDISK
        int 67h

        or ah,ah ; if EMM error, jump to return flag
        jnz map_sec1

        pop ax ; get remainder (relative sector)
        mov cx,sec_size ; remainder*sec_size to get offset
        mul cx ; into EMS logical page
        cld ; return CY=clear for no error
        ret ; back to caller

map_sec1: ; come here if EMM mapping error
        add sp,2 ; clear stack
        stc ; return CY=set for error
        ret

map_sec endp
;

```

subsequent read or write operations on it.

5. If the requested number of pages is not available, the application can query the EMM to find out how many

pages are available (EMS function 3). Then the application can determine if it can continue processing in a degraded fashion.

6. Perform mapping requests (EMS

function 5) as needed to gain access through the page frame to the expanded-memory logical pages that the application owns. Any further

(continued)

blocking, deblocking, or imposing a record structure on the expanded memory must be done at the application level. (The routine `map_sec`, which is extracted from `EMS-DISK.ASM`, is an example of such mapping. See listing 3.)

7. Deallocate the expanded-memory pages and release the EMM handle obtained earlier (EMS function 6) when it has finished using them. If the application doesn't perform this housekeeping, those pages will be unavailable to other programs until the system is rebooted.

with the EMM directly via interrupt 67h. The basic calling sequence for the EMM is shown in listing 4. In general, registers `ES:DI` are used to pass the address of a buffer or an array, and register `DX` is used to hold an EMM handle. Upon return from an EMM function call, register `AH` will contain zeros if the function was successful or an error code with the most significant bit set if the function failed (see table 1). Other values are typically returned in registers `AL` and `BX` or in a user-specified buffer. Table 2 contains a summary of the services available from the EMM.

driver that uses EMS follows the same general procedure that an application does, with a few minor variations. It may need to acquire an EMM handle and allocate pages before the operating system is fully functional. Thus, since it may or may not have MS-DOS file open, close, and IOCTL functions available, it must use a modified version of the get-interrupt-vector technique to test for the existence of the EMM.

A resident driver or an interrupt handler typically owns its expanded-memory pages on a permanent basis (until the system is rebooted) and never deallocates them. It must also save and restore the EMM's page mapping context (EMS functions 8 and 9, respectively), so it won't disturb a foreground program's use of EMS.

The EMM relies heavily on the good behavior of other software to avoid the corruption of expanded memory. If several applications that use expanded memory run under a multi-tasking manager, such as Windows or TopView, and one of them does not abide strictly by the EMM's conventions, the data of some or all of those applications may be destroyed.

THE EMSDISK PROGRAM

EMSDISK is an installable RAM disk driver for MS-DOS 2.0 or higher that uses expanded memory and the EMM services. Written in assembly language, it can emulate a fixed disk as large as 8 megabytes and store the files in expanded-memory pages for extremely fast access. It was tested on a Compaq running PC-DOS 3.1, using the Intel Above Board and its EMM version 3.3. [Editor's note: EMSDISK.ASM is available on disk, in print, and on BIX. See the insert card following page 176 for details. Listings are also available on BYTEnet. See page 4.]

Don't confuse the EMSDISK driver with the EMM driver that is provided with the expanded-memory board. The EMM is a proprietary software product of the board manufacturer. EMSDISK requires the EMM in order to operate, but the only resemblance between the two programs is that they are both user-installable device

Application programs communicate with the EMM directly via interrupt 67h. An interrupt handler or a resident

Listing 4: The calling sequence for the EMM.

```

mov  ah,function      ;AH always determines service type
.
.                    ;load other registers with values
.                    ;specific to the EMS function
.
int  67h
    
```

Table 1: EMM error codes. After a call to the EMM, register `AH` will contain a zero if the function was successful or an error code in the range 80h-8Fh.

Error Code	Significance
00	Function was successful.
80h	Internal error in the EMM software.
81h	Malfunction in the expanded-memory hardware.
82h	Memory manager is busy.
83h	Invalid handle.
84h	Function requested by the application is not defined.
85h	No more EMM handles available.
86h	Error in save or restore of mapping context.
87h	An allocation request specified more logical pages than are physically available in the system; no pages were allocated.
88h	An allocation request specified more logical pages than are currently available in the system (the request does not exceed the physical pages that exist, but some are already allocated to other handles); no pages were allocated.
89h	You cannot allocate zero pages.
8Ah	The logical page that was requested is outside the range of logical pages allocated to the handle.
8Bh	Illegal physical page number in mapping request (not in the range 0 to 3).
8Ch	The save area for mapping contexts is full.
8Dh	Save of mapping context failed because save area already contains a context associated with the requested handle.
8Eh	Restore of mapping context failed because save area does not contain a context for the requested handle.
8Fh	Subfunction parameter not defined.

drivers. (To implement EMSDISK on your system, see the text box "Putting EMSDISK to Work" below.)

EMSDISK follows the structure required of an installable block device driver under MS-DOS. For more information about the structure or programming of installable drivers, see the bibliography at the end of this article.

The EMSDISK driver contains two critical data structures: the device header and the BIOS parameter block (BPB). The device header contains linkages to the driver's routines, a device-attribute word that describes its nature and capabilities, and a link to the next installed driver in the chain. The BPB is supplied by block device drivers for use by MS-DOS and

describes the size and location of a disk's control and data areas.

EMSDISK breaks down logically into two major modules: the initialization module and the driver proper. MS-DOS calls the initialization module when it first loads EMSDISK. This module is responsible for determining whether the EMM is present, checking its version, getting the segment address of the EMM's page frame, allocating memory pages for EMSDISK, setting up the BPB, printing the program's identification message, and notifying the operating system of the amount of memory the program occupies and the number of logical disk units it supports. The initialization routine is used only once, and the

(continued)

PUTTING EMSDISK TO WORK

To assemble the source code into a usable EMSDISK driver module, you need the Microsoft Macro Assembler (MASM.EXE), the Microsoft Linker (LINK.EXE), and the EXE-to-BIN conversion utility (EXE2BIN.EXE). Put these three programs and the source file, EMSDISK.ASM, on a working disk, then enter the following sequence of instructions:

```
MASM EMSDISK;
LINK EMSDISK;
EXE2BIN EMSDISK.EXE
EMSDISK.BIN
DEL EMSDISK.EXE
```

Now copy the resulting EMSDISK.BIN file to the root directory of your system boot disk. Finally, to link the EMSDISK driver into the operating system, you need to add the line DEVICE=EMSDISK.BIN to the CONFIG.SYS file on your system boot disk. This line must occur after the line that loads the EMM (DEVICE=EMM.SYS in the case of the Intel Above Board).

If you enter the DEVICE line as given, all the available expanded-memory pages will be allocated to the EMSDISK. If you want a smaller size EMSDISK, enter the line DEVICE=EMSDISK.BIN nnnK. For example, to create an EMSDISK of 512K bytes, you would enter DEVICE=EMSDISK.BIN 512K

in your CONFIG.SYS file. If you omit the nnnK parameter, or specify more expanded memory than actually exists or is available, the EMSDISK driver will simply allocate all of the available expanded-memory pages.

When the system is booting, EMSDISK will display a message on the screen to let you know that it has installed successfully, what drive letter is assigned to it, and how much memory is allocated to it. The drive letter that is assigned to the EMSDISK depends on the number of other block devices in your system and the position of the DEVICE=EMSDISK.BIN line in the CONFIG.SYS file. Under DOS 3.x, the drive letter is made available to the EMSDISK driver in the initialization process and is printed out in the driver identification message; under DOS 2.x, you have to figure out which drive letter it is.

Finally, you can create multiple EMSDISK drives by placing multiple DEVICE=EMSDISK.BIN nnnK lines in your CONFIG.SYS file, allocating a portion of the available expanded memory on each line. Realize, however, that if you omit the nnnK parameter, the first DEVICE=EMSDISK.BIN line will allocate all the available expanded memory, and none will be left for the others.



POWERFUL, FAST, FLEXIBLE

SIMPLE operations and FAST calculations are ideal for "WHAT IF" ANALYSIS or use in meetings or during PHONE NEGOTIATIONS.

Gain new insights on loans, savings plans, IRA's, real estate contracts, leases, structured settlements and more.

NEWINT Loan Amortization - Version 1.68 set a new standard for professional quality loan amortization and projections. **\$59.95*** now only

NEWINT PLUS - Version 2.50 more than doubles the amortization functions of NEWINT Version 1.68. Select from six methods of interest computations (including any number of compoundings and any number of payments per year). NEWINT PLUS includes additional methods of loan computations, additional reporting options, unlimited creative financing options, and more. **\$95.00***

NEWINT Money Functions addresses compound interest, the accumulation of 1 per period, reversions, Inwood Factors, annuities, and the installment to amortize. Solve for present value, future value, payments, interest rate, term, and payments per year. Prints financial tables and projections. Select payments in advance or in arrears (in fact do both at the same time). Compare 1 to 3 sets of variables at the same time. Money Functions brings a new dimension to "what if" analysis. **\$49.95***

Available for over 70 different computers. Inquire.

AVAILABLE FOR	MS/PCDOS	CP/M 85	CP/M 80	APPLE II
NEWINT Ver. 1.68	YES	YES	YES	YES
NEWINT PLUS Ver. 2.50	YES	YES	-	-
NEWINT Money Functions	YES	YES	YES	-

NO INSTALLATION NECESSARY
DEALER INQUIRIES INVITED

To Order or Inquire Call
515-424-6591

VISA, MASTERCARD, AMERICAN EXPRESS
CHECK, MONEY ORDER, OR C.O.D. ACCEPTED



* All prices in U.S. Dollars - plus \$2.50 shipping to U.S. & Canada other countries \$2.00 handling + actual shipping cost - Iowa residents add 4% sales tax. NEWINT, NEWINT PLUS and NEWINT Money Functions are trademarks of Bridge Software, Ltd.

Table 2: A summary of software interfaces to application programs provided by the EMM.

Function Name	Action	Called With	Returns	Comments
Function 1: Get Manager Status	Tests whether the expanded-memory software and hardware are functional.	AH = 40h	AH = status	This call is used after the program has established that the EMM is present, using one of the techniques presented in listings 1 and 2.
Function 2: Get Page Frame Segment	Obtains the segment address of the EMM page frame.	AH = 41h	AH = status BX = segment of page frame, if AH = 0	The page frame is divided into four 16K-byte pages, which are used to map logical expanded-memory pages into the physical memory space of the 8086/88.
Function 3: Get Number of Pages	Obtains the total number of logical expanded-memory pages present in the system and the number not already allocated.	AH = 42h	AH = status BX = unallocated EMS pages, if AH = 0 DX = total EMS pages in system	The application need not have already acquired an EMM handle to use this function.
Function 4: Get Handle and Allocate Memory	Obtains an EMM handle and allocates logical EMS pages to be controlled by that handle.	AH = 43h BX = logical pages to allocate	AH = status DX = handle, if AH = 0	Equivalent of a file open function for the EMM. The handle that is returned is analogous to a file handle and "owns" a certain number of EMM pages. The handle must be used with every subsequent request to map memory and must be released by a close operation when the application is finished. The function may fail because available EMM handles or EMS pages have been exhausted.
Function 5: Map Memory	Maps one of the logical pages of expanded memory assigned to a handle onto one of the four physical pages within the EMM's page frame.	AH = 44h AL = physical page (0 to 3) BX = logical page (0...[n-1]) DX = handle	AH = status	The logical page number must be in the range (0...[n-1]), where <i>n</i> is the number of logical pages previously allocated to the EMM handle with function 4. To access the memory once it has been mapped to a physical page, the application also needs the segment of the EMM's page frame, obtained with function 2.
Function 6: Release Handle and Memory	Deallocates the logical pages of expanded memory currently assigned to a handle and then releases the handle for reuse.	AH = 45h DX = EMM handle	AH = status	This is the equivalent of a close operation on a file. It notifies the EMM that the application will not be making further use of the data it may have stored within expanded-memory pages.
Function 7: Get EMM Version	Returns the version number of the EMM software.	AH = 46h	AH = status AL = EMM version, if AH = 0	The returned value is the version of the EMS that the EMM driver complies with. It is returned encoded as BCD, with the integer part in the upper 4 bits and the fractional part in the lower 4 bits.
Function 8: Save Mapping Context	Saves the contents of the expanded-memory page mapping registers on the expanded-memory boards, associating those contents with a specific EMM handle.	AH = 47h DX = handle	AH = status	This function is designed for use by interrupt handlers and resident drivers or utilities that must access expanded memory. The handle supplied to the function is the handle that was assigned to the interrupt handler during its initialization sequence, not the one assigned to the program that was interrupted.

LISTINGS YOUR WAY!

It's easy. Now there are three ways to get source-code listings that go with BYTE articles—on disk, in print or on line.

ORDER BYTE LISTINGS ON DISK!

These magnetic disks contain listings of source code described in the issues of BYTE. Disks are available by annual subscription or as individual orders and in 11 popular disk formats. Order today!



FOR DIRECT ORDERING CALL TOLL FREE: 800-258-5485

Call: M-F, 8:30 a.m. to 4:30 p.m. Eastern Time

(603-924-9281 for New Hampshire residents)

For credit card orders only.

ORDER BYTE LISTINGS IN PRINT!

BYTE is now offering a supplement in print. In this supplement, you can now get printed versions of all source-code listings that go with BYTE articles.

LISTINGS ON DISK

BYTE listings on disk are right for you if you want to compile or run programs quickly. Disks are now available by annual subscription as well as individual orders. BYTE offers listings in 11 popular disk formats. See the order card below.

LISTINGS IN PRINT

This print supplement contains source-code listings described in the issues of BYTE. See order card below.

LISTINGS FROM BIX

(BYTE Information Exchange) By joining BIX, you can download BYTE source-code listings for no additional connect-time charges. See BIX informational ad listed in Reader Service index in this issue.

BYTE LISTINGS ON DISK

	Single Disks (one disk)	Annual Subscription (13 disks)		Single Disks (one disk)	Annual Subscription (13 disks)
IN USA:			OUTSIDE USA:		
5¼ inch:	<input type="checkbox"/> \$8.95	<input type="checkbox"/> \$69.95 (Save \$46.40)	5¼ inch:	<input type="checkbox"/> \$10.95	<input type="checkbox"/> \$89.95 (Save \$52.40)
<input type="checkbox"/> IBM PC			<input type="checkbox"/> IBM PC		
<input type="checkbox"/> Apple II			<input type="checkbox"/> Apple II		
<input type="checkbox"/> Kaypro 2 CP/M			<input type="checkbox"/> Kaypro 2 CP/M		
<input type="checkbox"/> Tandy Mod 4			<input type="checkbox"/> Tandy Mod 4		
<input type="checkbox"/> MS-DOS 8 Sector			<input type="checkbox"/> MS-DOS 8 Sector		
<input type="checkbox"/> TI Professional			<input type="checkbox"/> TI Professional		
3½ inch:	<input type="checkbox"/> \$9.95	<input type="checkbox"/> \$79.95 (Save \$49.40)	3½ inch:	<input type="checkbox"/> \$11.95	<input type="checkbox"/> \$99.95 (Save \$55.40)
<input type="checkbox"/> Apple Macintosh			<input type="checkbox"/> Apple Macintosh		
<input type="checkbox"/> Atari ST			<input type="checkbox"/> Atari ST		
<input type="checkbox"/> Amiga			<input type="checkbox"/> Amiga		
<input type="checkbox"/> HP 150			<input type="checkbox"/> HP 150		
8 inch:	<input type="checkbox"/> \$9.95	<input type="checkbox"/> \$79.95 (Save \$49.40)	8 inch:	<input type="checkbox"/> \$11.95	<input type="checkbox"/> \$99.95 (Save \$55.40)
<input type="checkbox"/> CP/M			<input type="checkbox"/> CP/M		

Please send me single disks in the format checked above for the following 1986 issues:

- | | |
|-----------------------------------|---------------------------------------|
| <input type="checkbox"/> January | <input type="checkbox"/> August |
| <input type="checkbox"/> February | <input type="checkbox"/> September |
| <input type="checkbox"/> March | <input type="checkbox"/> October |
| <input type="checkbox"/> April | <input type="checkbox"/> November |
| <input type="checkbox"/> May | <input type="checkbox"/> December |
| <input type="checkbox"/> June | <input type="checkbox"/> IBM PC Issue |
| <input type="checkbox"/> July | |

Name _____

Address _____

City _____

State _____ Zip _____ Country _____

Check enclosed MasterCard VISA

Credit Card _____

Exp. Date _____ Signature _____ Date _____

U.S. Funds enclosed (If ordering from outside the U.S. please remit in U.S. funds drawn on a U.S. bank. Thank you.)

IBM

BYTE LISTINGS IN PRINT

- IN USA:**
- January through June 1986 for only \$8.95.
- July through September 1986 for only \$6.95.
- October through December 1986 (available in November) for only \$6.95.
- All of the above 1986 issues for only \$18.00 (Save \$4.85).

- OUTSIDE USA:**
- January through June for only \$9.95.
- June through September for only \$7.95.
- October through December for only \$7.95.
- 1986 Annual Subscription for only \$21.00 (Save \$4.85).

The listings come in one convenient package. The first issue of the listings supplement will include listings for the first half of 1986. Thereafter, the list-

ings supplement will be published quarterly. Sign up now for an annual subscription and avoid the need to order every quarter.

Name _____

Address _____

City _____

State _____ Zip _____ Country _____

Check enclosed MasterCard VISA

Credit Card _____

Exp. Date _____ Signature _____ Date _____

U.S. Funds enclosed (If ordering from outside the U.S. please remit in U.S. funds drawn on a U.S. bank. Thank you.)

LISTINGS YOUR WAY!

It's easy. Now there are three ways to get source-code listings that go with BYTE articles — on disk, in print or on line.

LISTINGS ON DISK

BYTE listings on disk are right for you if you want to compile or run programs quickly. Disks are now available by annual subscription as well as individual orders. BYTE offers listings in 11 popular disk formats. See the order card below.

LISTINGS IN PRINT

This print supplement contains source-code listings described in the issues of BYTE. See order card below.

LISTINGS FROM BIX

(BYTE Information Exchange) By joining BIX, you can download BYTE source-code listings for no additional connect-time charges. See BIX informational ad listed in Reader Service index in this issue.



NO POSTAGE
NECESSARY
IF MAILED
IN THE
UNITED STATES

BUSINESS REPLY MAIL
FIRST CLASS MAIL PERMIT NO. 10 PETERBOROUGH, NH

POSTAGE WILL BE PAID BY ADDRESSEE

BYTE Listings

One Phoenix Mill Lane
Peterborough, NH 03458-9990



NO POSTAGE
NECESSARY
IF MAILED
IN THE
UNITED STATES

BUSINESS REPLY MAIL
FIRST CLASS MAIL PERMIT NO. 10 PETERBOROUGH, NH

POSTAGE WILL BE PAID BY ADDRESSEE

BYTE Listings

One Phoenix Mill Lane
Peterborough, NH 03458-9990

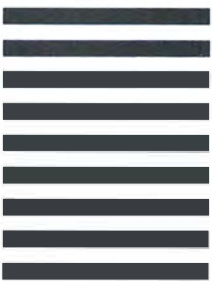

**FOR DIRECT
ORDERING (**
TOLL FREE:



Function Name	Action	Called With	Returns	Comments
Function 9: Restore Mapping Context	Restores the contents of all expanded-memory hardware page mapping registers to the values associated with the given handle.	AH = 48h DX = EMM handle	AH = status	Use of this function must be balanced with a previous call to EMS function 8. It allows an interrupt handler or resident driver that used expanded memory to restore the mapping context to its state at the point of interrupt.
Function 10 (0Ah): Reserved				This function was defined in the EMS 3.0 specification, but it is no longer documented in EMS version 3.2.
Function 11 (0Bh): Reserved				This function was defined in the EMS 3.0 specification, but it is no longer documented in EMS version 3.2.
Function 12 (0Ch): Get Number of EMM Handles	Returns the number of active EMM handles.	AH = 4Bh	AH = status BX = number of EMM handles, if AH = 0	If the returned number of handles is zero, none of the expanded memory is in use. The number of active EMM handles will never exceed 255.
Function 13 (0Dh): Get Pages Owned by Handle	Returns the number of logical expanded-memory pages allocated to a specific handle.	AH = 4Ch DX = EMM handle	AH = status BX = logical pages, if AH = 0	A single program can make several allocation requests and therefore "own" several EMM handles. The number of pages returned will always be in the range of 1 to 512—never zero if the function is successful.
Function 14 (0Eh): Get Pages for All Handles	Returns an array that contains all the active handles and the number of logical expanded-memory pages associated with each handle.	AH = 4Dh DI = offset of array to receive information ES = array segment	AH = status BX = number of active EMM handles If AH = 0, array is filled in as described in the Comments column.	The array is filled in with 2-word entries. The first word of each entry contains a handle; the next word, the number of pages associated with that handle. The value returned in BX gives the number of valid 2-word entries in the array. Since the maximum number of active EMM handles is 255, the array need not be larger than 1024 bytes.
Function 15 (0Fh): Get/Set Page Map	Saves or sets the contents of the EMS page mapping registers on the expanded-memory boards.	AH = 4Eh AL = subfunction number DS:SI = array holding mapping information (subfunctions 1 and 2) ES:DI = array to receive information (subfunctions 0 and 2)	AH = status AL = bytes in page mapping array (subfunction 3) Array pointed to by ES:DI receives mapping information for subfunctions 0 and 2.	Subfunctions: 0 = get mapping registers into array 1 = set mapping registers from array 2 = get and set mapping registers in one operation 3 = return needed size of page mapping array This function was added in EMS version 3.2 and is designed to support multitasking operating systems. It should not ordinarily be used by application software. The array contains hardware- and EMM- software-dependent information. It may contain other information that is necessary to restore the expanded-memory subsystem to its previous state, as well as the contents of the mapping registers themselves.

CopyWrite

BACKS UP IBM PC SOFTWARE

Hundreds of the most popular copy-protected programs are copied readily. CopyWrite needs no complicated parameters. It needs an IBM Personal Computer, or an XT or an AT, 128k bytes of memory, and one diskette drive. CopyWrite will run faster with more memory or another drive.

CopyWrite is revised monthly to keep up with the latest in copy-protection. You may get a new edition at any time for a \$15 trade in fee.

CopyWrite makes back up copies to protect you against accidental loss of your software. It is not for producing copies for sale or trade, or for any other use that deprives the author of payment for his work.

To order CopyWrite, send a check for \$50 U.S., or call us with your credit card. We will ship the software within a day.



Quaid Software Limited

45 Charles Street East
Third Floor
Toronto, Ontario M4Y 1S2
(416) 961-8243

Ask about ZeroDisk to run copy-protected software from a hard disk without floppies.

Listing 5: An extract from the initialization module of the EMSDISK program.

```

init2:  xor     ax,ax           ; if EMM driver present,
        mov     es,ax        ; address in vector
        mov     bx,emm_int*4 ; points to EMM driver.
        mov     es,es:[bx+2] ; ES:0000 points to EMM hdr,
        mov     di,10        ; ES:DI = addr of device
        ; name field, DS:SI = addr
        ; of EMM driver name
        mov     si,offset emm_name
        mov     cx,8         ; length of device name fld
        cld
        repz   cmpsb        ; if EMM name matches
        jz     init3        ; driver header, jump.
        mov     dx,offset msg1 ; if strings didn't match,
        jmp    init_err     ; driver is absent, exit.

init3:  mov     ah,40h       ; EMM driver is present,
        int     67h         ; test EM Manager status.
        or     ah,ah
        jz     init4        ; jump, driver is OK
        mov     dx,offset msg2 ; EMM non-functional, print
        jmp    init_err     ; error message and exit

init4:  mov     ah,46h       ; check EM Manager version
        int     67h
        or     ah,ah
        jz     init5        ; jump, got version ok
init45: mov     dx,offset msg3 ; print EMM error message
        jmp    init_err     ; exit, discarding driver

init5:  cmp     al,030h      ; check at least ver. 3.0
        jae    init6        ; jump if EMM version OK
        mov     dx,offset msg6 ; EMM version too low, exit
        jmp    init_err

init6:  mov     ah,41h       ; get page frame segment
        int     67h
        or     ah,ah
        jnz   init45        ; jump if didn't get frame
        mov     page_frame,bx ; save segment of page frame

        mov     ah,42h       ; get number of pages avail
        int     67h
        or     ah,ah
        jnz   init45        ; jump if error on get pages
        mov     total_pages,dx ; save total EMM pages
        mov     avail_pages,bx ; save available EMM pages
        or     bx,bx
        jnz   init7        ; proceed if some pages
        ; available
        mov     dx,offset msg4 ; no EMS pages left, exit
        jmp    init_err

init7:  call    get_kb        ; convert desired size
        ; of EMSDISK
        mov     ah,43h       ; try and allocate EMM pages
        mov     bx,owned_pages
        int     67h         ; if allocation is
        or     ah,ah
        jz     init8        ; successful, jump
        mov     dx,offset msg5 ; if it failed, print
        jmp    init_err     ; error message and exit

init8:  mov     emm_handle,dx ; save EMM handle
        ; for this driver

```

(continued)

L I M E X P A N D E D M E M O R Y

```

call    setup          ; set up BPB

call    format         ; format the EMSDISK
jnc     init9          ; jump if no format error
mov     dx,offset msg7 ; formatting error, exit
jmp     init_err

init9:  call    signon  ; format and display driver
        -          ; identification
        .
        .

```

memory it occupies is discarded afterward. If it can't find the EMM or no pages are available, it aborts the installation of the entire program so that no system memory is wasted. (See listing 5.)

The driver proper is composed mainly of the read and write subroutines that transfer logical sectors to and from expanded-memory pages. Two other minor subroutines, `media_chk` and `build_bpb`, provide MS-DOS with information about the RAM disk's logical structure.

EMSDISK contains a fair amount of code that is not strictly necessary for its operation but is provided as an example of good behavior. This includes checking the DOS and EMM versions, testing the maximum command code passed to the driver in the request header, discarding the EMSDISK driver if the EMM cannot be found or if inadequate expanded memory is available, and using a local stack (to avoid overflowing the DOS stack) in the interrupt routine. On the other hand, I have omitted many optimizations from EMSDISK that could increase performance, such as conserving page mappings when multisector transfers are requested by DOS.

There are three values in the EMSDISK program that you may wish to fine-tune to change its behavior. Two of these are equates at the beginning of the program: `sec_size`, which sets the logical sector size (I have used 512 bytes for symmetry with other IBM media), and `dir_size`, which specifies the maximum number of entries in EMSDISK's root directory. The sector size should be an even multiple of 512 bytes (512, 1024, 2048, . . . , 16384). If you modify `sec_size`, you

will need to set the non-IBM-format bit in the device-attribute word of the device header.

The third value that you can alter is the number of sectors per cluster. This value is calculated in the setup subroutine according to the number of logical sectors that will fit into the allocated expanded-memory pages. Raising the number of sectors per cluster trades wasted disk space for a faster access speed. On average, one-half cluster per file is wasted space on the disk.

A LASTING EFFECT

The RAM disk program EMSDISK is only one way in which you can use expanded memory. Several of the most popular spreadsheet and integrated data management programs have been released in new versions to take advantage of the additional fast storage that is provided by expanded memory. ■

BIBLIOGRAPHY

Angermeyer, John, and Kevin Jaeger. *MS-DOS Developer's Guide*. Indianapolis, IN: The Waite Group. Howard K. Sams and Co., 1986.

The AST Enhanced Expanded Memory Specification. Product Marketing, AST Research, 2121 Alton Ave., Irvine, CA 92714. Hotline number: (714) 863-1333, ext. 5906.

Duncan, Ray. *Advanced MS-DOS*. Redmond, WA: Microsoft Press, 1986.

The Lotus/Intel/Microsoft Expanded Memory Specification, original document (part no. 300275-003, dated September 1985). Intel Corp., 3065 Bowers Ave., Santa Clara, CA 95051. Hotline number for software developers: (800) 538-3373.

Microsoft MS-DOS Programmer's Reference. Document 410630014-320-003-1285. Redmond, WA: Microsoft Corp., 1986.



AMERICAN MADE IBM AT COMPATIBILITY and 10 MHz POWER

\$1795!

1 YR PARTS/
LABOR WARRANTY.
SATISFACTION GUARANTEED.
BEST CUSTOMER SERVICE
IN THE INDUSTRY.

LOW PRICES

FOR GUARANTEED QUALITY!

ADTEK ATi SYSTEM (1MB/10MHz) w20MBHD	\$2184
ADTEK ATi SYSTEM (1MB/10MHz) w40MBHD	2595
ADTEK ATi SYSTEM (640K/8MHz) w1.2MFD	1495
ADTEK ATi SYSTEM (640KB/8MHz) w20MBHD	1884
ADTEK ATi SYSTEM (640KB/8MHz) w40MBHD	2295
TURBO XT SYSTEM (512KB/8MHz)	859
w360KFD w/pp, 2 sp, FD controller, clock/ calendar, battery backup, reset button on MB, 6 full size expansion slot in this configuration	
TURBO XT SYSTEM (640KB/8MHz) w20MBHD	1395
Panasonic/TEAC 360KFD (for AT)	109
Panasonic/TEAC 360KFD (for XT)	99
60MB Tape Backup	899
AT I/O EXP. CARD 1-SER/1-PAR	89
SECOND SERIAL PORT FOR D220	29
AT MFUNC. CARD/WITH OKB/1-SER/1-PAR	229
COLOR CARD W/PRINTER PORT	99
MONO GRAPHICS CARD W/PRINTER PORT	99
GENOA SPECTRUM GRAPHICS CARD	215
EGA COMPATIBLE CARD	299
EGA COMPATIBLE CARD/W PRINTER PORT	339
12" MONOCHROME MONITOR (AMBER)	109
12" TAXAN 630 WITH 553 CGA	599
14" MITSUBISHI CGA MONITOR	299
14" MITSUBISHI EGA MONITOR	419
14" NEC MULTISYNC EGA MONITOR	569
AT/XT MAXI-SWITCH K/B	75
NEC V20-8 for TURBO XT	19
8MHz Math co-processor for AT	299
8MHz math co-processor for XT	159

Write or call for FREE brochure and price list of ADTEK's full line of ATi/XT Systems and Accessories.

IBM AT is a registered trademark of International Business Machines Corp.

**ADTEK
TELECOMMUNICATIONS
CORPORATION
3706 Realty Road
Dallas, Texas 75241
(214) 241-5811**

FLOPPY DISK CONTROLLER

- Supports 2 IBM PC/XT Compatible 360K Drives
- Short Card

\$2900

FLOPPY DRIVE



- 360K Format DS/IDD Drive
- IBM PC/XT Compatible
- Half Height

\$8900

MINI I/O CARD



- Par. 1 Ser/Game Ports & Clk Cal
- 4x4 Short Slot
- IBM PC Compat
- w/Ramdisk, Print Spooler & other utilities & cables

\$8900

ADDA MODEM



- Compatibility: Bell 103 & 212A
 Speed: 0:300 & 1200 BPS
 Duplex Mode: Full or Half Duplex
 Bust Redial: Auto Busy Redial
 Data Format: 7 or 8 Bit ASCII
 Parity Format: Even, Odd or None
 Port Adapt: Com 1 or Com 2

Internal **\$11900** External **\$12900**

ADDA XT BASIC UNIT



- 135 Watts UL Approved Power Supply
- 640K On Board Memory
- AT Style Keyboard
- IBM XT Compatible
- 8 IBM Compatible Expansion Slots
- 1 Year Warranty
- 4 Layer Motherboard

MODEL I

4.77MHz
Same Speed as IBM PC/XT

\$39500

MODEL II

4.77 / 8MHz
3 Times Faster than PC/XT

\$49500

MODEL III

4.77 / 10MHz
3.7 Times Faster than PC/XT

\$59500

HARD DISK CONTROL'R



- Controller for 5, 10, 20 and 33Mb Hard Disks
- IBM PC/XT Hard Disk Controller Compatible

\$9900

HARD DISK DRIVE

20Mb Hard Disk

- 3 1/2" Shock Mounted
- Speed 65mS
- 1/2" Height

\$29900

30Mb Hard Disk

- Full Height - 45mS

\$49900

DRIVE PLUS



- High Reliability • Base Is Mounted On Controller Card • Fits One Disk Drive Slot
- Saves Space • Easy Installation • Auto Boot

\$44900

EGA MONITOR

- 640 x 350 Resolution
- 640 x 200 Resolution
- EGA and CGA Mode
- Amber and Green Text Switch

\$Call

TAXAN 630/640



\$Call

- 12" CRT w/31mm (640) or .37 (630) Dot Pitch • Ultra High Res(720x400) • Text Color Switchable Green/Amber/White Reverse/White on Blue • Includes Cables

TAXAN 555 Ctr/Graph **\$Call**

SIGMA Color 400 **\$39500**

TAXAN 620



\$Call

- Taxan High Quality • Text Switchable Green & Amber and White and Green Reverse

- 12" Dot In Line (640 x 262)
- RGB/TTL Pos
- Includes Cables

COLOR CARD **\$8900**

TTL MONITOR



- 12" Clear Green Monochrome Screen
- TTL Input

\$8900

MONO GRAPHIC CARD **\$8900**

UNINTERRUPTABLE POWER SUPPLY

- Power Failure Interrupt Signal to Computer
- Back-up Power for 15 Min
- Noise Suppression
- Surge Protection
- 250 Watt Output

\$19900

TAPE BACK-UP



- 60Mb Ext. Tape Back-Up Sys
- Self-Contained & Menu Driven
- Image & File by File Back-Up
- PC, XT, AT and Compatibles
- QIC Data Format

\$69900

132 COLUMN PRINTER

- 200 CPS
- Near Letter Quality Mode
- Epson 286 Compatible
- Tractor & Friction

\$39900

2Mb RAM BOARD

- OK Expandable to 2Mb
- Supports EMS Standard
- Works with Lotus Release 2 etc.
- Test w/8MHz CPU

XT **\$14900** AT **\$16900**

D-RAM 41256 **\$3.00 ea.**

ACCESSORIES

- Panasonic 1091 . . . \$249.00
- Printer Cable 15.00
- RS232 Cable 15.00
- 8087 \$Call
- 80287 \$Call
- Mouse \$Call
- MS DOS 3.1 40.00
- MS DOS 3.1 with GW Basic 80.00

AT FLOPPY & HARD DISK CONTROLLER

- AT Compatible Floppy and Hard Disk Controller
- Supports 2 Floppy (360K or 1.2Mb) & 2 Hard Disks

\$19900

1/2 HIGH FLOPPY

- Includes Bracket to Fit PCI/AT
- Grey Face Panel
- Highly Reliable
- IBM PC/AT Compatible

360K **\$9900** 1.2Mb **\$14900**

AT HARD DISK

- Full Height
- High Performance - 45mS
- Comes w/Mounting Rail and Cable

20 Mb Hard Disk **\$39900**

30 Mb Hard Disk **\$49900**

ADDA AT BASIC UNIT

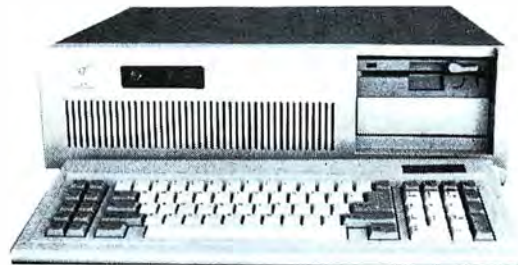

- 200 Watt Power Supply
- 640K On Board Memory
- AT Style Keyboard
- IBM AT Compatible
- 8 Expansion Slots
- 1 Year Warranty
- 8087 Optional Socket

ADDA Price . . . Only **\$99500**

MINI I/O CARD



- Parallel & 1 Serial/Game Port • Floppy Drive Contrl, IBM AT Comp. • w/Ramdisk, Printspooler and other Utilities • Incl Cables

\$8900

MULTI-FUNCTION SUPER AT CARD



- Serial Port • Parallel Port
- 3Mb Expandable
- MF-3001 w/OK

\$19900

NETWORK CARD

- PC Network Compatible
- Easy Installation
- Twisted Pair or Phone Cable Type
- Call for More Details

\$29900

Prompt delivery, usually shipment within 48 hours (except personal check orders). 25% deposit required for C.O.D. orders. We welcome major educational institutions and government agencies to establish open accounts (P/O) status with us to facilitate shipment of orders. Write or call for details.

Prices quoted above do not include UPS shipment charges. Prices subject to change without notice. California residents add 6% sales tax. Mastercard or Visa add 3%

Business hours: Mon.-Sat. 8:30am - 5:30pm

IBM PC is a registered trade mark of IBM Corp. TAXAN is a registered trade mark of TAXAN Corp.

©1986, American Digital Discount Association



AMERICAN DIGITAL DISCOUNT ASSOCIATION, INC.

4040 SPENCER STREET, SUITE M
 TORRANCE, CALIFORNIA 90503
 TELEPHONE: (213) 542-3578

PERFORMANCE PROGRAMMING

Developing a single program for a variety of IBM PC compatibles

BY JOEL ROSENBLUM AND DAN JACOBS

IF YOU CREATE programs for the IBM PC, you often need to sell separate versions of your software for particular "compatible" machines. The wide variety of so-called PC compatibles creates problems for you as a software engineer trying to write one version of your program that operates on as many machines as possible.

As many buyers have already discovered, some IBM PC clones are not true clones at all. These machines either are enhanced with features that give them a marketing edge over the original IBM machine or are so restricted that they have trouble using common existing software such as Lotus 1-2-3 and dBASE III. All this hardware incompatibility makes it more difficult to design and sell your programs to everyone who can use them. Your customers send you back to the salt mines to develop 16 different versions of the same software product.

DEFINING PERFORMANCE PROGRAMMING

We have developed a methodology that lets you design "generic" software; it will operate with most IBM-compatible machines that use MS-DOS.

Best of all, our procedures will let your programs automatically take advantage of PC hardware features. Your programs will know when they can



write directly to video memory or access the IBM BIOS low-memory variables. If your program encounters a machine it doesn't know, it can decide whether certain features exist for it to use or whether it should treat the new machine as generic until you can incorporate that machine's features into the next release of your software. We will also describe some methods that allow user-selectable compatibility so your customers won't have to wait for your next software release. Now you can sell only one version of your program. However, that version is special because you create it using a method we call performance programming.

We will explain how to program for performance while maintaining compatibility. Our approach is twofold

First, we define a generic PC as a model on which to base your program. Then we define and use a features table that automatically determines IBM PC compatibility by reading the manufacturer's copyright notice contained in the machine's BIOS ROMs. We next look at how you can use the presence of other equipment within your machine to set "performance bits" and how you can incorporate that information into your overall program design. Finally, we will give some examples relating to processor detection and speed determination, video capability, extended character set presence, ANSI cursor addressing,

and use of other set bits in your program.

DEFINING THE GENERIC PC

We define a generic PC as a computer that is only minimally compatible with the IBM PC. The requirements of our theoretical generic PC design are the presence of an Intel 8088 or equivalent processor, the ability to read/write either IBM PC 5¼-inch or 3½-inch disks, MS-DOS, the ability to

(continued)

Joel Rosenblum (609 East Speer Blvd., Denver, CO 80203) is president of Data Pacific Inc. and codeveloper of the Apple Macintosh emulator for the Atari ST. Dan Jacobs is a member of the technical staff at Quest Analysis (11965 Venice Blvd., #305, Los Angeles, CA 90066).

display 25 lines of either 40- or 80-column text, and an ASCII keyboard without cursor and function keys.

Our generic PC does not include the following features present in a true IBM PC: an IBM extended character set, direct cursor-key positioning, bit-mapped screen graphics, the ability to use BIOS calls and corresponding access to low-memory variables, and the ability to access hardware directly.

We assume that a generic PC has a text-only screen display that supports only the standard ASCII character set and has a keyboard without cursor-positioning or function keys. You might note that the Zenith Z-100 is close to qualifying as our theoretical generic PC. Also, the generic system does not have an IBM-compatible BIOS even though it supports MS-DOS. This implies that all operating system function calls for a generic PC must occur at the highest level, which in this case is by using DOS system interrupt calls 20h through 27h. More information about these OS interrupt calls appears in IBM's *Disk Operating System Technical Reference*, available through IBM dealers or directly from IBM (write IBM Technical Directory, P.O. Box 2009, Racine, WI 53404-3336 or call (800) 426-7282).

The advantages of generic PC software are threefold. From your standpoint as a programmer, your software will work on most IBM PCs and compatibles. As a software publisher and dealer, you have to stock and sell only one version of a program. Finally, as a user, you do not need to be concerned about program compatibility or special steps to install the software on your IBM PC-compatible hardware.

On the other hand, generic software cannot take advantage of the advanced features present in the original IBM PC and some compatibles. Software with only scrolling generic screens and no graphics capability is not acceptable for some users. Here the second part of our methodology, the features table, comes into play.

DEFINING A FEATURES TABLE

A features table lets your programs take advantage of a particular com-

patible's features by determining the equipment your program is operating on. Your software automatically enhances itself for certain compatibles, so your program runs faster and more efficiently and has an improved user interface.

If your program is to operate with this type of intelligence, it must reliably determine the equipment. Your software can't read the label on the outside of your compatible, so we rely primarily on the copyright notice contained inside the machine's BIOS ROMs.

When an engineer designs a PC compatible, he or she incorporates into that machine's ROMs a set of routines that directly control the hardware. Those routines are the BIOS. A manufacturer of PC compatibles can write his or her own BIOS or purchase a BIOS from another manufacturer such as Phoenix Software Associates or Faraday Electronics.

The manufacturer can also market a machine that is made by an OEM. The OEM usually brands its machines by placing a copyright notice within the BIOS code. An example is the AT&T PC 6300, which is manufactured by Olivetti. Olivetti purchases the BIOS for its machine from Phoenix Software Associates. So what is the resulting copyright notice inside the user's 6300? It is the string "OLIVETTI," followed by some text.

Copyright notices thus far have been an unofficial method of determining a machine's manufacturer. The method is not 100 percent reliable, however, since the manufacturer might decide, for whatever reason, to change the location or actual string of the copyright notice. To prevent problems with your users, we have provided some software escape hatches. When your program cannot locate the copyright, the software will default to its generic-machine mode. However, some of your users might not be satisfied with the resulting loss of performance, so we also suggest that you incorporate into your program a method for the user to set the machine's compatibility level. Here are three examples of how to do that.

First, you can let your user input a slash option such as /IBM when invoking your software with its command string, as in

```
yourprgm /IBM
```

A good example of a program that uses the slash-option approach is Microsoft's SYMDEB.

Second, you can incorporate an "It's a compatible" override as part of an optional installation process. Finally, you can let your user set compatibility as part of the DOS environment. For example,

```
set compatibility = IBM
```

The use of any of these methods in your program lets those users who need more performance obtain it. When a new machine appears on the market, advanced users will be able to use that machine to its fullest potential.

An example of a C-language implementation of a features table is presented in listing 1. *[Editor's note: Only listings 1, 2, and 3 are reproduced here. The entire set of listings (1 through 9) is available for downloading. See the note at the end of this article.]* In that example, machine characteristics are defined as bit flags in the variables FEATURES and VIDEO_FEATURES.

You should develop your own set of bit flags for the features your program needs to use. These bit flags are bits that you can set either off or on and that exist within a word. For example, if we set bits 1, 4, and 8 of a word "on" while leaving the remaining bits "off," the value of that word is 13 hexadecimal. Since we are interested in determining only if particular bits within the word are set, the value of the word is not important. Instead, we extract the bits that we are interested in by using a mask. Our sample programs in the listings illustrate how the mask is used.

Some of your programs might require information about the compatible's operating system version or the availability of certain BIOS calls. We will not discuss the detection of this additional information here, but we

(continued)

Listing 1: A sample features table, as described in the article.

```

/*
*/
/*
This code contains a C language Features Table which contains the location
and copyright string that uniquely identify a machine. In addition to the
copyrights, the bit fields for the FEATURES and VIDEO_FEATURES variables
are defined. Note that this code is compiled with the Lattice C Compiler
version 2.15, using -md -n options. Copyright (c) 1986 Dan Jacobs and
Joel Rosenblum for public, unrestricted use.
*/

/* bit flags for FEATURES */
#define IBMPC          0x0100 /* IBM PC, XT, Portable, */
#define IBMPCAT        0x0200 /* IBM AT */
#define IBMCOMPAT      0x0400 /* IBM PC BIOS Compatible */
#define IBM_CONVERT    0x0800 /* IBM Convertible */
#define GENERIC        0x1000 /* Assumed generic PC */
#define NO_DMA         0x2000 /* Machine has no DMA */
#define WANG            0x4000 /* Wang PC special case*/
#define TIPROF         0x8000 /* TI Professional PC special case */
#define CPU_88         0x0001 /* 8088, 8086 processor */
#define CPU_186        0x0002 /* 80188, 80186 processor */
#define CPU_286        0x0004 /* 80286 processor */
#define CPU_V20        0x0008 /* V20, V30 processor */
#define NDP            0x0010 /* 8087, 80287 math coprocessor */

/* bit flags for VIDEO_FEATURES */
#define CGA            0x0001 /* IBM Color Graphics Adapter */
#define MONO           0x0002 /* IBM Monochrome Adapter */
#define HERCULES       0x0004 /* Hercules Monochrome Adapter Card */
#define PGA            0x0008 /* IBM Professional Graphics Adapter */
#define EGA_MONO       0x0010 /* w/Monochrome Monitor */
#define EGA_COLOR      0x0020 /* w/Color Monitor */
#define EGA_HIGH       0x0040 /* w/High Resolution Color Monitor */
#define UNKNOWN        0x0080 /* Unknown graphics type */
#define ANSI           0x0100 /* ANSI.SYS installed */

/* Additional bit fields may also be defined, please see TABLE 1 for suggestions */

struct machine_info {
    char *logo; /* Unique copyright string */
    long addr; /* String memory location */
    /* Note: actually (char *) must be (long) to pass Lattice C */
    int type; /* Machine attributes */
} feature_table[] = {

/* copyright notice, physical address, pctype */
"IBM", 0xFE00EL, IBMPC|IBMCOMPAT}, /* All IBMs */
"COMPAQ", 0xFFFEAL, IBMCOMPAT}, /* All Compaqs */
"Corona", 0xFE00F, IBMCOMPAT}, /* Old version Corona */
"Corona", 0xFE01A, IBMCOMPAT}, /* Version 3.10 ROM Corona (also Phillips) */
"M.P.C.", 0xFDB2D, IBMCOMPAT}, /* New Columbia */
"Columbia", 0xFF768, IBMCOMPAT}, /* Old Columbia */
"Eagle PC", 0xFFFAA, IBMCOMPAT}, /* Eagle PC */
"Eagle PC", 0xFF810, IBMCOMPAT}, /* Eagle PC Plus */
"Zenith", 0xFB000, IBMCOMPAT}, /* Zenith Data Systems */
"Zenith", 0xFC2FF, GENERIC}, /* Zenith 100 */
"MITSUBISHI", 0xFC02A, IBMCOMPAT}, /* Sperry PC and Leading Edge */
"TVS", 0xFE003, IBMCOMPAT}, /* TeleVideo */
"OSM", 0xFFFF5, IBMCOMPAT}, /* OSM Rom Version 3.6 or later */
"OLIVETTI", 0xFC050, IBMCOMPAT}, /* AT&T-IS PC 300 and Xerox */

```

(continued)

```

/* NOTE: AT&T is not supporting V1.0 ROMs */
/* WANG Professional */
/* Applied Data Digital Systems Model PC/I */
/* Seattle Telecom Turbo Boards */
/* Personal Computer Products */
/* Tava PC */
/* Tandy 1000 has no DMA without memory upgrade */
/* Tandy 1200 */
/* TI Professional V1.23 & V2.11 SYSROM */
/* American PC lookalike */
/* STD Turbo Boards in IBMs */
/* STD Turbo Boards in COMPAQs */
/* Tomcat AT clone */
/* WYSE PC BIOS Version 1.08 */
/* Hewlett-Packard Vectra AT Compatible */
/* Morrow Pivot II & Zenith 171 Desktops */

{ "WANG", 0xFFFFC2, WANG|GENERIC},
{ "ADDS", 0xFC050, IBMCOMPAT},
{ "CROS", 0xFE000, IBMCOMPAT},
{ "PCPI", 0xFE00F, IBMCOMPAT},
{ "TAVA", 0xFE018, IBMCOMPAT},
{ "Tandy", 0xFC02B, IBMCOMPAT|NO_DMA},
{ "Tandon", 0xFC013, IBMCOMPAT},
{ "Texas", 0xFE022, TIPROF},
{ "American", 0xFE004, IBMCOMPAT},
{ "STD", 0xFE00EL, IBMCOMPAT},
{ "STD", 0xFFFEAL, IBMCOMPAT},
{ "TOMCAT", 0xFE02B, IBMCOMPAT},
{ "WYSE", 0xFC003, IBMCOMPAT},
{ "Hewlett-Packard", 0xF0024, IBMCOMPAT},
{ "Morrow", 0xFE073, IBMCOMPAT},

/* Additional machines are added to the list starting here */

{ NULL, NULL, 0}
};

```

Table 1: A summary of some bit-field considerations, information that programs might require before they can run on IBM PC-compatible systems.

CPU-related features:

- detection of the primary processor in the machine
- detection of the processor's speed
- detection and use of coprocessors

Video-related features:

- present video type(s)
- present video mode
- installation of ANSI.SYS video device driver
- ability to use IBM expanded-video character set

Operating system-related features:

- availability of certain BIOS-level calls
- DOS version check

Disk-related use and detection:

- floppy and/or hard disk drive type
- floppy and/or hard disk drive size
- detection of floppy disk drive mode
- ability to use interrupt 13h calls
- DMA detection

interrupt 4Eh in place of any assembly language interrupt 13h direct disk I/O calls. Thus, listing 1 defines the special bit flags WANG and TIPROF. If your program needed to use any of these calls on one of these two machines, the defined bit flag would handle the branch within your program. Some examples of use of the bit-flag branch to control program performance optimization are contained in the Detecting Video Type section of this article.

The sample features table in listing 1 also shows how you might determine the presence of a turbo board. The copyright notice was given for an STD turbo board used in an IBM or Compaq PC. Again, once it detects the board, your program could act accordingly. Of course, your program could also incorporate detection for other installed circuit cards using their copyright notices.

In summary, the equipment features table places all the burden of compatibility and machine optimization in one convenient place. If a computer is not on the list, the program assumes it is generic. Otherwise, the capabilities of the machine are already "known" and your program would automatically use them. For new or previously unknown machines, your user must either accept the automatic generic-machine mode or over-

have provided a summary of some bit-field considerations for use in the FEATURES variable in table 1.

The definitions are then followed by the copyright notices that appear in a structure containing the location and unique identifying string for some sample machine BIOS ROMs. Note that each defined machine in the table contains its own set of characteristics that are then placed in the bit-flag variable.

Two machines, the Wang PC and the

TI Professional, are important examples of how you can use the table to deal with some unusual compatibility considerations. For example, the Wang PC requires clearing the direction flag before making disk I/O calls from assembly language routines. This problem does not occur when making the I/O calls from most high-level languages since, in these languages, the direction flag is usually left in the increment position. The TI Professional requires a substitution of

ride it by providing the program with performance optimization. Therefore, as a service to your users who prefer to use software as it comes off the shelf, you have a responsibility to keep your features table as up-to-date as possible. Perhaps the features table will become a public domain standard for use by all programmers.

USING THE FEATURES TABLE

Now that you have developed a features table, how do you use it in your code? Listing 2 contains a C-language routine that uses the features-table structure defined in listing 1 to determine machine compatibilities. The routine reads the copyright notice, if it can locate one, and sets the bits within the variable FEATURES. The routine also calls separate functions that set additional bits within FEATURES and VIDEO_FEATURES. Your program's code then checks the appropriate bit within the variable to determine if a particular ability exists for the machine on which your software is currently operating.

It is important that the routines in your program that use the features variables exist at the lowest level of your code. The reason for this is so that the rest of your program will sit above the machine's hardware and be oblivious to the equipment present. Your program will execute the appropriate routines based on the information contained within the variables. For example, suppose your software could speed up its disk access by using BIOS interrupt 13h calls. If FEATURES indicated that the machine your software is currently operating on is 100 percent IBM-compatible, then you would use the BIOS interrupt; otherwise, you would use DOS interrupt calls 25h and 26h to access the disk. In effect, you create a device-independent interface for your program. If you later find that you need to define another FEATURES bit or you need to extend the length of the FEATURES variable, you will be able to make the change with a minimum of recoding.

Now that we have defined the bits

(continued)

The Only EGA

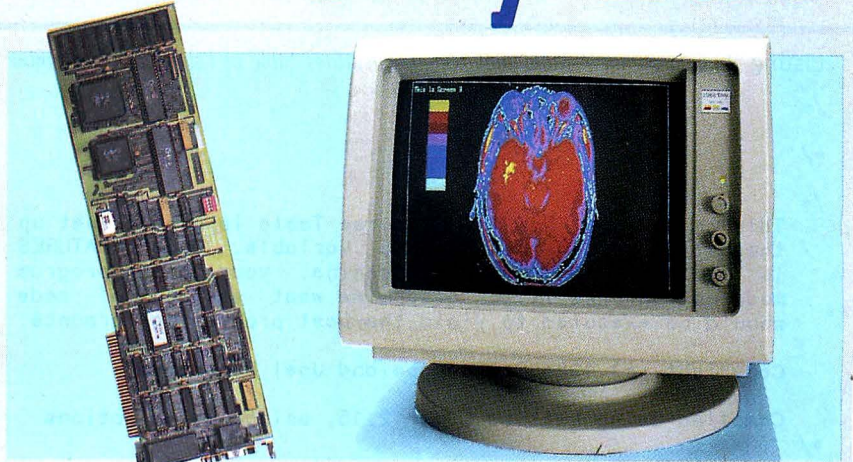

A fully compatible 256k EGA card with a parallel port for only \$259. If you buy any display card: Color, Monochrome, Hercules, or EGA, without reading this ad, you're probably throwing away a lot of money.

BT/EGA Enhanced Graphics Adapter: 256k of memory, and parallel printer port. Works with all standard IBM displays, and compatible displays.
5150 Monochrome Display: Both text and 640x350 bit mapped graphics.

5153 Color Display: 640x200 and 320x200.
5154 Enhanced Display: Color 640x350 16 simultaneous colors from a palette of 64.

A Clear Upgrade Path

This really is the only display board you may ever need. Regardless of what monitor you buy today, this card is a clear upgrade path for the future, and the best choice today, even if you are only going to use a Monochrome Display. This means one board today does monochrome 640x350 bit mapped graphics and text, and provides a clear upgrade path to 640x350 Enhanced Color Display with no change of display board. It also runs with the 640x200, 320x200 Color Display.

Killer Features

All boards come with a full 256k of memory, and a parallel printer port. That means no extras for later, and 16 simultaneous colors displayed from a palette of 64 colors, and crisp clear text on both Mono-

No Risk Guarantee

If you are not completely satisfied with your purchase, you may return it within 30 days of purchase for a complete refund, including the cost to send it back. If you can get any dealer or competitor to give you the same **No Risk Guarantee**, buy both and return the one you don't like.



For fastest delivery, send cashier's check, money order, or order by MasterCard/Visa. Personal Checks allow 18 days to clear. Company purchase orders accepted, call for prior authorization. California residents add 6% sales tax.

chrome and Enhanced Color Displays - features or options that are not available on other EGA boards. Since all your current software will run, you're set for today, and prepared for the standard of the future.

The Display Deal

Of course many of you will want to take advantage of the EGA card right away, so we are offering a special deal when you buy the board together with a Basic Time HR 31-350 monitor - you get both for just \$749, or the card only for \$259. This means that you can equip all your PC's now and in the future with displays and EGA cards and get the Qubie "No Risk Guarantee", our one year warranty, and 48 hour turnaround on warranty repairs. The price is the whole price, there are no extras for freight, insurance, or credit cards.

QUBIE'

Department B
 507 Calle San Pablo
 Camarillo, California 93010

Inside California
805-987-9741

Outside California
800-821-4479

London (01) 223-4569 Sydney (02) 579-3322
 Paris (01) 321-5316 Canada (403) 434-9444

Hours: M-F 8am - 5pm PTZ
 Sat 8am - 12pm PTZ

Listing 2: C-language routine that uses the features table of listing 1 to determine machine compatibility.

```

/*
*/
/*
This code shows how the Features Table is used to set up
the bit flags in the FEATURES variable. Once FEATURES
is set for the current machine, your other program
modules can use it to determine what section of code
should be executed to yield the best program performance.

Copyright (c) 1986 Dan Jacobs and Joel Rosenblum

Compiled using Lattice C ver 2.15, using -md -n options
*/
unsigned int video_features; /* global variable which holds video attributes */
unsigned int set_features()
{
    char *cp; /* Pointer */
    struct machine_info *p; /* Features Table Structure */
    unsigned int feature; /* FEATURES bit field variable */

    /* Assume the PC is generic to start */
    feature = GENERIC; /* default to generic */
}
/*
A pseudo code example of how to override the automatic set of FEATURES
assuming that either a slash option or a DOS environment variable is
set. Your actual code will depend upon how you do the parsing. See
the section on using the machine's copyright notice to determine
compatibility in our text.

begin pseudo code example --
    if ((/IBM entered on command line) |
        (compatibility = IBM is in the environment)) {
        feature = IBMCOMPAT;
        goto cpu_test;
    }
-- end pseudo code example */

for (p = feature_table; p->addr != NULL; p++) /* If next table entry is NULL, end loop */
    if (strncmp((char *) p->addr, p->logo, strlen(p->logo)) == 0) {
        feature = p->type;
        break;
    }

if (feature & IBMPCC) { /* IBM Personal Computers */
    cp = (char *) 0xFFFFE; /* physical address 0FFFF:E */
    switch (*cp) {
        case 0xF9: /* IBM Convertible */
            feature |= IBM_CONVERT;
            break;
        case 0xFC: /* IBM AT */
            feature |= IBMPCCAT | CPU_286;
            break;
        case 0xFD: /* IBM PC JR */
            feature |= NO_DMA;
            break;
        case 0xFE: /* IBM XT or Portable */
        case 0xFF: /* IBM PC */
            break;
        default:
            break; /* unknown IBM type */
    }
}

```

(continued on page 190)

Hard Solutions

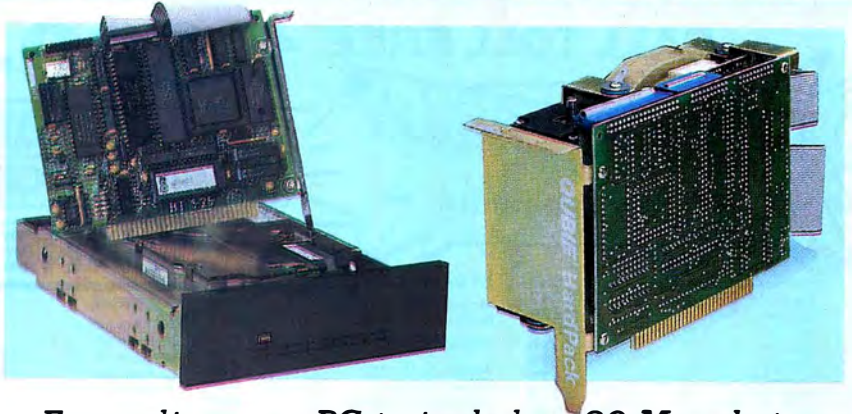

that make up the variables, the next sections will show you the details behind setting those flags. These examples illustrate how your programs can detect such features of your machine as its processor, effective clock speed, and video display. These routines are the foundation for the creation of your own hardware-independent modules.

DETERMINING CPU TYPE

Software that is dependent upon processor type needs to determine under which processor it is operating. Examples include operating system software that might require the use of certain processor modes such as the Intel 80286's protected mode or the use of the PUSHA instruction on the 80186.

Listing 3 gives a C-callable assembly language routine that you can use to determine the presence of the Intel 8088/8086, 80186, and 80286 processors and the NEC V20 and V30 processors, so you can set the corresponding bit in FEATURES.

Your program's performance might improve by detecting and using a math coprocessor. Examples include programs with heavy trigonometric or floating-point operations such as statistical analysis and speech-processing software. Two methods for detecting a math coprocessor are in listing 4.

Finally, it might be important to determine the processor's clock speed. Timing loops are an important part of communications software, and the assembly language procedure in listing 5a lets you set processor-speed-independent timing loops. Listing 5b shows an example of how to use the timing routine.

DETECTING VIDEO TYPE

Automatic video detection should be an almost universal part of your software if you want to display any of the IBM extended character set or bit-mapped graphics on the video display. Further, automatic display-type determination eliminates placing the burden of video-display installation

(continued)

Expanding your PC to include a 20 Megabyte hard drive has never been simpler with Qubie' internal or HardPack 20 slot mounted drives.

PC 20: Standard, internal mounted 1/2 height unit for use in floppy disk area of a PC, PC XT or compatible.
HardPack: Card Mount for slot mounting, 1/2 slot length to mount behind floppy drive, on a PC, PC XT or compatible.

Data Transfer Rate: 5 Megabits/Sec
Access Time: 65 Milliseconds
Power Requirements: +5 VDC 2.0 A
+12 VDC 9 A Max
Capacity: 20 Megabytes
Reliability: 14,000 Hours

The Pentagon Ashtray

The military is famous for paying \$450 for ashtrays. A lot of companies are asking the same kind of outlandish sums for a hard disk mounted on a card. You get a hard disk, a controller, and a bracket, and they charge you hundreds more than you pay for a Qubie' 20 Megabyte hard disk system. Unlike the others, our HardPack 20 fits into a single slot and nestles in behind your floppy drives. If you buy any other hard drive, you may simply pay more and get a whole lot less.

The Choice

We offer both types, an internal mounted like your floppy, or a card mount for the same \$459 price. Let's face it, the bracket doesn't cost us 450 bucks. While some people prefer the standard mounting, (like a floppy) so they can see the read/write light, others want a card mount so they can use both floppies they now have. Both drives boot directly from the hard disk, and require no software patches. They run all the popular software, and

are low power. Our format software allows changeable interleaving that gives you noticeable speed improvement over the standard XT drive. Both have the ability to run a second drive from the controller, (Part Number 2nd-20HP \$399), giving you 40 megabytes of storage for under \$900.

The Goodies

We give you some software that really enhances the use of a hard disk. 1dir is the hard disk organizer that really makes DOS a snap, and our special Qubie' version of ZyIndex, the super searcher is also included. Easy to read manuals make installation a snap. Of course the drives are backed by our "No Risk Guarantee", our one year warranty, and 48 hour turnaround on warranty repairs. The price is the whole price; there are no extras for freight, insurance, or credit cards. Order part numbers PC20 for IBM PC and compatibles. PC20-1000 for Tandy 1000, or HardPack 20. By popular demand we still offer the matching ashtray for just \$450, (Part No. PCKIDDING).

No Risk Guarantee

If you are not completely satisfied with your purchase, you may return it within 30 days of purchase for a complete refund, including the cost to send it back. If you can get any dealer or competitor to give you the same **No Risk Guarantee**, buy both and return the one you don't like.



For fastest delivery, send cashier's check, money order, or order by MasterCard/Visa. Personal Checks allow 18 days to clear. Company purchase orders accepted, call for prior authorization. California residents add 6% sales tax.

QUBIE'

Department B
507 Calle San Pablo
Camarillo, California 93010

Inside California
805-987-9741

Outside California
800-821-4479

London (01) 223-4569 Sydney (02) 579-3322
Paris (01) 321-5316 Canada (403) 434-9444

Hours: M-F 8am - 5pm PTZ
Sat 8am - 12pm PTZ

COMPUTER WAREHOUSE

CALL TOLL FREE **1-800-528-1054**

FREE FEDERAL EXPRESS
Air Express Shipping
See Details Below

NOW **BEST PRICES**
No Charge for Bank Cards

HARDWARE

PRINTERS

Brother All Models	Call
Cannon Laser Printer	\$1949
Citizen MSP-10	\$279
MSP-15	\$379
MSP-20	\$315
MSP-25	\$479
Premier 35	\$479
Diablo D-25	\$489
635	\$1035

EPSON

All Printer Models Call

Fujitsu	Call
IBM Proprinter	\$399
Juki	
6100	\$349
6300	\$669
NEC 3510, 3550, 3515, 3530	\$729
8810, 8830, 8850	\$1039
P5	\$959
P6	\$429
P7	\$609

OKIDATA

All Printer Models Call

Panasonic 1080	\$199
1091	\$239
1092	\$309
1592	\$425
KXP3151	\$399

STAR MICRONICS

All Printer Models Call

Toshiba 321 Parallel & Serial	\$449
341	\$769
P351 Parallel & Serial	\$919
Laser Printer	Call

KEYBOARDS

Keytronics 5151	\$159
-----------------	-------

PLOTTERS

Epson Hi-80	Call
-------------	------

DISKETTES

Maxell MD-2 (Qty 100)	\$100
Sony MD/2 (Qty 100)	\$119

MONITORS

Amdex All Monitors	Call
NEC All Monitors	Call
Princeton Graphics	Call
Zenith All Models	Call

VIDEO TERMINALS

Qume QVT Green 101	\$299
QVT Amber 101	\$314
Wyse 30	\$299
50	\$419
75	\$559
Wyse 85	\$439
Wyse 350	\$859
Zenith Z-22	\$455
Z-29A	\$559
Z-49	Call

MODEMS

Anchor Automation	
Signalman Express	\$235
Practical Peripherals	
Practical 1200 Baud	\$124

HAYES

All Modems Call

Prometheus All Models	Call
US Robotics Courier 2400	\$369
Password 1200	\$175
Microlink 2400	\$369

DISK DRIVES

Omega Bernoulli 10 meg.	\$1359
Bernoulli 20 meg.	\$1749
Bernoulli 40 meg.	\$2469

SEAGATE

20 meg w/Western I/O \$395

BOARDS

AST Advantage	\$329
Rampage AT	\$445
Rampage PC	\$239
Six Pack Plus	\$159
Hercules Color Card	\$149
Graphic Card	\$179
Intel Above Board PC (1110)	\$239
Above Board AT (2010)	\$329
Above Board PS/AT (2110)	\$369
Paradise Modular Graphic 06-1	\$239
Five Pak	\$115
Plus Development	
Plus Hard Card 20 Megabyte	\$669
Quadram Gold & Silver Boards	Call
Quadlink	\$329
Quad EGA+	\$359
Tec Mar Graphics Master	\$445
Captain No Memory	\$169

FCC Approved

\$449



MIT SYSTEMS Turbo PC/XT

256 Memory, One 380K Brand Name Floppy Drive • 135 Watt Power Supply, Slide Case, AT Style Keyboard, 8 MHz Clock Speed, (Keyboard Selectable), 8 Expansion Slots

COMPUTERS

IBM

PC 1 Drive 256K	\$1199
XT 1 Drive 256K	\$1729
XT 1 Drive 20 Meg 640K	\$2169
AT/68	\$2849
AT/339	\$4449

COMPAQ

Portable II-2 Drive	\$1649
---------------------	--------

PANASONIC

Sr. Partner Dual Drive	\$1109
Exec. Partner Dual Drive	\$1759
Other Models	Call

TOSHIBA

T-1100	\$1299
T-1100 Plus	\$1729
T-3100	Call

SPERRY

Sperry IT	\$1999
Other Models	Call

WYSE

Wyse pc 1100-1	\$979
Wyse pc 1100-20	\$1539

Zenith Computer Products
SAVE up to 50%
All Models Call

COPIERS

Canon

Canon PC-20 \$719
Canon PC-25 \$939

SOFTWARE

IBM PC and 100% Compatibles

TRAINING

Flight Simulator	\$28
PC Logo	\$75
Typing Instructor	\$28
Typing Tutor III	\$28

LANGUAGES

C Compiler (Microsoft)	\$249
Fortran Compiler (Microsoft)	\$195
Lattice C Compiler	\$242
Macro Assembler (Microsoft)	\$84
Pascal Compiler (Microsoft)	\$166
Quick Basic 2	\$55
Run C Interpreter	\$65
Turbo Pascal w/8087 & BCD	\$59
Turbo Database Tool Box	Call

PROJECT MANAGEMENT

Harvard Total Project Manager	\$262
Microsoft Project	\$219
Super Project Plus	\$239
Timeline 2.0	\$209

COMMUNICATIONS

CompuServe Starter Kit	Best Price \$92
Crosstalk XVI	\$139
MS Access 1.01	\$76
PFS Access	\$92
Remote	\$92
Smartcom II	\$83

INTEGRATIVE SOFTWARE

Enable 1.1	\$319
Framework II	Call
Smart Software System	\$379
Symphony	Call

GRAPHICS

Chartmaster	\$199
Diagram Master	\$185
Energraphics 2.0	\$269
In-A-Vision	\$249

Microsoft Buss Mouse	\$106
w/PC Paintbrush 3.0	\$164
Microsoft Chart	\$119
Microsoft Serial Mouse	\$119
Newsroom	\$139
PC Draw	\$99
Click Art Personal Publisher	\$99
PC Mouse w/Dr. Halo II	\$115
PC Paint w/Mouse	\$76
PFS Graph	\$29
Printmaster	\$132
Signmaster	\$34
Turbo Graphix Tool Box	Call

WORD PROCESSORS

Leading Edge Word Processor	\$48
Leading Edge W/P w/Spell & Mail	\$72
Lightening	\$55
Microsoft Word 3.0	\$249
Multimate Advantage	\$269
PFS: Write w/Spell Checker	\$76
Wordstar w/Tutor	\$162
Wordstar Pro Pack	\$233

Word Perfect (Ver.4.1) \$196
Wordstar 2000 + 2.0 \$278

UTILITIES

Copy II PC	\$19
1 DIR	\$46
Fastback	\$86
Norton Utilities 3.1	\$48
Printworks	\$36
Sidekick	\$30
Sidekick (Unprotected)	\$47
Sidekick-Superkey (Bundle)	\$85
Travelling Sidekick	\$39
Turbo Prolog	\$54
Sideways 3.1	\$34
Superkey	\$39

SPREADSHEETS

Lotus 1-2-3	Call
Multiplan	\$108
Spreadsheet Auditor 3.0	\$82
VP Planner	\$48
Supercalc 4	\$259

MONEY MANAGEMENT

Dollars & Sense w/Forecast	\$94
Tobias Managing Your Money	Call

DATA BASE MANAGEMENT

Clipper	\$329
Cornerstone	\$67
dBase II	Call
dBase III Plus	Call
Extended Report Writer	\$74
KnowledgeMan II	\$249
Nutshell 2.0	\$59
PFS: File	\$76
PFS: Report	\$67
Quickcode	\$138
QuickReport	\$138
Reflex	\$82
Think Tank	\$91

R:Base 5000 System V \$329
Many other titles available.

Inquiry 71 for MS-DOS Products. Inquiry 72 for all others.

COMPUTER WAREHOUSE

Order Line: 1-800-528-1054
Order Processing: 602-224-9345
2222 E. Indian School Rd.
Phoenix, Arizona 85016
602-954-6109

Store Hours: Mon-Fri 10-5:30
Saturday 9-1
Order Line Hours: Mon-Fri 7-5:30
Saturday 9-1
Order Processing Hours: Mon-Fri 10-3

Product shipped in factory cartons with manufacturer's warranty. Please add \$6.00 per order for UPS ground shipping on orders up to 10 lbs. Orders 10 lbs. and under you pay for ground service, receive air service at no extra charge. Available on orders 11-30 lbs. \$17 for air service. Prices & availability subject to change without notice. Send cashier's check or money order...all other checks will delay shipping two weeks.

We do not guarantee computer compatibility.

on the user. Of course, a feature that lets users override this display determination, similar to the ones described in the copyright-notice section of our article, could be incorporated into your program.

Video detection starts with determination of the active display-adapter type. The five major adapter types are IBM Monochrome Adapter, Hercules Graphics Card, IBM Color Graphics Adapter (CGA), IBM Enhanced Graphics Adapter (EGA), and IBM Professional Graphics Adapters (PGA). The procedure in listing 6 detects these adapter types and sets the appropriate performance bits in the variable VIDEO_FEATURES.

The performance bits in VIDEO_FEATURES activate code within your program, which can then take advantage of the selected display adapter's features. Programs that allow use of the EGA's colors, for instance, could be set active when that adapter type is detected. You could also use VIDEO_FEATURES bit flags to politely notify your user that a particular display is not present if, for instance, your software absolutely requires the use of that display.

If none of the above display adapters is in the compatible's hardware, the display might still have the ability to position the cursor directly on the screen. Direct cursor positioning lets screen displays appear without scrolling. Displays with this capability are ANSI-compatible. ANSI compatibility implies that the ANSI.SYS device driver has been installed by the user as a part of the CONFIG.SYS file on the compatible machine. If you incorporate the code contained in listing 7 into your program, the program will be able to directly check whether ANSI.SYS has been installed on the user's machine.

In addition to determining ANSI compatibility, you might want to take advantage of the IBM extended character set so that you can design screen displays and menus to look better. Screen enhancements such as character blinking, underlining, and boldface might also be possible. We

(continued)

MICROSYNC JUST BROKE THE PC

SPEED LIMIT

for

\$199

Introducing the

SCREAMER™

Sometimes your computer seems to crawl through applications, it slows down, drags its feet and makes you want to scream. Don't scream... get The SCREAMER, the newest timesaver from Microsync™.

The SCREAMER breaks old PC speed limits by doubling the speed of your IBM® PC, XT or compatible*, which means you get faster word processing, speedier spread sheets, double-time data bases and much more. All aspects of your PC operations are speeded-up, including I/O, memory access and disk access.

The SCREAMER has an on-board battery backed-up clock-calendar, keyboard selectable speed control, fits in a short expansion slot, and is compatible with all your hardware and software.

Break the speed limit on your PC, and write your own ticket on performance. Order a SCREAMER today.

AT™ version available late summer.



MICRO SYNC™

P. O. BOX 116302 • Carrollton, Texas 75011 • (214) 788-5198

*Actual speed dependent on system configuration and software application.
Microsync and Screamer are trademarks of Microsync, Inc.
IBM is a registered trademark of International Business Machines.
AT is a trademark of International Business Machines.

```

}
}

/* add the cpu type to FEATURES -- see listing 3 */
feature = cputest(feature);

/* check for numeric data processor -- see listing 4 */
feature = test_ndp(feature);

/* add the video display type to VIDEO_FEATURES -- see listing 6 */
video_features = video_test(feature);

/* check if ANSI.SYS is present -- see listing 7 */
if (check_ansi()) {
    video_features |= ANSI;
} else {
    putch(0x0D); /* This cleans up any garbage left on the screen */
    putch(' '); /* by the ANSI check if ANSI.SYS is not present */
    putch(' ');
    putch(' ');
    putch(' ');
    putch(' ');
    putch(0x0A);
    putch(0x0D);
}

return (feature);
}
}

```

Listing 3: A C-callable assembly language routine for determining the type of microprocessor used in an IBM PC compatible.

; Cputest.asm is the Lattice C-callable assembly language routine that determines
; the machine's processor type. Copyright (c) 1986 Dan Jacobs and Joel Rosenblum

```

name      cputest          ;determine CPU type
include   dos.mac         ; Lattice C memory model configuration macro
                          ; In this case it is a copy of dm8086.mac

; processor type equates
CPU_88    equ 01H         ; Intel 8088 - 8086
CPU_186   equ 02H         ; Intel 80188 - 80186
CPU_286   equ 04H         ; Intel 80286
CPU_V20   equ 08H         ; NEC V20 - V30

PSEG

comment\*****\

NAME
    cputest
SYNOPSIS
    unsigned int cputest (features)
    unsigned int features;          see definition of machine type
DESCRIPTION
    returns features with the proper active CPU type or'ed in

*****\

cputest    public  cputest
           proc   near

           push   BP          ; save the frame pointer (if called from C)
           mov    BP, SP

           mov    AX, 4[BP]   ; next, save the passed existing features

```

(continued)

PC-DESK TAKES YOU BEYOND SIDEKICK

PC-DESK. The Ultimate in Desk-Top Management

Now, finally at your command. A completely integrated word processor, calendar/reminder, name/address/phone database and directory. Letter/label/report printer, mailmerge, invoice system and printing calculator.

PC-Desk does just about everything you need. It's a powerful and easy-to-use tool that reduces your work and makes your business life easier. And, it does more than hundreds of higher-priced programs.

Look At Everything You Get!

Easy Instructions

Step by step directions on the screen. You'll always know what codes to use. Even if you're new to computers, you'll be efficient right away.

Calendar/Reminder

24 reminders per day. Reminder days are highlighted. Put the cursor on any day. . . all your reminders pop up. See a full month at a time. Flick back and forth between months. Print reminders with a single key-stroke. You're organized and you'll stay organized.

To Do List

Tracks up to 20 projects. You'll never forget what you need to do.

Word Processor

Full-featured. . . why use any other word processor? PC-Desk gives you professional-looking documents. . . with bold, underlining, centering, and justification. Word wrap, block move, search, margin settings. And no waiting for screens to come up with Turboscreen.

Personal Address Book

Automatically printed in a pocket-sized format. Cross-indexed by company name. Breast-pocket holder free when you order PC-Desk.

Database

Outstanding organization and flexibility. Easy to access and maintain. Name, address, phone number (work and home), salutation, title, date, variables for automatic printing, comments, and more. Sort on zip, or alphabetically by name or company. Search, scroll through, change or delete.

SideKick is a registered trademark of Borland International, Inc. IBM is a registered trademark of International Business Machines Corp.

The Most Powerful Feature

PC-Desk automatically prepares your letters, invoices and memos.

It's fast and easy to send individually typed, personalized letters, either singly or by the hundreds. Just select the names you want. Tell PC-Desk which letter to send, and it does the rest.

It puts in the special greeting you use for each person. It adds the variable information you want. . . the shipment date, company or product name, or

whatever you choose. All at the touch of a button.

PC-Desk is simply spectacular. Users say, "This is the way software ought to be!" Try it for 60 days. If you're not completely satisfied, return it for a full refund.

Free Updates, Free Support.

That's right. Free updates. (Remember, if you already own PC-Desk, send for your free update to version 6.5.)

And, if you ever need help, just call us. We'll talk you through it.

Select names for group mailings. Make notes on client contact. Print your rolodex, envelopes, (with return address too), letterheads, invoices, labels, entire name and address file.

Mail Merge

Fully integrated with database. Letters with up to four variables.

Calculator

Print your calculations. Pops up into word processor. Hex, binary, and octal for programmers.

Memory Partitioning

Lets you flip back and forth between PC-Desk and other programs. Cut and paste.

Logs

Client billing, computer use, telephone, and expense logs. Great for tax records! Print monthly statements with total time and expenses. Edit your logs. With auto-dialer calls are logged automatically.

Auto-Dial

Save time! Auto-dial any phone number in your database. Choose work or home number.

Encrypt

Protect your files from prying eyes.

DOS Functions

Copy, delete, print, view, rename files easily.

On-Screen Clock

Full instructions.

Manual

Full instructions.

Not Copy

Protected



PC-DESK SIMPLY THE BEST.

To order, or for more information:

Call Toll Free 1-800-A-PC-DESK

YES! Rush me the best—PC-Desk.
60-Day Money-Back Guarantee.

★ **SPECIAL OFFER** ★

Only \$79

(plus \$5.00 Shipping & Handling).

You save \$46 on the regular \$125 price.

Offer Expires in 30 Days

Check Money order
 MasterCard Visa

Card # _____

Expiration date _____ / _____

Name _____

Firm _____

Address _____

City _____

State/Zip _____

Requirements: IBM-PC, AT, XT, or compatible. 128K for program, 272K for memory partitioning, MS-DOS 2.0. Modem required for Auto-Dial only.

```

    push    AX
; check for 8088 or 8086 by using the SHR instruction since the
; 8088 and 8086 do not mask cl with 07H before executing the shift.
    mov     CL, 20H
    mov     AX, 1
    shr     AX, CL
    test    AX, AX           ; if after the shift AX is the same
                           ; as before, it's an 8088 - 8086 or V20 - V30
    jnz     check_80186     ; else, continue checking other Intel CPUs
; check for V20 or V30 by detecting if PUSH A is a valid instruction
; on the NEC CPUs
    mov     BX, SP          ; save SP
    pusha
    cmp     BX, SP          ; if SP has not been decremented, then
    je      is_88           ; it's an 8088 - 8086
                           ; else, we restore registers
    popa
    mov     AX, CPU_V20
    jmp     return
is_88:    mov     AX, CPU_88
          jmp     return
check_80186:
; check for the 80188 or 80186 by detecting if SP is updated
; before or after it is pushed.
    push    SP
    pop     BX
    cmp     BX, SP
    je      is_286         ; if updated after, it's an 80286
                           ; else, it's an 80186 or 80188
    mov     AX, CPU_186
    jmp     short return
is_286:   mov     AX, CPU_286

return:   pop     BX          ; recall saved features
          or     AX, BX      ; and or cputype into other features bits
          pop     BP
          ret
cputest   endp
          ENDPS
          end

```

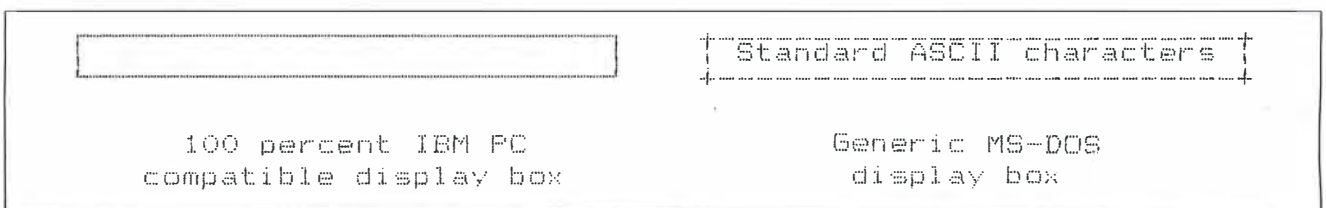

Figure 1: Two boxes drawn by the routine in listing 8, on a system that has the IBM extended character set available (left) and on a system that does not and uses only ASCII characters (right).

assume that a machine has an extended character set if it has the IBM-COMPAT bit set in the variable FEATURES.

The sample program in listing 8 shows how to draw a simple box that could take advantage of the machine's ability to use the IBM extended character set. The draw_box routine uses the IBMCOMPAT bit flag contained in FEATURES to determine which character set can be displayed. Figure 1 shows the difference between boxes

drawn with the two sets.

The draw_box routine uses a routine called move_cursor, which is contained in listing 9. Whereas draw_box uses a bit flag set in FEATURES, move_cursor relies more directly upon the video hardware. Thus, it uses bit flags set in VIDEO_FEATURES, as well as a bit set in FEATURES. Move_cursor then moves the cursor to the position row, column. It decides which method is needed to move the cursor on your

particular machine without burdening the calling program with the task.

Note that if your program detects the presence of ANSISYS operating on a machine that is IBMCOMPAT and sets screen attributes using BIOS-level video calls, then it should not use the low-level video DOS calls to display additional text. To do so will overwrite the attributes you have just set with what ANSISYS believes the attributes to be. Complicated prob-

(continued)

NEW F R O M CompuClassics

SOFTWARE

WORD PROCESSORS

LEADING EDGE	
Word Processor with Merge & Spell	79.00
LIFETREE	
Volksword 3	159.00
MICROPRD	
Wordstar	179.00
Wordstar Propack	249.00
Wordstar 2000	245.00
MICROSOFT	
Word (Version 3)	279.00
MULTIMATE	
Multimate	235.00
Multimate Advantage	319.00
SATELLITE SOFTWARE	
Word Perfect	219.00
Word Perfect Library	59.00
WORD PROCESSING UTILITIES	
BORLAND INTERNATIONAL	
Turbo Lightening	62.00
LIVING VIDEOTEXT	
Thinktank	99.00
MAX THINK	
Max Think	49.00
WRITING CONSULTANTS	
Word Finder	60.00
DATA BASE MANAGEMENT	
ASHTON TATE	
dBase III Plus	419.00
BORLAND INTERNATIONAL	
Reflex	85.00
LEADING EDGE	
Nutshell	69.00
M. D. B. S.	
Kman II	299.00
Kman Bundle	369.00
MICRORIM	
RBase 5000	269.00
Clout II	145.00
RBase System V	CALL
DATABASE UTILITIES	
FOX & GELLER	
Quickreport	145.00
NANTUCKET	
Cipper	359.00
SOFTWARE TOOLS	
Viewgen	49.95
SPREADSHEETS/ INTEGRATED SOFTWARE	
ASHTON TATE	
Framework II	429.00
COMPUTER ASSOCIATES/I.U.S.	
Supercalc 4	295.00
DIGITAL RESEARCH	
GEM Draw	159.00
GEM Collection	119.00
GEM Desktop	32.00
LOTUS	
Lotus 1-2-3 Version 2	339.00
Symphony	449.00
MICROSOFT	
Multiplan	129.00
MIGENT SOFTWARE	
Ability	59.00
PAPERBACK SOFTWARE	
VP Planner	59.00
SOFTWARE GROUP	
Enable	359.00
SOFTWARE PUBLISHING	
PFS File, Write, Plan	80.00 each
PFS Report	69.00
SYMANTEC	
Q & A	225.00

ADVANTAGES

- Orders placed before 3 p.m. (PST) shipped same day.
- We welcome corporate accounts.
- Free technical support.
- Immediate replacement of defective goods.
- Bulk discounts.
- One million dollar inventory.

SPREADSHEET UTILITIES

CAMBRIDGE CO-OPERATIVE	
Spreadsheet Analyst	75.00
LOTUS	
1-2-3- Report Writer	115.00
TURNER HALL	
SQZ	59.00
PRESENTATION GRAPHICS	
AMERICAN SMALL BUSINESS	
Prodesign II	199.00
BLOC DEVELOPMENT	
Form Tool	42.00
DECISION RESOURCES	
Chartmaster	209.00
Signmaster	145.00
ENERTRONICS RESEARCH	
Energraphics 2.0	329.00
GRAPHICS COMMUNICATIONS	
Graphwriter Combo	329.00
Freelance	219.00
MICROGRAFX	
PC Draw	159.00
In-A-Vision	199.00
Windows Draw	85.00
MICROSOFT	
Chart	189.00
SPRINGBOARD	
Newsroom	32.00
T-MAKER	
ClickArt Personal Publisher	129.00
UNISON WORLD	
Printmaster	32.00
Art Gallery I & II	22.00 each
PROJECT MANAGEMENT	
BREAKTHROUGH	
Timeline	235.00
COMPUTER ASSOCIATES/I.U.S.	
Superproject Plus	279.00
HARVARD SOFTWARE	
Total Project Manager	279.00
SCITOR	
Project Scheduler Network	339.00
ACCOUNTING	
COMPUTER ASSOCIATES/I.U.S.	
Each Accounting Module	309.00
Payroll	389.00
Easy Plus	89.00
OPEN SYSTEMS	
GL/AR/AP/Payroll/Inventory	429.00
Purchase Order/Sales Order/Report Writer	379.00
Resource Manager	239.00
SBT	
Accounting Software for dBase III	
dLedger/dPayroll/dProject	275.00
dOrder/dInvoice/dPurchase	145.00
PERSONAL MANAGEMENT/ INVESTMENT	
MECA	
Managing Your Money	99.00
MONOGRAM	
Dollars & Sense	99.00
COMMUNICATIONS/ TERMINAL EMULATION	
HAYES	
Smartcom II	95.00
MERIDIAN TECHNOLOGY	
Carbon Copy	109.00
MICROSTUF	
Crosstalk XVI	99.00
Remote	99.00
PERSOFT	
Smartterm 220	149.00
SOFTKLONE	
Mirror (Crosstalk Clone)	29.00
UTILITIES	
BORLAND INTERNATIONAL	
Superkey	40.00
Sidekick (Unprotected)	48.00
Travelling Sidekick	40.00

- Immediate shipment on purchase orders from qualified institutions (schools and universities included).
- No hidden charges.

TERMS:

All prices subject to change without notice. We do not guarantee compatibility. No surcharge for VISA or MasterCard. 2% surcharge

CENTRAL POINT

Copy II PC	29.00
Copy II Option Board	90.00
EXECUTIVE SYSTEMS	
X-Tree	32.00
FIFTH GENERATION	
Fastback	99.00
MICROSOFT	
Windows	65.00
PERSONICS	
Smart Notes	49.00
PETER NORTON	
Norton Utilities	55.00
Norton Commander	37.00
QUAD SOFTWARE	
Copywrite	39.00
Zerodisk	55.00
SOFTLOGIC SOLUTIONS	
Disk Optimizer	37.00
Double Dos	37.00
Software Carousel	25.00
STERLING SOFTWARE	
Intelligent Back-up	79.00
PROGRAMMING LANGUAGES	
BORLAND INTERNATIONAL	
Turbo Pascal W/8087 & BCD	59.00
Turbo Database Toolbox	40.00
Turbo Tutor	22.00
Turbo Graphix Toolbox	40.00
Turbo Jumbo Pack	139.00
LIFEBOAT ASSOCIATES	
Lattice C Compiler	259.00
MICROSOFT	
Macro Assembler	95.00
Fortran Compiler	219.00
Quick Basic	65.00
C Compiler	289.00

HARDWARE

MEMORY/MULTIFUNCTION BOARDS

A.S.T. RESEARCH	
Six Pack Plus w/64k	170.00
Six Pack Premium w/512k	409.00
Rampage PC with 256k	275.00
Rampage AT with 512k	485.00
PARADISE SYSTEMS	
Five Pack with 0 k	120.00
TALLTREE SYSTEMS	
JRAM 3 PC with 0 k	195.00
JRAM 3 AT with 0 k	245.00
JLASER	270.00
GRAPHICS CARDS	
HERCULES	
Monochrome Plus	185.00
Color Card	159.00
PARADISE	
Modular Graphics Card	219.00
EGAAuto Switch Card	359.00
SIGMA DESIGNS	
Sigma 400	425.00
Sigma EGA	349.00
TEGMAR	
EGA Master	305.00
ZUCKERBOARD	
Color Card (No parallel Port)	59.00
Color Card (Parallel Port)	79.00
Monochrome Graphics (Hercules Compatible)	79.00
I-O Mini w/clock calendar, parallel & serial port	75.00
MODEMS	
HAYES	
1200	399.00
1200B with Smartcom II	379.00

American Express. No returns without RA#. Short shipments must be notified within 48 hours. 15% restocking fee on non-defective goods: \$3.00 C.O.D. charge. Shipping \$4.00 per item, less on bulk orders. (\$8.00 Blue Label.) (Higher for some hardware items.)

MIGENT

External Modem-1200 Baud	99.00
PRACTICAL PERIPHERALS	
1200 Internal half-card	140.00
MONITORS	
AMDEK	
310 A	155.00
MAGNAVOX	
Monochrome Monitor (Amber/Green)	90.00
Color (320X200)	279.00
NEC	
NEC Multisync	575.00
PRINCETON	
Max 12E	165.00
HX 12	469.00
SR 12	629.00
PRINTERS	
C. ITOH DIGITAL GROUP	Call for Prices
CANON	
LBP-8A1 Laser Printer	2,285.00
CITIZEN	
120D	199.00
Premiere 35 LQ	475.00
EPSON	Call for Prices
NEC	
Pinwriter P5	1,159.00
Pinwriter P6	529.00
OKIDATA	Call for Prices
TOSHIBA	
P321	580.00
P351	1205.00
CALL FOR ALL PRINTER ACCESSORIES	
PLOTTERS/ PRESENTATION SYSTEMS	
POLAROID	
Polaroid Palette	1,499.00
SOFTWARE GARDEN	
Dan Bricklin's Demo Program	60.00
HARD DISKS/ TAPE BACK-UPS	
12 INTERFACE	
10 MB External Tape Back-up	579.00
IRWIN MAGNETICS	
10 MB Internal Tape Back-up	549.00
20 MB Internal AT Tape Back-up	859.00
MOUNTAIN	
20 MB Hard Card	825.00
SEAGATE	
20 MB Hard Disk with Controller	469.00
INPUT DEVICES	
KEYTRONICS	
KB 5151	175.00
MICROSOFT	
Mouse with PC Paintbrush	129.00
MOUSE SYSTEMS	
Mouse Systems Mouse with DR Halo II	99.00
SURGE PROTECTION/ BACK-UP POWER	
COMPUTER ACCESSORIES	
P15 Power Director	115.00
EPD	
EPD Lemon 6 Outlet	32.00
IBC/TADRAN	
AT Replacement Battery	27.50
KENSINGTON	
Masterpiece	89.00
Masterpiece Plus	115.00
RAM CHIPS/ CO-PROCESSORS	
Intel, NEC, Toshiba, etc.	Call for prices
COMPUTERS	
PC/XT Compatible Computers	
(FCC & UL Authorized)	
Complete PC Systems from under \$850.00	
Complete XT Systems from under \$1,150.00	
Call for price quotation	
We can build the system according to your needs	

Order desk & technical support open: 8 a.m. to 6 p.m. Monday-Friday 10 a.m. to 2 p.m. Saturday (PST) 6934 Canby St. Suite #109-110 Reseda, CA 91335
Call for prices for any item not included in this price list.

1 818 705-1895 US

1 800 231-6603 CA

1 800 328 4473 US

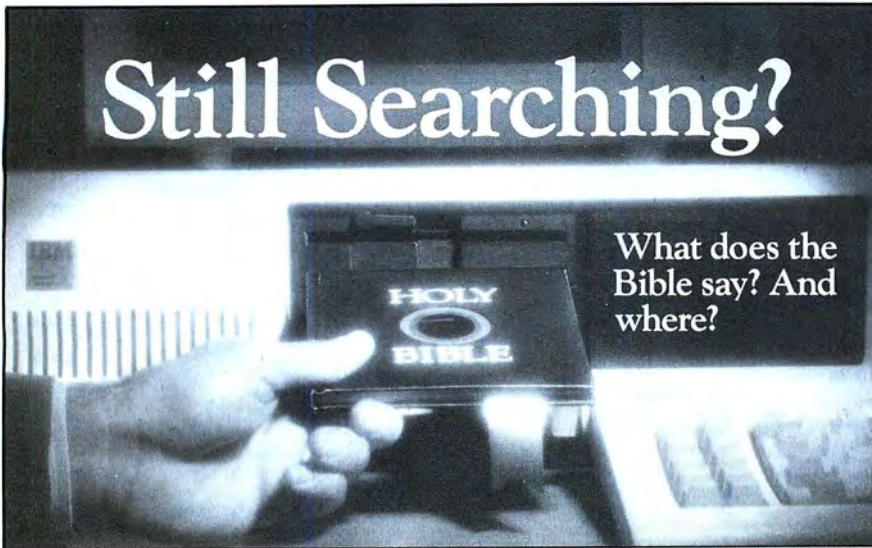

We offer an integrated family of software products that allow you to search the Bible as never before.

With "THE WORD Processor" software (which includes the complete text of the KJV or NIV Bible) you can create indexes on key words, phrases, even concepts, as well as search, display or print, for just \$199.95. Greek and Hebrew Transliterator products which include Strong's Concordance are also available. Or choose from a host of other exciting Biblical software products available in varying price ranges.

So if you're still searching, give us a call. We're anxious to show you how your PC can help you access your Bible as never before.



2013 Wells Branch Parkway, Suite 304
Austin, Texas 78728 (512) 251-7541

Include \$3.00 for postage and handling. For Apple, IBM PC, Commodore 64, TRS80, Kavra, CPM 2.2, MS-DOS

COPY II PC™ OPTION BOARD

AN ALMOST FOOLPROOF WAY TO MAKE ARCHIVAL BACKUPS OF PROTECTED SOFTWARE!

The Copy II PC Option Board is an add-in board that will give your PC the same disk duplication technology used by most disk duplication firms (who put the copy protection on software in the first place).

DUPLICATES NEARLY ALL PROTECTED DISKETTES.

The Option Board can easily backup almost all protected diskettes for the IBM PC (except those "protected" by physical disk damage), including ones software-only backup programs can't touch. It even includes a track editor that will allow the more technically inclined to look at protection schemes and edit any data on a diskette.

The Option Board uses a full size slot in an IBM PC, XT or AT (with at least 1 360KB floppy disk drive), Zenith 150, Compaq Deskpro. Extra \$15 cable required for Compaq Portable, HP Vectra and Tandy 1000. Tandy 1000 requires 256K of memory.

Call 503/244-5782, M-F 8-5 (West Coast time) with your in hand. Or send a check for \$95.00 U.S. plus \$3 s/h, \$15 overseas. Please specify your computer brand when ordering so we can send you the correct cable.

\$95.00

Central Point Software, Inc.
9700 S.W. Capitol Hwy., #100
Portland, OR 97219



Backup utilities also available for the Macintosh, Apple II, Commodore 64/128 and Atari ST.

lems like this are easier to solve with the availability of some of the seemingly unrelated bit flags. Parts of your program gain compatibility and performance on some machines but not on others. Here's a scenario.

Incorporating processor- and speed-detection procedures into your program allows for run-time performance determination of the PC compatible. Based on that run-time analysis, you could enable sections of optimizing code in the program by setting your program's "performance bit flags." For example, a multiuser spreadsheet program that allows for multiple users only if operating on an 80286-based system could determine if the processor type was an 80286. If so, a flag within the software could be set that allows multiuser capability. Then detection would proceed to determine the presence of a math coprocessor. If an 8087 or 80287 was detected, a bit would enable use of the hardware-based math routines. Finally, your device time-out loops could be adjusted according to the results of the processor-speed check. Combining this analysis with the screen display lets your spreadsheet program allow charts and plots to appear on the screen, if possible.

Didn't we mention the salt mines? We have eliminated some of your work, but good programs come from good design. You now have a program that appears to be hardware-intelligent and contains performance increases to match. This combination keeps your users happy and helps you sell more software. Meanwhile, you can go back to the salt mines and write the next software masterpiece.

Editor's note: The listings from this article are available on disk, in print, and on BIX. See the insert card following page 176 for details. Listings are also available on BYTEnet. See page 4. Listings 1, 2, 5b, 7, 8, and 9 are C source code and are available as the file PERPROPC.C; listings 3, 4, 5a, and 6 are assembly language code and are available as the file PERPROPC.ASM. You will need the Lattice C compiler or a compatible C compiler to use the source code listings. ■

APPARAT INTRODUCES THE...

LIMBO*



You've got a problem. You have 640K of RAM and you still run out of memory! Go to your favorite computer store. Then ask about expanded memory cards. See the problem? Just too many to pick from. Now, ask to see the **LIMBO™**. No problem. There's only one. Ours. Except you probably don't know a **LIMBO** from a dance step. Maybe you guessed that it is an expanded memory board that supports the Lotus/Intel/Microsoft Expanded Memory Specification (EMS). And that it has a 2 MB capacity and up to 8 MB is supported by the memory management software.

The **LIMBO** includes a clock/calendar and 8 banks for use by either 64K or 256K DRAM. Software includes the EMS memory manager, EMS compatible RAM Disk and print spooler.

The **LIMBO** is manufactured by Apparat in Denver, Colorado, and is covered by Apparat's Exclusive Limited Lifetime Warranty. So you can be confident that you won't find yourself out on a limb. (We've been in business since 1978.)

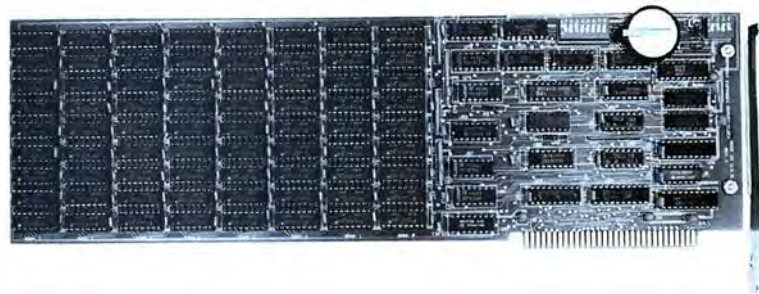

Need an EMS multifunctional board? Ask to see the **LIMBO II**. The **LIMBO II** has a 1.25 MB capacity with a parallel port, a serial port, a clock/calendar, and game-stick adapter. **LIMBO** and **LIMBO II** have flexible starting addresses and can be set to fill system memory to 640K, with the remaining memory to be used for EMS. This eliminates the need for conventional RAM boards.

The **LIMBO** is only \$199 with 64K of RAM installed or \$549 with full 2 MB of RAM installed.

The **LIMBO II** is only \$299 with 256K of RAM installed or \$499 with full 1.25 MB of RAM installed.

Go check out the **LIMBO** at the same store carrying other expanded memory boards. If they don't have the **LIMBO**, have them call us: 800/525-7674. Or write: **Apparat, Inc.**, 6801 South Dayton, Englewood, Colorado 80112, 303/799-0819.

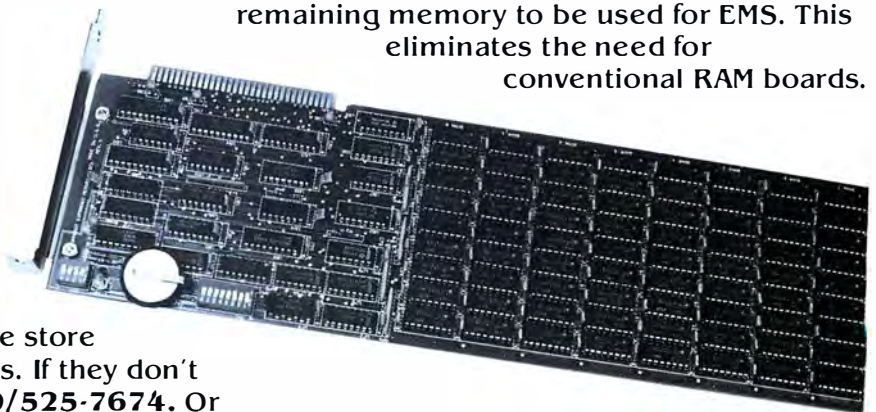

NOTE:
The LIMBO
boards work great
with Lotus 1-2-3
Release 2.



Apparat, Inc.

Inquiry 21

6801 South Dayton, Englewood, CO 80112 — Customer Service 303/799-0819
Retail Outlet in the Chicago area 312/640-0322

* Lotus Intel Microsoft EMS Board

* Lotus is a registered trademark of the Lotus Development Corporation. * Intel is a registered trademark of the Intel Corporation. * Microsoft is a registered trademark of the Microsoft Corporation.

OUR PLUG-IN CARD GIVES YOU PLUG-IN CONTROL.

PC ϕ 488 allows your IBM PC/XT/AT or compatible to control IEEE-488 instruments.

WHAT ADDITIONAL SOFTWARE DO I HAVE TO BUY?

None. **PC ϕ 488** supports all popular programming languages including interpreted and compiled BASIC, TBASIC™, Microsoft® Pascal, Turbo™ Pascal, C, and FORTRAN. You can use Tektronix® Standard Codes and Formats and emulate HP controller statements.

PC ϕ 488 also runs IBM's IEEE-488 software as well as application programs.

IS IT DIFFICULT TO USE?

You just plug it in. **PC ϕ 488** is totally self-contained with all software packaged in read only memory. Documentation includes a complete tutorial and programming reference, plus more than thirty application programs.

WILL IT WORK WITH ALL MY INSTRUMENTS?

You bet! More than 500 companies, including every major instrument manufacturer in the U.S. and Europe, are currently using **PC ϕ 488**.

WHAT'S THE BOTTOM LINE?

That's the best part. **PC ϕ 488** costs just \$395 including software support for all popular programming languages, extensive applications library, and the programming and reference manual. Order today by calling (617) 273-1818 or Telex 247316.



cec

Capital Equipment Corporation
10 Evergreen Ave., Burlington, MA 01803.
(617) 273-1818, Telex 247316.

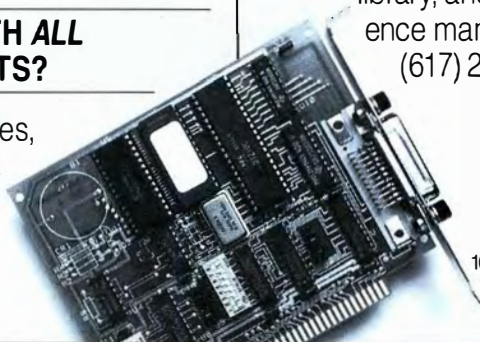

RAM-LOADABLE CHARACTER SETS FOR THE IBM PC

How to create and use RAM-based character fonts

BY RICHARD WILTON

MOST IBM PC users take for granted the size and shape of the characters on their video displays. However, the newer video display adapters from IBM and Hercules let you change the font of the displayed characters, as well as the set of displayable characters, without compromising the display's speed or clarity.

The ability to display characters of arbitrary size and shape helps programmers make the user interface more natural. For example, a word-processing program can display characters exactly as they will appear on the printed page. Foreign-language alphabets, mathematical symbols, and simple graphics elements can all appear on a single screen.

Almost all the video display adapters available for the IBM PC can display some sort of customized character set (see table 1). Some adapters provide more built-in support for custom character sets than others. In general, a greater amount of hardware and firmware support simplifies character-set software and delivers greater speed.

There are two general approaches to displaying customized character sets on an IBM PC. One is to define and display each character with special software routines. The other is to load a table containing formatted descriptions of each character into RAM where a hardware character

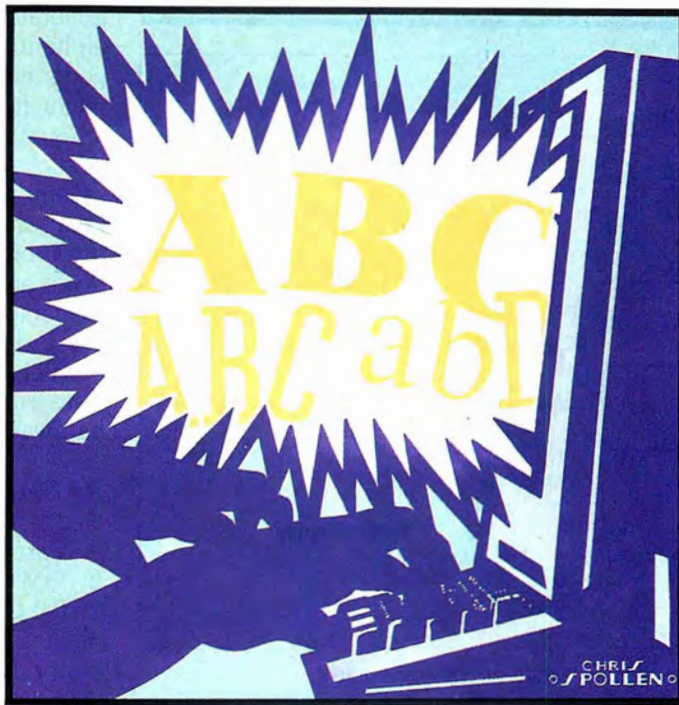

generator can display them. I will focus on programming for such RAM-loadable fonts. I'll explain how to create them and how to apply them on commonly available IBM PC video adapters.

ALPHANUMERIC CHARACTERS

A close look at the characters on your video display reveals that each one is composed of a group of dots. A hardware or software character generator puts the dots on the screen in the patterns that you see as individual characters.

To display alphanumeric characters using an IBM PC video adapter, you must store the code for each character in a buffer in the adapter's video display RAM. Data bytes in the video

display buffer represent these character codes. Each 8-bit byte from 0 to 255 (0 to 0FF hexadecimal) is interpreted as a character code that corresponds to a single character in an extended ASCII character set.

Every IBM PC video adapter includes a hardware character generator that displays the dot pattern corresponding to the character codes in the video display buffer. The dot patterns are stored in an 8K-byte table in ROM and are indexed by the character code. Thus, for each character code in the video display buffer, the character generator copies the corresponding dot pattern to the video display screen (see figure 1).

SOFTWARE CHARACTER SETS

Many IBM PC video adapters support one or more *all-points-addressable* (APA) display modes that let you place individual dots directly on the display. Such adapters can interpret the data in the video display buffer as a bit stream that corresponds to the appearance of points on the screen. You can draw characters on the display by setting the appropriate bits in the video display buffer.

[Editor's note: There are 7 programs that illustrate many of the concepts explained in

(continued)

Richard Wilton is a software developer with Laboratory Microsystems Inc., 3007 Washington Blvd., Marina del Rey, CA 90295.

Table 1: Support for custom character sets on video display adapters.

	APA graphics	BIOS support for APA graphics characters	RAM-loadable character sets
MDA	no	no	no
CGA	yes	yes	no
PCjr	yes	yes	no
EGA	yes	yes	yes
HGC	yes	no	no
HGC Plus	yes	no	yes

acters for APA graphics. The address of your character-definition table is passed to the BIOS using interrupt 10h, function 10h. When the BIOS is subsequently called upon to display graphics characters, the BIOS routine uses your character-definition table in RAM rather than its default table in ROM.

Whether you write them yourself or use the ones provided in IBM's ROM BIOS, such APA software character generators are much slower than an alphanumeric hardware character generator. One reason is that you might need to write a considerable amount of code to implement a practical character-set generator. Even in assembly language, executing a sizable subroutine just to display a character of text can significantly slow down an application. Also, you have to manipulate much more data in the video display buffer when you draw each character explicitly. Lastly, software runs much more slowly than hardware.

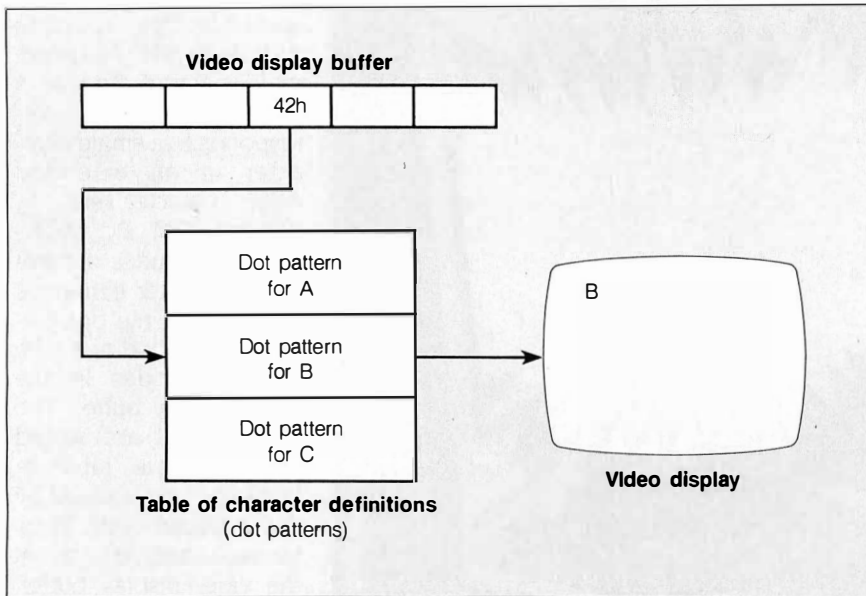

Figure 1: A block diagram for an alphanumeric character generator.

RAM-LOADABLE CHARACTER SETS

A reasonable compromise adopted by IBM on the EGA and by Hercules on the Graphics Card Plus is to implement a hardware character-set generator that can use a table of character definitions that you load into RAM rather than store permanently in ROM. This approach does not provide as much flexibility as the use of a software character generator but preserves the speed advantage of using a hardware character generator.

Using a RAM-loadable character set requires that you accomplish three programming tasks. First, you must create a table containing the dot-pattern definitions for your character set. Second, you must load the character-definition table into RAM. Third, you have to program the video adapter's CRT controller to display your characters.

CHARACTER-SET DEFINITION

To define a character set, you create an ordered list of the dot patterns that

(continued)

this article. They are available on disk, in print, and on BIX. See the order card following page 176 for details. Listings are also available on BYTENet. See page 4.]

Because it is under software control, this table-driven technique is extremely flexible. The characters you draw can be virtually any size and shape. Using a software character generator is also the best way to mix text with graphics images because you have point-by-point control over arcs, lines, and other graphics elements as well as text characters.

IBM's Color Graphics Adapter supports a software character generator in its ROM BIOS. The routine uses the address in interrupt vector 1Fh [Editor's note: For the remainder of the article, all interrupt vectors and addresses will be

in hexadecimal.] to locate a character-definition table for ASCII characters 80 through FF. If you store the address of your own character-definition table in this interrupt vector, the BIOS character-generator routine will use your character set for ASCII characters 80 through FF hexadecimal (see the program CSLS2.ASM for an example).

Unfortunately, the BIOS definitions for ASCII characters 00 through 7F hexadecimal are always taken from a table in ROM at address F000:FA6E. Thus, you still need to do some special programming if you want to customize the first 128 ASCII characters, 00 through 7F.

However, IBM's Enhanced Graphics Adapter lets you define all 256 char-

Alloy . . . We're Writing the Future of Multi-User PCs

PC-PLUS — The Fastest Growing Multi-user PC Solution

1984 Alloy introduces PC-PLUS — a revolutionary multiuser, multiprocessor architecture for PCs. Amidst the confusion of LANs and time-sharing approaches, RTNX and PC-SLAVE/16 provides a unique, high-performance solution. What LANs promised, PC-PLUS delivered. Faster. Easier to install and use. Less Expensive.

1985 ATNX with its lightning-fast disk caching supports AT-class machines. File and record locking — plus controls to manage file access. Disk volumes greater than 32 Mb. DOS 3.X machines can reach the peak of multiuser performance.

1986 NTNX and PCST/G graphics terminal continue the tradition. NTNX lets PC-PLUS run multiuser applications written for Novell NetWare and MS-NET. PCST/G brings high-resolution, Hercules-compatible graphics to PC-PLUS workstations.

AND BEYOND We've written the history of multiuser PCs, and we're writing the future . . . with PC-compatible multiuser systems.



The LAN Alternative

PC-PLUS . . . the perfect solution for sharing data among users. The 8MHz SLAVE/16 card operates at over twice the speed of typical PCs. Advanced bank-switched memory delivers data at bus speed. Many times faster than LANs. Engineering ingenuity makes PC-PLUS simpler and much easier to install than LANs or UNIX multiuser systems. While sharing disks, printers and other peripherals with single-user ease of operation.

The Optimum IBM Multi- user Solution . . . Made Possible by Alloy

The PC-PLUS family turns your single IBM personal computer or compatible into a fully integrated office solution. Up to 31 users can be added to the host — while maintaining full functionality of the PC. As needs grow, add more PC-SLAVE/16 cards and low-cost terminals.

The Choice of Vertical Market Resellers

PC-PLUS expands as business grows. In any vertical market. Law. Finance. Medicine.

POS. Real Estate. And more. That's why PC-PLUS is the fastest-growing multiuser solution among vertical market resellers. Today with a strong commitment to tomorrow.

Alloy PC-PLUS, RTNX, PC-SLAVE/16, ATNX, NTNX and PCST/G are trademarks of Alloy Computer Products, Inc. NetWare is a trademark of Novell, Inc. MS-NET is a trademark of MicroSoft, Corp. UNIX is a trademark of AT&T Information Systems.

The PC-PLUS is available from:

ALLOY
Computer Products, Inc.

Alloy Computer Products, Inc., 100 Pennsylvania Avenue, Framingham, Massachusetts 01701. (617) 875-6100, TWX: 710-346-0394
Alloy Computer Products, Inc., 9 Executive Circle, Suite 240, Irvine, California 92714. (714) 261-7661
In Europe: Alloy Computer Products (Europe) Ltd., Cirencester, Gloucestershire, England. Tel. 0285-69571, Tlx: 43340
In Australia: Alloy Australia Pty. Ltd., 5 Enterprise Court, Mulgrave, Victoria, Australia 3170. Tel. 011-613-561-4988

make up the characters. Usually, the order in which the characters appear corresponds to the ASCII character sequence. Of course, many applications demand the use of other character-set sequences. For example, you might want to use the EBCDIC character sequence, a foreign-language character set, or even a set of graphics

'tiles' that you could piece together to form larger graphics images.

The HGC Plus character generator uses a table in RAM that defines each character in exactly 16 bytes. This means that the maximum size of a character in the table is 8 dots wide (the size of 1 byte) by 16 dots high. If you wish to define a character set

in which the characters are less than 16 dots high, you need to pad each character definition out to a total of 16 bytes. When you program the HGC Plus's video controller to display characters that are less than 16 rows high, the extra padding is ignored.

The EGA's character-generator table is similar except that it has a 32-byte-per-character format. This means that character sets that utilize a small dot matrix contain a significant amount of padding. For instance, a table that defines an 8- by 8-dot character set would contain 75 percent padding.

For this reason, the EGA's ROM BIOS provides a routine that loads a table that includes no padding between characters. If your characters are defined in an 8- by 6-dot matrix, for example, each character definition is exactly 6 bytes long. If you save character-set definitions in disk files, this "compressed" format can save a fair amount of space. Also, since the ROM BIOS character-definition tables are stored in a compressed format, you can use the same EGA BIOS routine to load them into RAM as well. (The programs CSL54.ASM and CSL55.ASM contain examples of compressed and padded character-definition tables.)

MAPPING CHARACTER-GENERATOR RAM

You have to know exactly where in RAM to store your character-set definition table. Because the architecture of RAM differs among video display adapters, the way you load your character set into RAM is hardware-dependent.

All IBM PC video display adapters are designed with the video display refresh buffer located in RAM, built onto the adapter itself. When you use RAM-loadable character sets, this on-board RAM is partitioned so that a portion is used to store the character-set definition table. The method of partitioning reflects the underlying architecture of the adapter's on-board RAM.

The HGC Plus can use the 64K bytes of RAM from B000:0000 through

IMAGINE WHAT YOUR COMPUTER COULD SAY WITH PC DIAL/LOG™

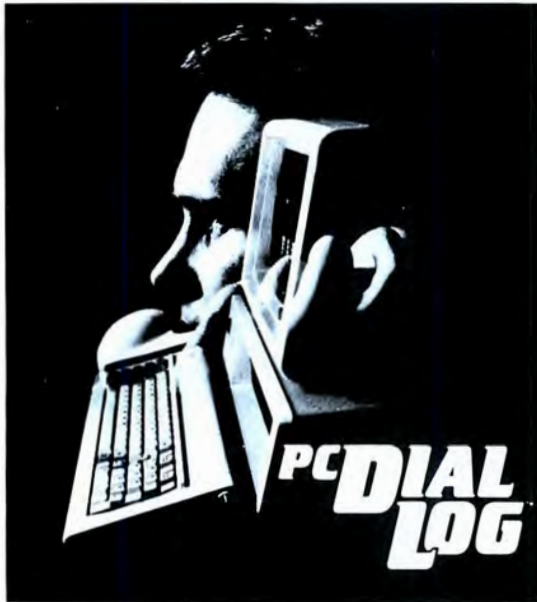

PC DIAL/LOG™ consists of an expansion card, software and a cable that connects a Touch Tone® telephone directly to your computer. When installed the PC Dial/Log™ automatically dials and answers the phone, saves and sends telephone messages and stores and forwards telephone calls.

IT'S SIMPLE, with direct installation and a menu-driven program. These features make PC Dial/Log™ convenient and easy to use.

UNPARALLELED VOICE QUALITY made possible by the Votrax® voice digitization process enables PC Dial/Log™ to deliver the best low-cost voice reproduction.

VOTRAX®'S SOFTWARE INTERFACE PROGRAM, THE TOOL KIT, created especially for the developer whose application includes PC Dial/Log™, will help save valuable programming time.

- Other Votrax® Products**
- Personal Speech System™
 - Type- 'N-Talk™ Stand-Alone Devices
 - IBM, Apple II, Commodore 64 Plug In Board Synthesizers
 - Votrax® Speech Chips

APPLICATIONS including appointment scheduling, telemarketing, marketing surveys, financial updates, inventory status reports, dispatching and order entry are just some of the many ways that PC Dial/Log™ can be used.

WE WELCOME DEALERS AND DISTRIBUTORS to contact Votrax® regarding our complete line of products. Our reputation has been built on quality products and outstanding customer service that are sure to satisfy you.

AN UNBEATABLE PRICE at only \$495*, PC Dial/Log™ is the lowest priced digital board available today. Please contact Votrax® directly for additional information.

* Plus shipping and handling.



VOTRAX/CMC Int'l, Inc.
"Technology That Talks"
 1394 Rankin, Troy, MI 48063
 1-800-521-1350
 In Michigan 313-588-0341
 TWX-8102324140 Votrax-TRMI
 For a voice demonstration call
 313-588-2926

C the Advantage.

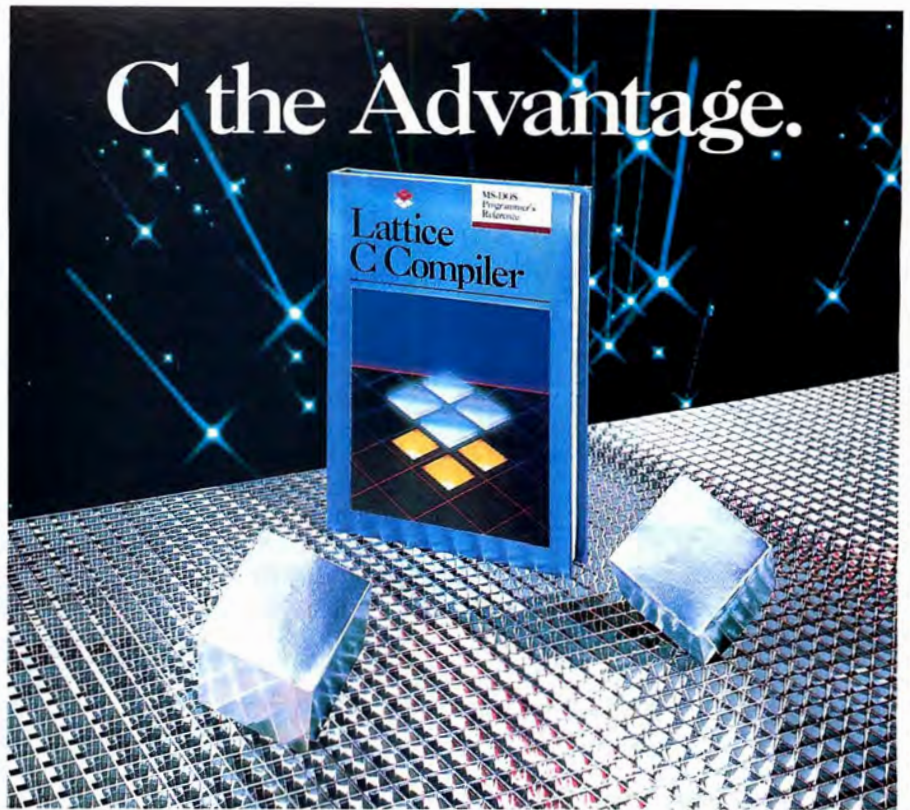

Introducing the Lattice® MS-DOS C Compiler, Version 3.

There's never been a better time to buy Lattice C. Professional programmers the world over have made Lattice C the standard compiler for serious MS-DOS programming. Now Version 3 offers even more of the features that have made our previous versions so popular. Our new compiler features include:

ANSI language constructs including, *unsigned* as a modifier, *void* data type, *enum* data type, structure assignments, structure arguments, structure returns, and argument type checking.

The compiler also incorporates improved code generation, more efficient stack overflow checking, in-line 8087 code generation, and 80186/80286 code generation.

The library contains more than 200 new functions, including: ANSI/UNIX/XENIX compatibility; extended support for MS-DOS; extended support for networking including file sharing, file locking, and I/O redirection; and flexible error handling via user traps and exits. Plus the library has also been re-engineered to produce much smaller executables.

Try the new Version 3 Compiler from Lattice. Because C-ing is believing.



Lattice

Lattice, Incorporated
P.O. Box 3072
Glen Ellyn, Illinois 60138
312-858-7950
TWX 910-291-2190

INTERNATIONAL SALES OFFICES:
Benelux: Ines Datacom (32) 2-720-51-61
Japan: Lifeboat Inc. (03)293-4711
England: Roundhill (0672)5-4675
France: SFL (1)46-66-11-55
Germany: (49)7841/4500 (49)8946/13290

B000:FFFF as a video display buffer. However, when you use a RAM-loadable character set, only the first 16K bytes serve as the display buffer. The remaining 48K bytes, starting at B000:4000, can contain your character-set definition table.

IBM's EGA has a different RAM layout. Individual pixels are represented by corresponding bits in four parallel bit planes. All four bit planes occupy the same range of addresses in the 8088's address space. Each plane is individually addressable by modifying the contents of special registers on the EGA.

The EGA's alphanumeric character generator uses only one of the four parallel bit planes as a display refresh buffer. One of the other three bit planes is then used to store up to 32K bytes of character definitions for the character generator.

LOADING A CHARACTER-SET DEFINITION

Since different video adapters have different hardware configurations of video RAM, you must tailor your font-loading routines to the hardware you use. This task is simpler on the EGA with its fairly complete ROM BIOS support for loading character-definition tables into video RAM. On the HGC Plus, you must write your own software routines to load a font into RAM.

As you have already seen, the EGA and the HGC require that your character-definition table reside at a particular location in video RAM. On the HGC Plus, this location is at B000:4000 (see figure 2a). You can copy the table to this location from somewhere else in memory. (The program CSL5.ASM shows an example of the copy operation.) If your character-definition data is stored in a disk file, however, you can read the data directly from the file to B000:4000. You can use MS-DOS function 3Fh of interrupt 21h to accomplish this.

Since the HGC Plus lets you use all 48K bytes of the on-board RAM between B000:4000 and B000:FFFF for your table, you can define up to 3072

(continued)

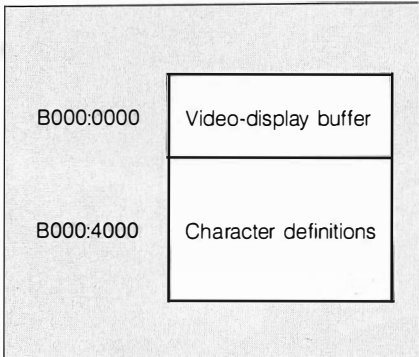

Figure 2a: Video RAM configuration for the Hercules Graphics Card Plus.

(49152/16) characters in a single table. However, the IBM PC BIOS and PC-DOS are capable of displaying only the first 256 characters. You can display all 3072 characters at one time only by changing the way character codes are stored in the video display buffer (this will be discussed further under "Extended Character Sets").

You must restrict the size of your character-definition table if your HGC Plus is installed in a system with another video adapter such as the IBM CGA, which uses RAM beginning at B800:0000 (B000:8000). In this case,

you must limit your character-definition table to the 16K bytes between B000:4000 and B000:8000. This is done by resetting bit 1 of the HGC Plus's configuration switch (I/O port 3BF). Using only 16K bytes lets you define up to 1024 characters in your table.

On the EGA, you can load your character definitions in up to four RAM locations in bit plane 2 of the EGA's on-board RAM (see figure 2b). The maximum size of each character-definition table is 8K bytes (256 characters times 32 bytes per character). The actual number of character tables you can load at one time depends on the amount of RAM on your EGA: One RAM-loadable character set is supported for every 64K bytes of RAM on the card. Thus, the basic 64K-byte EGA provides enough RAM for only one table, while the fully loaded 256K-byte card supports four character-definition tables at once (see figure 3).

Although you can define only 256 characters in each table, you can maintain up to four such tables in EGA RAM at once and display characters from any two of them at the same time. In other words, you can load as many as 1024 characters into RAM and display 512 of them at once.

The addresses of the 8K-byte tables are at 16K-byte increments in segment A000 (i.e., A000:0000, A000:4000, A000:8000, and A000:C000). Of course, if you want to write to these locations directly, you must selectively enable only bit plane 2 and disable the other three bit planes by programming the adapter's Sequencer Map Mask register. However, you may use EGA BIOS interrupt 10h, function 11h, to copy a character-definition table properly from any arbitrary address in RAM to any of the four available locations in bit plane 2.

PROGRAMMING THE VIDEO CONTROLLER

The third task you must accomplish in order to use a RAM-loadable character set is to program your video dis-

(continued)

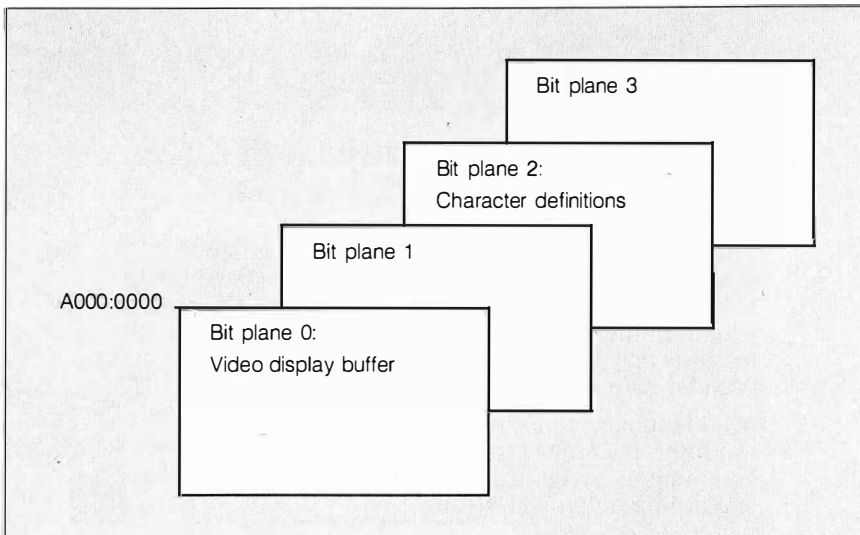

Figure 2b: Video RAM configuration for IBM's Enhanced Graphics Adapter.

Starting address		Total EGA RAM
A000:0000	8K character definitions	64K
	(Unused)	
A000:4000	8K character definitions	128K
	(Unused)	
A000:8000	8K character definitions	192K
	(Unused)	
A000:C000	8K character definitions	256K
	(Unused)	

Figure 3: Bit plane 2 of the EGA's character-set RAM.

Does your laser printer have enough power to produce a stunning document?

Only SoftCraft offers you: 1. Font variety, 2. Formatting power, 3. The ability to create custom characters and symbols.

Armed with Fancy Word, Fancy Font or Laser Fonts your laser printer becomes a high-quality alternative to expensive, time consuming typesetting services. SoftCraft products maximize your laser printer's potential by easily turning your newsletters, presentation materials, documents and invitations into works of art.

In fact, this ad copy was printed using Laser Fonts on an HP LaserJet printer!

1. Font Variety

SoftCraft's complete library contains hundreds of fonts in various styles and sizes from 4 to 72 points. Each product comes with fonts in sizes from 8 to 24 points, including Roman, Sans Serif, *Italic*, **Bold**, *Script*, *Old English* and more.

2. Formatting Power

In addition to all of the conventional formatting commands, *Fancy Font* includes commands that deal with variable-width (proportional) fonts and different height fonts. This is especially useful in setting tables, math formulas and perfectly justified text.

Fancy Word and *Laser Fonts* support all of Microsoft Word's formatting features; no other codes or commands are required.

3. Create Custom Symbols and New Fonts

An included font editing program (optional with *Fancy Word*) allows you to modify any character and create new characters and

logos, up to one inch by one inch. You can also create new fonts, scaled to size, from our database of character outlines.

Choose the Product That's Right For You

Fancy Font: A powerful text formatting and printing program that works with any word processor to provide a wide range of font styles and sizes. You embed simple commands in your document to control *Fancy Font*'s extensive formatting capabilities.

Fancy Word: For Microsoft Word users. You use Microsoft Word like you always have, including the paragraph and character format commands, but you now print all the special characters, styles and sizes.

Laser Fonts: Downloads a large variety of fonts, up to 30 points in size, into laser printers at a significantly reduced price over HP. *Laser Fonts* automatically configures Microsoft Word to fully take advantage of the downloaded fonts and can be used with any other word processor that can access soft fonts. *Laser Fonts* can also be used with *Fancy Font* or *Fancy Word* to dramatically speed printing on laser printers.

SoftCraft software runs on PCDOS and MSDOS computers with HP, Canon, NCR, Tall Tree and compatible laser printers (*Laser Fonts* requires a printer with download capability). *Fancy Font* and *Fancy Word* are also available for dot matrix printers.

Call TOLL FREE (800) 351-0500

Please send me information on the following SoftCraft products:

- Laser Fonts
- Fancy Word
- Fancy Font



NAME _____

ADDRESS _____

CITY, STATE, ZIP _____

PHONE _____

PRINTER MAKE _____

MAIL TO:

SoftCraft, Inc., 222 State St., Madison, WI 53703

 **SoftCraft, Inc.**

222 State Street, Madison, WI 53703 (608) 257-3300

Fancy Font is a registered trademark of SoftCraft, Inc. Fancy Word and Laser Fonts are trademarks of SoftCraft, Inc. Microsoft is a registered trademark of Microsoft Corp.

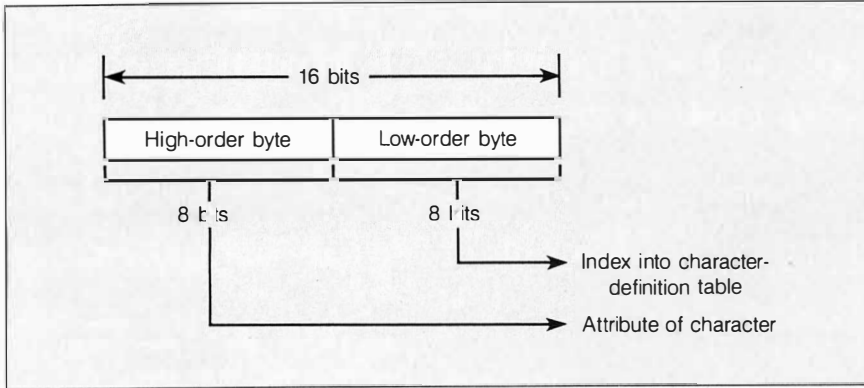

Figure 4a: The video display buffer mapping of the alphanumeric modes of IBM's Monochrome Display Adapter, CGA, and EGA, and the Hercules Graphics Card Plus.

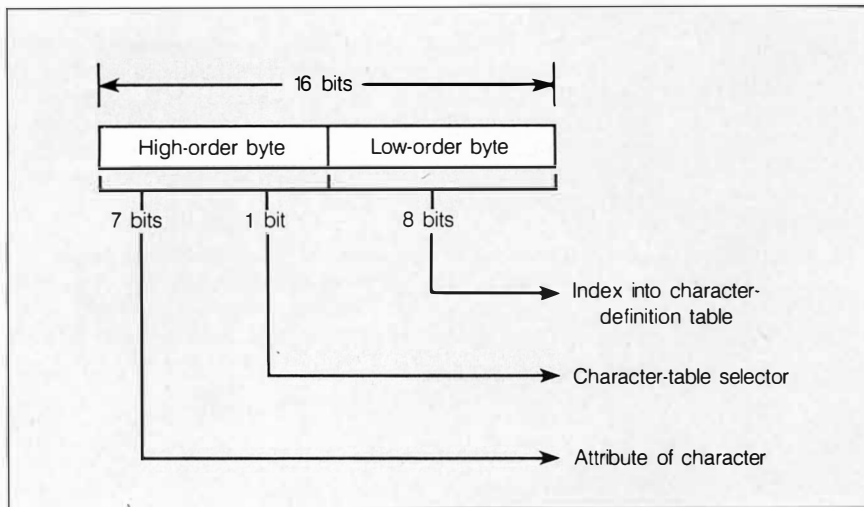

Figure 4b: The video display buffer mapping of IBM's EGA extended character set. Bit 3 of the high-order byte selects one of two 256-character tables.

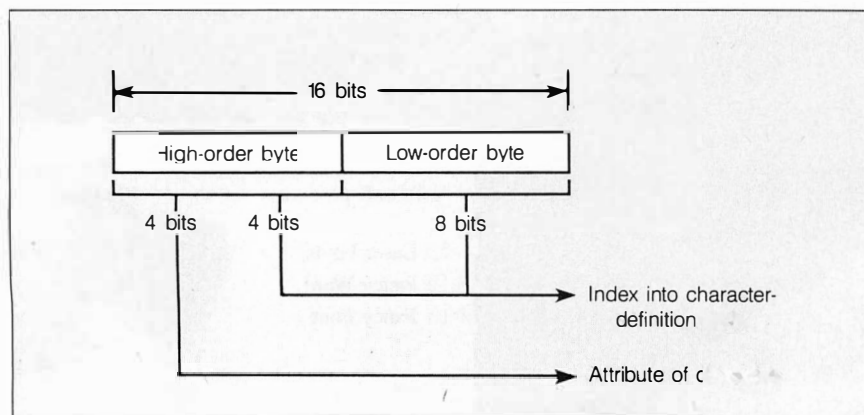

Figure 4c: The extended character set of the HGC Plus video display buffer map. Bits 0 to 7 of the low-order byte are appended to bits 0 to 3 of the high-order byte to form a 12-bit index into the character-definition table.

play adapter's CRT controller. On the EGA, the CRT controller circuitry resides in a special LSI chip with 27 internal registers. The HGC Plus uses a Motorola 6845 plus a proprietary chip that adds an additional 3 registers for controlling RAM-loadable font configurations.

The way you configure the CRT controller on the EGA and the HGC Plus depends primarily on the height of the characters in your character set. Hercules provides a table of register values for its CRT controller. Your program must explicitly load each of these values into the proper CRT controller registers.

Similarly, the EGA's CRT controller must be programmed to reflect the character height. In particular, the Maximum Scan Line, Cursor Start, Cursor End, Vertical Display Enable End, and Underline Location registers must be updated. Again, your task is simplified by an EGA ROM BIOS routine (interrupt 10h, function 11h). The BIOS routine calculates the correct register values given the number of bytes per character in your character-definition table and programs the CRT controller accordingly.

NINE-DOT-WIDE CHARACTERS

Although the height of the characters you define may vary, you might expect their width to be restricted to eight dots, since this is the number of bits in each byte of your character-definition table. However, both the HGC Plus and the EGA can be programmed to put 8-dot-wide characters on the screen in a 9-dot-wide matrix. The extra space between characters improves their appearance on a green IBM monochrome display.

To do this on the HGC Plus, you must set bit 1 in CRT controller register 14 hexadecimal. On the EGA, you reset bit 0 of the Sequencer Clocking Mode register. The EGA BIOS routines set this bit for alphanumeric display modes on a color monitor (8-dot-wide characters) and reset the bit for a monochrome monitor (9-dot-wide characters).

A subtle built-in function of both
(continued)

MicroWay is the world's leading retailer of 8087s and high performance PC upgrades. We stock a complete selection of 8087s that run from 5 to 12 MHz. All of our coprocessors are shipped with a diagnostic disk and the best warranty in the business - one year! We also offer daughterboards for socketless computers (NEC PC) and 287Turbo which increases the clock speed of the 80287 from 4 to 10 MHz. Our NUMBER SMASHER/ECM™ runs at 12 MHz with a megabyte of RAM and achieves a throughput of .1 megaflops with 87BASIC/INLINE, Intel For-

tran, or Microsoft Fortran. Software reviewers consistently cite MicroWay software and 8087 expertise as the best in the industry! Our customers frequently write to thank us for recommending the correct software and hardware to meet their specific needs. They also thank us for our same-day shipping! In addition to our own products which support the 8087 and 80287, we stock the largest supply of specialized software available. For more information call us at

617-746-7341

**NUMBER SMASHER/ECM™
THE FASTEST ACCELERATOR
CARD AVAILABLE**

gives you 12 MHz speed in two modes: 704K or one megabyte of "Extended Conventional Memory." MEGASWITCH MMU and MegaDOS software make it possible to run DOS applications with up to 1015K using PC compilers, AutoCAD and Lotus 1-2-3. Does not require EMS software. Totally compatible... from **\$599** for 512K and 9.54 MHz to **\$1199** with one megabyte and 8087-12. Cooling Fan (for 12 MHz)..... **\$80**

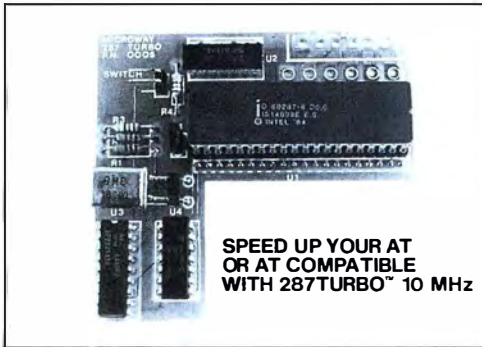

MicroWay® 8087 Support

For the IBM PC, PC XT, PC AT and Compatibles.

A2D-160™ MicroWay's Data Acquisition Board performs 160,000 12 bit Analog to Digital conversions per second! Includes software drivers. The fastest 12 bit A to D board available. For the IBM PC XT and Compatibles..... **\$1295**

87SFL™ Accurate and fast **Scientific Subroutine Packages**. More than 145 functions: 34 Elementary Fcns, 18 Probability and Statistical Fcns, 15 Random Number Generators, Ei(x), E_i(x), li(x), Si(x), Ci(x), Γ(x), ψ(x), B(x,ω), I₁(a,b), erf x, S(x), C(x), J₁(z), Y₁(z), I₁(z), K₁(z), Ai(x), Bi(x), Ai'(x), Bi'(x), ber x, bei x, ker x, kei x, K(x), E(x), F(ρ|a), E(ρ|a), Π(ρ|a,b), Λ(a,b,ρ), ρ(z), ρ'(z), P_n(x), H_n(x), L_n^(α)(x), J_ν^(ρ)(x), G₁(p,q,x), C₁⁽²⁾(x) and many more. Callable from FORTRAN, Pascal, BASIC and C. 1st module \$250, 2nd on \$100.

MATRIXPAK™ manages a **MEGABYTE!** Written in assembly language, our runtime package accurately manipulates large matrices at very fast speeds. Includes matrix inversion and the solution of simultaneous linear equations. Callable from RM or MS Fortran, MS Assembler, or 87BASIC/INLINE..... each **\$99**

87FFT™ Written in assembly language, performs Forward and Inverse FFTs on real and complex arrays which occupy up to 512 Kbytes of RAM. Also does convolutions, auto correlations, hamming, complex vector multiplication, and complex to radial conversions. Callable from most 8087 compatible compilers..... **\$200**

87FFT-2™ performs two-dimensional FFTs. Ideal for image processing. Requires 87FFT **\$100**

FASTBREAK™ 8087 support for Lotus 1-2-3™ Version 1A or 1A* **\$79**
Microsoft Fortran V.3.31 **\$209**
IBM Professional Fortran **\$565**
Ryan-McFarland Fortran V.2.0 **\$399**
LAHEY Fortran F77L **\$477**
Grafmatic for Fortran or Pascal **\$125**
MultiHalo Graphics (1 language) **\$189**
Microsoft C V.4.0 **\$299**
STSC APL★PLUS/PC **\$450**
INTEL, JRAM, AST, MAYNARD **CALL**

MegaPage™ The only Intel-Lotus EMS board which comes with two megabytes of cool-running, low power drain CMOS RAM installed. Includes RAM disk, print spooler, disk cache, and EMS drivers. For the IBM PC, XT & compatibles.... **\$549**

DFixer™ Our disk utility which thoroughly checks PC or AT hard disks for bad sectors and updates the MS DOS file allocation table accordingly. Solves the AT hard disk problem! ... **\$149**

DOptimizer™ Optimizes the way your hard disk or floppy stores its files. Speeds up accesses by recombining fragmented files. **\$49**

DCache™ Our disk caching software speeds up your I/O by storing repetitively used tracks in memory. The amount of memory used can be selected in 64 Kbyte banks **\$49**

87MACRO/DEBUG™ Contains all the pieces needed for writing 8087/80287 assembly code & MicroWay's 87DEBUG debugger. **\$199**

OBJ→ASM™ A multipass object module translator and disassembler. Produces assembly language listings which include public symbols, external symbols and labels commented with cross references. Ideal for patching object modules for which source is not available. **\$200**

87BASIC™ includes patches to the IBM BASIC or MS Quick BASIC Compiler for USER TRANS-PARENT 8087 support. Provides super fast performance for all numeric operations including trigonometrics, transcendental, addition, subtraction, multiplication, and division..... each **\$150**

87BASIC/INLINE™ converts the output of the IBM BASIC Compiler into optimized 8087 inline code which executes up to seven times faster than 87BASIC. Supports separately compiled inline subroutines. Requires the IBM BASIC Compiler Version 1 and a Macro Assembler. Includes 87BASIC **\$200**

RTOS - REAL TIME OPERATING SYSTEM
RTOS is a multi-user, multi-tasking real time operating system. It includes a configured version of Intel's IRMX-86, LINK-86, LOC-86, LIB-86, OH-86, and MicroWay's 87DEBUG. Runs on the IBM-PC, XT, PC-AT and COMPAQ..... **\$600**

INTEL COMPILERS¹
FORTRAN-86..... **\$750**
PASCAL-86..... **\$750**
PL/M-86..... **\$500**
ASM-86..... **\$200**

¹Requires RTOS or IRMX-86. All Intel compiler names and IRMX-86 TM Intel Corp

8087 UPGRADES

All MicroWay 8087s include a one year warranty, complete MicroWay Test Program and accurate installation instructions

8087 5 MHz..... \$114
For the IBM PC, XT and compatibles.

8087-2 8 MHz..... \$149
For Wang, AT&T, DeskPro, NEC, Leading Edge.

80287-3 5 MHz..... \$179
For the IBM PC AT and 286 compatibles.

80287-6 6 MHz..... \$229
For 8 MHz AT compatibles

80287-8 8 MHz..... \$295
For the 8 MHz 80286 accelerator cards

NEC V20, V30..... \$16, \$30

64K RAM Set 150ns..... \$10

256K RAM Set 150ns..... \$29

256K RAM Set 120ns..... \$39

128K RAM Set PC AT..... \$49

287Turbo™ 10 MHz If you own an AT, Deskpro 286 or AT compatible, this is the card you need to get reasonable numeric performance. It plugs into your 80287 socket and includes a specially driven 10 MHz 80287. The card comes in three configurations. The IBM AT version includes a hardware RESET button **\$450**

287Turbo 8 MHz..... \$369

87/88Turbo™ is a stubby card which includes a clock calendar and a speed controller which changes the speed of your motherboard from 4.77 to 7.4 MHz. Its use requires your PC to have a socketed 8284. Typical speed increase is 1.6 to 2.0. The card overcomes slow hardware by slowing up only when such devices are accessed and running at full speed otherwise **\$149**
Optional 8087-2 **\$149**

286TurboCache™ This accelerator for the PC or XT uses 8K of cache memory and 80286/80287 processors to provide an average speed increase of 3:1 for most programs. Call for specifications and benchmarks..... **\$469**

Call for our complete catalog of software which supports the 8087.

In London, please phone 223-7662



adapters relates to the use of the block-graphics characters, specified with character codes B0 through DF hexadecimal in IBM's PC character set. You can concatenate these characters to draw horizontal lines on the display. When they display characters in a 9-dot-wide matrix, the EGA and the HGC Plus copy the rightmost dot

of all block-graphics characters into the extra space between characters. This ensures the continuity of horizontal lines.

EXTENDED CHARACTER SETS

When 8-bit codes represent characters in the video display buffer, a maximum of 256 (2⁸) different characters

can be displayed at one time. To display more characters than this, you must find a way to use character codes that are larger than 8 bits.

When IBM PC video adapters display text, 16 bits (one word) of data are actually stored in the video display buffer for each character on the screen. Usually, 8 of these bits encode the ASCII character number, while the other 8 bits specify attributes such as the character's color, intensity, blinking, or underlining (see figure 4a). The HGC Plus and the EGA use one or more of the 8 attribute bits to extend the range of character codes and thus increase the number of displayable characters.

On the EGA, the character-generator hardware can use bit 3 of the high-order byte to toggle two 256-character tables (see figure 4b). Which two of the four possible tables are actually used is determined by programming the EGA's Sequencer Character Map Selector register. Although it is possible to program this register directly, EGA ROM BIOS function 11h will perform this function for you.

On the HGC Plus, the character-generator hardware can use the low-order 12 bits of the 16-bit word as an index into the character-definition table at B000:4000 (see figure 4c). The character generator interprets character codes in this way when you set bit 2 of CRT controller register 14 hexadecimal. (The program CSLS7.ASM demonstrates this technique.)

In order to use the extended character sets on either adapter, you must write software routines to store character codes and attributes in the display buffer in the appropriate format. Unfortunately, software that uses extended character sets on the EGA will not format character codes and attributes correctly for the HGC Plus, and vice versa. Furthermore, all the IBM PC's BIOS routines assume that the video buffer is formatted for only 256 character codes (as in figure 4a). Programs that perform video output with BIOS calls or with PC-DOS calls (which in turn call the BIOS) will not

(continued)

Don't get burned by surge protection alone.

Now get **total** power protection... for as little as \$139... with the Personal Computer Line Tamer™ Power Conditioner.

Why risk any power trouble?

You will if you buy just a surge protector. Transients and spikes cause less than half of all power problems. Overvoltages, brownouts and just plain power noise can mess up your system just as badly—and they're much more frequent. Only Line Tamer's ferro-resonant technology protects you from any conceivable power problem, short of a blackout

Line Tamers have protected the big boys for years, on all the big mainframes and minis. Those guys would laugh at surge suppression alone.



Choose from 150, 300, 450, or 600 VA models for the Line Tamer that's right for you.

Does it make sense to you to be half safe... especially when so few dollars are involved?

You won't find this total power protection

from anyone else at anywhere near the price, so contact us for complete specifications and the dealer nearest you.

SHAPE
MAGNETRONICS, INC.

THE CLEAN
POWER
SOURCE

901 DuPage Avenue, Lombard, IL 60148
Phone 1 312 620-8394 • TWX 910-991-2352



JUST RELEASED

Unleash the power of your LaserJet™

Mix any combination of fonts

Merge text and graphics from any program

Print extended and foreign language characters

Use all the printing features of your LaserJet with Polaris Ram-Resident PrintMerge

Ram-Resident PrintMerge gives you quick and easy access to all the LaserJet's printing features - no matter which word processing, database or LaserJet-compatible graphics program you're using. With a few simple commands, you can turn a ho-hum report into an exciting, visually appealing presentation. You'll be able to format text from virtually any program and combine it with the graphic output from any graphics program that can print on the LaserJet.

For instance, the chart on the left was created with Graphic Communication's Freelance and Graphwriter. Ram-Resident PrintMerge even prints properly aligned tables made up of any combination of proportional fonts like the table on the right.

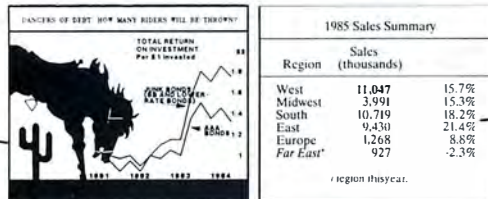

You also get full access to all the formatting you've been missing with DisplayWrite 3, Multimate, etc. which include: selection of any fonts, right justification of any combination of fonts, and a handy line and box drawing function. Plus, keyboard translation screens give you instant access to the LaserJet's foreign language and special purpose characters. Here's a small sample of words you can type without missing a beat:

Nimes	£125	iolle
— 22	Provencal	1.7 Å
Bano	Munchen	Orsted

Be sure to ask about Polaris Crunch, a program used with Ram-Resident PrintMerge. Polaris Crunch automatically reduces files to sizes the LaserJet can handle. It also rotates and trims graphic images, which allows you to print only the amount you want.

Read more about Ram-Resident PrintMerge below.

any proportionally spaced text

Align tables printed with proportional fonts

Draw lines and boxes

Your software only lets you use a small fraction of the LaserJet's printing capabilities. Unfortunately, that also limits how precisely you communicate your message.

That's why you need Polaris Ram-Resident PrintMerge.

It's the only program that puts you in direct control of all the LaserJet's printing capabilities—so you control what your document looks like, not the limitations of your software.

You'll be able to add graphics right in the middle of your text. Use all the LaserJet fonts and extended characters wherever you like. And print it all beautifully with Ram-Resident PrintMerge's justification and line-drawing abilities. What's more, Ram-Resident PrintMerge works with the software you're already using, so it's very easy to learn.

Since Ram-Resident PrintMerge lets you merge graphics from virtually any program that prints on the LaserJet, you can reinforce complex ideas with illustrations right in the text. You can merge the graphic output or save a screen image, and merge either in any of four print resolutions. If your graphics are too large for your LaserJet to handle, try Polaris Crunch, a separate program that compresses, rotates and trims images.

With the help of Ram-Resident PrintMerge's useful formatting features, your document

Runs Directly From:

- | | |
|-----------------------|------------------------|
| DisplayWrite 3 | WordStar |
| Multimate | Microsoft Word |
| Freelance | Graphwriter |
| Lotus 123 | Javelin |
| Paradox | WordStar 2000 |
| NewWord | Framework |
| R:base 5000 | Easy |
| Map-Master | Microsoft Chart |
| WordPerfect | PC Crayon |
| Chart-Master | Sign-Master |
- and more

will be as impressive as its contents. You'll be able to use LaserJet fonts in any combination for more attractive, readable text. And justify right-hand margins and align table columns printed with proportional fonts—even if they're downloaded from diskettes. For extra emphasis, use Ram-Resident PrintMerge's line and box drawing capabilities and the LaserJet PLUS patterns to highlight important ideas.

And when you need to use extended or foreign language characters, Ram-Resident PrintMerge's five keyboard translation screens will put them at your fingertips instantly.

But even with all these features, Ram-Resident PrintMerge is truly easy to use.

Timesaving printer setup screens store nine sets of page parameters. Simply enter parameters for Lotus, dBase, or any other application program once, and use them again and again. "Ram-Resident" means it loads automatically when you boot your system, so it's always ready. Just use your software as you normally would. When you need Ram-Resident PrintMerge's special features, set up the printer with one of the nine setup screens or key in the simple print commands right in your document.

Put the rest of your LaserJet's printing power to work for you. Call these toll-free numbers to order your Ram-Resident PrintMerge. Versions are available for IBM-PC/100% compatibles. There's a 30-day money-back guarantee, so order now without risk.

\$149.

plus \$6 shipping and handling.

For ordering information call:

Inside California call
1 (800) 231-3531

Outside California call
1 (800) 338-5943

POLARIS
SOFTWARE

310 Via Vera Cruz
Suite 205
San Marcos, CA 92069
(619) 471-0922



run properly if your adapter is configured to display an extended character set.

UPDATING BIOS RAM

When you change the height or width of your character set, you implicitly change the screen's logical dimensions. The usual screen dimensions

are 80 characters across by 25 characters down. Consider what happens when you use 8 by 8 characters on a screen that usually displays 9 by 14 characters, such as the green monochrome display: Your screen now displays 90 characters across and 43 characters down.

Although the ROM BIOS and PC-

DOS are not always flexible enough to function correctly with screen dimensions other than 80 by 25 or 40 by 25, you can preserve a great deal of function by updating the status values stored by the BIOS in segment 40. In particular, several different BIOS routines use the words at 0040:004A (CRT_COLS) and 0040:004C (CRT_LEN).

It's 3 AM!



Do you know where your bugs are?

This C programmer is finding his bugs the hard way...one at a time. That's why it's taking so long. But there's an easier way. Use

PC-Lint 2.00

PC-Lint analyzes your C programs (one or many modules) and uncovers glitches, bugs, quirks, and inconsistencies. It will catch subtle errors before they catch you. By examining multiple modules, PC-Lint enjoys a perspective your compiler does not have.

- NEW: ANSI C extensions (enum, prototypes, void, defined, pragma), Microsoft keywords, and many additional checks.
- Full K&R C
- Use PC-Lint to find:
 - inconsistent declarations
 - argument/parameter mismatches
 - uninitialized variables
 - unaccessed variables
 - unreferenced variables
 - suspicious macros
 - indentation irregularities
 - function inconsistencies
 - unusual expressions
 - ... MUCH MUCH MORE
- User-modifiable library-description files for most major compilers.
- All warning and informational messages may be turned off individually.
- Indirect files automate testing.
- Use it to check existing programs, novice programs, programs about to be exported or imported, as a preliminary to compilation, or prior to scaling up to a larger memory model.
- All one pass with an integrated pre-processor so it's very fast.
- Has numerous options and informational messages.
- PRICE: \$139.00 MC, VISA, COD (Includes shipping and handling within US) PA residents add 6% sales tax. Outside USA add \$15.00. Educational and quantity discounts available.
- Runs under MS-DOS 2.0 and up, with a minimum of 128Kb of memory. It will use all the memory available.
- Trademarks: PC-Lint(Gimpel Software), MS-DOS(Microsoft)

NEW!! Amiga - Lint
Special Introductory Price
\$98.00

GIMPEL SOFTWARE

3207 Hogarth Lane • Collegeville, PA 19426
 (215) 584-4261

PROBLEMS AND PITFALLS

I've alluded to one obvious problem with the use of RAM-loadable character sets: namely, that neither PC-DOS nor the ROM BIOS was designed to handle character sets of different-size characters. Also, neither DOS nor the BIOS can support the modified video buffer format required for extended character sets. When the usual DOS and BIOS video output routines are used with an extended character-set configuration, garbage characters appear on the display. The only solution is to be certain that an appropriate character set is available when control is transferred out of your application to DOS or to a BIOS video output routine.

A related problem crops up in a windowing or multitasking environment when a coresident program or an alternate task takes control of the display. Your program's character set and CRT controller configuration might be incompatible with those expected by some other task. At present there is no agreed-upon way to coordinate character set and video status between tasks. The problem might be solved with some type of global video status table or by a memory-resident display manager, but any such approach would have to be agreed upon by software developers to become usable.

Despite such potential pitfalls, the availability of RAM-loadable character sets in moderately priced video hardware should encourage their use by software developers. The reasonable compromise between the flexibility of dot-addressable graphics and the speed of a hardware character generator provides a way to improve the user interface in many applications. ■

AN OLD RESPECTED NAME. A BOLD NEW LOOK.

Computer Mail Order is one of the oldest computer mail order companies in the country. We've succeeded where others have failed, because year after year, we've delivered to you the most product performance for your dollar and given you the attentive service you desire and deserve. This month we launch a new look. We hope you'll find it as easy on your eyes as Computer Mail Order has been on your pocketbook. We also hope you'll do us the honor of calling us C-M-O.



FINE PRODUCTS.

When you call CMO toll-free, you order from a selection of the finest computer hardware, software and peripherals available. More than 5000 items from the best sources in the business (including PC-TOO™, the tailor-made clone, direct from CMO!).

FINE PRICES.

Call us. Compare us. Talk to us. We won't hang up. We like talking price as much as we like talking computers.

FINE SERVICE.

We know computers. And we back that product knowledge with our best warranty package ever. And we deliver with next-day shipping on our entire inventory. At CMO, we're committed to keeping you up, running and satisfied.

NO FINE PRINT.

We're CMO. No hot air. No come-ons. No hang-ups. And no fine print. Turn the page. Explore CMO.

business, person to person.

PRINTERS.

Canon	
LBP-8 Lazer.....	see special
Citizen	
MSP-10 Dot Matrix.....	299.00
MSP-20 Dot Matrix.....	349.00
Premier 35 Daisywheel.....	449.00
C.ltoh	
8510-SEP Dot Matrix.....	call
Diablo	
635 Daisywheel.....	1099.00
Epson	
FX-85 Dot Matrix.....	call
FX-286 Dot Matrix.....	call
LQ-800 24 Pin.....	call
LQ-1000 24 Pin.....	call
Hewlett Packard	
2686A Laser.....	call
7475S Plotter.....	call
7550S 8-pen Plotter.....	call
Juki	
6100 Daisywheel.....	call
6300 Daisywheel.....	call
5510C Color.....	call
NEC	
P560, P660, P760.....	call
3550 Spinwriter.....	779.00
8850 Spinwriter.....	1099.00
Okidata	
ML-192 IBM.....	call
ML-193 IBM.....	call
OK293 Dot Matrix.....	call
OK2410 Hi Speed.....	call
Panasonic	
KX-1091 Dot Matrix.....	229.00
KX-1592 Dot Matrix.....	469.00
Star Micronics	
NX-10 Dot Matrix.....	249.00
SR-15 Dot Matrix.....	549.00
Toshiba	
P321 24 Pin.....	479.00
P351 24 Pin.....	1049.00

DISKETTES.

Maxell	
MD-2 DS/DD 5¼.....	12.99
MD-2HD Hi Density 5¼.....	24.99
Sony	
MD2D DS/DD 5¼.....	11.99
MD2HD Hi Density 5¼.....	24.99
MFD-2DD DS/DD 3½ 5 pak.....	9.99

MS/DOS SYSTEMS

AT&T	from \$1699.00
Compaq	from \$1499.00
Corona	from \$995.00
IBM-PC	from \$1199.00
IBM-XT	see special
IBM-AT	from \$2799.00
Leading Edge	from \$1299.00
Sperry	\$1899.00
Zenith	from \$995.00

MULTIFUNCTION CARDS.

AST	
Six Pak Plus PC/XT.....	\$169.00
Six Pak Premium PC/XT.....	369.00
Advantage IBM/AT.....	339.00
Rampage PC/XT.....	279.00
Rampage-AT IBM/AT.....	479.00
DCA	
IRMA PC-3278-I/O.....	849.00
Everex	
EV-640 Edge Card.....	259.00
Hercules	
Graphics Card.....	219.00
Graphics Card Plus.....	219.00
Color Card.....	169.00
IDEAssociates	
IDE-5251 Emulation Board.....	589.00
Intel	
1110 PC-Above Board.....	call
2010 AT-Above Board.....	call
8087, 80872, 80287, 802878.....	call
Paradise	
Modular Graphics Card.....	269.00
Color/Mono Card.....	139.00
Multidisplay Card.....	179.00
Polaroid Palette	
Computer Image Recorder.....	1399.00
Quadram	
Quad EGA Graphics Adapter....	369.00
Expanded Quadboard.....	149.00
Silver Quadboard.....	239.00
STB	
EGA Plus w/Dr. Halo.....	319.00
Video-7	
Vega Video adapter-EGA.....	339.00
Zuckerboard	
Color Card w/parallel.....	89.99
Monochrome Card.....	99.99
576-Memory Card.....	59.99

CM Only!

5th Generation
Fast Back **\$89**

CM Only!

Amdek
310A Amber
Screen **\$139**

CM Only!

Paradise
Auto Switch
EGA Card **\$359**

CM Only!

Hayes
Smartmodem
1200 External **\$379**

CM Only!

CMS
20 MB Kit
w/Western Digital
Controller **\$399**

CM Only!

IBM-XT
268
w/Americare **\$1699**

CM Only!

Toshiba
1100 +
Lap-top
Computer **\$1749**

CM Only!

Canon
LPB8
Laser Printer **\$1789**

When you want to talk computers.
When you want to talk price.
Call toll-free: 1 800 233-8950.

Outside the U.S.A. 717 327-9575 Telex 5106017898
CMO. 477 East Third Street, Dept. A113, Williamsport, PA 17701
All major credit cards accepted

CMO. Doing business-to-b

Person to person.

Not too long ago, I got a call from a new customer with an unexpected problem—we had delivered his order too quickly. He had placed a COD order with one of our sales consultants on the 14th. It went through our system and was shipped the 15th. When the shipment arrived, the customer called. He said he hadn't expected it so soon and hadn't had time to arrange for payment.

It turned out the customer had worked as a sales rep for a competitor of ours. He said it takes them 3 or 4 weeks to complete most orders. Consequently, he didn't think there was any hurry to get a check ready for the CMO order.

"They must have a lot of cancelled orders," I said.

He said yes, that in a typical month they only ship 40% of what's ordered.

That surprised me. I told him we ship 90% of our orders the next day. And we have very few cancellations.

Well, everything worked out. I apologized for our promptness. He laughed and said he'd be ready for us the next time he ordered.

And we'll be ready for him.

CMO is committed to its customers. We operate an IBM System 38 with state-of-the-art software to help expedite the tens of thousands of orders we receive. Thanks to this system CMO is able to provide customers with up-to-the-minute information about their orders.



Thomas A. Penfield
Sales Manager, CMO

SOFTWARE.	MONITORS.
Ansa Paradox.....\$499.00 Ashton-Tate d-Base III +429.00 Framework II.....429.00 Borland Reflex.....59.99 Lightening/Word Wizard.....99.99 Central Point Software Copy II PC.....24.99 5th Generation Fastback.....see special IMSI Mouse w/Dr. Halo.....119.00 IUS-Sorcim General Ledger.....299.00 SuperCalc III.....329.00 Super Project Plus.....299.00 Lifetree Volkswriter III.....149.00 Lotus Lotus 1•2•3.....329.00 Symphony.....449.00 MECA Managing Your Money.....119.00 MicroPro Wordstar 2000 +299.00 Wordstar Professional w/GL Demo 189.00 Microrim R:Base 5000.....359.00 Micro Soft Micro Soft Word.....289.00 Micro Soft Mouse/Serial.....139.00 Micro Soft Mouse/Bus.....139.00 Microstuf Crosstalk XVI.....89.99 Multimate Multimate 3.3.....229.00 Multimate Advantage.....289.00 Norton Software Norton Utilities.....57.99 PFS First Choice.....99.99 Professional Write.....129.00 Professional File.....159.00 Satellite Systems Word Perfect 4.1.....219.00 The Software Group Enable.....369.00	Amdek Color 600 RGB, IBM CGA.....\$399.00 Color 722 RGB, CGA/EGA.....499.00 Color 730 RGB Analog.....699.00 Magnavox 8CM515 RGB Monitor 80.....289.00 7BM623 PC Monitor 80.....99.99 NEC JC-1401P3A Multi-Sync.....599.00 JB-1280 TTL Green.....139.00 JB-1285 TTL Amber.....139.00 Princeton Graphics MAX-12 Amber.....169.00 HX-12 16 Color.....429.00 HX12e 64 Color.....509.00 SR-12e Super Hi-Res.....589.00 SR-12e RGB Analog.....649.00 Taxan 640 RGB Hi-Res.....539.00
	MODEMS.
	Anchor Expressi 1200 Half Card.....\$149.00 Everex Evercom 920 1200 Baud.....139.00 Hayas Smartmodem 1200B.....359.00 Smartmodem 2400.....599.00 Smartmodem 2400B.....539.00 Practical Peripherals Practical Modem 1200SA.....179.00
	DRIVES.
	CMS Drive Plus 20 MB Card.....\$499.00 T-120 20 MB Tape-Backup.....469.00 T-160 60 MB Tape-Backup.....699.00 lomega A210H 10 + 10 Bernoulli Box...1899.00 A220H 20 + 20 Bernoulli Box...2499.00 Mountain Drive Card-20.....689.00 Drive Card-30.....949.00 Priam Innerspace ID-60AT.....1349.00 Seagate ST-4026 20 MB Hard Drive.....689.00 ST-4038 30 MB Hard Drive.....739.00

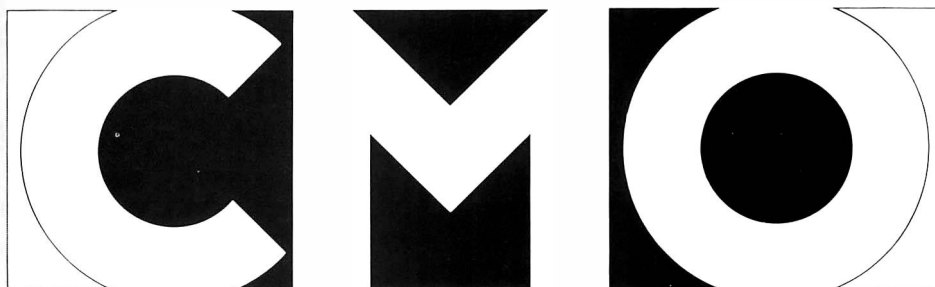

GET A TAILOR-MADE, 20 MEG, XT-COMPATIBLE FOR AS LITTLE AS \$999.



Presenting PC T00™ Only from CMO.

When you think of tailor-made, you think expensive, right? Think again.

Now CMO can offer you a 20 Mb PC-compatible—one we assemble in our Pennsylvania lab just for you. To your specifications. With the attention to quality and performance you've come to expect from CMO. All for just \$999.

Every tailor-made clone we make is backed with a full 90-day warranty on labor and parts, a 30 day money back guarantee and easy access to CMO technical support after the sale—the kind that keeps you up, running and satisfied.

For \$999, you get: A 20 Mb, PC-XT compatible that runs thousands of programs, including Lotus 1-2-3™ ■ A 4.77 Mh chip speed ■ An XT chassis with 256K (expandable to 640K) ■ A 20 Mb hard drive ■ A 360K floppy drive ■ A floppy disk and hard drive controller ■ A 150 watt power supply (not just 130) ■ Open architecture with 8 expansion slots (not just 7) ■ And an 84-key, XT-style keyboard.

Need more power and more flexibility? Call us. Let's talk about your tailor-made PC T00.

Your options are unlimited.

CMO. Policies and particulars.

Next day shipping on all in-stock items. • Free technical support from our own factory-trained staff. • Toll-free order inquiry. • No surcharge on VISA or MasterCard orders. • Credit cards will not be charged until the order is shipped. • No limit and no deposit on COD orders. • No sales tax on orders shipped outside PA. • No waiting period for cashier's checks.

SHIPPING. Add 3% (minimum \$7.00) shipping and handling on all orders. • Larger shipments may require additional charges. • Returned items may be subject to a restocking fee. • All items subject to availability and price changes.

EDUCATIONAL INSTITUTIONS: 1 800 221-4283



**When you want to talk computers.
When you want to talk price.
Call toll-free: 1 800 233-8950.**

Outside the U.S.A. 717 327-9575 Telex 5106017898
CMO. 477 East Third Street, Dept. A113, Williamsport, PA 17701
All major credit cards accepted

SPEEDING UP THE PC AT

Without spending a fortune, you can dramatically increase the AT's potential

BY BRIAN K. ROEMMELE

YOU CAN INCREASE the standard 6-MHz CPU speed of the IBM PC AT to 8 MHz with relatively low-cost modifications and replacement parts. All the critical components are socketed and easy to replace. You can obtain speeds faster than 8 MHz after testing and identifying the components that are not capable of higher speeds. How involved the speedup is depends on how fast you want your AT to go. The modifications can range from a simple crystal change to changing the CPU, RAM, and clock-generator chip as well as the crystal. Also, you will need to consider the speed limitations of any expansion boards you

have in the system. I will explain how you can speed up your AT and describe the possible negative effects. [Editor's note: See the "Benchmarks" text box for the results we got when speeding up one of BYTE's ATs.]

It is rare to find a system that has so much upgrade potential with so little cost investment. The generous performance margins that Intel built into its chips, along with the predictable quality of the components on the AT's motherboard, let you increase performance without causing problems. Also, evidence suggests that the AT was originally designed for an 8-MHz CPU speed. First, the crystal is socketed rather than soldered, which is unusual for microcomputers. Second, in the schematics in the IBM *Technical*

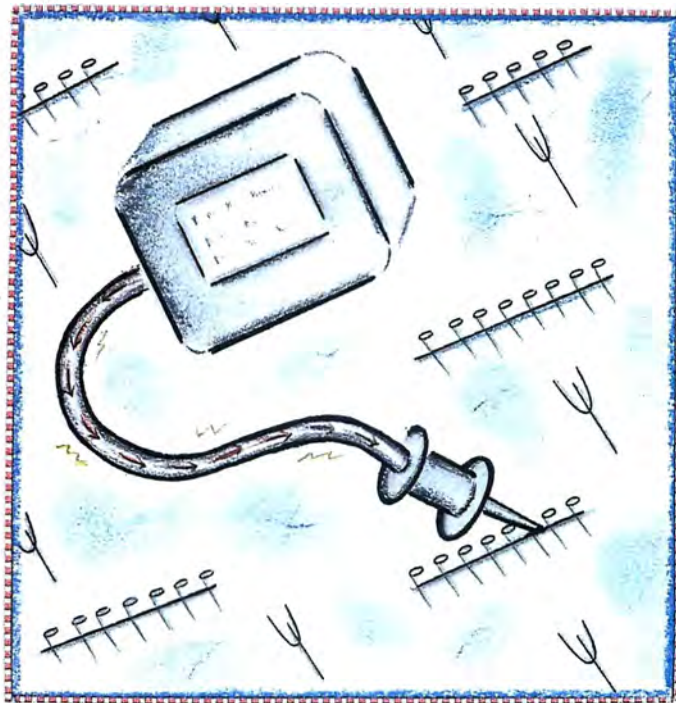

Reference Manual (Part #1502494, first edition, March 1984) the SysClk, ProcClk, and PClk traces all reference an 8-MHz bus, system frequency, and a 16-MHz crystal.

CRYSTALS

With a new crystal, you can increase the speed of your AT to 8 MHz. But the crystal you buy must be of high quality. The socket used to hold the AT's crystal requires an HC 25- or HC 33-type container. It is tempting to buy a low-cost wire-leaded HC 18 type and solder on nonpliable pins so you can mount it into the socket. In my tests, this method proved to be unreliable over the long term.

Standard HC 18- and HC 25-type crystals that you can find at local elec-

tronics stores might not be able to produce the stable and clean output many chips need to operate above the manufacturer's specifications. This is important for reliable operation when running the AT above 8 MHz.

You should buy an HC 25 military-specification-type crystal because of its stable frequency over temperature—better than 0.0005 percent +/- frequency deviation. The mil-spec crystals can cost twice as much as the lower-quality crystals and might be more stable than necessary, but the more stable frequency source will prevent damage to system components.

80286 MICROPROCESSOR

The 80286 is one of the most critical components when you are increasing the AT's system frequency. Intel's testing system works with a 35 percent upper performance margin when related to temperature, current, and frequency capabilities. Intel designed the 80286 to ultimately yield 10-MHz devices in volume production, but in early production runs Intel was able to produce only 6-MHz devices; this might be why the AT came out as a 6-MHz machine. Intel rates the 80286 by inducing an 85°C case

(continued)

Brian K. Roemmele is the president of Ariel Computer Corporation (Box 866, Flemington, NJ 08822, (201) 788-9002), maker of an IBM PC AT speed-up kit.

temperature with a stable and clean power source. The chip's resulting coefficient at 3.3 power dissipation will qualify its frequency capabilities. The AT's power supply produces a relatively stable, clean current. The surrounding ambient temperature (35 to 52°C) within the AT's case is rarely close to the 85°C case temperature used to rate the 80286.

Considering Intel's test safety margin and the CPU's relative temperature, 8-MHz operation from the 80286-6 is safe. On average, consider 9.5 MHz to be the maximum frequency of the 6-MHz device. The radiated temperature from the 80286-6 running with an 8- to 9-MHz clock stabilizes well below the chip's maximum specifications. Although I successfully ran some ATs with stock 80286-6s at 10 MHz, I would not recommend this unless you monitor the CPU's temperature and check the system regularly.

In the tests I ran, I saw no evidence of lower mortality of the 80286-6, provided it receives a reliable, stable clock frequency. The gates that directly see the input frequency could theoretically suffer unpredictable performance or damage from wide and continuous frequency shifts. The damage is usually to the gates of the chip. If you don't want to worry about running in the safety margins of an 80286-6, you can replace the CPU with an 80286-8 or 80286-10. Since this chip is socketed, it is a simple upgrade.

82284 CLOCK GENERATOR

The Intel 82284 clock generator divides the raw frequency from the crystal or frequency synthesizer in half, which stabilizes the frequency. The AT's standard 12-MHz crystal yields a 6-MHz processor and system frequency. The same test rating performed on the 80286 is performed on the 82284, resulting in the same coefficients. Intel designed this device to yield 8- to 10-MHz devices in volume production. In the AT, you can easily expect 10-MHz operation from this chip. In some ATs this chip is socketed, and you can replace it with a

faster device. The chip will need replacing if you want to bring the AT above 11.5 MHz.

RAM CHIPS

The AT waits one CPU cycle before it performs a read or write to the RAM or a read to ROM. This wait state is wired in by the hardware and does not increase when you increase the CPU frequency. In fact, the period of wait decreases proportionally to the increase in frequency. You can approximately calculate the needed RAM nanosecond rating by dividing two into the CPU frequency (e.g., $2/6 = .3333$, or 333 nanoseconds).

To arrive at an accurate result, you need to include the wait state (1/CPU frequency) and overall capacitance and propagation delays. IBM's *Technical Reference Manual* lists all RAM as 150 ns or better for the system board. The standard 128K-bit piggy-back 150-ns RAM is adequate up to a 9.5-MHz CPU speed. At 10 to 11 MHz, 120 ns is required; above that, 100-ns RAM should cover any other frequency that the rest of the system can handle. Because of increased capacitance and propagation delays, the RAM that populates memory-expansion cards should be at least 120 ns at frequencies above 8 MHz.

80287 MATH COPROCESSOR

The standard 80287 math coprocessor receives one-third of the actual crystal frequency. On the standard 6-MHz AT, this works out to 4 MHz. For system frequencies below 10 MHz, the normally heat-sensitive 80287 should not experience any dramatic temperature increases. With a system speed of 10 MHz, the 80287 is running at 6.6 MHz, which is far enough beyond the Intel 5-MHz specification that an 80287-8 should be used.

VARIOUS CHIPS

The 74ALSxxx-series TTL logic chips covering approximately 60 percent of the system board and the Intel 82288 bus controller are the final limiting factors after you have considered or replaced all other components. They

are both capable of approximately 11.5-MHz operation, but beyond that you should replace them. This is difficult because they are soldered into place. The extra 1 or 2 MHz you could gain might not be worth the heat and circuit-board damage that you could cause during desoldering.

RAM BOARDS

The quality control enforced by IBM on the chips that form the system board is predictable. After months of observing and testing, I have arrived at a reliable success rate in speeding up ATs. This is not the case for boards supplied by outside vendors. Some slow boards, just by being connected to the system bus, could cause the whole machine to lock up. RAM boards are particularly sensitive. To date there are no Lotus/Intel/Microsoft Expanded Memory Specification memory boards that run at or above 9 MHz. Some are not even capable of running at 8 MHz.

Most memory-board limitations can be traced to PAL (programmable array logic) chips, slow delay lines, and slow 74LSxxx-series chips. Standard RAM boards are more likely to be compatible. For example, the IBM 128K-byte memory board and the AST Advantage can run at 10 MHz, although the manufacturers don't support these capabilities. I have used the AST Advantage in A1S running at 12 MHz populated with 100-ns RAM chips. Other RAM boards are capable of fast CPU speeds. Working with the manufacturer or dealer in a trial-and-error process to find a suitable board would be the best way to identify boards capable of operating at high speed.

MONITOR BOARDS

Monitor boards, like memory boards, suffer from wide variations in the system frequencies at which they can operate. Some older boards designed specifically for the PC might not work correctly in even a 6-MHz AT. Most monitor boards now manufactured specify their maximum system frequency capabilities. All of IBM's display cards can operate at up to

10-MHz CPU speeds. Monitor boards rarely reference the CPU frequency.

OTHER BOARDS

Printer and RS-232C ports, if designed to IBM's recommended specification, do not limit the AT's maximum frequency capabilities. A few low-priced imported boards have failed in 8-MHz systems. They interface to the system bus with slow 74LSxxx TTL chips. Timing (data rates) for the printer and RS-232C ports is usually derived from an autonomous frequency source unrelated to the CPU frequency.

Modem boards are a little more sensitive to a faster system. All Hayes internal modem products perform correctly at 10 MHz. Older or low-quality modem boards seem to fail above 8-MHz CPU speeds. Most boards designed for AT-class systems should not show any major problems; when in doubt, contact a knowledgeable engineer at the manufacturer.

FLOPPY AND HARD DISK DRIVES

The fixed disk/floppy disk controller card that comes with the AT can run at 12.5-MHz. The hard disk drives I have tested work fine at faster CPU speeds. However, the 1.2-megabyte floppy disk drive experiences some errors at or above 9 MHz.

Approximately 45 percent of the systems I tested reported a "Drive not ready error" during first-time drive access or during a copy or format. In many cases this error can be traced to an optimization for 8-MHz CPU and bus frequencies in the BIOS and PC-DOS 3.1 and 3.2.

PC-DOS and the BIOS set up a timing loop to wait for the drive to respond after being prompted with a signal. The loop time decreases while the drive's reaction time stays the same, causing the drive to sometimes fail to report "Drive ready" to the DOS/BIOS. Fortunately, you can press R for retry until the drive is ready. [Editor's note: Ariel sells a patch to the BIOS to watch for the drive log-on.]

HARD DISK INTERLEAVE

If you increase the CPU speed above 8 MHz, you can change the hard disk

interleave. The 3:1 interleave on the standard IBM-supplied 20-megabyte drive is optimized for 6- to 8-MHz CPU speeds. At a CPU speed of 9 MHz or faster, a 2:1 interleave is better. You can change the hard disk interleave with IBM's Advanced Diagnostics found in the *Hardware Maintenance and Service Manual* (Part #1502242). You can expect a performance increase of 30 to 50 percent from a drive with a 2:1 interleave and a CPU speed of 9 MHz or above.

SOFTWARE

Software for MS/PC-DOS systems rarely intentionally uses the CPU frequency as a critical reference. Theoretically, software that assumes a particular CPU speed could pose an uncorrectable problem, although you can readjust some software defaults that assume a particular CPU speed. For example, in some terminal-emulation programs you might need to increase the time-out default before carrier detect in auto-dial mode.

Timed screen sequences and timed screen menus might need adjustment.

if it's possible. Some copy-protection techniques assume a particular system speed and will create a problem. Ashton-Tate seems to be the only company using this form of time-based copy protection.

ERRORS

The AT's POST (power-on self-test) investigates all the critical points of concern when increasing the CPU frequency. Running the standard IBM AT diagnostics disk continuously for the first 5 to 10 minutes after finalizing on a frequency should magnify conditions that the POST might have missed. During the testing of the monitor card in some systems, diagnostics might report a 501 error. This is due to IBM's technique for testing a specific function on the monitor board and does not represent any failure of the hardware.

Table 1 lists some of the errors that POST and diagnostics report, with a brief explanation and recommendation for correction. If the system fails to respond at less than 8-MHz CPU speeds, it is most often traced to a

(continued)

Table 1: Some errors that POST and diagnostics report if some component fails when you increase the IBM AT's processor speed.

Error	Description
Parity check 1 and 2 error	The RAM is too slow in responding to the CPU access cycle (install 120- or 100-ns RAM chips).
164 memory-size error	Usually attributed to an expansion RAM board that cannot handle the current CPU frequency.
201 system-board error	A general error—it usually means that under this system setup the current CPU speed is too fast for various chips on the system board (difficult to correct). It might also be an 80286 that is borderline failing.
System activity but no information on your screen	Generally relates to an incompatible display board.
No system activity or display	This is usually an 80286 failure. It can also represent a failure of the various chips on the system board.
Drive not ready error (abort, ignore, retry)	This can be traced to the BIOS, DOS, and the drive itself. You can retry until the drive is ready.

BENCHMARKS

BY EVA WHITE

I tried some of Brain Roemmele's techniques to speed up one of BYTE's IBM PC ATs I wanted to run benchmarks at six different speeds, so rather than buy six crystals, I opted for Ariel Corporation's variable frequency synthesizer (VFS), XCELX. It replaces the 12-MHz crystal in the AT.

The VFS is a silver box (about 2 by 1 by 1 inch) that you mount with Velcro to the AT's power-supply case. Three

wires and a control panel with variable resistor and toggle switch come out of the frequency synthesizer box; the red wire plugs in beside the wire in pin 1 of the P58 power connector, the black wire plugs in beside the wire in pin 1 of P59, and a wire with a hook-clip is attached to one of the leads of the empty crystal socket. The variable resistor lets you adjust the CPU speed, and the toggle switch engages either

the standard (6 MHz) operation or the variable-speed CPU operation. The panel mounts in the rear of the AT (between the card slots and the fan). The control panel is bolted in place of the utility plate. The control knob and toggle switch stick out the back of the AT's case, preventing you from replacing the plastic rear cover. An adhesive label goes over the control panel to give you approximate CPU speed. A program included with the XCELX software called Tuneup gives a more accurate value for the CPU speed. I used it to set the CPU speed for the benchmark tests.

The CPU speed knob was too easy to turn. If you had to reach behind the machine, you could accidentally brush against the knob, turn it past the speed that the machine could handle, and cause a crash. To be on the safe side you can flip the toggle switch to standard mode, adjusting any cables behind the machine.

The Benchmarks for a standard AT were identical to those I ran with the synthesizer in standard mode (6 MHz). I flipped the toggle switch and was able to crank up the standard AT to 9 MHz before the machine froze. Then I replaced the CPU with an 80286 rated at 12.5 MHz and replaced the standard RAM with 100-ns RAM, both supplied by Ariel Corp. I ran the Sieve and Calculations programs at different speeds; the results are shown in table A. (See *Inside the IBM PCs*, Fall 1985, pages 200-201 for the listings of the Sieve and Calculations programs.) The speed increase going from 6 to 8 MHz was dramatic. While speeding up the machine beyond 8 MHz results in a noticeable decrease in execution times, it becomes less attractive when you have to replace the CPU and memory. Still, it's neat to see the AT running at 11.5 MHz. So far our speeded-up AT has been running the Sieve continuously for four days and is still working fine.

Eva White is a BYTE technical editor. She can be reached at BYTE, One Phoenix Mill Lane, Peterborough, NH 03458.

Table A: Sieve and Calculations benchmarks run on an IBM PC AT at various CPU speeds. The benchmarks at 9 MHz and below were performed on an AT with all stock equipment except for a frequency synthesizer. For those tests at 10 MHz and above, 512K bytes of 100-ns RAM and a 12.5-MHz 80826 were installed. The 80287 was not accessed during these tests.

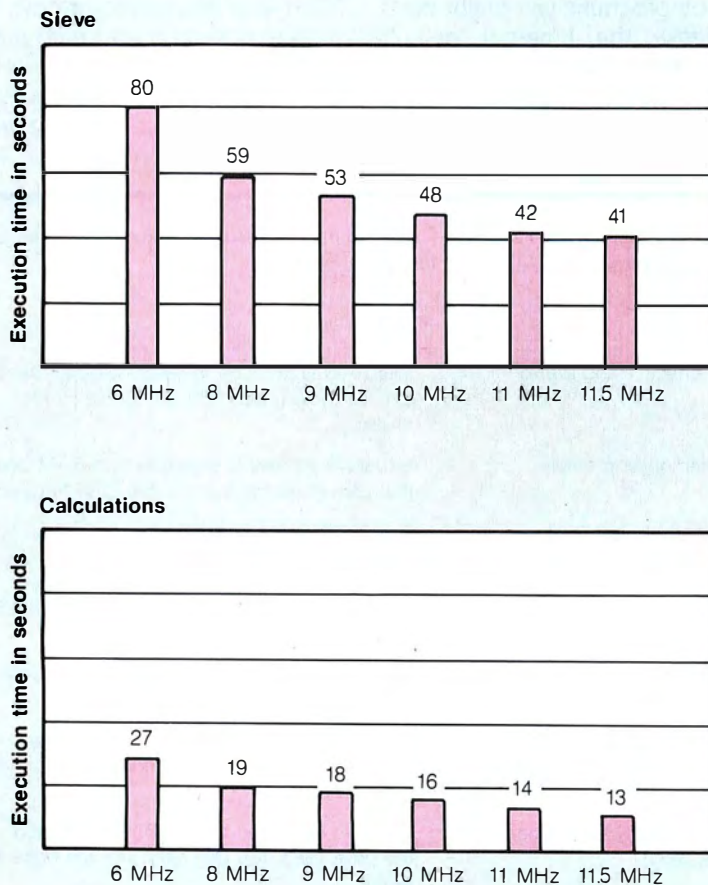

memory or monitor board not designed for anything above 6 MHz.

DAMAGE

With all the components I have mentioned, permanent circuit or chip damage is unlikely when you are increasing the CPU frequency. Provided the frequency is reliable and stable, the worst that you can expect is a reported error or the system refusing to come up altogether. A chip either fails entirely or does not work normally. Heat-related damage might occur from prolonged use of a borderline device or use of an unstable frequency reference. The borderline problem is possible but unlikely. By selecting a lower frequency when you suspect this, you will make damage less likely.

IBM'S WARRANTY

As of this writing, IBM has made no official statement on the effect that in-

creasing the system frequency will have on the company's one-year limited warranty. Officially, IBM doesn't encourage any activity of this type; unofficially, many IBM engineers and salespeople have been performing and recommending the upgrade. The dealer seems to have the final word on the warranty question.

IBM'S NEW ROM

The Model 239 30-megabyte hard disk system is not capable of increased CPU speeds with just a crystal replacement. Because of the popularity of increasing the CPU frequency, IBM chose to alter the ROMs in the new system. The affected ROMs have date codes beginning in June and July 1985. The alteration is a time-based loop in the first 500 lines of code in the BIOS's POST portion. The loop will determine if the CPU speed is greater than 6.6 MHz. If it is greater,

the code will perform a branch that will purposely seize the system. The system will not beep or report any errors. (Newer ROM releases will produce two beeps.) I had considered a sophisticated ROM patch using mapped-in RAM or ROM to the code area. However, such a solution is complicated, inelegant, and would have introduced more vulnerability to the system as a whole.

I have come up with an easy fix for the ROM check. If you maintain a 6-MHz frequency to the 80286 for at least 10 seconds after power-up, the POST sees the standard AT frequency. Slowly and uniformly increasing the frequency to the system's maximum speed circumvents the ROM's investigations. A crystal switch selector would lock up the system if switched while the system was running. Debouncing only marginally im-

(continued)



We Can Do Any Configuration for your system requirements

\$1125

IBM AT Compatible
AT PC/XT Prices



- * Turbo speed-33% faster than IBM AT
- * Designed, Manufactured & Serviced in U.S.A.
- * FCC Class 'B' Approved
- 8/6 MHz switchable, 80286 micro processor
- Dual floppy & hard disk controller
- 1.2 MB high capacity floppy drive
- Fully IBM compatible BIOS, runs major IBM software
- CMOS clock/calendar with battery back-up
- 192 watt Power supply
- AT style Keyboard
- 72 Hours Burn-in
- One year limited warranty

HAWAII Trip includes 8 Days, 7 Nights, Round trip airfare, Hotel accomodations.

Drawing Rules
The drawings will be held on the last day of the month. All purchases of AT System qualify Departure/arrival at San Francisco airport

Computer Library's employees and family members are not eligible to participate

Quantity Discounts are Available

Computer Library

A Lytek Company
An electronic company with Years of experience
(415) 659-8784
5349 Randall Place
Fremont, Ca 94538

AT PC XT are registered Trademarks of IBM

Above System with Monitor & video card \$1350

proves the crystal switch design. A variable-frequency synthesizer proved to be the only reliable option.

It was relatively easy to design a frequency synthesizer that will automatically handle the procedures for getting around the ROM check. The timing loop for detecting an increase in system frequency is activated only

during power-up and during a Ctrl-Alt-Del key combination. If you add an extra connector to a chip that receives this interrupt, the frequency synthesizer resets so that the required 6-MHz CPU speed is maintained during restart of POST.

Unlike crystals, which are passive devices, the frequency synthesizer is

an active device that produces a continuum of frequencies; it allows increasing and decreasing of frequency while the system is running. This makes it easy to adjust the system for top performance. A variable resistor-based circuit offers the widest possible range of frequencies from which to choose.

FLASH
SPEED UP YOUR COMPUTER!
\$49.95

NOT COPY PROTECTED

Increase the **speed** of your computer by as much as **4-8** times. Why buy a PC AT when all you may need is some **FLASH**. **FLASH** is just that, it gives disk accesses in a **FLASH**. Every PC owner can't be without **FLASH** once the powers of **FLASH** are discovered. The program is totally invisible to the user. There is nothing to learn. Make your floppies **faster** than a hard disk. Make your hard disks faster than ever before. Allows the user to have sub-directories on his floppies without the usual loss of speed. **FLASH** will also tell you just how much faster you are running than you would have been without **FLASH**. **FLASH** is handcrafted in ASSEMBLER. Upgrade your computer with **FLASH**. Batch files will fly like they had wings. Save wear & tear on expensive program disks.

You'll be so **amazed** with your improved performance, you will want to call us to tell us so!

"The novice and expert alike will consider **FLASH** their most valued utility."

DAVE LEE REED
President, **SOFTWARE MASTERS**

BENCHMARKS for different programs utilizing **FLASH**

	W/O FLASH	W/FLASH
WORD STAR	2.0	0.33
BASICA	2.7	0.40
LINKING	113.8	6.00
SORTING FILES	105.0	27.00

When **FLASH** increases your speed it generally makes you run **3-5** times faster. In favorable conditions like the ones above **FLASH** can make your PC run **6-16** times faster! PC's over the world are screaming for **FLASH**. Reach the speed of a RAM DISK, without their disadvantages. If you think you DON'T need **FLASH**, call us and tell us why!

Order Line 1-800-25-**FLASH**
Info Line 1-317-253-8088
MC, Visa, Check, C.O.D.
For: IBM PC, AT, XT, JR, or clone.

Now utilizes expanded & extended memory.



Reg. Price.....~~\$69.95~~
Limited Time.....\$49.95
add 4.00 shpng hndl
Software Masters
6223 Carrollton Ave.
Indpls., IN 46220



THE UTILITY ROOM

- **Spool-Master**, ram printer spooler. Multiple copies, handles single sheets, any buffer size. 49.95 **29.95**
- **Buffer-Master**, keyboard buffer extender from 15 to 2000 key type ahead. 29.95 **24.95**
- **Super-Ram-Disk**, set up MULTIPLE ram disks and as MANY as you want. 49.95 **24.95**
- **Calc-Pad**, ram resident calculator, hex octal binary and decimal. Works in ANY graphic mode. Unlimited parenthesis nesting. Many functions. 49.95 **24.95**
- **Sort-Merge-Copy**, a super sort utility. Use it stand alone or call it from ANY language. 150.00 **49.95**
- **Unprotect**, unprotects basic programs. 49.95 **29.95**
- **Data-Path**, Have paths setup to find your data and overlay files. Works with ALL programs. 49.95 **29.95**
- **MoreHard**, gain up to 10%-50% more hard disk space! ALL programs work in harmony with each other. 49.95 **29.95**

SUPER-ED Version 3.0

- Do ANY DOS command or RUN ANY program from within **SUPER-ED**.
- Turbo Pascal like environment for ANY language.
- **MULTI-FILE** window editing. Move & copy between file windows.
- Extensive Find & Replace usage.
- **ON-LINE** editing **HELP**.
- Editing commands & colors & more are fully user configurable.
- **ON-LINE** language-specific user definable **HELP**.
- Full featured editor with **WORD STAR** like commands.
- Fully utilizes sub-directories.
- Supports keyboard **MACROS**.

Reg. Price ~~\$59.95~~
Limited Time **\$39.95**

We believe in the highest quality software at the lowest possible price!

Turbo Pascal is a trademark of Borland Intl. Word Star is a trademark of Micro Pro Intl.

Inquiry 264

NEW 8-MHZ AT

As I write this, IBM is beginning to ship the new Model 339 and 319 8-MHz system. It uses the same Type 2 system board found on most Model 239s. This board requires 256K-bit memory chips rather than the 128K-bit devices the Type 1 board used.

The differences are that the CPU is an 8-MHz marked part, the crystal is a 16-MHz device, and the ROMs (date beginning November 1985) have a loop that senses the CPU speed and causes them to seize on frequencies above 8.6 MHz. I have used a frequency synthesizer in an unmodified system up to and above a 10-MHz CPU speed.

CONCLUSIONS

If you are using an IBM PC AT with 512K bytes of RAM, a 20-megabyte fixed disk, and an IBM monochrome adapter, you can replace the 12-MHz crystal with a 16-MHz crystal without replacing other components. You might even be able to push the 80286-6 to 9 MHz with an 18-MHz crystal. Using a 20-MHz crystal, you would need to replace the CPU. With a 22-MHz crystal you would need to replace the CPU and RAM. At 24 MHz, you would need to replace the CPU, RAM, 82284 and 82288 chips, and possibly some 74ALS TTL chips.

Electronics manufacturers test and rate their products to perform predictably and reliably within their stated guidelines. Normally you should not design products that use components close to or above the manufacturer's specifications. Under most circumstances, I believe this is a good rule to follow, but the AT has a large safety margin; I have found that the benefits of improving its speed greatly outweigh the potential drawbacks. ■

"...masterpiece of IBM imitation...minor masterpiece of the circuit designer's art... impressed by its high standards of quality and workmanship."

Winn L. Rosch, Cloning Your Own PC, PC Magazine, July 10, 1984.

"The most compatible IBM clone I've ever worked with."

Lee Konowe, American Software Club, Ridgefield, CT.



"Fullfills our every need...and leaves us money for software."

John Glenn, Electric Engineer, U.S. Navy.

Display Telecommunications Corporation was named *Best Small Business Exporter in Texas for 1986* because we offer the best IBM® PC clone available.

COMPATIBILITY[®]

DISPLAY TELECOMMUNICATIONS QUALITY

\$750

MEGA-KIT INCLUDES: System Unit • 256K Mega-Board-XT.™
(2) 360K Floppy Drives and Controller • Enhanced Keyboard
• 130W Switching Power Supply—**FCC APPROVED**

- MEGA-KIT™ with Monochrome Monitor and Controller—\$909.95
- MEGA-KIT™ with 20 meg Hard Drive, Monochrome Monitor and Controller—\$1269.90

IBM is a registered trademark of International Business Machines Corporation.

Mega Board-XT™ 289.95

Power Supply 89.95

Disk Drive Controller 59.95

Mega-Case™ 69.95

Keyboard 79.95

Floppy Disk Drive 139.95

CALL FOR PRICES ON OTHER COMPONENTS

INTRODUCING: MEGA-NET™—Display Telecommunication's NET BIOS Compatible Token-Ring Twisted Pair Local Area Network

- Benchmarked 20% faster than IBM
- Uses 40% less memory than IBM

Display Telecommunications Corporation

8445 Freeport Parkway • Suite 445 • Irving, TX 75063
1-800-227-8383 • For Technical Calls Only: 1-214-929-1382
TELEX 5106000176 DTC UD

Inquiry 88

Best Small Business Exporter in Texas for 1986

A Computer Work of Art ...the Advanced 286™



Everything You Ever Wanted in an IBM AT Compatible System, Including Price.

The Advanced 286 offers all the features of the IBM PC/AT® at a fraction of the cost. The Advanced 286 is available for \$1395.

Add \$85.00 for MS-DOS® 3.2 and \$95.00 for GW Basic®.

All systems are FCC Class B/UII approved and come with Phoenix BIOS assuring you of far reaching compatibility.

Features:

- 6/8 MHz Software Switchable
- 640K upgradable to 1 MB on board • Floppy Disk Controller • 1.2 MB Floppy Disk • Patented easy mount mechanism for installing disk drives and streamer tapes
- On board real time clock
- Runs all major software written for IBM PC/AT • Phoenix BIOS

Options:

- Up to 4 MB RAM • 20 to 40 MB Hard Disk • 360K Floppy Disk Drive
- AT Hard Disk Controller • RLL Hard Disk Controller • 3-1/2" Floppy Disk • Streamer Tape



A Computer Work of Art. "Sunrise"... an original computer graphic masterpiece created by the eminent David Em.



Testimonials:

"If compatibility, aesthetic design and price are key considerations in your computer selection decision, you will be delighted with the Advanced 286..."

— Steve Zelencik, Vice President
Advanced Micro Devices

"We have evaluated over 35 clones and compatibles and the Advanced 286 proved superior to all units tested including the IBM AT product. The easy mount disk drive design and providing easy access to three half height devices makes upgrading a snap..."

— Jim Lizzio, President
Concept Development Corp.

Everything You Ever Wanted in AT Compatible Boards Including Price.

- 2 MB Multi I/O Card w/Serial (optional 2nd serial) Parallel, game ports/OK \$179.00
- 3 MB Ram Card/
- I/O Card w/serial, parallel (optional 2nd serial) \$ 89.00
- EGA/256K (Half-Card) \$249.00
 - EGA Monitor ... \$499.00
 - EGA Mouse \$119.00
 - Color/Mono-chrome Graphics Card \$169.00

Advanced 286™

**CALL NOW
FOR
DEALER
PRICING**

**BUY NOW
GET MS-DOS
GW BASIC
FREE!**

Since 1976...
★ ACP
INTERNATIONAL, INC.
1310 E. Edinger Street, Santa Ana, CA 92705
(714) 558-8813 (800) 854-8230

USING ASSEMBLY ROUTINES IN MS-FORTRAN PROGRAMS

Improve the speed of your FORTRAN code

BY MARK DAHMKE

IN THE COURSE of developing a large program, it is often necessary to call assembly language routines to make a critical task efficient or to gain access to features that are machine-specific or not implemented well in a high-level language. To that end, I'll present some mechanisms for dealing with the problem of passing parameters and managing the programming environment when working with Microsoft FORTRAN and 8086-family assembly language. The examples presented here are written in Microsoft assembly language and should work correctly with any version of the assembler.

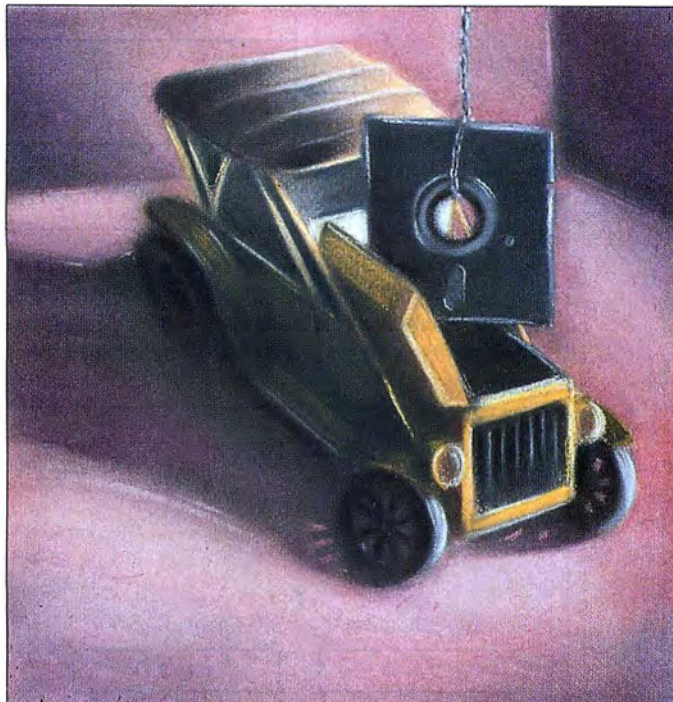

are less efficient to address. The DGROUP also contains stack space and heap space used by FORTRAN.

Due to the 8088 and 8086 family's segmented address space scheme, you must establish addressability before reading or writing memory or you will likely cause your system to crash. "Establishing addressability" means loading one of the segment registers with a 16-bit pointer to the base of the block of memory you want access to. Figure 2 shows how this works. The CS, DS, and SS registers establish addressability for code, data, and stack segments, respectively. The ES register is

THE FORTRAN ENVIRONMENT

Microsoft FORTRAN, Pascal, and C have many common features in terms of their environment, parameter passing, and data structures. Many of the examples shown here will work well with all these languages, but the emphasis in this article will be on Microsoft FORTRAN.

The Microsoft FORTRAN run-time environment is shown in figure 1. Depending on which version of FORTRAN you are using, there may be some minor differences. FORTRAN begins by allocating memory at the first available low address and places the code segment (all user-generated code and library routines) there. All segments that are part of a group must reside in the same 64K-byte

block of memory, due to the segmentation scheme of the 8088 and the 8086. For example, all FORTRAN subroutines compiled together (from one source file) are treated as a group. Thus, you could create a program with 256K bytes of code by compiling the main program and subroutines in four pieces, then linking them.

Similarly, blocks of constants and variables are put in groups that cannot exceed 64K bytes each. The most frequently used of these is the DGROUP, which includes all constants, variables, and unnamed common blocks and strings. If a program becomes so large that the data space exceeds 64K bytes, you must move variables and arrays into common blocks; unfortunately, common blocks

for an "extra segment" that allows you to copy data from one segment to another. The segment registers hold the most significant 16 bits of a 20-bit address. This is added to the "offset" address specified in the instruction. For example, the CS and IP (instruction pointer) registers always point to the current instruction. Addresses of this form are denoted as CS:IP or "segment plus offset."

Parameters passed to subroutines must include the segment portion of the address if the constant or variable

(continued)

A contributing editor for BYTE, Mark Dahmke owns a consulting business and has had three books published by BYTE Books/McGraw-Hill. He can be reached at P. O. Box 80266, Lincoln, NE 68501.

MathCAD

The Engineer's Scratch Pad

FOURIER RECONSTRUCTION: SQUARE WAVE

$N := 40 \quad j := 0 \dots N \dots 40 \text{ points}$

$S_j := 1 - 2 \cdot \delta(j - 20) \dots \text{step function}$

Reconstruct function, using first two terms of Fourier series $i := 1, 3 \dots 3$

$$R_j := \frac{4}{\pi} \sum_i \frac{1}{i} \sin \left[i \cdot 2 \cdot \pi \cdot \frac{j}{N} \right]$$

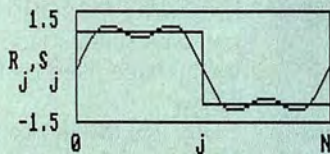

A powerful computation and documentation tool for your IBM-PC.

With MathCAD you simply and interactively create, edit and display formulas on the screen the way you are used to writing them. Equations are instantly computed and the results displayed on the screen as a single number or a plot. Text may be added to the screen and everything may be printed out as an integrated document. MathCAD has built-in hyperbolic and circular functions, performs all calculations with real and complex numbers, performs iterative calculations, handles all units, performs error checking and dimensional analysis and much more...

The price of MathCAD—\$189. In Massachusetts add 5% sales tax.

To order send check, p.o., call us with your MasterCard number or call us for the nearest dealer.

1.800.MathCAD or 617.577.1017

Math Soft

$\Sigma + \sqrt{-} = \times \int \div \delta$

One Kendall Square
Cambridge, Massachusetts 02139

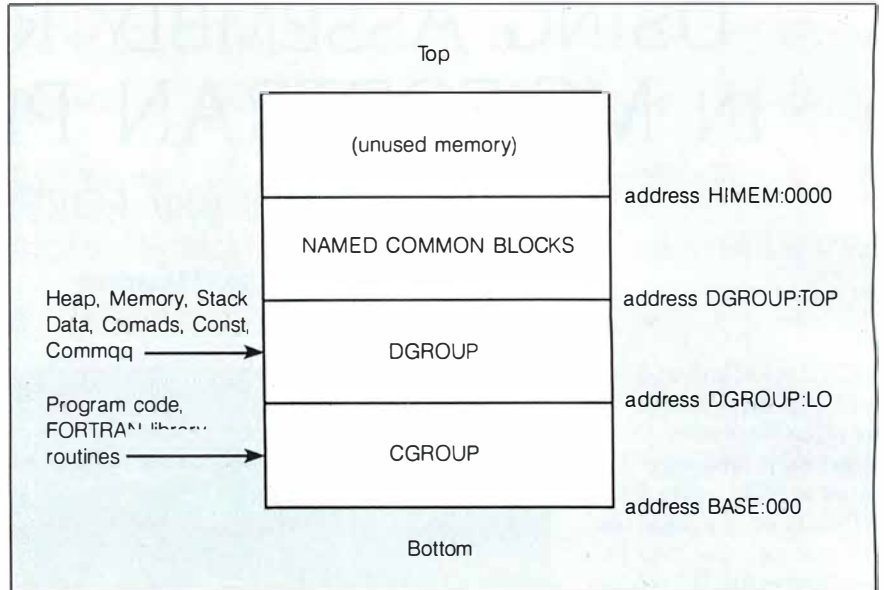

Figure 1: MS-FORTRAN run-time memory organization. FORTRAN sets up two major areas, the code group and the data group. You may need additional groups for named common blocks. Due to the segmented address scheme of the 8086 family, 4-byte addresses (segment plus offset) are required for most parameter passing to subroutines.

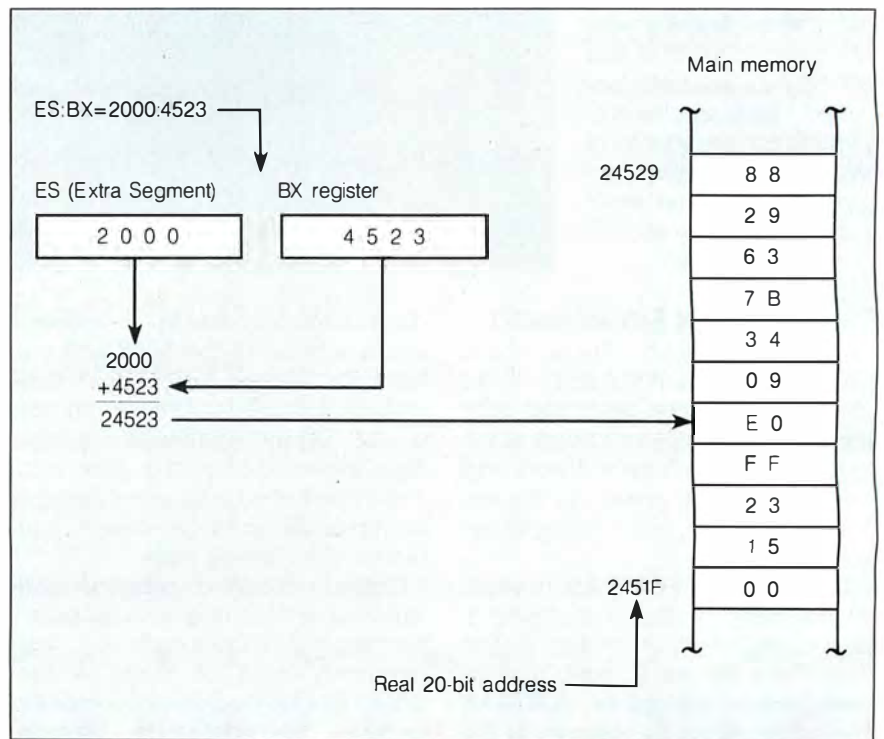

Figure 2: Establishing addressability. Assuming that ES and BX have been loaded with 2000 and 4523, respectively, the instruction MOV AX,ES:[BX] would cause the value 09E0 to be loaded into AX. If interpreted as an INTEGER*2 number, 09E0 would equal 2528 in decimal.

**NETWORK
VERSION
AVAILABLE**

INTRODUCING OPEN ACCESS® II™

**THE FULLY INTEGRATED BUSINESS SYSTEM
WITH THE WORLD AT YOUR FINGERTIPS**

Open Access II is a new, super-program which can perform virtually every managerial and business task you'll ever need with performance and ease-of-use unheard of in the industry.

Open Access II combines an extremely powerful relational database and superior spreadsheet with data communications, word processing, 3-dimensional graphics, and time management. Information is conveniently changed from module to module.

Open Access II's Database features an effective and flexible report generator and user definable screens. "Programmer," our new Database language, features simple interacting English-like commands to produce your customized applications.

Open Access II's Spreadsheet offers a unique combination of business problem solving capabilities; including goal-seeking, and an advanced table look-up command. Professional business presentations are easily produced by the enhanced graphic capabilities.

Open Access II's improved Word Processor can merge data from Spreadsheet or Database easily to produce reports, mail merge and graphic presentations.

Open Access II's data communications provides you with the capabilities to handle any of your micro computer communications needs. All of Open Access II's modules work together and data is easily communicated to the rest of the world.

**BEST OF ALL,
THE PRICE**

\$595.

Open Access II's super program is also available in the network version. Ask for details. Call (619) 450-1526 in California, or (800) 521-3511 if outside California for your nearest authorized dealer or distributor and expand your business base with Open Access II, the fully integrated business system.

SPI

SOFTWARE PRODUCTS INTERNATIONAL

10240 Sorrento Valley Road
San Diego, California 92121

(619) 450-1526

For Your Authorized Dealer
or Distributor Outside California

(800) 521-3511

Inquiry 265 for End-Users.
Inquiry 266 for DEALERS ONLY.

Open Access is a registered trademark of Software Products International, Inc.
Lotus 1-2-3 and Symphony are registered trademarks of Lotus Development Corp.
Framework is a registered trademark of Ashton-Tate.
Enable is a trademark of The Software Group.
Smart is a trademark of Innovative Software, Inc.

**Open Access II
Comparison Chart**

	Database	Form Query	Report Generator	Query Processor	Relational Database	Graphics	3-D Graphics	Spreadsheet	Goal Seeking	Word Processor	Communications	Time Management	Price
Open Access II	✓	✓	✓	✓	✓	✓	✓	✓	✓	✓	✓	✓	595⁰⁰
Lotus 1-2-3	✓					✓	✓	✓					495 ⁰⁰
Symphony	✓	✓	✓			✓	✓	✓	✓	✓			695 ⁰⁰
Framework	✓		✓	✓		✓	✓	✓	✓	✓			695 ⁰⁰
Enable	✓		✓			✓	✓	✓	✓	✓			695 ⁰⁰
Smart	✓		✓			✓	✓	✓	✓	✓			895 ⁰⁰



SERVICE DIAGNOSTICS

Your Microcomputer Repair Solution. For over seven years, major manufacturers have been relying on SuperSoft's[®] diagnostics software to help them and their customers repair microcomputers. End users have been relying on SuperSoft's Diagnostics I and II, for the most thorough hardware error isolation available. Now SERVICE DIAGNOSTICS is available to save everyone time, money and headaches in fixing your IBM[®]PC, XT, AT or compatibles.

Tests all of the major components of your system, even non-IBM equipment:

CPU and System Board	System Memory	Keyboard
8087 Co-processor	Expansion Memory	Color Graphics Monitor
Floppy Disk Drives	Parallel and Serial Ports	Monochrome Monitor
Fixed Disk Drives	Standard Printers	Color Graphics Adapter
Non-standard Drives	All other printers	Monochrome Adapter

No other diagnostics can test non-IBM equipment, such as IBM compatibles, NEC[®] CPUs, add-on boards, special disk drives, and printers.

Join the ranks of XEROX[®], CDC[®], SONY[®], PRIME[®], MORROW DESIGNS[®] . . . who have bundled SuperSoft diagnostics with at least one of their microcomputers.

SERVICE DIAGNOSTICS goes farther than any other diagnostics for IBM PC, XT, and AT, as well as all compatibles \$225
Dysan[®] alignment disk for further rigorous floppy testing \$40

Diagnostics II is the solution to the service problems of users of ALL CP/M-80[™], CP/M-86[™], and MS-DOS[®] computers \$125

To order call 800-762-6629 (in Illinois 217-359-2112), or write to SuperSoft.



FIRST IN SOFTWARE TECHNOLOGY P.O.Box 1628 Champaign, IL 61820 (217) 359-2112 Telex 270365

SUPERSOFT is a registered trademark of SuperSoft, Inc.; CDC of Control Data Corp.; Dysan of Dysan Corp.; IBM PC, AT & XT of International Business Machines Corp.; Morrow Designs of Morrow Designs Corp.; MS-DOS of Microsoft Corp.; NEC of NEC Information Systems, Inc.; PRIME of PRIME INC.; Sony of Sony Corp.; and Xerox of Xerox Corp. CP/M-80 & CP/M-86 are the trademarks of Digital Research, Inc.

is not considered local to the subroutine. Since it is almost impossible to tell in advance whether the DS or ES register will be correctly loaded before calling the routine, FORTRAN always passes the segment and offset to a subroutine.

PASSING PARAMETERS

Two cases must be dealt with in FORTRAN: functions and subroutines. In both cases, FORTRAN uses the call-by-reference method for passing parameters, even for constants and expressions. This method makes it easier to write assembly language programs, since the values being passed are always addressed in the segment-plus-offset format.

For both functions and subroutines, the parameters are placed on the stack in the order in which they appear in the parameter list of the calling program. Figure 3 shows the stack before a call to a sample function. In the case of functions, results are returned in registers if the result is defined as an integer or single-precision real number. If the result is 16 or fewer bits long, it is assumed to be in the AX register upon return. If the result is declared INTEGER*4 or REAL*4, it will be in the AX,DX pair. If a number is double-precision (REAL*8), the result must be returned in a dummy variable created by the calling program. The offset address of this variable is in the stack at location BP+6.

SUBROUTINES

All variables passed to subroutines and all results returned from subroutines are passed as parameters in the call list. Figure 4 shows how the stack is loaded prior to calling the sample subroutine shown.

ENTRY AND EXIT REQUIREMENTS

As shown earlier, the addresses must be obtained from the stack and placed in segment and offset registers to gain access to the value of the variable. This can be confusing, especially if the stack contains many parameters. All addressing is done on the basis of the base pointer (BP) register.

(continued)

THE CURE FOR THE COMMON CLONE!

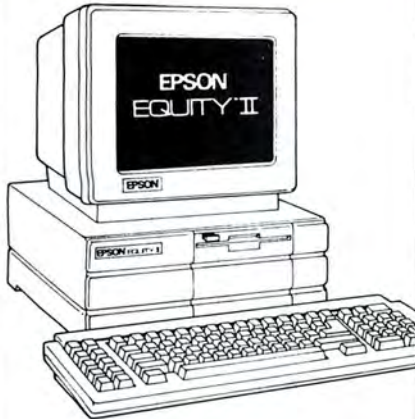

EPSON EQUITY II

IBM-PC compatibility mated to the new NEC V30 microprocessor gives you 8086 CPU power at speeds of 4.77 and 7.16 MHz. On board you'll find 640K RAM, color and Hercules compatible graphics, clock/calendar and 5 full size option slots - all standard equipment! Add to this two 360K drives, an AT-type keyboard and a one year warranty - well, you can see it makes sense to start building some EQUITY into your business.

The Epson EQUITY II.....CALL

CAD



DMP-29

houston instrument

DMP 41/42	\$2449
DMP 51/52	3699
DMP 56	4399
DMP 29	1699
DMP 40	889

True Grid Digitizers

TG 1005	\$289
TG 1011	509
TG 1017	619

Also: cursors, styli, etc.

HANZON LP-3000+ LASER CALL
HPGL PLOTTER COMMANDS!!!

NEC MULTISYNC \$529

ACS GRAPHAX 20/20 2K by 2K Graphics Resolution
Single Card Design, up to 32 Colors, Supports
AutoCAD. CALL

ACS
EVERYONE'S PHONING HOME ABOUT THIS ADVANCED "AT" COMPATIBLE SYSTEM



"ET-286" BASIC SYSTEM

12MHZ ONE WAIT STATE OF 10MHZ NO WAIT STATE SPECIAL ORDER - ALLOW 5 WEEKS. 10 & 6 MHZ 80286 CPU ONE WAIT STATE, 1-4MB RAM ON MOTHER BOARD.

ALSO ON MOTHERBOARD:

- * 6 AT COMPATIBLE SLOTS
- * 2 XT COMPATIBLE SLOTS
- * 3 RS232 OR RS422 SWITCHABLE S PORTS
- * 2 CENTRONICS P PORTS
- * CLK/CAL WITH BATT BACK-UP
- * 100% IBM-AT COMPATIBLE BIOS
- * CABLE, 200 WATT P/S, & KEYBD..\$1595

Printers

CORDATA LP300 Laser w/ WordStar 2000	2175
TOSHIBA P321 Para & Serial	449
TOSHIBA P341	789
CITIZEN MSP25	499
CITIZEN MSP 20	349
CITIZEN 120D 120CPS, TRAC	189
OKIDATA 292 Color Printer	459
OKIDATA 293 Color W/ Trac, 132 Col	589
OKIDATA Personality Boards	88
XEROX Diablo D25.....\$484 Diablo 635	949
XEROX 4045 Laser	4585
STAR MICRONICS SR15.....	595

BROTHER M-1509



~~\$399~~ CALL

180 CPS Draft - 45 CPS NLQ - Push Tractor
Auto Feed - S&P Ports - Wide Carriage
EPSON Compatible - More!

1409	CALL
TWINWRITER 5 Daisy & Dot Matrix	CALL
HR35 36 CPS Daisy, 132 Col	\$729
HR20 20 CPS	\$349
HR15XL Daisy	\$299

Hard Disk & Tape Subsystems

20 MB HARD DRIVES
with CONTROLLER

\$379

MICROPOLIS MC-1325 85MB 30mSEC 5 1/4"	1299
QUANTUM Q540 43MB, 45mSEC 5 1/4"	939
MAXTOR XT1140 140MB, 30mSEC 5 1/4"	3299
AMCODYNE ARAPAHOE 7110, 25MB Fixed & 25MB Removable CDC Lark Plug Compatible	CALL
IRWIN 10MB Tape B/U	369
IRWIN 20MB Tape B/U	459
WANGTEC PC-36 60MB INT Tape FAST!!!	785

Software

WE SELL ALL WELL KNOWN BRANDS. ORDER
CORRECTLY! OPENED SW IS NOT RETURNABLE!

PC Boards, Etc.

TECMAR WAVE 64 - 256K..\$149 BOSUN S,P,CLK. 149	
TECMAR Expansion Chassis - 11 Slots, Etc.	595
TECMAR Graphics Master	429
TECMAR IEEE 488	235
AST 6 Pack Plus	165
AST 6 Pack Premium	385
AST Rampage AT	512
AST Advantage	385
INTEL Above Board PCMB 1010..... List \$345 Sell 199	
INTEL Above Board - AT 128K to 4MB	399
STB Rio Grande 128K to 5MB	269
MACROTECH MSRAT 6,8,10,12MHz, to 3MB ..From 185	

PC & AT Multi User Cards

ALLOY PC-SLAVE/16 1MB 8MHz V-20	\$655
RTNX MSDOS 2.1 / ATNX MSDOS 3.1	119/189
PC PLUS PKGI PC Slave / 16, Link 125 Term, 20' Cbl1099	

Scientific / Indust. Bds.

Industrial Computer Designs:	
A/D 64-100.....\$315	A/D 64-PC.....\$396
D/A 64-100.....\$236	D/A 64-PC.....\$468
1018-PC 96 TTL INPUT LINES	\$446
Scientific Solutions (TECMAR)	
IEEE-488.....\$239	LAB MASTER.....\$659

Power Systems & Acces

SAFE (SAFT) SPS1000 WATT SINE WAVE	\$989
SOLA 750 WATT With 4500 WATT HI-INRUSH	1495
Computer Accessories:	
ALL CABLES SOLD AT DEEP DISCOUNT	CALL
S4 4 CIRCUIT SURGE SUPPRESSOR.....	\$19
S10 6 CIRCUIT SURGE SUPPRESSOR	29
P15 5 CIRCUIT MON BASE W/ MODEM PROT	98
U1000 POWER SAVER 1000W U.P.S. (TOPAZ)	729

Modems

CTS Hayes Comp. 212 AHC.....\$149 224 AD*1	\$295
PROMETHEUS PROMODEM 1200	259
PROMODEM 1200G.....\$179 2400G	339
MULTITECH MT224EH MNP	529
MULTITECH MT224ER Rack Mount	495

Floppy Disk Drives

MITSUBISHI 2894 8" \$475 2896 1/2 HT,8" \$435	
MITSUBISHI MF501 48TPI..\$95 MF504 96TPI..\$129	
TEAC FD55BV 48TPI	\$89
TANDON TN-50 DSSD For Compatibles	CALL

Computer Systems

BIG BLUE CLONE™

When you need performance without the Name Brand cost, the BIG BLUE CLONE from S-100 will fit the bill at a price that will let you foot the bill.

THE BASIC B.B.C.:

256K turbo with 8 Slots, 150W P/S, Slide Case, Speaker, At Style Keybd, F.C.C. Approved & a 1 Yr. Warr \$424
CALL 1-528-2138 NOW FOR ADDITIONAL OPTIONS!

CORDATA AT SERIES:

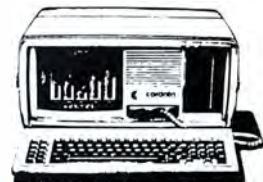

NEW LOW PRICES

AT PORTABLE 8MHz, 640K, 1.2 Fipy, S,P, Mon \$1649
AT DESKTOP 8MHz, 640K, 1.2 Fipy, S,P..... 1569
AT DESKTOP 20MB as above w/ H.D. 1999

PC-400 512K, 2 Fipys, 14" 6740x400 Mon 979
PPC-400 as above but Portable w/ 9" Mon 979
20MB Version of Desktop or Portable 1369

ALSO:

SPERRY PC/IT Enhanced \$2899 || ZENITH 148, 158, 171, 200 AT | CALL |
ALTO 1086-50 1MB RAM, 50MB HARD DISK, 50MB TAPE DRIVE, XENIX	11399
ALTO 1086-80 AS ABOVE WITH 80MB HD & TAPE	12999
ALTO 686-25 6 USER, 25MB HD, XENIX	4099

Monitors & Terminals

NEC MULTISYNC	\$529
ZENITH 1240 Flat Screen, Amber	149
PRINCETON GRAPHICS All Models	CALL
TATUNG 1422A Dual Freq, Tilt/Swivel 14" G/A	139
TATUNG 1360 640x200 RGB, 13" G/A Switch	339
WYSE TERMINALS ALL MODELS	CALL
LINK 125 Emulates WY-50 1 Year Warranty	399

POP-UP TIME & BILLING SOFTWARE FOR \$99.95?

**IT'S NEVER BEEN
DONE BEFORE!**

But now you can have the ultimate RAM resident system that does your billing and graphically shows where your assets are!

TIMESLIPS™ WILL...

- Time phone calls like a "stopwatch."
- Batch enter time/expense data.
- Generate professional bills with over 5,000 formats, aged receivables, flat fee and more.
- Produce business & financial reports.
- Export data to spreadsheets & databases.
- Track your Retainer/Trust accounts.

TIMESLIPS IS PERFECT FOR:

- Consultants
- Lawyers
- Accountants
- PR/Advertising
- Any service oriented professional

DON'T WASTE ANOTHER BILLABLE MINUTE!

GET TIMESLIPS...THE SOFTWARE THAT FITS THE BILL!

**ONLY \$99.95 (plus \$7.00 S/H).
30-Day Money Back Guarantee.
Call (800) 225-5669 to order.
For RUSH SERVICE and additional
information, call (617) 468-7358.**

TIMESLIPS IS NOT COPY PROTECTED.

NEW!!

TIME-LINK: PLUS™—\$49.95! Integrates TIMESLIPS with ONE-WRITE PLUS™—"The accounting software for anyone who can write a check."

ONE-WRITE PLUS is available from North Edge Software at special prices!!



—north edge—
—software—
—corp—

P.O. Box 286, Hamilton, MA 01936
617-468-7358

All of the above are trademarks of third parties except TIMESLIPS which is a trademark of North Edge Software Corp.

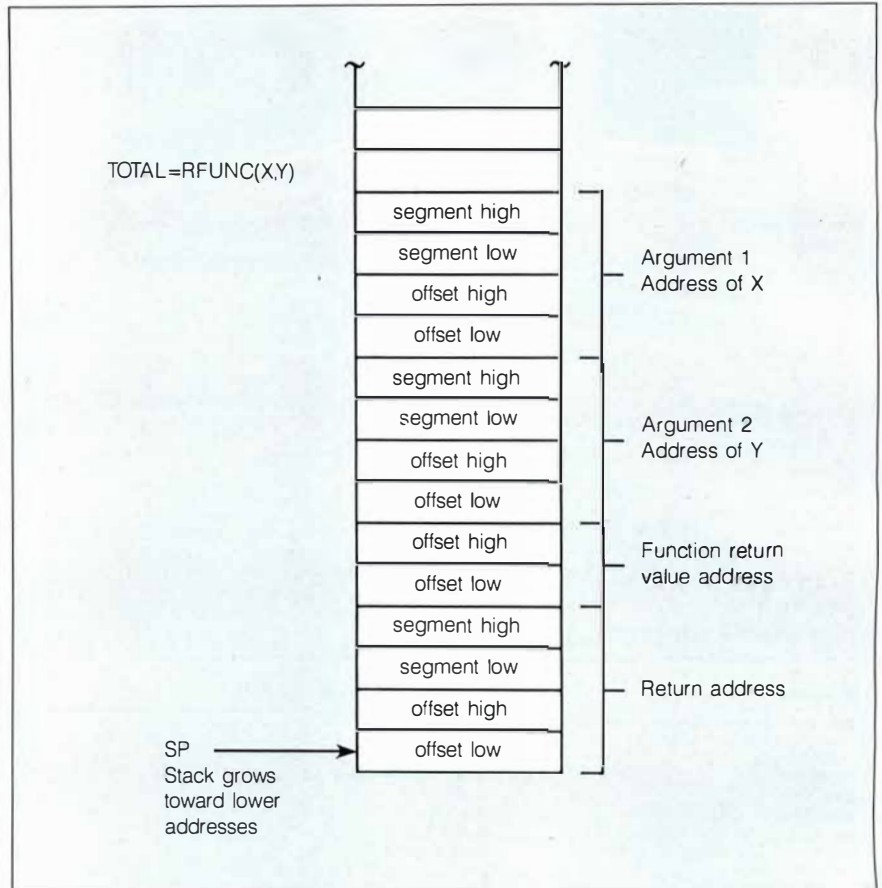

Figure 3: The stack segment before a function call. All argument addresses are pushed onto the stack prior to a subroutine or function call. Four bytes are required to store each address in the segment-plus-offset format.

To simplify the process of computing offsets, I wrote the macros shown in figure 5.

SETFRAME (see listing 1) performs the housekeeping tasks needed to gain access to the stack. The frame pointer must be saved, so it is in the same location when returning to the calling program. Also, the stack pointer (SP) must be loaded into the BP so that the offset address to the parameters will be correct.

The GETPARAM macro solves the problem of getting an address and putting it in the ES:BX register pair. The first argument of GETPARAM is the number (counting from the left) of the parameter you want to retrieve. The second argument specifies the total number of parameters in the call list. For example, if the call CALL SUBR(A,B,C) were made from a pro-

gram, and you wanted to retrieve the address of the variable C, you would enter GETPARAM 3,3, which would return the address of the third of three parameters. Listing 1 shows the instructions generated for all three parameters in the call list of this sample program. [Editor's note: Listing 1 and the sample assembly language subroutines discussed below are available on disk, in print, and on BIX. See the insert card following page 176 for details. Listings are also available on BYTEnet. See page 4.]

The third macro shown in figure 5 is for housekeeping at the end of a subroutine. POPRET will make sure the SP and BP registers are returned to their starting values and that the correct number of bytes is popped off the stack before returning. This is necessary because the calling program

(continued)



If you pay the price of a network, you're paying too much.

The Classic Multiuser System delivers full PC performance to multiple users for half the price (or less) of a network.

Which helps explain why it's selling so well. And why ComputerLand chose it.

You can select from a virtually unlimited selection of software. The Classic Multiuser System runs all DOS 3.1 and 3.2 programs, in addition to most programs designed to run on the IBM and 3Com 3+ networks.

You get all the advantages of a network in a true multiuser solution, complete with record locking and file sharing.

It just doesn't make sense anymore to add a PC for each new user when you need only monitors and keyboards.

Especially since the Classic Multiuser System is faster to install

than a network. And much easier to work with, because all users see are the familiar DOS commands they already know. So you not only save on hardware, you save on training and support.

Simply insert our solution in an AT (or in a PC with our 286 Speed Pak) and you're ready to grow your own economical Classic Multiuser System.

Ask for the Classic Multiuser System at participating ComputerLand stores nationwide. Or call us at 800/392-8324 for the dealer nearest you. (408/434-9333 in CA.)

Or pay the price.



Inquiry 60 for End-Users.
Inquiry 61 for DEALERS ONLY.

The Classic Multiuser System. Now at ComputerLand.

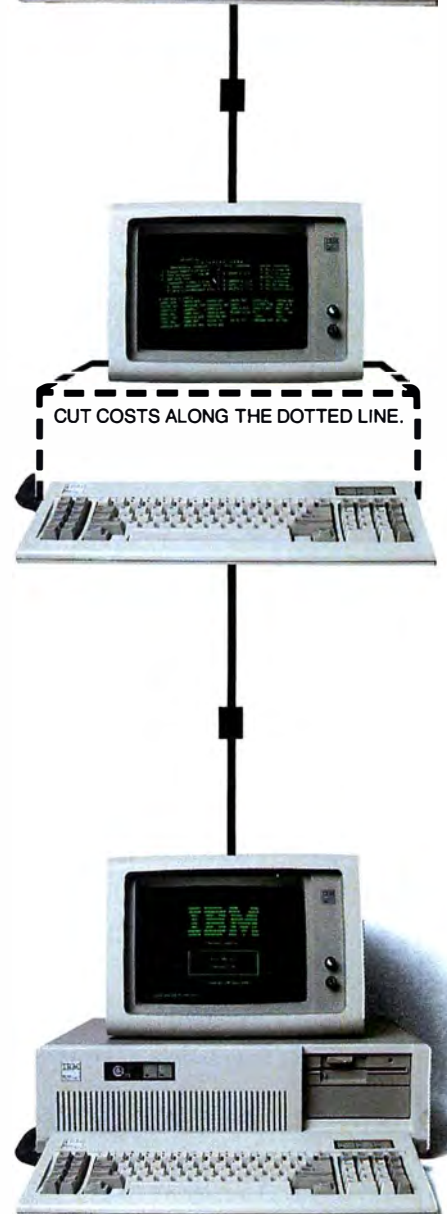

Atlanta Office: 404-587-3237
Chicago Office: 312-695-8233
New York Office: 516-434-1616

Classic Technology Ltd.-EUROPE
Jupiterstraat 98
2132 HE Hoofddorp
Netherlands
31-2503-32074

IBM is a registered trademark of International Business Machines Corporation.
3COM 3+ NETWORKS is a registered trademark of 3Com Corporation.
COMPUTERLAND is a registered trademark of ComputerLand Corporation.
CLASSIC, 286 SPEEK PAD and CLASSIC MULTIUSER SYSTEM are trademarks of Classic Technology Corporation.

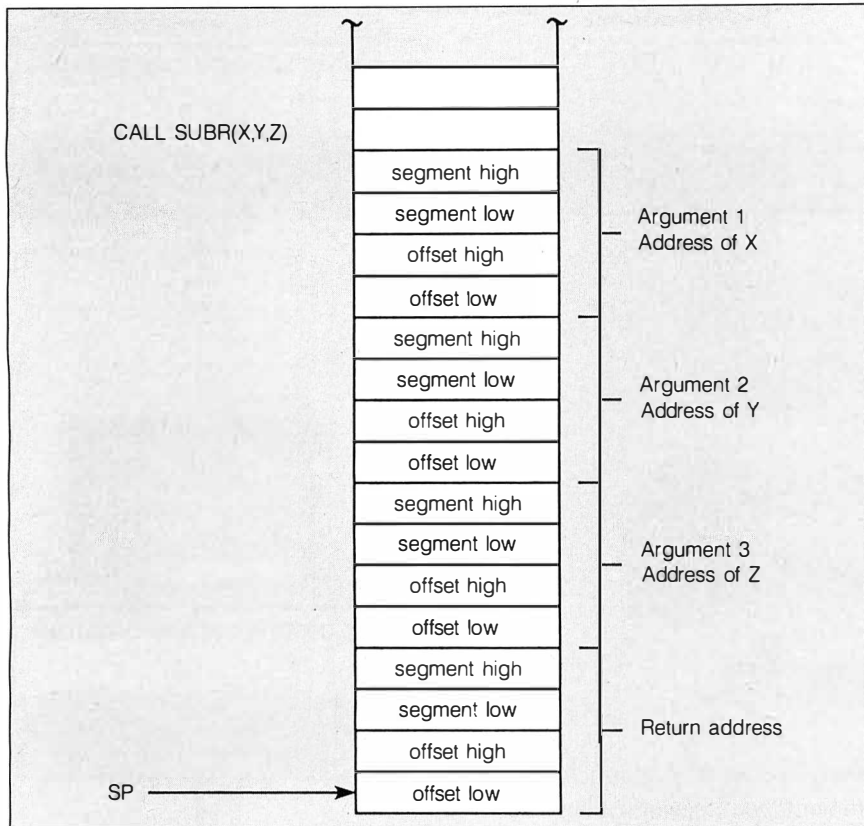

Figure 4: The stack segment before a subroutine call.

assumes that the stack is the same as it was before setting up for the subroutine call. The only argument given to POPRET is the number of parameters in the call list. In this example, four parameters were passed, so you would code POPRET 4. After 16 bytes are popped off the stack, a FAR return instruction is executed, which passes control back to the caller.

EXAMPLES

I have written four sample subroutines. The first two, SRCHF and SRCHN, allow a calling FORTRAN program to scan the current directory for file names. These subroutines use the old DOS function calls that use FCBs (file control blocks) instead of the newer DOS functions, which use file handles.

SRCHF and SRCHN are almost identical, except that SRCHF locates the first matching directory entry and SRCHN finds subsequent matching entries. SRCHF is called just once, while SRCHN can be called repeatedly to get subsequent filenames that may or may not be identical to the first one returned.

(continued)

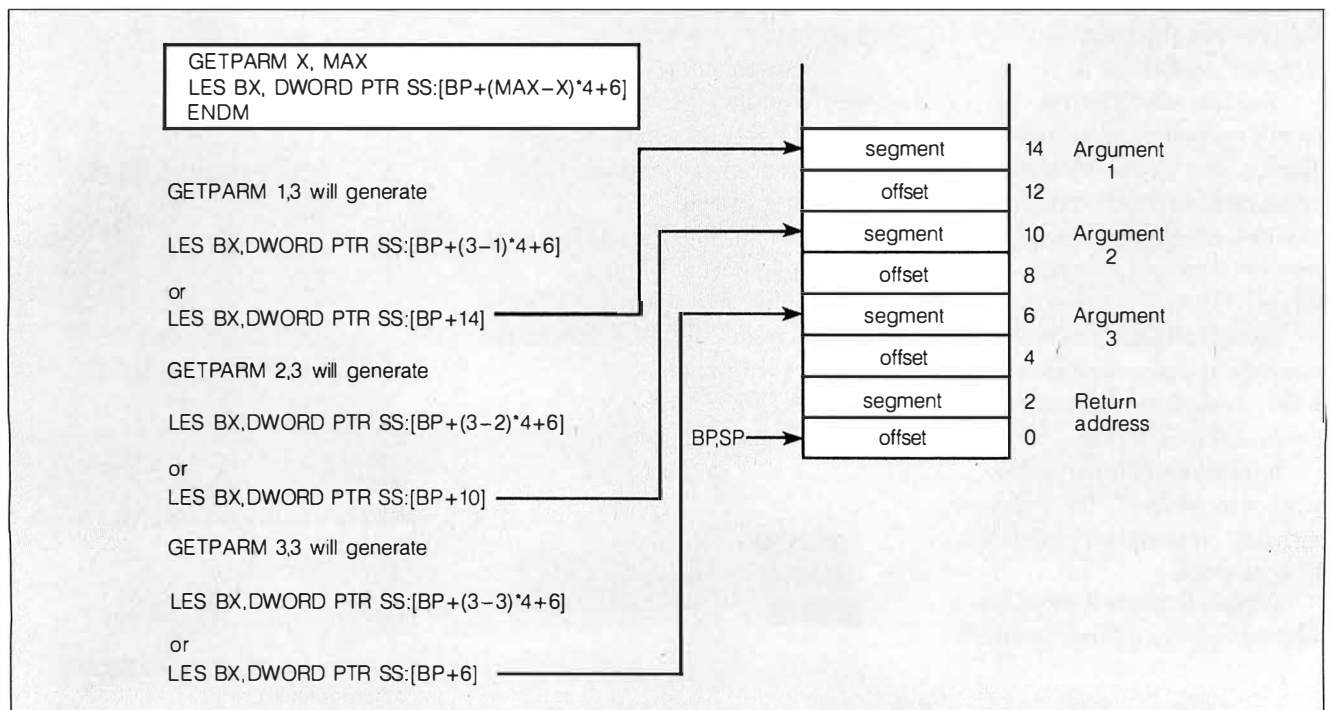

Figure 5: Utility macros that simplify parameter handling in assembly language subroutines.

ComputerLand chooses the Classic 286 Speed Pak. Here's why...

Model Available Now!
10 Mhz
Increases Speed 10 Times

Speed. Compatibility. Upgradeability. You need all three in a turbo board for your PC/XT.

And no one but Classic delivers all three.

The Classic 286 Speed Pak makes your PC/XT blaze-up to **7 times** faster with the 8Mhz model, and **10 times** faster with the 10Mhz model. That's up to 100% faster than turbo boards that use cache.

And it's the only fully compatible turbo board. Simply plug in and run. No software patches needed. It works with the IBM EGA, Lotus/Intel Above Board and all popular networks.

What's more, the Classic 286 Speed Pak is the only turbo board that grows with your needs...

TURBO BOARD COMPARISON	CLASSIC 286 SPEED PAK	ORCHID TURBO 286E	VICTOR/PCT MOUNTAIN
SPEED: ▲ INCREASES PC/XT SPEED* ▲ 16-BIT PROCESSING-20-30% FASTER THAN CACHE	4-5X YES	5X YES	2-3X NO
COMPATIBILITY: ▲ FULLY SOFTWARE/HARDWARE COMPATIBLE ▲ NO SOFTWARE PATCHES NEEDED ▲ IBM EGA COMPATIBLE ▲ LOTUS/INTEL EMS COMPATIBLE ▲ NETWORK COMPATIBLE ▲ STANDARD 8088 MODE	YES YES YES YES YES	NO NO NO NO YES	NO NO YES YES YES NO
UPGRADEABILITY: ▲ 16-BIT MEMORY EXPANSION UP TO 16MB ▲ 16-BIT EMS TO 5MB ▲ MULTIPLE VDISKS ▲ MULTIUSER OPTION	YES YES YES YES	NO NO NO NO	NO NO NO NO
PERFORMANCE: ▲ FULL 16-BIT BIOS/RAM ▲ INCLUDES 1 MB MEMORY	YES YES	YES YES	NO NO
3-YR. WARRANTY:	YES	NO	NO

The "DYNAMIC DUO"

Add Classic SHADOW 2.5MB memory modules to run high speed EMS memory. You'll move through huge spreadsheets with dazzling speed, thanks to SHADOW's 16-Bit memory.

And your disk-hungry programs run lightning fast with SHADOW's high capacity RAM disks. You have the flexibility to use both EMS and RAM disks for more power and speed.

You can even turn your PC or XT into a complete multi-user, multitasking system.

The 286 Speed Pak and the SHADOW are the perfect pair to make your PC or XT a *real powerhouse*.

So visit your local ComputerLand store today or call 800-392-3224 for the name of your local Classic dealer [In CA, call 800-338-0777].

Because no one else gives you everything in a turbo board. No one, no way, no how.

Classic Technology Corporation, 2090 Concourse Drive, San Jose, CA 95131.

Atlanta Office: 404-587-3237
Chicago Office: 312-695-8233
New York Office: 516-434-1616

Classic Technology Ltd.-EUROPE
Jupiterstraat 98
2132 HE Hoofddorp
Netherlands
31-2503-32074

Shadow

286 Speed Pak



Inquiry 62 for End-Users.
Inquiry 63 for DEALERS ONLY.

**Everything you always
wanted in an IBM.**

*Average benchmark using popular programs
IBM is a registered trademark of International Business Machines Corporation
CLASSIC, 286 SPEED PAK and SHADOW are trademarks of Classic Technology Corporation
COMPUTERLAND is a registered trademark of ComputerLand Corporation

Because these two routines are nearly identical, I will describe only SRCHF in detail. The calling FORTRAN routine must load a string with the filename to be matched. This name may include question mark (?) as a wildcard, but not an asterisk (*). While the asterisk is a valid wildcard in many DOS commands, this low-level function call doesn't recognize it. Normally the asterisk is parsed by the calling program and converted into question marks.

The calling program must pass two other parameters: the drive code and an empty string in which the requested filename is returned. The drive code is an integer that corresponds to the disk drive letter (1 = A., 2 = B., 3 = C., and 0 = default).

Upon receiving control, the SRCHF routine retrieves the drive code value. The GETPARM 1,3 macro looks into the stack and finds the double word pointer for the drive code, which is returned in the ES:BX register pair.

The next instruction gets the value of the drive code and stores it in the AX register. The FCB template must be initialized with the drive code and filename. The next instruction copies the least significant byte of the drive code (all that really matters anyway) into the first byte of the FCB.

Next, a GETPARM 2,3 macro retrieves the pointer to the second of three parameters passed to SRCHF—the filename itself. The filename must be stored as 11 characters with no period separating the filename from the file type. For example, the filename SAMPLE.DAT would be stored as SAMPLE___.DAT. A second pointer is set up to copy these 11 bytes from the FORTRAN string to the filename area of the FCB. The length is loaded into CX, and a REP MOVSB instruction performs the copy automatically.

After the FCB is loaded, DOS must be told where to find the buffer that will hold the resulting FCB. This is

done through the SET DMA ADDRESS function call. Finally, a call to the SEARCH FIRST function will cause DOS to check the directory and return either a matching filename or an error code. If a filename is found, an error code of zero will be returned, along with the filename in the same 11-byte format as described earlier. If no files are found, the subroutine returns a single question mark in the first character of the returned filename string.

GETDIR AND CHDIR

The subroutine GETDIR returns the current directory name. Three parameters are required: an empty string to store the resulting directory name, the drive code, and an error code variable.

This routine first gets a pointer to the character string and stores the segment and offset in STRING__SEG and STRING, respectively. After load-

(continued)

Listing 1: The GETPARM macro loads the ES:BX pair with the address of a parameter from the subroutine call list. The first argument of the macro is the number (counting from the left) of the desired parameter in the call list. The second argument (X,MAX) is the maximum number of parameters in the call list.

```

; SETFRAME: Sets the environment upon entry to a subroutine.
;
SETFRAME MACRO
    PUSH    BP                ;SAVE FRAMEPOINTER ON STACK
    MOV     BP,SP
    ENDM

;
; POPRET: Restores the BP register and returns to the
; calling FORTRAN routine after cleaning up the
; stack.
;
POPRET MACRO NPARMS          ;RETURN FROM SUBR. NPARMS=NUMBER OF PARMS
    POP     BP
    RET     NPARMS*4
    ENDM

;
; GETPARM: returns a pointer to a parameter in the call list.
;
; Operands: X = the number of the desired parameter
;           MAX = the maximum number of parameters in
;           the call list.
;
; Result: The ES:BX register pair points to the parameter.
;
GETPARM MACRO X,MAX          ;PARAMETER NUMBER (IE, 1,2,3)
    LES     BX,DWORD PTR SS:[BP+(MAX-X)*4+6]
    ENDM

;
;

```

AVOCET INTRODUCES MACRO ASSEMBLERS.



Put your design ideas into more chips.

New AVMAC™ Macro cross-assemblers, combined with our simulators, emulators and EPROM programmers, turn your PC or VAX into a complete development system.

AVMAC is fast. Its transparent buffering scheme provides the speed of memory-based assembly without restricting file size. And, AVMAC has one of the most comprehensive macro facilities available.

AVMAC is loaded with features that make your development job easier. You get source code flexibility; AVMAC supports over 1000 relocatable segments. AVLINK™ linker and AVLIB™ librarian support modular programming with full control over segment combination and placement. AVREF™ generates cross-references by line and procedure. And, AVMAC gives you informative, plain English error messages.

AVMAC offers superior compatibility with manufacturers' assembly languages. And it's designed to work hand-in-hand with AVSIM™, Avocet's software simulator/debugger.

Every company talks about service. But at Avocet we're committed to satisfying customer requests for in-stock items in 2-3 working days. And that's a fact!

For easy access, call our 800 number for ordering, product information and technical assistance. We're also interested in *your* ideas on how we can better serve your needs.

AVMAC Macro Cross-assemblers	
MSDOS™, PCDOS™	\$349
XMAC68K	\$595
VAX™/UNIX™	\$995

Target Microprocessor Families Supported:

6804	6502/65C02	Z8
6805	6800/01,6301	Z80
6809	NEC 7500	68H11
1802/1805	8085	HD64180
8048/8041	COP400	68020
8051	F8/3870	68000/68010
NEW!	TMS32010	TMS32020

In addition to AVMAC, Avocet provides everything you need to develop microprocessor software.

AVSIM full-screen Simulator/Debuggers make software simulation practical. Test your code in a crashproof, interactive environment, without additional hardware. Price \$299.

TRICE™ self-powered In-circuit Emulators recognize 34 different commands;

set break points, single-step, trace and more. Priced from \$498.

AVPROM™ Programmers work with any PC. Program over 37 different devices, including EPROMs through 27512, CMOS and E²PROMS, and MPU/EPROM combos, using fast, "adaptive" algorithms. From \$429. Gang programmers from \$979.

To find out more about Avocet software development tools, call us toll-free:

1-800-448-8500

(In the U.S. except Alaska.)

VISA and Mastercard accepted. Most popular disk formats now available—please specify. Software shipment by second-day air within the continental U.S. included. Special handling and other shipping additional; call for exact quotes. OEM INQUIRIES INVITED. Avocet Systems Inc., P.O. Box 490-B16, Rockport, Maine 04856, (207) 236-9055. Telex: 467210 AVOCET CI.

AVOCET SYSTEMS INC.®



™ signifies manufacturer's trademark

SOLID OAK COMPUTER FURNITURE

\$135*

Computer Desk	\$135
Keyboard Slide	\$ 25
CPU Storage Unit	\$ 25
Pencil Drawer	\$ 25
48" Hutch	\$ 30
20" Hutch	\$ 20



Dimensions: 48"L x 20"D x 27"H
(Other Dimensions Available)
Order desk without a finish and save 10%
*Plus Options and Shipping

Satisfaction Guaranteed
or Your Money Back

**COMPUTER
FURNITURE
CRAFTSMEN**

1812 Dan Court
P.O. Box 10 Palm Bay, FL 32906
1-305-725-2356



USING ASSEMBLY IN MS-FORTRAN

ing the drive code into the AX register, the string segment and offset addresses are loaded into the DS:DX pair, and DOS function 47h is called. This function stores the full directory name in the string space but will not add a leading backslash (\) or drive letter and colon to the name. Thus, if you are currently in the directory C: \ MAIN \ SAMPLE, this subroutine will return the string MAIN \ SAMPLE. Also, the string will be terminated with a null or zero byte. After the DOS function call, the return code is stored in the third variable and returned to the calling program.

CHDIR (change directory) is almost identical to GETDIR, but the input directory name can be fully qualified, including a drive code, colon, and leading backslash character, just as you would enter it in the DOS CD command. The string must be terminated with a null or zero byte to be accepted, though.

THE GETDFS SUBROUTINE

The GETDFS (get disk free space) routine returns information about the disk drive. Three values are returned, indicating the number of bytes per sector, sectors per cluster, and the number of free clusters on a disk. With these three values, you can calculate the number of free bytes easily. The values are returned to the calling program in INTEGER*2 variables, but if the three are multiplied to get free space in bytes, you must use an INTEGER*4 variable to hold the result. If the value returned in the fourth argument of the call list (ICLUST) is equal to -1 (OFFF hexadecimal), an error condition has resulted.

A USEFUL MODEL

Many DOS functions, graphics, screen formatting, and resident modules cannot be handled through native FORTRAN code. By coding these functions in assembly language, you can extend the versatility of a program without forcing a complete rewrite in a different language. These sample routines can provide a useful model for creating your own extensions to FORTRAN. ■

Hot Tips

Turn to the Inmac catalog for helpful hints and problem solving advice from our engineers. And for over 2,400

computer supplies and accessories displayed and described in detail. All have our exclusive 45-day trial and minimum 1-year guarantee.



FREE!

Call or write today. Yes... rush me your catalog today.

800-547-5444

inmac™

Name _____
 Company _____
 Address _____
 City _____ State _____ Zip _____
 Phone () _____
 2465 Augustine Drive, Santa Clara, Ca. 95054

5052

Automatic Document Conversion.

WORDFORWORD™

by Mastersoft®, Inc.

Word For Word is the software document converter that converts files and documents from one PC-compatible word processing system to another.

Producing "mirror-image" conversions that preserve ALL features and functions, Word For Word can transmit documents over standard communication links between like or unlike word processing systems. It also allows uploading to or downloading from mini and main-frame computers in ASCII and EBCDIC formats.

Fast—converts a one-page document in five seconds.

Easy-to-use, menu driven operation.

For further information call (800) 654-5301 or (213) 493-2471 and ask about the availability of Microsoft Word™, Displaywrite III™, DCA and Wordstar 2000™.



Dealer Inquiries Invited

Marketing and Sales
by CSSL, Inc.
909 Electric Avenue, Suite 202
Seal Beach, CA 90740
(800) 654-5301 or (213) 493-2471

SPECIAL INTRODUCTORY OFFER — \$149.

WORDFORWORD™

c/o CSSL Inc.
909 Electric Avenue, Suite 202
Seal Beach, CA 90740

- YES, send me Word For Word for \$149.00. (Add \$5.00 for shipping and handling. Arizona residents add an additional \$9.98 for sales tax.)
- My check is enclosed. Or charge my
- VISA MasterCard Am.Ex.
- Card # _____
- Exp. _____
- Name _____
- Address _____
- City _____ State _____ ZIP _____
- Telephone (____) _____

The following are trademarks of their respective companies: WORD FOR WORD and Mastersoft: Mastersoft, Inc.; Wordstar and Wordstar 2000: Micropro International Corp.; Multimate: Ashton-Tate, Inc.; Displaywrite III and IBM Writing Assistant: International Business Machines Corp.; WordPerfect: Satellite Software, Inc.; Microsoft Word: Microsoft, Inc.; Volkswriter: Lifetree Software, Inc.; PFS: Write: Software Publishing Corp.

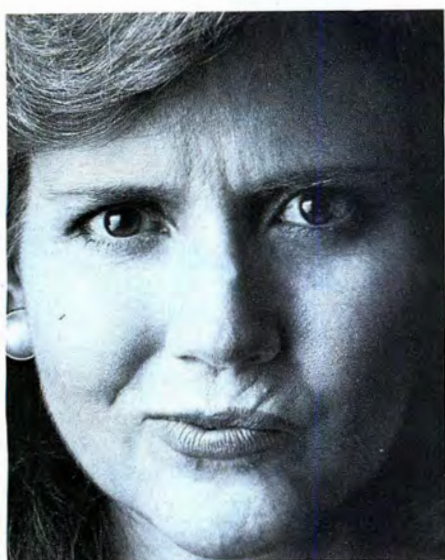

9:08: *"Hit any key. Where's the 'any' key?"*



9:47: *"So that's how you create a file."*



10:26: *"And they all laughed when I sat down at the computer."*

DataEase.

If it was hard to use we would have called it DataHard.

There are many jobs a database manager is perfect for. It can significantly reduce the hours people spend keeping records, filing and creating reports. The trouble is most database managers aren't perfect for the people who have to do those jobs. They're just too difficult for them to learn.

So a lot of people end up using a spreadsheet program to try to do the job of a database manager. A job the spreadsheet wasn't designed for and doesn't do very well.

That's why many companies that had already standardized on complex systems like dBASE™ have decided to re-standardize on DataEase.™

DataEase. No database manager that does as much is easier.

People become productive immediately with DataEase. Even people without any PC experience. In just a couple of hours they'll be setting up forms, files and reports by themselves. Because DataEase is menu driven and leads them through the process.

And DataEase is just as powerful as much more complex systems. But the power doesn't get in the way of a beginner using DataEase. Instead it becomes available as it's needed. So as they become

more experienced, the transition from building simple applications to building complex ones is seamless. And easy.

And even though DataEase is easy, we support it as if it weren't. We have customer support people to answer your questions. Seminars and user groups around the country to help you make more productive use of DataEase. And we offer free templates to help make developing applications even easier.

DataEase. What it can do is hard. How it does it is easy.

Send us the coupon for a free DataEase demonstration disk. Or call 1-800-334-**EASE**, or 203-374-8000.

Byte 10/15/86

Software Solutions, Inc.
12 Cambridge Drive, Trumbull, CT 06611
1-800-334-**EASE**

Please send me a free DataEase™ demonstration disk.
 Please have a Software Solutions representative call.

Name _____ Title _____
Company _____ Phone _____
Address _____
City _____ State _____ Zip _____

No. of PCs on site 1-50 51-250 251 +
 IBM PC/XT/AT IBM COMPATIBLES WANG DEC OTHER

DATAEASE™

FROM SOFTWARE SOLUTIONS, INC.

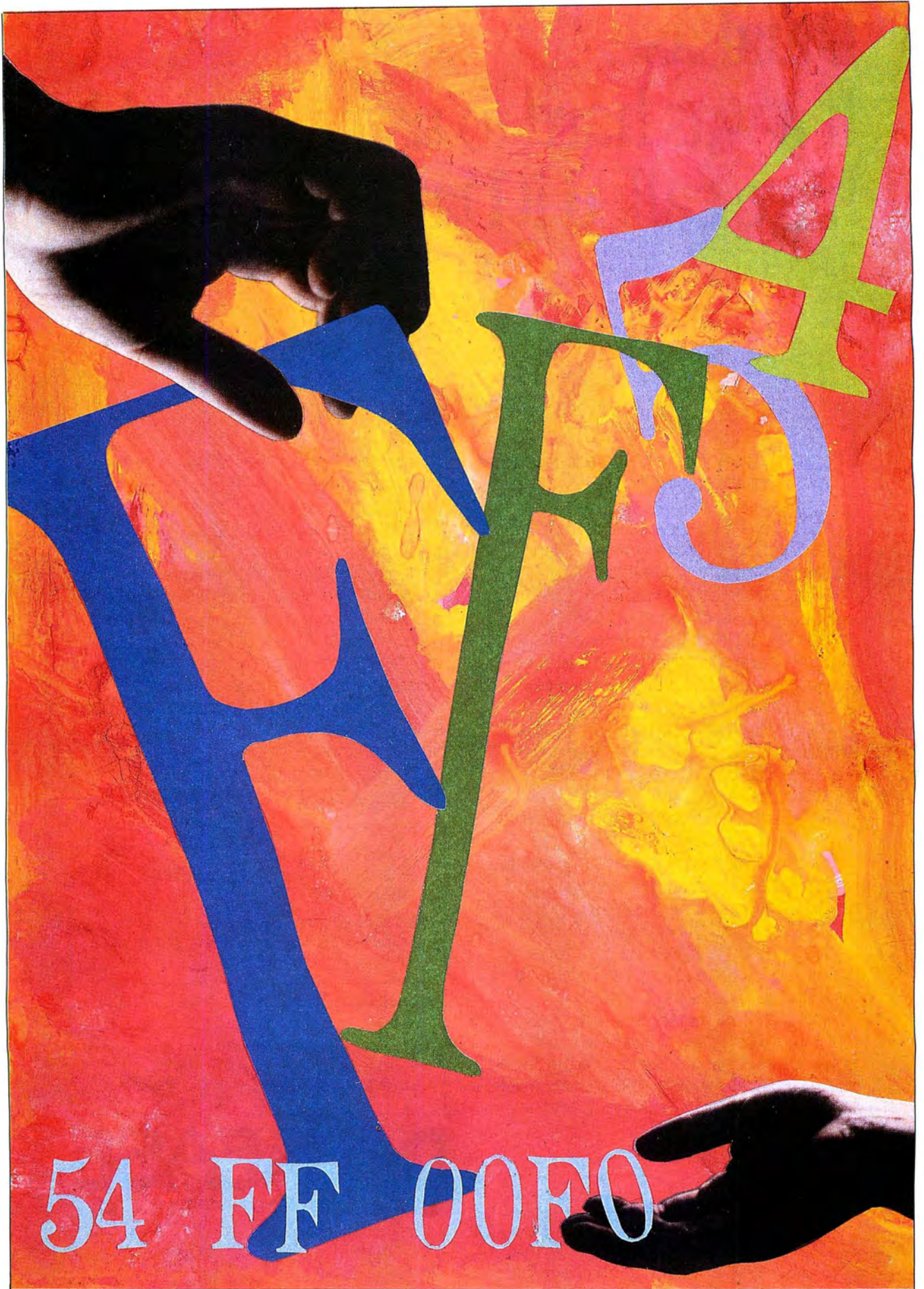

MEMORY MANIPULATIONS

PART 1: ARABIC VERSUS ROMAN

Making sense out of FATs and other reversed addresses

BY ALAN R. MILLER

Editor's note: Alan Miller explains two ways to manipulate the memory of the IBM PC. Part 1 clarifies the ordering of addresses. Part 2 discusses how to adjust the size of memory.

READING HEXADECIMAL numbers larger than one byte presents a problem that is rooted in the difference between the Arabic language, which is written from right to left and from which our numbers come, and the Roman language, which is written from left to right and from which our letters come. In our number systems—whether binary, hexadecimal, or decimal—the value of each digit position increases as you move from right to left, in the Arabic style. For example, in the decimal system, the tens are positioned to the left of the units, and the hundreds to the left of the tens.

Unfortunately, it has become the custom to display successive hexadecimal bytes in the Roman fashion, from left to right. Thus, although the 16-bit binary number 1010 1101 0101 0111 is equivalent to the hexadecimal number AD57, when this number is written as two bytes, the order is reversed to give 57 AD. Now the low byte, 57, is on the left, and the high byte, AD, is on the right. Notice the inconsistency of this form. The two characters of *each* byte are shown with the high nybble on the left and the low nybble on the right in Arabic style. However, successive bytes of the number are given with the low byte on the left and the high byte on the right in Roman style.

FINDING THE PORT ADDRESSES

You can observe the reversed display on the IBM PC by using the DOS pro-

gram DEBUG. Execute DEBUG by typing its name and then pressing the Return key. When you see the minus-sign prompt, display two lines in hexadecimal notation by entering the command D0:400L20, then press the Return key. You should see something like the display in figure 1, corresponding to the first 32 bytes of the BIOS data area. The first symbols give the beginning address of 400 hexadecimal that was requested.

The first item at address 400 is the 16-bit address of the serial port. The two bytes are shown as F8 03. However, you need to reverse these two bytes to find the real address of the serial port, which is 3F8 hexadecimal. Similarly, the addresses of the two parallel ports start at address 408. After you reverse the byte pairs, the values BC 03 78 03 give the port addresses 3BC and 378. While this might seem confusing, the comforting rule is that the higher, and therefore more significant, half of the address resides higher in memory than the lower half.

Consider the next line at address 413. The two bytes at this location give the maximum amount of available RAM in K bytes. The reversed bytes 80 and 02 become 280 hexadecimal or 640K bytes.

THE INTERRUPT VECTORS

The first 1024 bytes of IBM PC memory (0 to 400 hexadecimal) contain 256 four-byte addresses that point to subroutines or data located somewhere in memory. These addresses are numbered from 0 through FF hexadecimal and are known as interrupt vectors. The hardware directly accesses some of these vectors. For

example, when you type information at the keyboard, an electrical signal interrupts the microprocessor and directs it to the address given at 24^h hexadecimal, which is for interrupt 9. The address there points to a keyboard-service routine in the ROM BIOS near the top of memory. After the keyboard routine completes its work, it returns control to the interrupted program.

If you use DEBUG to look at the first 12 interrupt vectors by giving the command D0:0L30, you will see something similar to figure 2. Each group of four bytes represents one interrupt vector. For example, interrupt 5 activates the PrtSc routine. When you hold down the Shift key and press the PrtSc key, the microprocessor branches to the address given at location 14 hexadecimal. The data there is shown as 54 FF 00 F0, which after reversal represents the address F000:FF54. Again, the display is inconsistent. The two characters in each byte have the higher half on the left and the lower half on the right in Arabic fashion. However, successive bytes are arranged with the higher bytes on the right and the lower bytes on the left in Roman fashion. Notice

(continued)

Alan R. Miller is a BYTE contributing editor and the author of *Assembly Language Techniques for the IBM PC* (Sybex, 1986). These two articles are adaptations of information from that book. Alan is a professor at New Mexico Institute of Mining and Technology (Metallurgy Department, Socorro, NM 87801), where he has taught materials science, thermodynamics, electrical engineering, and programming methods. He holds a Ph.D. in engineering from the University of California at Berkeley.

that if the display's second line were in reverse order (i.e., in Arabic fashion), you would see the contents of figure 3a. Then you could more

easily read the four interrupt vectors shown in figure 3b. The address for interrupt 5 is now the second one from the right.

```
0000:0400 F8 03 F8 02 00 00 00 00-BC 03 78 03 00 00 00 00
0000:0410 7F 82 00 80 02 40 02 00-00 00 32 00 32 00 64 20
```

Figure 1: An example of DEBUG's display of the first 32 bytes of the BIOS data area.

```
0000:0000 E8 4E 2E 01 F0 01 70 00-C3 E2 00 F0 F0 01 70 00
0000:0010 F0 01 70 00 54 FF 00 F0-47 FF 00 F0 47 FF 00 F0
0000:0020 DF 01 6F 0B 2F 01 4A 10-DD E6 00 F0 DD E6 00 F0
```

Figure 2: An example of DEBUG's display of the first 12 interrupt vectors.

```
F0 00 FF 47 F0 00 FF 47-F0 00 FF 54 00 70 01 F0 0000:0010
```

Figure 3a: The second line of figure 2 shown in reverse order (i.e., in Arabic fashion).

```
F000:FF47 F000:FF47-F000:FF54 0070:01F0
```

Figure 3b: The four interrupt vectors described in figure 3a.

```
xxxx:0170 C0 04 4D E0 04 4F 00 05-51 20 05 53 40 05 55 60
```

Figure 4a: An example of DEBUG's display of the FAT. (The xxxx value is unimportant.)

```
4C 4D 4E 4F 50 51 52 53 54 55
```

Figure 4b: The actual FAT numbers shown in figure 4a.

```
60 55 05 40 53 05 20 51-05 00 4F 04 E0 4D 04 C0
```

Figure 4c: The FAT display from figure 4a shown backward.

```
6 0 55 0 54 0 53 0 52 0 51-0 50 0 4F 0 4E 0 4D 0 4C 0
```

Figure 4d: The display in figure 4c with the nybbles split. Note that the FAT for a floppy disk uses three nybbles per entry.

THE FILE ALLOCATION TABLE

A more serious problem occurs with the file allocation table (FAT), a set of numbers that shows where each part of a file is located on the disk. Floppy disks and hard disks smaller than 20 megabytes use a 12-bit FAT, while larger disks use a 16-bit FAT. (A 20-megabyte hard disk uses a 12-bit FAT with DOS 2.x and a 16-bit FAT with DOS 3.x.) You can inspect the FAT for the floppy disk in drive A by giving the DEBUG command LDS:100 0 1 2. The first parameter to the load command is the offset address in memory where the FAT will be loaded (100 hexadecimal). The next parameter, 0, requests drive A; 1 is starting sector number, and 2 is the number of sectors.

After the FAT is loaded, you can examine it with the command D170L10. You will see something like the contents of figure 4a. Although it is not readily apparent, the FAT numbers in figure 4a are those in figure 4b. It is more obvious if you display the line backward (figure 4c) and then split the nybbles (figure 4d). Remember, the FAT for a floppy disk uses 12 bits, or three nybbles, per entry. When read from right to left (Arabic style), the bytes appear as in figure 4b.

Several authors have criticized the FAT's backward design. However, the design is correct; the problem lies in mixing Arabic and Roman notation. We have accepted the system of Arabic numerals, which is backward to us, without question. However, we insist on displaying successive bytes in Roman fashion from left to right. In this way, we scramble 12-bit, 16-bit, and 32-bit numbers in our displays.

Microsoft compromises by reversing the 16-bit addresses but then runs the bytes together to indicate that they are reversed. Consider a typical assembly listing that shows

```
E9 02DC JMP done
```

The value E9 hexadecimal is the 8088 code for JMP, and the number 02DC hexadecimal is the relative distance to be jumped. However, if you look at a hexadecimal display of this instruction, you would see E9 DC 02. The DC

(continued)

AMERICA'S NEXT FAVORITE MOUSE.

The best price: \$99

NEW Reflex & LOGICADD Packages!



THE BEST HARDWARE:

- PC/XT/AT compatible through your serial port
- NO pad. NO power supply
- High (200 DPI) resolution
- Tactile feedback switches

THE BEST SOFTWARE:

LOGIMOUSE with Plus Package Software \$119

LOGIMOUSE® C7

- Driver 3.0: makes LOGIMOUSE run with all mouse based software, including Microsoft.
- LOGIMENU: a programmable Pop-Up Menu System that customizes LOGIMOUSE for each of your keyboard based applications.
- CLICK: a new concept in mouse software! It resides in memory, detects what application you're running and automatically sets the mouse to your predefined setting.
- POINT-AND-CLICK SHELL for Lotus 1-2-3: the only mouse interface for 1-2-3 that goes beyond keyboard emulation. With context sensitive pop-up menus and an independent mouse cursor that changes shape and meaning in different areas of the 1-2-3 screen. Makes it faster and easier to select a cell, invoke a command or scroll.
- POINT EDITOR: a mouse based program editor featuring pop-up menus and overlapping, color windows for faster, easier file editing. Use it instead of EDLIN or any other ASCII file editor.

THE BEST DEALS:

NEW! Introductory Price!
LOGIMOUSE with Plus Pkg. & Reflex ~~\$268~~ \$199
 A winning combination! LOGIMOUSE enhances the power of Reflex. Borland's amazing database management system, to probe relationships in your data and display them in graphic form.

NEW! Introductory Price!
LOGICADD-LOGIMOUSE with Plus Pkg. & Generic CADD 2.0 with Dot Plot ~~\$244~~ \$189
 Everything you need to turn your PC into a CAD workstation. Generic CADD has the features and performance of high-priced CAD. DotPlot turns your dot matrix printer into a plotter, and LOGIMOUSE is the ultimate input device.

LOGIPAINT SET—LOGIMOUSE

with Plus Pkg. & PC Paintbrush 3.0 ~~\$258~~ \$169
 LOGIMOUSE plus PC Paintbrush 3.0 is the most advanced paint set available for the PC. Use it for designing a logo or painting a picture. You won't believe its power with either freehand drawing or graphics!

To place a credit card order call our special toll-free number:
800-231-7717

Call toll-free in California:
800-552-8885

YES! I want America's next favorite mouse!

- Please send me:
- | | | |
|---|-------|---|
| <input type="checkbox"/> LOGIMOUSE with Driver 3.0 | \$ 99 | 30-Day Money-Back Guarantee/ New 3-Year Warranty |
| <input type="checkbox"/> LOGIMOUSE with Plus Software | \$119 | |
| <input type="checkbox"/> Plus Package Software | \$ 29 | |
| <input type="checkbox"/> LOGIMOUSE with Reflex | \$199 | <small>Add \$6.50 for shipping & handling. Calif. residents add applicable sales tax.</small> |
| <input type="checkbox"/> LOGICADD | \$189 | |
| <input type="checkbox"/> LOGIPAINT | \$169 | |

For your computer model: _____

VISA MASTERCARD CHECK ENCLOSED

Card Number _____ Expiration Date _____

SIGNATURE _____

NAME _____

ADDRESS _____

CITY, STATE _____

ZIP _____ PHONE _____

DEALER INQUIRIES WELCOME

LOGITECH

United States:
 LOGITECH, Inc.
 805 Veterans Blvd.
 Redwood City, CA 94063
 Tel: 415-365-9852

In Europe:
 LOGITECH SA
 CH-1143 Apples
 Switzerland
 Tel: 41-21-774545

LOGIMOUSE is a registered trademark of LOGITECH. Lotus and 1-2-3 are trademarks of Lotus Development Corp. Reflex is a trademark of Borland-Analytica. Generic CADD is a trademark of Generic Software, Inc.

Listing 1: ADUMP.ASM, a program designed to display bytes in Arabic fashion from right to left. (Note that this is written to be executed in a .COM file.)

```

PAGE      ,132
TITLE     ADUMP

COMMENT *
  Display a portion of memory in hex and ASCII
  Successive hex bytes are reversed in Arabic fashion
  Usage:
    ADUMP
    ADUMP 400      ;offset
    ADUMP 5300 0   ;segment, offset
  Macros: @d_char, @ucase, @write_r
  INT 21h function 8
*
      IF1
      INCLUDE mymac.lib
      ENDIF

blank EQU 32
cr    EQU 13
esc   EQU 1Bh
lf    EQU 10
period EQU 46
up_arr EQU 72      ;up cursor
down_ar EQU 80     ;down cursor
pg_up  EQU 73      ;previous screen
pg_dn  EQU 81      ;next screen

code SEGMENT
ASSUME CS:code, DS:code
ORG 5Dh
param1 DB ?        ;parameter 1
ORG 6Dh
param2 DB ?        ;parameter 2
ORG 100h

strt:
  @write_r <OFFSET mes1>
; set segment and offset to zero
  XOR SI,SI        ;zero offset
  MOV ES,SI        ;segment
; check if parameter was entered
  MOV DI,OFFSET param1
  CMP BYTE PTR [DI],blank ;anything?
  JZ t_lines
; convert parameter from ASCII hex to binary in SI
  CALL get_hex
  MOV SI,DX
; check if second parameter was entered
  MOV DI,OFFSET param2
  CMP BYTE PTR [DI],blank ;anything?
  JZ t_lines
  MOV ES,SI
; convert parameter from ASCII hex to binary in SI
  CALL get_hex
  MOV SI,DX
;-----
; start display of 16 lines
; ES has segment, SI has offset
;-----
t_lines:
  @write_r <OFFSET mes2>
  MOV CX,21        ;lines

```

(continued)

byte is located between the E9 and 02 bytes. This would be much clearer if we displayed the data with the order of the bytes reversed, as in

```
02 DC E9 JMP done
```

or

```
JMP done 02 DC E9
```

AN ARABIC DISPLAY

The assembly language program ADUMP.ASM (listing 1) is designed to make your hexadecimal displays easier to read by giving the bytes in Arabic fashion from right to left. To run ADUMP.ASM, you need the macros given in MYMAC.LIB (listing 2); notice that the macro names begin with @. (If you don't have a macro assembler, you must put the corresponding code at each place in the program. But then be careful to change the dummy variables and to remove the INCLUDE directive near the beginning. ADUMP.ASM is described in my book *Assembly Language Techniques for the IBM PC*, Sybex, 1986.) [Editor's note: ADUMP.ASM and MYMAC.LIB are available on disk, in print, and on BIX. See the insert card following page 176 for details. Listings are also available on BYTEnet. See page 4.]

After you assemble ADUMP.ASM, if you execute it without parameters, you will see a listing similar to the one in table 1. The display begins at address 0, and so it includes the BIOS interrupt vectors. For example, the PrtSc vector at address 14 hexadecimal can now be clearly seen as F0 00 FF 54 or F000:FF54.

You can press the down arrow key to see the next line or the PgDn key to see the next page. To view another area of memory, execute this program with one or two parameters. If you provide only one parameter, the display begins at that hexadecimal offset from the beginning of memory. For example, to see the BIOS data area, you use the parameter 400. If you provide two parameters, the first is the segment address and the second is the offset within that segment.

ADUMP.ASM contains routines for

(continued)

Business Tools Introduces Reality Pricing.®

- ✓ Relational Database
- ✓ 4th Generation Language
- ✓ Screen Painter
- ✓ Program Generator
- ✓ Report Writer
- ✓ Source Code Editor
- ✓ Runtime Compiler



**Reality Pricing means
real features +
real savings.**

TAS-Plus just made it faster, easier and cheaper to build database applications. TAS-Plus combines the power of a Relational Database with the ease of a Program Generator. Then TAS-Plus adds a Runtime Compiler to produce lightning-fast finished code.

Look at what TAS-Plus gives you:

- Relational Database**
- 4th Generation Language**
- Screen Painter**
- Program Generator**
- Report Writer**
- Source Code Editor**
- Runtime Compiler**

TAS-Plus gives you power where it counts. You can store up to 65,000 records, open up to 16 files at a time and enter up to 10,000 characters per record. TAS-Plus even reads your old DBase files.

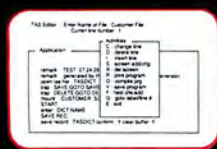

**TAS-Plus
writes the
program
for you**

With TAS-Plus, you can start building professional database applications on day one. Just "paint" the screen the way you want and TAS-Plus writes the program for you. You can even paint

using different colors or graphic characters. And custom reports are just as easy.

TAS-Plus has over 86 commands and 200 options available in its Source Code Editor, so you won't run out of room to grow.

Easy to use features

Add new databases quickly and easily. Add, change or delete records without any programming at all. Browse through your database and see multiple records on the screen at the same time.

Restructure capability allows you to change existing databases without loss of any data.

All this for just \$69

TAS-Plus would be respectable at any price, at \$69 it's awesome.

30 day Money Back Deal

TAS-Plus comes with a 30 day money back guarantee (less \$15 handling fee). TAS-Plus is available for the IBM PC/XT/AT and fully compatible computers. TAS-Plus Accounting applications available.

**Order Today
1-800-648-6258**

Call our Toll-Free Hotline. Use your VISA, MasterCard or American Express to order today. For information or Washington residents call 1-206-644-2015.

TAS+™

NOT COPY-PROTECTED

YES! Rush me the following items.

Qty.	Item	Price	Subtotal
_____	TAS+	\$69	_____
_____	Shipping add \$8 USA, \$25 outside USA	Shipping	_____
_____	WA res add \$5.59 Tax	Tax	_____
_____	Amount Enclosed (US funds only)		_____

Name: _____

Shipping Address: _____

City: _____

State: _____ Zip: _____

Telephone: _____

Payment: VISA MC AMX Check

Credit Card Expiration Date: _____

Card Number: _____

Name on Card: _____



4038-B 128th Ave. S.E., Suite 266
Bellevue, Washington 98006
(206) 644-2015



The following are registered trademarks of these companies: TAS-Plus, The Accounting Solution, Business Tools, Inc.; IBM PC/XT/AT, International Business Machines Corp;

© Copyright 1986 Business Tools, Inc.

One fast solution to disk format problems

Diskmaker® translates disks quickly.

If you work with many different computers and disk formats, one Diskmaker® will pay for itself by rapidly converting hundreds of different formats.

Diskmaker® transfers are fast, disk-to-disk; no modems or other special software necessary. Does not tie-up expensive computer systems to convert disks.

Diskmaker® handles all common disk sizes: 8", 5¼" and 3½". Transfers can be made among PC DOS, MSDOS, CP/M, UNIX, word processing and phototypesetting systems.

Ongoing support features several software updates each year to stay abreast of new systems as they are introduced.

Diskmaker® comes complete with drives, software and extensive manual (requires only monitor and keyboard). Six months warranty.

For more information, write:
 New Generation Systems, Inc.,
 9510A Lee Highway, Fairfax, VA 22031.
 Telex 750417 NEW GEN SYS. Or call:
(703) 471-5598

DISKMAKER®



```

n_line:
    @d_char cr
    @d_char lf
; display address and 16 hex bytes
    CALL do_hex
; display ASCII
    CALL do_ascii
    ADD SI,16 ;next line
    LOOP n_line
; wait for keyboard input
    CALL get_in
    CMP AL,esc ;quit?
    JZ done ;yes
    CMP AL,cr ;next page?
    JNZ not_cr ;no
    JMP t_lines

not_cr:
    CMP AL,pg_dn
    JNZ not_pd
    JMP t_lines ;next page

not_pd:
    CMP AL,up_arr
    JNZ not_uu ;prev line
; back up pointer one line and redisplay
    SUB SI,22*16
    JMP t_lines

not_uu:
    CMP AL,pg_up
    JNZ not_tl ;prev page
; back up pointer one page and redisplay
    SUB SI,42*16
    JMP t_lines

not_tl:
    MOV CX,1
    CMP AL,blank
    JZ n_line ;next line
    CMP AL,down_ar
    JZ n_line ;next line

done:
    INT 20h
; translation table binary to ASCII hex
hex_tab DB '0123456789ABCDEF'
;*****
; Convert binary number in AL to hex and
; and display on screen
; Input: AL = byte
;*****
outhex PROC
    PUSH DX
    MOV DL,AL ;save
    REPT 4 ;times 16
    SHR AL,1
    ENDM
    CALL outhx ;high half
    MOV AL,DL ;get back
    CALL outhx ;low half
    MOV AL,DL ;restore
    POP DX
    RET
outhex ENDP
;***** End outhex *****
;*****
; convert four bits in AL to hex and
; display on screen
;*****
    
```

MEMORY MANIPULATIONS

```

outhx PROC
AND     AL,0Fh           ;low 4 bits
PUSH    BX
MOV     BX,OFFSET hex_tab
XLAT   hex_tab
@_d_char AL              ;display
POP     BX
RET
outhx ENDP
;***** End outhx *****
;*****
; Convert ASCII hex to binary
; Input:      DI points to string
; Output:     DX = binary value
;*****
get_hex PROC
PUSH    AX
XOR     AX,AX           ;zero
MOV     DX,AX           ;DX too
g_hex2:
MOV     AL,[DI]
SUB     AL,'0'          ;make binary
JL     g_hex_b         ;too low
CMP     AL,10
JL     g_hex_g         ;ok
@ucase ;make upper
SUB     AL,'A'-'9'-1   ;adjust for A-F
JL     g_hex_b         ;too low
CMP     AL,15
JG     g_hex_b         ;too large
; add new character to sum
g_hex_g:
REPT    4
SHL     DX,1
ENDM
ADD     DX,AX
INC     DI
JMP     g_hex2         ;next char
; end of string
g_hex_b:
POP     AX
RET
get_hex ENDP
;***** End of get_hex *****
;*****
; display address and 16 hex bytes
; Input:      SI = pointer
; Output:     SI is 16 larger
;*****
do_hex PROC
MOV     DI,SI
ADD     DI,16
PUSH    CX
MOV     CX,16          ;one line
next_ch:
DEC     DI              ;next
MOV     AL,ES:[DI]
CALL   outhx
PUSH    BX
MOV     BL,blank
; put a minus sign at quarter points
MOV     AX,DI
AND     AL,0Fh
JZ     not_min         ;line end
AND     AL,3
    
```

(continued)

LePrint™
 and graphics
 Typesetting for your
 laser and dot-matrix
 printers

*Now Supports
 Graphics!*

Now you can combine
 LePrint's high-quality
 letterforms with photos,
 charts and logos.
 Design your own
 professional-looking
 documents and enter
 the world of
desktop publishing.

EEEEEEEEEEEEEEEE



"Picture yourself using LePrint..."

For further information
 Call Toll-Free

800-LEBAUGH

(800-532-2844)

In Nebraska 402-733-7600

Telex 5106005837 LEBAUGH SC

LeBaugh Software Corporation
 2720 Greene Avenue
 Omaha, Nebraska 68147

*This entire ad was printed
 exactly as you see it by LePrint.*

picoware™

Introducing...

G-Spell

90,000-word
Spelling Checker

for the IBM PC and compatibles

Only
\$9.95

At last! Here is a spelling checker for everyone! Now you can let your computer proofread those important reports. Your letters, proposals, and school work can all be letter perfect! And it's fast, easy, and inexpensive with G-SPELL.

FEATURES

- G-SPELL uses a 90,000-word dictionary to proof any ASCII file.
- You can set up your own personal, customized dictionaries.
- Misspelled words are displayed for in-context editing.
- Optionally write the list of misspelled words to a disk file.
- G-SPELL can make intelligent guesses at correct spellings for misspelled words. Guesses can be accepted into your text without retyping.
- G-SPELL is not copy protected.
- Only 128K of memory is required, yet all available RAM can be used to proofread very large files.
- Runs on the IBM PC, XT, AT, and 100% compatibles. Requires PC-DOS 2.00 or higher.
- Site licenses and quantity discounts are available.

30-day money-back guarantee!



Order today!



319-362-6964

Or mail orders to:

Pico Publishing
512 Paramount Bldg.
305 2nd Street S.E.
Cedar Rapids, IA 52401

Please add \$2.00 shipping and handling.
Iowa residents add 4% sales tax.

MEMORY MANIPULATIONS

```

        JNZ     not_min
        MOV     BL, '-'           ;minus
not_min:
        @_char BL
        POP     BX
        LOOP   next_ch
        POP     CX
        @_char blank
; display address at right side
        PUSH   BX
; display segment address
        MOV    BX,ES
        MOV    AL,BH
        CALL   outhex           ;high half
        MOV    AL,BL
        CALL   outhex           ;low half
        @_char ':'               ;colon
; display offset address
        MOV    BX,SI           ;offset
        MOV    AL,BH
        CALL   outhex           ;high half
        MOV    AL,BL
        POP    BX
        CALL   outhex           ;low half
        RET
do_hex  ENDP
;***** End of do_hex *****
;*****
; display 16 ASCII bytes
; control characters shown as period
; extended character translated to ASCII
;
; Input:      SI = pointer
;*****
do_ascii PROC
        @_char blank
        @_char blank
        MOV    DI,SI
        PUSH  CX
        MOV    CX,16           ;one line
next_as:
        MOV    AL,ES:[DI]
        AND    AL,7Fh          ;make ASCII
        CMP    AL,7Fh          ;DEL?
        JZ     d_per           ;yes
        CMP    AL,blank        ;too small?
        JNB    nbl
d_per:
; change to period
        MOV    AL,period
nbl:
        @_char AL
        INC    DI               ;next
        LOOP  next_as
        POP    CX
        RET
do_ascii ENDP
;***** End of do_ascii *****
;*****
; wait for character from keyboard
; don't echo on screen
; if extended code, two calls are made
;
; Output:     AL = character
;*****

```



your career to develop!

If microcomputing is your business, *BYTE has to be* your technology source. Make a career move now. Join your peers on the leading edge of microcomputer technology. Subscribe to *BYTE* at our low introductory half price offer:

Save 50% off the newsstand price—12 issues at \$21 instead of \$42. If you're not satisfied write "cancel" on your invoice and keep the first issue free.

- U.S. \$21.00 (1 yr.) Canada/Mexico \$23.00 U.S. (1 yr.) Europe-Air Delivery \$69.00 U.S. (1 yr.) Worldwide-Surface Delivery \$37.00 U.S. (1 yr.)

- Bill me (North America only)
 Payment enclosed (U.S. Funds drawn on a U.S. bank only)
 Charge to my VISA MasterCard
Card # _____ Expires _____
Signature _____

Name _____

Address _____

City/State _____

Country _____ Code _____

Please allow 6-8 weeks for processing your subscription

46SASX

**For direct ordering call toll free weekdays
8:30am-4:30pm E.S.T. : 800-258-5485.**

BYTE
THE SMALL SYSTEMS JOURNAL





NO POSTAGE
NECESSARY
IF MAILED
IN THE
UNITED STATES

BUSINESS REPLY MAIL

FIRST CLASS MAIL PERMIT NO. 39 MARTINSVILLE, NJ

POSTAGE WILL BE PAID BY ADDRESSEE

BYTE Subscriptions
PO Box 597
Martinsville, NJ 08836-9956



MEMORY MANIPULATIONS

```

get_in PROC
    MOV     AH,8
    INT     21h
    OR      AL,AL           ;zero?
    JNZ     get_2          ;no
; get extended code
    INT     21h

get_2:
    RET
get_in ENDP
;***** End of get_in *****
mes1 DB ' Arabic display--Hex goes from'
      DB ' right to left',cr,lf
      DB ' Active keys are: down and up'
      DB ' arrows, PgDn, PgUp, and Esc$'
mes2 DB cr,lf,lf,' F E D C B A 9 8 '
      DB ' 7 6 5 4 3 2 1 0 SEGM'
      DB ' ADDR 0123456789ABCDEF$'

code ENDS
      END      strt
    
```

Table 1: Arabic display of BIOS interrupt vectors. If you execute the ADUMP program without parameters, you will see an output listing similar to this.

Arabic display—Hex goes from right to left
Active keys are: down and up arrows, PgDn, PgUp, and Esc

F	E	D	C	B	A	9	8	7	6	5	4	3	2	1	0	SEGM	ADDR
00	70	01	F0-F0	00	E2	C3-00	70	01	F0-01	2E	4E	E8	0000:0000				
F0	00	FF	47-F0	00	FF	F0-F0	00	FF	54-00	70	01	F0	0000:0010				
F0	00	E6	DD-F0	00	E6	DD-10	4A	01	2F-0B	6F	01	DF	0000:0020				
00	70	01	F0-F0	00	EF	57-C8	00	08	49-F0	00	E6	DD	0000:0030				
00	70	09	AB-F0	00	F8	41-F0	00	F8	4D-F0	00	F0	65	0000:0040				
0B	6F	01	64-F0	00	E8	2E-F0	00	F8	59-F0	00	E7	39	0000:0050				
00	70	01	EA-F0	00	FE	6E-00	70	0A	DD-F6	00	00	00	0000:0060				
F0	00	00	00-00	00	05	22-F0	00	F0	A4-F0	00	FF	53	0000:0070				
0A	9A	01	3C-0A	9A	01	2F-10	67	03	5C-01	2E	12	C3	0000:0080				

Listing 2: MYMAC.LIB, a macro-definition library.

```

@d_char MACRO par?
;; display par? on video screen
;; Usage: @d_char AL ;;from register
;; @d_char '*' ;;constant
    PUSH    DX
    MOV     DL,par?
    MOV     AH,2
    INT     21h
    POP     DX
ENDM

@ucase MACRO
LOCAL notup?
;; Macro to change AL to upper case
;; Usage: @ucase
    CMP     AL,'a' ;;uppercase?
    JB     notup? ;;yes
    AND     AL,5Fh ;;make upper

notup?:
ENDM
    
```

(continued)

P.C. Computer Brokers Inc.

The Place To Buy Your Epson Printers



LX-86
\$239⁰⁰ List \$349⁰⁰

FREE Stand With Purchase of any Epson Printer at PC.

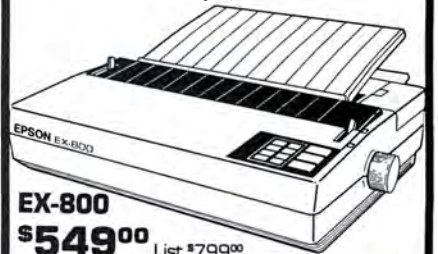

EX-800
\$549⁰⁰ List \$799⁰⁰

FX-85	\$549 ⁰⁰	\$349⁰⁰
420I	\$1995 ⁰⁰	CALL
FX-286	\$799 ⁰⁰	\$489⁰⁰
LQ-800	\$799 ⁰⁰	\$529⁰⁰
LQ-1000	\$1095 ⁰⁰	\$749⁰⁰

Close-Out Specials—While They Last—Close-Out Prices

AP-80 ..	\$275⁰⁰	DX-10 ..	\$225⁰⁰
DX-35 ..	\$650⁰⁰	HW-10 ..	\$175⁰⁰
RX-100 ..	\$325⁰⁰		

Call For Prices On: DX-20, HI-80, LX-80, HS-80, LQ-1500, RX-80, SQ-2000

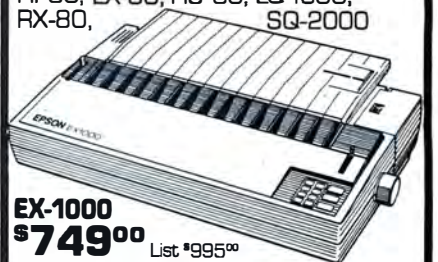

EX-1000
\$749⁰⁰ List \$995⁰⁰

Call Toll FREE **1-800-245-4122**

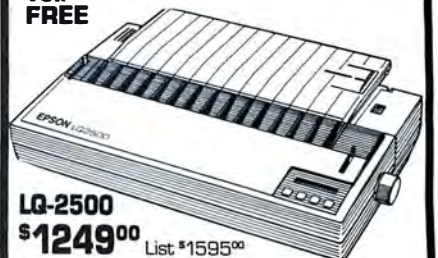

LQ-2500
\$1249⁰⁰ List \$1595⁰⁰

Prices Subject to Change Without Notice



Add 2.9% For Use of Visa, M/C & Choice.

These Prices Are Good For Mail Order Dept. Only

P.C. Computer Brokers Inc.
3879 East 120th Ave.
Thornton, CO 80233
(303)450-6727

Call Toll FREE **1-800-245-4122**

```

@write MACRO text?
LOCAL around,mesg
;; Macro to embed version number
;; Usage: @write 'title, date'
PUSH DX
PUSH AX
MOV AH,9 ;;write string
MOV DX,OFFSET mesg
INT 21h
POP AX
POP DX
JMP SHORT around

mesg DB text?,'$'
around: ;;write
ENDM

@write_r MACRO addr?
;; display text at location addr?
;; text must end with $
;; Usage: @write_r <OFFSET p_ver>

PUSH DX
MOV DX,addr?
MOV AH,9
INT 21h
POP DX
ENDM
    
```

converting binary to hexadecimal and hexadecimal to binary. The binary-to-hexadecimal routine uses the 8088 XLAT instruction and a simple table of hexadecimal values for the conversion.

You can back the display up one line by pressing the up arrow key and back it up one page by pressing PgUp. Unfortunately, these operations refresh the entire screen, so they are time-consuming. It would be faster if the information were written directly to the video screen; then the screen would be instantly updated. This technique is also described in my book.

FINALLY

There is considerable confusion between Arabic and Roman styles in reading hexadecimal addresses. However, with the help of ADUMP.ASM or a similar program, you can make such addresses more logically readable.

Meet The New Chairman Of The Board.

DEVELOPED WITH PC MAGAZINE

Chairman™ is the first true multiuser bulletin board software. Now up to six users can access your bulletin board simultaneously.

Are you tired of using expensive online services as your company's message center? **Chairman** can handle all your electronic mail needs at a fraction of the cost, and with a higher level of security.

Do you service your customers' software? Use **Chairman** to send new software versions to all current users. **Chairman** can also become a clearinghouse for programs and data files. You can upload or download both binary and ASCII files.



Do you have trouble getting customers to fill out questionnaires? With **Chairman**, you can conduct fast, effortless electronic surveys. Use the built-in editor to create a list of questions. **Chairman** will record user responses for your instant analysis.

We developed **Chairman** initially to work on PC Magazine's extremely busy and demanding Interactive Reader Service. **Chairman** is written in DMA's powerful ASCOM IV script language—

and we include the actual source code, to make customization for your particular needs a snap.

Are you ready to revolutionize your electronic communications? Start at the top—with **Chairman**.

For more information, contact DMA the leaders in communications software.



DYNAMIC MICROPROCESSOR ASSOCIATES,
545 FIFTH AVENUE, NEW YORK, NY 10017
(212) 687-7115

WE SPEAK YOUR LANGUAGE®

PART 2: ADJUSTING MEMORY SIZE

Making it smaller—or larger

IT IS POSSIBLE to decrease or increase the amount of memory available for program execution on the IBM PC. Everyone can find reasons for increasing memory, but there are also reasons why you might want to decrease it.

REDUCING THE MEMORY SIZE

Although the IBM PC can, in principle, address about 1 megabyte of memory, DOS versions 2.x and 3.x are limited to a maximum of 640K bytes for program execution. Many programs can use all 640K bytes. However, while several commercial programs won't operate with this much memory, they will run correctly with less, usually 512K bytes or fewer. Furthermore, if you attempt to run one of these programs with the full 640K bytes, you will get the confusing error message "Insufficient memory." You can solve this problem by reducing the effective memory size of your PC temporarily while you run these programs.

One way to reduce memory size is to install a RAM disk. However, if you have a PC AT, it would be better to install a RAM disk in addition to the regular 1 megabyte of memory using a board such as the AST Advantage. Then you can still have 640K bytes of RAM for program execution.

You can also reduce the memory size by creating a resident program. When a program begins execution, DOS gives it all the remaining RAM. If that program terminates normally through interrupt 20h or function 4Ch of interrupt 21h, DOS recovers the allocated RAM for the next program's



use. However, if a program terminates with DOS interrupt 27h, DOS reserves a portion of memory, and the effective memory available for the next program is reduced accordingly. This technique is commonly utilized for installing device drivers such as a print spooler or a RAM disk program.

The program in listing 3, `FILL.ASM`, allocates a 64K-byte block of memory; it does not execute any code in this space. You also need the macro library, `MYMAC.LIB` (see listing 2 in "Arabic versus Roman" on page 241), since the program uses the macro `@write`. [Editor's note: `FILL.ASM`, `MYMAC.LIB`, and `MEM704.ASM` are available in a variety of formats. See the insert card following page 176 for details.] If you have 640K bytes of memory available, you might occasionally need to run this program.

You can run the DOS `CHKDSK.COM` program to determine the amount of

available memory. For example, if you have 640K bytes, you will see a display such as

```
655360 bytes total
memory
618464 bytes free
```

If you assemble and execute `FILL.ASM`, you will see the expression "Memory reduced 64K bytes" on the screen. You should run the `CHKDSK.COM` program again to verify that the memory has been reduced:

```
655360 bytes total
memory
552912 bytes free
```

`FILL.ASM` begins with assembler directives and comments; the `INCLUDE` directive tells the assembler

to look in the library you created, `MYMAC.LIB`, for the macros. Since `FILL.ASM` assembles into a `.COM` file, you set the instruction pointer to 100 hexadecimal with the `ORG` statement. The executable instructions begin with the `@write` macro, which displays the "Memory reduced . . ." message.

The program contains only two more microprocessor instructions: `MOV` and `INT`. `MOV` places the resident code length in the `DX` register; `INT` terminates the program with DOS interrupt 27h, leaving 64K bytes resident. The assembler calculates the resident length by using the labels `pg_len` and `strt`.

INCREASING THE MEMORY TO 704K BYTES

The maximum amount of RAM that DOS can normally use is 640K bytes, ending with segment 9000 hexadecimal. Since the video-screen memory

(continued)

begins at segment B000, an unused 64K-byte block of memory is at segment A000. The program MEM704.ASM (listing 4) lets you expand DOS into this segment so that 704K bytes are available to your programs. Of course, you can't use this program unless you have memory in segment A000. Therefore, you might need to add another memory board. Some memory boards, such as the AST SixPak, can't be addressed in this region, while others, like the IBM 64/256 board, can. After adding the new memory and addressing it to the A000 segment, you must run MEM704.ASM to reset the internal indicators for maximum RAM memory to 704K bytes. You don't need to change the switches on your system board that specify memory size.

MEM704.ASM does several things. It increases the maximum memory size, stored in the BIOS data area at 413 hexadecimal (or 40:13), and sets the new memory to zero to avoid parity errors. After making these changes, the program initiates interrupt 19h so the PC will reload DOS. Finally, it checks to make sure that it doesn't perform these services a second time.

First, MEM704.ASM establishes the segment in the BIOS data area at 40 hexadecimal (bios_d). Then it defines the offset (in this segment) of the maximum memory size stored at location 13 hexadecimal (mem_siz). The code segment begins by checking the word at 413 to see if the value stored there is already 704K (2C0 hexadecimal). (This will be the case after the program has reset the computer with interrupt 19h.) If so, the program terminates because this is the second time it has been run. However, if this is the first time the program has executed, it checks to see if the computer has 704K bytes of memory installed.

To determine whether any memory exists at the A000 segment, the program writes the pattern 55 hexadecimal, an alternating sequence of zeros and ones, at the beginning of the A000 segment. Then it reads back the value to see if it is correct. Next, it writes the value AA, an alternating se-

Listing 3: FILL.ASM, a program to reduce the size of addressable memory. (Note that this is written to be executed in a .COM file.)

```

PAGE      ,132
TITLE     FILL part of memory

COMMENT *
  Program to fill part of memory with
  resident program (some programs will
  not run when there is too much memory).
  Macros: @write
  INT 27h
*
cr        EQU      13
lf        EQU      10

          IF1
          INCLUDE  mymac.lib
          ENDIF

code      SEGMENT
          ASSUME  CS:code, DS:code
          ORG     100h

strt:
  @write  <cr,lf,' Memory reduced 64K bytes'>
;-----
; quit and stay resident
;-----
          MOV     DX,OFFSET strt-OFFSET pg_len
          INT     27h                ;done
pg_len    LABEL   BYTE

code      ENDS
          END     strt
    
```

Listing 4: MEM704.ASM, a program to increase addressable memory from 640K to 704K bytes. (Note that this is written to be executed in a .COM file.)

```

PAGE      ,132
TITLE     704K - set memory to 704K bytes

COMMENT *
  Increase memory to 704K bytes by changing
  BIOS data word at 40:13 hex
  Set new memory to zero
*
cr        EQU      13
lf        EQU      10

          IF1
          INCLUDE  mymac.lib
          ENDIF

old_siz   EQU      640                ;old mem size
new_siz   EQU      704                ;new mem size
new_seg   EQU      0A000h            ;704K segment

; BIOS data area
bios_d    SEGMENT AT 40h
          ORG     13h
mem_siz   LABEL   WORD                ;memory size
bios_d    ENDS
    
```

```

code    SEGMENT
ASSUME  CS:code,DS:code, ES:bios_d
ORG     100h

strt:
; point to memory size in BIOS data area
MOV     AX,bios_d      ;zero
MOV     ES,AX
MOV     SI,OFFSET mem_siz
; check if already run
CMP     WORD PTR ES:[SI],new_siz
JNE     ok
INT     20h            ;quit
; check for memory at A000 hex
ok:
MOV     BX,ES          ;save ES
MOV     AX,new_seg
MOV     ES,AX          ;ES=A000
XOR     DI,DI          ;offset
MOV     AX,55AAh
MOV     ES:[DI],AH     ;55 hex
CMP     AH,ES:[DI]    ;ok?
JNZ     no_mem         ;no
MOV     ES:[DI],AL    ;AA hex
CMP     AL,ES:[DI]    ;ok?
JNZ     no_mem         ;no
; set memory size for 704K bytes
MOV     CX,ES          ;save ES
MOV     ES,BX          ;ES=40
MOV     WORD PTR ES:[SI],new_siz
MOV     ES,CX          ;ES=A000
; fill new memory with zeros
XOR     AX,AX          ;zero word
MOV     DI,AX          ;zero location
MOV     CX,8000h       ;32K words
REP     STOSW          ;do it
@write <' Memory now 704K bytes',cr,lf>
INT     19h            ;reboot system
; no memory at A000 hex, terminate without change
no_mem:
@write 'No memory at A000 hex, aborting'
INT     20h

code    ENDS
END     strt

```

quence of ones and zeros, and again checks for the correct value. If the program can't read back the values it stored, it concludes that there is no memory at the A000 segment. The program displays an error message and aborts.

If 704K bytes of memory are present, the program changes the BIOS word at 413 to 2C0, sets the memory in segment A000 to zero, writes the message "Memory now 704K bytes" on the screen, and reboots with interrupt 19h.

This "new" memory needs to be set to zero because the IBM PC uses parity-checked memory. Each 8-bit

byte has an associated ninth bit that is used for a parity check. The sum of the 9 bits *must* have zero parity. When any byte is read, the parity bit is checked to see that there is no error. However, this scheme works properly only if the parity bits are set correctly on start-up. You can accomplish this by writing a zero in each memory location.

The system sets memory parity only up through 640K bytes. Therefore, the new memory in the A000 segment will not automatically be set to even parity. If you try to read from the new memory before setting its parity, you will get a parity error and your com-

You can increase or decrease the PC's memory to do what you want.

puter will lock up. However, if you first fill the new memory with zeros, it will pass subsequent parity checks.

MEM704.ASM sets the new 64K bytes of memory to zero with the store-string instruction (STOSW). It points the ES:DI registers to the beginning of segment A000, sets the AX register to zero, sets the CX register to 64K bytes (8000 hexadecimal, or 32K words), and combines the REP instruction with the STOSW string instruction. After you run MEM704.ASM, your programs can use as much as 704K bytes of memory. You might want to establish a 360K-byte RAM disk with the DOS VDISK program. If you do, you will still have 344K bytes of usable memory.

If you run CHKDSK.COM after establishing a 360K-byte RAM disk, you will see a display such as

```

720896 bytes total memory
281472 bytes free

```

Since 1K bytes equals 1024 or 2¹⁰ bytes, 704K bytes equals 720,896 bytes. You can also think of this as 11 segments (0 through A) of 64K bytes, or 65,536 bytes, each.

While this technique works properly with both the monochrome and the graphics adapter, there is a potential problem. The IBM Extended Graphics Adapter uses part of the A000 segment. Therefore, you cannot use this technique when you have an EGA installed in your computer.

IN CONCLUSION

As you can see, you can adjust the amount of memory on the IBM PC to fill your needs. Within limits, you can increase it—or decrease it—to do what you want to do. You aren't necessarily stuck with what comes on the system. ■

It lets all the programs we just mentioned (and plenty more in the future) do all the things we just described, all on one screen.

At precisely the same speed as text mode.

How RamFont works.

Like text mode, RamFont uses a 16-bit word to represent a character on the display.

Unlike text mode, however, the 48K RamFont mode uses a 12-bit character code instead of an 8-bit code.

Which allows you to choose from an astonishing 3072 different characters.

While setting the size of your screen cells from eight to nine pixels wide and from four to 16 scan lines tall.

To help you design your own RamFont characters and symbols, we've included a font editor called FontMan.™

Along with a set of 25 sample fonts to start your library.

And since the 4K RamFont mode can accept 8-bit character codes, running your text mode software with your favorite font is as simple as loading it into RAM.

Just for the record, RamFont supports

the standard character attributes of reverse, high-intensity, blink and underline.

Plus two new RamFont attributes: boldface and strike-through.

What price success?

While we're on the subject of technological breakthroughs, let's not forget the suggested retail price.

Think of it. You get everything the original card gave you.

Plus RamFont.

Plus FontMan.

Plus a free printer cable.

Plus a parallel printer port that you can now disable if there's a conflict with another port in your system.

All for just \$299—about half the price of the original Graphics Card.

If you haven't gone into shock, call 1-800-532-0600 ext. 212 for the name of an Authorized Hercules Dealer near you and we'll rush you our free info kit.

\$299.

Suggested retail price.

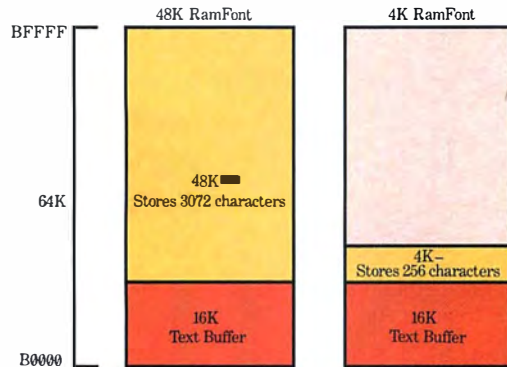

The new RamFont mode displays 3072 programmable characters at the speed of text mode, or replaces the standard character set with one of your choice in 4K RamFont mode.

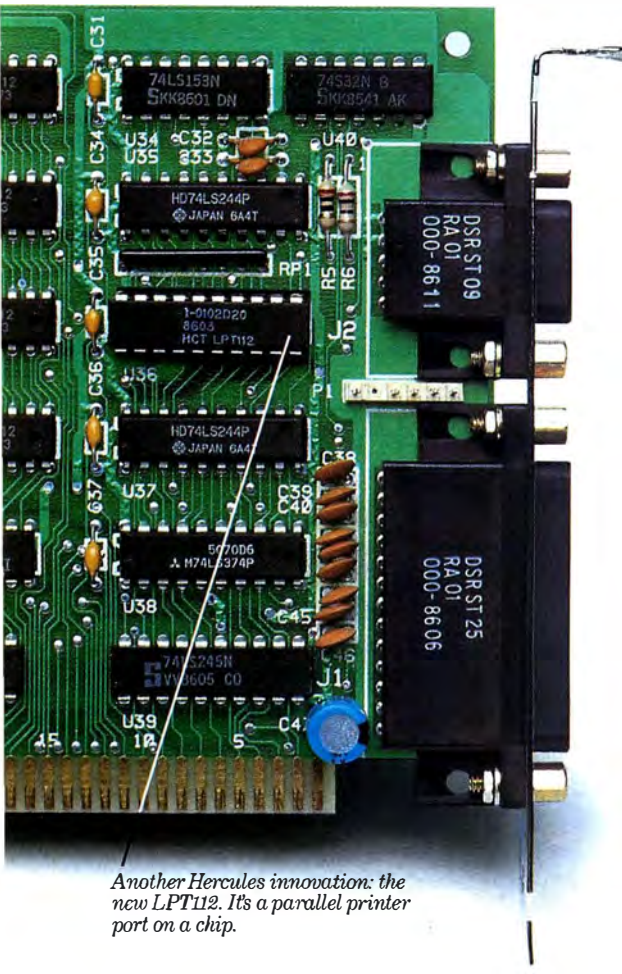

Another Hercules innovation: the new LPT112. It's a parallel printer port on a chip.

Hercules.™ We're strong on graphics.

Address: 2550 Ninth Street, Berkeley, California 94710 Ph: 415 540-6000
Telex: 754063

Trademarks/Owners: Lotus, 1-2-3, Symphony/Lotus; Framework/Ashton-Tate; Microsoft/Microsoft; Hercules, RamFont, FontMan/Hercules

Inquiry 123

WE TOP IBM BEAUTIFULLY



I BM's Personal Computer is the standard of the industry, but a Thomson monitor gives your IBM's great body a beautiful face. A Thomson monitor atop your IBM simply outperforms the IBM Color Display.

Here's proof:

Who is Thomson? Thomson is a six billion dollar multi-national company. Unlike our competition, we design and build our own monitors with stringent quality control. We offer monochrome or color monitors from TV-grade to high resolution.

FEATURE	THOMSON .38mm COLOR	IBM COLOR DISPLAY	BENEFIT
Dot pitch (in mm)	.38	.43	Superior resolution
Screen	Non-glare	Glare	Less eyestrain
Switch for green/amber text	Yes	No	Improved legibility
All major controls up front	Yes	No	Greater convenience
Warranty	1 yr.	90 days	Greater confidence
List Price	\$549	\$680	A bargain

Call 1-800-325-0464. In California call 1-213-568-1002 (Monday-Friday, 9 a.m. to 5 p.m. PST) for your local Thomson dealer, and start looking at a beautiful face.

THOMSON 
A SIGHT FOR SORE EYES.™

© 1986 Thomson Consumer Products Corporation 5731 W. Slauson Avenue, Suite 111, Culver City, CA 90230

Thomson is a trademark of Thomson S.A. IBM is a registered trademark of International Business Machines Corp. IBM model number 5153. List prices in effect on February 18, 1986.

WRITING ASSEMBLY LANGUAGE : INTERRUPT ROUTINES

*A description of interrupts on the PC
and examples of some interrupt handlers*

BY WILLIAM J. CLAFF

THIS IS A GUIDE for IBM PC programmers interested in writing assembly language interrupt routines. I will briefly discuss the concept of an interrupt, followed by some programming examples.

You can think of interrupt routines as subroutines called by the hardware or the operating system. Implementing interrupt routines is an advanced topic in programming that requires a high degree of understanding of the computer's existing interrupt structure and hardware. I am assuming that you are familiar with the basics of assembly language programming for the IBM PC.

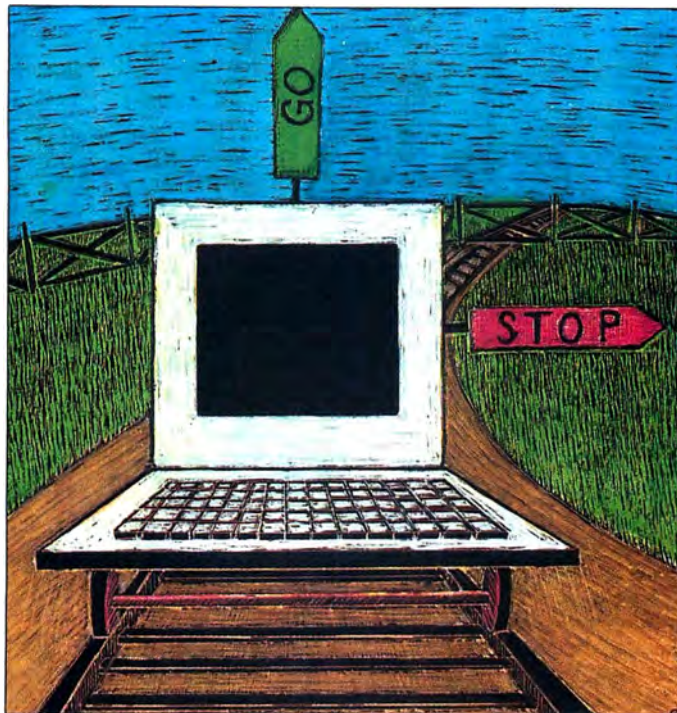

nized the value of stand-alone software interrupts.

HARDWARE INTERRUPTS

Hardware interrupts are either internal or external. Internal hardware interrupts are generated from within the CPU; external hardware interrupts are generated by circuitry outside the CPU. On the IBM PC, the 8259 PIC manages external interrupts.

SOFTWARE INTERRUPTS

Software interrupts have three levels: BIOS interrupts, DOS interrupts, and application-program interrupts.

IBM intended the BIOS interrupts to be the sole

INTERRUPTS ON THE 8088

The Intel 8088 microprocessor has 256 interrupts that are dispatched through the interrupt-vector table located at 0000:0000 hexadecimal. This table is treated as a zero-based array of the interrupt routines' double-word addresses. The two types of interrupts are hardware and software.

The hardware interrupt is aptly named. The CPU, or external circuitry attached to the CPU, generates hardware interrupts. When a hardware interrupt occurs, it suspends the code that is currently executing so the interrupt routine can be called.

The software interrupt is not so aptly named. The execution of the INT instruction generates software inter-

rupts. Since the code is not suspended at an arbitrary location as it is during a hardware interrupt, the term "interrupt" is a misnomer. In effect, INT behaves much like a subroutine call.

Many early microcomputer systems had no software-interrupt capability. This concept was first introduced in the Intel 8080 with the RST (restart) instruction. The 8080's interrupts are usually controlled by an Intel 8259 Programmable Interrupt Controller (PIC) that lets you associate a hardware interrupt with each of the eight RST interrupts. Intel took a different approach with the 8085; it included three hardware interrupts with no corresponding software interrupt. It wasn't until the 8086 that Intel recog-

means of accessing the hardware. Unfortunately, due to incomplete functionality and speed considerations, many programs manipulate the hardware directly. Such programs are less likely to work with "IBM-compatible" computers.

DOS interrupts are intended as the sole means of accessing the DOS

(continued)

William J. Claff (7 Roberts Rd., Wellesley, MA 02181) is a senior technical engineer with SoftSet Associates. He has run his own microcomputer retail and consulting business since 1978. Mr. Claff, who holds an M.S. in applied mathematics from Harvard University, publishes an IBM technical newsletter and is the leader of the IBM PC Technical Subgroup of the Boston Computer Society's IBM PC Users Group.

Custom forms. Easy.

Isn't it frustrating? You need all kinds of forms to run your business, but your word processor can't draw lines and your graphics software won't type. Now **FormWorx™** lets you create top-quality business forms right on your PC — or modify existing ones quickly and easily as your needs change. FormWorx is fast, neat and flexible.

Design forms easily. You can use solid, double, bold, or dotted lines. And choose from a variety of graphic symbols and type sizes (including compressed type on most printers) using simple commands and pop-down menus. Pick from dozens of possible form sizes including 11" x 14".

Fill out forms perfectly. You can fill out custom or even pre-printed forms on your PC without accidentally crossing a line, using text editing features like on-screen underlining, boldfacing, justification and automatic word wrap. Integrated macros let you automate repetitive tasks, type "boiler plate" phrases

with a single keystroke, jump from one blank to another, and more.

Print the whole form or just the data. On any of 100 printers including the HP LaserJet.

Special offer! For just \$95* you get the complete FormWorx system including sample forms and superb manual with tutorials. Plus free telephone support. Ask your dealer or order directly using your credit card.

1-800-992-0085
(In Mass. 617-641-0400)

Ask about our other products including M.A.C.E.™, the character editor for designing special symbols, and ESCapade™, for getting the most out of your printer.

Analytix International, Inc.
1365 Massachusetts Avenue
Arlington, MA 02174

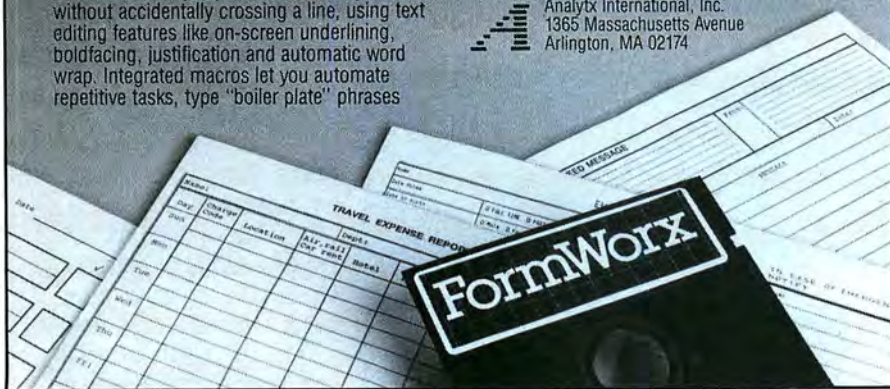

*Includes normal handling and shipping. Add \$5 for foreign, COD, and POs.

Requirements: IBM PC with 320 KB and DOS 2.0 or higher. Works with or without a graphics board. FormWorx is a trademark of Analytix International, Inc.

INTERRUPT ROUTINES

The interrupt-intercept

resources. Fortunately, most programs abide by the intent of the DOS software-interrupt interface.

The application-program interrupts are those used by programs executed by the DOS (e.g., BASIC). You must be aware of these interrupts in order to permanently install a new interrupt routine. Although many interrupts are unused, only interrupts 60h through 67h are officially available.

INTERRUPT LEVELS

To illustrate the various interrupt levels, I want to consider the PC's keyboard. The three keyboard-related interrupts are the external hardware interrupt, the BIOS software interrupt, and the DOS software interrupt.

A DOS software interrupt that involves the keyboard (e.g., function 1h) will use the BIOS software interrupt 16h to interface with the hardware. The INT 016H routine polls memory locations it shares with hardware interrupt 9h. When you press a key, you generate an interrupt 9h. The INT 009H routine stores the keystroke in the shared buffer; the INT 016H routine senses the arrival of the keystroke and returns the key to DOS.

REPLACEMENT VS. INTERCEPT

An interrupt-replacement routine is one that replaces an existing interrupt routine. An INT 023H (control/break) handler would be of this type.

Rather than replacing an existing interrupt routine, the interrupt-intercept routine remembers the original interrupt routine. It might or might not pass control through to the original routine. Most keyboard macro programs are of this type. They do not replace the BIOS INT 009H routine (the keyboard-interrupt handler) but field the hardware interrupt first and decide whether or not to use the

(continued)

NEW RELEASE 1.1

StatPac Gold Outperforms SPSS/PC+™

- Faster learning curve
- More convenient to use
- Less expensive
- More comprehensive
- Prompt technical support
- Personal & courteous service
- Uses less disk space
- Requires less memory
- Handles more variables
- Contains more options
- More frequent updates
- Affordable academic licenses
- Greater versatility
- Better data file management
- More readable printouts
- Designed specifically for the PC
- Available from your local dealer
- Many analyses not found in SPSS/PC+™

- Menus or commands
- Interactive or batch
- Windows
- Presentation-quality graphics
- On-line help
- Clearly written user's manual
- dBase™ & Lotus™ compatibility
- Quality control & forecasting options
- Latest version contains 11 ANOVA designs

...and the list goes on

► StatPac Gold saves time and money. You receive quality performance at a reasonable cost. One price of \$595 buys it all. No need to buy several expensive modules to get full capabilities. (SPSS charges almost \$2,000 for all their modules!)

► Full Working Evaluation Copy Available (not a self-running demo)

YOU OWE IT TO YOURSELF TO FIND OUT!

Call 1-800-328-4907



WALONICK ASSOCIATES, INC.

6500 Nicollet Ave. S., Minneapolis, MN 55423 • (612) 866-9022

SPSS/PC+ is a trademark of SPSS Inc., dBase is a trademark of Ashton-Tate, Lotus is a trademark of Lotus Development Corp.

EGAWONDER™

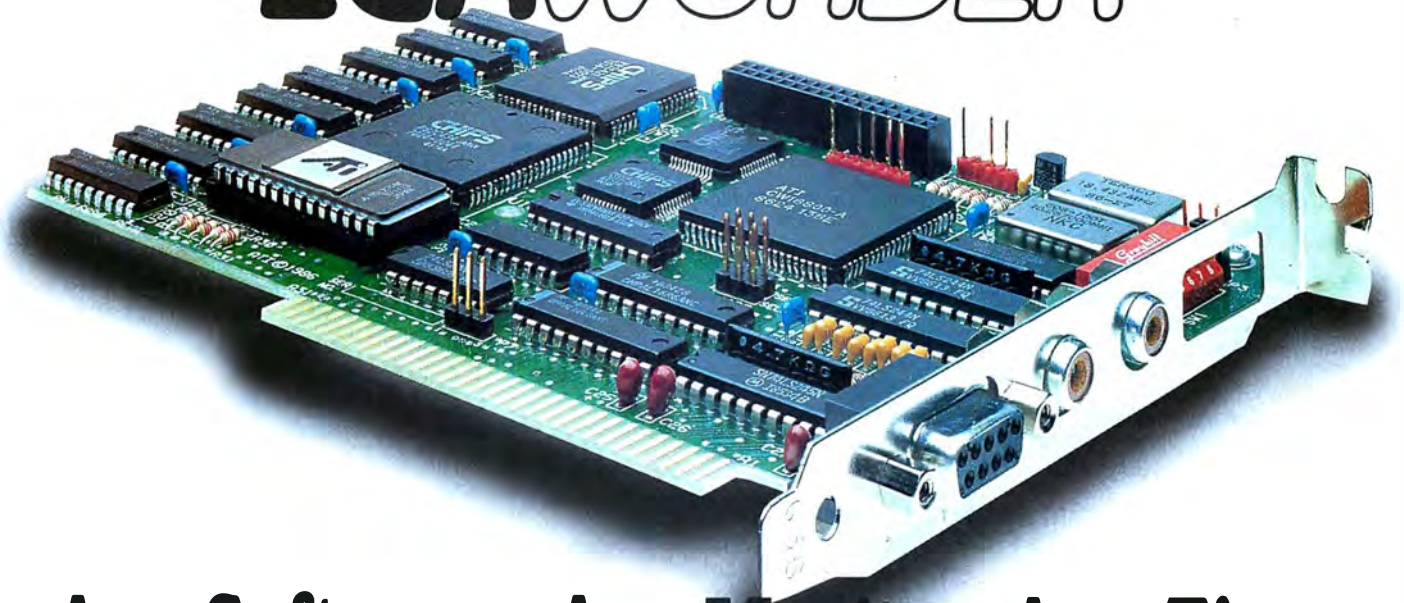

Any Software. Any Monitor. Any Time.

EGA Software

Hercules Software

EGA Software

Hercules Software

EGA Software

Hercules Software



CGA Software

132 Column Software

CGA Software

132 Column Software

CGA Software

132 Column Software

EGA Monitor

EGA Wonder runs EGA, CGA, MDA, Hercules and 132 Columns on an Enhanced Graphics Display. CGA text is improved to 8 x 14 and graphics are double scanned for a high quality display.

TTL Monochrome Monitor

EGA Wonder runs EGA, CGA, MDA, Hercules and 132 Columns on a TTL Monochrome Monitor. Colors of EGA and CGA are converted into shades, graphics are full screen and no pre-boot drivers are required.

RGB, *Composite Monitors, and the IBM Portable P.C.

EGA Wonder also runs EGA, CGA, MDA, Hercules and 132 Columns on an RGB Monitor, *Composite Monitor, and the IBM Portable P.C. in 64 colors (shades). EGA and Hercules software are inter-laced for high resolution text and graphics.

* Composite Monitor not shown

Features	ATI EGA Wonder	Paradise Auto Switch	Quadram and Video 7
Compatible to EGA, CGA, MDA, Hercules	✓	✓	✓
256K Video Memory	✓	✓	✓
Automatic Switching Between EGA and CGA Color Modes and Among EGA, MDA, and Hercules Modes	✓	✓	
Runs EGA, CGA, MDA, Hercules and 132 Columns on an EGA Monitor	✓		
Runs EGA, CGA, MDA, Hercules and 132 Columns on an RGB Color Monitor	✓		
Runs EGA, CGA, MDA, Hercules and 132 Columns on a TTL Monochrome Monitor	✓		
Runs EGA, CGA, MDA, Hercules and 132 Columns on a Composite Monitor	✓		
Runs EGA, CGA, MDA, Hercules and 132 Columns on an IBM Portable P.C.	✓		
Warranty	2 Yrs	1 Yr	1 Yr
Suggested List Price	\$399	\$599	\$595

EGA - Enhanced Graphics Adapter MDA - Monochrome Display Adapter
CGA - Color Graphics Adapter

*Trademarks: Paradise, Auto Switch - Paradise Systems Inc; Quad EGA+ is a trademark of Quadram Corp.; Video-7, Video-7, Incorporated. IBM Portable P.C. - IBM - International Business Machines

420 Esna Park Dr. Markham, Ontario Canada L3R 1H5 TLX. 06-966640

Inquiry 318

Upgrade to EGA Without An EGA Monitor

Only EGA Wonder transcends normal hardware compatibility by displaying EGA, MDA, CGA, Hercules and/or 132 columns, on any of the four major monitor types.

True Hardware Level Compatibility

No incompatibilities, no limitations - EGA Wonder is compatible at the hardware level to EGA, CGA, MDA, and Hercules.

Automatic Mode Switching

No mode commands, no special software - EGA Wonder can sense and automatically switch between EGA and CGA color modes or between MDA, Hercules and EGA monochrome modes.

The Unique Solution

Only EGA Wonder runs any software, any monitor, anytime with true hardware level compatibility and automatic mode switching. Call us today at (416) 477-8804 for more information.



Technology you can Trust.

Listing 1: Source code for the PRTSC program. The include file, PSP.INC, is in listing 2.

```

;=====INTERRUPT VECTOR STRUCTURE
VECTOR STRUC
REGIP DW ?
REGCS DW ?
VECTOR ENDS
;=====KEYBOARD SHIFT FLAG RECORD
RIGHT EQU 0000001B
;=====CODE SEGMENT
CODE SEGMENT
;*****EXECUTION STARTS WITH THIS PIECE
ASSUME CS:CODE,DS:CODE,ES:CODE,SS:CODE
; PROGRAM SEGMENT PREFIX
INCLUDE PSP.INC
; LABEL FOR END STATEMENT
IP LABEL NEAR
JMP SHORT START
;*****INTERRUPT INTERCEPT PIECE
ASSUME CS:CODE,DS:NOTHING,ES:NOTHING
ASSUME SS:NOTHING
ORG05 VECTOR <> ;ORIGINAL INT
; ; 005H VECTOR
;-----INTERCEPT ROUTINE
INT05 PROC FAR
PUSH AX
MOV AH,002H ;GET KEYBOARD
; ; FLAGS FROM BIOS

INT 016H
; TEST FOR RIGHT SHIFT KEY
TEST AL,RIGHT
POP AX
JNZ INT05X
; NOT DOWN, DO ORIGINAL INT 005H
JMP ORG05
INT05X LABEL NEAR
IRET
INT05 ENDP
;*****INITIALIZATION PIECE
ASSUME CS:CODE,DS:CODE,ES:CODE,SS:CODE
START LABEL NEAR
;-----GET INT 5 VECTOR AND SAVE IN ORG05
PUSH ES
MOV AH,035H
MOV AL,005H
INT 021H
ASSUME ES:NOTHING
MOV ORG05.REGIP,BX
MOV ORG05.REGCS,ES
POP ES
ASSUME ES:CODE
;-----SET INT 5 VECTOR TO INT05
MOV AH,025H
MOV AL,005H
MOV DX,OFFSET INT05
INT 021H
;-----FREE MEMORY ALLOCATED TO THE ENVIRONMENT
PUSH ES
MOV AH,049H
MOV ES,ENVIRONMENT
ASSUME ES:NOTHING
INT 021H

```

BIOS INT 009H routine as well.

In fact, most interrupt routines are (or should be) interrupt-intercept routines. For example, some word processors will replace the keyboard interrupt and not pass control through to other programs "watching" the keyboard.

So far, I have been careful to differentiate hardware from software, internal from external, and BIOS from DOS interrupts. However, the type of interrupt routine is usually implied in the interrupt number. For the balance of this article, I will not distinguish between interrupt types unless there is an ambiguity.

PRTSC

Listing 1, PRTSC.ASM, is a handy interrupt-intercept routine. [Editor's note: The listings in this article are available on disk, in print, and on BIX. See the insert card following page 176 for details. Listings are also available on BYTenet. See page 4.] It intercepts interrupt 5h (the print-screen interrupt) and passes control through to the original print-screen routine only if you are not holding down the right Shift key. This eliminates accidental print-screen functions caused by careless typists and abetted by the adjacent placement of the Shift and Print Screen keys on the IBM PC and PC XT keyboards.

PRTSC begins by defining VECTOR and RIGHT. VECTOR is a structure for holding an interrupt-vector address. RIGHT is a bit in KB__FLAG that is described in the ROM BIOS data area.

The CODE segment is divided into three sections: the entry code, the intercept-routine code, and the initialization code. Note that the ASSUME statements at the top of each piece properly convey the segment-register values. In particular, the only known segment-register value at the top of the intercept piece is CS=SEG CODE. I will describe the sections of the CODE segment in order of execution.

ENTRY CODE

The entry code starts with an INCLUDE of the file PSP.INC, as shown in listing 2. This file represents the lay-

out of the program segment prefix (PSP). PRTSC uses the value of ENVIRONMENT (it needs this to free the memory allocated to the environment). IP is a LABEL for the END statement and must be at offset 00100 hexadecimal. There is no need for an ORG 00100H statement, since the PSP occupies 00100 hexadecimal bytes. The only executable code in the entry code is a jump to the START LABEL of the initialization code. Since you jump over the interrupt-routine code, the initialization code will be highest in memory.

INITIALIZATION CODE

This section uses DOS functions 35h (GET) and 25h (SET) to retrieve and modify the interrupt 5h vector. The original interrupt 5h vector is saved for use by the intercept routine.

Note the careful use of ASSUME statements. Good assembly language programming requires strict adherence to this rule: Any statement changing the value of a segment register must be immediately followed by the appropriate ASSUME statement.

The next piece of code frees the memory that is allocated to the environment. This memory is usually freed when the program terminates; however, INT 027H (the terminate-and-stay-resident interrupt) does not free this memory. Finally, the termination interrupt is executed, returning to DOS. The memory before the LABEL START is reserved so that subsequent programs do not overlay the interrupt routine. The IP on the END statement is required for EXE2BIN to work properly. As noted earlier, IP must have a value of 00100 hexadecimal.

INTERCEPT-ROUTINE CODE

Control passes to the code at location INT05 whenever an INT 005H is executed. (Interrupt 5 is a BIOS interrupt that is often replaced by executing the DOS program GRAPHICS.) INT05 checks the keyboard-shift flags using a BIOS interrupt. If the right Shift key is held down, the routine simply exits with an IRET. If the right Shift key is

```

                POP     ES
                ASSUME ES:CODE
;-----TERMINATE PROTECTING MEMORY BELOW START
                MOV     DX,OFFSET START
                INT     027H
CODE           ENDS
                END     IP      ;NOTE IP FOR EXE2BIN
    
```

Listing 2: Layout of the program segment prefix.

```

;=====PROGRAM SEGMENT PREFIX
TOP_OF_MEMORY   INT     020H      ;INT 020H
                DW     ?
                DB     ?
                DB     5 DUP(?)   ;IOCTL
                DB     5 DUP(?)   ;DOS_JMP
TERMINATE        VECTOR <>
CTRL_BREAK      VECTOR <>
CRITICAL_ERROR  VECTOR <>
                DW     ?
                DB     20 DUP(?)  ;USED BY DOS
ENVIRONMENT      DW     ?
                DW     7 DUP(?)   ;USED BY DOS
                DB     20 DUP(?)  ;UNUSED ?
DOS_CALL         PROC FAR
                INT     021H      ;INT 021H
                RET
DOS_CALL         ENDP
                DB     9 DUP(?)   ;UNUSED ?
FORMATTED_AREA_1 DB     16 DUP(?)
FORMATTED_AREA_2 DB     16 DUP(?)
                DB     4 DUP(?)   ;UNUSED
UNFORMATTED_LENGTH DB    ?
UNFORMATTED_AREA DB    127 DUP(?)
    
```

not held down, control is passed to the previous interrupt 5h routine.

ASSEMBLING PRTSC

To assemble PRTSC and produce a usable program file, execute the following commands:

```

MASM PRTSC;
LINK PRTSC;
EXE2BIN PRTSC PRTSC.COM
    
```

Do not be alarmed by any message from the linker concerning the stack segment, since .COM files cannot have a stack segment. To use PRTSC, type PRTSC on a line by itself in your AUTOEXEC.BAT file.

NESTED INTERCEPT ROUTINES

PRTSC does not detect whether or not you have already installed the inter-

cept routine. The installation of additional PRTSC routines causes no problems, except that each installation uses memory. There is no standard for the identification of intercept routines. Therefore, detection of reinstallation is not a trivial matter. Although it is probably too late to take hold, I propose the following interrupt-routine standard:

```

NAME          DB
NEXTRTN       VECTOR <>>
ROUTINE       PROC FAR
...
ROUTINE       ENDP
    
```

The ROUTINE is preceded by the VECTOR NEXTRTN, where VECTOR defines a structure consisting of a segment/offset double word. NEXTRTN

(continued)

Listing 3: Source code for the CLK program.

```

;=====VECTOR STRUCTURE
VECTOR  STRUC
REGIP   DW      ?
REGCS   DW      ?
VECTOR  ENDS
;=====DATA SEGMENT
DATA    SEGMENT PUBLIC 'DATA'
CLKDIV  DW      ?      ;<- USER PROVIDED DIVISOR
        PUBLIC  CLKDIV
        ; ACTUAL DIVISOR ...
CLKDIVH DW      ?      ;... (HIGH WORD)
CLKDIVL DW      ?      ;... (LOW WORD)
CLKMOD  DW      ?      ; DIVISOR MODULUS
; USER-PROVIDED NEAR PROCEDURE
CLKRTN  DW      ?
        PUBLIC  CLKRTN
INT08   VECTOR <>      ;INTERCEPTED INT 008H VECTOR
DATA    ENDS
;=====STACK SEGMENT
STACK   SEGMENT STACK 'STACK'
STACK   ENDS
;=====CODE SEGMENT
CODE    SEGMENT PUBLIC 'CODE'
        ASSUME  CS:CODE,DS:DATA,ES:DATA,SS:STACK
        EXTRN  SEGCODE:WORD      ;<- CODE SEGMENT
        EXTRN  SEGDATA:WORD     ;<- DATA SEGMENT
;*****CLKRATE CLOCK RATE SETTING ROUTINE
CLKRATE PROC NEAR
;-----LOAD COUNTER 0 OF THE 8259
        PUSH   AX
        MOV    AL,00110110B
        OUT   043H,AL
        POP   AX
        OUT   040H,AL
        XCHG  AH,AL
        OUT   040H,AL
        XCHG  AH,AL
        RET
CLKRATE ENDP
;*****CLKPRO CLOCK PROLOGUE
CLKPRO  PROC NEAR
        PUBLIC CLKPRO
        PUSH  AX
        PUSH  DX
;-----INITIALIZE CLK VARIABLES
        XOR   AX,AX
        CALL  CLKRATE
        MOV   CLKDIV,AX
        MOV   CLKDIVH,1
        MOV   CLKDIVL,AX
        MOV   CLKMOD,AX
        MOV   CLKRTN,OFFSET CLKNUL
;-----SAVE CURRENT INTERRUPT VECTOR
        PUSH  ES
        MOV   AH,035H
        MOV   AL,008H
        INT   021H
        ASSUME ES:NOTHING
        MOV   INT08.REGIP,BX
        MOV   INT08.REGCS,ES
        POP   ES
        ASSUME ES:DATA
;-----INSTALL INTERRUPT INTERCEPT VECTOR

```

(continued)

points to the next routine in the intercept-routine chain. If there is no next routine, NEXTRTN is VECTOR <-1,-1>. NEXTRTN is preceded by an eight-character name.

If this standard were in place, the installation code could start at the original interrupt-vector location, follow the interrupt-routine chain, and determine whether or not to install the intercept. The linked list could also be manipulated to modify the priorities of routines vying for a common resource.

CLK

Listing 3, CLK.ASM, is a module containing code to assist in managing the Intel 8253 Programmable Interval Timer. This chip has three counters. Counter 0 generates interrupt 8h, counter 1 triggers dynamic memory refreshes, and counter 2 drives the cassette port or speaker. They count at a rate determined by the system crystal frequency of 14.31818 megahertz.

Designers of the PC chose this value because, when divided by 4, it produces a 3.58-MHz rate for television color burst. When divided by 3, it produces a 4.77-MHz rate for the Intel 8088. When divided by 12, it produces a 1.19-MHz rate for the Intel 8253. The counter chip has 16-bit counters that count down to 0 (a 0 value is equivalent to 65,536 decimal). The 1.19-MHz rate divided by 65,536 produces the 18.2-Hz signal that triggers the interrupt 8h handler.

INTERRUPT 8H

Interrupt 8h has three responsibilities. First, it updates a count that represents the system time. Second, it decrements the count for the floppy disk head load. This controls when the head is retracted and the LED light goes off; the head is kept against the disk until this count reaches 0. The count is reset on every disk access, thus reducing disk access time if a new read or write request arrives while the head is still loaded.

Third, interrupt 8h does an INT 1CH (timer tick), letting you provide a

(continued)

CHAIRMAN OF THE BOARDS

THE 2400 bps MODEM FOR IBM-PCs & COMPATIBLES.

Plug the new USRobotics Microlink 2400™ modem board into any slot in your IBM PC or compatible—to give your computer full 2400 bps data communications capability.

The Microlink 2400 can communicate twice as fast as 1200 bps modems. (It transmits a double-spaced page of text in as little as 7 seconds!) Faster communication means lower phone bills and increased productivity. The modem can even redial busy numbers until it gets through—freeing you for other tasks.



Microlink 2400 displays call status and length on your screen, as well as operational parameters, including the command set and S-register settings. The modem's auto-answer feature automatically adjusts from 2400 bps to 1200 or 300 bps to match the speed of incoming transmissions.

What's more, a powerful equalizer assures peak performance on every call.

SOFTWARE COMPATIBILITY, SUPERIOR PERFORMANCE.



Help Screens

The Microlink 2400 is CCITT and Bell compatible, and responds to the full AT command set. You can use it with any of the popular telecommunications software packages including Telpac™ by USRobotics, Crosstalk™, PC Talk™ and Smartcom™. In

addition to the features you'd expect, our new, improved Telpac enhances Microlink 2400's performance with such features as easy-to-use windows, multilevel security, and log files to monitor your outgoing calls.

ALL THIS PLUS HIGH RELIABILITY AND LOW COST, TOO.

Microlink 2400's low chip count results in exceptional reliability—backed by a full 2-year manufacturer's warranty. But best of all is the price—only \$699! And if you prefer an external modem, our new Courier 2400™ will deliver the same superior performance at the same affordable price. We set out to build the best modems on the market. Now, they're ready. Microlink or Courier. Being faster is important. But being best was our goal.



Courier 2400™

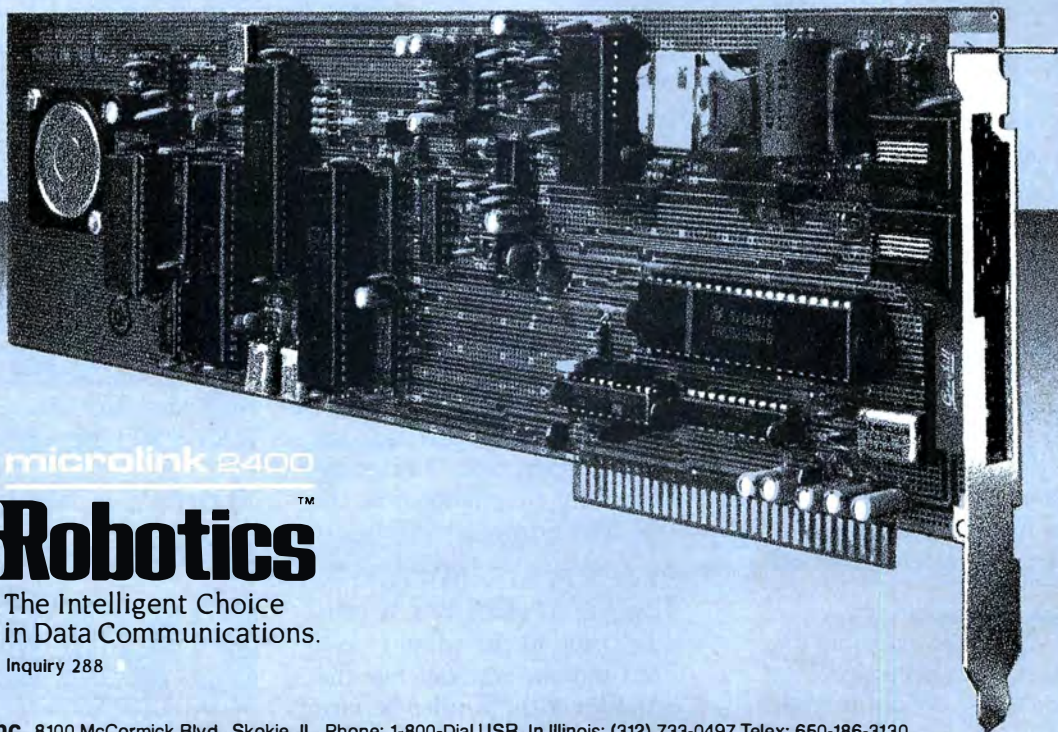

microlink 2400

USRobotics™

The Intelligent Choice
in Data Communications.

Inquiry 288

Announcing BYTE's New Subscriber Benefits Program

Your BYTE subscription brings you a complete diet of the latest in microcomputer technology every 30 days. The kind of broad-based objective coverage you've read in this issue. *In addition*, your subscription carries a wealth of other benefits. Check the check list:

DISCOUNTS

- 13 issues instead of 12 if you send payment with subscription order.
- One-year subscription at \$21 (50% off cover price).
- Two-year subscription at \$38.
- Three-year subscription at \$55.
- One-year GROUP subscription for ten or more at \$17.50 each. (Call or write for details.)

SERVICES

- BIX:** BYTE's Information Exchange puts you on-line 24 hours a day with your peers via computer conferencing and electronic mail. All you need to sign up is a microcomputer, a modem and telecomm software.
- Reader Service:** For information on products advertised in BYTE, circle the numbers on the Reader Service Card enclosed in each issue that correspond to the numbers for the advertisers you select. Drop it in the mail and we'll get your inquiries to the advertisers.
- TIPS:** BYTE's Telephone Inquiry System is available to subscribers who need *fast response*. After obtaining your

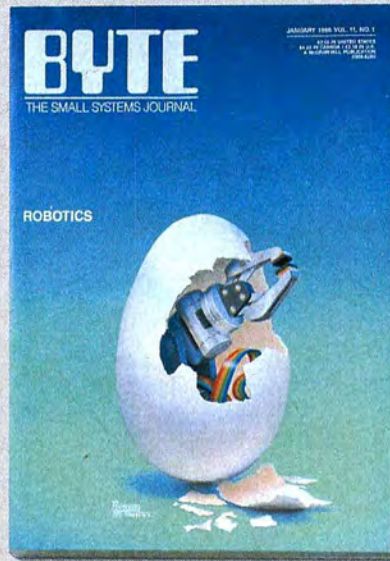

Subscriber I.D. Card (see TIPS information adjacent to Reader Service cards), dial TIPS and enter your inquiries. You'll save as much as ten days over the response to Reader Service Cards.

- Disks and Downloads:** Listings of programs that accompany BYTE articles are now available free on the BYTENet bulletin board; and on disk or in quarterly printed supplements (see reply cards in this issue).
- Microform:** BYTE is available in microform from University Microfilm International in the U.S. and Europe.
- BYTE's BOMB:** BYTE's Ongoing Monitor Box is your direct line to the editor's desk. Each month, you can rate the articles via the Reader Service

Card. Your feedback helps us keep up to date on your information needs.

- Customer Service:** If you have a problem with, or a question about, your subscription, you may phone us during regular business hours (Eastern time) at our toll-free number: 800-258-5485. You can also use Customer Service to obtain back issues and editorial indices.

BONUSES

- Annual Separate Issues:** In addition to BYTE's 12 monthly issues, subscribers also receive our annual IBM PC issue free of charge, as well as any other annual issues BYTE may produce.
- BYTE Deck:** Subscribers receive five BYTE postcard deck mailings each year—a direct response system for you to obtain information on advertised products through return mail.

To be on the leading edge of microcomputer technology *and* receive all the aforementioned benefits, make a career decision today—complete and mail in a subscription card or, call toll-free weekdays, 8:30am to 4:30pm E.S.T.: 800-258-5485.

*And... welcome to
BYTE country!*

BYTE
THE SMALL SYSTEMS JOURNAL



Make a
career move
today...
Subscribe to
BYTE and
stay on the
leading edge
of micro-
computing
technology.



For direct ordering
call toll free weekdays
8:30am-4:30pm
E.S.T.:

800-258-5485

(603-924-9281 for
New Hampshire
residents)

OR

Complete adjacent
postcard and mail.

Note our special offer:
*Send cash with your order
and receive 13 issues at
the price of 12 for each
year you subscribe (North
America only).*



YES! I want to subscribe to **BYTE
and save 50% off* the cover price.**

U.S. \$21.00 (1 yr.) *Basic subscription rate \$38.00 (2 yrs.) \$55.00 (3 yrs.)
 Canada/Mexico **Europe-Air Delivery** **Worldwide-Surface Delivery**
 \$23.00 U.S. (1 yr.) \$69.00 U.S. (1 yr.) \$37.00 U.S. (1 yr.)

Enclose payment (check or credit card information) and get one extra issue for each year you subscribe (North America only).

- Bill me (North America only)
 Payment enclosed (U.S. funds drawn on a U.S. bank only)
 Charge to my VISA MasterCard



46STSX

Card # _____ Expires _____ Signature _____

Name _____

Address _____

City/State _____ Country _____ Code _____

Please allow 6-8 weeks for processing your subscription



YES! I want to subscribe to **BYTE
and save 50% off* the cover price.**

U.S. \$21.00 (1 yr.) *Basic subscription rate \$38.00 (2 yrs.) \$55.00 (3 yrs.)
 Canada/Mexico **Europe-Air Delivery** **Worldwide-Surface Delivery**
 \$23.00 U.S. (1 yr.) \$69.00 U.S. (1 yr.) \$37.00 U.S. (1 yr.)

Enclose payment (check or credit card information) and get one extra issue for each year you subscribe (North America only).

- Bill me (North America only)
 Payment enclosed (U.S. funds drawn on a U.S. bank only)
 Charge to my VISA MasterCard



46STSX

Card # _____ Expires _____ Signature _____

Name _____

Address _____

City/State _____ Country _____ Code _____

Please allow 6-8 weeks for processing your subscription



YES! I want to subscribe to **BYTE
and save 50% off* the cover price.**

U.S. \$21.00 (1 yr.) *Basic subscription rate \$38.00 (2 yrs.) \$55.00 (3 yrs.)
 Canada/Mexico **Europe-Air Delivery** **Worldwide-Surface Delivery**
 \$23.00 U.S. (1 yr.) \$69.00 U.S. (1 yr.) \$37.00 U.S. (1 yr.)

Enclose payment (check or credit card information) and get one extra issue for each year you subscribe (North America only).

- Bill me (North America only)
 Payment enclosed (U.S. funds drawn on a U.S. bank only)
 Charge to my VISA MasterCard



46STSX

Card # _____ Expires _____ Signature _____

Name _____

Address _____

City/State _____ Country _____ Code _____

Please allow 6-8 weeks for processing your subscription



NO POSTAGE
NECESSARY
IF MAILED
IN THE
UNITED STATES



BUSINESS REPLY MAIL
FIRST CLASS MAIL PERMIT NO. 39 MARTINSVILLE, NJ

POSTAGE WILL BE PAID BY ADDRESSEE

BYTE Subscriptions
PO Box 597
Martinsville, NJ 08836-9956



NO POSTAGE
NECESSARY
IF MAILED
IN THE
UNITED STATES

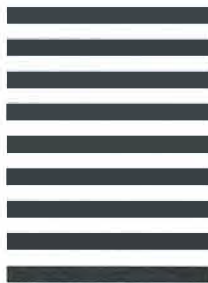

BUSINESS REPLY MAIL
FIRST CLASS MAIL PERMIT NO. 39 MARTINSVILLE, NJ

POSTAGE WILL BE PAID BY ADDRESSEE

BYTE Subscriptions
PO Box 597
Martinsville, NJ 08836-9956



NO POSTAGE
NECESSARY
IF MAILED
IN THE
UNITED STATES



BUSINESS REPLY MAIL
FIRST CLASS MAIL PERMIT NO. 39 MARTINSVILLE, NJ

POSTAGE WILL BE PAID BY ADDRESSEE

BYTE Subscriptions
PO Box 597
Martinsville, NJ 08836-9956



Make a
career move
today...
Subscribe to
BYTE and
stay on the
leading edge
of micro-
computing
technology.



For direct ordering
call toll free weekdays
8:30am-4:30pm
E.S.T. :

800-258-5485

(603-924-9281 for
New Hampshire
residents)

OR

Complete adjacent
postcard and mail.

Note our special offer:
*Send cash with your order
and receive 13 issues at
the price of 12 for each
year you subscribe (North
America only).*

The CLK module

lets you run

counter 0 at

almost any rate.

routine to be executed 18.2 times per second. To run counter 0 at a rate other than 65,536, you need to write an intercept routine that calls the original interrupt routine at the rate of 18.2 times per second. The CLK module lets you run counter 0 at almost any rate.

CLK WALK-THROUGH

The CLK module starts with my ubiquitous VECTOR structure. The DATA segment contains several values. CLKDIV is the interrupt rate that the user desires. CLKDIVH and CLKDIVL are the high and low portions of the current divisor. CLKMOD is the number of 1.19-MHz clock ticks since the last true interrupt 8h. CLKRTN is the user-provided NEAR procedure, to be called on every interrupt 8h. INT08 is the original interrupt 8h vector.

I have defined a STACK segment, even though the SS register is not used, so that the ASSUME SS:STACK statement can be coded. Defining all known segments is a good programming practice.

The CODE segment begins with the proper ASSUMEs and with two EXTRN (external) definitions. In particular, the interrupt routine needs SEGDATA to locate the DATA segment.

CLKRATE is a utility routine that sets the counter 0 divisor value.

CLKPRO is the CLK-module prologue routine. It calls CLKRATE to ensure that counter 0's divisor is set to 65,536. The DATA segment values are initialized, and the current interrupt 8h VECTOR is saved in INT08. Finally, CLKPRO installs CLKINT as the interrupt 8h intercept routine.

CLKEPI is the CLK-module epilogue

(continued)

```

        PUSH    DS
        MOV     AH,025H
        MOV     AL,008H
        MOV     DX,OFFSET CLKINT
        MOV     DS,SEGCODE
        ASSUME DS:CODE
        INT     021H
        POP     DS
        ASSUME DS:DATA
        POP     DX
        POP     AX
        RET
CLKPRO  ENDP
;*****CLKEPI  CLOCK EPILOGUE
CLKEPI  PROC   NEAR
        PUBLIC CLKEPI
        PUSH   AX
        PUSH   DX
;-----RESET CLOCK DIVISOR TO 65536
        XOR    AX,AX
        CALL   CLKRATE
;-----RESET INTERRUPT VECTOR
        PUSH   DS
        MOV    AH,025H
        MOV    AL,008H
        LDS   DX,INT08
        ASSUME DS:NOTHING
        INT   021H
        POP   DS
        ASSUME DS:DATA
        POP   DX
        POP   AX
        RET
CLKEPI  ENDP
;*****INTERRUPT ROUTINES
        ASSUME CS:CODE,DS:NOTHING,ES:NOTHING
        ASSUME SS:NOTHING
;*****CLKINT  CLOCK INTERRUPT INTERCEPT ROUTINE
CLKINT  PROC   FAR
        PUSH   AX
        PUSH   DS
        PUSH   ES
;-----ESTABLISH ADDRESSABILITY
        MOV    DS,SEGDATA
        ASSUME DS:DATA
        MOV    ES,SEGDATA
        ASSUME ES:DATA
;-----DO USER ROUTINE.
        CALL   CLKRTN
;-----CHECK FOR ROLL-OVER OF 65536 CYCLES
        MOV    AX,CLKDIVL
        ADD    CLKMOD,AX
        MOV    AX,CLKDIVH
        ADC    AX,0
        JNZ   CLKINT8
;-----NOT TIME YET, SKIP ORIGINAL INTERRUPT
        MOV    AL,00100000B
        OUT   020H,AL
        JMP   CLKINT7
;-----DO THE ORIGINAL INTERRUPT.
CLKINT8 LABEL  NEAR
        PUSHF
        CALL  INT08
CLKINT7 LABEL  NEAR
;-----CHANGE DIVISOR IF SO REQUESTED
        MOV    AX,CLKDIV

```

(continued)

```

        CMP     AX,CLKDIVL
        JE      CLKINTX
        CALL   CLKRATE
        MOV    CLKDIVL,AX
        CMP    AX,1
        MOV    CLKDIVH,0
        ADC    CLKDIVH,0
CLKINTX LABEL  NEAR
        POP    ES
        ASSUME ES:NOTHING
        POP    DS
        ASSUME DS:NOTHING
        POP    AX
        IRET
CLKINT  ENDP
;*****CLKNUL  INITIAL USER PROVIDED ROUTINE
CLKNUL  PROC   NEAR
        RET
CLKNUL  ENDP
CODE    ENDS
END
    
```

routine. It also calls CLKRATE to ensure a divisor of 65,536. Then, CLKEPI resets the interrupt 8h interrupt vector to its original value.

CLKINT

CLKINT is the CLK-module interrupt-intercept routine where the work is done. Note again that the program initially assumes nothing except CS=CODE. CLKINT establishes the location of the DATA segment and the extra segment by loading DS and ES with SEGDATA. It then calls the user-provided NEAR procedure, whose address is in CLKRTN. If CLKRTN does not finish before the next timer interrupt, an interrupt might be lost because the hardware keeps track of an interrupt's occurrence only—not how many times it has occurred. The current counter's divisor represents the number of 1.19-MHz ticks that have passed since the last interrupt. This value is added to CLKMOD.

A carry indicates a rollover past 65,536. If there is no rollover, the 8259 is notified that the interrupt has been processed. If there is a rollover, the intercepted interrupt 8h is called. In order to call an interrupt routine, you must precede that call with a PUSHF instruction. Finally, the routine checks to see if the user has requested a different divisor since the previous interrupt and, if so, sets the new divisor.

CLKNUL is a null interrupt routine used as the initial value of CLKRTN.

I have used the CLK module for interrupt-driven music at varying tempos and to invoke C procedures as background tasks. Unfortunately, a full-blown example of its use is beyond the scope of this article. However, the DEMO program described below hints at some of its potential uses.

DEMO

Listing 4, DEMO.ASM, is a program that graphically verifies the operation of the CLK module. It writes characters to the top line of the screen until you press the Escape key. The characters are displayed left to right until

Listing 4: Source code for the DEMO program.

```

;=====VECTOR STRUCTURE
VECTOR  STRUC
REGIP   DW      ?
REGCS   DW      ?
VECTOR  ENDS
;=====PSP SEGMENT
PSP     SEGMENT AT 0FFFFH
; PROGRAM SEGMENT PREFIX
        INCLUDE PSP.INC
PSP     ENDS
;=====DATA SEGMENT
DATA    SEGMENT PUBLIC 'DATA'
        EXTRN  CLKDIV:WORD
        EXTRN  CLKRTN:WORD
COL     DB      0           ;COLUMN
DIR     DB      1           ;DIRECTION
LEFT    DB      ?           ;NUMBER LEFT
COLS    DB      ?           ;LAST COLUMN (0 RELATIVE)
SPEED   DW      1000000000000000B ;SPEED MASK
DEEPS   DW      0000000000000001B ;BACKWARDS!
DATA    ENDS
;=====STACK SEGMENT
STACK   SEGMENT STACK 'STACK'
        DW      128 DUP(?)
STACK   ENDS
;=====CODE SEGMENT
CODE    SEGMENT PUBLIC 'CODE'
        ASSUME CS:CODE,DS:PSP,ES:PSP,SS:STACK
        EXTRN  CLKEPI:NEAR
        EXTRN  CLKPRO:NEAR
DOSCALL VECTOR <> ;WILL POINT TO
                ; PSP:DOS_CALL

SEGCODE DW      CODE ;CODE SEGMENT
PUBLIC  SEGCODE
SEGDATA DW      DATA ;DATA SEGMENT
PUBLIC  SEGDATA
IP      LABEL   NEAR ;EXECUTION STARTS HERE
    
```

(continued)

(continued)

COMPUTER INNOVATIONS

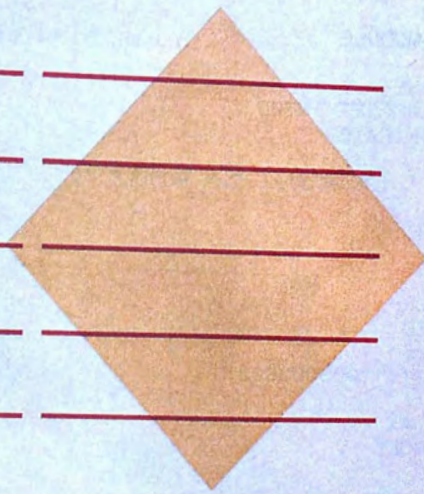

C86 **PLUS**
C COMPILER

86 PLUS
REFERENCE MANUAL

SUPREMACY.

С СОМПИЛЕР

C86 **PLUS**

```

;-----SETUP DOSCALL VECTOR
MOV     DOSCALL.REGIP,OFFSET DOS_CALL
MOV     DOSCALL.REGCS,DS
;-----SETUP DS AND ES REGISTERS
MOV     ES,SEGDATA
ASSUME  ES:DATA
MOV     DS,SEGDATA
ASSUME  DS:DATA
;-----DETERMINE LAST COLUMN
MOV     AH,00FH
INT     010H
DEC     AH
MOV     COLS,AH
MOV     LEFT,AH
;-----INITIALIZE CLK MODULE
CALL    CLKPRO
;-----SET CLOCK ROUTINE
MOV     CLKRTN,OFFSET INT08
JMP     SHORT SETRATE
MAINX   LABEL   NEAR
CALL    CLKEPI    ;DEINSTALL CLK MODULE
;-----RETURN TO DOS
MOV     AH,000H
CALL    DOSCALL
;-----SET CLK RATE
SETRATE LABEL   NEAR
MOV     AX,SPEED
OR      AX,DEEPS
AND     AX,1111111100000000B
SHL    AX,1
MOV     CLKDIV,AX
;-----WAIT FOR KEYSTROKE
KEY     LABEL   NEAR
MOV     AH,0
INT     016H
CMP     AL,01BH
JE      MAINX           ;EXIT ON ESCAPE
ROR     SPEED,1        ;OTHERWISE,
ROL     DEEPS,1        ;CHANGE SPEED
JMP     SETRATE
;*****INTERRUPT ROUTINE
ASSUME  CS:CODE,DS:DATA,ES:DATA,SS:NOTHING
; NEAR PROC CALLED BY INT08
INT08   PROC    NEAR
PUSH    AX
PUSH    BX
PUSH    CX
PUSH    DX
PUSH    BP
PUSH    SI
PUSH    DI
;-----POSITION CURSOR
MOV     AH,002H
MOV     BH,0
MOV     DH,0
MOV     DL,COL
INT     010H
;-----DERIVE CHARACTER FROM TIME OF DAY
MOV     AH,0
INT     01AH
MOV     AL,DL
AND     AL,00111111B
ADD     AL,' '
;-----PUT CHARACTER ON THE SCREEN
MOV     AH,00AH

```

(continued)

*When the clock rate
is 36.4 Hz, each
character shows twice.*

the right edge is reached and right to left until the left edge is reached. Any keystroke other than an Escape causes the rate to change. The first eight keystrokes double the rate until it reaches a frequency of 2329.6 Hz. The next eight keystrokes halve the rate until it returns to 18.2 Hz.

The character to display is chosen from the lower-order bits of the system clock. Since the system clock runs at a rate of 18.2 Hz, the initial output is of consecutive characters in the ASCII collating sequence. When the rate is increased to 36.4 Hz, each character shows twice. This verifies that the system clock is still running at the proper 18.2-Hz rate.

DEMO WALK-THROUGH

Execution begins at the LABEL IP. The first two statements set up a VECTOR called DOSCALL that points to PSP:DOS_CALL. This documented but seldom-used field in the PSP consists of an INT 021H and a FAR RET. Calling this VECTOR causes an INT 021H to be executed with the CS register set to the PSP. Since calling PSP:DOS_CALL meets all the requirements of DOS functions 0h (program terminate) and 31h (terminate process and remain resident), you never need to use INT 020H or INT 027H. It is possible to make an .EXE file resident using this technique.

At initialization, DEMO sets up the segment registers and determines the last display column. It then calls the CLK prologue routine and informs the CLK module that INT08 is the routine to be called at the rate determined by CLKDIV.

CLKDIV

CLKDIV is derived from SPEED and DEEPS using some unnecessary but fun bit-twiddling. SPEED contains a

(continued)

SUBSTANTIATED.

SUPREMACY

It's a bold claim. A claim we're prepared to stake our reputation on. And at Computer Innovations, we've always taken our reputation very seriously.

It's no industry secret that the competitive C Compilers are at the end of their optimization cycle — they're just about as good as they are going to get. C86PLUS begins where everybody else has left off. It's an entirely new technology based on artificial intelligence and advanced compiler design techniques. Designed with the serious programmer in mind, C86PLUS provides the ultimate development environment, matching unparalleled execution speed with a host of productivity features.

FAST EXECUTION

- 20% faster than Microsoft C, version 4.0
- 70% faster than existing C86, version 2.3 (timings based on the classic sieve benchmark)

ANSI C COMPILER FEATURES

- Register variables
- Structure assignment
- Function prototypes
- New type modifiers
 - near
 - far
 - signed
 - const
 - volatile
- Long double 80 bit floating-point
- Enumerator data types (enums)
- Extended preprocessor capabilities

FULL CONTROL OVER COMPILATION ENVIRONMENT

- Small, Medium, and Large memory models
- 8086/80186 and 80286 code generation options
- In-line 8087/80287 floating point
- 8087/80287 auto detect emulator
- Source level debugger support
- Wild-card compilation
- Make utility
- ROMable code
- Linkable with macro assembler output
- Intel-standard OMF object files
- Optional assembly language output
- Warning level control

EXTENSIVE FUNCTION LIBRARIES FOR INCREASED PRODUCTIVITY

- Over 250 library functions
- Full ANSI C library
- Functional equivalents to most UNIX System V libraries
- Shared file and network support
- Low-level machine access functions
- IBM ROM BIOS support routines
- Fully compiled small, medium and large model libraries
- C library source code
- Run-time start-up source code
- Source code librarian
- Object code librarian

MICROSOFT COMPATIBILITY

If you're a current Microsoft user, we invite you to consider this simple point. C86PLUS will recompile most applications developed using MS-C without changes to your source code. You'll find that your application runs much faster.

PROVEN EXPERIENCE

In 1981, Computer Innovations and its founder, George Eberhardt, revolutionized the DOS programming world with the introduction of the first C Compiler for the PC called C86. Today, C86 boasts a satisfied and loyal user base of over 20,000 programmers worldwide. C86PLUS represents an extension of this expertise and reputation. It's backed with more than a decade of intensive research and development.

PROVEN SUPPORT

Making the claim that C86PLUS is supreme is one thing, standing behind it is another. Computer Innovations has always offered timely and intelligent technical support, and this is an important customer service which we do not intend to change.

CALL TO ORDER

The call is on us. For more information or to order call:
800-922-0169
or **201-542-5920** (in NJ)



C86PLUS™
COMPUTER
INNOVATIONS

980 Shrewsbury Ave.
Tinton Falls, NJ 07724, USA
Telex: 705127 COMP INNOV UD

C86 PLUS is a trademark of Computer Innovations, Inc.
Microsoft is a registered trademark of Microsoft Corporation.
UNIX is a registered trademark of AT&T Bell Laboratories. IBM
is a registered trademark of International Business Machines
Corporation.

©1986 Computer Innovations, Inc.

See us at
COMDEX/Fall '86
November 10-14, 1986
Las Vegas Convention Center
Las Vegas, Nevada
Booth #454

Inquiry 69

**MAKE YOUR PC
SEEM LIKE AN AT!**

**MAKE YOUR AT
SEEM LIKE A
DREAM MACHINE!**

FANSI- CONSOLE™

The Integrated Console Utility™
**FAST, POWERFUL
ANSI.SYS REPLACEMENT**

For the IBM-PC, AT, and clones

New Version 2.00 is **MUCH FASTER!**
Now blink free scrolling on CGA!

**GET A BOX FULL OF UTILITIES!
MAKE LIFE EASIER FOR ONLY \$75!**

- Speed up your screenwriting 2-6x
- Extend your ANSI.SYS to full VT100
- Add many more escape sequences
- Scroll lines back onto screen
- Save scrolled lines into a file
- Add zip to your cursor keys
- Free your eyes from scroll blinking
- Easy installation
- Get a 43 line screen w/EGA
- Get a 50 line screen w/CGA
- No more annoying typeahead beep
- Prevent screen phosphor burnin
- Control many programs' use of color
- Generate breakpts from keyboard
- Shorten that annoying bell
- Over 40 other useful options

*"The psychological difference is
astounding"*
—Lotus June 85 pg 8.

*"So many handy functions rolled into
one unobtrusive package"*
—PC-World Feb 86 pg 282.

*"The support provided by the
publishers is extraordinary"*
—Capital PC Monitor May 86 pg 25.

*"... the best choice for improving your
console ..."*
—Capital PC Monitor June 86 pg 282.
400p Manual (w/slip case) & disks \$75.

**Satisfaction Guaranteed!
Order Yours Today!**

HERSEY MICRO CONSULTING
Box 8276, Ann Arbor, MI 48107
(313) 994-3259 VISA/MC/Amex



```

MOV     BH,0
MOV     CX,1
INT     010H
;-----UPDATE COLUMN
MOV     AL,DIR
ADD     COL,AL
DEC     LEFT
JNZ     SHOWX
NEG     DIR
MOV     AL,COLS
MOV     LEFT,AL
SHOWX  LABEL NEAR
POP     DI
POP     SI
POP     BP
POP     DX
POP     CX
POP     BX
POP     AX
RET
INT08  ENDP
CODE   ENDS
END     IP
    
```

single bit and is rotated right on each keystroke. DEEPS is the reverse of SPEED; it contains a single bit (which is the mirror image of SPEED) that is rotated left on each keystroke. When SPEED and DEEPS are combined via an OR operation, a single bit is in each byte. To set CLKDIV, the program isolates the upper byte and doubles its value. This produces divisors from 10000 down to 02000 hexadecimal in powers of two.

MAIN LOOP

The main loop processes keystrokes. If the keystroke is not an Escape, it cycles CLKDIV as described above. If the keystroke is an Escape, it calls the CLK prologue routine and the program is terminated.

INT08

When INT08 is called, it first pushes all registers. BP, SI, and DI are pushed because INT 010H does not preserve these registers. Next, the routine positions the cursor and derives the character to be displayed from the time of day. It sends this character to the CRT and updates the column number. Finally, INT08 restores all the registers and returns control to the CLK

module.

I have used only BIOS interrupts in this program because it is difficult to use DOS interrupts within a hardware-interrupt routine. This is because DOS is not reentrant.

ASSEMBLING DEMO

The steps in assembling DEMO are

```

MASM  DEMO;
LINK  DEMO+CLK;
    
```

To execute the DEMO program, simply enter DEMO.

CONCLUSION

In this article, I have covered the major aspects of writing interrupt routines for the IBM PC family. You should be able to successfully tackle writing your own interrupt routines by building on this foundation. ■

BIBLIOGRAPHY

- Disk Operating System *Technical Reference*. Boca Raton, FL: IBM Corporation, 1985.
- iAPX 86.88 *User's Manual*. Santa Clara, CA: Intel Corporation, 1981.
- MCS-85 *User's Manual*. Santa Clara, CA: Intel Corporation, 1977.
- Technical Reference Personal Computer AT*. Boca Raton, FL: IBM Corporation, 1984.

MORE OF THE BEST FROM MICRO MART AMERICA'S PC SPECIALIST!

Proline 286

- 80286 processor
- 10 MHZ
- 256K standard (up to 1MB)
- Video graphics card
- AT-style keyboard
- BIOS guaranteed
- 8 total expansion slots
- FCC licensed & UL approved

Color Graphics System \$1,449.00
Mono Graphics System \$1,495.00



Proline AT

- 80286 processor
- 8 MHZ
- 360K floppy drive
- 512K standard (up to 1MB)
- Video graphics card
- 12 total expansion slots
- BIOS guaranteed
- FCC licensed & UL approved

Color Graphics System \$1,925.00
Mono Graphics System \$1,975.00



Proline XT

- 8088-2 processor
- 4.77 MHZ - 8 MHZ
- 256K standard (up to 640K)
- AT-style keyboard
- Video graphics card
- 8 total expansion slots
- BIOS guaranteed
- FCC licensed & UL approved

Color Graphics System \$549.00
Mono Graphics System \$599.00



Monitor not included with PROLINE desk top systems, but we'll be glad to configure any system to your specific needs!!

We have a complete line of Multifunction Boards compatible with the PC, XT & AT and all compatibles.

- AST SIX PAK, loaded w/384K \$209
- AST I/O MINI, short bd, serial, parallel, clock CALL
- QUADRAM Gold Quadboard, 384K, optional 2nd serial & parallel ports \$439
- TALLTREE J-RAM II and III From \$125
- INTELABOVEBOARD, PC & AT, NEW! From \$235
- THESEY FASTCARD up to 1 MB, Password Security for PC From \$219

CARD!

- AST Preview, Hercules mono compatible CALL
- HERCULES Mono & Color Graphics Card New Low Price!
- TECMAR Graphics Master, HiRes Color & Mono supports Lotus CALL
- QUADRAM Quadcolor I & II color card \$299
- QUADRAM EGA, Includes 256K displa \$351
- STB EGA + with 256K display buffer \$299
- STB Mono & Graphics Cards available.
- Generic monographic cards \$99
- SIGMA Color 400 for PGSSR New Low Price!
- PARADISE Multidisplay, mo \$195
- VIDEO 7 Vega EGA, best er graphics buy \$309

- \$429
- \$529
- SYSGEN Complete line Call for our syngen pricing!
- BERNOULLI TECHNOLOGY Hd disc Su (20 & 40MB) From \$2095
- SEAGATE 20 & 30 Meg. for PC/XT & PC/AT CALL
- PRIAM 40MB voice coil superfast hard drive \$1249
- PRIAM 60MB voice coil superfast hard drive \$1595
- TALLGRASS 25 through 80 MB Hard drive sub: including 60MB tape back-up
- WESTERN DIGITAL 10MB File card
- WESTERN DIGITAL 20MB File card

SOFTWARE

ACCOUNTING

- SORCIM/IU ncluding windows From \$295 each

SPREADSHEETS & INTEGRATED PACKAGES

- SORCIM/IUS SuperCALC 3, Vers. 2.1 \$209
- SORCIM/IUS SuperCALC 4 NEW

ENHANCEMENTS & IES

- NORTON Utilities 3.1 \$50
- ROSESOFT ProKey 3.0 \$79
- COPY II PC \$22
- SOFTSTYLE Set FX+ and Printw nter control
- SIDEWAYS Inverts printout \$35
- BORLAND SideKick \$32
- BORLAND Superkey \$42
- BORLAND Lightning \$59

COMPILERS & LANGUAGE TOOLS

- LATTICE C-Compiler \$249
- MICROSOFT Complete line CALL
- MICROSOFT Quick-Basic \$65
- BORLAND Turbo Pascal, Toolb & more From \$35/each

GRAPHICS

- Z-SOFT PC Paintbrush, mouse graphics \$69
- DECISION RESOURCES Diagram Master CALL

- DECISION RESOURCES Sign Master \$149
- DECISION RESOURCES Chart Master \$219
- DECISION RESOURCES Map Master \$239
- MICROSOFT Chart \$189
- MICROSOFT Windows \$65

COMMUNICATIONS

- MICROSTUF Crosstalk XVI, Latest version \$95
- HAYES Smartcom II \$85
- MICROSOFT Access with windows \$159

WORD PROCESSING

- MULTIMATE Advantage \$279
- MICROSOFT Word, version 3.0 \$257
- VOLKSWRITER, ver 3.0 \$159
- SSI WordPerfect, version 4.1 \$229
- MICROPRO Wordstar Professional \$229
- MICROPRO Wordstar 2000 \$229
- MICROPRO Wordstar 2000 Plus \$279

OFFICE & PLANNING

- HARVARD Total Project Manager CALL
- SORCIM/IUS Super Project \$212
- MICROSOFT Project, vers. 2.0 CALL

DATA BASE MANAGERS

- Call For Unadvertised Data Base Managers
- MICROMOR Report Writer & Clout CALL
- MICROMOR R-BASE 5000 \$379
- MICROMOR R-BASE System 5 CALL
- MICROSTUF Infoscope \$99
- D BASE III PLUS CALL!

PROTOCOL CONVERSION

- SNA & BISYNC 3780, 5251, Mod 11 & 12, 3274, 3278 In Stock!
- IRMA Complete line From \$825

NETWORKING

- DNET IX com
- HID PC Net c

PRINTERS

- Complete line of EPS Special!
- EPSON FX-85 \$389
- OKIDATA 192, 193, CALL
- OKIDATA 292 \$449
- OKIDATA 293 \$579

- TOSHIBA P-341 \$789
- TOSHIBA P-351 \$1019
- NEC P-5, P-6, & I w Prices
- DATAPRODUCT \$1175

LETTER QUALITY

- NEC Spinwriters 2050 \$619
- NEC Spinwriters 3550 \$729
- NEC Spinwriters 8850 \$1049
- EPSON DX-20 \$319
- EPSON DX-35 \$639
- LQ Laser printers available CALL

We carry a full range of form handling op

- All our chips are tested and pr le. Call us!
- INTEL 8087-2, 8087-3, 80287 From \$112
- 64K RAM CHIPS for Market Price.
- 128K RAM CHIPS for Market Price.
- TECK RAM CHIPS for Market Price.

- HAYES Smartmodem 300, 1200, 1200B & 2400. We have the best stock in the USA CALL!
- PEACHTREE TECHNOLOGIES P-1200 (Hayes compatible external) \$239
- ANCHOR Signalman Express (300-1200 baud external) \$249

- PGS Max 12(E), HX12, HX12 & SR-12 Low Price
- AMDEK Color 600, 640 x 20 IBM standard res. \$389
- AMDEK Color 722 \$499
- AMDEK 310A amber monocl CALL
- MAGNAVOX amber monoch \$99
- SONY 9" portable color \$399
- SONY 12" & 13" (RGB/TV) In stock

- MOUSE SYSTEMS Mouse, optical mouse \$125
- MICROSOFT Mouse, busor serial \$135
- KEYTRONICS 5151 Keybdsfor IBM & AT&T \$169
- QUADRAM Microfazer print buffer, 8-128K From \$125
- GRAVIS Joystick \$35

We have a full line of accessories, ribbons, diskettes, dust covers, flip 'n' files, printer stands, switch boxes, and surge protectors in stock!!!

Due to continuing market fluctuations, pricing may drop daily.
Call for most current prices!!

(404) 449-8089 Orders Only 1-800-241-8149



America's PC Specialist

© Copyright 1986, Micro Mart, Inc. Technology Corporate Campus 3159 Campus Drive, Norcross, GA 30071
Prices and availability are subject to change without notice and are similar, but may vary at Micro Mart Retail Stores.

HOW FAST CAN THE 80386 MAKE YOUR WORKSTATION GO?

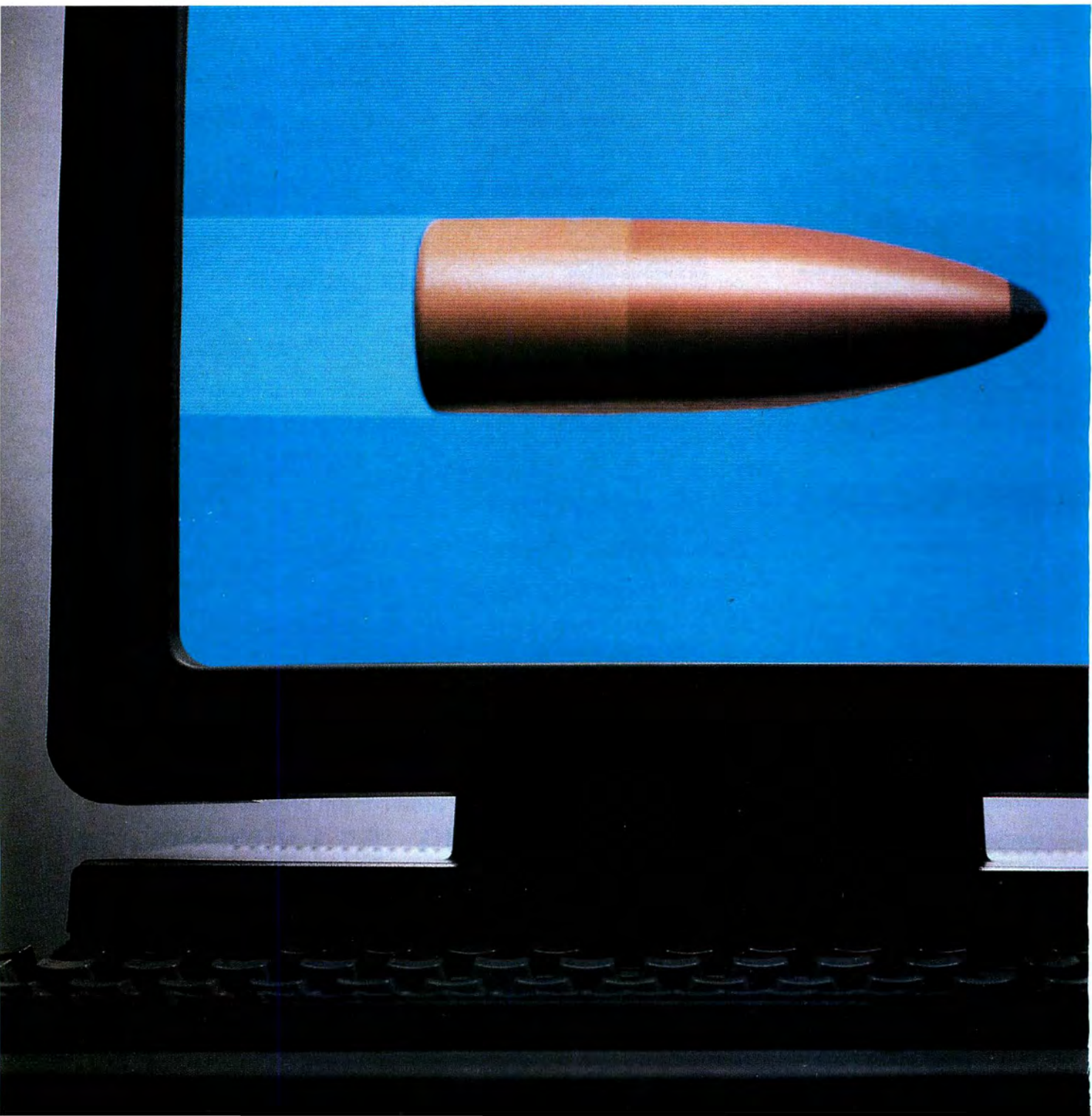

Faster than any other 32-bit microprocessor can.

In technical terms that's 4 MIPS. 4 MegaWhetstones. With 4 Gigabytes.

Fast enough to have a sudden and lethal impact on your competition.

To achieve its blazing speed, the 80386 has six-stage pipelining, which

allows the standard 16 MHz part to deliver over 6100 Dhrystones per second.

That's nearly four times the Dhrystone performance of a VAX*11/780, or 4 VAX MIPS.

And with the 80386 you don't sacrifice all that performance for demand-paged virtual memory. Because of its on-chip paging unit and transparent paging cache, the 80386 can do a full virtual to physical address translation without the performance penalty of non-pipelined, off-chip designs. Giving you 4 MIPS of deliverable UNIX** performance.

Of course, to achieve performance like that, you need a bus that's faster than a speeding bullet.

Like our 2 clock bus that provides a 32 Megabytes per second transfer rate.

That's the highest performance of any microprocessor bus.

So what more could advanced system designers ask for?

Blistering 4 Mega-Whetstones per second performance for superb graphics and number crunching. Only the 80386 uniquely teams with Weitek's 1167 floating point coprocessor to deliver the highest numerics

performance on the market.

And of course all this comes in a 64 Terabyte virtual address space with a 4 Gigabyte linear address space.

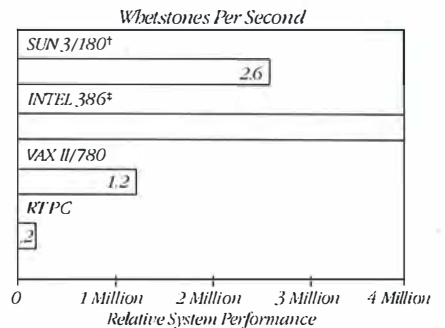
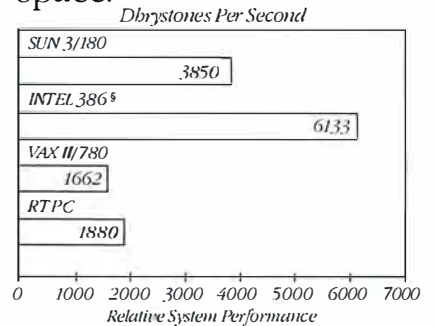

[§] Intel 386 MULTIBUS*1 16MHz Starter Kit.
[†] With Weitek 1164, 1165 floating point chip set.
[‡] With Weitek 1167 floating point coprocessor.
Source: Refer to Intel 80386 Benchmark Report.

Finally, for your silver bullet, add to all this \$6 billion worth of DOS software. And watch how fast it runs on your 4 MIPS, 4 MegaWhetstones UNIX machine.

To find out more, attend one of our 80386 Seminars. Call your local Intel sales office for details.

Or call (800) 548-4725 for complete technical information.

Get all the ammunition you need to make your next system a success.

intel[®]

*VAX is a registered trademark of Digital Equipment Corp.

**UNIX is a trademark of AT&T Bell Laboratories.

© 1986 Intel Corporation



NEC'S PINWRITER P5XL HAS MADE BLACK A PRIMARY COLOR.

Our Pinwriter® P5XL printer has changed forever the way people look at dot matrix printing.

It's the first 24-pin dot matrix printer to use a letter-quality multistrike film ribbon—the same ribbon used in typewriters and letter-quality printers, such as our Spinwriter®. So for the first time in computer history there is a printer that honestly does everything. A printer that produces important letters and documents with crisp, black, true letter-quality printing. But with all the speed and graphics capability dot matrix printers are known for.

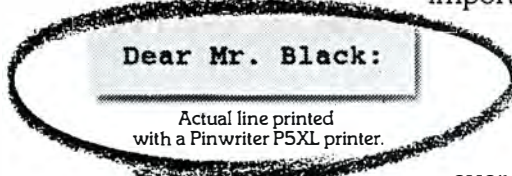

Fast, black letter-quality printing will be the primary reason many people will buy a P5XL printer. But there are plenty of other good reasons. In fact, it's the most versatile printer ever created for personal computers.

It can use an optional ribbon to print seven other colors plus black. And it has the best graphics resolution of any impact printer you can buy, due in part to our advanced 24-pin printhead. Plus it can print more type faces automatically than any other dot matrix printer. And it's quiet and fast.

You can also expect a P5XL printer to turn out millions of characters before it will need service because it has the highest reliability rating in the industry. And there's a nationwide network of NEC Customer Service Centers to take care of maintenance.

Now, while the Pinwriter P5XL performs a little black magic, you won't have to go in the red to buy it.

The Pinwriter P5XL is the latest addition to the most advanced and extensive family of 24-pin printers available. See it at your dealer or for an information package that includes actual print samples, call 1-800-343-4418 (in MA 617-264-8635).

Or write: NEC Information Systems, Dept. 1610, 1414 Massachusetts Ave., Boxborough, MA 01719.



NEC PRINTERS. THEY ONLY STOP WHEN YOU WANT THEM TO.

NEC
NEC Information Systems, Inc.

Inquiry 207

C&C Computers and Communications

The chevrons and serpentine designs are registered trademarks of Binney and Smith Inc., used with permission.

C VERSUS ASSEMBLY— C PLUS ASSEMBLY

C provides portability and assembly functionality without the pitfalls of assembly code

BY TOM HOGAN

IS C A BETTER choice than assembly language for professional programming tasks? C has a reputation for being portable, easy to write, very fast, and difficult to maintain. Assembly has a reputation for being compact, difficult to write, lightning fast, and impossible to maintain.

While the reputations of C and assembly language have some factual basis, it is easy to find examples that don't fit them. Some C programs are definitely not portable, and some C applications run faster than others written in assembly. Assembly can be written to be readable, as can C (see "Easy C" by Pete Orlin and John Heath, May BYTE). This discussion should clarify matters.

My bias is in favor of C because applications can be written more quickly with C than with assembly. My experience is in developing a C graphics library for the IBM PC. Since the hardware is barely adequate for real-time low-resolution graphics applications, I had to write some assembly code to get acceptable performance. In doing this, I became familiar with the C-to-assembly language interface.

I will compare C with assembly by discussing their relative speed, the suitability of one versus the other for complex applications, real-world products that were written in each language, the comparative popularity of products written in each, which ap-

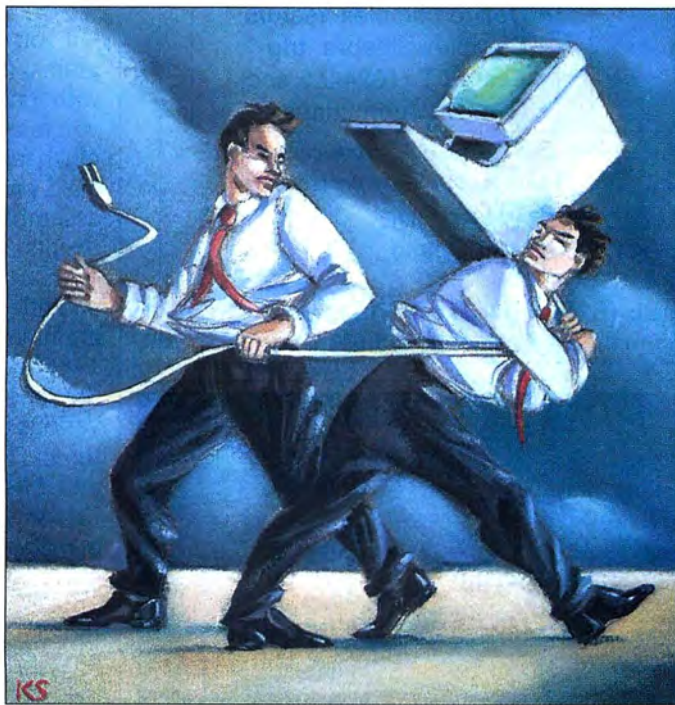

plications absolutely require assembly language, and techniques to help you write assembly functions to work with your C programs.

C's portability is one of its supposed advantages over other languages. Assembly language is not portable, although cross-assemblers can aid in moving code to new architectures. High-level languages like FORTRAN and Pascal have built-in I/O capabilities that limit their portability. C lacks any I/O functions, but every C compiler I am aware of comes with a library that supplies these.

A bigger problem with high-level languages is that most compilers are supersets of the language. If a programmer relies heavily on a compiler's nonstandard features, it is not going

to port easily to another compiler. C avoids this by not including much in the language. If a programmer needs a special function, he writes it himself or buys a commercial library package.

One dilemma C programmers often face is whether to sacrifice speed or portability. If the application must run independently of the hardware (under UNIX, for example), portability is more important. If the application is written for a single architecture, speed is the priority.

C programs are not necessarily portable, but you can write them to be portable, and you must take great care to ensure this.

Generally, you reduce a program's portability if you introduce assembly language to improve its speed. The resources and overhead of MS-DOS, for example, are too limiting for highly interactive commercial applications to rely on them (or on the standard library that relies on them), so assembly language is used for video output instead of MS-DOS routines. For example, writing text through DOS is much too slow when you have to update an entire screen for a full-screen editor.

(continued)

Tom Hogan (C Source Inc., 12801 Frost Rd., Kansas City, MO 64138) is a senior programmer using assembly and various C compilers. His interests are war and fantasy games and computer-game design.

Array processing subroutines and 8087 speed
For IBM PC/XT/AT or Compatible.

\$130

Introducing **VECTOR87**

A building-block math subroutine library* of 312 assembly vector and matrix functions for your BASICA interpreter with:



✓ **HIGH SPEED & LOW COST**

- Native 8087 assembly code
- 20-50 fold speed increase
- Faster than compilers
- Less than 50¢ each

✓ **VECTOR MATH**

- Algebra & transcendentals
- Statistics, polynomials
- Data merges, comparisons
- Histograms, logic

✓ **MATRIX & ARRAY MATH**

- Inverse, transpose
- Matrix multiply
- Linear equations
- Matrix to vector map

✓ **COMPLEX VARIABLES**

- Define complex vectors
- Complex algebra, trig
- Fast FFT (1024-2.5 sec)
- Over 40 subroutines

* Loads outside BASICA, requires 8087 or 80287 coprocessor and 256K memory, "CALL" from BASICA, not copy protected



MAGIC SOFTWARE, INC.
7941 Paseo del Ocaso
La Jolla, CA 92037

To order VECTOR87 call: (619) 454-3750, VISA, MC, AE
\$130 (2 disks + manual), CA Residents add 6% tax

**C VERSUS
ASSEMBLY**

*Comparing C programs
written for speed
with assembly
programs produces
mixed results.*

If you compare well-behaved C programs (such as UNIX applications) with programs written in assembly, you might conclude that assembly is much faster than C. However, comparing C programs written for speed with assembly programs produces mixed results.

An article written by Mark Edwards and titled "Programming Editors, Programmable Editors" in the November 1985 issue of Dr. Dobb's Journal rated the speed of different editors for various applications. The editors written in C included BRIEF, EC, EMACS, and Epsilon. [Editor's note: BRIEF and Epsilon are written primarily in C with assembly routines to optimize performance. EC and EMACS are written entirely in C.] Those written in assembly were Pmate, VEDIT PLUS, and XyWrite II Plus. Editors written in C had by far the fastest times in the following categories: search and replace (EC), change ASM comments to C (EMACS), and brace count macro (BRIEF). In file I/O, XyWrite came in first, followed closely by Epsilon, with the rest of the editors quite far behind. Pmate had the fastest load time, although EC was a not-too-distant second.

In the macro benchmark, editors written in assembly were at least an order of magnitude slower than the editors written in C that took first and second place. Screen handling had a three-way tie for first place with a C editor and two assembly editors.

The upshot of all this is that the language in which a program is written matters less than its implementation where speed is concerned. The

(continued)

**The Personal
EE/EPROM
Programmer**

FOR YOUR
IBM P.C.

\$395.00

PLUS POSTAGE
& HANDLING

*With Shooter
You Aim Low
in Price and High
in Quality!*

- RS-232 Port. Works with any computer or terminal.
- Stand-Alone. Copies & verifies.
- 128K RAM Buffer.
- Upload / Download in Intel or Motorola Hex format.
- 90 Day Warranty.
- UV Erasers from \$49.95.



1-800-EE1-PROM (331-7766)
FLA. (305) 974-0967 • TELEX: 383142 LOGICALTX
1321E N.W. 65th PLACE, FT. LAUDERDALE, FL 33309

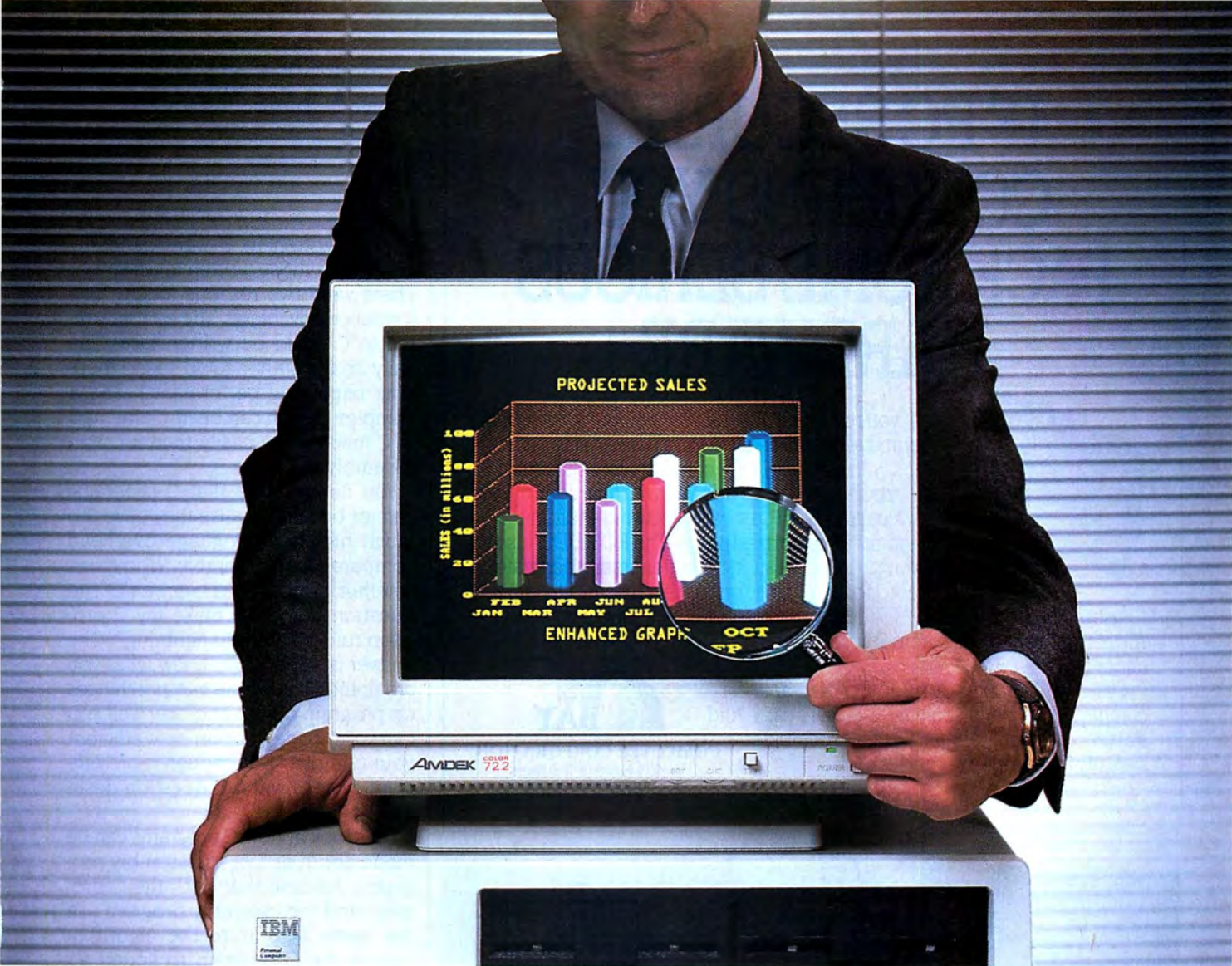

Amdek challenges you to read between the lines.

Not all monitors are created equal. And no monitor in this price range can equal the new Amdek Color 722.

What makes the 722 RGB monitor so distinctive? For one, a dual frequency output that is capable of supporting IBM's Enhanced Graphics Adaptor. The result is 350 lines of resolution, assuring you of a sharper, crisper image that makes your graphs and charts look more like a work of art, and less like a rough sketch. For another, the fact that the 722 is made by Amdek — where monitors are our only line, not just a sideline.

The high performance 722 features an etched glass, non-glare screen that's easy on the eyes, plus front-mounted controls that are easy on the operator. This means less eye fatigue and greater productivity.

All 350 of 'em.

What's more, the 3-position text switch enables you to choose green, amber or full-color type — up to

80 characters in width x 25 lines of text. There's even an optional tilt/swivel stand that allows you to select a viewing angle that's most comfortable for you.

It all adds up to more monitor for the money, and is backed by more warranty for your peace of mind. Amdek's warranty protects your investment for three full years on the CRT, and two years on all other parts and labor. No other monitor warranty offers you more.

For high resolution performance, see the new Amdek Color 722. We know you'll be impressed. After all, everytime an Amdek monitor is sold, we know that we are putting our image on the line.

AMDEK

Inquiry 13

Clearly the finest in monitors.

IF PC SECURITY CONCERNS YOU, PACK SOME SERIOUS HARDWARE.

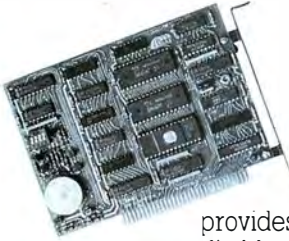

If you're responsible for your company's personal computer resources, you should be arming each unit with a PC/AUDIT™ card from Bay Computer Corporation. It'll provide you with total control over valuable PC resources by securing each unit against unauthorized usage. The PC/AUDIT also provides comprehensive audit trails, generating accurate and auditable records of work performed. It's transparent to your users, and fits any IBM PC, XT, AT, portable, or PC compatible computer. All this and more in one tamperproof half board package. And all for under \$250.00.

Call Bay Computer Corp. at (617) 470-3748 for complete information on the PC/AUDIT card. And start shooting for optimum personal computer security and productivity.

Dealer inquiries welcome.



COMPUTER CORPORATION
York & Haverhill Streets
Andover, MA 01810
(617) 470-3748

C VERSUS ASSEMBLY

editors written in C were generally faster than those written in assembly. There were two reasons for the performance advantage: The editors written in C could be written faster initially, so the author could spend more time improving performance; and a complex design can be implemented in C much more easily than it can in assembly.

You might argue that C programs cannot be fast because they have too much high-level language overhead compared with assembly. Who cares whether or not C has overhead? The question is, "Can I make my C program run like greased lightning?" The answer is, "Yes, if you know what you are doing." The whole question hinges on program design and how well you can write code—not on how efficient your compiler is (although more efficient code is without question desirable).

Let's look at how C programs can be made about as fast as assembly programs. Assume that both the C program and the assembly program use the same algorithm, the algorithm causes the C program to spend 95 percent of its time in 5 percent of the code, and the C program is unacceptably slow. An experienced C programmer can rewrite the time-intensive 5 percent of the C code in assembly, often achieving a several-fold improvement in performance. Thus, the final program will run about as fast as if it had been written entirely in assembly.

In the world of commercial applications, speed is often crucial to success. Part of the reason for the success of Turbo Pascal (written in assembly) is that it is more fun to use than competitive products. Today, people complain that WordStar 2000 (written in C) is slower than the original WordStar (cross-assembled from 8080 assembly), although WordStar 2000 does a lot more.

Assembly advocates tout early successes like dBASE II and WordStar to show that the most popular programs are written in assembly. I submit that assembly was used because it was the

(continued)

Powerful InCircuit Emulation, Priced Within Your Budget. That's NICE™

Remember the NICE™ Z80? Nicolet has added a "+" to give you full speed, real-time execution, operation up to 8 MHz, 16 hardware breakpoints, 8k of overlay RAM, histograms and loading of Intel Hex Code. It even works with the new Z80C microprocessors.

Designed for system development, troubleshooting, debugging or testing in the lab, field, or at home, the NICE Z80+ simply plugs directly into the target microprocessor socket and any RS-232 terminal or terminal emulator.



At \$1295* the NICE Z80+ gives you the best emulator price/performance available. For info call 800-NICOLET X259 (outside California) or 415 490-8300 X278 (in California).



Send check, money order, or VISA/MasterCard to Nicolet, 201 Fourier, Fremont, Ca. 94539. C.O.D.s accepted.

*Other NICE emulators for the Z80, 8085, 8088 and NSC800 start at \$550 (68000 available Q1 '86). NICE is a trademark of Nicolet, Digital Systems Division. Z80 is a trademark of Zilog, Inc.

TRANSEC NEW PRODUCTS

Program Review:

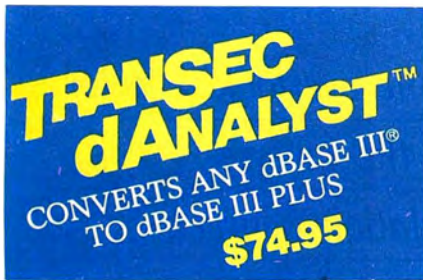

Makes dBASE Easier to Program, Reduces Logic Errors, Bugs

TranSec dANALYST™ automatically converts any dBASE III program to dBASE III PLUS with true record and file locking for multi-user operation. Features include syntax/blocking analysis, tabbed file output, variable cross reference. Framework-type interface command windows, pop-up menus, graphic analysis REPORTS menu. Saves programmer's time to analyze and debug dBASE II, III, or PLUS. Supports multi-user Clipper and network version of WordTech. Not copy protected. Rated a "best buy."

TranSec dANALYST™ \$74.95 plus \$5 s/h
TO ORDER: 1-800-423-0772 VISA/MC
IN FL: 1-305-474-7548

Program Review:



Simplify Naming, Finding Your Files with 32-Character File Names

TranSec PCEasy™ is a new easy-to-use "office environment" file management system that allows anyone to easily organize large amounts of data on a hard disk. Expands DOS file name limit to 32 characters to name files naturally, the way you think. Use easily remembered plain words or numbers. The interface structure mimics the paper world, only it's faster, better and easier to use... by programmers, managers, secretaries, clerks. PCEasy immediately finds file cabinets, file drawers, file folders, spread sheets, reports in their own logical location. Automatic menu access to application programs. Works with all popular applications and utilities. Not copy protected. Rated "★★★★ for ease of use."

TranSec PCEasy™ \$74.95 plus \$5 s/h
TO ORDER: 1-800-423-0772 VISA/MC
IN FL: 1-305-474-7548

UNLOCK™ Removes Copy Protection

Produces Unprotected Backup Copies

RUNS YOUR SOFTWARE ON ANY HARD DISK

UNlock "copying" disk allows you to make "unprotected" DOS copies of popular original program disks. **Unprotected backup copies** perform perfectly, as do copies of these copies. UNlock copies **run on any hard disk**, including Bernoulli Boxes. No original

required in drive "A." **Run on a RAM disk** simply and conveniently. **Also, copy DOS 5¼" programs to 3½" diskettes.** For IBM® PC, XT, AT, compatibles, 256K or more, DOS 2.1 or higher. Choice of the critics!

Guaranteed to work only with programs below:

UNLOCK™ ALBUM "A" PLUS		\$49.95
		(Plus \$4 ship/handling. Foreign orders \$10)
<ul style="list-style-type: none"> • dBASE III & dBASE III PLUS™ • FRAMEWORK I & II™ • CHARTMASTER™ (6.1) • SIGNMASTER™ (5.1) • FASTBACK™ (5.3) • HARVARD TOTAL PROJECT MGR.™ (1.10) • THINKTANK™ (2.0, 2.1) 	<ul style="list-style-type: none"> • LOTUS 1-2-3™ (1A-2.0) • IBM WRITING ASSISTANT™ (1.01) • IBM FILING ASSISTANT™ (1.0) • IBM REPORTING ASSISTANT™ (1.0) • GRAPHWRITER™ (4.3, 4.31) • REALIA COBOL™ (1.2, 2.0) • MULTILINK ADVANCED™ (3.02, 3.03) 	
• DOLLARS & SENSE™ (2.0)		

UNLOCK™ ALBUM "B" PLUS		\$49.95
		(Plus \$4 ship/handling. Foreign orders \$10)
<ul style="list-style-type: none"> • SYMPHONY™ (1.1) • CLIPPER™ • LOTUS 1-2-3 REPORT WRITER™ (1.0) • DOUBLEDOS™ • smARTWORK™ (1.0 Rev. 8 thru 10 & 1.1) • DISK OPTIMIZER™ • MANAGING YOUR MONEY™ (1.5, 1.51, 2.0) 	<ul style="list-style-type: none"> • MICROSOFT WORD™ (1.15, 2.0, 2.01) • PFS: ACCESS™ (1984 Ed.) • PFS: PLANT™ (B) • PFS: GRAPH™ (B) • PFS: WRIT™ (1.01, C) • PFS: REPORT™ (B, C) • PFS: FILE™ (B, C) 	
• DATABASE MANAGER II—THE INTEGRATOR™ (2.0, 2.02)		

SPECIAL OFFER	"Best of UNLOCK"	\$74.95
	ALBUM "D" PLUS	(Plus \$4 ship/handling. Foreign orders \$10)
<ul style="list-style-type: none"> • dBASE III & dBASE III PLUS™ • FRAMEWORK I & II™ • CLIPPER™ • FASTBACK™ (5.3) • CHARTMASTER™ (6.1) • SIGNMASTER™ (5.1) • DOLLARS & SENSE™ (2.0) 	<ul style="list-style-type: none"> • LOTUS 1-2-3™ (1A-2.0) • SYMPHONY™ (1.1) • LOTUS 1-2-3 REPORT WRITER™ (1.0) • DOUBLEDOS™ • HARVARD TOTAL PROJECT MGR.™ (1.10) • MANAGING YOUR MONEY™ (1.5, 1.51, 2.0) • THINKTANK™ (2.0, 2.1) 	
• MICROSOFT WORD™ (1.15, 2.0, 2.01)		

UNLOCK™ FLIGHT/JET #201	\$14.95
• FLIGHT SIMULATOR™ • JET™	(Plus \$4 ship/handling. Foreign orders \$10)

CHOICE OF THE CRITICS!

PERSONAL COMPUTING "UNlock has two particularly endearing characteristics: it works, and works simply. I was able to quickly produce unprotected copies of Lotus 1-2-3 release 2, Symphony 1.1, Microsoft Word 2.0, dBase III 1.1, and Framework II. These copies performed flawlessly, as did copies of these copies."
Christopher O'Malley,
PERSONAL COMPUTING, April '86

PC MAGAZINE "Because copy protection can interfere with the ability to back up a hard disk, business-oriented users may prefer programs like TranSec's UNlock series."
Winn L. Rosch, PC MAGAZINE, May 27, 1986

BYTE "UNlock 4.7 defeats the latest Prolok and SuperLock type of copy protection scheme. It's menu-driven and works fine on the programs it's supposed to work on: Lotus 1-2-3, dBase III, Framework, Symphony, Paradox, and several others."
Jerry Pournelle, BYTE, Feb. '86

Recommended by the editors of:
PERSONAL COMPUTING
"The Best Software Utilities For Under \$100"

TRANSEC UNLOCK™

ORDER TODAY TOLL FREE:
1-800-423-0772
IN FLORIDA: 1-305-474-7548



TranSec Systems, Inc., 1802 North University Drive, Plantation, FL 33322
Trademarks are the sole property of their respective owners. UNlock is for use only to improve the useability of legally acquired and operated software.

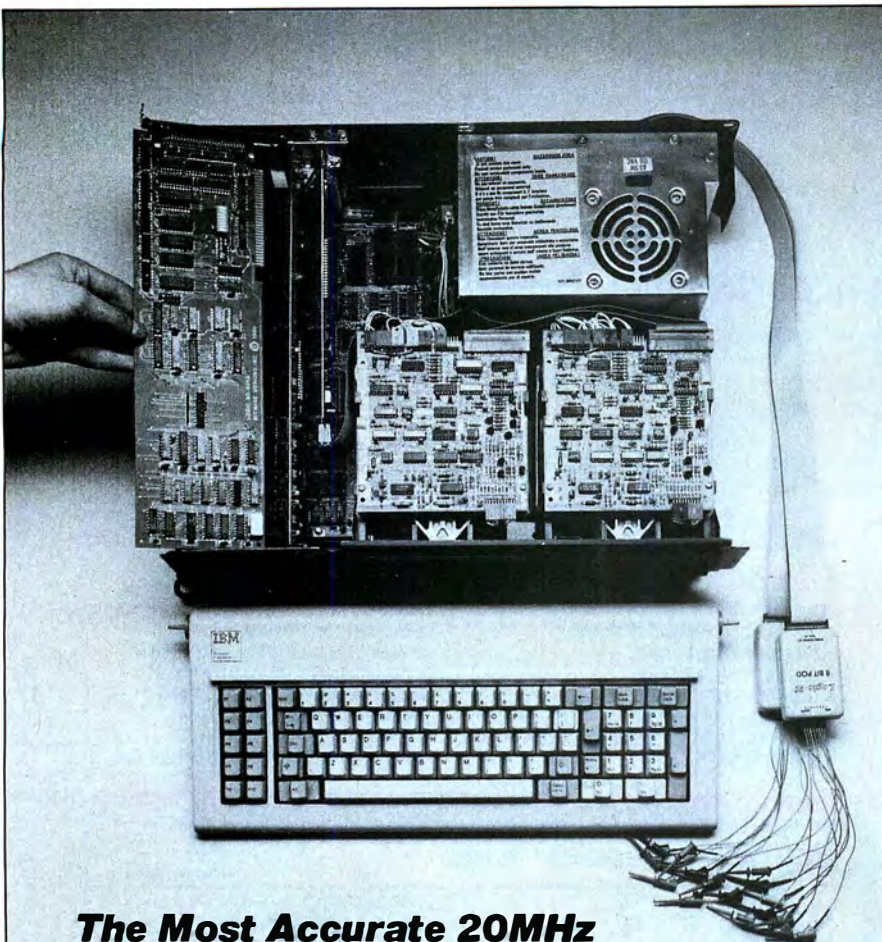

**The Most Accurate 20MHz
Logic Analyzer Available.
For Only \$1,495.**

**Only with the Logic-20™
Only from BitWise Designs**

The true criterion of a logic analyzer's accuracy is not its sample speed, but its set-up time — that period of time prior to the clock edge in which it cannot accurately sample data.

With a set-up time of only 2 ns, the Logic-20 from BitWise Designs blows away its nearest 20 MHz competitors — which are totally unreliable for a monstrous 25 ns. before the clock edge.

The Logic-20 is a single IBM PC (or compatible) expansion card, offering 16 channels of 20 MHz sampling with less than one ns. channel-to-channel skew. Optionally, for those with unusually fast sampling speed applications, the Doubler™ pod is available that allows 40 MHz sampling over eight channels.

And because the Logic-20 is an add on to your personal computer, you can have it right on your

desktop when you need it. You can interrupt development at any time to use your PC to write a memo or document your progress, and then go right back to where you left off. All in your office, all right at your desk.

Need to know more about logic analyzer accuracy or the Logic-20?



Logic That Makes Sense

1223 PEOPLES AVE.
TROY • NY • 12180
518 • 274 • 0755

IBM and IBM PC are trademarks of International Business Machines Corporation.
Logic-20 is a trademark of BitWise Designs, Inc.

*One overlooked factor
is the inverse
relation between
speed and the time
required to write
a program.*

best tool available at the time. It offered very good speed in the finished applications and produced compact code (important on 8080 systems where memory was limited). Also, users were willing to put up with buggy software because there wasn't a lot of software available.

Now that excellent implementations of C are available, many programmers are choosing them over assembly. Another important reason for using assembly has vanished—compact size. Personal computers tend to have at least 512K bytes of memory, so a program's compactness is less important than it was on 8080 systems. Compactness will become less important as systems have increasing amounts of memory.

Assembly is less attractive as a programming language because programs written in it tend to have more bugs than those written in other languages. Fast programs don't help you get a job done more quickly if they are buggy. Programs written in C help you get the job done faster because the program is more robust (that is, less likely to crash), resulting in less downtime. So a program's useful speed can be as important as its execution speed.

One overlooked factor is the inverse relation between speed and the time necessary to write a program. This is hard to quantify, because it assumes that if you have more time to work on a program you will find a faster algorithm. It is this factor that lets some C programs run faster than their as-

(continued)

Contemporary Programming & Software Design Series



Available for IBM PC/IBM PC
Compatibles and Commodore
64/128™ microcomputers.

Check your preference below:

IBM Commodore 64/128

15 Day Trial Examination Order Form

YES! I would like to learn how to make any computer do exactly what I want it to do and would like to examine the first module in the Series absolutely free. If I decide to keep it, I will pay just \$24.95 plus \$2.25 shipping and handling. I will then receive future modules automatically, one every 4 to 6 weeks. Each of the 10 modules in the Series is \$24.95 plus \$2.25 shipping and handling and comes on the same 15-day Trial Examination basis. There is no minimum number of modules that I must buy and I may cancel at any time simply by notifying you.

If I do not choose to keep the first module, I will return all materials in good condition and pay nothing. Future modules will be canceled and I will be under no further obligation.

Name _____

Please Print

Street _____

City/State/ZIP _____

Phone Number () _____

**Ten modules teach you how
to write your own programs
or modify existing software
to fit your needs:**

- Getting Started in Programming & Software Design
- Attacking the Problem
- How to Design the Solution and Arrange It Logically
- Coding the Program: High Level Languages
- Coding the Program: Assembly Language
- Testing and Debugging Made Easy
- Creating Meaningful Documentation
- Modifying & Updating Existing Programs
- Tools & Tricks for Program Design
- Writing Advanced Programs



Post Office
Will Not
Deliver Without
First Class
Stamp

McGraw-Hill Continuing Education Center
3939 Wisconsin Avenue
Washington, D.C. 20016-2876



Make Any Computer Do Exactly What You Want With McGraw-Hill's

Contemporary Programming & Software Design Series



From Writing Your Own Programs to Modifying Existing Software, Here's the New, Easy, and Low Cost Way to Unlock the Secrets of Your Computer

Whether you use computers for business, for personal applications, or for fun, off-the-shelf programs will never do everything you want them to do for you. That's because they were written by programmers to satisfy what they perceived as the needs of the greatest number of potential users—often missing some or many of your specific needs.

That's why McGraw-Hill's new Contemporary Programming and Software Design Series teaches you how to create your own software . . . either from scratch or by making key modifications to existing programs.

There is nothing magical about it. You learn the process of building a computer program step-by-step with McGraw-Hill *Concept Modules* sent to you one at a time, once a month. Each of the ten modules in the Series takes you through an important step in the development of the structure and detailed logic of a program, including testing, debugging, and documentation.

Unique Interactive Hands-On Instruction

Each module includes an easy-to-understand guide PLUS a 5¼" floppy disk containing typical programs and interactive instruction that you can run on IBM PCs, PC compatibles and Commodore 64 and 128 computers for hands-on experience.

In the first Module, for example, when your sample program (Declining Interest Loans) appears on your screen, you'll find errors on certain program lines. You'll also see that the program is only three-quarters completed.

Now comes the fun part. You'll discover how this program is built, and in the process you'll learn how to identify and correct errors. And by the end of Module 1, you'll actually have completed this program yourself.

But there's more. Special graphics on your screen work in conjunction with the accompanying guide to amplify, illustrate, and deepen your understanding of software design principles.



The Crucial 95%—Learn the Foundation of Computer Programming

While the Series includes interactive disks that run on specific computers, everything you learn you can apply to any language or machine. Why is this possible? Because McGraw-Hill knows programming is far more than coding a program into the computer using a specific language. In the real world of computers, 95% of the programming process is carried out using design techniques that are independent of specific language or machine. It is this crucial 95% that you thoroughly understand and master in the Series.

Make no mistake. Almost all books and courses on "programming" teach you only the final 5% of the total programming process—namely, how to code in a specific language. . . information of little value if you don't know how to reach the point in the programming process when you are ready to code.

With the Series, however, you'll learn to create your own programs from scratch, even modify off-the-shelf programs. You'll learn enough BASIC and machine language to get you started on the remaining 5% of the programming process.

Build Your Own Personal Software Library

The sample programs you work with throughout the Series are excellent learning tools. But they're more than that. By combining the sample programs onto one master disk, you'll have the start of your own personal software library. In addition to the programs you've written and modified throughout the Series, you'll also receive dozens of the most popular public domain and user-supported programs, such as data base manager, word processor, calendar generator, appointments reminder and much, much more.

15-Day No-Risk Trial

To order your first module without risk, send the postage-paid card today. Examine the first module for 15 days and see how the Series will

help you make your computer do exactly what you want it to do!



If someone has beaten you to the card, write to us for ordering information about the Contemporary Programming and Software Design Series.



McGraw-Hill
Continuing Education Center

3939 Wisconsin Avenue
Washington, DC 20016

SUNDAY 10-5

COMPUTERS, PRINTERS, DISK DRIVES, MODEMS, MONITORS, ACCESSORIES, FURNITURE & EXPERIENCE

PROMPT DELIVERY

GUARANTEED LOWEST PRICES

COMPUTER: 1-800-874-1235
VIDEO: 1-800-223-6779

IN N.Y. CALL (718) 237-2828

S'nW ELECTRONICS & APPLIANCES
 633 Bedford Ave, Bklyn, NY 11211

Closed Oct 18-26. Open Oct. 27

HOURS: Mon-Thurs. 9-6
Fri. 9-2, Sun. 10-5, Sat. Closed

TOLL FREE OUT OF N.Y.

C.O.D. Accepted
 Credit Card Accounts charged at time of order
 Add shipping/handling
 Qty. Limited
 Prices subject to change without notice
 Not responsible for typographical errors

C VERSUS ASSEMBLY

sembly language counterparts. Even programmers who favor assembly language admit that assembly programs take longer to write than C programs.

A general rule of thumb is that it takes about the same amount of time to write a line of source code no matter which language you use. (Scaling factors enter in if you want precise results, but the general rule is adequate for my argument.) Because it typically takes me three lines of assembly code to generate the equivalent of one line of C, I will estimate that it takes about three times as long to write a program in assembly as it does in C.

The cost to a company that uses assembly as its primary programming language is twofold. Assuming salaries for C and assembly programmers are comparable, the company spends three times as much on programmers' salaries as it would if its programmers wrote in C. And competitors who use C will beat it to market and get plenty of time to establish their products.

As far as maintenance goes, programs written in assembly are more difficult (translate "expensive") to maintain for commercial developers. Naturally, the extra cost is passed along to the consumer.

Some people assert that assembly has a more complete set of instructions than C. I disagree—assembly has a much *finer* set of instructions than C. Assembly gives the programmer much tighter control of program flow. However, it interfaces so nicely with C that you might say that the C instruction set includes assembly's instruction set. As far as addressing memory goes, C provides about everything you need. (The only really necessary data types that C lacks are an 8-byte BCD data type for accounting packages and an 8-byte long for high-resolution graphics.)

C has much more powerful software tools than assembly because of all the support products for C programmers. There are more than 15 professional C compilers, plus many source-level debuggers, general C libraries, C

(continued)

A CROSSTALK[®] XVI

SuperKlone[™]



\$195⁰⁰



\$69⁹⁵

FEATURING Foreground/Background Communications

SOFTKLONE
 The Age of KloneWare Has Arrived

1210 E. Park Ave. • Tallahassee, FL 32301
 For information call 1-904-878-8564
 TLX: 6714280 KLON

MIRROR[™] provides:

- Crosstalk XVI compatibility
- Background communications
- Built-in text editor
- Learn-mode for automatic script file generation
- Transaction log

AND MUCH MORE...

MIRROR[™] \$69⁹⁵

Site Licensing Available
 60-Day Money-back Guarantee
 Not Copy Protected

MIRROR is available for the IBM PC/XT/AT and compatibles running MS-DOS 2.0 or higher. **MIRROR[™]**, SuperKlone, KloneWare and SoftKlone are trademarks of SoftKlone Distributing Corporation. Crosstalk XVI and Microstar are registered trademarks of Microstar, Inc.

Shipping/handling 5.00
 (COD orders add \$3.00)
 International shipping/handling 18.00
 Florida residents must add 5% sales tax

COD To Order Call (904) 878-8564

Distributed in Canada by:
 Saragody Software Distributors
 Telephone: (416) 923-1500

Distributed in Scandinavia by:
 UNIC (Norway)
 Telephone: 02 38 39 10

Distributed in the UK by:
 Management Data Processing Ltd.
 Telephone: (0225) 60491
 Trade Ltd Telephone: (0629) 3321

Distributed in Australia by:
 Delta Computer Systems Pty. Ltd.
 Telephone: (02) 633-4055
 P.O. Extras Pty. Ltd.
 Telephone: (02) 319-2155

jc lips

The Word is Out...

It's going to break your heart if you already own a PC.

JC LIPS provides a new experience in personal computing. Our third generation personal computer brings you technological advancement and features which have not been possible in the past. It runs all popular IBM PC software 2 to 4 times faster than other compatibles. It will impress you with unsurpassed performance and cool reliability. Best of all, it is available to you at an affordable price.

JC LIPS features the advanced-technology CMOS NEC V40 processor running at 8 MHz with an equivalent throughput of at least 9.5 MHz. The systemboard has 256K of RAM, expandable to 640K, a built-in floppy disk controller, a socket for a high speed floating point processor, and 8 I/O expansion slots. Also included as standard on systems are 360K floppy disk(s), a serial interface, a parallel printer interface, a battery backed-up clock, a keyboard, and a 135 Watt power supply, capable of handling all of this plus any accessories you may add later.

JC LIPS' display system includes a quality 14" high resolution monochrome monitor, with a dark

background non-glare screen and a tilt and swivel base for easy viewing. The multi-function display card provides an IBM PC compatible interface for a monochrome display with Hercules compatible graphics or a RGB color graphics display.

JC LIPS is also available with high speed 20 MB hard disk with 2K cache buffer memory controller, Enhanced Color Graphics display adapter, high resolution RGB color monitor, local area networking controller, and more. These options can be added at any time, and with the features we supply as standard, it will be a difficult system to outgrow.

NOW the word is out. Another superb product is available from the high-performance, multi-user systems company, JC Information Systems.



JC INFORMATION SYSTEMS

161 Whitney Place
Fremont, CA 94539
(415) 659-8440 TWX 910-381-7041

**IN THE WORLD OF SCIENCE,
ONE WORD PROCESSOR STANDS OUT.
CALL 1-800-874-2383 TODAY!**



- Typing is simple and direct, so you can compose scientific manuscripts directly at the keyboard. Expressions appear on the screen as they'll be printed, with special fonts, line spacing, underline, boldface, italics, subscripts and superscripts all correctly displayed.
- Fonts of mathematical symbols. Greek, italics, script, Russian, and chemistry symbols are supplied. You can make your own characters if you need them.
- Complex expressions can be saved by name, in files of keyboard macros, so you'll never have to retype them again.

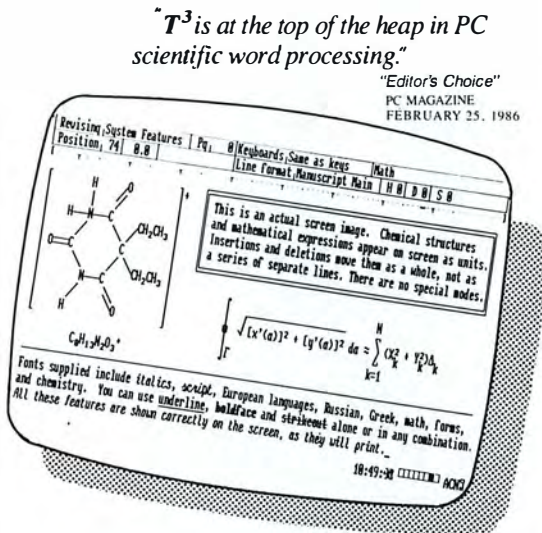

1-800-874-2383 In New Mexico (505) 522-4600
TELEX 317629
1190-B FOSTER ROAD • LAS CRUCES, NEW MEXICO 88001

Supports: IBM PC family, HP Vectra, NEC APC III, AT&T 6300 and close compatibles. IBM and Hercules graphics boards; many dot matrix, daisy wheel, and laser printers.

**C VERSUS
ASSEMBLY**

C's rich programming environment is probably the most important reason to choose it as a development language.

libraries that emulate commercial database managers, interpreters, lint checkers, editors that offer special C support, translators that convert source code from other languages to C, and teaching tools to help novice C programmers learn C. The rich programming environment for C is probably the most important reason to choose C as a development language.

Assembly just doesn't have the support. Support products include Microsoft's Macro Assembler, other miscellaneous assemblers, cross-assemblers, and a few symbolic debuggers. Its support is sparse when compared with C's.

One assembly writer was surprised to learn that a C programmer went to the trouble to write his own I/O routines. He thought that a C compiler was supposed to do that. His error is instructive in the philosophy behind C: The compiler is deliberately kept sparse so that you can tailor I/O routines to your needs. Many C programmers write their own routines eventually. The standard library just gets you up and running under MS-DOS.

Having covered the disadvantages of assembly, I want to point out two instances where it has distinct advantages over C. Where memory is extremely limited, C might not be able to produce code that will fit. Assembly's compactness may be the deciding criterion. Another case is when very high-performance software is needed and the program doesn't spend most of its time in a small sec-

(continued)

Coldblue™
A Ventilation System exclusively for IBM® PC.

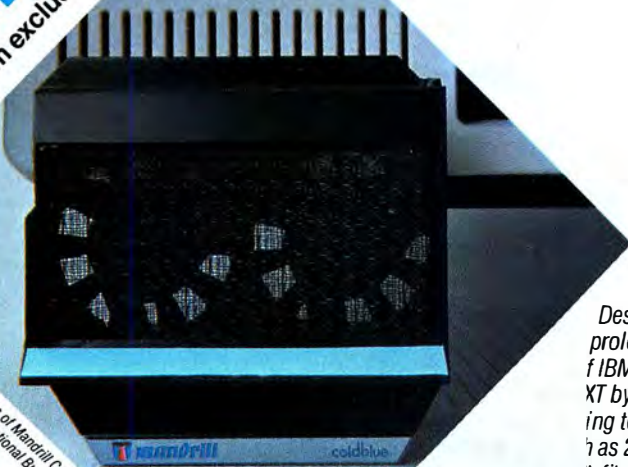

Designed to prolong the life of IBM PC XT by reducing temperature as 27°F. or more. It fits inside and forces air out of the area. The

one that really works! \$185. Dealer inquiries welcome.

mandrill™ Mandrill Corporation, PO Box 33848, San Antonio, TX 78265
1-800-531-5314 (1-800-292-5619 in Texas only.)

The ultimate 101 keyboard



has arrived.

Perfect timing. Because the Maxi-Switch ME-101 is the next-generation AT, PC/XT* compatible keyboard. And you can order it right now. Not next week, not tomorrow. Today.

Three custom layouts. Order the standard 101-key when you must have an exact IBM layout. Select the 102-key European version when you need a keyboard tailored for international markets. To make any operator's data entry life easier, choose the super enhanced model with its oversize L-shaped "Enter" key for quick, accurate striking.

All three switch selectable layouts offer a smaller footprint for extra desktop space. All three give you the option of relocating the "Caps Lock" and "Ctrl" keys to their traditional AT positions. All three feature the patented Maxi-Key rollover for fast, error-free data entry.

The Maxi-Touch is here. And best of all — all three models offer you the Maxi-Touch™ a clear, consistent tactile response with true breakover

keyswitch action. Made possible by the conductive elastomer technology Maxi-Switch introduced to the keyboard world in 1981, proven since then in hundreds of thousands of keyboards to measurably increase typing throughput.

No time to lose. Call or write today for detailed information about our entire line of IBM plug compatible keyboards. If you have a custom requirement, call us or your local Maxi-Switch representative about making your keyboard your way. At Maxi-Switch, we profile our products for tomorrow's technology.

Get in touch with the **Maxi-Switch Company**, 9697 East River Road, Minneapolis, Minnesota 55433, phone (612) 755-7660, TWX 910-576-2690. In Europe, contact **EECO Ltd.**, Bar Hill, Cambridge, CB3 8SQ, England phone 0954-80257, TLX 817303.



Experience the Maxi-Touch

*IBM AT and XT are registered trademarks of IBM Corporation.

Inquiry 184 for End-Users. Inquiry 185 for DEALERS ONLY.

tion of the code. In this case it might be easier to write the whole application in assembly.

SUPPLEMENTING C WITH ASSEMBLY

Although I have presented C and assembly in an opposition format, I would like to show how assembly can

complement C. Of the C programs written for the PC architecture, most are written in the small-data model. Accordingly, if a program needs to access areas outside of the program's data space, such as video RAM, it needs to use assembly routines.

C doesn't provide access to some of the 8088's hardware resources. If

a program needs to access a system interrupt or a port, you must use assembly. Generally, the C compiler library includes assembly functions that do these things. Sometimes these resources are inadequate, requiring you to write assembly code.

If a program's performance is too slow, you will have to write certain portions of the code in assembly. Assembly provides access to the fast 8088 block write/search commands (REPZ, REPNZ with MOV, SCAS, CMPS, or STOS) that C lacks. Again, the compiler library typically provides C functions using fast block writes/searches, but they might not do what the programmer needs.

HOW ASSEMBLY INTERFACES WITH C

Let's look at what C programmers have to take into consideration when writing assembly routines. The C programmer who is starting to write assembly code for use by C programs will run into several obstacles, one of which deals with segments. C compilers take care of all the linkage information so you don't have to worry about code and data segments. Assembly isn't so nice: You have to make sure the assembly code includes instructions that match the output of the C compiler to tell the linker where code and data are to go.

Some C compilers add an underscore before or after public names. When you write public functions or reference static data in assembly code, be sure to add a leading or trailing underscore (as required by your compiler) to its name. Should you forget the underscore, you will probably get an error message from the linker about unresolved external names.

C compilers assume that the contents of certain registers will be saved. In the small-data model, most compilers require that all segment registers be saved. In the large-data model, the ES register doesn't need to be saved, but the contents of all other segment registers need to be saved. If the compiler implements register

(continued)



WORKSTATION MANAGER... IT'S THAT SIMPLE.

WORKSTATION MANAGER is a window-based menu system. QUICK and EASY to use...yet powerful enough to link programs and commands resulting in a sophisticated tool for information center personnel.

WORKSTATION MANAGER can be used to:

- ▶ Provide a standardized interface between application programs, DOS commands and PC users
- ▶ Free users from hardware configuration concerns
- ▶ Buffer users from LAN environment complexities
- ▶ Minimize menu disk space through the use of a unique library management facility
- ▶ Simplify development and eliminate the need to maintain more than one user manual
- ▶ Invoke any software package without using Batch Files

WORKSTATION MANAGER comes with over 200 menus and operates on the IBM PC™, XT™, AT™, 3270™, and other 99% compatibles.

With WORKSTATION MANAGER, support problems become a thing of the past.

Call STAR... It's that simple.



Software Technologies and Research, Incorporated

160 West Street
Cromwell, CT 06416-1930
203-529-7128
Telex: 5106012927 (STAR INCC T UQ)

1-800-258-STAR

Corporate Licensing Available.
Dealer Inquiries Welcome.

IBM®, PC, XT, AT, 3270 are registered trademarks of IBM Corporation

The Diconix 150. So quiet, it's the one
PC printer you can take lightly. Anywhere.



DICONIX
A Kodak Company

3100 Research Boulevard
Dayton, Ohio 45420.
1-800-DICONIX Telex: 288-280
Inquiry 85

The Common Dilemma

Apparent Solution.



**512KB, 6Mhz.
\$4545***

The **Common Dilemma** for you, the microcomputer buyer is deciding which system to purchase to meet the needs of your users, your customers, or yourself.

The **Apparent Solution** seems to be that you *could* buy IBM®. What you'd get however, is a naked machine with inadequate performance at an astronomical price.

Or, you *could* be enticed by those super-cheap and questionable clones at the expense of sacrificing full compatibility, quality, reliability, and user satisfaction.

The **Intelligent Conclusion** is, of course, to move up to **Proteus™**. **Proteus™** solves the dilemma with three high quality *American-Designed, Engineered and American-Built* powerful microcomputers. **Proteus™ Microcomputers**, which come from a leading electronics corporation, surpass all microcomputers on the market, in technology, speed, reliability, price and after-sale support.

Our basic philosophy:

- use high quality and stable 8-layer boards.
- use only genuine components.
- we are always testing software & hardware products to ensure total compatibility—we spend the time making it right so you don't have to.

And **Proteus™** comes with Operations & Technical Guides that are meant to be used by people, not machines. Of course, we also offer our **free** 24-hour, 7-day on line system for technical support, service inquiries, and just plain questions about **Proteus™**. Fully compatible with UNIX, ZENIX and Autocad.

The **Proteus-XTi™** is our basic business system. As with all **Proteus™** systems, it includes **nation-wide on-site support by a major U.S. maintenance group**. **Free upgrades** of BIOS, ROM, and systems utility software for all registered users.

- ✓ Intel 8088-2CPU, 4.77/8 Mhz
 - ✓ 640K RAM Expandable to 1MB on Motherboard
 - ✓ 0 Memory Wait State
 - ✓ 360K 5¼" Floppy Drive
 - ✓ 2 Serial Ports, 2 Parallel Ports
 - ✓ Clock/Calendar, SASI Interface on Board
 - ✓ Reset Button
 - ✓ 135 Watt UL Power Supply
 - ✓ Hercules Compatible Mono/Graphics Adapter
 - ✓ High Resolution Monochrome Monitor
- Price: \$979.**

Intelligent Conclusion.



**1MB, 12.5Mhz.
\$2549***

The Proteus-286™, Our Standard Configuration

- ✓ Intel 80286-10 CPU, 6/10 Mhz
 - ✓ 1 Wait State, 0 Wait State Optional
 - ✓ 1.2 MB 5¼" Floppy Disk Drive
 - ✓ 360K 5¼" or 3.5" Microfloppy
 - ✓ Combination Hard/Floppy Disk Controller
 - ✓ 1 MB RAM Expandable to 4MB on Motherboard
 - ✓ 5 Mhz DMA Bus
 - ✓ 2 Parallel Ports, 3 Serial Ports on Motherboard Selectable RS232 or RS422
 - ✓ Clock/Calendar with Battery on Board
 - ✓ A.T. Keyboard
 - ✓ Reset Button
 - ✓ 200 Watt UL Power Supply — 110v/220v Switching
- Price: \$2195.**

The Proteus-286GT™, Our Standard Configuration

- Same as 286 but with
- ✓ Intel 80286-12 CPU, 6/12.5 Mhz
 - ✓ One Memory Wait State
- Price: \$2549.**

proteus

The Intelligent Conclusion



To Order,
Call:

WINTech DATA PRODUCTS CORP.® U.S.A.
377 ROUTE 17
HASBROUCK HEIGHTS, N.J. 07604
Inquiry 307

PHONE: 201-288-8629
TELEX: 510 601 0960
FAX: 201-288-8577

Special Configurations with Hard Disks, EGA, CGA, Monitors available.

Terms: Visa, M.C., C.O.D., Prepayment, Wire Transfer or L.C.

*(The Fine Print). Suggested Retail Prices. IBM is a registered trademark of International Business Machines. Proteus is a trademark of Wintech Data Products Corp. All prices, terms, specs, and offers, subject to change.

variables, the SI and DI registers might need to be saved. BP needs to be pushed and popped if you use it to address the stack (which you do if you need to pass arguments to the function).

Assembly routines address these arguments as offsets of the base pointer. The difficulty with addressing arguments as numeric offsets is that it is easy to become confused as to just what [BP + 18] is pointing at. The offset is different for the small- and large-code models, because in the large-code model the segment number—as well as the offset—must be in the return sequence. The small-code model requires only the offset. In the large-data model, pointers are 4-byte quantities. To load pointers passed as arguments on the stack into a register requires an LES or LDS instruction. In the small-data model, a simple MOV will suffice.

Sometimes your assembly function will need to return a value. Generally, integers are returned in the AX register. The way pointers are returned is variable, depending on the compiler and whether you are using the small- or large-data model. Longs may be returned in AX and BX or in AX and DX (which is standard DOS convention). Chars are returned in AL. Doubles are returned in AX, BX, CX, and DX. One compiler returns near pointers in a different register than integers—a mistake in my opinion, because many C programmers don't explicitly declare functions to return pointers.

USING A MACRO ASSEMBLER

You can make writing assembly for C a good deal easier when you use a macro assembler. You should combine standard patterns into macros. For example, the prologue to starting a function called FN_INT in the small-code model is

```
PUBLIC FN_INT
FN_INT PROC NEAR
```

As an example, you could write a macro called FN_PROLOGUE (this macro won't work with version 1.0 of

(continued)

Sudden AT™ Death. What Would You Do?



You

suddenly it starts to happen. Your computer starts gasping for information because your AT battery is dying. The simplest data, like the time and date, becomes a struggle. All vital signs start fading from the screen. Without action, the victim will soon lapse into unconsciousness.

What would you do?

Until recently you would have been powerless to save your AT computer. Replacement batteries were not readily available. All you could do was stand by helplessly as your computer's life source drained away. But now, with the help of IBC, you can resurre your AT, by using IBC's simple method of CPR— Computer Resuscitation. Just plug in one of IBC's new Tadiran high-energy lithium batteries, and your AT will have a new lease on life.

The Tadiran Replacement Battery from IBC saves you from an inevitable crisis. Every one of the million ATs, compatibles and clones in use today will face this emergency in the coming months. It could happen a few weeks from now, or maybe in a year. The lifespan of currently installed batteries varies from one month to 3 years.

Don't let time run out on your computer. Protect against down time!

Buy an IBC battery now, so you always have a back-up.

IBC Battery Features:

- Meets or exceeds all manufacturer's specifications
- Warranted for in-use life of 3 years
- 10-year shelf-life
- For IBM/AT, Compaq 286 series, and all other AT compatibles and clones
- Easy to install

If your computer should exhibit the following warning signs, you must take action immediately!

WARNING SIGNS

- Clock/calendar function fades and disappears
- Configuration files vanish

Steps to Take In Case of Sudden AT Death

- Do not panic
- Do not move injured computer
- No need to call repairman
- No need to call manufacturer

Just call IBC, and you will get immediate shipment of your new Tadiran AT replacement battery. The life you save will be your computer's.

Corporate quantity discount available.



Don't delay. Order today.

Shipping \$3.00 per battery.

Please send me an IBC AT Battery for \$27.50 (CA residents add 6.5% for sales tax)

Name _____ Title _____

Company Name _____

Address _____

Make of computer _____

Check enclosed* Make money order or check payable to International Battery Corporation.

Mastercard or Visa # _____

Card expiration _____

*We need 7 working days for check to clear.

International Battery Corporation
6860 Canby Ave. #113, Reseda,
CA 91335 (TLX 6975427 +)
To order call: **(800) 225-9359 CA**
(800) 654-3790 US
Other inquiries call:
(818) 609-0516



IBM/AT is a registered trademark of International Business Machines. Compaq 286 is a registered trademark of Compaq Corporation.

MASM because of a bug):

```
FN__PROLOGUE MACRO NAME
PUBLIC NAME
NAME PROC NEAR
ENDM
```

Then, if you wanted to write FN__INT, you could start with

```
FN__PROLOGUE FN__INT
```

Most compilers put the first argument passed to a function at [BP + 4] in the small-code model (remember, the return address and BP register—two words—are commonly pushed onto the stack upon entering a function). Let's define a constant, ARG__BASE, which points at the first argument passed to the assembly function:

```
ARG__BASE EQU BP + 4
```

To make sure you address the stack properly, you can create other constants (assuming the small-data model):

```
INTEGER = 2
```

```
POINTER = 2
LONG = 4
LONG_PTR = 4
FLOAT = 4
DOUBLE = 8
CHAR = 2 ; although chars are
; 1-byte values, com-
; pilers promote
; them to integers
; before pushing them
; on the stack
```

With these defined, you can address the first element on the stack with the expression [ARG__BASE]. If the first argument is a pointer, you can address the second argument with the expression [ARG__BASE + POINTER], and so on.

For those of you who use a compiler that adds an underscore before or after public names, an operator in the Macro Assembler that you will find invaluable is &. For example, if you want to append an underscore to a function called FN__INT, you would say FN__INT&_. This can be handy when you are creating macros. You

might want to modify my first example using this trick.

WRITING FAST-EXECUTING ASSEMBLY CODE

If you've decided to use assembly routines to improve the performance of your C program, here are some hints to make these parts of your code as fast as possible.

Keep your variables in registers. The difference between MOV REG, REG and MOV REG, MEMORY is theoretically a factor of eight. In practice, the execution of many small, fast instructions limits the speed because time is spent moving the instructions into the prefetch queue.

You normally have six registers to work with—AX, BX, CX, DX, SI, and DI. Any variables that you can guarantee won't exceed the value of 255 can be kept in AL, AH, BL, BH, and so on. This means you could have up to 10 variables in registers. For most functions, this is more than adequate.

Write large code. This might sound like
(continued)

Listing 1: A faster way to multiply a byte variable by the value 80.

```
MOV AX, VARIABLE ; 3 bytes, 14 clocks
MOV CL, 4 ; 2 bytes, 4 clocks
SHL AX, CL ; 2 bytes, 24 clocks
MOV BX, AX ; 2 bytes, 2 clocks
SHL AX, 1 ; 2 bytes, 2 clocks
SHL AX, 1 ; 2 bytes, 6 clocks -- prefetch queue
; is empty before the instruction
; is executed
ADD AX, BX ; 2 bytes, 14 clocks -- 4 clocks/byte
; for the BIU to put the instruction
; in the queue plus 2 clocks to
; execute it
```

Listing 2: A routine to move a row of text into the screen buffer.

```
MOV CX, 40 ; 40 WORDs to search
MOV DI, BUFFER ; DI points at the buffer
MOV SI, SCREEN_OFFSET ; SI points at the screen offset
START:
MOV AX, [DI] ; 14 clocks -- get two chars from the buffer
AND AX, 07F7FH ; 4 clocks -- turn off the high bits
MOV [SI], AX ; 14 clocks -- put the chars into screen RAM
ADD SI, 2 ; 4 clocks -- the next two chars in the buffer
ADD DI, 2 ; 4 clocks -- the next two chars in screen RAM
LOOP START ; 17 clocks -- continue until CX is zero
```

Introducing . . .

ATI 6/12 MHz System 286

A Quick Step Forward...



Specifications:

- IBM PC-AT compatible
- 12 MHz 80286 microprocessor
- Dual speed, 6/12 MHz
- Keyboard switchable
- Norton Sys Info rating of 11.5-13.3
- 1 MByte on board memory
- One 1.2 MByte Floppy Drive
- 200 watt power supply
- AT style keyboard
- BIOS standard

IT'S FAST! The ATI System 286-12 runs at an amazing speed of 12MHz. *That's 100% faster than the original IBM Personal Computer AT.*[®]

IT'S COMPATIBLE! Even at this amazing speed, it is compatible with most name-brand multifunction, video and peripheral boards. And to protect your existing investment, we've built-in a normal speed mode as well. A few simple keystrokes will switch you to 6 MHz operation mode, when necessary.

IT'S RELIABLE! This ATI system 286-12 is evolved from proven design of ATI-2000 and ATI-1000 mother boards, of which over 10,000 pieces have been shipped in the field. And to back this reputation, on-line technical support is available to you from knowledgeable people who speak your language.

IT'S VERSATILE! Combine the ATI System 286-12 with our MegaGraph Plus EGA board to get superb graphics performance. Or expand your system's main memory with the ATI Multifunction card and benefit from Xenix[®] applications. Up to five disk drive slots and eight expansion slots give you everything you need to grow from single-user environments to the next generation multi-user systems.

Call or write today for more information on our full line of AT[®] compatible system boards, graphics peripherals, and system accessories. And take a quick step forward!

ATI welcomes our current customers to inquire regarding our special offers.



**ATronics
International Inc.**
We Deliver Advanced Technology

491 Valley Way, Milpitas CA 95035
(408) 943-6629 TLX: 510-600-6093

Inquiry 27

Listing 3: A routine to search for a byte using the compare string block instruction.

```

MOV    CX, 128      ; SEARCH 128 BYTES
MOV    AL, VALUE    ; VALUE TO BE FOUND
MOV    DI, OFFSET   ; START OF MEMORY TO SEARCH
REPZ  SCASB        ; 15 clocks/repetition,
                  ; plus 2 clocks per
                  ; execution of prefix.
    
```

Listing 4: The same search routine without using block instructions.

```

MOV    CX, 128      ; SEARCH 128 BYTES
MOV    AL, VALUE    ; VALUE TO BE FOUND
MOV    AH, AL       ; SAME VALUE IN AH
MOV    DI, OFFSET   ; START OF MEMORY TO SEARCH
DEC    DI
TOP:
INC    DI           ; 2 clocks
MOV    AL, AH      ; 2 clocks
SUB    AL, [DI]    ; 14 clocks
LOOPNZ TOP         ; 19 clocks
    
```

heresy, but it's true in many cases. Here's an example in which larger code runs faster than smaller code. Suppose you want to multiply a byte variable by 80 and can guarantee no overflow. One way to do it is

```

MOV AX, VARIABLE ; 3 bytes
                ; 14 clocks
MOV BL, 80      ; 2 bytes
                ; 4 clocks
MUL AL, BL      ; 2 bytes
                ; 70-77 clocks
    
```

This produces 7 bytes of code that takes 88-95 clocks to execute.

Listing 1 shows a much faster way. The code is 15 bytes long and takes about 66 clocks to execute. It is about twice as much code as the previous example and runs about a third faster. (The comparison assumes that the prefetch queue is full at the beginning of each example.) This finding runs counter to what some experts say—that the larger a program is, the slower it runs.

Michael Abrash had an interesting observation in his article on how using fast shift and rotate instructions can actually slow execution time (see "Bit Rotation Speeds," *PC Tech Journal*, May 1986). Although Intel gives a time of two clocks for the instruction SHL AX, 1, if the instruction isn't

already in the prefetch queue, it will take eight clocks to fetch the instruction and two clocks to execute it—five times what the book says. You empty the queue quickly with those fast two or three clock instructions. It might be faster to use the shift or rotate instructions with the CL register.

A corollary of "write large code" is "avoid elegance." Brute-force routines run faster than routines that rely on a lot of decision making. Those conditional jumps aren't cheap. (The idea that more code runs faster also applies to C, although at a higher level. You might have two similar routines that are optimized to be fast at specific tasks instead of one general, slower routine.)

Suppose you want to move a row of text into screen RAM from a buffer and turn off the high bit. You could write the code shown in listing 2. Each iteration of the loop takes 57 clocks. The total time to process 80 characters is 2280 clocks, which doesn't include the overhead from having to refill the prefetch queue after each jump. Look what happens when you use more code:

```

MOV    CX, 20
MOV    DI, BUFFER
MOV    SI, SCREEN__OFFSET
    
```

START:

```

MOV    AX, [DI]      ; 14 clocks
AND    AX, 07F7FH   ; 4 clocks
MOV    [SI], AX      ; 14 clocks
MOV    AX, [DI + 2] ; 14 clocks
AND    AX, 07F7FH   ; 4 clocks
MOV    [SI + 2], AX ; 14 clocks
ADD    SI, 4         ; 4 clocks
ADD    DI, 4         ; 4 clocks
LOOP  START          ; 17 clocks
    
```

The total time for this loop is 1780 clocks. You can continue the process by moving four words at a time instead of two. For four words, the total time is 1530 clocks. The advantage decreases significantly as more time is spent inside the loop. Figure that the overhead is 23 clocks times the number of iterations.

Take advantage of block instructions. The 8088 instruction set includes instructions that can search a block of memory for a byte or word value, or write a byte or word value into a block of memory. These instructions execute much faster than code that uses instructions that search a byte or word at a time. For example, the code in listing 3 searches for VALUE beginning at OFFSET. Assuming that the code searches the entire 128 bytes without finding VALUE, the code will take about 1950 clocks. The equivalent code that doesn't use block instructions is shown in listing 4. The set of instructions in listing 4 takes over twice as long to execute as the previous set (37 clocks per repetition versus the previous 15).

Count the clocks. Use short instructions if possible. Be aware of how instructions modify flags so you don't use a TST or CMP if the flags already contain the information you need to do a conditional jump. Use one word instruction instead of two byte instructions if possible. The list of tricks to speed up code goes on and on.

One key idea is: Learn the 8088 instruction set. Another is: Don't be afraid to use unconventional tricks. Often, merely setting up a nonintuitive array of data to drive the decision making will reduce code size and increase the speed. This will work in your C code as well. ■

A NEW DIMENSION IN COMPUTER EDUCATION

"PC TechVideo provides an in-depth overview of the installation of computer components. We use it to train all our technicians and assemblers."

**John Atma, Chief Technician
for Tech Personal Computers**

"After viewing PC TechVideo, I now understand the basics of how my computer works and was even able to replace the 1.2M drive on my AT at work. PC TechVideo was definitely worth the money."

**Brenda Hudson, Data entry and processor
for Sark Enterprises**

"PC TechVideo is great. With the help of PC TechVideo, I was able to install a 10MB hard disk on my XT without taking it to an expensive service center."

**Gita Beant, Economics major
at UC Irvine**

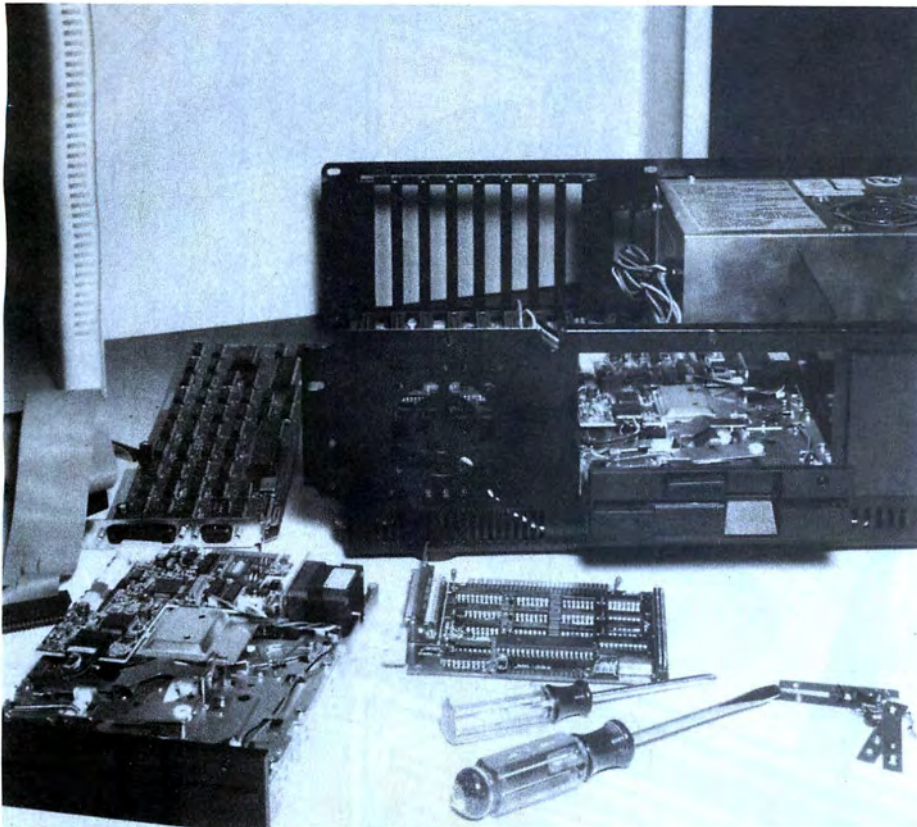

**1040 EAST CHAPMAN AVE.
ORANGE, CALIFORNIA 92666**

**OUTSIDE CALIFORNIA IN CONTINENTAL
U.S. - PUERTO RICO, HAWAII EX-
CLUDING ALASKA:**

1-800-438-8877

**CALIFORNIA RESIDENTS CALL:
(714) 771-3560**

**SPECIAL
INTRODUCTORY
OFFER
\$89.95**



PC TechVideo is an innovative set of two 2-hour instructional video tapes which form a complete guide to the IBM® and compatible personal computer systems. Designed for everyone, from the complete novice to the software expert. PC TechVideo provides the viewer invaluable first hand instruction in the installation and maintenance for IBM® and compatible systems.

Part I of PC TechVideo is a complete and comprehensive presentation of prominent features of the PC family including:

Motherboard architecture

Memory Configuration and Addressing
Monitor Technology
Floppy and Fixed Disk Technology
Bus Architecture
Serial and Parallel Ports

Part II of PC TechVideo shows the details involved in actually installing, configuring, and replacing:

Motherboards
Power Supplies
Floppy and Fixed Disks
Drive Controllers
Popular Expansion Boards

PC TechVideo provides instruction not found in books or magazines. It is an essential tool for anyone interested in understanding their PC. You can't afford not to have PC TechVideo.

ORDER NOW

NAME _____

ADDRESS _____

CITY _____ STATE _____ ZIP _____

PHONE # _____

PLEASE RUSH _____ COPIES OF
PC TECHVIDEO IN

VHS BETA FORMAT

VISA MASTERCARD C.O.D.

CHECK/MONEY ORDER ENCLOSED

ADD \$3.50 SHIPPING.

CALIFORNIA RESIDENTS ADD 6% SALES TAX.

ANYONE CAN BUILD A CLONE, BUT...

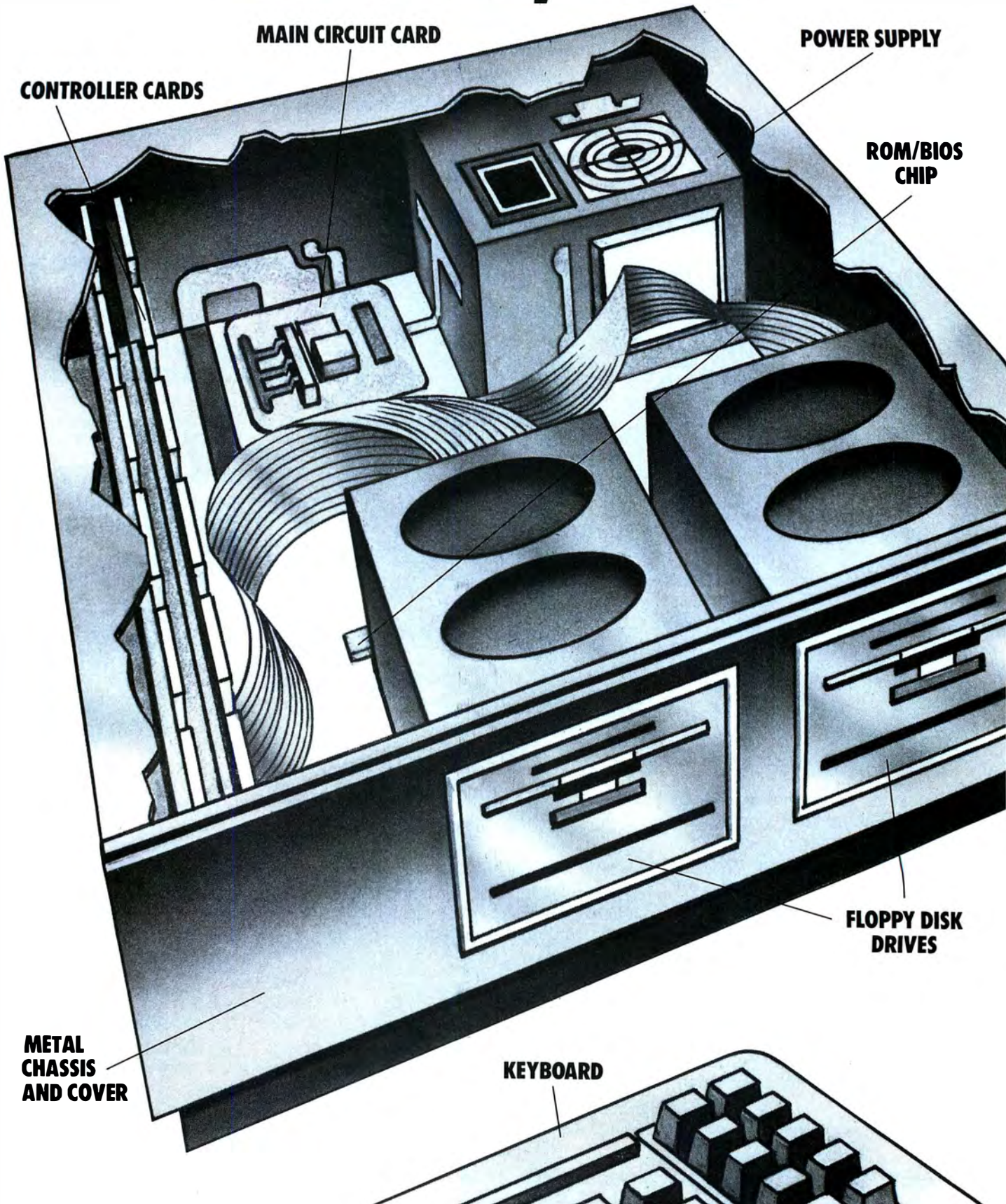

MAIN CIRCUIT CARD

POWER SUPPLY

CONTROLLER CARDS

ROM/BIOS
CHIP

FLOPPY DISK
DRIVES

METAL
CHASSIS
AND COVER

KEYBOARD

ONLY PANASONIC® GIVES YOU A BUSINESS PARTNER.™

Everyone seems to be jumping on the bandwagon. Today, companies that weren't there yesterday, and may not be there tomorrow, are building computers from easily assembled components.

The result is a sea of computer clones with little to distinguish one from another.

THE PANASONIC DIFFERENCE—A POWERFUL BUSINESS ALLY. Our approach to offering you a computer was entirely different. We looked at what would work best for you and your business.

The result is the Panasonic Business Partner and Panasonic Business Partner 286. Two powerful business allies, designed to answer your most demanding computer requirements.

YOU CAN SEE THE DIFFERENCE

PANASONIC MAKES. With our long, unparalleled heritage in video technology, you get high-quality, high resolution monitors. An optional Panasonic CGA PLUS board is switchable to let you use a color or monochrome display for both graphics and text.



BUILT-IN FLEXIBILITY. No two businesses run exactly the same way. So you can configure the Business Partners to your own individual needs. In addition to their built-in floppy disk drives, you can add a hard disk drive, additional half-height drives—even a magnetic tape drive.



SPEED AND PERFORMANCE. The Business Partner 286 is built with maximum power and speed. Its 80286 processor runs at 6 MHz or 8 MHz, with the ability of addressing up to 15Mb RAM.



The Business Partner, with its 8086-2 processor, runs at 4.77 MHz, and for projects that need added acceleration, it will run up to 7.16 MHz.

FUTURE GROWTH. Both Business Partners have been designed to grow as your business grows. Extra slots are built in to offer you the flexibility—now and in the future—to add on cards for high resolution graphics, communications accessories and other peripherals.



*IBM is a registered trademark of the International Business Machines Corp.

POWER TO SPARE. As your business grows, you'll put greater demands on your Business Partner. Don't worry, it can handle it. With 130 watts on the Business Partner and 220 watts on the Business Partner 286, you'll be able to drive additional peripherals and expansion boards.



IMPORTANT DESIGN CONSIDERATIONS. The deluxe, detachable keyboards on both models have been designed for comfort and ease of use. We've separated the cursor keys and numeric keys for quick, convenient access. Swivel monitors adjust for each operator. On the Business Partner 286, you can lock the cabinet with a key to help prevent tampering and prying.



SOME REASSURING LAST WORDS. You'll find the Business Partner compatible with the IBM* PC/XT. And the Business Partner 286, with the PC/AT. So you'll be able to run the most popular software. You'll also get compatibility with Panasonic's wide range of quality peripherals, for the complete Panasonic office.



And more importantly, both Business Partners are from Panasonic, the company firmly committed to building a high-quality and dependable reputation in computer products. So both are backed with a full-year limited warranty.



For more information, and the location of the dealer nearest you, call **1-800-PIC-8086**. Or write: Panasonic Industrial Company, Computer Products Division, Two Panasonic Way, Secaucus, NJ 07094. And discover how the right Business Partner can make running your business easier. You'll see: **THE EASIER, THE BETTER.**

Panasonic
Office Automation 

ONE MOUSE FOR ALL YOUR APPLICATION SOFTWARE.

Genius Mouse

NEW PRODUCT/CMOS VERSION FOR IBM AND COMPATIBLE COMPUTERS

 * **SOFT-TOUCH SWITCHABLE** *
 * **BETWEEN** *
 * **MOUSE SYSTEM MOUSE** *
 * **AND** *
 * **MICROSOFT MOUSE** *

GM-6 Mouse
 + Genius Paint

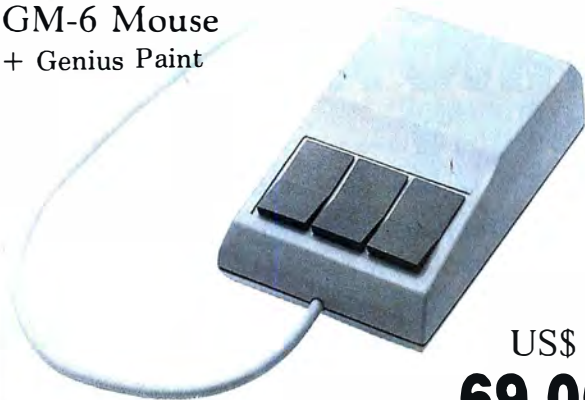

US\$
69.00

Feature:

- * Mouse System Mouse & Microsoft Mouse compatible.
- * No pad. No power supply.
- * Super tracking speed: 500 mm/sec up.
- * Super high resolution: 200 DPI (dot per inch), 0.12 mm/dot.
- * Optical rotary encoder.
- * Silicon rubber coated ball.
- * Connector: D-25P (standard), other type available.

Feature-more only US\$ 69.- per GM-6. That's nothing to sneeze at!
 Yes! Please send me _____ Gm-6 at this special introductory price.

Name _____

Company _____

Address _____

Country _____

- * Air mail postage: 1-5: US\$ 8.-/pc . 6 up: US\$ 6.-/pc
- * American bank check or T/T will be thankful.

KYE KUN YING ENTERPRISE CO., LTD.

P.O. Box 22826, Taipei, Taiwan, R.O.C.
 Office: Rm. 1311, No. 41, Sec. 1, Chung Hsiao W. Rd., Taipei, Taiwan, R.O.C.
 Tel: (02) 331-8779, 381-3682. Telex: 11388 KUNYING. Fax: 2-361-5300

pascal/turbo #244, from billn (Bill Nicholls)
 a comment to message 221

My company is using TP for production programming and we have found the screen differences (and others) to cause some compatibility problems. The best solution to the screen compatibility issue is to use the IBM version 3 compiler for PC and 100% compatibles, but use generic TP version 2 for MS-DOS compatibles, as it still supports reverse video, etc., which was removed from generic v.3. This has not been exhaustively tested but works for our code. The v.2 generic works on a PC also.
 Billn.

pascal/turbo #268, from jdown (Joanne Dow)
 a comment to message 262

At the risk of getting fried for the "C"isms here, this is a very partial listing of the ANSI x3.64 commands. Hope they help.

<^_^>

=====
 c.language/tips #48, from jdown

And printf("\0x1b[%dJ", parameter) will:

parameter	action
0	erase to end of screen
1	erase from start to current (including current)
2	as noted clear screen leaving cursor in place

And printf("\0x1b[%dK", parameter); is the same with line replacing screen.
 printf("\0x1b[%d;%dH); can be: printf("\0x1b[H"); for home cursor or printf("\0x1b[%dH", line); works, as does printf("\0x1b[%dH", column);

cursor	sequence
up	\0x1b[A
dn	\0x1b[B
rt	\0x1b[C (make last two lines "\x1b" into "\0x1b")
lt	\0x1b[D

Note that a parameter can squeeze into the string just after the "[" for a rep count.

index = \0x1bM
 reverse index = \0x1bD

And then we get into the attributes that I won't get into because I am not sure what they'd be implementing. I believe the general sequence would be "\0x1b[%d;%d;...%dm" (any sensible number of %d's in there separated by ";" will work). If the parameter is "0" then all attributes are canceled.

These are ANSI x3.64 defns that, hopefully, they followed in ANSI.SYS but I have no PC to try them on. I'm just reading my terminal defns.
 <^_^>

THE EOF() FUNCTION

pascal/turbo #1036, from mwelch (Mark Welch)

I've been fiddling with a program that will invert a file or set of files (text files) into a binary tree of the words, so I can easily search and locate all instances of a word within the file set. (I know it's been done before, and yes, I'll post it when it's ready.)

To try to cut down execution time, I've been using

(continued)

ONLY PANASONIC® GIVES YOU A BUSINESS PARTNER.™

Everyone seems to be jumping on the bandwagon. Today, companies that weren't there yesterday, and may not be there tomorrow, are building computers from easily assembled components.

The result is a sea of computer clones with little to distinguish one from another.

THE PANASONIC DIFFERENCE—A POWERFUL BUSINESS ALLY. Our approach to offering you a computer was entirely different. We looked at what would work best for you and your business.

The result is the Panasonic Business Partner and Panasonic Business Partner 286. Two powerful business allies, designed to answer your most demanding computer requirements.

YOU CAN SEE THE DIFFERENCE

PANASONIC MAKES. With our long, unparalleled heritage in video technology, you get high-quality, high resolution monitors. An optional Panasonic CGA PLUS board is switchable to let you use a color or monochrome display for both graphics and text.

BUILT-IN FLEXIBILITY. No two businesses run exactly the same way. So you can configure the Business Partners to your own individual needs. In addition to their built-in floppy disk drives, you can add a hard disk drive, additional half-height drives—even a magnetic tape drive.



SPEED AND PERFORMANCE. The Business Partner 286 is built with maximum power and speed. Its 80286 processor runs at 6 MHz or 8 MHz, with the ability of addressing up to 15Mb RAM.

The Business Partner, with its 8086-2 processor, runs at 4.77 MHz, and for projects that need added acceleration, it will run up to 7.16 MHz.

FUTURE GROWTH. Both Business Partners have been designed to grow as your business grows. Extra slots are built in to offer you the flexibility—now and in the future—to add on cards for high resolution graphics, communications accessories and other peripherals.



POWER TO SPARE. As your business grows, you'll put greater demands on your Business Partner. Don't worry, it can handle it. With 130 watts on the Business Partner and 220 watts on the Business Partner 286, you'll be able to drive additional peripherals and expansion boards.

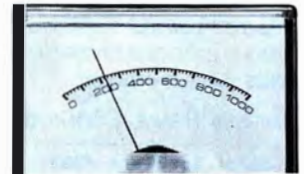

IMPORTANT DESIGN CONSIDERATIONS. The deluxe, detachable keyboards on both models have been designed for comfort and ease of use. We've separated the cursor keys and numeric keys for quick, convenient access. Swivel monitors adjust for each operator. On the Business Partner 286, you can lock the cabinet with a key to help prevent tampering and prying.



SOME REASSURING LAST WORDS. You'll find the Business Partner compatible with the IBM* PC/XT. And the Business Partner 286, with the PC/AT. So you'll be able to run the most popular software. You'll also get compatibility with Panasonic's wide range of quality peripherals, for the complete Panasonic office.

And more importantly, both Business Partners are from Panasonic, the company firmly committed to building a high-quality and dependable reputation in computer products. So both are backed with a full-year limited warranty.



For more information, and the location of the dealer nearest you, call **1-800-PIC-8086**. Or write: Panasonic Industrial Company, Computer Products Division, Two Panasonic Way, Secaucus, NJ 07094. And discover how the right Business Partner can make running your business easier. You'll see: **THE EASIER, THE BETTER.**

Panasonic
Office Automation 

*IBM is a registered trademark of the International Business Machines Corp.

BIX is the BYTE Information Exchange, BYTE's continuous electronic conferencing system. The following excerpts represent conversations taking place on BIX over a number of months and in a number of different conferences. The common ground for all is, of course, the IBM PC. The conferences represented this month are IBM AT, Pascal, Assembler, and BASIC. For information on how to join BIX, see the advertisement on page 320.

IBM PC AND COMPATIBLES

As the most powerful member of the IBM PC family, the PC AT receives a good deal of attention on BIX. In the following excerpts, an address space is explored.

ADDRESS SPACE E000:0000

ibm.at/at.hardware #353, from tanstaaf1 (Dana Cline)

Does anyone know if the 64K bytes starting at E000:0000 is used for anything? On my AT, Debug reads changing garbage there. I think it is mapped to an empty ROM socket. I need to use it for a video board and don't know if it will work reliably. Any ideas?

ibm.at/at.hardware #354, from cjackson (Craig Jackson)
a comment to message 353

The only uses I've ever heard of for that area are the PCjr ROM cartridge slots. One is at D000 and the other at E000. IBM presumably will evaluate new uses for this space as the PCjr becomes less of an issue.

ibm.at/at.hardware #355, from rschnapp (Russell L. Schnapp)
a comment to message 353

This area can be used for onboard BIOS ROM. I don't think the AT has any dedicated purpose for E000:0.

ibm.at/at.hardware #369, from tanstaaf1
a comment to message 353

I've investigated the E000:xxxx address space on my AT and found some interesting things. The results make me wonder about the sanity of Debug. I'm using a video board that looks like RAM to the system. I jumped it to fit in segment E. When using the Debug fill command, no matter what I fill with, it sets the RAM to FFs. When I display that area, it shows garbage. However, the garbage changes. Not only that, a Debug display does not match the hex to the ASCII. The left side has FEs and 5As, while the characters are "<" and "s" (and periods). 5A is "Z", so why does Debug display it wrong?

As far as E000 reserved for BIOS ROM, there is none there that I can find. Does it map to the empty sockets on the motherboard? A Debug dump of D000 shows different stuff, and D000 works for the video board. According to all the manuals, both D and E segments are reserved, unused. AST Research uses D and E to page in their Enhanced Memory Spec memory. What do they know about this area?

ibm.at/at.hardware #383, from rschnapp
a comment to message 369

It appears that E000:0 does, in fact, map to the spare ROM sockets on the AT motherboard. We have Golden Bow disk map chips in our ATs, and when I looked at E000:0, I found their copyright notice (doubled up, of course).

I haven't checked the tech specs yet, to find out if E000 is still available if you don't plug in ROM chips in those sockets.

PASCAL

The Pascal conference is consistently one of the busiest on the system. The following conversations cover a number of topics including setting screen attributes, errant EOF markers, a data compression technique (this is a simple technique in the best hacker tradition), and replacing console output drivers.

SCREEN ATTRIBUTES FROM PASCAL

pascal/turbo #221, from rlang (Robert Lang)

This question breaks down into two parts. First, since Turbo Pascal doesn't have an Inverse or Blink command similar to LowVideo and NormVideo, I have been playing around with attribute bytes. The way I currently do it is to create an absolute variable:

```
MonoScreen : array [ 1..25, 1..80, 1..2 ] of char
absolute $B000:0000;
```

And one for Color screen at \$B800. Then I write into Row, Col, 2 for the attribute byte, the code I want. It works but violates every rule on writing generic software. Is there a way I can use an interrupt or ms-dos call to set an attribute byte that will work on all MS-DOS machines? One that is as simple to use as assigning to an array the Row, Col and either char or attribute byte? (Perhaps a procedure with arguments?)

Second, Microsoft Word does something on a monochrome screen I didn't think could be done. When a bold letter, word, etc., is highlighted it appears in inverse, but with a bold background. (Bold in this case implies intensity on.) Whenever I set the intensity bit on, it only works for foreground, that is, the character, not the background. I just double-checked this and MS Word does in fact have two different intensity inverse backgrounds. Anyone know how they can set background on intense? Could they be using a different character set where the character is the background and the foreground is the shadow of the character? If I knew how, I would love to get a copy of the screen bytes as in the adapter when I have some bold text highlighted with MS Word. I would really like to be able to get intense inverse in my TP program. Granted it is an aesthetic issue, but if MS Word can do it, then there has to be a way in TP.

Sorry about length of question, but I am way over my head and could use any help anyone might offer.
Rob Lang

pascal/turbo #232, from rlang
a comment to message 221

My objective is to be MS-DOS-specific, not IBM PC-specific. My assumption (!?) is that if I keep to generic TP procedures and functions, then I can run my software on other machines. Inherent in this assumption was the capability of the MS-DOS machine to be able to display on the screen

```
Normal Text ( Intense )
Dim Text ( LowVideo )
Inverse
Blinking
```

and hopefully any one of the permutations (inverse blinking of high intensity text!).

Perhaps this assumption is incorrect for all MS-DOS machines and I should admit defeat now and stick with PC-specific software?

Rob Lang

(continued)



PANASONIC® PRINTERS. THEY'RE GENERATING A LOT OF GOOD PRINT.

The good reviews keep rolling in. And, as you can see, the critics agree: Panasonic printers are real winners!

But that shouldn't come as too big of a surprise.

After all, Panasonic printers offer the advanced features and

any bad. Like their reputation, the Panasonic machines are well made, sturdy printers that should serve well in the various applications for which they were designed. To be sure, they produce letter-quality text. About the best...

PC WEEK—JUNE 17, 1986

ease-of-use you've come to expect from Panasonic.

So, whether your business is big, small or in-between, you'll find a printer with features to love every bit as much as the critics. Like—as one

switches and buttons that let you change print sizes and styles right on the printer rather than through the computer. And, with our continuous, self-re-inking ribbons, you'll find yourself changing ribbons

less often. When you do, our snap-in cartridge makes it a snap.

and performance of the KX-P1091. It is a well-built product that promises to deliver many hours of trouble-free operation. The print quality is clear and well-defined. The alignment of characters on adjacent lines is also excellent, a sign of a well-designed paper transport system.

PC PRODUCTS—APRIL, 1985

Finally, just when you thought all this would be hard to top, there's more: all our printers are backed with an unprecedented two-year limited warranty.

Now that you've reviewed all of this for yourself, call toll-free 1 (800) PIC-8086 for the name

ed. / with 30.1 pounds. Like all the Panasonics we tested at, the 1592 comes with the company's exceptional two-year warranty. And like all of them, it definitely rates a look.

of the dealer nearest you. Or you can write to: Panasonic Industrial Company,

PRINTERS BUYERS GUIDE & HANDBOOK #3
Computer Products Division, Two Panasonic Way, Secaucus, NJ 07094. You'll see how easily Panasonic printers generate good print for you.

And you'll agree: **THE EASIER, THE BETTER.**

with this little printer. As far as I'm concerned, the KX-P1091 produces not near letter quality but rather true letter quality in this mode. You'd really have to strain to distinguish it from typewriter quality. Knowing that the text on the page printed, the company produced fast, courteous, and knowledgeable answers.

PC—SEPT. 17, 1985

reviewer observed—extraordinary near-letter-quality on our dot matrix models. They also come standard with impressive high-resolution graphics capability. So you can add graphs, charts, illustrations—even your company's logo.

Not to be outdone, all our daisy wheel printers give you sophisticated advances like boldface, shadow and underline.

Of course, we've put just as much care into the human side of our printers, too. You'll find

Panasonic
Office Automation 
Inquiry 220

ONE MOUSE FOR ALL YOUR APPLICATION SOFTWARE.

Genius Mouse

NEW PRODUCT/CMOS VERSION
FOR IBM AND COMPATIBLE COMPUTERS

* **SOFT-TOUCH SWITCHABLE** *
* **BETWEEN** *
* **MOUSE SYSTEM MOUSE** *
* **AND** *
* **MICROSOFT MOUSE** *

GM-6 Mouse
+ Genius Paint

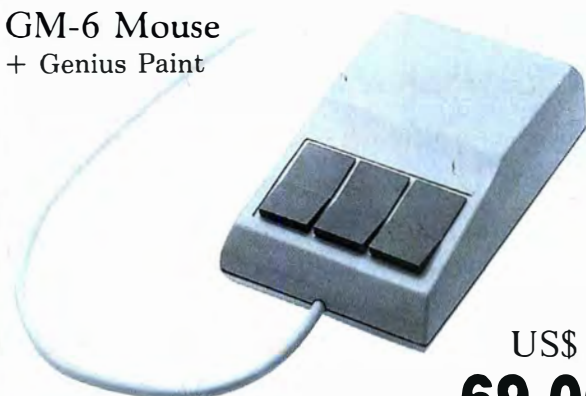

US\$
69.00

Feature:

- * Mouse System Mouse & Microsoft Mouse compatible.
- * No pad. No power supply.
- * Super tracking speed: 500 mm/sec up.
- * Super high resolution: 200 DPI (dot per inch), 0.12 mm/dot.
- * Optical rotary encoder.
- * Silicon rubber coated ball.
- * Connector: D-25P (standard), other type available.

Feature-more only US\$ 69.- per GM-6.
That's nothing to sneeze at!
Yes! Please send me _____ Gm-6
at this special introductory price.

Name _____
Company _____
Address _____

Country _____



- * Air mail postage: 1-5: US\$ 8.-/pc . 6 up: US\$ 6.-/pc
- * American bank check or T/T will be thankful.

KYE KUN YING ENTERPRISE CO., LTD.

P.O. Box 22826, Taipei, Taiwan, R.O.C.
Office: Rm. 1311, No. 41, Sec. 1, Chung Hsiao W. Rd., Taipei, Taiwan, R.O.C.
Tel: (02) 331-8779, 381-3682. Telex: 11388 KUNYING. Fax: 2-361-5300

pascal/turbo #244, from billn (Bill Nicholls)
a comment to message 221

My company is using TP for production programming and we have found the screen differences (and others) to cause some compatibility problems. The best solution to the screen compatibility issue is to use the IBM version 3 compiler for PC and 100% compatibles, but use generic TP version 2 for MS-DOS compatibles, as it still supports reverse video, etc., which was removed from generic v.3. This has not been exhaustively tested but works for our code. The v.2 generic works on a PC also.
Billn.

pascal/turbo #268, from jdow (Joanne Dow)
a comment to message 262

At the risk of getting fried for the "C"isms here, this is a very partial listing of the ANSI x3.64 commands. Hope they help.
<^_>

=====

c.language/tips #48, from jdow

And printf("\0x1b[%dJ", parameter) will:

parameter	action
0	erase to end of screen
1	erase from start to current (including current)
2	as noted clear screen leaving cursor in place

And printf("\0x1b[%dK", parameter); is the same with line replacing screen.
printf("\0x1b[%d;%dH"); can be: printf("\0x1b[H"); for home cursor or printf("\0x1b[%dH", line); works, as does printf("\0x1b[;%dH", column);

cursor	sequence
up	\0x1b[A
dn	\0x1b[B
rt	\0x1b[C (make last two lines "\x1b" into "\0x1b")
lt	\0x1b[D

Note that a parameter can squeeze into the string just after the "[" for a rep count.

index = \0x1bM
reverse index = \0x1bD

And then we get into the attributes that I won't get into because I am not sure what they'd be implementing. I believe the general sequence would be "\0x1b[%d;%d;...%dm" (any sensible number of %d's in there separated by ";" will work). If the parameter is "0" then all attributes are canceled.

These are ANSI x3.64 defns that, hopefully, they followed in ANSI.SYS but I have no PC to try them on. I'm just reading my terminal defns.
<^_>

THE EOF() FUNCTION

pascal/turbo #1036, from mwelch (Mark Welch)

I've been fiddling with a program that will invert a file or set of files (text files) into a binary tree of the words, so I can easily search and locate all instances of a word within the file set. (I know it's been done before, and yes, I'll post it when it's ready.)

To try to cut down execution time, I've been using

(continued)

\$9,900 = 563 MegaBytes

For All PC, XT, AT and RT Applications



Optional integrated 60MB tape back-up
\$1,495

- Data rate to 2.4MB/Sec.
- Average access times as fast as 15 milliseconds
- Breaks DOS 32MB limit

8000 Series 8 inch Winchester technologies intelligently interfaced to microcomputers



Optional integrated 60MB tape back-up

8100 Series 5.25 inch Disk/Tape memory systems

8000A Series

- Mainframe:** NMS Disk/Tape systems and controllers provide economical, compact, and high performance mass storage that can be formatted as one volume. When you need performance and/or storage on your PC, XT, AT and RT, you need the industry standard NMS 8000A series with Multifunction Controller. The SMD-SCSI single board controller you've been waiting for is available now . . . The NMS 8000A.
- Tape Back-Up:** NMS provides ANSI-IBM format 1/2 inch tape systems and 60mb of file-by-file/streamer 1/4 inch cartridge tape systems. (NMS 9000 and PC .25 series).
- Laser Optical:** Complete, 12 inch media, 1000MB memory systems that support DOS applications and format as one volume.
- Warranty:** Controller . . . 24 months (RTV), and 12 months (RTV) all other system parts.

8100 Series

- Selection:** Only NMS provides selection of 8 inch and 5.25 inch technologies. Where speed, power and networking are important . . . NMS is there.
- Tape Back-Up:** An option you control . . . file by file and streamer back-ups. 60 megabytes per cartridge. Fast, reliable, and easy to use. One half inch ASCII/EBCDIC tape systems are available too.
- DOS Limits:** They don't exist with NMS memory systems. We were the first to break the barriers for you!

Call us today!

National Memory Systems
CORPORATION

355 Earhart Way
Livermore, CA 94550

(415) 443-1669

PRICES VALID THROUGH 12/31/86

- When gems lose their luster . . . NMS still shines —
- Compatible with all popular networks —
- One year RTV warranty —

New Quark®/PC Single Board Computer



Base model 5.75" x 8"
Only \$ **495.**

Quantity discounts available

- IBM PC® compatible single board computer mounts to 5 1/4" drive
- Includes Floppy Disk & Color Graphics CRT Controllers plus more

Also includes: Legal BIOS • Boots PCDOS® 2.1 • Printer Port • 2 Serial Ports • 256K RAM • Clock Speed at 4.77 MHz • Alphanumeric and Graphics Modes for Color Video Controller • Standard IBM® Keyboard Port.

Options include: 512K RAM • Piggyback I/O channel OEM Expansion Board • XT - Compatible Hard Disk SCSI Interface • Real Time Clock with battery-back-up • Clock speed of 9.5 MHz (Twice as fast as a PC)

The Megatel Quark/PC is for OEM and end user applications that require PC compatibility in a compact single board computer. The Quark/PC BIOS will run most IBM PC® software including Flight Simulator and Lotus®. To meet your specifications a set of options let you add memory, speed and an XT-compatible hard disk interface. Not only does it quickly mount to a 5 1/4" drive, it also comes with floppy disk and CRT color graphics controllers — all for just \$495.

To order or enquire call us today. Dealer enquiries welcome. Megatel Computer Technologies (416) 745-7214 150 Turbine Drive Weston, Ontario M9L2S2
Telex: 065-27453 U.S. Address: 1051 Clinton St., Buffalo, N.Y. 14206 Distributors: NCS Electronics Varese, Italy • SES Electronics Nordlingen, Germany • Perdex Microtronics Biggin Hill, U.K. • Microcomputing Ghent, Belgium • Asp Microcomputers Melbourne, Australia.

Quark is a registered trademark of I.F. and K.M.F.G. CO. LTD. IBM, IBM PC and PC DOS are registered trademarks of International Business Machines Corp. Lotus is a registered trademark of Lotus Development Corp. MSDOS is a registered trademark of Microsoft Corp.

megatel

Visit us at Comdex Booth #H7642

• BEST OF BIX • **BIX** • BEST OF BIX • BEST

the Execution Timer from the Turbo Power Utilities, and after much agony I've found the single largest bottleneck: the Turbo eof() function. While each call to it takes only a *very* short time, my program calls it very often (2716 times for a typical run), and it takes longer than most other functions. As a result, it accounts for about 30% of the program's total execution time.

Is there any way to cut down on the number of calls to eof() or to speed up eof() or, conversely, to use some other routine?

The code segment in question is:

```
...
var f: file of char; (* can't be text, since I need to
know exact file pos *)
...
repeat
...
until eof(f);
...
```

pascal/turbo #1053, from jimkeo (Jim Keohane)
a comment to message 1036

Invert.pas speedup via blockread

Mark, the following reduced time for inverting a file from 3.40 seconds to 1.27. See "Now" calls for start-stop time displaysconds. - Jim

PS- If garbage past the ^Z in the last block is a problem, then the "for i:=0 to 127" could be changed to "for i:=0 to last" where last was set by a "scan" for ^Z in the current block. See very fast "scan" function in Turbo #757.

PPS- To reduce mem requirements, I would move "Text:S" to end of record description. Then, instead of New(recptr) I would use GetMem(recptr,sizeof(recptr^)-WordLength+Length(St)); That way, if St="HEAD", you save 10 bytes of memory!

```
{=====added for DOS time call=====}
type intregs = record
    case integer of
```

```
0:(ax,bx,cx,dx,bp,si,di,ds,es,flags:integer);
    1:(al,ah,bl,bh,cl,ch,dl,dh:byte)
end;
```

```
procedure time(var
hours,minutes,seconds,hundredths:integer);
var r:intregs;
begin
    r.ah:=$2c;
    msdos(r);
    hours:=r.ch;
    minutes:=r.cl;
    seconds:=r.dh;
    hundredths:=r.dl
end;
```

```
procedure now;
var h,m,s,hs:integer;
begin
    time(h,m,s,hs);
    writeln(h,':',m,':',s,':',hs)
end;
```

```
{=====ADDED to InvertFil=====}
```

```
{p.s. changed fil to just 'file', not 'file of char'}
```

```
var block:array[0..127] of char;
    j,k:integer;
```

```
Begin (* InvertFil *)
```

(continued)



AUTOROUTER
NOW AVAILABLE
FOR ADDITIONAL \$975⁰⁰

EE DESIGNER™
CAE/CAD Integrated Software Package for
IBM PC, XT or AT **\$975**

At only \$975, no electrical engineer can afford to be without this end-to-end circuit design, simulation and PCB layout tool. You can pay up to 15 times more and still not get all the features offered by EE Designer—Schematic Capture... Circuit Simulation... PCB Layout. 30 day money back guarantee. Full purchase price refunded if not completely satisfied. Call 1-800-225-5669 today to order your package. Bank cards welcome.

VISIONICS
CORPORATION
1284 Geneva Drive
Sunnyvale, CA 94089

SOTA Technology Announces MotherCard 5.0™

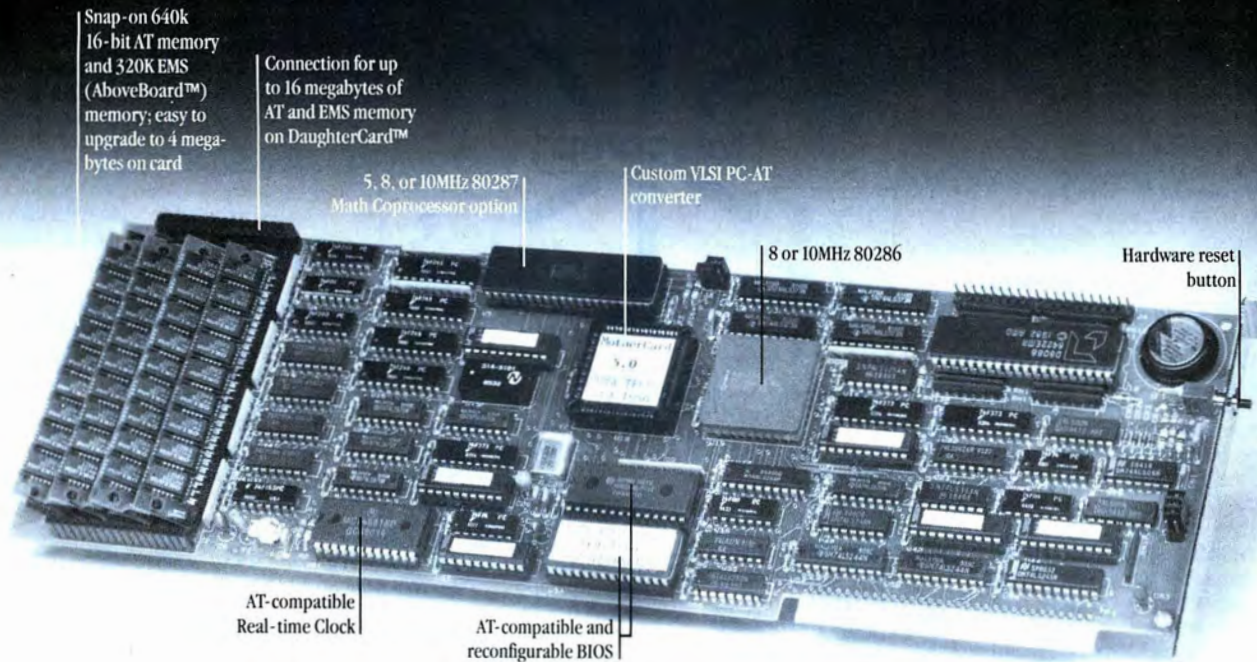

Snap-on 640k
16-bit AT memory
and 320K EMS
(AboveBoard™)
memory; easy to
upgrade to 4 mega-
bytes on card

Connection for up
to 16 megabytes of
AT and EMS memory
on DaughterCard™

5, 8, or 10MHz 80287
Math Coprocessor option

Custom VLSI PC-AT
converter

8 or 10MHz 80286

Hardware reset
button

AT-compatible
Real-time Clock

AT-compatible and
reconfigurable BIOS

**Put this board into your old PC
and get full AT hardware/
software compatibility.
Only \$995!**

Speed is everything

You started using a computer to get your work done faster. Now you'd like your computer to go faster, right?

Easy. SOTA Technology's *MotherCard 5.0* is the quickest and easiest way to upgrade your favorite old PC.

Easy to install: No hardware or software changes required.

Easy to use: simply run your same familiar programs. They just run *seven to ten times faster*.

And it's easy to buy: \$995 makes your current IBM PC system fully AT compatible; that's a lot less than you'd have to invest in any off-brand machine, set up the way your current system is configured.

SOTA's *MotherCard 5.0* is the easiest way to get *faster* and still keep your "old reliable" IBM system.

Compatible with all software.

An ingenious new concept of putting the machine BIOS (Basic Input Output System) into battery-backed RAM insures long-term compatibility with all your software.

You will not only be able to run all your tried-and-true PC software, but anything written specifically for the PC AT, as well.

Hardware compatibility, too!

The SOTA Technology *MotherCard 5.0* is compatible with any other board in your PC. EGA, CGA, LAN, internal modems and tape backup systems all work without a hitch.

The megabyte of 16-bit AT and EMS on-board memory can be expanded with our DaughterCard to anywhere from 2 to 16 megabytes.

Our complex VLSI PC-AT converter handles any signal coming through that requires an I/O call on the system bus.

This allows the 286 to do its 16-bit work at full speed and still talk to the outside world over the 8-bit IBM PC bus.

Magic? No. This is the only way to be fully AT-compatible and still keep your reliable old equipment. And we're the only company doing it this way.

If any new "protected mode" DOS comes along, we know we'll be compatible. It's in the nature of the technology. And, as our name suggests, we deal with *State Of The Art Technology*.

Order your MotherCard 5.0 today! Money back guarantee.

While we are still establishing our dealer network, we want to make the *MotherCard 5.0* available to you without delay.

To order, just call SOTA Technology during West Coast business hours. You can use any major credit card or send a company purchase order or check.

SOTA Technology *unconditionally guarantees the MotherCard 5.0* against defects of workmanship or any compatibility problems. We will gladly replace any card or refund your money in full if you return it within 30 days after receipt.

**TO ORDER, CALL 800-237-1713
In California, call 408-245-3366.**

SOTA™

STATE OF THE ART TECHNOLOGY™
SOTA TECHNOLOGY, INC.
657 N. Pastoria Blvd, Sunnyvale, CA 94086

Trademarks: IBM, PC/XT/AT are trademarks of IBM Corp.

AboveBoard is Intel's. MotherCard, MotherCard 5.0 and DaughterCard are ours.

WE'RE TEACHING COMPUTERS AND VIDEO NEW TRICKS!

INTRODUCING TELECOMP COMPUTER/VIDEO COMBINERS

Now, Add Full Color Video From Any Video Source To Your Micro-Computer Display. . .

VIRTUALLY NO LIMIT TO THE APPLICATIONS

With just a few simple cable connections, TELEcomp lets you interface almost any micro-computer with virtually all video equipment without limitation. Imagine the new horizons your micro-computer can attain with the added power of video. Simulations become real! Demonstrations come alive! Instruction and training can be combined with data displays. Computer graphics and animations mixed with video take on a new dimension. Research and development groups, scientists, doctors, and trainers, to name a few, can generate computer data and make real-time video observations all on a single monitor screen.

RECORD THE COMBINED OUTPUT ON VIDEO TAPE OR DISC

And with the TELEcomp 2000 Series, you can project the signal using any composite or RGB video projector. In fact, you can broadcast the signal or even transmit it by satellite for applications such as teleconferencing, because the TELEcomp 2000 returns an NTSC standard video signal, equal to the quality of the video input—with the computer output combined!

USE WITH MOST MICRO-COMPUTERS. . . NO SOFTWARE REQUIRED

TELEcomp has been engineered to provide you with the maximum in benefits and versatility. TELEcomp interfaces with virtually all computers with TTL or composite video output. This includes IBM PC/XT/AT and compatibles, Apple, Commodore and countless others. Since TELEcomp does all the work, no software is required. Your computer remains free to run the software you want and to perform the jobs you need. TELEcomp's external peripheral design doesn't use up your computer's valuable board slots or memory.

ADD, COMBINE, MIX OR SUPERIMPOSE VIDEO AND COMPUTER

TELEcomp incorporates full window control which permits you to place the video or computer image anywhere on the screen—from a dot to a full screen image (4 dials control the horizontal/vertical window image size). Overlay and source selector switches let you view either computer, video or combined image and then choose which source (computer, video or mix) is dominant. For more flexibility there's even an overlay intensity control. TELEcomp 2000 Series converts your TTL signal to composite video and provides 2 amplified video outputs along with analog RGB output. It even includes a built-in video sync generator in case you want to record, display or project your micro-computer's output when no other video source is present.

MORE VALUE AND A LOT MORE FEATURES STARTING AT UNDER \$400.00

Order the TELEcomp you need. TELEcomp-1000 lets you combine genlockable B+W camera video with computers that have composite video output for only \$399.95. Choose the TELEcomp-2000M to combine monochrome computer output with any color video source for \$995.00. If your needs require color computer output combined with any color video source, order the TELEcomp-2000C for only \$1595.00.

SPECIAL LIMITED TIME OFFER

Order a TELEcomp-1000 with our hi-res. B+W genlockable video camera. Get both for only \$599.00. Save over \$250.00.

ORDER NOW. . . AT THESE INCREDIBLE BREAKTHROUGH PRICES!

All of the capabilities of the remarkable TELECOMP product are available now. With our 10 DAY RISK FREE TRIAL, you can order knowing that TELEcomp will perform to your satisfaction or we'll return your money! Don't delay, order now—call toll free 800-431-6000 and have your Visa, MasterCard or American Express card ready. Or order by writing to the address listed below, enclosing your check or money order with your purchase order. (Prices include shipping/handling; NJ customers add 6% sales tax).

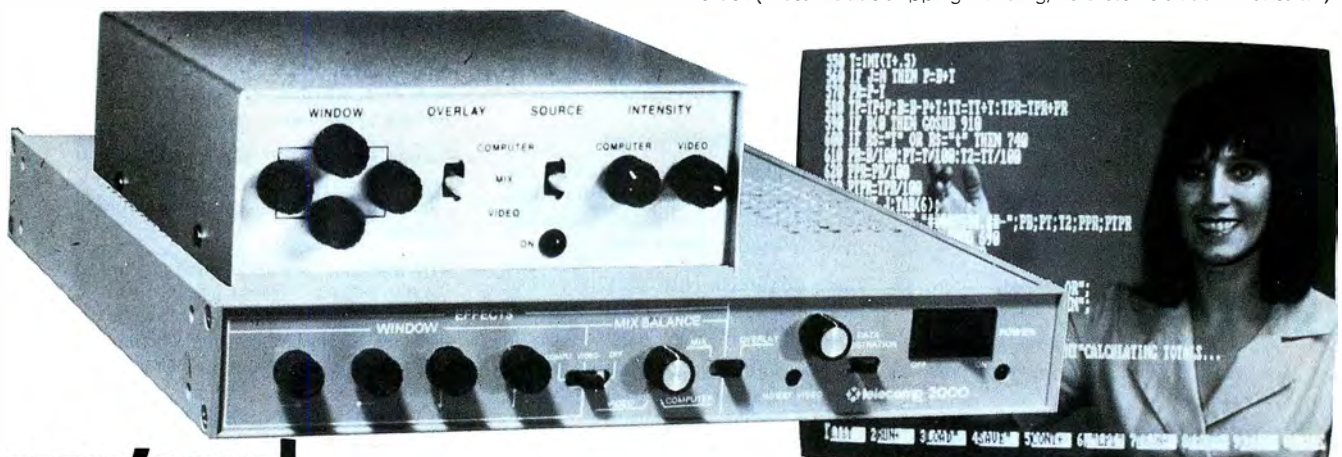
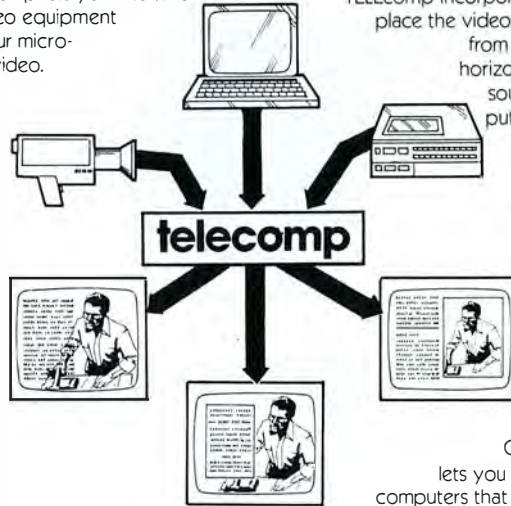

**universal
micro™**

195 Bonhomme Street, P.O. Box 488
Hackensack, NJ, USA, 07602.
International telex 219-804
NJ call 201-487-6340
Toll-Free 800-631-0867

telecomp™
COMPUTER/VIDEO COMBINERS™

Dealer, distributor and OEM inquiries are encouraged.

```

WriteIn('Invert: ',FN); (* let user know what file
we're fiddling with *)
NumFiles := NumFiles + 1;
If NumFiles > MaxFiles (* remove this when FileList
is a linked list *)
then begin (* crash impolitely, trashing all work
done so far *)
    writeln('Too many files inverted: maximum is
',MaxFiles);
    Halt;
end
else FileList[NumFiles] := fn;
Assign(fil,fn);
Reset(fil);
St := '';
Now;          {display time to 100ths sec}
k:=0;          {block no}
blockread(fil,block,1,j); {read first
block}
while (j=1) do
begin
for i := 0 to 127 do {128 bytes
per block}
begin
c:=block[i];
If ((c >= 'A') and (c < 'z'))
and ((c >= 'a') or (c <= 'Z'))
then st := st + UpCase(c)
else if (Ord(St[0]) > 0)
then
begin
matchKey := false;
case st[1] of
'A': matchKey := (st = 'A') or (st =
'AND') or (st = 'AN');
'I': matchKey := (st = 'IN') or (st =
'IS') or (st = 'IT') or (st =
'ITS');
'N': matchKey := (st = 'NOT');
'O': matchKey := (st = 'OR') or (st =
'ON') or (st = 'OF');
'T': matchKey := (st = 'THE') or (st =
'TO');
'Y': matchKey := (st = 'YOU');
end; (* case *)
if matchKey
then
St := ''
else
begin
New(StPtr);
StPtr^.F := NumFiles;
StPtr^.FilPosPtr :=k+i-ord(st[0]);
StPtr^.Next := Nil;
AddWord(St,StPtr);
St := '';
end;
end;
k:=k+128; {add in 128 bytes per block}
blockread(fil,block,1,j) {read next and j=1 if
more}
end;
Now;
Writeln(' Done Inverting ',FN);
End; (* InvertFile *)
    
```

DATA COMPRESSION TRICKS

pascal/turbo #624, from jimkeo

This is a CORRECTION/REPLACEMENT for msg #619, now withdrawn.

You have a VERY LARGE data file filled with REAL numbers, what can ya do? Well, here's what SOME can do. Turbo REALS take 6 bytes. That's a lot of precision

(continued)

OUR TIME IS YOUR TIME.

- Business Applications**
- General Ledger
 - Accounts Payable
 - Accounts Receivable
 - Payroll
 - Inventory Control
 - Purchasing
 - Sales Orders
- Fixed Assets**
- Project Costs
 - Reports
 - Forecasting
 - Word Processing
 - Mailing Lists
 - Information Services

CCRI has taken the time to put together advanced computer equipment, software, and a highly trained professional staff so you won't have to. Our library of software includes applications for accounting, business, engineering and science. We make timesharing easy via dial-up (X.25 or direct), leased lines with dedicated modems, or by using our facilities. No matter which mode of access you choose, you'll find the same experienced professional support and training that our customers have come to expect since 1978. Let us show you how easy it is to put computer timesharing to work in your business. Call CCRI today, to make our time your time.

You can access:

- 3 VAX 11/780's (VMS)
- Fortran, C, Datatrieve
- COBOL, PASCAL, TDMS
- BSO microprocessor development systems
- IT-OS word processing
- 24 Hour Access
- Celerity graphics workstation (UNIX)
- ELXI 6400 (EMBOS)
- Telenet X.25
- Laser printing
- Pen plotting
- Computer VIDEO movies

"We care about your time."

(818) 709-2681
20941 Devonshire St.
Chatsworth, CA 91311



COMPUTER TIME SHARING

Symbolic Debugger for Turbo Pascal

For PC-DOS and MS-DOS computers.

- Examine and modify variables during program execution.
- Set breakpoints at procedures, functions and labels by name.
- Variables are displayed according to their declared types.
- View Pascal source on the screen or send it to the printer while your program is running.
- Line-by-line single step.
- Debug window allows debugging of programs without interfering with screen output.
- *Much more*, including machine-level debugging features.

Suggested retail price: **\$59**

Our mail order price: **\$49**

plus Shipping and Handling:
\$3 US/Canada, \$11 elsewhere.

VISA and MASTERCARD accepted.

Texas residents please add 6.125% sales tax.

Unsure? Send \$2 for a demonstration disc, refunded upon purchase.

Kydor Computer Systems

1701 Greenville Avenue Suite 505
Richardson, Texas 75081
(214) 669-1888

DeSmet C

now with 32-Bit Pointer Option

C88.....still \$109

The editors' choice for fast compilation and execution. The price/performance winner in all major C benchmarks since 1983. Includes Compiler, Assembler, Binder, Librarian, Execution Profiler and Full Screen Editor. Supports both disk and memory resident Overlays. Contains both 8087 and Software floating point support. Full STDIO library.

Large Case Option.....\$50

Makes a great C Compiler even better. Adds 32-Bit Pointers to C88 so you can utilize all of your PC. Groups scalar and static data for fast access. Supports the D88 debugger.

D88.....\$50

Gain most of the benefits of an interpreter while losing none of the run-time speed of the C88 compiler. Display C source and variable contents during execution. Set breakpoints by function name or line number. Examine and set variables by name using C expressions.

order direct from:

C Ware Corporation

505 W. Olive, Suite 767, Sunnyvale, CA 94086 U.S.A.
(408) 720-9696 — Telex: 358185
We accept VISA, MasterCard & American Express

and a big range. Suppose your numbers can be held in an integer. "But my numbers are outside the range - 32768..32767," you say. Well, do ya need them kept exactly or just to a certain precision? Like for graphing purposes. Turbo REALS have an 8-bit signed exponent and a 40-bit signed fraction. The following code has 2 routines called "i2r" and "r2i" which swap numbers between integer and real. The integers are really mini-reals with a 5-bit UNSIGNED exponent and an 11-bit UNSIGNED fraction. The example assumes positive so I don't need that 1 bit for exponent sign. The fraction sign only is negative when the value is less than 2. I get around this by adding 2 in "r2i" and subtracting 2 in "i2r" thus saving another bit. The "integers" can now hold values into the BILLIONS (mebbe I shudda called this a sneakie). The precision is to the nearest 16th when number less than 613, nearest 8th when less than 1025, nearest whole number when less than 4094, nearest even number when less than 8190 and so on. Depending on your needs the below routines might save you a lot of disk space, disk i/o time and RAM! You can always modify the routines to return a 3-byte structure (as a proc, not func) and can thus add greater range and/or more precision and still save 50%!

I use the routines all the time in stock market applications and in many graphics applications. Hope they're useful to you. - Jim Keohane

P.S. The routines are in a program that asks you to enter numbers, then shows you what that number becomes after packing and after unpacking. Use the program with the range of numbers your application requires to see if it is adequate. I have other data compression techniques I'll post. Send me mail if you have a particular data type in question (strings, chars, etc.).

```

program tr;
type both = record case integer of
    0:(r:real);
    1:(b:array[0..5] of byte)
end;
str3=string[3];

var r:real;i:integer;

function r2i(r:real):integer;
var x:both;
    i:integer;
begin
    x.r:=r+2;
    i:=(x.b[0] and $1f) shl 11; {$5 lsb of exponent}
    i:=i or ((x.b[5] and $7f) shl 4); {$hi 7 bits of precision}
    i:=i or (x.b[4] shr 4); {$lo 4 bits of precision}
    r2i:=i
end;

function i2r(i:integer):real;
var j:integer;x:both;
begin
    x.r:=0;
    x.b[0]:=$80 or ((i shr 11) and $1f);
    x.b[5] := (i shr 4) and $7f; {$hi 7 bits precision}
    x.b[4] := (i and $000f) shl 4; {$lo 4 bits precision}
    i2r:=x.r-2
end;

begin
repeat
write('enter real number.....');readln(r);
writeln('orig=',r:12:6,' int=',r2i(r),'
packed/unpacked=',i2r(r2i(r)):12:6);
until r=0;
end.
    
```

Extra advantage: The mini-reals have the bit pattern eeeeehhhhhhllll where eeeee is a 5-bit exponent.

(continued)

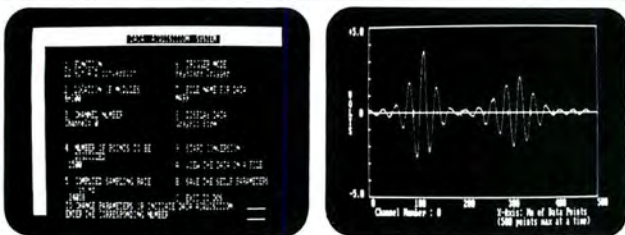

MODULAR DATA ACQUISITION SYSTEM

We Bring Engineers, Scientists And The IBM-PC Together. Our unique high-performance modular data acquisition system allows you to purchase the configuration that exactly meets your requirements.

**8-BIT A/D SYSTEM
\$490**

**12-BIT A/D SYSTEM
\$690**



640x480 on the MULTISYNC™ "Bulletproof" EGA Superset!



1. MS Windows/640 x 480

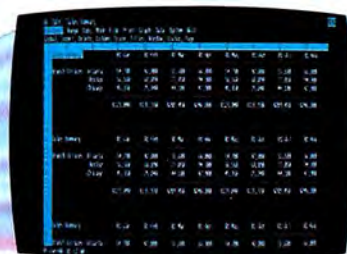
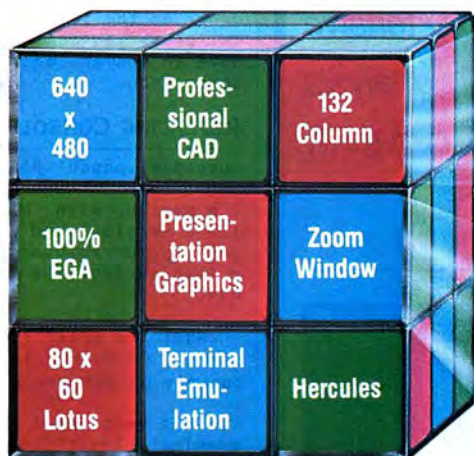

4. 132 Column EGA



2. Guaranteed EGA Compatibility



5. Dr. Halo Zoom Window in EGA or "480" Mode

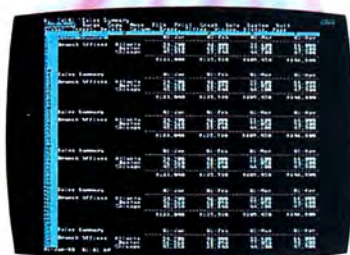

3. 80 x 60 Lotus Spreadsheet in "480" Mode

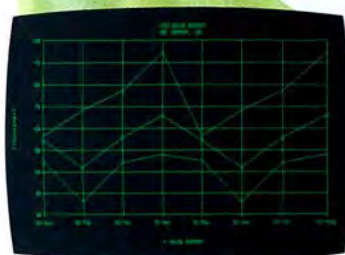

6. Hercules Compatible

Suggested List
\$680.00

FREE
Enhanced
Dr. Halo
Package

Eva™/480 Solves the EGA Board Puzzle!

Can your current EGA graphics board meet the 10 Point Challenge of Eva/480? Let's look at the benefits.

1. Eva/480 Exclusive! 640x480, 16 colors from 64 color palette! Software support for MS Windows, Lotus, Dr. Halo, Halo based products and AUTOCAD!
2. Eva/480 Delivers state-of-the-art in "bulletproof" EGA compatibility! Any program for the IBM EGA will run on Eva/480! Total 256K feature-set includes 16 colors, 64 color palette, smooth scroll, pixel pan and split screen!
3. Eva/480 Exclusive! 80x60 crystal clear spreadsheet with Lotus 1-2-3 in "480" mode! Lotus graphics in 640x480, 16 colors for amazing presentation graphics resolution!
4. Eva/480 Delivers 132x44/28/25 text display in EGA mode! 132 column multiple applications support includes: Terminal emulation, VT100, 3278/79 MOD5. Lotus 1-2-3. Symphony and word processing.
5. Zoom Window/viewport provides a "Power EGA Superset" standard on Eva/480! FREE enhanced version of Dr. Halo supports hardware zoom factors of 2x, 4x, 8x with total viewport access to display memory in both "480" and 350 (EGA) modes! Pixel editing in up to 64 viewport segments! Panning in zoom window! Unparalleled professional power at an unbeatable price.

6. Total downward compatibility with Hercules™ Mono, IBM CGA color via standard CM II Module included in Eva/480 package.
7. Parallel port standard on Eva/480.
8. Incredible utility software support for Lotus, MS Windows, Dr. Halo, Halo-based programs, optional AUTOCAD!
9. One Year Warranty! Made in the USA with Tseng Labs custom VLSI ET2000 Series Chip Set!
10. FREE enhanced Dr. Halo which utilizes advanced "480" mode resolution and zoom window/viewport superset! Complete customer support from Media Cybernetics.

*AUTOCAD Driver Optional \$49.99 (60 day introductory offer—FREE AUTOCAD Driver)

Monitors Supported: IBM Mono and compatibles (Hercules & MDA modes). IBM Color and compatibles (IBM CGA & EGA modes). IBM Enhanced and compatibles (IBM EGA mode). NEC MULTISYNC (Eva/480 mode).

Systems Supported: IBM PC/XT/AT and true compatibles.

EGA is TM of IBM, EGA PAINT is TM of RIX, MULTISYNC is TM of NEC, AUTOCAD is TM of AUTO-DESK, WINDOWS is TM of Microsoft, PC/XT/AT is TM of IBM Corp., EVA/480 is TM of Tseng Labs, HALO is TM of Media Cybernetics, 1-2-3 is TM of Lotus Development Corp., HERCULES is TM of Hercules Computer Technology, VT100 is TM of DEC.



Tseng Labs Inc.

205 Pheasant Run, Newtown, PA 18940 • (215) 968-0502, TELEX 705179

A Software Package

UnkeScope

For the Laboratory

Fast & easy Data Acquisition

plus

extensive analysis capability

Unkel Software Inc.

To order CALL:

(617) 861-0181

FREE demonstration disk available

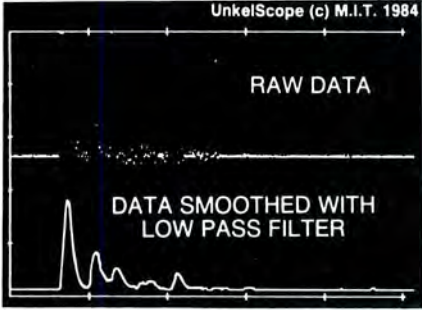

62 Bridge Street, Lexington, MA 02173

AMX

8080 8086 8088

Z80 6809

Now 68000

Real-Time Multitasking Executive

- No royalties
- Source code included
- Fault free operation
- Ideal for process control
- Timing control provided
- Low interrupt overhead
- Inter-task messages

Options:

- Resource Manager
- Buffer Manager
- Integer Math Library

■ Language Interfaces :

C	Pascal		
PL/M	Fortran	AMX for 8080	\$ 800 US

■ DOS File Access :

CP/M-80	8086	950
IBM PC DOS	6809	950
	68000	1600
	Manual (specify processor)	75

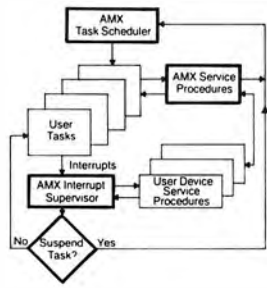

AMX is TM of KADAK Products Ltd.
CP/M-80 is TM of Digital Research Corp.
IBM, PC DOS are TM of IBM Corp.

KADAK Products Ltd. (604) 734-2796
Telex: 04-55670
206-1847 W. Broadway, Vancouver, B.C., Canada V6J1Y5

hhhhhhllll is the fraction broken into high & low significant parts. This means that for real #s less than 2**15-3 (32765) the mini-real retains the same order as the full real. If you wanna test for >, <, =, <=, or >= you can using the mini-real (integer) and not have to convert back to Turbo REALS before every comparison.

REPLACING CONSOLE OUTPUT DRIVER

pascal/ms.pascal #36, from mcmahon (Steve McMahon)

I'm working with MS Pascal 3.31 (Microsoft's, not IBM's version) and would like to find out if there is any way to replace the console output mechanism in such a fashion that the full Write library can still be used.

What I'm after is something like Turbo's ability to use the ConOutPtr to replace the built-in, underlying console output procedure with another.

This version of MS Pascal has the console output seemingly inextricably linked with the DOS2 file system functions. That's fine if you're willing to accept slow console output that can be killed (along with the program) by an inadvertant control-c from the keyboard, but not OK for anything else.

I'd like to get it to use DOS function 6 for output for program versions to be used on generic MS-DOS machines and the IBM BIOS functions on program versions for use on IBMs. Do I have to give up the write, writeln procedures to do this?

Any help will be much appreciated.
Steve McMahon

pascal/ms.pascal #37, from johnm (John McLaughlin)
a comment to message 36

How about using (or writing) a C-type "printf" function with varying numbers of arg's. "printf" may be in pascal.lib, but if not, it would be fairly easy to write. I'm a heavy MS Pascal user.

johnm, portland, or.

pascal/ms.pascal #38, from mcmahon
a comment to message 37

The point of finding a way to replace just the driver is to avoid the work of having to redo the terminal I/O routines. If I have to redo them, I'd probably go with a variety of special-purpose routines (e.g., WriteString, WriteLn, WriteInt ... a la Modula-2) rather than one big, relatively non-portable one.

But, there >>must<< be some way to accomplish the driver replacement. If Microsoft really buried the console I/O inextricably in the file system it seems to me they've compromised the possibility of porting code by forcing the use of non-standard constructs to achieve adequate terminal communication.
Steve McMahon

pascal/ms.pascal #41, from jsprowl (Jim Sprowl)
a comment to message 36

Steve, you should write your screen routine in assembler and link it into your Pascal program as an "extern" function. I wrote a full VT100 emulator that also emulates the DOS ANSI.SYS device driver. It includes Pascal callable entries that let me pass in single characters as well as LSTRINGS. I use ANSI standard escape sequences to position the cursor, etc. If you write an assembly language procedure to accept an LSTRING, watch out -- Microsoft Pascal passes an LSTRING with two words, not one, pushed on the stack.

(continued)

SAVE ON THESE IN STOCK PRINTERS

1080....\$195

NX-10 Call

PANASONIC

1080	195
1091	225
3131	249
1092	309
1592	419
1595	595

EPSON

LX80	CALL
FX85	CALL
DX10	CALL
H180	CALL
HS80	CALL
FX286	CALL
LO800	CALL
LO1000	CALL

SEIKOSHA

SP-1000 VC (C-64)	175
SP-1000 ACentronics	195
SP-1000 IBM	195
SP-1000 As RS-232	195
SP-1000 AP Apple IIC	195
BP-1300	469
BP-5200	649
BP-5420	999
Color Kit	119
BP-5420 Ribbon	12.50
SP-1000 Ribbon	8.50

JUKI

Juki 6100	CALL
5510 Juki	CALL
Juki 6300	CALL
RS-232 Serial Board	55
Color Kit	105
6100 Tractor	119
6100 Sheet Feeder	209

STAR MICRONICS

LV 12-10 (New)	CALL
NL-10	CALL
NX-10	CALL
NB-15	CALL
SB-15	CALL
SG-15	367
SD-10	319
SD-15	438
SR-10	469
SR-15	578
SB-10	589

CITIZEN

120-D	179
MSP-10	285
MSP-15	385
MSP-20	325
MSP-25	485
Premier 35	469

SILVER REED

EXP 420P	CALL
EXP 600P	489
EXP 800P	649
EXP 770	740

LEGEND

+808	148
1080	CALL
1380	229
1385	289

BROTHER

HR-15XL-P	359
HR-15XL-S	359

C.ITOH

1550 SP+	CALL
D1040	CALL
Prowriter Junior	CALL
Prowriter 8510SP	CALL

DIABLO

D25	549
P-32 COI	699
635	1029
P-38	1749
D-80 IF	2395



TOSHIBA

321 P/S	495
351 Sheet Feeder	529
P 341P	969
P 341S	999
P 351+	1149

OKIDATA

Okimate 10XE	179
292	CALL
293	CALL
Okimate 20ST	199
120 NLO	205
182	214
192	348
93	CALL

MONITORS

PANASONIC

TR-122 MYP 12" Amber TTL	139
TR-122 M9P 12" Green TTL	139
TX-12H3P 12" RGB	369
DT-H103 10" RGB	349

ZENITH

ZVM 1220	89
ZVM 1230	89
ZVM 1240	149

HITACHI

MM-1218 12" Green	99
MM-1220 12" TTL Amber	129
CM-1406C 13" color	179
w/ cable	305
CM-1409 13" RGB	305
CM-1216D 12" RGB	385
CM-1455S 13" 720x350	525
CM-1457A 13" RGB	679
720x460	679

TEKNIKA

MJ-10	149
MJ-22	249
MS-305 RGB	309

PRINCETON GRAPHICS

MAX-12 Amber	175
HX-12 RGB	458
SR-12 RGB	575

THOMPSON

365 12 RGB	CALL
------------	------

COMMODORE

1902 Color	CALL
1802	CALL

MODEMS

ZOOM

PC 1200 ST	189
PC 1200 XL	259
PC 1200 XL/PFS	279

ANCHOR

Volkmodem	55
Volkmodem 12	179

US ROBOTICS

Password 1200M	189
Courier 2400	395

MISCELLANEOUS

DUST COVERS

PC-AT 2 pc	10 99
PC-XT 2 pc	10 99

JOYSTICK

Tac 10 (Apr/Pc)	22 95
-----------------	-------

DISK NOTCHERS...\$7.95!!

AST

Six Pack Plus	209
---------------	-----

TANDON

*320K 1/2" Drive	115
------------------	-----

STB

EGA Plus	329
----------	-----

DISKETTES

MAXELL

SSDD	9.99
DSDD	12.99

BONUS

SSDD	6.99
DSDD	7.50

SKC

SSDD	8.50
DSDD	9.50

BRODERBUND (IBM)

Bank Street Writer	48.95
Print Shop	34.95
Graphics Library 1	22.95
Graphics Library 2	22.95
Ancient Art of War	22.95
Champ Lode	
Runner	22.95
Karateka	22.95

MICRO-LEAGUE (IBM)

ML Baseball	24 95
General Manager	24 95
85 Team Disk	14 95

INNOVATIVE CONCEPTS

Flip-N-File 10	2.49
Flip-N-File 25 Lock	10.95
Flip-N-File 50 Mini	10.95
Flip-N-File 50 Lock	15.95
Flip-N-File ROM	7.99

NAME BRAND VIDEO TAPES
from \$4.49
Qty. Discounts Available

SUBLOGIC (IBM)

Set Simulator	34.95
Scenery Disks	Each 14.95
Set 1-6	69.95
S.D. Japan	14.95
S.D. San Francisco	14.95

SSI (IBM)

Battle for Normandy	24.95
Knights of Desert	24.95
Tigers in Snow	24.95
Computer Baseball	24.95
Cartels & Cutthroats	24.95

ACTIVISION (IBM)

Borrowed Time	24.75
Mindshadows	24.75
Music Studio	29.95
Alter Ego	29.95
Alter Ego (Male)	29.55

QUADRAM

Gold Quadboard	399
Silver Quadboard	229
Quadboard	199

LEADING EDGE

Nutshell	69 95
Nutshell Filer	149 00

TOLL FREE 1-800-233-8760

In PA 717-494-1030
Customer Service 717-494-1670

or send order to
Lyco Computer
P.O. Box 5088
Jersey Shore, PA
17740



RISK FREE POLICY

In stock items shipped within 24 hours of order. No deposit on C.O.D. orders. Free shipping on prepaid cash orders within the continental U.S. Volume discounts available. PA residents add sales tax. APO, FPO, and international orders add \$5.00 plus 3% for priority mail service. Advertised prices show 4% discount for cash, add 4% for MasterCard and Visa. Personal checks require 4 weeks clearance before shipping. We do not guarantee compatibility. We only ship factory fresh merchandise. Ask about UPS Blue and Red label shipping. All merchandise carried under manufacturer's warranty. Return restriction applicable. Return authorization required. All items subject to change without notice.

Inquiry 172

NEW HOURS!

Mon-Thur 9AM-8PM
Fri 9AM-6PM
Sat 10AM-6PM

NEW HOURS!

Mon-Thur 9AM-8PM
Fri 9AM-6PM
Sat 10AM-6PM

AMERICA'S MAIL ORDER HEADQUARTERS

LYCO COMPUTER MARKETING & CONSULTANTS

LYCO COMPUTER MARKETING & CONSULTANTS

Charge Through Your Number Crunching

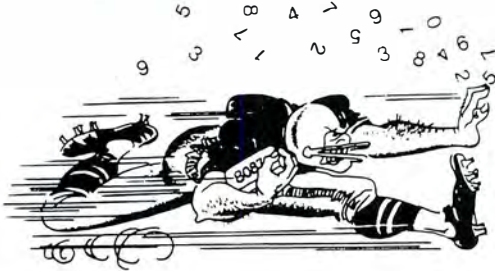

with **MATHPAK 87™**

MATHPAK 87 is a perfect tool for anyone doing scientific or engineering computation. **MATHPAK 87** is a set of over 130 assembler coded routines for virtually all common mathematical operations. These routines are specifically designed to extract the utmost performance from your 8087/80287 coprocessor and run up to 20 times faster than equivalent high level language routines. A 1K complex FFT takes 1.85s; a 1K real FFT takes 1s. The Fortran versions support single, double and mixed precision arithmetic. **MATHPAK 87** routines are easy to use — you simply call them from your programs. A detailed, 180 page manual (full of examples) gets you started in minutes.

MATHPAK 87 has routines for:

- real & complex vector/matrix/scalar operations
- matrix eigenvalues/vectors
- matrix decomposition
- matrix factoring
- convolution
- statistical operations
- FFT's — complex, real, 2D, etc.
- solution of linear equations
- solution of differential equations
- spectral analysis, windowing
- Kalman filtering
- numerical integration
- data fitting

To make full use of your 8087/80287 chip order **MATHPAK 87** today.

\$89 (US) for Turbo Pascal, \$119 (US) for Microsoft/IBM Pascal, Microsoft/IBM Fortran, IBM Professional Fortran, Lattice C or Microsoft C versions.

MasterCard, checks, money orders and company purchase orders accepted. Specify compiler. Please add \$5 for shipping and handling (\$10 overseas).

Precision Plus Software, 4095 Kingston Road, Suite 172, Scarborough, Ontario, Canada M1E 2M3. Telephone (416) 761-5309.

The first word is the LSTRING length, and the second word is its address within the DATA segment. This is not documented anywhere that I can find. There are some good examples in the IBM Pascal manual of how to pass parameters to an assembly language program.

Assembly language functions are really simple — just place the return argument in the AX or AL register, if I remember correctly. Make sure to pop off just the same number of bytes as Pascal pushed onto the stack, or the computer will head off into never-never land.

If you pass a byte to an assembly language routine by value, the byte will be placed on the stack along with a byte of padding so that a word is placed on the stack — caveat emptor!

Let me know if you would like some sample code.

pascal/ms.pascal #43, from mcMahon
a comment to message 41

That sounds wonderful, but ...

What I was really after was a way to replace the terminal output driver and retain the ability to use all the compiler magic of the Write/WriteLn routines. Writing assembler EXTERN routines is no particular problem: I've done lots before and would have to do another to do what I'm proposing. Except that what I'm proposing doesn't seem to be possible, judging from the reaction here.

To re-iterate:

In Turbo, you can replace the console output driver with a statement like:

```
ConOutPtr := Ofs( MyReplacementRoutine );
```

where MyReplacementRoutine is a function that takes a character as a value parameter. So, in Turbo, you can write a little inline code to handle an alternative console output technique, initialize the ConOutPtr at the top of the program and forget about it!

I guess Microsoft doesn't believe we'd really like to use the Write/WriteLn routines for anything other than slow, redirectable output!

Steve McMahon

ASSEMBLY

Though high-level languages have gotten the lion's share of publicity in the last few years, assembler remains the language tool of choice for many applications. The Assembler conference on BIX has topics covering most of the popular microprocessors in use today. These excerpts from the 8088 topic cover screen writing attributes and writing custom interrupt handlers.

REPLACING DOS INTERRUPT HANDLERS

assembler/cpu8088 #27, from Leroy (Leroy Casterline)

I am an experienced C programmer and have come to the point in my life where learning 8088 ASM is necessary. I need to write a few routines in ASM to be called from (Lattice) C and am looking for pointers (no pun intended) to good sources of learning material or any tips you folks would be willing to share with me.

I need to write a couple of interrupt service routines (pref in C) and must come up with a method of replacing the DOS interrupt handlers with pointers to

(continued)

Demo Disk Available



MACH 2 TURBOCHARGES BASIC

Turbo Pascal Version coming soon!

Brand new from the publishers of The Inside Track and Peeks 'n Pokes, MACH 2 is a library of ultra fast assembler subroutines for interpreted and compiled BASIC. Many functions faster than Turbo Pascal and C. Debug interpreted and compile the same program with no changes.

MACH 2 includes: Window Manager (also draws boxes) • Extra Memory Manager—store/sort/search data using all available DOS memory • Controlled input routine ignores Ctrl-C and Ctrl-Break • Display data 4-10 times faster than BASIC—instantly when compiled • BLOAD/BSAVE in compiled BASIC • Read/write files at DOS speeds • Scroll windows any direction • Print using for numbers up to 6 times faster than BASIC • Change file attributes — hide, unhide, read-only, etc • Get & change default drive/current directory • DOS/BIOS function calls and interrupts • Many more functions, sample programs and a manual explaining the use of each routine.

No assembler program or knowledge of assembler programming is required. **MACH 2** can be used by beginners.

Still not convinced? Send us a check for \$5 and you will receive a demo disk. That \$5 will be deducted from the purchase price of MACH 2.

MACH 2 is only \$75.00 and is not copy protected. Include our subroutines in your programs with no royalties. Requires DOS 2.00 +, GW-BASIC or IBM BASIC. Video routines require IBM or compatible. Others run under any MS-DOS 2.00 +. Compatible with Quick BASIC 1 & 2, BASCOM 1 & 2, MS compilers.

SHIPPING AND HANDLING. \$3 USA, \$5 1st class (Canada) \$18.00 elsewhere. We welcome MC/Visa/COD (add \$3 COD). To order call 1-800-922-3383. In Georgia, or for tech support, call 404-973-9272.

MicroHelp, Inc. • 2220 Carlyle Drive • Marietta, Georgia 30062

You Can Get Programming Software Anywhere

Here Are 10 Reasons Why You Should Insist On LIFEBOAT.

Everything the professional programmer needs, from a wide selection to our Tech Support Hotline to our competitive prices! Lifeboat's got the answers ...and the reasons why you'll insist on Lifeboat!

1 Latest Versions of Top-Rated Programs ... An unbeatable selection of up-to-the-minute programs. Including...

ADVANTAGE C++ • Advanced Trace 86 • ASCOM IV • BASIC_C • Bastoc • BetterBASIC, Math Support, Runtime • Brief • Btrieve • C-86 • C-FOOD Smorgasbord • C Power Packs • csd C Source Debugger • C-terp • C-Tree • Essential C Utility Library • Curses • CVUE • dBC III • db_Vista • dBX • Dr. Halo II • EMACS • Essential Graphics • Fast C • FirTime • Float 87 • Greenleaf Comm Library • Greenleaf Functions • GSS Graphic Development Toolkit • GSS Toolkit — Plotting • Halo • Hammer Informix • Instant C • Lattice C • Let's C • LMK • LSE • Mark Williams C • Microsoft BASIC Interpreter, C, COBOL, FORTRAN, Macro Assembler, Pascal • QuickBASIC • Norton Utilities • Opt-tech Sort • Panel • Pasm86 • PC-Lint • Periscope I • Periscope II • Pfix86 Plus • PforCe • Phact • Plink86 Plus • Pmaker • Pmate • PowerMake • Pre-C • ProFORTRAN • ProPascal • Ptel • Quelo Linker/Assembler • Rtrieve • RUN/C-The C Interpreter • RUN/C Professional • Text Management Utilities • TopView Toolbasket • VEDIT • VEDIT PLUS, V-PRINT, V-SPELL • Wizard C • WINDOWS FOR C • WINDOWS FOR DATA • Xtrieve • ZView

...and so much more!

2 Wide Selection ... Over 200 Programs to choose from, including C++, C, BASIC, Pascal, RPG II, Translators, Editors, Function Libraries, Language Utilities, Data Base Record Managers, Graphics, Communications and more!

3 Tech Support Hotline ... Immediate help with technical problems for all the software we publish. Lifeboat's there when you need us most!

4 Programming Tools Guide... a comprehensive reference catalog to help you select programs best suited to your needs.

5 Personal, Professional Advisor ... Your own Account Rep to advise you on the best programming software for your specific needs.

6 Automatic Update Service ... The easiest way to stay on top of the software market, with automatic notification of all new and updated programs, pre-tested and reviewed by Lifeboat.

7 Newsletter, Conference & Seminar Programs ... to keep you up-to-date on the newest products, technical developments and technical support relating to the world of software programming.

8 Special Orders ... In addition to our extensive selection, Lifeboat offers customers the option to select from an open ended product line.

9 Competitively Priced ... Our prices are competitive with those of other suppliers that offer none of the essential services to which we are committed.

10 Prompt Delivery... Our huge inventory allows Lifeboat to ship most of our products the same day they are ordered, including overnight deliveries.

BRAND NEW FROM LIFEBOAT

ADVANTAGE C++

They say you can't be all things to all people. But Lifeboat's *ADVANTAGE C++* proves that you can be! This exciting new product, developed by AT&T, represents a major programming breakthrough. By introducing the concept of classes, it enables programmers to use object-oriented programming methods. Plus it gives you a host of other major improvements over C.

ADVANTAGE C++ gives you the ability to create new functionality to solve your applications problems. It allows programmers to more productively build large and sophisticated applications. All the benefits of C, without its limitations.

ADVANTAGE C++ is available for the most popular C compilers, Lattice C and Microsoft C.

So why be limited to just C... when you can have all these pluses! *ADVANTAGE C++* exclusively from *LIFEBOAT*.

1-800-847-7078 In NY: 914-332-1875

LIFEBOAT

The Full-Service Source For Programming Software

International Sales Offices
Australia
Fagan Microprocessor Associates
Phone: (61) 3699-9899
Canada: Scantel Systems
Phone: (416) 449-9252

England: Grey Matter, Ltd.
Phone: (44) 364-53499
Italy: Lifeat Associates, S.p.A.
Phone: (02) 656-841
Japan: Lifeboat Japan
Phone: (03) 293-4711

Spain: Micronet, S.A.
Phone: (34) 1-457-5056
The Netherlands:
GIGA Computer Products
Phone: (31) 10-771846

West Germany:
MEMA Computer GmbH
Phone: (49) (069) 34 72 26
Omnitex
Phone: (49) (076) 23 61820

PC/VI

Full Screen Editor for MS-DOS (PC-DOS)

Looking for an Ultra-Powerful Full-Screen editor for your MS-DOS or PC-DOS system? Are you looking for an editor FULLY COMPATIBLE with the UNIX*VI editor? Are you looking for an editor which not only runs on IBM-PC's and compatibles, but ANY MS-DOS system? Are you looking for an editor which provides power and flexibility for both programming and text editing? If you are, then look no further because PC/VI IS HERE!

The following is only a hint of the power behind PC/VI: English-like syntax in command mode; mnemonic control sequences in visual mode; full undo capability; deletions, changes and cursor positioning on character, word, line, sentence, paragraph or global basis; editing of files larger than available memory; powerful pattern matching capability for searches and substitutions; location marking; joining multiple lines; auto-indentation; word abbreviations and MUCH, MUCH MORE!

The PC/VI editor is available for IBM-PC's and generic MS-DOS based systems for only \$149. For more information call or write:

Custom Software Systems
P.O. Box 678
Natick, MA 01760
617-653-2555

The UNIX community has been using the VI editor for years. Now you can run an implementation of the same editor under MS-DOS. Don't miss out on the power of PC/VI!

*UNIX is a trademark of AT&T Bell Laboratories.

9-TRACK MAG. TAPE SUBSYSTEM FOR THE IBM PC/XT/AT AND...



For information interchange, backup and archival storage, IBEX offers a 9-track, IBM format-compatible 1/2" magnetic tape subsystem for the IBM PC, featuring:

- IBM format 1600/3200 and 800 cpi.
- Software for PC-DOS, MS-DOS.
- Also for DEC, VAX, VME, S-100, RS-232, IEEE 488.

IBEX

IBEX COMPUTER CORP.
20741 Marilla St.
Chatsworth, CA 91311
(818) 709-8100
TWX: 910-493-2071

Write, phone or TWX for information.

the C functions that will actually process the interrupt. I need to write a general-purpose routine that will allow me to specify the interrupt number to replace and a pointer to the C function. Anyone had experience with this?

Thanks in advance,
Leroy

assembler/cpu8088 #28, from barryn (Barry Nance)
a comment to message 27

Leo Scanlon's "IBM PC & XT Assembly Language: A Guide for Programmers" is a decent text on the subject.

I could put about 60 lines of assembler code here that replaces an interrupt vector (part of a program I wrote). Want it?

assembler/cpu8088 #29, from hvanderbilt (Henry Vanderbilt)
a comment to message 28

Somebody's bound to get some good out of it. Put it up!

assembler/cpu8088 #30, from barryn
a comment to message 29

OK, you asked for it. (Seriously, it's a code fragment from a GRAPHICS.COM-type replacement that I wrote for the Okidata 92/93 printers. It is about 60 lines long, so, for those not wanting it, you can skip the next message. BTW, pardon that it occurs in uppercase; I apologize in advance.)

assembler/cpu8088 #31, from barryn

```
TITLE: Code fragment for interrupt replacement
;
;   INITIALIZATION CODE (NOT PART OF RESIDENT)
;
INIT_CODE:
    ASSUME  CS:CODE
    PUSH   DS                ; set up DOS
                                return
    MOV    AX,0
    PUSH  AX
;
;   IF WE'VE BEEN HERE BEFORE, THEN
;   SAY SO AND EXIT GRACEFULLY.
;   (JUST RETURN TO DOS; WE'RE ALREADY
;   RESIDENT)
;
    ASSUME  DS:INT_5_LOC
    MOV    AX,INT_5_LOC    ; establish
    MOV    DS,AX          ; addressability
;
    MOV    DX,INT_5_OFS
    ASSUME DS:CODE
    MOV    AX,CS
    MOV    DS,AX
    MOV    AX,OFFSET MAIN_ROUTINE
    CMP    AX,DX           ;BIOS interrupt
                                in place?
    JNE    P010_CONTINUE  ;yes, go ahead &
                                replace
;
    MOV    DX,OFFSET ERRMSG
                                ;no,say'already
                                here'
    MOV    AH,9H
    INT    21H
;
    RET                    ;FAR RETURN TO DOS
;
;   outline of initialization logic:
;   1. REPLACE INTERRUPT 5 VECTOR ADDRESS
;      (WITH ADDRESS OF
;      MAIN_ROUTINE)
```

(continued)

THE CURE FOR COPY WOES.

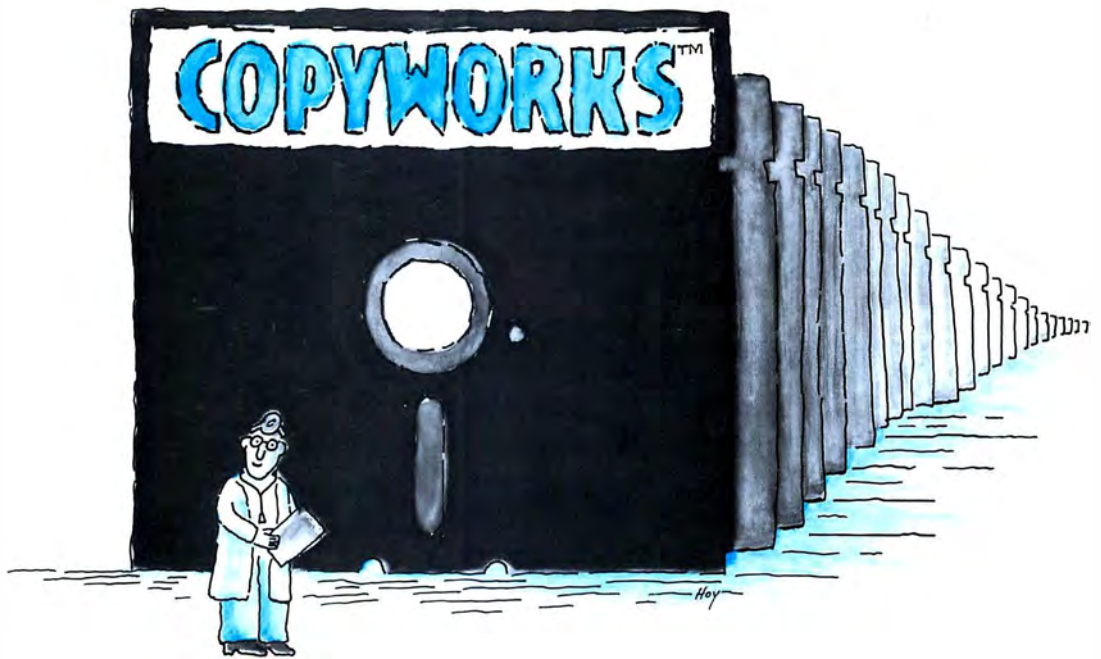

COPYWORKS® is the ultimate software duplication system, unequalled for versatility, power, and customized options.

COPYWORKS is designed by Vault Corporation to maximize your PC/MS-DOS® software production capabilities and will enhance your disk production output whether you hand feed disks or use an autoloading machine such as Vault's PROLOADER®.

COPYWORKS verifies good diskettes and rejects bad ones, and is just as effective at copying unprotected software as it is at producing copy protected diskettes using Vault's award winning, patented PROLOK® protection, or serialized UNILOK® for networking or easy field updating of protected programs.

COPYWORKS uses an IBM® PC as the host computer, but can be configured to work in a variety of environments under many different copy formats.

Multiple slash (/) options allow you to:

- Produce single-sided or double-sided diskettes.
- Create disks with 8 or 9 sectors per track.
- Use Vault fingerprinted diskettes or plain diskettes.
- Create hidden files, system files, and read-only files.
- Assign serial numbers to successfully copied diskettes.
- Assign password for absolute access control.
- Execute custom programs during the duplication process.

Additional data files may be purchased allowing you to produce:

HARD DISK PROLOK and UNILOK diskettes with easy to follow help screens enabling end users to install/uninstall protected programs and data files onto a hard disk and to make executable backup copies on floppy diskettes.

CHRONOLOK® with a limited number of runs of protected programs from 1-32,000 for demo disks or sale-by-situation such as psychological testing, where specified numbers of execution are desired.

No longer do you need to be locked into a single duplication configuration. COPYWORKS gives you the freedom of choice that is every American's birth right.



For ordering your COPYWORKS package call tollfree:
800-445-0193 (US)
or 800-821-8638 (CA)
or write: Vault Corporation,
2192 Anchor Court, Unit C,
Newbury Park, California 91320.

COPYWORKS.™

THE ULTIMATE DUPLICATION SOFTWARE.

Copyright © 1986 Vault Corporation. Copyworks, Prolok, Unilok, Chronolok, Proloader are trademarks of Vault Corporation.
PC-DOS and MS-DOS are trademarks of International Business Machines and Microsoft Corporations.
Printed in U.S.A.

The BCC52 packs an entire development and acquisition system into a single dose.

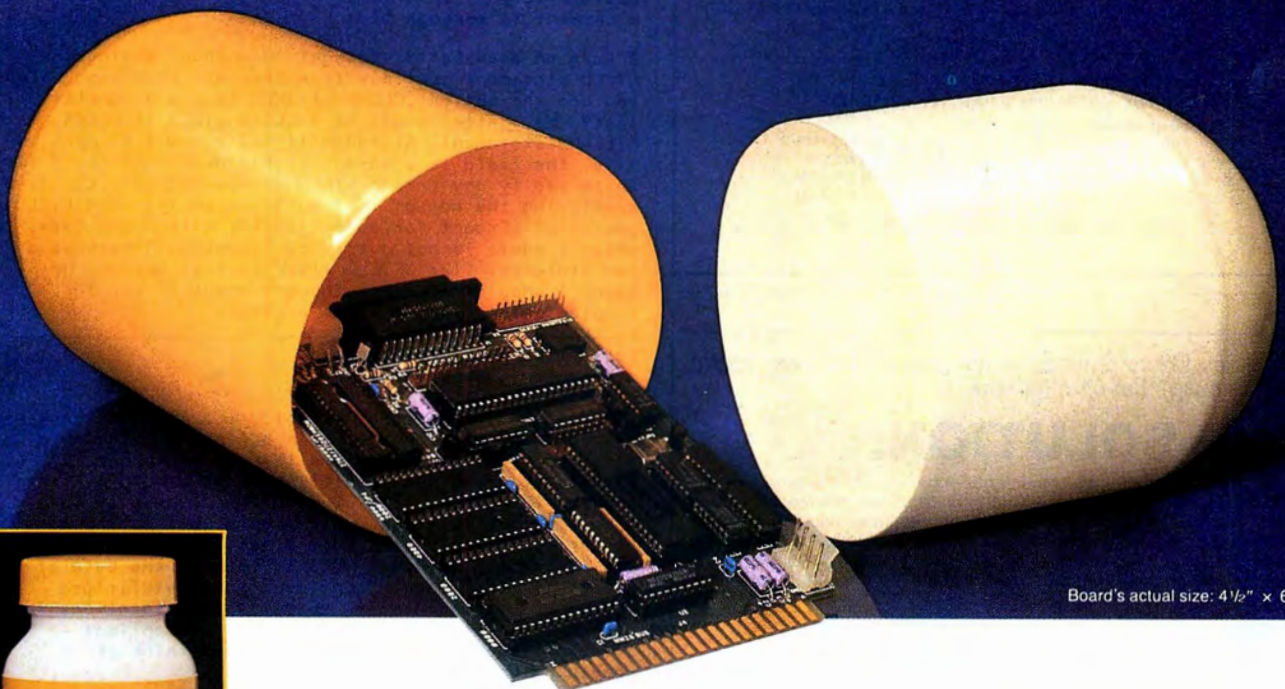

Board's actual size: 4 1/2" x 6 1/2"



Indications for use:

When a single controller board or a complete development and acquisition system is needed.

Active Ingredients:

Intel 8052 8-bit processor, 8K floating point ROM resident control BASIC, 3 on-board parallel I/O ports,

Serial terminal port (auto baud rate select), Serial printer port, Socketed for 48K bytes RAM and EPROM, 2 interrupts, Expandable to 64K bytes each of data and program memory, On-board intelligent 2764/27128 EPROM programmer.

Dosage: Take either a single board or an entire system to provide control relief.

CAUTION:

This product has proven to be habit forming.

*Now available without prescription
from Micromint for only*

\$152*

*100 quantity OEM price

CALL TOLL FREE

1-800-635-3355

In Connecticut call: 1 871-6170

Micromint, Inc. 25 Terrace Drive, Vernon, Connecticut 06066 TELEX: 643331



FORTRAN PROGRAMMERS

Looking for the right PC FORTRAN LANGUAGE SYSTEM? If you're serious about your FORTRAN programming then you should be using F77L- LAHEY FORTRAN.

Editor's Choice - PC Magazine

- Full FORTRAN 77 Standard (F77L is not a subset)
- Popular Extensions for easy porting of minicomputer and mainframe applications
- COMPLEX*16, LOGICAL*1 and INTEGER*2
- Recursion - allocates local variables on the stack
- IEEE - Standard Floating Point Arithmetic
- IMPLICIT NONE
- Long variable names - 31 characters
- Fast Compile - Increase your productivity
- Source on Line Debugger (Advanced features without recompiling)
- Arrays and Common Blocks greater than 64K
- Clear and Precise English Diagnostics
- Compatibility with Popular 3rd Party Software (i.e. Lattice C)
- Easy to use manual
- Technical Support from LCS

• NEW FEATURE - NAMELIST

F77L - THE PROGRAMMER'S FORTRAN \$477.00 U.S.

System Requirements: MS-DOS or PC-DOS, 256K, math coprocessor (8087/80287)

FOR MORE INFORMATION: (702) 831-2500



Lahey Computer Systems Inc.

P.O. Box 6091 Incline Village, NV 89450/USA

International Dealers:

England:	Grey Matter Ltd.,	Tel: (0364) 53499
Denmark:	Ravenholm Computing,	Tel: (02) 887249
Australia:	Computer Transitions	Tel: (03) 537-2786
Japan:	Microsoft, Inc.,	Tel: (03) 813-8222

SERVING THE FORTRAN COMMUNITY SINCE 1967

Would you like to reduce the number of hours you spend programming? Let us offer you

THE SOLUTION.

Reducing your programming hours can provide you with the extra time you need to unleash your creativity. That can mean the difference between making a living and making it big. Let our products help you generate innovative software with minimum effort. Use our tools to expand the capabilities of current programs without scrapping existing code. Let PSI put you ahead of the competition by streamlining your software development effort.

TURBOLINK +

"... TURBO Pascal hackers will like this program."

Jerry Pournelle
Byte Magazine

- Build up to 574K of TURBO Pascal* code in user memory in up to 9 separately compiled modules
- Add up to 512K of TURBO Pascal procedures to programs written in:
 - BASIC, BASICA, Compiled BASIC
 - Microsoft Pascal and Fortran
 - Standard, 8087 and BCD TURBO Pascal
 - TURBO Prolog
 - Assembly Language, Lattice C
- Automatically generate TURBO Pascal compatible inline machine code.
- Use all TURBO Pascal variants together in a single program.
- Add AI capabilities to existing code with TURBO Prolog*.

TURBOMATRIX

TURBOMATRIX is a complete source code library of matrix algebraic operations. Use this library of TURBO Pascal procedures and functions for engineering and scientific analysis. Includes:

- Matrix addition, multiplication, constant multiplication
- Inversion
- Eigen value/eigen vector calculations
- I/O procedures and functions

FOR IBM PC/COMPATIBLES

\$6995 EACH, S&H included
(Foreign orders add \$10.00)

VISA/MC: 1-800-835-2246 X 123
Inquiries, orders, info:
(303) 971-0729

PATHFINDER
SOFTWARE, INC.
P.O. Box 43
Littleton, CO 80160

*TURBO Pascal and TURBO Prolog are registered trademarks of Borland International

A\$(), #1, 256 BY 1? Or FIELD #1; A\$(256) BY 1? Maybe even FIELD #1, A\$(1-256) BY 1 or FIELD #1, 1 AS A\$(256)

Is the horse dead yet? (smirk) Is it obvious I've read Pascal and PL/I? (grln,chuckle)

basic/misc #51, from btonkin
a comment to message 50

Your examples would seem ambiguous, syntactically. The nice thing about the CFIELD statement is that you could have an integer array specify the individual FIELD lengths. It's not clear that any of yours could do the same. Further, A\$(256) already has a meaning in BASIC; using it the way you did would be, er, confusing at best. How would you like FIELD #1, USING F(), A\$() Where F() is an array holding the field lengths, and A\$() is the array of separate fields, in order?

No, I don't think the horse is dead yet. Kick 'lm again, Dan.

basic/misc #52, from dmick
a comment to message 51

I have an even better thought. How about having the FIELD statement continue from the last statement unless you add the option ,CLEAR or ,NEW to the parameter list? No, better would be a CLEAR FIELD or CLEAR FILENUM statement. Although if you close & re-open the file, the field is cleared, right? How about that? Is there really any reason FIELD should not mean continue specifying the map of this buffer from the last FIELDed position? (Except for compatibility with older code, which I admit is not a trivial exception.) Perhaps a new statement like CFIELD *is* the best option. Or maybe I should have just thought about it for 10 minutes before saying *any* of this.

basic/misc #53, from btonkin
a comment to message 52

Sounds like a good idea, except . . . I think there may be a problem with the "of this buffer" part. Could make for horrendous problems in compiled programs, especially given the possibilities of a GOTO statement mucking things up. The other problem I see is one involving multiple FIELD statements, all to the same buffer, existing at the same time. I use that one a lot, depending on how I want to look at the data at the time. If FIELD meant "continue from last fielded location," it would screw up multiple allocations for sure. I'm pretty sure CFIELD isn't the optimal solution, though. Someone's bound to think of something better. Any more ideas?

basic/misc #54, from barryn
a comment to message 53

(timidly...) I kind of like the way it works now. If I have to redefine part of a record, I can use the FIELD statement the way you've described. If I want to have multiple FIELD statements that want to follow one another across a record, I just put a FillerX\$ item at the beginning of each new FIELD statement whose size exactly covers the already-defined portion of the record.

basic/misc #55, from btonkin
a comment to message 54

No need to be timid. Your approach is exactly what I've been doing for years. Still, it seems like rather a waste, and in interpreted BASIC you end up having to watch to make sure you don't make the filler longer than 255 characters (boom! string too long). That latter problem means you've got to use multiple dummy strings explicitly in the FIELD statement for long records, and the line length limitation will eat you up pretty soon.

(continued)

1	Exxon	25	Standard Oil (Ohio)	49	Consolidated Foods	73	American Home Prod.	97	North American
2	General Motors	26	AT&T Technologies	50	Lockheed	74	Litton Industries	98	
3	Mobil	27	Boeing	51	Georgia-Pacific	75	Hewlett-Packard	99	
		28	Dow Chemical	52	Monsanto	76	Control Data	100	H...
5		29	Allied	53	W.R. Grace	77	Texas Instruments	101	
6	Texaco	30	Eastman Kodak	54	Signal Companies	78	LTV	102	F
7	E.I. du Pont	31	Unocal	55	Anheuser-Busch	79	American Brands	103	PPG Inc
		32	Goodyear	56	Nabisco Brands	80	International Paper	104	Int. H&
		33	Dart & Kraft	57	Johnson & Johnson	81	Motorola	105	American
		34	Westinghouse Elec.	58	Coastal	82	Burroughs	106	Borg-V
		35	Philip Morris	59	Raytheon	83	Archer-Daniels-Midland	107	American Cy
		36	Beatrice Foods	60	Honeywell			108	Kerr I
		37	Union Carbide	61	Charter	85	Borden	109	United
		38	Xerox	62	General Mills	86	Champion International	110	
		39	Amerada Hess	63	TRW	87	Armco	111	Emerson E
		40	Union Pacific	64	Caterpillar Tractor	88	Esmark	112	Dresser Ind
		41	General Foods	65	Aluminum Co. of Amer.	89	Diamond Shamrock	113	Boise C.
		42	McDonnell Douglas	66	Sperry	90	CPC International	114	Warner C
		43	Rockwell Int.	67	Gulf & Western Ind.	91	Time Inc.	115	Owens-
	ITT	44	PepsiCo	68	Continental Group	92	Deere	116	Car
		45	Ashland Oil	69	Bethlehem Steel	93	Bristol-Myers	117	America
		46	General Dynamics	70	Weyerhaeuser	94	Martin Marietta	118	Reynolds I
		47	3M	71	Ralston Purina	95	Firestone Tire & Rubber	119	Campbel
		48	Coca-Cola	72	Colgate-Palmolive	96	IC Industries	120	Kimberly

While American business is trying to stay competitive with foreign companies, it's paying an added penalty. The penalty of double-digit illiteracy.

Believe it or not, 27 million American adults can't read and write. Another 47 million are literate on only the most minimal level. That adds up to almost one third of our entire population...and probably a disturbing number of *your* employees.

What does illiteracy cost you? Get out your calculator. Illiterate adults make up 50%-75% of our unemployed. Every year they cost us an estimated \$237 billion in lost earnings. They swell our welfare costs by \$6 billion annually and diminish our tax revenues by \$8 billion.

Illiteracy costs you through your community, too. It robs the place where you work and live of its resources. It undermines the potential of the people who make your products and the people who buy them. No dollar figure can be assigned to this. But over the years, this may be the costliest loss of all.

What can your company do about this? It can join in local efforts to fight illiteracy. It can volunteer company dollars and facilities for better school and tutorial programs. It can invest in a more literate community.

The first step is to call the Coalition for Literacy at **1-800-228-8813** or fill out the coupon below. Do it today. You may find it's the greatest cost-saving measure your company has ever taken.

- I want my company to join the fight against illiteracy. Please send brochure with additional information.
- We want to discuss funding the Coalition for Literacy. Please have a representative contact me.

Name _____

Title _____

Company _____

Address _____

City _____ State _____ Zip _____

Phone _____

Please return to: Coalition for Literacy
Business Division
P.O. Box 81826
Lincoln, NE 68501-1826

**A literate America
is a good investment.**

In compiled BASIC under CP/M, you have the same problem; no string can be longer than 255 characters. If you want to write transportable programs, you end up with scads of useless dummy variables cluttering up the code, and FIELD statements that look like their nearest ancestor was spaghetti.

So, the question: what should we do instead?

basic/misc #59, from bwaldheim (Bill Waldheim)
a comment to message 46

Bruce, I've been programming in BASIC (Microsoft & GW) for about as long as you have and I agree. The FIELD statement didn't cause me any problems once I became comfortable enough in BASIC to start messing around with files. The beauty of BASIC is that I could write little 10-line programs of the "Gee, I wonder if this'll work" type. I think some beginners have the mistaken idea that they must write useful code right from the start, but that ain't the way to really learn anything. The machines may lock up, but they don't blow up. And avoiding the FIELD statement won't make life any easier later on when writing let's say an accounting program that accesses 50 to 100 accounts. Having to scan them all from the beginning via a sequential type file will really spoil what might otherwise be a good program. So to all you novices out there, jump in and get your feet wet and DON'T be afraid of making mistakes. That's part of the learning process!!!

Bill Waldheim

basic/misc #60, from bwaldheim

Bruce, I'm putting these comments in as I scan the new messages, so that's why there are two from me. The CFIELD sounds like a sensible solution to me. As far as clearing things out, as was mentioned in an earlier message, I wish BASIC had a dBASE-type CLEAR statement that you could use to DISCREETLY release variables from memory instead of the shotgun it now has. How sweet it would be!

Bill

basic/misc #61, from btonkin
a comment to message 60

A possible way to work around the CLEAR statement would be a CHAIN that allowed an EXCEPT for variables you wanted killed. Often, I get programs where CHAIN ALL is too inclusive, and COMMON is far too much of a pain.

COUNTING "ON" BITS IN A WORD

basic/one liners #15, from jimkeo

I forget where exactly on BIX this problem was first posed. The problem was to code a routine that calculated the number of one (1) bits in a word. One solution was to use each byte of the word as an index into a 256-byte table preset with the appropriate counts. Another solution that I suggested is the following: Function fmbt(I) returns the number of bits

(continued)

Why Settle For An Impersonal Computer?

Now you can have your own **PERSONALIZED USER INTERFACE** and add **VOICE CONTROL** to any PC-DOS/MS-DOS application program. PRONOUNCE™ is the revolutionary new product from Microphonics that lets anyone develop a custom-tailored user interface to word processing, spreadsheet, DBMS, CAD/CAM, and accounting programs. No programming is required.

PRONOUNCE is more than menus, more than macros, more than voice control. PRONOUNCE is a universal user interface enhancement system that works together with DOS, your keyboard, mouse, digitizer, and application program to make you more productive than you ever thought possible.

Impatient with time-consuming menus and tedious keystrokes? Add "expert mode" to your programs and perform hundreds of instructions *fast* with a single spoken command!

Confused by "computerese" and having to run diverse applications that don't work the same? Add "novice mode" to operate DOS and intergrate diverse programs using a single *standardized* set of commands.

PRONOUNCE is featured in the exciting new Microphonics ProVOX™ XT pictured here. The ProVOX XT integrates PRONOUNCE with an AT-speed IBM-compatible PC, 20 mb hard disk, electronic mailbox, dial-in security, and top-rated communications modem. All for just \$2495.

Or buy PRONOUNCE separately and add a personalized voice-controlled user interface to the IBM-compatible PC of your choice. Complete systems start at just \$695.

Major credit cards and COD accepted. Dealer inquiries welcome.

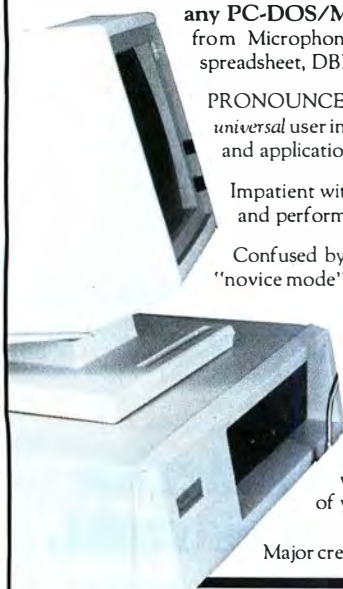

Microphonics™

The Leader in Voice Technology.

Microphonics Technology Corporation
25-37th Street N.E., Suite B
Auburn, WA 98002
(206) 939-2321 Telex 797839

Call Today
1-800-325-9286

COMPATABILITY GUARANTEED OR WE'LL EAT IT!

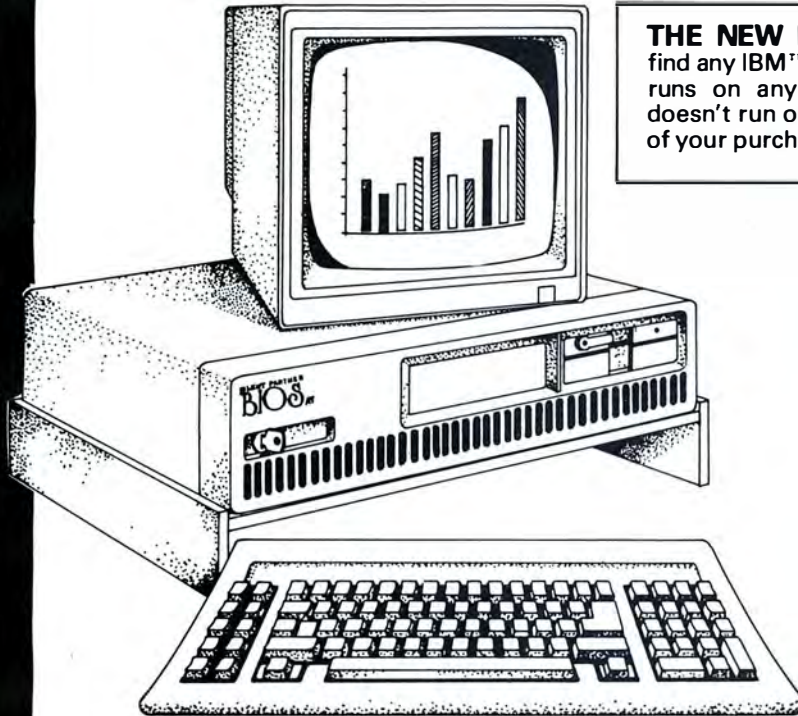

THE NEW BIOS™ GUARANTEE* - If you find any IBM™ Compatible Software Package that runs on any other compatible computer and doesn't run on the BIOS™ AT. We'll refund 100% of your purchase price.

- 640K RAM
- 80286 16 Bit Processor
- 8 Mhz 0 Wait States
- 6 Mhz 1 Wait States
- 84 Key AT Style Keyboard
- MS™ DOS (Latest Version)
- GW™ Basic
- Advanced Diagnostics
- 20 MB Fixed Disk Drive Included
- Users Manual
- 8 Expansion slots
- 6 16 Bit Slots
- 2 8 Bit Slots
- Serial/Parallel Board
- Hard Disk Contoller Supports 2 Floppy & Two Fixed Disk Drives
- FCC Class B, UL, & CSA Approved
- Made in Japan
- 90 Days on site service by Intellogic Trace
- Extended on site 9 month service warranty only \$109.00 dealer
- 550 pages of easy to use documentation

NOVELL COMPATIBLE
8 MHZ 0 WAIT STATES
PETER NORTON SYS INFO RATES THE BIOS™ AT 9.2

FREE
90 DAYS ON SITE SERVICE

Distributed by:
DISTRIBUTION PLUS
Call USA (800) 638-7654
MD (800) 492-5316
For Dealer Near You

BIOS™ is a trademark of Silent Partner Corporation
IBM is a trademark of International Business Machine.
MS™ DOS is a trademark of Microsoft Corp.
GW™ Basic is a trademark of Microsoft Corp.

OFFER LIMITED TO UP TO \$2950*
TO RETAIL PRICE OF **Sugg. Retail Price**

* Offer limited to up to dealer cost of \$1999, 30 days after invoice purchase date. BIOS must be returned complete, as new, in original box with all accessories, manuals, diskettes, cables, etc. to apply. Program must be compatible with DOS 3.2 - must be original purchaser of BIOS™. Offer void where prohibited by law. Purchaser must present original invoice and proof of payment (cancelled check, charge slip, etc.) to Silent Partner Corp. to qualify. Silent Partner has the right to refuse refund for any legitimate reason.

***Individual Retailers Prices May Vary**

SILENT PARTNER
BIOS™ AT

7313 Grove Road, Frederick, Maryland 21701

>Count Bits...

Touche! Juan. I guess I got a little carried away with functions. - Jim

basic/one.liners #18, from btonkin
a comment to message 16

Elegant solution, Juan! All I'd change in that one would be the part that reads $B=INT(B/2)$. Better would be $B=B\backslash 2$; it does the same thing!

basic/one.liners #19, from jimkeo
a comment to message 18

>Count Bits...

Bruce & Juan, I did some checking and the count-bits problem was first posed in soft.eng/algorithms #47. Another cute solution. Though it can't be contained on one line due to a GOTO, it has merit in that it loops one time for every 1 bit rather than 16 times. Statement 50 can be omitted if you have overflow checking disabled. It makes use of the fact that "B=B AND (B-1)" turns OFF the rightmost bit.

- Jim Keohane
PS- Taken from C code posted by rfoxmich in soft.eng/algorithms #80

```
10 GOTO 80
20 K=0
30 IF B=0 THEN RETURN
40 K=K+1
50 IF B=&H8000 THEN RETURN
60 B=B AND (B-1)
70 GOTO 30
80 INPUT "Number....",B
90 GOSUB 20
100 PRINT K
```

basic/one.liners #20, from juan
a comment to message 18

Now that is interesting. "\" you say? OK, I'll try it. What follows is a THREE liner. Believe it or not, it is a full implementation of the Quicksort algorithm. To call it, fill array LN\$() with the elements to be sorted and set N to the maximum element to go up to when sorting. On return LN\$(N) will be sorted!

```
1000 S=1:STACK(S)=1:STACK(S+1)=N:WHILE
S>0:L=STACK(S):R=STACK(S+1):S=S-2:WHILE
L<R:I=L:J=R:X$=LN$((L+R)/2):WHILE I<=J:WHILE
LN$(I)<X$:I=I+1:WEND:WHILE X$<LN$(J):J=J-1:WEND:IF I<=J
THEN SWAP LN$(I),LN$(J):I=I+1:J=J-1
1010 WEND:IF I<R THEN S=S+2:STACK(S)=I:STACK(S+1)=R
1020 R=J:WEND:WEND:RETURN
```

Enjoy.

|1|

PS- If LN\$() is very big, then dimension STACK() out to about 20 or 30, not much more, since by that point you should write an assembly language version.

|1|

basic/one.liners #21, from juan
a comment to message 19

As a matter of fact, I think it can. Try this out:
10 K=0:WHILE (B<>0) and (B<>&H8000):K=K+1:B=B and (B-1):WEND
It should work, but I don't guarantee it. I just winged that one.
|1|

basic/one.liners #22, from jimkeo
a comment to message 21

>WENDs...

Hmmmmmm. Gotta brush up on my WENDs. Forgot about WHILE-WEND. - Jim
PS- It won't work 'cause K will end up zero if B is

&H8000 initially. Mebbe change "K=0" to "K=ABS(B=&H8000)" That should do it!

basic/one.liners #23, from juan
a comment to message 22

Question: Why do you need that &H8000 anyways?
|1|

basic/one.liners #24, from jimkeo
a comment to message 23

>&H8000 test
Otherwise, ya get OVERFLOW with "B-1" when B=&H8000 (-32768). Of course, you can disable OVERFLOW as I think I mentioned with the example. - Jim

MS-DOS

The activity in the MS-DOS conference reflects the fact that a high percentage of BIXen (and BYTE readers) own or use IBM PCs (or clones). This thread is centered on the very disturbing situation of a destructive program being distributed through public domain channels. The name of this program, ways to recognize other vandal programs, and possible ways to protect a machine from damage are discussed.

AN ATTACK ON THE PUBLIC DOMAIN

ms.dos/other #464, from dondumitru (Donald Dumitru)

TITLE: ARC513.COM is a TROJAN!
WARNING! WARNING! WARNING! WARNING! WARNING!

The program ARC513.COM is a TROJAN! It will alter the boot sector on your hard disk, preventing you from booting from your HD until you do a PHYSICAL FORMAT! Do *not* run this program! If you see it posted on a BBS, tell the sysop about it! I am attempting to track down the source of the copy that I have - wish me luck.

I had warned the sysop of the board that I got ARC513.COM from, after I had heard previous warnings from BIX and FidoNews, but before I downloaded it to test it myself. He said he ran check4bomb on it, and it passed as "safe". From my (very limited) debugging of ARC513.COM, I'd say that that thing does weird things to make it hard to trace through. It is even possible that it tests whether it is being run under Debug or not.

Donald

PS- But it definitely does things to your hard disk. I ran it *twice*, and had to do a physical format after each run.

ms.dos/other #469, from dondumitru
a comment to message 467

These are the details of my experience with ARC513.COM.

I first became aware of this program from messages posted on BIX by "wheelock," warning that he had heard rumors about ARC513.COM being a trojan.

The next day, as I cruised past a local BBS, I noted that ARC513.COM was in the "recent uploads" section. I left a message to the sysop, warning him about the program. He left a reply thanking me for the warning, then another reply stating that he had run Check4Bomb, and that the program had passed as "safe" (so he left it posted).

A couple of days later, in FidoNews #319, there was a warning (unsigned) that stated that ARC513.COM was

(continued)

COMPATABILITY GUARANTEED OR WE'LL EAT IT!

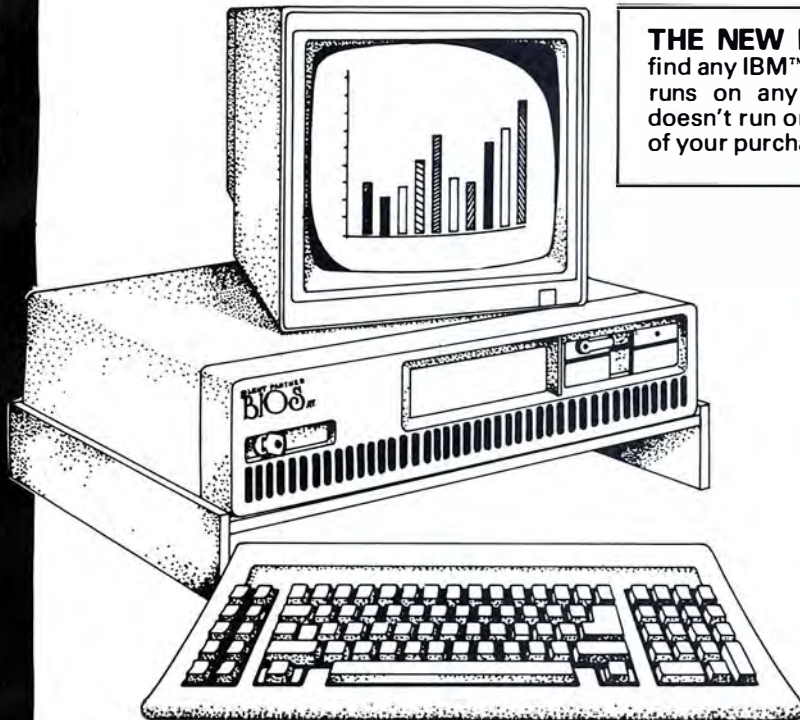

THE NEW BIOS™ GUARANTEE* - If you find any IBM™ Compatible Software Package that runs on any other compatible computer and doesn't run on the BIOS™ AT. We'll refund 100% of your purchase price.

- 640K RAM
- 80286 16 Bit Processor
- 8 Mhz 0 Wait States
- 6 Mhz 1 Wait States
- 84 Key AT Style Keyboard
- MS™ DOS (Latest Version)
- GW™ Basic
- Advanced Diagnostics
- 20 MB Fixed Disk Drive Included
- Users Manual
- 8 Expansion slots
- 6 16 Bit Slots
- 2 8 Bit Slots
- Serial/Parallel Board
- Hard Disk Controller Supports 2 Floppy & Two Fixed Disk Drives
- FCC Class B, UL, & CSA Approved
- Made in Japan
- 90 Days on site service by Intelogic Trace
- Extended on site 9 month service warranty only \$109.00 dealer
- 550 pages of easy to use documentation

NOVELL COMPATIBLE
8 MHZ 0 WAIT STATES
PETER NORTON SYS INFO RATES THE BIOS™ AT 9.2

FREE—
90 DAYS ON SITE SERVICE

Distributed by:
DISTRIBUTION PLUS
Call USA (800) 638-7654
MD (800) 492-5316
For Dealer Near You

BIOS™ is a trademark of Silent Partner Corporation
IBM is a trademark of International Business Machine.
MS™ DOS is a trademark of Microsoft Corp.
GW™ Basic is a trademark of Microsoft Corp.

OFFER LIMITED TO UP TO \$2950*
TO RETAIL PRICE OF **Sugg. Retail Price**

* Offer limited to up to dealer cost of \$1999, 30 days after invoice purchase date. BIOS must be returned complete, as new, in original box with all accessories, manuals, diskettes, cables, etc. to apply. Program must be compatible with DOS 3.2 - must be original purchaser of BIOS™. Offer void where prohibited by law. Purchaser must present original invoice and proof of payment (cancelled check, charge slip, etc.) to Silent Partner Corp. to qualify. Silent Partner has the right to refuse refund for any legitimate reason.

***Individual Retailers Prices May Vary**

SILENT PARTNER
BIOS AT

7313 Grove Road, Frederick, Maryland 21701

in I that are ON (0 thru 16). It has application where individual bits are used as switches and you wish a count.

- Jim Keohane

```

1 DEF FNB1(I)=(I AND &H5555)+((I\2) AND &H5555)
2 DEF FNB2(I)=(FNB1(I) AND &H3333)+(FNB1(I)\4) AND &H3333
3 DEF FNB3(I)=(FNB2(I) AND &HF0F)+((FNB2(I)\16) AND &HF0F)
4 DEF FNBB(I)=(FNB3(I) AND &HFF)+((FNB3(I)\256) AND &HFF)
5 DEF FNBT(I)=FNBB(I AND 32767)-(I<0)
6 print fnbt(32767),      fnbt(-1),      fnbt(255),
fnbt(0)
7 REM                    15          16          8          0
    
```

basic/one.liners #16, from Juan (Juan Orlandini) a comment to message 15

```

1 CIXI=0:FOR IXI=1 TO 16:CIXI=(B AND 1)+CIXI:B=INT(B/2):NEXT IXI:B=CIXI:RETURN
    
```

Now that is what I call a ONE-LINER. It counts the number of bits in a word. Just set B equal to the word and then call it. B will return the number of bits on. By the way, this comes directly from a Pascal program that I wrote.

|1| Moderator of the Osborne Conference.

basic/one.liners #17, from jimkeo a comment to message 16

(continued)

Still Waiting?

ATTENTION BERNOULLI BOOSTERS

Go Either Way!

BOOT

from the Bernoulli Box!
from the AT Hard Disk!

FORMAT WITH DOS
PARTITION WITH FDISK
NO SLOWING

We've been shipping Bernoulli Boots that work for over a year — still waiting?

Golden Bow Systems

\$95-\$110
Add \$3 for shipping/handling.
California residents add 6% sales tax



P.O. Box 3039
San Diego, CA 92103
(619) 298-9349

Inquiry 113

TURBO MASTER

Turbo Master is an integrated development system for Turbo Pascal programmers consisting of six floppy disks and a manual. The components of this system include the following: Turbo Screen master, Turbo ISAM Master, Turbo Menu Master, Turbo Toolkit Master, and Resident ISAM Master. The Turbo Screen Master features Intelligent Cursor which allows you to draw boxes and borders by simply moving the cursor to the desired position, and Extended Variable Names which allows the use of arrays and structures in your variable names. The Turbo ISAM Master generates ready to run Turbo programs using Borland's Turbo Pascal Database Toolbox: It automatically interfaces to Turbo Screen Master. The Turbo Menu Master features a menu data base and an interactive menu builder allowing for the automatic entry and reorder of selections and users choice of procedure, chain, execute or comment code generation for each selection. The Turbo Toolkit Master includes procedures for full control over all screen attributes, advanced string functions, automatic control of multiple help screens, saving and retrieving screens to RAM buffers, Caps/Num/Scroll/Lock control procedures, and report procedures. The Resident ISAM Module Module uses less code space, provides a key buffer data area outside your program's data space. All of these programs are available as a package for:

Money Back Guarantee **\$99.95** plus 7.50 S&H
Hawaiian Village Computer Software
1109 Pennsylvania Ave., St. Cloud, FL 32769
Info: (305) 892-5686 (800) 821-9503

Inquiry 121

LOW COST HIGH RESOLUTION DATA LOGGING for IBM PC/XT/AT®

15-Bit four input channel system
7 samples/second with hardware and menu driven software \$415

Expand system above by 15 analog input channels (64 max.)... \$165

Add thermocouple thermometry to above, 6 channels for..... \$175

Add 16-bit, 12,000 sample/second capabilities to above for... \$210

Call for quantity pricing or for quotes on custom hardware, software or complete systems.

LAWSON LABS, INC.

5700 Raibe Road
Columbia Falls, MT 59912
Phone: 406 387-5355



Inquiry 161

IBM-PC Schematic Design

A professional package enabling you to design, edit, print & plot electronic schematics. Supports "A" through "E" size sheets, over 2000 Unique Library Parts, Part Rotation, Unlimited Hierarchy, Grids, Auto Panning, 5 Zoom Levels, Rubberbanding, Powerful Macros, Hi-Res Color & Monochrome Graphics, Much More! \$495 Includes Everything.

Call To Receive Free Demo Disk.

OrCAD Systems Corporation
1049 S.W. Baseline St.
Hillsboro, OR 97123
(503) 640-5007



Inquiry 213



Sure it's insured?

SAFEWARE® Insurance provides full replacement of hardware, media and purchased software. As little as \$39/yr. covers:

- Fire • Theft • Power Surges
- Earthquake • Water Damage • Auto Accident

For information or immediate coverage call:

1-800-848-3469

In Ohio call 1-614-262-0559



SAFEWARE. The Insurance Agency Inc.

Inquiry 249



ROSE DATA SWITCHES

SHARE computers, printers, any parallel or serial device
ELIMINATE cable swapping
INEXPENSIVE way to network
COMPATIBLE with all computers.
Businesses, Schools, Homes

WE ALSO OFFER:
Data Buffers, Line Drivers, Modems, Protocol Converters, Parallel - Serial Converters, Cables, Computers, Printers, Disk Drives, and more.

AUTOMATIC - CARETAKER is ideal for a business or school to share a printer or modem among many computers. Operation is fully automatic with no software required.
Parallel or Serial 4 channels - \$295 8 channels - \$395

MANUAL - HARD SWITCH is operated with the flip of a switch. 2:2 and 2:4 models allow simultaneous communication.
Serial 1:2 - \$55 1:4 - \$99 2:2 - \$109 2:4 - \$169
Parallel 1:2 - \$79 1:4 - \$139 2:2 - \$119 2:4 - \$199
LED and spike protection on serial models add \$20.

CODE ACTIVATED - PORTER connects one computer to multiple peripherals. A software code selects the peripheral.
Parallel or Serial 4 channels - \$295 8 channels - \$395
Buffer option 64K - \$100 256K - \$250

REMOTE - TELEPATH connects multiple computers to multiple peripherals. A selector at each computer or terminal chooses up to 4 peripherals and displays busy status.
4:4 - \$495 4:8 - \$795 selector - \$39.

Give a Rose to your computer

ROSE ELECTRONICS (713) 933-7673
P.O. BOX 742571 MC & VISA Accepted
HOUSTON, TX 77274 Dealer Inquiries Invited
CALL US FOR ALL YOUR INTERFACE NEEDS

Inquiry 245

A COMMAND PERFORMANCE

Your performance depends as much on your instrument as it does on your ability.

XyWrite III is a critically acclaimed word processor that extends your writing and editing range—on a simple memo or letter, a complex technical or legal document, or a multi-column script. With XyWrite III, you get nine windows, a redefinable keyboard, and many more features to support a truly fine performance.

A pianist couldn't perform if several seconds elapsed between pressing a key and hearing the note. You shouldn't wait precious seconds for your word processor to handle a command. XyWrite III processes your commands instantly, so you get more done in less time.

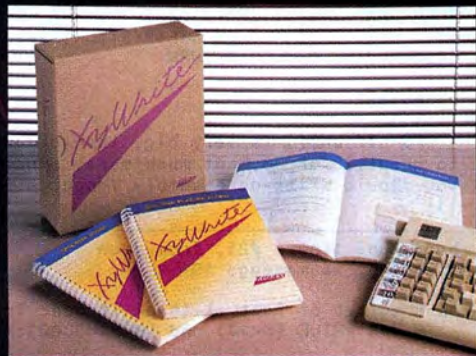

Enjoy the feel of a superior instrument when you sit down at the keyboard. Call (617) 275-4439 today and order our demo disk.

XyQuest

Inquiry 309

XyQuest, Inc.
3 Loomis Street, Bedford, MA 01730

>Count Bits...

Touche! Juan. I guess I got a little carried away with functions. - Jim

basic/one liners #18, from btonkin
a comment to message 16

Elegant solution, Juan! All I'd change in that one would be the part that reads B=INT(B/2). Better would be B=B\2; it does the same thing!

basic/one liners #19, from jimkeo
a comment to message 18

>Count Bits...

Bruce & Juan, I did some checking and the count-bits problem was first posed in soft.eng/algorithms #47. Another cute solution. Though it can't be contained on one line due to a GOTO, it has merit in that it loops one time for every 1 bit rather than 16 times. Statement 50 can be omitted if you have overflow checking disabled. It makes use of the fact that "B=B AND (B-1)" turns OFF the rightmost bit.

- Jim Keohane
PS- Taken from C code posted by rfoxmich in soft.eng/algorithms #80

```
10 GOTO 80
20 K=0
30 IF B=0 THEN RETURN
40 K=K+1
50 IF B=&H8000 THEN RETURN
60 B=B AND (B-1)
70 GOTO 30
80 INPUT "Number....",B
90 GOSUB 20
100 PRINT K
```

basic/one liners #20, from juan
a comment to message 18

Now that is interesting. "\ " you say? OK, I'll try it. What follows is a THREE liner. Believe it or not, it is a full implementation of the Quicksort algorithm. To call it, fill array LN\$() with the elements to be sorted and set N to the maximum element to go up to when sorting. On return LN\$(N) will be sorted!

```
1000 S=1:STACK(S)=1:STACK(S+1)=N:WHILE
S>0:L=STACK(S):R=STACK(S+1):S=S-2:WHILE
L<R:I=L:J=R:X$=LN$((L+R)/2):WHILE I<=J:WHILE
LN$(I)<X$:I=I+1:WEND:WHILE X$<LN$(J):J=J-1:WEND:IF I<=J
THEN SWAP LN$(I),LN$(J):I=I+1:J=J-1
1010 WEND:IF I<R THEN S=S+2:STACK(S)=I:STACK(S+1)=R
1020 R=J:WEND:WEND:RETURN
```

Enjoy.
|1|
PS- If LN\$() is very big, then dimension STACK() out to about 20 or 30, not much more, since by that point you should write an assembly language version.
|1|

basic/one liners #21, from juan
a comment to message 19

As a matter of fact, I think it can. Try this out:
10 K=0:WHILE (B<>0) and (B<>&H8000):K=K+1:B=B and (B-1):WEND
it should work, but I don't guarantee it. I just winged that one.
|1|

basic/one liners #22, from jimkeo
a comment to message 21

>WENDs...
Hmmmmm. Gotta brush up on my WENDs. Forgot about WHILE=WEND. - Jim
PS- It won't work 'cause K will end up zero if B is

&H8000 initially. Mebbe change "K=0" to "K=ABS(B=&H8000)" That should do it!

basic/one liners #23, from juan
a comment to message 22

Question: Why do you need that &H8000 anyways?
|1|

basic/one liners #24, from jimkeo
a comment to message 23

>&H8000 test
Otherwise, ya get OVERFLOW with "B-1" when B=&H8000 (-32768). Of course, you can disable OVERFLOW as I think I mentioned with the example. - Jim

MS-DOS

The activity in the MS-DOS conference reflects the fact that a high percentage of BIXen (and BYTE readers) own or use IBM PCs (or clones). This thread is centered on the very disturbing situation of a destructive program being distributed through public domain channels. The name of this program, ways to recognize other vandal programs, and possible ways to protect a machine from damage are discussed.

AN ATTACK ON THE PUBLIC DOMAIN

ms.dos/other #464, from dondumitru (Donald Dumitru)

TITLE: ARC513.COM is a TROJAN!
WARNING! WARNING! WARNING! WARNING! WARNING!

The program ARC513.COM is a TROJAN! It will alter the boot sector on your hard disk, preventing you from booting from your HD until you do a PHYSICAL FORMAT! Do *not* run this program! If you see it posted on a BBS, tell the sysop about it! I am attempting to track down the source of the copy that I have - wish me luck.

I had warned the sysop of the board that I got ARC513.COM from, after I had heard previous warnings from BIX and FidoNews, but before I downloaded it to test it myself. He said he ran check4bomb on it, and it passed as "safe". From my (very limited) debugging of ARC513.COM, I'd say that that thing does weird things to make it hard to trace through. It is even possible that it tests whether it is being run under Debug or not.

Donald
PS- But it definitely does things to your hard disk. I ran it *twice*, and had to do a physical format after each run.

ms.dos/other #469, from dondumitru
a comment to message 467

These are the details of my experience with ARC513.COM.

I first became aware of this program from messages posted on BIX by "wheelock," warning that he had heard rumors about ARC513.COM being a trojan.

The next day, as I cruised past a local BBS, I noted that ARC513.COM was in the "recent uploads" section. I left a message to the sysop, warning him about the program. He left a reply thanking me for the warning, then another reply stating that he had run Check4Bomb, and that the program had passed as "safe" (so he left it posted).

A couple of days later, in FidoNews #319, there was a warning (unsigned) that stated that ARC513.COM was

(continued)

Osborne/McGraw-Hill Computer Books For IBM® PC Productivity

Using dBASE III PLUS™

by Edward Jones

You'll be in full command of all the new features of this powerful database software with Jones' expertise. Design, create, and display a dBASE III PLUS database; generate reports; use Query files; and plug into networking. A practical handbook for beginners and experienced users.

\$18.95, Order #0-07-881252-6, 516 pp.
7½ x 9¼

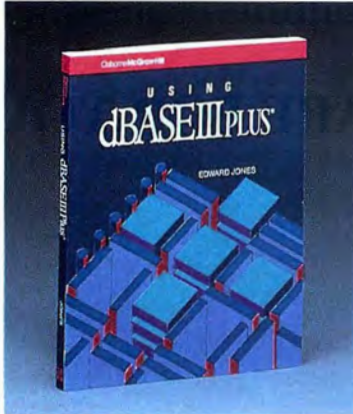

PC-DOS Tips & Traps

by Dick Andersen, Janice M. Gessin, Fred Warren, and Jack Rodgers

Here's an invaluable collection of helpful tips and clever solutions to troublesome traps for everyone using PC-DOS 2.1 or MS-DOS® 2.11. From initializing your system and formatting disks, to controlling peripherals and managing the DOS environment, you'll find an array of tricks and secrets.

\$16.95, Order #0-07-881194-5, 218 pp.
7¾ x 9¼

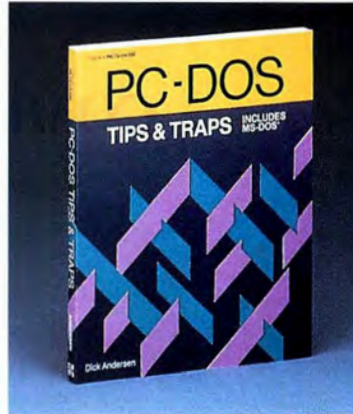

Advanced WordPerfect®: Features & Techniques

by Eric Alderman and Lawrence J. Magid

The source for ambitious users. Provides tools and concepts that you can use to take advantage of macros, paragraph numbering and outlining, indexing, and WordPerfect's mathematical capabilities. Covers WordPerfect integration with Lotus® 1-2-3; dBASE III; Sidekick; and ProKey.™

\$16.95, Order #0-07-881239-9, 310 pp.
7¾ x 9¼

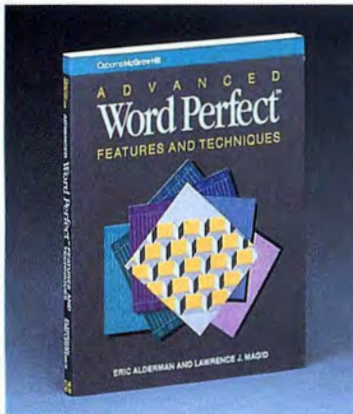

The Osborne/McGraw-Hill Guide to Using Lotus® 1-2-3; Second Edition

by Edward M. Baras

Master Lotus 1-2-3 upgrade, Release 2, with this comprehensive guide. Provides detailed descriptions of worksheet, database, and graphics functions for fundamental through advanced applications. Includes ready-to-use models.

\$18.95, Order #0-07-881230-5, 412 pp.
7¾ x 9¼

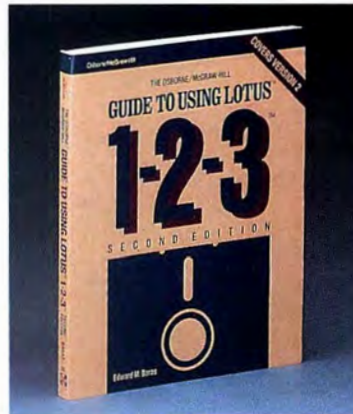

◆ Osborne/McGraw-Hill books are available at bookstores and computer stores everywhere.

◆ To order by mail, complete the coupon and send it to: Osborne/McGraw-Hill
P. O. Box 400
Hightstown, NJ 08520

◆ All orders must be prepaid and should include local tax.

◆ Checks, money orders, VISA and MasterCard are acceptable for payment. No postage or handling charges are required.

◆ Books will be shipped via UPS. Allow 4-6 weeks for delivery. Books will not be delivered to post office boxes.

This order is subject to acceptance by McGraw-Hill. Offer is good only in the U.S.A.

Osborne McGraw-Hill

Copyright ©1986 by McGraw-Hill, Inc.

NAME _____	
ADDRESS (No PO Box) _____	
CITY _____	
STATE _____	ZIP _____
INDICATE METHOD OF PAYMENT <input type="checkbox"/> CHECK/MONEY ORDER	
<input type="checkbox"/> VISA/EXP. DATE _____	<input type="checkbox"/> MASTERCARD/EXP. DATE _____
CARD # _____	
SIGNATURE _____	
QTY _____	ORDER# _____ PRICE _____

Osborne/McGraw-Hill	SUBTOTAL _____
PO Box 400, Hightstown, NJ 08520	TAX _____
Clip and send.	TOTAL _____
42-Q-015-7000-1	



30 Day Satisfaction Guarantee*

Not Copy-Protected

PC Outline!™

the Best Memory-Resident Outline Processor



Outline!
is only
\$89.95
+\$5 shipping*
* CA residents add tax

COMPARE FOR YOURSELF

	Outline!	ThinkTank	Ready	MaxThink
OUTLINE FUNCTIONS:				
Outline structure	Y	Y	Y	Y
Autonumbering	Y	N	N	Y
Multi-line entries	Y	Y	N	Y
Sorting	Y	Y	?	Y
Numbering Formats	7	0	0	?
Outline Title	Y	N	N	N
Hide/Unhide	Y	Y	Y	Y
Save previous Hides	Y	N	N	?
Global Hide/Unhides	Y	N	N	N
Hide Paragraphs	Y	Y	N/A	?
Start new numbering	Y	N	N	N
Skip numbering	Y	N	N	N
Place Entry left/right	Y	N	N	N
Xfer between outlines	Y	N	N	N
EDITING FUNCTIONS:				
Full screen editing	Y	N	N	N
Margin Control	Y	N	N	N
Hanging indents	Y	N	N	N
Justification	Y	N	N	N
Centering	Y	N	N	N
Search/Replace	Y	Y	Y	Y
Block Copy/Move	Y	Y	N	Y
Xfer between windows	Y	N	N	N
On Screen Page Breaks	Y	N	N	N
Insert Page Breaks	Y	N	N	N
Tab Settings	Y	Y	N	N
Printer fonts	Y	N	N	N
Print any part	Y	N	N	?
MISC FUNCTIONS:				
Memory Resident Option	Y	N	Y	N
Pull-Down Menus	Y	N	N	N
Windows	9	1	1	1
Zoom Windows	Y	N	N	N
Macros	Y	N	N	N
Live Time/Date stamp	Y	N	N	N
Min. Memory Consumption	85k	256k	128k	?
Import from screen	Y	N	N	N
Export to application	Y	N	Y	N
Autosave	Y	Y	N	N

To Order **PC Outline!** Call Now
24 hours a day, 7 days a week

800-523-0764

in California

800-323-5335

C'est la difference!



If lines are busy or calling from out of the country call
408-559-4545 TELEX: 70414 (SBS NV UD)

*call for details

Brown Bag Software
2105 So. Bascom Ave.
Suite 164
Campbell, CA 95008

hacked (meaning that it was not a legitimate release of ARC), and that it was possibly a trojan.

That night, I went back by the BBS where I had seen ARC513.COM and downloaded it. After backing up my hard disk, I ran it. Surprise! It looked just like any other ARC and professed to be version 5.13, created in late April. I had it extract some library files, etc., with no problems. So I rebooted. Surprise! The system locked up after attempting to read from the hard disk, and I had to power down. I let it try to boot from the HD twice more (with duplicate results) before stuffing a floppy in to boot from. The hard disk was *still* accessible, with no apparent change. All data was available. I just couldn't boot from it. So I did a DOS (logical) FORMAT and tried to boot from the HD - lockup. I tried FDISK, FORMAT, reboot, lockup. I did a low-level format, FDISK, FORMAT, reboot, success! (I would sure *hope* so!) I ran the bugger again, and again had to resort to low-level formatting to boot from my hard disk.

My best guess is that it alters bootstrap code in the boot sector. FDISK will detect that there *is* a boot record on the HD and so doesn't rewrite the bootstrap code but just updates the partition table. FORMAT doesn't touch the boot sector at all. So you have to do a low-level format to erase the boot sector, forcing FDISK to completely rewrite it, etc. This is just a guess.

Observations: The company that produces ARC distributes .COM files - these .COM files have the executable code as well as documentation in them, and they unpack themselves when run. The executable code is *always* an .EXE file. (They have stated that executable .COM versions of ARC are hacked and thus are against the licensing agreement.) This trojan is an executable .COM file. Its approximate size is 33792 bytes (having been rounded up from XMODEM transfer). The first couple of bytes in the file are -9C 55 56 8C CD 83-. This should help identify any other copies of it that are around.

I still have a copy of it. If anybody *really* wants to have a chance at debugging through it (I don't think I have the skill to get too far), they should BIXmail me.

Donald

ms.dos/other #473, from dmlck
a comment to message 472

I have that too, and it's short enough so I could upload ASCII .ASM source or Debug instructions. What it does is intercept INT 13 calls to disk units >3 (hard disks) and if it's a write, returns the error that means "write-protected disk in drive." You must reboot to remove, but it works for most things. I don't know if it's foolproof, though. I suppose one could always call C800: at some offset to do the same thing as an INT 13h, and bypass the resident WPTH.D. Or maybe some other wizard knows if (besides that) there's another commonly-used way to write to the disks than INT 13? It seems pretty low-level and possibly what the Debug interrupts use for "w" command. I'll investigate that and report back. Meanwhile, here's the hex dump of WPTH.D, which you may use to create a .COM file that will do the above.

```
0000H EB 1A 00 00 00 00 80 FC 03 75 0C 80 FA 03 76 07
0010H BB 00 03 F9 CA 02 00 2E FF 2E 02 01 BB 4C 00 BB
0020H 00 00 8E C0 26 8B 47 02 26 8B 1F 8E C0 8B FB BE
0030H 06 01 B9 08 00 F3 A6 75 04 B4 4C CD 21 89 1E 02
0040H 01 8C 06 04 01 BA 06 01 B8 13 25 CD 21 BA 1C 01
0050H B1 04 D3 EA 42 B4 31 CD 21 00 00 00 00 00 00 00
```

Since I've got SideKick up, here also is the Debug unassembled. And I commented it (that's why this is the second try).

```
6237:0100 EB1A    JMP     011C          ;to install
                          ;routine
6237:0102 0000    ADD     [BX+SI],AL   ;holds old Int
                          ;vector offset
6237:0104 0000    ADD     [BX+SI],AL   ;and segment
6237:0106 80FC03  CMP     AH,03        ;write?
6237:0109 750C    JNZ    0117          ;no, skip
6237:010B 80FA03  CMP     DL,03        ;disk unit >=3?
6237:010E 7607    JBE    0117          ;no, skip
6237:0110 B80003  MOV     AX,0300      ;wrtprot error
6237:0113 F9      STC                ;cy=error
6237:0114 CA0200  RETF    0002        ;get rid of
                          ;callers flags
6237:0117 2E      CS:
6237:0118 FF2E0201 JMP     FAR [0102]   ;go to previous
                          ;int 13
6237:011C BB4C00  MOV     BX,004C      ;install - 0:4c
                          ;is int 13 vec
6237:011F B80000  MOV     AX,0000
6237:0122 8EC0    MOV     ES,AX
6237:0124 26      ES:
6237:0125 8B4702  MOV     AX,[BX+02]
6237:0128 26      ES:
6237:0129 8B1F    MOV     BX,[BX]
6237:012B 8EC0    MOV     ES,AX
6237:012D 8BFB    MOV     DI,BX
6237:012F BE0601  MOV     SI,0106
6237:0132 B90800  MOV     CX,0008      ;check first 8
                          ;bytes of isr
6237:0135 F3      REPZ
6237:0136 A6      CMPSB
6237:0137 7504    JNZ    013D          ;if not same,
                          ;do install
6237:0139 B44C    MOV     AH,4C        ;same,
                          ;terminate
6237:013B CD21    INT     21
6237:013D 891E0201 MOV     [0102],BX   ;store old
                          ;vecadd
6237:0141 8C060401 MOV     [0104],ES
6237:0145 BA0601  MOV     DX,0106      ;install ours
6237:0148 B81325  MOV     AX,2513
6237:014B CD21    INT     21
6237:014D BA1C01  MOV     DX,011C      ;term and stay
                          ;res
6237:0150 B104    MOV     CL,04
6237:0152 D3EA    SHR     DX,CL
6237:0154 42      INC     DX
6237:0155 B431    MOV     AH,31
6237:0157 CD21    INT     21
```

Okay? I know nobody asked, but....

ms.dos/other #474, from barryn
a comment to message 473

Gosh, that'll be even faster than a RAM disk for output files! <grin>

Seriously, the only other way besides INT 13 (and DOS function calls, of course, which use INT 13) to access a disk would be to write low-level code to send commands directly to the disk controller.

I have no idea how you'd even begin to protect against that kind of code.

ms.dos/other #475, from dondumitru
a comment to message 474

To protect against *all* attempted access to your hard disk, do what I did while I was debugging through ARC513.COM a bit more today - remove the hard disk. Of course this has the disadvantage of preventing you from *reading* from the HD as well, but in some cases...

I'm gonna type in that WPTH.D program and see if it works.

Donald

(continued)

ms.dos/other #479, from petewhite (Pete White)
a comment to message 471

I'm trying to find that same program. It doesn't really "write protect," but I guess that's terminology. It gives a warning when any attempt is made to the hard disk and refuses to do so. I KNOW I have it, but on which section of my board? System (the Cul-De-Dac) is getting too big!

ms.dos/other #483, from wglivens (Wayne Givens)
a comment to message 475

A thought, Don - if that ARC513.COM is messing up the boot record (IBMBIO.COM and IBMSYS.COM?), you can unhide them and do a compare to verify/deny this. If bad, just strip all attributes, do a copy, and remark them as wo, sys, and hidden. If this works, then you know where the bugger is attacking. Otherwise....sigh.
Wayne

ms.dos/other #488, from dmick
a comment to message 483

The "boot record" is a reserved sector on the hard disk that contains partition info, which is bootable, size, etc., and is read (by the hard disk BIOS?) at bootup only. If IBMBIO and IBMSYS were the problems, one could do a SYS or something to redo. I assume Don tried that or has some other indication that the boot record was the problem.

ms.dos/other #489, from dondumitru
a comment to message 483

No! No! It's screwing up the hard disk PARTITION RECORD, which is located outside of the DOS partition (outside of *any* partition). Even Norton utilities won't read it!

ms.dos/other #490, from chrisd (Chris Dunford)
a comment to message 489

BIOS will read it. Using Debug, you can set the registers to read track 0, head 0, sector 0 and do an INT 13 to read the sector into memory someplace. You can then fix it in memory and write it back out.

ms.dos/other #491, from dmick
a comment to message 490

Sure, BIOS will (through Debug, I'd think). So will DOS interrupts....are they 25 and 26h? I never can remember.

Surprising that Norton won't. I guess I never tried it.

Actually, IBM calls that the boot record/partition table. They say a fixed-disk boot record (normally either the DOS loader or a code frag that prints the msg "Non-system disk") consists of the normal boot record PLUS a partition table. They both (being contiguous) reside in the first sector of the disk, that is, sector 0, cylinder 0, head 0. Try getting at it with Debug's L command, Don; it works 'cause I've snooped there before. The L command uses that DOS interrupt (it's 25h, absolute disk read) but makes it a lot easier to do than writing your own code fragment. It'd be interesting to see just what happened as a result of running ARC, just to get some clue as to whether it was a deliberate trojan or what.

BTW, I've seen it on several other boards since you told us all about it. Those who are members might take a look and leave a msg for the sysop if you find it.

ms.dos/other #494, from dondumitru
a comment to message 491

The DOS interrupt *won't* read the boot record - they only allow access to the DOS partition. Any sector number you pass to DOS interrupts is the logical sector in the DOS partition - not the physical sector on the disk.

The hard disk is set up as follows:

The first physical sector has the fixed-disk master boot record in it. This boot record has some bootstrap code in the front, as well as the partition table after. It is loaded into memory (by BIOS) and given control. It looks at its own boot record for a bootable partition, loads that partition's boot record into memory, and gives *it* control. This last step is the first step with diskettes. They don't load a master boot record into memory to find the bootable partition, 'cause they only have *one* partition.

Norton utilities won't read the master fixed-disk boot record (probably) because NU uses DOS interrupts for I/O (so it will work on MS-DOS machines, not just PCs).

What ARC513.COM seems to do is screw up the master fixed-disk boot record's bootstrap code. But it leaves enough of it there so that FDISK thinks it's OK and doesn't bother rewriting it - just updates the partition table at the end.

[The last paragraph is an educated guess!]
Donald

ms.dos/other #524, from dmick
a comment to message 523

Well, let's theorize together. If 1) a program has no INT 13s 2) no obvious DOS writes (INT 21 calls or INT 25 or 26h), and 3) doesn't do any IN or OUT inst. or, if it does, none to the disk board ports, then is the only other way to do it to do one of those by modifying code on the fly? One could use one of the debugging utilities that execute code like an interpreter to breakpoint mem accesses, port accesses, specific interrupts, etc., to stop any Trojan if there's no other way to write to the disk. Let me recap in a bit more organized fashion what ways I think you have to stop:

- 1) INT 13h (or only some...can look at subfunction in AX to check)
- 2) DOS calls (INT 21h, several functions...INT 26h)
- 3) IN's and OUT's to disk ports...I guess the important ones are the hard disk ports, since you can run floppies with write-protect tabs and if you lose 'em who cares anyway.

Is there another way to make the hard disk controller write to the disk? Or is there any other way besides writing to the hd to bung it up?

ms.dos/other #525, from dondumitru
a comment to message 524

All three of those methods are (reasonably) easy to check for in small files. In larger files, it might take a little more time to search through (but would still be worth it). The problem is large files with self-modifying code - can you imagine trying to run that 37K+ ARC513.COM through an interpreter?! That would be a lot worse than "go out for coffee while its running." Maybe if you had an AT (or a 386-based machine) you could put the CPU in protected mode so self-modifying code wouldn't work. Then if the CPU sets a flag when self-modification is tried, you could check it for an indication. But *lots* of programs would be trapped by the protected mode (any program with data in the same segment as code...*lots*). Other ideas? ■

A COMPUTER PROGRAM THAT SPEAKS YOUR LANGUAGE



The Computer Chronicles, a half-hour weekly television series brings you news and information from Silicon Valley and around the world. Correspondent Stewart Cheifet and Gary Kildall, creator of CP/M cover today's headlines and the stories behind them. Find out what is, what was and what will be, with the only computer program you're ever going to need. **The Computer Chronicles**, every week on a public television station near you. (Check local listings for time and channel.)

Produced by KCSM, San Mateo, CA and WITF, Harrisburg, PA with funding from AFIPS and McGraw-Hill's **BYTE** magazine.



"INSIDE IBM" SPORT-SHIRT!



The classic November '83 Byte cover—and boy, does it look great on this ¾ sleeve “baseball shirt”! The vivid royal blue sleeves and neckline really make the design jump out. And don’t mistake this for one of those rubbery patches that cracks and peels off after a few washings. This is true four-color process: the inks are silk-screened into the fabric of the shirt, resulting in a beautiful, full-color image that lasts.

You’ll also appreciate the shirt itself: a real heavy-weight made of 50% cotton, 50% polyester. You’ll enjoy cotton comfort in a tough, sporty shirt that keeps its crisp, fresh look through many washings—with almost no shrinking! The price for each “Inside IBM” Sport-Shirt is only \$12.50 (\$11.50 each for 3 or more). Your order will be shipped within a week.

Please send me the following shirt(s) at \$12.50 each, or \$11.50 each for 3 or more. I have included \$2.00 for shipping and handling.

Qty.	Size	Amount
_____	Adult—Extra Large	\$ _____
_____	Adult—Large	\$ _____
_____	Adult—Medium	\$ _____
_____	Adult—Small	\$ _____
_____	Child—(sizes 10-12)	\$ _____
	Shipping and Handling (Overseas add \$3.00)	\$2.00 \$ _____
	TOTAL	\$ _____

I have enclosed check or money order.
 VISA MasterCard Free Color Brochure
 Card #: _____
 Exp. Date: _____
Ship my shirt(s) to:
 Name: _____
 (Business): _____
 Address: _____
 City: _____
 State: _____ Zip: _____

Mail this coupon to:
Robert Tinney Graphics
 1864 North Pamela Dr.
 Baton Rouge, Louisiana
 70815

For VISA or MasterCard Orders
 or for more information
Call 1-504-272-7266



500
1000

ROBERT
TINNEY

Technological Breakthrough

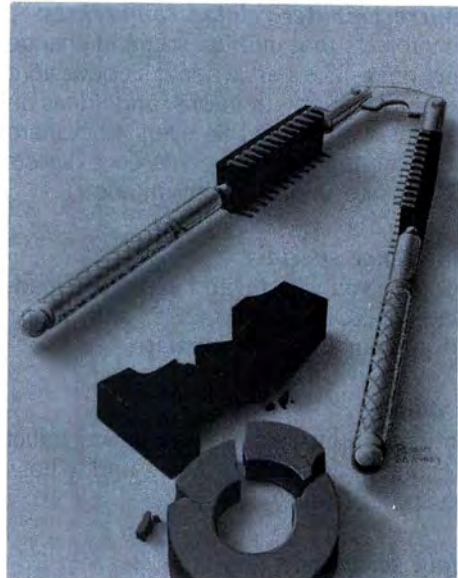

500
1000

ROBERT
TINNEY

Number Crunching

FROM THE COVERS OF
BYTE
MAGAZINE

Announcing 2 New **BYTE** Collector Prints by Robert Tinney.

Limited Edition Classics

We are proud to announce the annual release of two new 16" x 20" **BYTE** Magazine Cover Art reproductions by renowned **BYTE** artist Robert Tinney. Only 1,000 of these flawless Collector Edition Classics will be produced, on acid-free 100% cotton fiber stock to ensure that they will keep their brilliance and quality over the years without cracking or yellowing. The color separations for these sumptuous prints are made *directly from the original paintings*, guaranteeing absolutely faithful reproduction of every subtle nuance present in the originals. Each is individually inspected, signed and numbered by the artist, and accompanied by a handsome Certificate of Authenticity (also signed and numbered). The plates are then destroyed, and no future editions of any size or number will ever be published.

The price of these magnificent limited editions is just \$55, or \$45 each if you order two or more. Your prints will be shipped flat by UPS Blue Label (2-day delivery) and carry an unconditional 30-day guarantee. Order today!

Order Form

Please send me the following Limited Edition **BYTE** Collector Prints at \$55 (\$45 each for 2 or more):

Qty.	Title	Amount
_____	_____	\$ _____
_____	_____	\$ _____
\$4 Postage & handling (\$15 overseas)		\$ _____
TOTAL:		\$ _____

I enclose my check money order payable to Robert Tinney Graphics; or, bill:

MasterCard VISA American Express card
_____ Expires: _____

NAME _____

ADDRESS _____

CITY _____ STATE _____ ZIP _____

Please send me your FREE color catalog.

VISA, MasterCard or American Express orders, call 1-504-272-7266

ROBERT TINNEY GRAPHICS

1864 N. Pamela Drive Baton Rouge, Louisiana 70815



Six great reasons to join BIX today

- **Over 140 microcomputer-related conferences:**

Join only those subjects that interest you and change selections at any time. Take part when it's convenient for you. Share information, opinions and ideas in focused discussions with other BIX users who share your interests. Easy commands and conference digests help you quickly locate important information.

- **Monthly conference specials:**

BIX specials connect you with invited experts in leading-edge topics—CD-ROM, MIDI, OS-9 and more. They're all part of your BIX membership.

- **Microbytes daily:**

Get up-to-the-minute industry news and new product information by joining Microbytes Daily and What's New Hardware and Software.

- **Public domain software:**

Yours for the downloading, including programs from BYTE articles and a growing library of PD listings.

- **Electronic mail:**

Exchange private messages with BYTE editors and authors and other BIX users.

- **Vendor support:**

A growing number of microcomputer manufacturers use BIX to answer your questions about their products and how to use them for peak performance.

What BIX Costs. . . How You Pay

ONE-TIME REGISTRATION FEE: \$25

Hourly Charges: (Your Time of Access)	Off-Peak 6PM-7AM Weekdays Plus Weekends & Holidays	Peak 7AM-6PM Weekdays
BIX	\$9	\$12
Tymnet*	\$2	\$6
TOTAL	\$11/hr.	\$18/hr.**

* Continental U.S. BIX is accessible via Tymnet from throughout the U.S. at charges much less than regular long distance. Call the BIX helpline number listed below for the Tymnet number near you or Tymnet at 1-800-336-0149

** User is billed for time on system (i.e., 1/2 Hr. Off-Peak w/Tymnet = \$5.50 charge)

BIX and Tymnet charges billed by Visa or Mastercard only.

BIX HELPLINE

(8:30 AM-11:30 PM Eastern Weekdays)

U.S. (except NH)—1-800-227-BYTE

Elsewhere (603) 924-7681



We'll
Send
You a

BIX User's Manual and Subscriber Agreement
as Soon as We've Processed Your Registration.

JOIN THE EXCITING WORLD
OF BIX TODAY!

JOIN BIX RIGHT NOW:

Set your computer's telecommunications program for full duplex, 8-bit characters, no parity, 1 stop bit OR 7-bit characters, even parity, 1 stop using 300 or 1200 baud.

Call your local Tymnet* number and respond as follows:

Tymnet Prompt

Garble or "terminal identifier"
login:
password:
mhis login:
BIX Logo—Name:

You Enter

a
byteneti <CR>
mgh <CR>
bix <CR>
new <CR>

After you register on-line, you're immediately taken to the BIX learn conference and can start using the system right away.

FOREIGN ACCESS:

To access BIX from foreign countries, you must have an account with your local Postal Telephone & Telegraph (PTT) company. From your PTT enter 310600157878. Then enter bix <CR> and new <CR> at the prompts. Call or write us for PTT contact information.

BIX

ONE PHOENIX MILL LANE
PETERBOROUGH, NH 03458
(603) 924-9281

THE BUYER'S MART

A Directory of Products and Services

THE BUYER'S MART is a monthly advertising section which enables readers to easily locate suppliers by product category. As a unique feature, each BUYER'S MART ad includes a Reader Service number to assist interested readers in requesting information from participating advertisers.

RATES: 1x—\$475 3x—\$450 6x—\$425 12x—\$375

Prepayment must accompany each insertion. VISA/MC Accepted.

AD FORMAT: Each ad will be designed and typeset by BYTE. Advertisers must

furnish typewritten copy. Ads can include headline (23 characters maximum), descriptive text (250 characters maximum), plus company name, address and telephone number. Do not send logos or camera-ready artwork.

DEADLINE: Ad copy is due 2 months prior to issue date. For example: October issue closes on August 1. Send your copy and payment to THE BUYER'S MART, BYTE magazine, 70 Main Street, Peterborough, NH 03458. For more information call Karen Burgess at BYTE 603-924-3754.

ACCESSORIES

DATA CABLES & PARTS

EIA RS232-C Data Cables - standard, extended distance, Teflon Assemblies. Also Centronics (parallel), Coaxial (RG59U, RG62A/U, Dual Wang, Twin-axial), Ethernet, Ribbon, IBM, DEC Compatible cables, AB switches, connector parts, bulk cable; tools & hardware (wall plates). Send for Catalog.

Communication Cable Co.
POB 600-B, Wayne, PA 19087
215-644-1900

Inquiry 658.

ACCESSORIES

COMPUTER PROTECTION

- UPS • LINE CONDITIONERS • ISOLATORS
- MODEM PROTECTORS
- AC POWER INTERRUPTERS
- HUNDREDS OF HINTS & PRODUCTS —

FREE CATALOG 1-800-225-4876

ELECTRONIC SPECIALISTS, INC.
171 So. Main St., POB 389, Natick, Mass 01760
1-800-225-4876

Inquiry 666.

DATA/DISK CONVERSION

Conversion Systems

Do your own diskette conversions on your IBM PC with our system. Read/write 6-inch IBM 3740 Data (all formats), 100+ flavors of CP/M (30 8-inch), Displaywriter, IBM Systems 3, 32, 34, 36, 36/PC, 38, 370, 5120, DEC PDP-11, Vax, and more.

Microtech Exports

223 Forest Avenue, Palo Alto, CA 94301
(415) 324-9114

Inquiry 694.

SOFTWARE PACKAGING, DISKS

Cloth binders & slips like IBM's. Vinyl binders, boxes, and folders—many sizes. Disk pages, envelopes, & labels. Low qty. imprinting. Bulk & branded disks. Much More! Low prices. Fast service. Call or write for FREE CATALOG.

Anthropomorphic Systems Limited

376-B East St. Charles Road
Lombard, IL 60148

1-800-DEAL-NOW (312) 629-5160

Inquiry 652.

ASSEMBLY LANGUAGE

FREE 8088 TUTOR Monitor

Learn 8088 assembly language using the new book, *IBM PC-8088 Assembly Language Programming*, by Richard E. Haskell. Order the book for \$25 plus \$3 S/H and get the powerful TUTOR monitor software free. Load and examine any disk file, disassemble any 8088 code, debug EXE files. Satisfaction guaranteed.

REHI Books

54 N. Adams, Suite 130-Y, Rochester Hills, MI 48063

(313) 853-1941

Inquiry 707.

CONVERT TAPE TO DISK

We will transfer data from any 1/2" 9-track magnetic tape recorded at 1600 or 3200 bpi to 5 1/4" IBM PC floppies. Diskettes included. Quantity and repeat customer discounts. Fast turnaround. Disk to tape transfers also available.

Competitive Rates!

Micro Data Services

5 Town and Country Village, Suite 774 • San Jose, CA 95128

(408) 980-7203

Inquiry 688.

FREE CATALOG

Outstanding prices on computer accessories for your computer and workstation. Our catalog features a wide selection of quality products to meet all your accessory needs. Call or write today to receive your free catalog.

LINTEK COMPUTER ACCESSORIES

POB 8056, Grand Rapids, MI 49508

(616) 241-4040

Inquiry 684.

BAR CODE

PrintBar II is a unique memory resident program that prints code 39 and UPC bar codes on Epson, IBM graphics and LaserJet printers. Print directly from almost any program, without copying data to special print files. 30 day money back guarantee. **\$295.** Easy to install bar code readers also available at **\$495.**

BEAR ROCK SOFTWARE CO.

P.O. Box 212, Placerville, CA 95667

(916) 622-4640

Inquiry 653.

DUPLICATING SERVICES

DUPLICATION SOLUTIONS

MEGASOFT has the answer to your Diskette Duplication needs no matter what the volume. We provide *DUPLICATION *COPY PROTECTION *TECHNICAL SUPPORT *PACKAGE ASSEMBLY & DISTRIBUTIVE SHIPPING. We supply *AUTOLOADERS *BULK DISKETTES. We guarantee *QUALITY *100% SATISFACTION *FAST TURN AROUND.

MegaSoft

P.O. Box 710, Freehold, NJ 07728

1-800-222-0490 201-462-7628 (in NJ)

Inquiry 688.

Self-Inking Printer Ribbon

For users of Okidata and other open spool ribbon printers. Controlled Printout Devices are a new kind of printing ribbon that re-ink themselves, and will last 15 times longer than the ribbon you are now using. For further information please call or write.

CONTROLLED PRINTOUT DEVICES, INC.

POB 869, Baldwin Rd., Arden, NC 28704

(704) 684-9044

Inquiry 659.

COMMUNICATION

VT102/52 TEK4014 VT220

Our terminal emulators turn your PC/AT/jr into a full featured terminal. Features include: local printing, ASCII & KERMIT file transfer, softkeys, DOSkey, ANSI COLOR, 4014 graphics support. Guaranteed compatibility. Call today for free info packet.

General Micro Systems

P.O. Box 5330, Hopkins, MN 55343-1553

(612) 944-0593

Inquiry 672.

WESTERN TRANSDATA, INC.

Why risk duplicating your important programs on your computer, when our equipment is designed solely to duplicate disks & verify their perfection 100%? Over 600 formats. 3 1/2", 5 1/4" & 8". Plus serialization, copy protection, labeling, packaging, shrink-wrapping and fast, personalized service.

WESTERN TRANSDATA, INC.

1701 E. Edinger Ave. A-4

Santa Ana, CA 92705

714/547-3383 (collect)

Inquiry 723.

DATA/DISK CONVERSION

CONVERSION SERVICES

Convert any 9 track magnetic tape to or from over 700 formats including 3 1/2", 5 1/4", 8" disk formats & word processors. Disk to disk conversions also available. Call for more info. Introducing OCR Scanning Services.

Pivar Computing Services, Inc.

165 Arlington Hgts. Rd., Dept. #B
Buffalo Grove, IL 60089 **(312) 459-6010**

Inquiry 705.

DISKETTE COPYING:

3 day turn around, security, quality, most popular formats.

MAG RABBIT/MICHIGAN

616-685-6186

Inquiry 685.

... SOFTWARE PUBLISHING ...

GDS offers a wide variety of services that will help get your software to the market. Address your needs with GDS.

- IBM style cloth/vinyl 3-ring binders/slips
- Labels, sleeves, disk pages, bulk diskettes...
- Disk duplication with 100% verification.
- Shrink wrapping and product assembly.
- Quick turnaround.

A well packaged product can make the difference in making a sale. Call us now! VISA/MC.

GLENCO DEVELOPMENT SYSTEMS(312) 392-2492
3920 Ridge Ave., Arlington Hts., IL 60004

Inquiry 673.

DUPLICATING SERVICES

**DISK DUPLICATION
LOWEST PRICES
CALL NOW
401-624-3322**

Newline Software
P.O. Box 289, Tiverton, RI 02878

Inquiry 697.

BLANKET SERVICES

Diskette duplication • Packaging • Stocking/Drop shipping • 48 hour delivery • SUPERLoK copy protection • No mastering fee • No charge for standard labels • Place a blanket order with releases as you need them for any quantity at a fixed price.

Star-Byte, Inc.
2564 Industry Lane, Norristown, PA 19403
215-539-4300 800-243-1515

Inquiry 715.

ENTERTAINMENT

★ **BORED WITH YOUR IBM PC? ★**
Turn it into a FLYING SAUCER cockpit simulator for \$2.00! To introduce new customers to our line of fine software toys, a copy of Tommy's Saucer (\$19.95 value) will be sent to the first 50 zillion who send \$2 and ask for our free electronic catalog on 2s/2d diskette.

TOMMY'S TOYS
Box 11261, Denver, CO 80211

Inquiry 718.

FLOW CHARTS

FLOW CHARTING II HELPS YOU!

Precise flowcharting is fast and simple with Flow Charting II. Draw, edit and print perfect charts: bold and normal fonts, 24 shapes—95 sizes; fast entry of arrows, bypasses & connectors; Fast Insert Line; shrink screen displays 200-column chart; 40 column edit screen for detail work, much more!

PATTON & PATTON
340 Lassenpark Circle, San Jose, CA 95136
1-800/672-3470, ext. 897 (CA residents)
1-800/538-8157, ext. 897 (Outside CA)
408/629-5044 (Outside the U.S.A.)

Inquiry 710.

HARDWARE

PC WHOLESALE CENTER F.C.C. APPROVED BASIC KIT

* 640K Mother Board (OK)	\$94.00
* 5150 Keyboard	\$46.00
* 150W Power Supply	\$56.00
* Case	\$34.00

ALL FOR \$230.00, CALL FOR OTHER ADD-ON CARD.
* TTL Monitor . . . \$80.00 * AGP . . . \$60.00

SANFORD INC.
10413 Rockley Rd., Houston, TX 77099
(713) 879-0068

Inquiry 710.

M68000-SBC

Expandable single board computer with on board 10 MHz 68000, 20K SRAM, 32K PROM, two RS-232 serial ports, 16-bit parallel port, 5 counter/timers. Expansion for additional memory/Floppy Disk Controller board. Custom designs available. Price starts at \$89.95.

Educational Microcomputer Systems
POB 16115, Irvine, CA 92713
(714) 854-8545

Inquiry 724.

HARDWARE

POWERLINE GREMLINS?? POWER FAILURES??

The MEIRICK STANDBY POWER SYSTEM is the TOTAL SOLUTION to your powerline problems.
400 watt system - \$449;
800 watt system - \$795

MEIRICK Inc., POWER SYSTEMS DIV.
Box 298, Frisco, CO 80443 303-668-3251

HARDWARE ADD-ONS

RS-232 RS-422

• Four Port RS-232 w/software	\$349 ⁰⁰
• RS-422/485 Serial	\$149 ⁰⁰
• RS-232/422 with 24 Parallel I/O	\$199 ⁰⁰
• RS-422 Synchronous	\$299 ⁰⁰
• EPROM/RAM	\$199 ⁰⁰
• A/D & Digital I/O	\$299 ⁰⁰

Call About Custom Designed Boards
Sealevel Systems Inc.
P.O. Box 1808, Easley, SC 29641
(803) 855-1581

Inquiry 711.

GM CAR DIAGNOSTICS TO PC

Connect the IBM PC to your GM car with our 851051/F and RS232. Our BASIC gives car trouble codes and sensor data from most 1980 1/2 & newer cars. Exceptions include Cadillac. (\$160) Store data on audio tape, with our 85104 cassettes I/F. (\$80) Play tape to 85104 to 85105 to PC.

EXECUTIVE ELECTRONICS INC.
938 Main St., Dept. B, Yarmouthport, MA 02675
(617) 362-3694

Inquiry 669.

PATCHMAN®

ABC Serial Switching Unit

• 31 switching	\$9995
• 8" x 4" x 2" ONLY	
• RS-232 connectors	

• Null Modem - "Cross-over"

U S Software®

United States Software Corporation
14215 N.W. Science Park Dr., Portland, OR 97229
(503) 641-8446

Inquiry 720.

DATA ACQUISITION IN A PCI

- ICIS plug-in cards for PC and compatibles
- 16-64 A/D/frequency inputs; 0-8 D-A outputs
- 24-48 digital I/O incl. 0-24 event counts
- Data converted to engineering units; avg, std dev, max, min computed; results stored on board.
- Ideal for continuous monitoring appl.

Western Telecomputing Corporation
202 E Kagy Blvd, Bozeman, MT 59715
(406) 586-1511 or (touch tone)
1-800-423-0587, then 328 222

Inquiry 722.

MAINTENANCE MGT.

MAINTENANCE & INSPECTION

An easy-to-use computerized method to organize, operate, and control an effective preventive maintenance system. Applicable to any type of business or industry. Full screen input and displays, plus function key help command. Maintains historical data, creates work orders, and provides numerous reports. For info, write to:

Penguin Computer Consultants
P.O. Box 20485, San Jose, CA 95160
(408) 997-7703

Inquiry 704.

PROGRAM GENERATORS

WINDOW.LIB \$99.

An easy to use complete windowing system for programmers and writing in
• BASIC IBM, M-S, CB86 . . . • C LATTICE, M-S
• COBOL M-S, RMF . . . • PASCAL M-S, TURBO
• FORTRAN M-S, RMF . . . dBase Clipper
Window editor included. Create callable pop-up menus, help screens. The line selector features auto reverse highlighting and cursor control. No royalties. Ask about our BIOS/DOS LIB VISA/MC.

GLESCO ENGINEERING (312) 392-2492
3920 Ridge Ave., Arlington Hts., IL 60004

Inquiry 730.

PUBLIC DOMAIN

THE BEST OF THE BEST!

Public Domain & User Supported Software for IBM PC or compatible. Word Processing, Database, Spreadsheets, Utilities, Games, Accounting, etc! 50 disk package \$205.00, or rent 2 wks. \$75.00. Info & Super Sampler Disk \$6.50, Deluxe Word Processor \$6.50, both \$12.00. MC/VISA

BLUE CIRCLE GROUP, INC.
Box 23502, Minneapolis, MN 55423
(612) 823-4111

Inquiry 655.

SOFTWARE A.I.

OPS5+ for PC's & Mac's

OPS5+ by ComputerThought is a quality implementation of OPS5 for IBM PC, XT, AT's & compatibles and the Apple Macintosh Mouse controlled, menu driven development environment \$1,750 single qty. (Substantial educational, VAR & corporate discounts). Mention BYTE & get a free mouse or \$100 off until 12/31/86.

**** Distributed by JCL Systems ****
2508 Teakwood Ln. # 100, Plano, TX 75075
(214) 867-0962 VISA, MC, MO & Checks accepted

Inquiry 680.

SOFTWARE ACCOUNTING

dBASE BUSINESS TOOLS

* General Ledger	* Purch Ord/Inventory
* Accounts Recvbl.	* Accounts Payable
* Order Entry	* Job Costing
* Sales Analysis	* Job Estimating

\$99 EA. + s&h w/dBASE 2, 3 or 3+ SOURCE CODE
dATAMAR SYSTEMS™ Cred. Card-Check-COD
6809-B Convooy Court, San Diego, CA 92111
800-223-9963/CA 800-221-9964/(619) 278-8222

Inquiry 661.

TIME & BILLING

400 clients/20 partners/80 job & 40 out of pocket categories/20 areas of practice/fixd fee or hourly/more! Prints billing/statements/aged rec's/more! Free phone support. \$149 (VISA/MC/AMEX). MS-DOS/CPM-80. Other original software. FRE catalogue.

MICRO-ART PROGRAMMERS
614 Alameda Padre Serra, Santa Barbara, CA 93103
(805) 962-0922

Inquiry 726.

SOFTWARE/BUSINESS

SAVE LEGAL FEES

157 time tested legal forms on disk, complete with menu driven system and editing and printing capability. Free copy of PC-Write word processor included. Forms written by a noted attorney and applicable nation-wide. \$129.95 plus \$7.50 shipping and handling.

LegalEase™ HDG Software, Inc.
54 Whitney St., Sherborn, MA 01770
617-651-1881
800-628-2828 x 706 for credit card orders

Inquiry 674.

SOFTWARE/BUSINESS

PC-Write™ Shareware

Fast, powerful word processor/text editor for IBM PC. Mailmerge, split screen, ASCII files, macros. Supports proportional printing, laserJet, 300+ printers. \$10 for all software, tutorial/guide on diskette. OK to copy. Register for manual/support, \$75. Full 90-day guarantee. Version 2.7 with spell check soon: diskette pair, \$16; register, \$89.

Quicksoft (206) 282-0452 Visa/MC
219 Firat N. #224.I. Seattle. WA 98109

Inquiry 706.

METATEXT

Letter quality from any dot matrix printer that is Epson or IBM Graphics Printer compatible. Memory resident, 10 fonts. COMPLETELY compatible with word processors, spreadsheets, languages. Approx. 1/7th normal printer speed.

ONLY \$89 VISA/MC

For more information call or write:

Image Computer Systems

P.O. Box 647, Avon, CT 06001
(203) 678-8771

Inquiry 678.

dFELLER Inventory

Business inventory programs written in modifiable dBASE source code.

dFELLER Inventory \$150.00

Requires dBASE II or III, PC-DOS/CPM

dFELLER Plus \$200.00

with History and Purchase Orders

Requires dBASE III or dBASE III Plus (For Stockrooms)

Feller Associates

550 CR PPA, Route 3, Ishpeming, MI 49849
(906) 486-6024

Inquiry 670.

TRANSPORTATION RESEARCH

TSAB88 Transportation Simplex Algorithm (up to 510 sources, sinks or transshipment points)

TNET88 Transportation Network System (networks up to 510 nodes & 16K links)

TPR088 Transportation Problem Solver (shortest path, tours up to 50 stops)

Req. 192K, color graphics adaptor \$99 each w/8087 support, user's guide. Write or call for our brochure.

EASTERN SOFTWARE PRODUCTS INC.

P.O. Box 15328, Alexandria, VA 22309
(703) 549-5469

Inquiry 665.

DBASE III SOURCE CODE FOR

HUMAN RESOURCES MGR. \$250

VIDEO MOVIE MGR. \$395

Runs on IBM PC or compatible. All modifiable.

Demo diskette plus manual \$25.

ORDER NOW!

PC MASTERS, INC.

POB 521, Lapuente, CA 91746

(818) 913-6100

Inquiry 702.

FOR YOUR EYES ONLY* \$55

Did your competition underbid you again? Losing company secrets? Fight back! Password protect your files on floppies/HD. Has Corporate Security for employees and Maximum Security for office manager. Memory resident. Best Buy in Data Encryption. \$54.95. U.S. Requires 256K IBM PC/XT/AT, DOS 2.0 or later.

GREBAR

Box 2926, Winnipeg, Manitoba, Canada R3C 4B5

(204) 942-3301

SOFTWARE/BUSINESS

OPERATIONS RESEARCH

LP88 Linear Programming (up to 510 constraints and 2510 variables). BLP88 Bounded Variables LP (up to 510 by 1510). DLP88 Dual Linear Programming (up to 1510 by 510). MLP88 Mixed-Integer LP (up to 64 integers, 255 by 1255). MZLP88 Mixed-Zero/One LP (up to 255 by 1255). Req. 192K. \$99 each w/8087 support, user's guide. Write or call for our brochure.

EASTERN SOFTWARE PRODUCTS INC.

P.O. Box 15328, Alexandria, VA 22309

(703) 549-5469

Inquiry 728.

ROMAR CHURCH SYSTEMS™

Membership-61 fields plus alternate address; labels, letters, reports any field(s). Offering-256 funds; optional pledge; statements, post to 255 x/year. Finance-G/L with budget; up to 500 sub-totals & 99 depts. month & YTD reports anytime for any month. Size 29000 people/floppy; 25000/10 meg. Ad too short! Write!

Romar Church Systems, Attn: BMB

P.O. Box 4211, Elkhart, IN 46514

(219) 262-2188

Inquiry 709.

Church Package

Parishioner Time, Talent and Treasure System program is written in modifiable dBASE source code.

- Contributions • Disbursements • Ledger
- Names with mailing labels
- Personal information database.

Requires dBASE II or III. PC-DOS/CPM-80 \$200.

Feller Associates

550 CR PPA, Route 3, Ishpeming, MI 49849

(906) 486-6024

Inquiry 729.

RECORD OF CONTRIBUTIONS

An in depth system to account for contributions to the church - and more. Easy to enter/update/retrieve data. Prepares Reports/Statements on demand. For the IBM PC/XT or AT or compatibles. Excellent Documentation. \$99.00 + \$5.00 S&H.

MICRO-DYNAMICS OF TEXAS

P.O. Box 40691, Houston, TX 77240

(713) 896-9957

Inquiry 689.

SOFTWARE/EDUCATION

KID HAS MATH TROUBLE?

Our exciting "EDUCATIONAL GAMES" could make your kid THE TOP MATH STUDENT in his class. Send CHK/MO, specify IBM PC or APPLE II/C. \$21.50 ea. + \$2 S/H.

BLACK BELT-ADDITION -SUBTRACTION
-DIVISION -MULTIPLICATION

ROBIN SOFTWARE

P.O. Box 1053, Cupertino, CA 95015

(408) 255-7458

Inquiry 708.

PC/VEGAS II

oker, Blackjack, Roulette, Keno, Slots—\$26. Above plus Baccarat and Craps—\$39. Exact Vegas simulation, includes Help, best bet/odds windows. Cross-game scoring. Graphics not mandatory. Color or Mono. MS/PC DOS, 128K. C Source available, ask. Add \$2 for shipping/CA res. add 6 1/2% tax.

D & H BEAR SOFTWARE

P.O. Box 10793, Marina Del Rey, CA 90295

(213) 374-0358

Inquiry 660.

SOFTWARE/GENERAL

NEW INTEGRATED ENVIRONMENT AI FOR THE IBM PC

TOPSI IS A FULL VERSION OF OPS5 WHICH RUNS UNDER MS-DOS, UNIX OR CP/M. A FAST, EFFICIENT EXPERT SYSTEM DEVELOPMENT TOOL.

PROTOTYPING: \$125 PRODUCTION: \$250

PROFESSIONAL: \$375 SHIPPING, ADD \$5

DYNAMIC MASTER SYSTEMS

POB 566456, Atlanta, GA 30356

(404) 565-0771 Telex #282923

Inquiry 664.

Label Printing Made Easy

LABLMAKR prints on label or card stock up to 8" wide. 52 standard formats, thousands of variations - including audio/video cassette labels. Works with PC-compatible and dot matrix printers. Only \$49 - money back if not delighted.

ETS Center

35026-A, S. Turtle Trail, P.O. Box 651

Willoughby, OH 44094

(216) 946-8479

Inquiry 668.

NEW Turbo Pascal™ Programs

Outstanding software. Full source code included! KEYMASTER, DESKMASTER: Pop Up desk organizers. Editor, macros, alarms, addr book/dialer, calculator, more! \$49.95 + \$2 s&h each. IBM PC & Comp. DICTIONARY TOOLBOX: Library to produce/manage bit compressed dict. \$39.95. Any MS-DOS Comp. CHESTER: Full featured Chinese checkers game using heuristic search. \$22.00 IBM-PC & Comp. Visa/MC

A. I. SOFTWARE 512-928-2009

2200 Rogge Ln., Austin, TX 78723

Inquiry 650.

PERSONAL FINANCE STATEMENT

Spreadsheet for Lotus, Symphony or Multiplan on IBM PC's or compatibles. Produces a Personal Finance Statement in a standard form acceptable by all banks and lending institutions. Never fill out another personal statement. Easy to update. Keeps a permanent record of your assets and liabilities. 30-day money-back guarantee. \$29.95. MC/VISA.

NavStar

P.O. Box 1763, Rockville, MD 20850

800-835-2246 x230 In KS 800-362-2421 x230

Inquiry 695.

SOFTWARE/GRAPHICS

GRAPHICS PRINTER SUPPORT

AT LAST! Use the PrtSc key to make quality scaled B&W or color reproductions of your display on any dot matrix, inkjet, or laser printer. GRAFPLUS supports all versions of PC or MS-DOS with IBM, Tecmar, and Hercules graphics boards. \$59.95.

Jewel Technologies, Inc.

4302 SW Alaska St., Suite 207, Seattle, WA 98116

(206) 937-1081

Inquiry 681.

FORTRAN PROGRAMMER?

Now you can call 2-D and 3-D graphics routines within your FORTRAN program.

GRAF-MATIC: 75 callable routines for screen output. \$135.

PLOT-MATIC: Pen plotter driver. \$135.

For the IBM PC, XT, AT and compatibles. We support a variety of compilers, graphics boards and plotters.

MICROCOMPATIBLES

301 Prelude Drive, Dept. B

Silver Spring, MD 20901

(301) 593-0683

Inquiry 692.

THE BUYER'S MART

SOFTWARE/GRAPHICS

SCIENTIFIC GRAPHS

SCI-GRAF produces high-res graphs (1680 x 1712 pixels) on Epson or IBM graphics printers. Supports log/linear scales, error bars, overlays, batch mode operation. Very flexible data entry from disk or keyboard. User customizable. Requires DOS 2 or 3, 256K.
\$99.95 (Sorry, no credit cards)

Microcomputer Systems Consultants

32 West Anapamu, Suite 190, Santa Barbara, CA 93101
(805) 963-3412

Inquiry 693.

PC-KEY-DRAW TRY IT \$15 VER. 3.1

Comprehensive, high-power graphics editor, CAD, paint, slide show program. Over 150 standard functions plus macros, 64 pages/layers, zoom printer, 64 patterns, novice/expert modes. \$15 includes manual, software, quick ref. card. Register \$100 for support, updates complete printed manuals. Shareware. IBM PC and compatibles.

OEDWARE

P.O. Box 595, Columbia, MD 21045-0595
(301) 997-9333

Inquiry 699.

PRESENTATION GRAPHICS

Executive Picture Show - complete presentation graphics! IDEAL for demos, tutorials, hardcopy, slides. SLIDE-SHOWS, WORD CHARTS, BUSINESS GRAPHICS, FREE-FORM PAINTING & DRAWING and GRAPHICS LIBRARIES. SUPPORTS dot matrix, inkjet, laser printers, and plotters. Complete package \$245 - Trial version \$15.

PCsoftware

11627 Calamar Court, San Diego, CA 92124
(619) 571-0981

Inquiry 703.

SOFTWARE/LANGUAGES

SIMULATION LANGUAGE

TurboSim allows large discrete event simulations i.e., manufacturing systems, health-care systems, etc. to be run on a micro. It features a comprehensive final report, histograms, plots and multiple simulation runs in an unattended mode. Source code is written in Turbo Pascal and is included. Borland International's Turbo Pascal and an IBM/PC with 64K are required. \$49.95.

Micro Simulation

37 William J. Heights, Framingham, MA 01701
(617) 875-6098

Inquiry 691.

SCREEN PROGRAM GENERATOR

SPG1 creates BASIC program code quickly and easily. Design your screen directly and SPG1 will generate the BASIC program code to handle the display and input of data. Controls use of color, editing, graphics, cursor movement and function keys. Generated code easy to modify / merge.

IBM PC & compatibles 128K
\$75 + \$3.00 S&H (CA + tax)

Treebeard Software

5901 Warner Avenue, Suite 428
 Huntington Beach, CA 92649
(714) 840-6939

Inquiry 619.

MUMPS

DTM-PC, fastest ANSI Standard MUMPS for IBM PC XT, AT or compatibles. VA File Manager available. Runs up to 16 crts from one AT.

DataTree, Inc.

318 Bear Hill Rd., Waltham, MA 02154
(617) 890-1620

Inquiry 662.

SOFTWARE/LANGUAGES

Minnesota SNOBOL4 Language

Powerful string & data handling facilities. Interpreter compatible with mainframe SNOBOL4. 32K strings, 32 bit integers, 8087 for float & large memory model. Sample pgms include ELIZA. For >128K IBM PC & DOS or equivalent. Definitive "green" book by Griswold et al available.
 Guide + 5 1/4" SSDD diskette **\$44.95**
 Guide + diskette + "green" book **\$59.95**
 "Green" book only **\$26.95**

Postpaid in USA. In NY add tax. VISAMC (914) 271-5855
BERSTIS INTERNATIONAL
 POB 441, Millwood, NY 10546

Inquiry 654.

SOFTWARE/PRINTER

HP LASERJET

LASER FONTS works with your font cartridges to make near typeset printing a snap. Simply embed [xxx] into your word processor spreadsheet, etc. Only **\$39 + \$3 s/h**.

- 245 type styles
- Memory-resident
- IBM PC DOS 2.0+
- Site licences
- Network version
- Guarantee

Keller Software

1825 Westcliff Dr., Newport Beach, CA
714/642-5544

Inquiry 683.

SOFTWARE/SCIENTIFIC

HP-PC HYPER-CALCULATOR

Pop-up MS-DOS programmable scientific calculator emulates HP-11C. Hex/oct/bin arithmetic, two-way data transfer, program & data disk storage, HELP, alpha prompts, 100 registers, 1000 program steps. Free 8087 version, utility programs. **\$39.95 + \$1 s&h**.

SUNDERLAND SOFTWARE ASSOCIATES

P.O. BOX 7000-64
 REDONDO BEACH, CA 90277
 CALL TOLL FREE 800-628-2828 ext. 502

Inquiry 716.

UPGRADE YOUR IBM PC TO A STORAGE OSCILLOSCOPE!

Do Data Acquisition, Frequency Spectrum Analysis, Transfer Functions, Analysis with Lotus 1-2-3, and more—inexpensively and all without programming!

For info on SNAPSHOT Storage Scope:

HEM Data Corporation
 17025 Crescent • Southfield, MI 48076
(313) 559-5807

Inquiry 675.

DIGITAL SIGNAL ANALYSIS

Fourier Perspective II w/graphics. FFT/IFT, convolution, deconvolution, Hanning, Power Spectrum, Cross Correlation, 25 more. Graphics 2D and 3D. 8087 recommended, not required. Easy to use menus. FP II \$395 or FP I (FFT w/graphics only) \$149. Runs on PC, PC-XT, PC-AT.

Alligator Transforms Scientific Software

P.O. Box 11386, Costa Mesa, CA 92627
(714) 662-0660

Inquiry 651.

CROSS ASSEMBLERS for VAX VMS and PC/MS DOS New Low Prices

Relocatable Macro Cross Assemblers, Linkers, Librarians
 Targeted to almost all Microprocessors

ENERTEC, INC.

BOX 1312, Lansdale, PA 19446
215-362-0966 **MC/VISA**

Inquiry 667.

SOFTWARE/SCIENTIFIC

ELECTRONIC CIRCUIT ANALYSIS

Has AC, DC, Transient and Fourier. Includes worst-case, Monte-Carlo, component sweeping. Macro models, transmission lines.

Electronic Circuit Analysis **\$450.**
 EC-Ace **\$95.**

TATUM LABS

POB 698, Sandy Hook, CT 06482
(203) 264-3755

Inquiry 717.

FAST FOURIER TRANSFORMS

Best available! Extremely fast and accurate. Two assembly language subroutines: one for integer data, one for floating point (8087 & 80287 supported). Forward transforms, inverse, power spectra, special modes for real-valued data. Callable from MS-FORTRAN. Excellent documentation. **\$149** each, or **\$249** for both.

J. W. HARTWELL & ASSOCIATES

Route 4, Box 1540, Hillsborough, NC 27278
(919) 732-7951

Inquiry 682.

forMath® text-formatter

- Equations, matrices, ratios, integrals, diagrams
 - Macros, fonts, Greek/math symbols
 - Hyphenation, secn/eqn/ref numbering
 - Indexes, table of contents, footnotes
 - Dot-matrix, daisywheel, laser printers, all monitors
- \$400. \$50 for demo**

SHANTHA SOFTWARE INC.

50 West 97th St. Room 11N, New York City 10025
(212) 222-SNIP

Touchtone toll free: **950-1088-walt-FORMATH**

Inquiry 712.

► SCIENTIFIC CALCULATOR ◀

Memory resident emulation of the HP-11C plus direct insertion of results in foreground program, graphically presented, decimal, hex, binary, & octal operations, boolean functions and more. Mouse support. 8087 or Standard versions **\$49.95 + 3.00 s&h**.

K SOFTWARE HOUSE

Rt. 2, Box 83B1 Unionville, TN 31780
(615) 294-5090

Inquiry 725.

CHARACTER CUSTOMIZATION

CHARGENI 2.1 lets you modify the character set on the EGA. Useful for scientific/engineering symbols on your word processor, special symbols in your programs, and more. Requires DOS 2.x or 3.x, Enhanced Graphics Adapter. **\$35 + \$2 s/h (MN add 6%)**.

DK Micro Consultants

P.O. Box 6714, Minneapolis, MN 55406
(612) 722-0931

Inquiry 663.

► MATRIX 100 ◀

Perform multiple regression, solve simultaneous equations, invert matrices, etc. in BASIC or Fortran. ".... very sound numerically very powerful and very easy to use" — **OR/MS Today 2/85**. "Stanford Business Software deserves congratulations" — **PC Mag. 5/14/85**. Price **\$80**, 8087 support **\$125**, compiler support **\$250**. Fortran library **\$175** (\$4 s&h).

STANFORD BUSINESS SOFTWARE, INC.

2672 Bayshore Parkway, Ste. 304
 Mountain View, CA 94043
 To Order Call **(415) 424-9499**

Inquiry 714.

THE BUYER'S MART

SOFTWARE/TOOLS

FORTRAN Addenda

Graphics, color text, keyboard control, and much more for PC/XT/AT FORTRAN Programs. Includes gets/puts, filing, fills, pull-down windows, and USER I/O EDITING MDA thru EGA, Hercules Support. 170 pg. manual & annotated samples. Sold as 2 libraries, each \$95, combined \$165.

IMPULSE ENGINEERING

P.O. Box 3540, San Francisco, CA 94119-3540
(415) 788-4611

Inquiry 679.

STATISTICS

STATISTICS CATALOG!

If you need statistics for IBM PC or Apple II, call us and let our technical advisors help you find the statistics programs you need. Write or call now to get a FREE catalog of statistics and quality control software.

HUMAN SYSTEMS DYNAMICS

9010 Reseda Blvd., Ste. 222
Northridge, CA 91324

(800) 451-3030 (818) 993-8536 (CA)

Inquiry 677.

NUMBER CRUNCHER STAT SYS

Menu-driven. Multiple & stepwise regression, ANOVA, time series, discriminant cluster and factor analysis, principal components, scatter plots, histograms, t-tests, contingency tables, non-parametrics. Import export data. Spreadsheet, sort, join, merge. \$79. IBM PC/Macintosh. Quantity discount.

NCSS-B

865 East 400 North, Kaysville, UT 84037
801-546-0445

Inquiry 696.

TYPESETTING

DESKTOP PUBLISHING

Laser Printer composition software to drive Cordata L300 with 76 PS fonts \$495. With add 14 PS Lndscp fonts \$695. For Canon LBP-8 A2, NCR, or HP LaserJet+ with 41 PSprior Lndscp fonts \$695. H & J, merge graphics, mix face & pt. size anywhere on any line, mult tab & col justification. Boxes & Rules.

Micro Print-X, Inc.

P.O. Box 581, Ballinger, TX 76821
(915) 365-2343

Inquiry 690.

UTILITIES

SOURCE CODE LIBRARIAN & REVISION CONTROL SYSTEM

TLIB™ keeps ALL versions of your program in ONE compact library file, even with hundreds of revisions.
• 5 times faster than SCCS • LAN compatible
• Free public domain MAKE (with source) by L. Dyer MS/PC-DOS 2.x & 3.x. \$99.95 + \$3 S&H. VISA/MC

BURTON SYSTEMS SOFTWARE

POB 4156, Cary, NC 27511
(919) 469-3068

Inquiry 657.

UTILITIES

ZERODISK

ZeroDisk runs dozens of copyprotected business packages from your hard disk without floppies. Call for the latest list of software it handles. Needs IBM AT, XT, PC, or compatible, DOS 2.0 or higher. ZeroDisk is revised monthly and is not copy protected. \$75 US. Check or Credit Cards accepted.

QUAD SOFTWARE LIMITED

45 Charles St. E. 3rd Fl.
Toronto, Ontario, Canada M4Y 1S2
(416) 961-8243

UTILITIES

PADLOCK/PADLOCK II DISKS

PADLOCK furnishes the user with a method for providing protection against unauthorized duplication from DOS commands \$99. PADLOCK II disks come preformatted with finger-print and serialization. PADLOCK II disks offer superior protection. Ask about our HARD DISK protection with uninstall capability. MCVISA.

GLENCO ENGINEERING

3920 Ridge Ave., Arlington Hts., IL 60004
(312) 392-2492

Inquiry 731.

STILL RIVER SHELL

Visual shell for PC/MS-DOS. Turns your directory into a menu. V1.33. Only \$9 for shareware diskette. \$35 manual & diskette.

Bob Howard

PO Box 57, Still River, MA 01467
617-456-3699

Inquiry 656.

Automenu™ version 4.0

Create one menu system to run all your programs, batch files & DOS commands. "Insulates" novices; many options for power users. On-screen help, password protection, user-defined prompts. Written in assembler. 16K size. Over 8,000 satisfied users. Money back guarantee. \$46 + \$4 s/h. Chk/Visa/MC. Call or write for brochure.

Magee Enterprises

Dept. B13, 6577 Peachtree Industrial Blvd.
Norcross, GA USA 30092-3796
404/446-6611

Inquiry 686.

WORD PROCESSING

HEBREW / ENGLISH / GREEK

Arabic, Russian, and European Languages. Full featured, multi-language word processor supports on-screen foreign characters with no hardware modifications, and prints on most dot matrix printers. \$350 + \$5 s/h. Or send \$15 + \$4 s/h for demo. Req. 384K.

Gamma Productions, Inc.

710 Wilshire Blvd., Suite 609
Santa Monica, CA 90401

(213) 394-8622

Inquiry 671.

THE NEWMAN UTILITIES

41 general purpose utility programs for manipulating your files and your system. Includes printed manual. 15 day money back guarantee. IBM and compatibles with MSDOS 2.XX up. Not copy protected. \$19.95 or \$2 sample disk. Free shipping on prepaid orders.

NEWMAN COMPUTER

2 Briar Mills Drive, Bricktown, NJ 08724
(201) 458-5169 BIX EDNEWMAN

Inquiry 698.

WARP-TEN or RAMback - 9.95

WARP-TEN is a programmable disk cache that speeds up your PC disk access's. RAMbak automates the saving of new or changed RAM disk files to floppy disks and/or hard disk subdirectories. PC, XT, AT, compatibles with 256K DOS 2.0+. Introductory price is only 9.95 each. (MN Res. + 6%). Visa/MC/CHK

Software Brewing Company

P.O. Box 12094, St. Paul, MN 55112
612-636-2727

Inquiry 713.

ChWriter Scientific WP

- Complete word processor, fully WYSIWYG
- Includes 14 fonts and a font design program
- Very easy editing of formulas, super/subscripts
- Quick printing—mixes built-in, graphic fonts
- Excellent for scientific, foreign language text
- \$79.95 + \$5 s/h (Epson MX/FX, Okidata printers)
- Hercules, Toshiba, Epson LQ support \$19.95 ea.

Horatmann Software Design

P.O. Box 4544, Ann Arbor, MI 48105
(313) 663-4049/763-8203

Inquiry 676.

PAL FOR SIDEKICK!

Personal Appointment Locator automatically shows coming appointments, searches your file, maintains to-do list, examines multiple files. Resident alarm tool! Only \$49.95. Cheap at twice the price!

PAL SOFTWARE

Ste. 12B 110 Green St., New York, NY 10012
212-925-1843

Inquiry 700.

SQUARENOTE™

For writers, researchers, lawyers, teachers!! Flexible text database system, retrieval by keywords. Up to 10 pages text & 100 keywords per record. Built-in editor + transfer to & from word processors. Manual, tutorial, on-line help. IBM compatibles. Just \$89.95 + \$4.50 s/h. 30 day \$ back! Not copy-protected.

UnionSquareware

Box 228, Somerville, MA 02143
617-623-3023

Call TOLL FREE

800-334-0854
(Ext 583)

Inquiry 721.

Advertise your computer products for
as little as \$375 in THE BUYER'S MART.
For more information call
Karen Burgess at BYTE 603-924-3754.

Inquiry 727.

SAVE! — SAVE! — SAVE!

MEMORIES—BOARDS—PRINTERS

- * **84K/128K/256K D-RAMs at LOW PRICES**
- * **V20-5 or -8 . . . \$14.00 / V30-8 . . . 18.00**
- * **8087 . . . \$109.00 / 8087-2 . . . \$155.00**
- * **80287-8 . \$178.00 / 80287-8 . . . \$285.00**

*** Memory Boards and Modules**

- JRAM-2 Parallel or Serial w/OK . . . **\$149.25**
- JRAM-3 /JRAM-AT Par. or Ser. w/OK . . . **\$201.75**
- JRAM AT-3 Par. or Ser. w/OK . . . **\$261.75**
- Ser/Par or Ser/Ser Clock module . . . **\$150.00**
- Ser/Par or Ser/Ser module . . . **\$105.00**
- Clock/Calendar module . . . **\$90.00**
- JDISKETTE module . . . **\$150.00**
- JLASER-1 w/ Canon switch & cable . . . **\$300.00**

*** BROTHER Printers & Accessories**

- M-1509 Dot Matrix Printer . . . **\$380.00**
- HR-15XL Daisy Wheel Printer . . . **\$385.00**
- Twinwriter 5 Dot Matrix/Daisy . . . **\$680.00**
- Printer Accessories . . . **25% off LIST**

* **WARRANTY:** All I.C.s guaranteed for 180 days. * **OEM and DEALER** discounts available. * Prepaid orders — No shipping charges * **Maryland residents** must add sales tax.

Advanced Technology Products, Corp.
 P.O. Box 2205 / 11141 Georgia Ave., Silver Spring, MD 20902
Phone: 301-933-3523

Inquiry 5

**64K ■ 128K ■ 256K
 DRAMS**

EPROMS

- 80287-10 ■ 80287-8 ■ 80287-3
- 8087-3 ■ 8087-2 ■ 8087-1

4416 ■ 4464

V-20 ■ V-30

BITTNER



ELECTRONICS

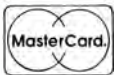

(714) 497-6200
CALL NOW FOR FREE CATALOG

Inquiry 35

NEW AN I/O™ Series
Analogue Interfaces
for your PC/APPLE

**Versatile
 Accurate
 and Fast**



MODELS

- AP-8 • 8-bit A/D and D/A to 50Khz. amplifier, anti-aliasing filters, etc. \$299.
- AP-12 • 12-bit A/D and D/A to 40Khz. analog multiplexer, amplifier, S/H, 8-bit I/O, clock, etc. \$450.
- PC-12 • 12-bit A/D or D/A to 60Khz. analog multiplexer, amplifier, anti-aliasing filter, S/H, on board VCO function generator, 8-bit I/O, etc. \$750
- PC-DMA • Our best available analog interface. 12-bit A/D or D/A to 100Khz. DMA driven to allow real-time processing on board timer for zero timing jitter, input and output filters, amplifier, S/H, multiplexer 500Hz to 100Khz phase-locked (to timer) function generator, fully program mable, \$1 250.

PC-model designation refers to IBM PC compatible boards. AP for Apple II. Prices include software. Peripheral multi-channel input signal conditioner and filter, and PC-based FFT board available soon. For purchase or info please contact:

CANETICS, Inc. PO Box 70549, Pasadena, CA 91107
 Telephone (818) 584-0438

Inquiry 53

DATA ACQUISITION TO GO
INTERFACE FOR ANY COMPUTER
FREE IBM SOFTWARE

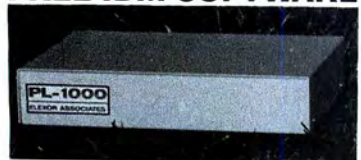

Connects via RS-232. Fully IBM compatible. Built-in BASIC. Stand alone capability. Expandable. Battery Option. Basic system: 16 ch. 12 bit A/D, 2 ch. D/A, 32 bit Digital I/O. Expansion boards available. Direct Bus units for many computers.

(201) 299-1615

P.O. Box 246, Morris Plains, NJ 07950

ELEXOR

Inquiry 91

Why waste time?

**ACCELERATE
 with VCACHE™**

HARD DISK ACCELERATOR

- Caching eliminates repetitive disk accesses
- Use up to 15 Mb of extended/expanded or 500 Kb of standard memory

**DISKETTE ACCELERATOR
 SCREEN ACCELERATOR
 FAST — FRIENDLY — SAFE
 VCACHE
 GOLDEN BOW SYSTEMS**

\$65

Add \$3 for shipping/handling
 California residents add 6% sales tax



2870 Fifth Avenue Suite 201
 San Diego, CA 92103
619/298-9349

Inquiry 114

**Get the whole
 story on graphics
 terminal emulation.**



To find out more about software that lets your PC emulate **TEKTRONIX™ 4105/6/7/9** and **DEC VT100™** terminals, call or write:

GRAFFPOINT

4340 Stevens Creeks Blvd., Suite 280,
 San Jose, CA 95129 (408) 249-7951

Inquiry 117

DYNAMIC RAMS

41256	100ns	\$4.85
41256	120ns	\$3.25
✓41256	150ns	\$2.90
4164	120ns	\$1.40
✓4164	150ns	\$1.10
4464	150ns	\$3.95

PROCESSORS		E. PROMS	
8087-2	8MHz \$159.00	27C256	250ns \$6.50
8087-3	5MHz \$115.00	27256	250ns \$5.25
80287-3	6MHz \$179.00	27128	250ns \$3.95
80287-8	8MHz \$ CALL	27C64	200ns \$4.50
V-20	8MHz \$ 12.75	2764	250ns \$3.25
V-30	8MHz \$ 14.00	2732A	250ns \$3.75
STATIC RAMS		8000's	
6264LP-15	150ns \$2.95	(Parts in stock)	

I.C. EXPRESS

15358 Valley Blvd., City of Industry, CA 91746
 Phone: 818-369-2688 (Mon-Fri • 8-5)

(800) 892-8889 • (800) 882-8181
 Outside California Inside California

CALL FOR CURRENT PRICES & VOLUME DISCOUNTS.
 Price Shown for Cash + MasterCard/VISA add 3% more.
 Prices are subject to change. Minimum order \$10.00.
 California residents must add 6.5% sales tax.
 Shipping & Handling: UPS Ground \$5.00, UPS Air \$7.00 (under 1lb.)
 ALL MERCHANDISE IS 100% GUARANTEED.

Inquiry 137



INI-10/AT

PC-AT EXPANSION CHASSIS

- Full 16-bit PC-AT bus
- 10 slots
- 250W power supply
- Two fans
- Direct extension of PC-AT bus
- No software changes needed
- Inexpensive, simple, attractive

Dealer inquires invited.
 List Price \$1,400.00

INI Computer Products
 6915 Hightech Drive
 Midvale, UT 84047

(801) 561-1100
 Contact Mark Jenkins

Inquiry 140

**GAT-286
 COMPLETE SYSTEM—\$2195⁰⁰**

Includes one megabyte memory on board, 6 or 8 MHz, zero wait state, Phoenix BIOS; Disk drive controller with 2 floppy disk drives (1.2 M.B. and 360 K) and one 20 M.B. hard disk; monochrome monitor with adapter, serial/parallel ports; 200 W. power supply, keyboard, case. IBM PC/AT compatible. Certified to comply with FCC class B standards.

PC/XT/AT COMPATIBLE PARTS

- Seagate 30 M.B., High Speed Hard Disk **\$645.00**
- 20 M.B. Hard Disk Kit for PC/XT **\$395.00**
- 30 M.B. Hard Disk Kit for PC/XT **\$465.00**
- 135 W. Power Supply **\$ 65.00**
- I/O Card for XT or AT **\$ 75.00**
- LOGIMOUSE **\$85.00**
- 8087-3 Co-Processor **\$120.00**
- 80287-3 Co-Processor **\$215.00**
- XT Compatible System w/640 K, all ports & clock, 2 drives, monochrome monitor **\$825.00**

LUCKY COMPUTERS
(214) 690-6110

1701 Greenville, Suite 602, Richardson, TX 75081

IBM PC/XT/AT are Registered Trademarks of International Business Machines Corp.

Inquiry 171

U.L. Rated • High Reliability • Full Technical Support



140W (Typ.) 150W(Max.)
 PC/XT \$129.00

- U.L. recognized, yellow card available File # E-101115(S)
- Meet FCC class B, European safety spec.
- 115/230V AC convertible
- Low noise DC fan
- OVP, OCP, short circuit protection
- IBM® standard pin out or Faraday type pin out selectable
- 100% 24 hrs. burn-in 100% pre-shipment test.
- One full year warranty

Your PC represents a substantial investment. It does not make sense to risk costly down time due to bargain power supply, when for a few dollars more you can have the confidence of FORTRON QUALITY.

IBM is a registered trademark of International Business Machines.



FC 5192 200W (max)
 PC/AT \$189.00

PROFITABLE DISCOUNT PRICES FOR SYSTEM INTEGRATORS & DEALERS - PLEASE CALL

FC 520 Color Graphic / Mono / Printer  <ul style="list-style-type: none"> • TTL / composite level outputs • 320 x 200 (color) 640 x 200 (B&W) • Centronics Printer Port \$99.00	FC 550 (CT-6040) Monochrome / Graphic / Printer  <ul style="list-style-type: none"> • 80x 25 text mode • 720x348 graphic mode • Run Lotus 1-2-3 - autocad. etc. • IBM® compatible \$99.00	FC 730 (CT-6050C) 384K Multifunctions  <ul style="list-style-type: none"> • Memory expansion to 384K • Clock / calendar • Serial, parallel ports • Game port (OK) \$119.00	FC 740 Multi-I/O w / Floppy Controller \$109.00  <ul style="list-style-type: none"> • 1 EIA-RS232C port (2nd optional) • 1 Centronic port, game port • Clock / calendar • Control 2 floppy drives • *FC 770) w / a Floppy Controller \$99.00	FC 1730 Multifunction Card for PC AT  <ul style="list-style-type: none"> • 1 EIA-RS232 port (2nd optional) • 128K to 1.5MB memory • Expandable to 3 MB (optional) by piggy back board • Game port \$169.00	FC 1930 RS232 / Printer Port for PC AT  <ul style="list-style-type: none"> • 1 EIA RS232 port (2nd optional) • Centronics parallel port \$99.00
FC 940 RS232C / Real Time Clock  <ul style="list-style-type: none"> • RS232C port • To 1920 baud • Battery back-up \$59.00 (clock only) \$49.00	Hard Disk Controller  Hard Disk Controller for XT <ul style="list-style-type: none"> • DTC 5150 BX \$149.00 • WD WX-2 (Western Digital) \$145.00 • Cable \$ 9.50 F.D. & H.D. Controller for AT <ul style="list-style-type: none"> • DTC 5290 \$265.00 • Western Digital WA-2 \$260.00 • Cable Set \$ 19.00 	FC 230 Floppy Disk Controller  <ul style="list-style-type: none"> • Drives up to four 5 1/4" floppy drives • IBM compatible • With cables \$59.00	XT CPU Board  FC 150 (4.77 MHz) \$149.00 FC 180 (8.00 MHz) \$189.00 <ul style="list-style-type: none"> • Expandable to 640K on board memory • Optional 8087 co-processor • Optional IBM® comp. BIOS 	Modems \$149.00  INTERNAL Hayes Compatible 1200 Baud \$148.00 2400 Baud \$425.00	SPECIAL <ul style="list-style-type: none"> • FC 830 512K memory exp. card \$69.00 • FC 830S 576K memory exp. card \$69.00 • FC 930 serial/parallel adaptor for XT \$49.00 • FC 530 monochrome controller w/printer port \$79.00

Enhanced Graphic Adaptor IBM® Compatible \$239.00  w/o printer port <ul style="list-style-type: none"> • For PC/XT/AT and compatibles • 256K on board memory • Full 16 colors in 640x350 on IBM® enhanced color display • Support 640x350 IBM® compatible enhance color and monochrome monitors • Parallel port • Light pen interface 	 EGA Monitor \$459.00	FORTRON 200 U.P.S. for PC  <ul style="list-style-type: none"> • 115V / 230V AC input convertible • Input current 2.5 amp • 200W continuous • 1/2 cycle (typical) transfer time • Hold-up time from 20 minutes (200W) up to 60 minutes (60W) • 5.12" x 7.7" x 13.48" \$259.00	FC 447 PC/AT Keyboard \$109.00  <ul style="list-style-type: none"> • IBM AT compatible keyboard • Enlarge return key • Light on num. lock key 	FC 427 (5150 Type) \$79.00  FC 437 (5151 Type) \$99.00  <ul style="list-style-type: none"> • For PC XT • Large return key • Light on num. lock keys
---	---	---	--	---

CABINETS & EXPANSION CHASSIS

FC 630 A-2 XT CHASSIS \$79.00  <ul style="list-style-type: none"> • For PC XT compatible side switch • To use FC 135-40 power supply • Complete mounting hardware 	FC 620 AT CHASSIS \$139.00  <ul style="list-style-type: none"> • For PC AT compatible • LED lamps, key, key lock, speaker and mounting hardware included 	FC 610 Drives Chassis \$149.00  <ul style="list-style-type: none"> • 18" x 8" x 6" • Capable of holding 2 half-height drives • Come w / power supply, fan • LED power indicator 	FC 640 / 5 Slots PC Expansion Chassis \$388.00  <ul style="list-style-type: none"> • W / 5 slot bus board • 100W power supply, fan • Capable of holding 3 half-height drives • Dia. 15 1/2" x 12" x 6 1/4" • System interface adaptor included 	FC 650 / 8 Slots PC Expansion Chassis \$398.00  <ul style="list-style-type: none"> • PC XT identical size • W / 8 slot bus board • 140W power supply • 4 half-height drives • System interface adaptor included 	FC 660 / 12 Slots PC Expansion Chassis \$438.00  <ul style="list-style-type: none"> • Dia. 15 1/2" x 15 1/4" x 5 1/2" • W / 12 slot bus board, power supply, fan • Capable of holding 2 half-height drives • System interface adaptor included
--	---	--	--	--	---

MONITORS \$89.00 <ul style="list-style-type: none"> • Monochrome Tatung MM 1222 A / G \$109.00 Samsung \$89.00 • Color Hi-Res (640 x 200) Tatung CM-1380 \$359.00 • Enhanced Graphic (640 x 350) Tatung CM-1380 \$459.00 Princeton HK-12E \$529.00 Mitsubishi EGA \$529.00 Quimax PX-22 \$459.00 	DISK DRIVES <ul style="list-style-type: none"> • Floppy Teac 55BV \$109.00 1.2 MB 55GFV \$149.00 • Hard (w / controller & cable) 10 MB \$379.00 20 MB ST-225 \$399.00 20 MB ST-4026 (40 MS) drive only \$579.00 30 MB ST-4038 (40 MS) drive only \$669.00 31 MB CMI-6640 (40 MS) drive only \$499.00 	Tape Back-Up (w / controller, cable & tape)  INTERNAL Sysgen 20 MB \$575.00 Sysgen 60 MB \$745.00 EXTERNAL Sysgen 20 MB \$749.00 Sysgen 60 MB \$955.00	Printers \$89.00  Acmate DP-130 \$195.00 <ul style="list-style-type: none"> • 130 C.P.S. • 80 columns • 9 x 9 dot matrix field • Parallel standard interface TTX-80 \$ 89.00 <ul style="list-style-type: none"> • 50 C.P.S. • 80 columns • Parallel standard interface • Thermo printer 	RAM CHIPS <ul style="list-style-type: none"> • 64K RAM \$11.00 / 9 pc. • 256K \$33.00 / 9 pc. • 128K \$44.00 / 9 pc. (for PC AT)
Terms: • Min. shipping & handling \$6.00 • CA res. add 6.5% tax • Restocking charge 15% • No rtn. goods w/o a RMA no. • Prices subject to change w/o notice				

TWO DEVICES CAN SHARE A SERIAL PORT WITHOUT SWITCHING

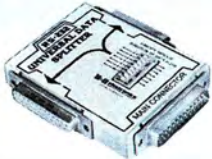

\$54.95

Model
232UDS

2 computers can share a printer. 2 terminals can share a modem. No power required. Supports pins 1-8 and 20. Order Now! Universal Data Splitter, Model 232UDS, \$54.95. Cash orders postpaid. (IL res. add 6 1/4% sales tax). Visa and MasterCard accepted. Satisfaction Guaranteed. FREE! Just published 1986-87 fully illustrated catalog of interface & testing equipment. Phone 815-434-0846.

B & B electronics
MANUFACTURING COMPANY
1500L BOYCE, OTTAWA, IL 61350

Inquiry 29

HELP IS HERE !!!

Quit wearing out the pages of your software manuals! Mainframe and Mini users quit years ago. Now they use on-line HELP -- so why not step up and see what you've been missing? With **microHELP** you can have on-line access to the description and syntax for all your DOS commands and special programs. Novice DOS users find it a real aid in becoming familiar with DOS commands. Experts enjoy the increased productivity of having command information on-line.

- DOS 2.x and 3.x libraries supplied.
- Disk space requirements reduced using Huffman compression algorithm.
- A utility for adding new subjects to the library or for generating new libraries is provided.
- Complete source code to the access routines enable users to write programs that can access any library generated by **microHELP**. Great for program messages.
- Requires MSDOS or PC DOS 2.1 or later and 256k memory. Hard disk desirable but not required.

ONLY \$60.00 Checks and COD

VITAL SYSTEMS

P.O. Box 61738 • Palm Bay, FL 32906
(305) 723-1808

TRADEMARKS: **microHELP** (VITAL SYSTEMS),
PCDOS (IBM), MSDOS (MICROSOFT).

Inquiry 296

NEW EPROM PROGRAMMER

\$349



The EP-1 is a great value, here's why:

- IBM PC Software included or RS-232 to any computer
- ASCII Command driven operation; All intelligence in unit
- Reads, Programs, Copies over 150 types from 2716 to 27512
- Optional Intel microcontroller programming head
- Menu-driven Chip Selection; No Personality Modules
- Fast, Slow, Quick-Pulse Programming Algorithms
- Intel (8080 & 8085), Motorola, Takfax, Straight Hex Files
- Splice Files By Base Address and Odd/Even (16 bit systems)
- Gold Textual ZIF IC Socket
- Generate & Set Checksums
- Over-Current Protection
- 8 Baud Rates 300 to 38,400
- Full One Year Warranty
- 5, 12.5, 21, 25V Programming
- UV Erasers from \$34.95

BP Microsystems

5325 Glenmont, Suite E, Houston, TX 77081
(800) 225-2102 (713) 667-1636

Inquiry 44

COLOR

VT220 \$150

*plus your PC, XT, AT, or compatible

ZSTEMpc-VT220 Smart Terminal Emulator
Double high/double wide characters
Full line graphics. Smooth Scrolling
2-way file transfers incl. XMODEM & KERMIT
Full keyboard softkeys/MACROS. DOS access
Data rates to 384 KB High throughput
CGA, Hercules, MDA, & EGA support
8-bit mode, downloadable fonts,
user defined keys, full national/multinational modes
ISO and attribute mapped color
ZSTEMpc-VT220 \$150. 4010/4014 option \$99.
Also available VT220 Style replacement keyboard
ZSTEMpc-VT100 \$99. - Choice of the U.S. A/V
30 day money back guarantee. MC/VISA

KEA SYSTEMS LTD.

#412 - 2150 W. Broadway
Vancouver, B.C. CANADA V6K 4L9
Support (604) 732-7411
TELEX 04-352848 VCR

Order Toll Free (800) 663-8702

Zstem by KEA SYSTEMS

Inquiry 311

COMPUTER BRIDGE

♥ TRY IT FOR FREE ♥

- Deals, Bids, Declares, Defends and Scores
- Enjoy over a MILLION Deals - or your own
- Scoring: Rubber-MPS-IMP-S-Chicago-Partials
- Either partnership can optionally Signal
- Runs on either a Color-Graphics or Text Display
- Cancel, Claim, Concede, Hints, Take-Back
- For 1 to 3 players - partners or opponents
- Novice to Advanced Features- for all players
- Newsletter subscription and Owner Tournaments
- Disk: **Not Copy-Protected** - can be Backed-up

- Here is what the Critics are saying...

"RECOMMENDED" Jerry Pournelle - BYTE JAN 86

"A Challenging Opponent" PC World - NOV 85

FOR ANY 256K IBM-PC OR COMPATIBLE

THE \$75 BRIDGE PARLOR™ Game

Use it FREE for 15 days - then decide

☎ 1-716-865-8412 Today

or Send order to Parlor Software Co.

Box 17850, Rochester, NY 14617

(No \$4 S&H Charge on Phone orders)

- Same Day Shipping - Dealer Inquires Welcome

Guaranteed to be Strongest Available

Inquiry 222

American Semiconductor

THE BARE XT TURBO SYSTEM
\$399

"Looks, feels, and acts like an IBM. AND it's 100% compatible."

8087 \$119.00
80287-3 175.00
64K99
41256K-150 2.39
41256K-200 1.99

BABY AT \$499.00
V-20 14.00
FLOPPY 75.00

XT & AT ADD ON CARDS
For AT, XT, Compaq, & Corona:

20MB Hard Drive \$325

30MB Hi-Speed RLL KIT \$499

TO ORDER TOLL FREE CALL
1-800-237-5758, EXT. 816

Inside Florida
813-961-9444

Technical Line
1-813-961-5584

Prices subject to change. Add 3.2% for VISA/MC purchases.
16520 N. Florida Ave., Lutz, Florida 33549

Inquiry 19

NEW!



SafeSkin™
KEYBOARD PROTECTOR

Remains in place during keyboard use. Prevents damage from liquid spills, dust, ashes, etc. Fits like a second skin, excellent feel. Available for: IBM-PC, AT, Apple (all), Compaq, Model 100, NEC 8201, C64, Zenith 150, DEC, Kaypro, KB5151, AT&T 6300, WYSE 50 and many others. Send \$29.95, check, M.O., Visa & MC include exp. date. Specify computer type. Dealer inquiries invited. Free brochure avail.

Merritt Computer Products, Inc.
2925 LBJ Fwy, #180 / Dallas, Texas 75234
(214) 339-0753

Inquiry 188

Motion Control & Data Acquisition

on your IBM PC or Apple II and all compatibles



Smart 2 Axis Motion Controller: For many types of motors & encoders. New IC (from HP) allows changes & monitoring on the fly. Optically isolated. W/SOFTWARE \$350.

Four Axis Stepper Driver: With SOFTWARE & motor for instant automation. \$95.

Fast A/D Board: With programmed gain, 650 KHz, 4 inputs, \$220. Complete Scope hardware & SOFTWARE \$500. Also: 12 Bit A/D, Relay Driver, Real Time Clock: Circuit developers Project Book \$25.

How do you do it? Use our Local Applications Bus, LAB 40. One host adapter (\$150) supports up to 8 boards, like those above, on a 50 ft. ribbon cable.

Please call (415) 755-1978 for free literature.

Computer Continuum

75 Southgate Ave., Suite 6
Daly City, CA 94015

(415) 755-1978

Inquiry 59

UPGRADE YOUR XT™

Our XAT-286 Mother Board is XT™ sized, AT compatible

- Fits XT enclosure
- fits into XT power supply
- 8 times faster than XT
- Completely compatible with AT hardware and software
- Intel 80286 CPU 6/8 MHz
- 512K RAM capacity on board

Challenger COMPUTER INC.

THE PRICE PERFORMANCE LEADERS
122 South Rd., Bedford, MA 01730
(617) 275-3517

IBM, PC, XT, and AT are trademarks of IBM Corporation

Inquiry 59

GEM

MAXIMUM PERFORMANCE.



GEM-ST Don't be fooled. No hidden cost!

In keeping with industry trends MSO is bringing our customers high performance P.C. compatibles and accessories. The GEM-ST™ features the V20-8 chip which runs at three times the speed of the IBM-PC XT* and also runs CPM 8080 software.

**FREE 5 module
intergrated software**

\$ 1199

**22 meg sub-system
with tape back-up
\$599 w/purchase**

GEM-ST Specifications:

CPU - V20-8 Chip & Run CPM Software
RAM - 640K
Clock Rate - 4.77 or 8 MHZ
Disk Interface and Drives - (2) - 5-1/4" floppy drives 360K
ROM BIOS - Legal BIOS
Keyboard - AT Style Keyboard
Expansion Slots - 8 IBM* compatible slots
Power Supply - DC Voltage and Max Current
+ 5V @ 15A - 5V @ .5A
+ 12V @ 6A - 12V @ .5A
Input Voltage 115/230V
Meets UL/FCC Standards
Standard Interface - (1) - Serial RS-232-Port
(1) - Game Port
(1) - Parallel Printer Port
Clock - Clock calendar battery backed up
Video - TTL Hi-Res Monographics Card and TTL Monitor
Operating System - MS-DOS
Warranty: 1 year all parts.
90 day labor.

GEM-AT Specifications:

CPU - 80286
RAM - 1 Meg
Clock Rate - 8 MHZ
Disk Interface and Drives - (1) - 5-1/4" floppy drive 1.2 Meg
ROM BIOS - Legal BIOS
Keyboard - AT Style Keyboard
Expansion Slots - 8 IBM* compatible slots
Power Supply - 200 Watt
Meets UL/FCC Standards
Standard Interface - (1) - Serial RS-232-Port
(1) - Parallel Printer Port
Clock - Clock calendar battery backed up
Video - TTL Hi-Res Monographics Card and TTL Monitor
Operating System - MS-DOS
Warranty: 1 year all parts.
90 day labor.

EDUCATIONAL DISCOUNTS

At Micro Supply Organization we offer the lowest prices on GEM computers. With prices like these you can afford the convenience of owning and operating more than one computer.

We also offer the User Support Hotline for questions concerning GEM computers. Whether you need one or a dozen computers, Micro Supply Organization is the place to get them.



GEM-AT Performance for the power user.

The GEM-AT™ runs eight times as fast as an IBM-XT™, for your multi-tasking and multi-user needs.

Including MS-DOS 3.2 with G.W. Basic. The GEM-AT™ is a complete turnkey system with everything to plug and go!

**FREE 5 module
intergrated software**

\$ 1899

**32 meg sub system
with tape backup
\$799 w/purchase**

MSO
**MICRO
SUPPLY
ORGANIZATION INC.**

For our catalog with complete details and prices, send \$2 to:

Micro Supply Organization, Inc.
4909 Stockdale Hwy #180
Bakersfield, CA 93309



15% Restocking on Returned Orders

805/393-2247

Expand your options!

DISK UPGRADE BIOS for ATs

Forget Drive Table Limits!

- Use any Compatible Drive on the AT Controller
- For DOS, UNIX, XENIX . . .
- Plug-in Installation
- Includes set-up and low-level format

DUB-14 GOLDEN BOW SYSTEMS

\$95

\$3 shipping/
handling
California orders
add 6%



2870 Fifth Avenue
Suite 201
San Diego, CA 92103
619/298-9349

Inquiry 115

DOUBLE PLOTTER COLOR PRINTER LETTER
CASSETTE RECORDER VOICE RE
THE OPTION CAPACITY
OF YOUR IBM PERSONAL COMPUTER

PC-XTRA

- DIRECT EXTENSION OF IBM PC BUS
- NO SOFTWARE CHANGES
- NO HARDWARE MODIFICATION
- STYLING CONSISTENT WITH IBM

Add all those special options that you've been wanting without worrying about filling your plug-in and back panel space



DEALER INQUIRIES INVITED.

\$549.00* F.O.B. SANTA ANA
*CALIFORNIA RESIDENTS ADD 6% SALES TAX

P C HORIZONS, INC.
1701 E. Edinger, Ste. A6, Santa Ana, CA 92705
(714) 953-5396

Inquiry 217

MICROSTAR

LABORATORIES

DATA ACQUISITION PROCESSOR



ON BOARD INTELLIGENCE FOR IBM PC/XT/AT DATA ACQUISITION

- 80186 coprocessor for real time processing
- Integrated hardware and software
- Runs applications w/o programming
- Software selectable inputs
- Labtech and Lotus compatible
- On board computations — including FFT



For details call or write:
2863 152nd Avenue NE
Redmond, WA 98052
(206) 881-4286 Telex 510 601 3473



Inquiry 197

Truly Low Cost PC Imaging!



IMAGE ACE II

Video Capture System

- Digitize video from cameras, tuners, and VCRs directly to your IBM PC display
- 320 x 200 x 4 levels
- 1.3 sec. full screen capture
- Complete with hardware card, software, cable, and manual

LODGE ELECTRONICS

P.O. Box 338 • Streamwood, IL 60103
(312) 837-6553

Inquiry 165

Flow Charting II™ FAST. SIMPLE. SPECIFIC.

Now build, update and print process flow and organizational charts easily, confidently.

- Readjust chart immediately after addition or deletion
- Travel quickly across a 120 or 200-column screen
- Move a single character or half a chart - instantly.

Present the true, current picture. Use Flow Charting II on your IBM® PC compatible system. General Motors, Bechtel, Touche Ross, Fairchild and 500 other major US corporations use it.

1-800/672-3470, ext. 897 Calif.
1-800/538-8157 ext. 897 National
408/629-5044 International

PATTON & PATTON

340 Lassenpark Circle
San Jose, CA 95136

IBM is a registered trademark of International Business Machine Corp.

! not only a
printer buffer !
THIS IS THE MOST SOPHISTICATED
PRINTER BUFFER - MULTIPLEXOR - SWITCH

WITH TWO SEPARATE INPUTS (SERIAL AND PARALLEL) AND TWO SEPARATE OUTPUTS (SERIAL AND PARALLEL) CAN BE USED LIKE STANDARD BUFFER WITH ANY INPUT TO ANY OUTPUT BUT ALSO YOU CAN CONNECT 2 COMPUTERS TO 1 PRINTER, OR 1 COMPUTER TO 2 PRINTERS, OR 2 COMPUTERS AND 2 PRINTERS AND MORE - 1 COMPUTER TO 3 PRINTERS OR 3 COMPUTERS TO 1 PRINTER
HIGH CAPACITY - 64 KB TO 256 KB AND - 256 KB TO 1 MB (MODRS A AND B) PAUSE, COPY AND RESET FUNCTIONS
SERIAL PORTS WITH 7 OR 8 BITS WORD LENGTH 1 OR 2 STOP BIT, PARITY, XON/XOFF, DTR, RTS

DCB-A-64K \$ 195 DCB-B-256K \$ 255 (*)

(*) Power supply and parallel cables are included

ALSO, WE HAVE THE MOST COMPLETE DATA CONVERTER UNIT CONVERTS RS232 SERIAL TO CENTRONICS PARALLEL OR VICE VERSA, JUST BY MOVING JUMPERS BAUD RATE AND PROTOCOL FULLY PROGRAMMABLE FROM 150 TO 19200 BAUDS INCLUDES DTR, RTS, XON/XOFF, PARITY, etc

DCU \$ 80 (**)

(**) Power supply and cables NOT included

serial < > parallel
bi-directional converter



INTECTRA Inc.-Dept.232

2629 TERMINAL BLVD
MOUNTAIN VIEW, CA 94043

(415) 967-8818 TX 345545

a message to our subscribers

From time to time we make the BYTE subscriber list available to other companies who wish to send our subscribers material about their products. We take great care to screen these companies, choosing only those who are reputable, and whose products, services, or information we feel would be of interest to you. Direct mail is an efficient medium for presenting the latest personal computer goods and services to our subscribers.

Many BYTE subscribers appreciate this controlled use of our mailing list, and look forward to finding information of interest to them in the mail. Used are our subscribers' names and addresses only (no other information we may have is ever given).

While we believe the distribution of this information is of benefit to our subscribers, we firmly respect the wishes of any subscriber who does not want to receive such promotional literature. Should you wish to restrict the use of your name, simply send your request to the following address.

BYTE Magazine
Attn: Circulation
Department
One Phoenix Mill Lane
Peterborough NH
03458



Inquiry 225



**We pledge allegiance
to low prices and superior technical service.**

DISK DRIVES FLOPPY

Teac

FD55 B-V (half height 5 1/4" 360K DS/1DD floppy) \$99
FD55 FIG-V (half height 5 1/4" 1.2 MB black or grey faceplate) \$145

Toshiba

HD 040 (half height 5 1/4" 360K black face plate) \$109
HD 04DEG (half height 5 1/4" 360K grey face plate) \$111
HD 08DEG (half height 5 1/4" 1.2 MB grey face plate) \$149

Fujitsu

Half height 5 1/4" 360K black face plate floppy \$85

HARD DISK DRIVES

Seagate

ST225 20MB half height 65MLS with controller card \$395
ST225 20MB half height 65MLS no controller card \$345
*NEW ST238 30MB half height 65 MLS with controller card \$499
ST4026 20MB full height 30MLS no controller \$545
ST4038 30MB full height 30MLS no controller \$645
ST4051 40MB full height 30MLS no controller \$745
Western Digital controller card \$125

Control Data

9415-86 86MB full height 30MLS no controller \$1495
Disk Manager Software for formatting past DOS (3.3MB) \$100

TAPE BACKUPS

Irwin Magnetics

10MB INTERNAL TAPE DRIVE half height unit uses floppy controller \$499
20MB INTERNAL TAPE DRIVE for 286 COMPAQ and AT \$599

Everex

20MB INTERNAL TAPE DRIVE half height with controller \$573
60MB INTERNAL TAPE DRIVE half height with controller \$724

Alloy

60MB EXTERNAL TAPE DRIVE software, cables and controller \$741

Tape Cartridges/Scotch 3M

DC-600A cartridge tape (up to 60MB capacity) \$26
DC-1000 cartridge tape for Irwin tape drive \$19

MEMORY MULTIFUNCTION BOARDS

AST

SIXPACK PREMIUM 512 to 2MB Advantage w/128K (expandable to 3MB, S2G for AT) \$356
RAMPAGE PC 256 to 2MB (EMS board w/extended windowing software) \$234
RAMPAGE AT 512 to 2MB (EMS board 8MHz) \$445

PCA (XT COMPATIBLE)

640K, 4.77MHz, 2 floppies, monochrome graphics, P, TTL monitor, FCC app.....**\$775**

PCA TURBO (XT COMPATIBLE)

640K, one floppy, 20MB, P, S,S,G,C, 4.77 or 8MHz switchable, FCC app.....**\$995**

MULTITECH 900 AT COMPATIBLE,

w/512K, keyboard, up to 5 half-height internal drives, 10 or 6 MHz Switchable, slots, 192 W supply, MS-DOS 3.1 FCC Approved. 1.2MB floppy, one year warranty...**\$1550**
Monitor and Card—add \$129
Alloy network compatible

IBM PC

w/256K, one floppy, 4.77MHz.....**\$1150**

IBM AT

w/512K, 1.2MB floppy 6MKZ, 20MB.....**\$3295**
w/640K, 1.2MB floppy 8MHZ, 30 MB.....**\$4290**

**TOSHIBA T1100
LAP TOP 9 POUND
PORTABLE COMPUTER**

512K memory, 720K 3.5 inch floppy, Liquid crystal display, P, KBD.....**\$1469.00**

MONOCHROME MONITORS

SAMSUNG TTL AMBER or GREEN \$85
AMDEK 310A TTL AMBER \$159
PRINCETON MAX 12 TTL/800 PIXIES \$155

COLOR MONITORS

TVM COLOR MONITOR, Ambi/Gr/640X200 \$299

Princeton Graphics

PL14 EGA 14" Multisync clone \$516
HX-12 31mm dot pitch, 640/240 \$442
HX-12 E 640/350 EGA \$539
SR-12 31mm dot pitch, 640/400 \$539
SIGMA 400 H \$460

Taxan

640 720/400 31 dot pitch \$506
555 16 color card text/graphics \$149

N E C

MULTISYNC 15 75Khz to 35KHz horizontal scan \$569

VIDEO DISPLAY BOARDS

Hercules

GRAPHICS CARD monochrome w/parallel \$194
COLOR CARD color w/parallel \$151
GRAPHIC CARD plus text graphics \$199

Clones

EVEREX color/mono 132 column \$239
GRAPHICS CARD monochrome w/parallel \$99
COLOR CARD color w/parallel \$89
ST8 EGA \$308

BACK-UP POWER AND SURGE PROTECTION

Data Shield

500 W Backup Power Supply \$615
800 W Backup Power Supply \$693
1500 W Backup Power Supply \$1427

Clone

150 W POWER SUPPLY \$99
135 W POWER SUPPLY \$89

Curtis

DIAMOND (SURGE PROTECTOR 6 OUTLET wall) \$35
EMERALD (SURGE PROTECTOR 6 OUTLET cord) \$45
RUBY (SURGE/FILTER/ICORD) \$58

Kinsington

MASTERPIECE \$97
MASTERPIECE PLUS \$131

CHIPS

256K SET \$29
128K SET \$40
64K SET \$10
8087 \$135
8087-2 \$158
80287 \$189
80287-8 \$327

Talltree

JRAM 2 w/OK (Parallel 2MB capacity) \$142
JRAM 3 w/OK (for PC, EMS board up to 2MB capacity) \$184
JRAM AT w/OK (Parallel 2MB capacity) \$190
JRAM 3 AT w/OK (EMS board up to 2MB capacity) \$239

Clone

6 PACK compatible w/S, P, C, G, v. OK (up to 384K) w/software \$99

MULTIFUNCTION I/O BOARDS

DISK I/O operates 2 floppies, and G, S, P, C \$95
AT I/O, Parallel, Serial \$95

MODEMS

Hayes

SMARTMODEM 1200B INTERNAL (1200/300 baud w/SmartcomII) \$384
SMARTMODEM 1200 External (1200/300 baud) \$479
SMARTMODEM 2400 External (12400) \$630

Everex

EVERCOM Modem (1200/300 baud w/software) \$150

US Robotics

COURIER 2400 Baud Internal or External \$491

NETWORKS MULTI-USER

Alloy

PC-SLAVE/16 16 BIT SLAVE BOARD 8088-2 (8MHz Processor, 2 serial ports, 1 Mb Ram) \$895

12 Slot Expansion Chassis 225 Watt power supply \$1135
20' RS-232 Slave Cable \$39
ATNX ALLOY TERMINAL NETWORK EXECUTIVE SOFTWARE \$295
LINK RS 323 ASCII Terminal IBM Keyboard \$625

PRINTERS/DOT MATRIX

Citizen

(Epson & IBM Compatible)

MSP-10 160/40 cps dot matrix narrow carriage \$307
MSP-15 160/40 cps dot matrix wide carriage \$414
MSP-20 200/50 cps dot matrix narrow carriage \$347
MPS-25 200/50 cps dot matrix-wide carriage \$520

Epson

FX-85 160 cps, narrow carriage NLO \$434
FX-286 200 cps, wide carriage NLO \$579
LQ 1000 24 Pin, 180 cps NLO 60 narrow carriage \$830
LQ 800 24 Pin, 180 cps, NLO 60 narrow carriage \$630

IBM

Proprinter \$445
Proprinter XL Wide Carriage \$661

Okidata

ML182 120 cps narrow carriage \$228
ML 192 160 cps NLO narrow carriage \$327
ML 193 160 cps NLO wide carriage \$529
ML 292 200 cps 100 NLO narrow carriage color \$614
ML 293 Dual 9 pin, 200 NLO wide carriage color \$803
2410/P/IBM 350 cps 175/351/wide \$1850

Toshiba

P-351 24 pin 288 cps wide carriage \$1025
P-341 24 pin 216 cps wide carriage 180 NLO \$727
P-321 24 pin 216 cps narrow carriage \$442
P-351 C Color printer \$1178

Panasonic

KXP1091 120 cps, NLD 29 cps \$270
KXP1092 180 cps, NLD 33 cps \$348
KX1592 wide carriage 180 CPS NLO 38 cps \$480

N E C

P-5XL24 24 pin 290 cps 100 NLO color \$1071
P-6, P-7, 24 pin \$477/667

LASER PRINTERS

Hewlett-Packard

LASER JET PROFESSIONAL 8 pages per minute \$2357
LASER JET PLUS DPI graphics/SIP interface \$3053

PRINTERS/LETTER QUALITY

Brother

HR-15 17 cps \$368
HR-25 23 cps \$615
TWINWRITER DOT MATRIX 140 cps, LD 36 cps \$1063
M1509 180 cps/45 cps NLO \$420

N E C

ELF (18 cps) \$408
NEC 3550 (33 cps) \$799

Panasonic

KXP-3131 (17 cps) \$286
KX-P3151 Wide (22 cps) \$448

TERMS: WE ACCEPT C.O.D. CASHIER CHECK, VISA, MASTER CARD, AMERICAN EXPRESS (3% EXTRA) WIRE TRANSFERS, APPROVED P.O.'S. ALL EQUIPMENT CARRIES NEW FACTORY WARRANTY. PRICES ARE SUBJECT TO CHANGE. ANY RETURN ITEM MUST BE ACCOMPANIED BY A RETURN AUTHORIZATION NUMBER AND DESCRIPTION. IBM, COMPAQ, SEAGATE IS A REGISTERED TRADEMARK OF THEIR RESPECTIVE COMPANIES.



pcAmerican

Marketing, Inc.

17195 Newhope St., Suite 104, Fountain Valley, CA 92708

Inquiry 226

HOURS:
MONDAY — FRIDAY
8:30 — 5:30
SATURDAY
10:00 — 2:00

1-714-557-3903
CUSTOMER SERVICE

1-800-654-5365
SALES HOTLINE

1-714-557-3904
TECHNICAL SUPPORT

NEW DEALER SPECIAL

XT—COMPUTER	QTY	2
640K MOTHER BOARD W/OK	89	
256K RAM	27	
135 WATT POWER SUPPLY	53	
FLOPPY DISK CONTROLLER	27	
FLIP TOP BOX	38	
XT/AT KEYBOARD	59	
MONO/GRAPHICS/PRN (HERC)	54	
TTL MONITOR W/SWIVEL	96	
(1) 360K FLOPPY	32	
PARTS	\$535	
ASSEMBLY & TEST	64	
	\$599	
20 MEG HARD DISK W/CONTROLLER	425	

AT COMPUTER	QTY	2
80286 MOTHER BOARD	595	
W 512K RAM		
200 W POWER SUPPLY	98	
AT BOX W/KEY LOCK	79	
SERIAL & PARALLEL CARD	65	
AD KEYBOARD	59	
1.2 M FLOPPY	129	
FDD & HDD CONTROLLER CARD	25	
PARTS	\$1,250	
ASSEMBLY & TEST	50	
	\$1,400	

30 MEG 40 MSEC HARD DRIVE	615
EGA CARD	295
EGA MONITOR	449

XT PORTABLE \$995

- 640K MOTHER BOARD
- 640K RAM
- MULTI I/O CARD
- CLOCK, CALENDAR, SERIAL,
- PARALLEL
- TWO 360K FLOPPY DRIVES
- MONO/GRAPHICS/PRN (HERC)
- DETACHED KEYBOARD
- 135 W POWER SUPPLY
- PORTABLE CASE
- 9" MONITOR, GREEN or AMBER



ADD ON BOARDS — PARTIAL LIST

XT-640K TURBO 4.77/8 MHZ W/OK	99
LOCAL AREA NET CARD W/SOFTWARE	249
384K MULTI-FUNCTION (AST 6 COMP) OK	69
MODEM CARD 300/1200 (HAYES COMP)	149
DISK I/O 2FD CTRL, PRN, SER, CLOCK, CAL, GAME	70
AB SWITCH BOX W/64K BUFFER (1:2 or 2:1)	94
AB SWITCH BOX (1:2 or 2:1)	29
COLOR/GRAPHICS/PRINTER CARD RGB	58

ACS IMPORTERS
5311 DERRY AVE., UNIT A
AGOURA HILLS, CA 91301
HOURS 9 AM - 6 PM PST
(818) 889-1092
TELEX: 299353 POST UR

PC DIADAC " " TAKE CONTROL WITH YOUR IBM PC/CLONE
16 CHANNEL 12 BIT ANALOG INPUT
UPTO 4 CHANNEL ANALOG OUTPUT
\$375.00 DIGITAL I/O 24 LINES



DIADACS 1 " " TAKE CONTROL WITH YOUR COMMODORE 64
16 CHANNEL 12 BIT A/D CONVERTER
D/A CONVERTER 12 BIT
DIGITAL OUTPUT 10 LINE
DIGITAL INPUT 12 LINE
REAL TIME CLOCK



Comes complete with user's manual and software driver. \$279

CONTROL MODE 1 DATA ACQUISITION SOFTWARE for C64 150
DEALERS/REPRESENTATIVES PLEASE CALL
MICROTECH P.O. Box 102 • LANGEHORNE, PA 19047 • (215) 757-0284

Inquiry 50

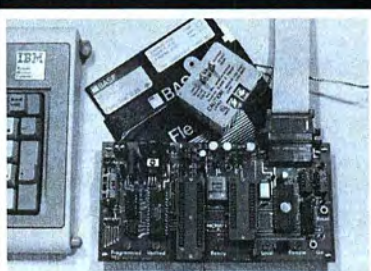

MOTOROLA 6805 SINGLE CHIP MICROCOMPUTER DEVELOPMENT SYSTEMS

Two systems from TEC allow the IBM PC/XT/AT to be used as a complete development system for the Motorola 6805 series single chip microcomputers. Model MCPM-1 supports the MC68705P3,P5,U3,U5, R3, & R5 chips. Model MCPM-2 supports the MC1468705F2 & G2 cmos versions. Both systems are priced at \$495 and include a cross assembler program, a Simulator/Debugger program and a programming circuit board with driver software. One serial port required.

TEC
PO Box 53, West Glover, Vt. 05875
(802) 525-3458

Inquiry 278

Beat the limits!

Vfeature™ DELUXE

Software for hard disks

- DOS partitions to 1 GIGABYTE
- Spans two drives in one bootable partition
- Supports big drives on AT and XT
- Secures data

GOLDEN BOW SYSTEMS

\$120

\$3 shipping/handling
California orders add 6%



2870 Fifth Avenue, Suite 201
San Diego, CA 92103
619/298-9349

Inquiry 116

MYSTIC PASCAL 640K CODE & DATA

- complete programming environment with editor
 - first incremental compiler for Pascal
 - 8087 & software math
 - true MULTI-TASKING support
 - spectacular graphics on 20 screens with pan & zoom
 - creates linkable OBJect files
 - open 8 to 5 Mtn. time, Mon thru Sat
- Disk with condensed manual to print out \$16. Full printed manual \$16—both \$32. For IBM PC 320K, Visa/MC/COD—add \$2 shipping, COD \$3. Overseas add \$10 for disk & manual or \$5 for disk only.

Mystic Canyon Software
P.O. Box 1010
Pecos, NM 87552 505/757-6344

NEW VERSION 1.6—STILL ONLY \$16!!!

Inquiry 202

MEMORY

Virtual

MicroVMS gives you 4 MBytes of LIM Expanded Memory WITHOUT BOARDS. Uses hard disk or Advantage! RAM for 1-2-3 Rel 2, Symphony 1.1, Reflex 1.1, or SuperCalc 4 data storage. Only \$75.

Conventional

XTend puts 640K on the system board of your IBM XT, Compaq Portable or Plus. From \$24.50 to \$119.00.

Expanded

Breakthru/PC adds 2 MBytes of LIM expanded memory to your PC, XT, AT or compatible. Check our specs before buying Above Board or RAMpage! From \$150 (no RAM) to \$450 (2 Mbytes).

VERICOMP

8825 Aero Drive (Suite 210)
San Diego, CA 92123

VISA 619-277-0400

Inquiry 294



COMPLETE MONEY MANAGEMENT FOR HOME AND BUSINESS.

- Checking, Savings and Credit Card Mgmt.
- Smart Account Reconciler With Automatic Error Detector
- Budgeting • CPA Designed • Financial Statements • Graphics
- On-Line Help Screens • High Speed Financial Data Base • Inquiry Reports • Pop-Up Calculator • Tutorial
- Not copy protected • Simplifies Tax Preparation • Much More.

Only \$69.95

Visa • MC • C.O.D. Free Brochure 319/373-0197

PARSONS TECHNOLOGY

6925 Surrey Drive NE
Cedar Rapids, IA 52402

Inquiry 223

HUNTING FOR A GREAT DEAL?

HARD DISK DRIVE CARDS

Logic Array MegaCard!



- Hard disk drive on a plug-in card gives PC or compatible the storage capacity of an XT
 - Uses NEC technology for high reliability
 - Fast, easy installation
 - **two year guarantee**—parts and labor
- 21-Megabyte CALL FOR PRICE
30-Megabyte CALL FOR PRICE

HARD DISK DRIVE KITS

(Half height, boots from hard disk—includes controller, cables, manual)

- 20-Megabyte \$415
40-Megabyte \$599
(with Disk Manager software)
On Track Disk Manager Software
sold separately \$65

BOARD LEVEL PRODUCTS FROM MYLEX

- Multifunction card
0-K \$82
384-K \$123
Envision I (mono/color/graphics) . . . \$147
Envision II (mono/color/graphics,
char. RAM enhanced modes) . . . \$156
Color Adapter I \$77
Color Adapter II \$83
Business Master I (mon/par adapter,
enhanced text modes) \$80
Business Master II (high-res. mon graphics,
enhanced text modes) \$91
Enhanced Graphics Adapter \$279
(EGA, CGA, MDA, HGC compatible)
Advanced Graphics Adapter I \$345
(high-res. 800 x 600, CGA compatible)
Advanced Graphics Adapter II \$605
(with 80186 multi-processor)

DISK DRIVE CONTROLLERS

From National Computer Ltd., Japan's premier maker of controllers

- These compact AT-compatible controller cards are among the smallest available.
- Co-resident, IBM-COMPATIBLE

- NDC 5126 AT Winchester only \$179
(a half card—so small you won't believe it's AT-compatible)
NDC 5125 AT Winchester/Floppy . . . \$189
NDC 5127 XT Winchester only \$79
NDC 3011 SASI Controller \$91
Data Technology
DTC5150CX \$99

FLOPPY DISK DRIVES

- 360-K \$89
1.2 Megabyte, AT-Compatible \$129
1.2 Megabyte, PC-compatible
(enables your PC or XT to read and write AT-formatted diskettes)
was \$299—clearance price NOW . . . \$129



EGA SOFTWARE

- Rix EGA paint \$49

CHIPS

- 256K D-RAM (set of 9) \$27
64K D-RAM (set of 9) \$9
V-20 (8 MHz) \$10.95

INTEL MATH CO-PROCESSORS

- 8087 \$125
8087-2 \$179
80287-6 \$225



MONITORS

- TTL Amber \$98
MultiSync CALL FOR PRICE

HERE'S HOW TO ORDER:

We accept Visa, MasterCard and American Express (no surcharge) and Money Orders. Minimum charge card order \$25. No sales tax outside California. (CA residents add 6%.)

Personal or company checks require three weeks to clear.

We insure all orders.

Shipping and handling minimum \$5 up to 3 lbs. within continental U.S. Call for shipping info on other orders.

Prices and availability may change.

Returns require authorization and are subject to restocking charge.

Normal manufacturers' warranties apply. Not responsible for typographical errors.

IBM, MultiSync, MegaCard, Business Card, Mylex EGA Paint and On Track are trademarks of their respective companies.

CALL 800-443-7355
In Calif. call 800-345-4868

Tech. support: 714-533-1651

Hours: Mon.-Fri. 7 a.m.-5 p.m. PDT



P.O. BOX 5008 IRVINE, CA 92715-5008

DON'T MAKE A \$300 MISTAKE!

WHEN YOU CAN
BUY IBM COMPATIBLE
SOFTWARE FOR
ONLY \$6 A DISK
OVER 500 DISKS FULL
OF PUBLIC DOMAIN AND
USER SUPPORTED PROGRAMS

LONE STAR SOFTWARE

Recently a Customer Wrote . . .

"... I'm SICK! Friday afternoon I bought a \$300.00 data base manager from my local computer dealer. When I got home I found out my neighbor bought the same kind of program from you last week for six dollars. What's worse, I like your program better! Please send me your disk directory and the following disks..."

What can we say? Isn't it really about time you discovered that spending big bucks for all of those "glamorous-name" software products doesn't necessarily guarantee you anything but a thin pocketbook and a fancy copy protection scheme?

No... Computerland won't tell you about us or our great software. But why make a \$300.00 mistake? Many of our \$6.00 packages will actually do everything better and faster than the great "Starword-dplus-4.5.6", and you can keep the difference.

Here is just a sample of our library by category.

WORD PROCESSORS

PC-Write 2.6 (#78) A full featured word processor that is faster than Wordstar.
DICTIONARY (#378) Dictionary type spelling checker.
IV-ED (#415) Word processor - editor.
LETTERWRITER (#415) controls letter processing.
PC TYPE (#455) Jim Button's contribution to a full fledged word processor.

SCREEN EDITORS

FOILEDIT (#347) Full screen editor. Top to bottom and left to right.

TEXT PROCESSING TOOLS

FOGFIND (#378) reverses writing complexity using the "Fog Index".
WORDSTAR AIDS (#379) collection of the most useful utilities for the Wordstar user.
PC OUTLINE (#414) Create and collapse and outline. Great for plans, essays, etc.

DATABASE PROGRAMS

PCFILEIII (#5) most popular database program from Jim Button.
U-MIND (#133) Fast hashing makes this a dandy database. (Intelligent database)
NEWBASE (#233) Menu driven database for the beginner.
PC-DBMS (#383) A relational database management system that provides on-line help and screen editing functions.
ELSI EXPERT SYSTEM (#398) Artificial intelligence shell to build a custom knowledge-base.

PDS*BASE (#396) Complete hierarchical data base system master/detail or mother/daughter type.
CREATOR (#339) create, report, and sort makes this a super database management system.

DATABASES

BOBCAT (#247) Small business database. Excellent!
MFIND (#311) Database of over 2000 movies that can be searched in any category, or you can add your own.

SPREADSHEETS

PC-CALC (#199) Fabulous 123 work-a-like from the author of PC-File.
PC-PAD (#406) Spreadsheet and address book program written in basic.

SPREADSHEET TEMPLATES

LOTUS 1-2-3 TEMPLATES AND MACROS (#140, 141, 165, 257, 289, 301-304, 406, 414) Why spend hours of writing your macros when these are ready made? Modify them yourself.

SYMPHONY WORKSHEETS (#305, 306)

FINANCIAL PROGRAMS

PC-CHECK MANAGER (#275) Keeps multiple checkbooks in balance.
TAX FILE DBS (#295) Tax record keeping system that saves you money on April 15.
SAGE TRADER (#242) Analyzes commodity trades. Don't "short" this one!
PORTSWORTH PACKAGE (#101) Evaluates your ever changing stock portfolios.
FINANCE (#164, 227) Determine present and compound values, interest rates, etc.
HOMEFINANCE (#406) Lotus 1-2-3 Macros for real life applications.
PC-GENERAL LEDGER 1.2 (#237) An exceptional accounting system. Used by some CPA's.
TIME AND MONEY (#251) Financial record keeping and analyst system.

LOAN AMORTIZATION (#399) For output to screen or printer. Lots of on-line help.
BASIK CHECKBOOK (#271) Keep track of checkbook and personal finances.
ACCU-TAX 1985 (#479) You can't buy a better "commercial" program.
MR. BILL (#469, 470) Prepare invoices, client report, audit trail, etc.
ANALYTIC CALC (#430-432) 3 disk set. Complete spreadsheet, database, graphics, word processor - fassst!

COMMUNICATIONS

QMODEM (#310) The best and fastest com-

munications programs you can buy at any price, bar none!

PC-TALK (#16) The classic "Freeware" communication program.
PC-VT (#286) VT-100 Emulation.
SYSCOMM (#338) Menu driven system allowing unattended file transfer.
RBBS 12.2 (#212) Become a SYSOP and start a bulletin board.
FIDO NET (#333) Bulletin Board System. Perhaps the easiest to run.

MATH AND STATISTICS

EPISTAT 3.1 (#88) Statistical analysis of small to medium-sized data samples.

LANGUAGES

CHASM 2.13 (#10) Cheap assembler with tutorial.
XLISP 1.4 (#148) Lisp language interpreter.
MVP-FORTH (#31, 32) Two disk set of Mountain Valley Press Forth.
3FORTHs (#352) To modify or expand your own forth language. MVPFORTH, FORTH-H and SEATTLE Computer's Forth.
PROLOG & UNIFORTH (#417) Complete with editor and documentation.
SNOCREST BASIC (#409, 410) two disk set. Real basic interpreter with manual. Can be used with a multi-user system.
ESIE (#398) Build and generate an expert system in a flash.
PASCAL COMPILER (#424) Written in Turbo Pascal.
P-BASIC (#381) BASICA work-a-like for clones, etc.

UTILITIES

DISKCAT 4.0 (#106) Catalog all your disk files in a hurry.
GINACO (#66) 54 polished routines written in basic for any beginner or experts. We love it!
ULTRA-UTILITIES 4.0 (#133, 245) Recover lost files, modify sectors, etc. Like Nortons.
SYSTEMU (#250) Build a menu driven menu system. Excellent for hard disks.
LOAD-US (#284) Allows Lotus and Symphony to be used on a hard disk.
PC-DESKMATES (#405) Better than Sidekick and all of the rest of the memory resident desktop utilities.
ALIGN 1.6 (#217) Disk alignment tool.
TOP UTILITIES (#273) All of the most requested utilities on one disk.
NUMZAP (#284) Removes line numbers from BASIC programs.
HARD DISK UTILITIES (#478) A collection of the best in the library.
UNPROTECT (#414) Various routines to disconnect protection schemes.

PATCHES (#376) make back up copies of some of the most popular commercial programs with this collection.

PRINTER UTILITIES

SP 3.4 (#186, 275) Printer buffer that partitions your data so you can use your computer and print at the same time.
SIDWAYS (#265, 411) Prints text sideways on an Epson printer.
SETPRTR (#79) Sets up Epson printer from a menu.
SLIDE (#244) produce medium resolution slides and overhead transparencies.
PRINTER UTILITIES (#411) Sorgasboard of utilities and tools.
EPSON PRINTER UTILITIES (#326) Spool, set up routines all designed for Epson codes.
BANNER (#386) make long banners with large letters. Includes MS-FORTRAN source codes.

EDUCATION

EQUATOR (#249) A teaching tool for math, science and finance.
PC-TUTORIAL (#403) A first course in computer usage covering various aspects of MS-DOS. Good!
PC-PROFESSOR (#105) Learn Basic the easy way. One of the best tutorials on BASIC.
PC-DOS HELP (#254) type "help" for the DOS command you forgot.
FLASH CARDS (#367-370) 4-disk set. Vocabulary builder, spelling teacher.
TOUCH-TYPE (#320) Advanced type tutor.

GAMES

TOP GAMES (#274) The most requested arcade type games.
ARCADE GAMES (#293) Another goodie bag of top Arcade games.
TRIVIA GAMES (#327-329) Lots of files and documentation for hours of fun. Will not work on PC JR.
PC JR GAMES (#354) Games that will work only on PC JR. Combat, dungeons and dragons, Global Thermonuclear War.
MISC. GAMES (#390) Good selection of educational, adventure, and arcade games.
BIG FOUR GAMES (#272) Texas most popular, STARGATE, ZAXXON, AIRTRAX, and DND

MUSIC

PC-MUSICIAN (#127) Compose music on your PC, save and play again.
PIANO MAN (#279) Play your PC keyboard like a piano.

APPLICATIONS

GENEALOGY ON DISPLAY 3.0 (#90)
GENEALOGY - FT 1.25 (#240) from Pine Cone software.
LABELMAKER (#146) Our favorite label file and maker. Menu driven.
PC-FLY "Fliteplan" 2.1 (#261) Pilots prepare and file your flight plans.
RECIPE 83 (#281) Recipe index for use with PC File III (#5)
FAMILY HISTORY (#361) Family history, ancestor and descendant charts. Sample programs.
FORM LETTERS (#388) LOTS of samples of the most commonly used business letters. Modify!
HAM RADIO (#436, 437) Electronic goodies, design antennas, great circuit, etc.

GRAPHICS

PC-KEY DRAW (#344-345) A small CAD system. Lots of demonstration files.
PC-PICTURE GRAPHICS (#136) Drawing package allows you to zoom, color, and store pictures.
PC-GRAPH (#418) Allows user to create graphics from PC-File report files.
ORIGAMI (#408) Japanese art of paper folding. Graphics required.
DRAFTSMAN (#400) Easy to use presentation quality. Mouse or keys.

ORDER FORM

LONE STAR SOFTWARE, INC.
2100 Hwy. 360, Suite 1204
Grand Prairie, Texas 75050
214/647-1010

CIRCLE DISK NUMBER DESIRED:

1	2	3	4	5	6	7	8	9	10	11	12	13	14	15	16	17	18	19	20
21	22	23	24	25	26	27	28	29	30	31	32	33	34	35	36	37	38	39	40
41	42	43	44	45	46	47	48	49	50	51	52	53	54	55	56	57	58	59	60
61	62	63	64	65	66	67	68	69	70	71	72	73	74	75	76	77	78	79	80
81	82	83	84	85	86	87	88	89	90	91	92	93	94	95	96	97	98	99	100
101	102	103	104	105	106	107	108	109	110	111	112	113	114	115	116	117	118	119	120
121	122	123	124	125	126	127	128	129	130	131	132	133	134	135	136	137	138	139	140
141	142	143	144	145	146	147	148	149	150	151	152	153	154	155	156	157	158	159	160
161	162	163	164	165	166	167	168	169	170	171	172	173	174	175	176	177	178	179	180
181	182	183	184	185	186	187	188	189	190	191	192	193	194	195	196	197	198	199	200
201	202	203	204	205	206	207	208	209	210	211	212	213	214	215	216	217	218	219	220
221	222	223	224	225	226	227	228	229	230	231	232	233	234	235	236	237	238	239	240
241	242	243	244	245	246	247	248	249	250	251	252	253	254	255	256	257	258	259	260
261	262	263	264	265	266	267	268	269	270	271	272	273	274	275	276	277	278	279	280
281	282	283	284	285	286	287	288	289	290	291	292	293	294	295	296	297	298	299	300
301	302	303	304	305	306	307	308	309	310	311	312	313	314	315	316	317	318	319	320
321	322	323	324	325	326	327	328	329	330	331	332	333	334	335	336	337	338	339	340
341	342	343	344	345	346	347	348	349	350	351	352	353	354	355	356	357	358	359	360
361	362	363	364	365	366	367	368	369	370	371	372	373	374	375	376	377	378	379	380
381	382	383	384	385	386	387	388	389	390	391	392	393	394	395	396	397	398	399	400
401	402	403	404	405	406	407	408	409	410	411	412	413	414	415	416	417	418	419	420
421	422	423	424	425	426	427	428	429	430	431	432	433	434	435	436	437	438	439	440
441	442	443	444	445	446	447	448	449	450	451	452	453	454	455	456	457	458	459	460
461	462	463	464	465	466	467	468	469	470	471	472	473	474	475	476	477	478	479	480
481	482	483	484	485	486	487	488	489	490	491	492	493	494	495	496	497	498	499	500

SHIP TO: _____

TOTAL # _____ x \$6 = _____

DISK DIRECTORY (Explanation of all files & programs) x \$6 = _____

OTHER _____ = _____

SUBTOTAL _____

TEXAS RESIDENTS ADD 6% TAX _____

SHIPPING & HANDLING _____

(1 @ \$1.00 and .50 for each additional disk)

TOTAL _____

MASTERCARD VISA

CARD NO. _____

EXPIRATION DATE _____

SIGNATURE _____

PLEASE ENCLOSE CHECK WITH ORDER

38¢

Each

is all you have to pay for the best 5.25" Double Sided, Double Density diskettes to be found!

SuperStar™ and DISK WORLD!™ do it again: super-premium diskettes at the lowest prices to be found anywhere ...without lies, fraud, hokum or crazy deals.

The "Life Is Simple" price list for first-line, top-quality diskettes:

5.25" SSDD (P/N38002).....	38 ea.
5.25" DSDD (P/N38012).....	38 ea.
5.25" SSDD -96TP (P/N38022).....	68 ea.
5.25" DSDD -96TP (P/N38032).....	71 ea.
5.25" DSDD -HD (P/N38042).....	\$ 1.36 ea.
3.50" SSDD (P/N38052).....	\$ 1.39 ea.
3.50" DSDD (P/N38062).....	\$ 1.45 ea.

All prices quoted are for multiples of 100 each. Add 10% for orders of 50 each. All 5.25" diskettes are supplied with Tyvec™ sleeves, user ID labels and write-protect tabs. 3.50" diskettes are supplied with user ID labels.

Don't buy junk.

DISK WORLD!™ has always been the price and quality leader in diskettes.

Our SuperStar™ diskettes are fully certified to at least 65% clipping levels, far in excess of the ANSI and IBM™ standard of 40%.

Furthermore, SuperStar™ diskettes have jackets of at least 8-mils, as opposed to the 6-mil jackets offered by other low-priced brands. (And, believe us, jacket thickness makes a big difference in whether or not you will get read/write errors on your machine.)

SuperStar™ 3.50" diskettes are all licensed by Sony™ Corporation, the inventor of the 3.50" diskette standard, and meet their exacting standards.

All SuperStar™ diskettes carry a FULL LIFETIME WARRANTY against manufacturing and material defects.

Finally, all SuperStar™ diskettes are manufactured in the United States...not in Hong Kong, Taiwan, Pago Pago or other strange and exotic places where the standards of quality might not be quite as high.

In short, SuperStar™ diskettes are equal or superior to such famous brand names as 3M™, TDK™, Fuji™, Maxell™ and just about any other brand you can name!

SuperStar™ diskettes simply cost half as much or less.

The truth about diskette prices, brand names and some other unpleasant facts of life.

There are exactly two kinds of diskettes: good and bad.

The brand name...or absence of a brand name...on a diskette doesn't mean a thing in terms of quality.

Neither does the price.

For example, let's take a hard look at 3M™ diskettes, a brand which we have carried for more than three years.

During that time, we sold more than \$ 6,500,000 worth of these diskettes...and that's one hell of a lot of diskettes.

Until very recently, we were proud to market 3M™ brand diskettes. Now we don't advertise them and actively

discourage people from buying them.

Why?

Well, here's a quote from the July 21, 1986 BusinessWeek magazine (page 107): "The disks have been plagued by quality problems recently..." according to one industry expert.

And a radical change in 3M's pricing policies has resulted in exactly the same diskette being sold at prices ranging from 29 to 89 cents, depending on who you were.

Not exactly a fair deal for anyone...except 3M™ which, according to BusinessWeek earned a mere \$ 73,000,000 in profits on magnetic media in 1985...mostly at your expense and ours while (t)he diskettes have been plagued by quality problems recently...

Counterfeiting and The Hong Kong Connection.

If the life of a diskette purchaser weren't bad enough already, there are now two more problems to contend with.

Counterfeiting is the newest game in town for the "let's get rich quick" crowd.

At least two mail order companies are currently operating very comfortable businesses offering "famous brand name" diskettes at unbeatable prices.

The prices ought to be unbeatable, since these two companies simply take an inferior diskette and slip into a Tyvec™ sleeve which they have printed to be an exact duplicate of the "famous brand name", slap on a forged manufacturer's label to the diskette and make a very tidy profit...without regard to the harm they are causing the end user.

Finally, there is now a wave of cheap, poorly made diskettes pouring in from the Orient, mostly Hong Kong. We are not talking about reputable brands such as Sony™ or Fuji™; we are talking about diskettes which are being turned out in sweatshops on outmoded equipment with little or no regard for quality control.

They show up in this country under a variety of names at extremely attractive prices. Prices so attractive, in fact, that your savings on buying these diskettes may just about pay for the cost of replacing your drives after you use them for a while.

90,000 DISK WORLD!™ customers really tell the story.

DISK WORLD!™ serves more than 90,000 customers throughout the United States and now the world. More and more major corporations, universities and governmental bodies have switched over to our SuperStar™ brands because they recognize that SuperStar™...with DISK WORLD!'s integrity standing behind it...offer absolutely the best combination of HIGH-QUALITY and LOW PRICE.

In short, DISK WORLD!™ and SuperStar™ are unbeatable.

Over the past three years, we've sold more than 30,000,000 diskettes.

Our return rate has been less than 1/10,000th of 1%.

Those two facts speak for themselves.

When every bit counts, it's SuperStar!™

We don't have to boast of imaginary factories employing "floppy phreaks", advertise diskettes for 39¢...if you buy 10,000 of them, offer "2 for 1" replacement guarantees or engage in any of the other hokum schemes designed to part you from your money.

Nor do we have to offer you "famous brand name" diskettes at inflated prices that don't offer you any more in quality, but do manage to support fleets of corporate jet aircraft and executive retreats in Minnesota and Canada.

We simply deliver the best for less.

More than a million diskettes a month flow out of our warehouse under the SuperStar™ "non-name". As noted, fewer than 1/10,000th of 1% of these are returned for any reason.

And that should say it all: SuperStar™ means far more for far less.

HOW TO ORDER: ORDERS ONLY:

1-800-621-6827

(In Illinois: 1-312-256-7140)

INQUIRIES:

1-312-256-7140

FOR FASTEST SERVICE, USE NO -COST MCI MAIL. Our address is DISKORDER. It's a FREE, MCI MAIL letter. No charge to you. (Situation permitting, we'll ship these orders in 24 hours or less.)

SHIPPING: 5.25" & 3.50" DISKETTES-Add \$ 3.00 per each 100 or fewer diskettes. OTHER ITEMS: Add shipping charges as shown in addition to other shipping charges.

PAYMENT: VISA, MASTERCARD and Prepaid orders accepted. COD ORDERS: Add \$ 5.00 special handling charge. APO, FPO, AK, HI & PR ORDERS: Include shipping charges as shown and additional 5% of total order amount to cover PAL and insurance. We ship only to United States addresses, except as shown above. TAXES: Illinois residents add 7% sales tax.

DISK WORLD!, Inc.

629 Green Bay Road
Wilmette, Illinois 60091

IBM® COMPATIBLE COMPUTER ACCESSORIES

NOW YOU CAN BUILD AN IBM PC/XT COMPATIBLE!

Part No.	Description	Price
IBM-64K (2 sets)	64K RAM CHIPS (18).....	\$ 24.98
KB-83	83-KEY KEYBOARD.....	\$ 29.95
IBM-FCC	FLOPPY CONTROLLER CARD.....	\$ 39.95
IBM-Case	FLIP-TOP CASE.....	\$ 39.95
IBM-MCC	MONOCHROME CARD.....	\$ 69.95
IBM-PS	POWER SUPPLY.....	\$ 69.95
FD55B	TEAC 5 1/4" DISK DRIVE.....	\$109.95
IBM-MON	12" MONOCHROME MONITOR.....	\$ 99.95
IBM-MB	MOTHERBOARD (with Zero-K RAM - Includes BIOS-ROM).....	\$129.95

SPECIAL!

Regular List **\$614.58**

IBM-Special (Includes the 9 items listed above)..... **\$549.95**

IBM PC XT Compatible Motherboard

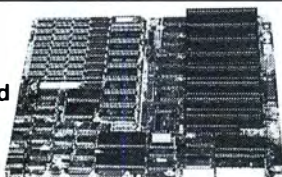

SALE!

• Comes with Zero-K of Memory (expandable to 640K - need 128K RAM for operation) • 8 expansion card slots • 8087 co-processor capability • Handles up to four drives

The whole board comes complete (including BIOS ROM) with system board, specifications and schematics. Ideal for engineer or OEM applications! Size: 12" L x 8 1/2" W x 15/16" H • Wt. 2 lbs.

IBM-MB..... **\$129.95**

IBM PC XT Compatible Case



Expand Your PC!

• Metal housing and chassis with coating & anti-static treatment
 • Plastic face plate

• Flip-up lid for easy access

• Back plate set for expansion including 8 card slots and power supply mount

• Color: grey • All necessary hardware for expansion included

Size: 19 1/2" W x 16 1/2" D x 5 3/4" H • Weight: 17 lbs.

IBM-Case..... **\$39.95**

5 1/4" Disk Drives



FD55B

TM100-2

SA455 Shugart 5 1/4" Half-Ht. **\$109.95**

FD55B Teac 5 1/4" Half-Ht. **\$109.95**

TM100-2 Tandon 5 1/4" Full-Ht. **\$119.95**

IBM PC XT Compatible Direct Replacement Keyboards



• Identical layout as original IBM PC keyboard • Illuminated "Caps Lock" and "Num Lock" keys • 84 keys, mechanical switches (uses Intel 8048) • Complete with schematics and instructions • Color: off-white • Size: 17 1/4" L x 7 1/4" W x 1 1/4" H

IBM-KB..... **\$59.95**

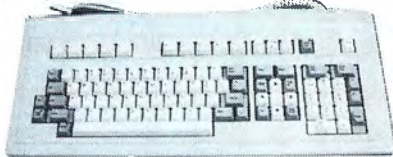

• Enhanced PC/XT keyboard (equivalent to Keytronic's™ 5151) • Separate cursor and numeric keyboard • Type-writer style layout: easier to learn! • LED indicators • Ready-to-go, complete with schematic & instructions • Color: off-white • Size: 20" L x 8 1/2" W x 1 1/2" H

IBM-ENH..... **\$89.95**

IBM PC/XT Equivalent 130W Power Supply



+5VDC @ 15A

-5VDC @ 0.5A

+12VDC @ 4.2A

SALE! -12VDC @ 0.5A

• Input: 100V-130V @ 47Hz • Output: +5VDC @ 15A, -5VDC @ 0.5A, +12VDC @ 4.2A, -12VDC @ 0.5A • Plug compatible connectors • Fits into IBM PC • Built-in fan • Weight: 6 lbs. • Size: 9 1/2" L x 5 1/2" W x 4 1/4" H • Spec. included

IBM-PS..... **\$69.95**

MONITOR

12" Green Monochrome Monitor for IBM PC

FEATURES:

- TTL input • Band width: 20MHz
- Input impedance: 75 Ohm
- Resolution: 800 lines at center
- Power consumption: 30 watts
- Complete with tilt/swivel monitor stand
- Weight: 19 lbs • Size: 14.5" W x 16" D x 16.5" H

IBM-MON..... **\$99.95**



ZUCKERBOARD

MADE IN THE U.S.A.
 Integrated Color Board for IBM PC, XT, AT and Portable Computers

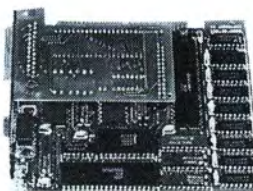

• Fully compatible with all IBM color software and RGB monitors • Fits the difficult-to-use half card short slot or any long slot • Requires 1/3 the power of conventional color boards • Quality backed by two year warranty

IBM-ICB..... **\$99.95**

CABLES, BEZELS AND SPEAKERS

IBM-BEZEL	Half-Height Bezel (Fills empty space when mounting half-height drives).....	\$4.95
IBM-KEC	Keyboard Extension Cable for IBM PC & XT Computers - 5' length.....	\$5.95
NEW! IBM-SPEAKER	Speaker Assembly Kit (Includes speaker, wire and 4-pin Molex connector).....	\$9.95
MMS-2206	Serial Modem/Printer Cable - 6' length - DB25P (Male) to DB25P (Male).....	\$6.95
MFS-2206	Serial Modem/Printer Cable - 6' length - DB25P (Male) to DB25S (Female).....	\$7.49
IBM-8PC	Parallel Printer Cable - 8' length - DB25P (Male) to CEN36M Centronics (Male).....	\$9.95



Monitor Adapter Power Cable

Enables user to plug any monitor into your IBM Power Supply (IBM-PS - See above)

MCable..... \$9.95

Worldwide • Since 1974

• QUALITY COMPONENTS • COMPETITIVE PRICING • PROMPT DELIVERY

Mail Order Electronics - Worldwide
Jameco
ELECTRONICS

COMMODORE COMPATIBLE ACCESSORIES



Now Compatible With C-128!
RS232 Adapter
for VIC-20, C-64 and C-128

The JE232CM allows connection of standard serial RS232 printers, modems, etc. to your VIC-20, C-64 (excluding the SX-64 Portable), and C-128. A 4-pole switch allows the inversion of the 4 control lines. Complete installation and operation instructions included.

• Plugs into User Port • Provides Standard RS232 signal levels
• Uses 6 signals (Transmit, Receive, Clear to Send, Request to Send, Data Terminal Ready, Data Set Ready).

JE232CM. \$39.95

Voice Synthesizer VIC-20 & C-64
Plug-In - Talking in Minutes!

JE520CM. \$99.95

External Power Supply
CPS-10 (For C-64). \$39.95

Parallel Printer Interface
2K Buffer, Expandable to 10K!
MW350 (For VIC-20, C-64 & C-128). \$54.95

TRS-80 COMPATIBLE ACCESSORIES

E-X-P-A-N-D TRS-80 MEMORY
All kits come complete with documentation

TRS-80 MODEL I, III

TRS-16K3 200ns (Model III). \$5.95

TRS-16K4 250ns (Model I). \$5.49

TRS-80 COLOR AND COLOR II

TRS-64K-2. \$11.95

New models only -
TRS-CoCo-Incl. 2-50464's (41464's). \$12.49

TRS-80 MODEL 4, 4P

TRS-64K-2. \$11.95

Expands Model 4 from 16K-64K or Model 4P from 64K-128K

TRS-64K-2PAL. \$29.95

Expands Model 4 from 64K to 128K

TRS-80 Model 100 • NEC • Olivetti

M1008K. \$24.95 ea. or 3 for \$59.95

TRS-80 Model 100 Expansion

NEC8KR. \$24.95 ea. or 3 for \$59.95

NEC Model PC-8201A Expansion

OM108K. \$24.95 ea. or 3 for \$59.95

Olivetti Model M10 Expansion

TANDY 200

M200R. \$74.95 ea. or 2 for \$129.95

Tandy Model 200 Expansion

UV-EPROM ERASER



Erases all EPROMs. Erases up to 8 chips within 21 minutes (1 chip in 15 minutes). Maintains constant exposure distance of 1". Special conductive foam liner eliminates static build-up. Built-in safety lock to prevent UV exposure. Compact - 9.00" L x 3.70" W x 2.60" H. Complete with holding tray for 8 chips.

DE-4 UV-EPROM Eraser. \$74.95

UVS-11EL Replacement Bulb. \$17.95

DATA BOOKS

30003 National Linear Data Book (82). \$14.95

30009 Intersil Data Book (85). \$ 9.95

30013 Zilog Data Book (85). \$14.95

30032 National Linear Supplement (84). \$ 6.95

210830 Intel Memory Handbook (86). \$17.95

230843 Intel Microsystem Hndbk. Set (86). \$24.95

MUFFIN/SPRITE-STYLE FANS



MUFF60 (SPN3-15-2462) \$9.95

Howard Industries (4.68" sq., 60 cfm)

SU2C7. \$9.95

EG&G Rotron (3.125" square, 20 cfm)

NEW PRODUCTS!

DISK DRIVE SALE!

MPI52S Double-sided 48TPI. . . **IBM PC/XT Compatible! . . . \$69.95**

TM100-4 Double-sided 96TPI. . . **QUAD Drive! \$59.95**

ZUCKERBOARD

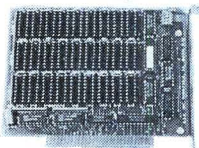

Expansion Memory Half-Card for IBM-PC, XT, Portable, Tandy 1200 and Compatible Computers

Expand your computer to its full capacity of 640K. It will accept either 64K memory chips (4164) or 256K memory chips (41256).

EM-100 Expansion Memory Half Card with 0K RAM . . . **\$59.95**

EM-D RAM Disk and Printer Spooler Software. . . . **\$39.95**

ZUCKERBOARD

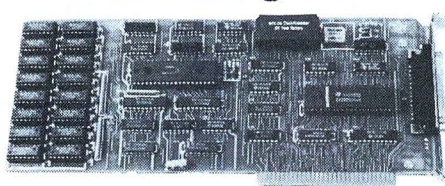

Multifunction Board with Clock Calendar for the Tandy 1000

The Zuckierboard Multifunction Board allows you to expand the memory on your Tandy 1000 to as much as 640K. The Multifunction Board comes complete with an RS232 port for your serial expansion needs, a clock/calendar and RAM Disk Printer Spooler. The Zuckierboard Multifunction Board is made in the U.S.A. and comes with a standard 2 year warranty.

MTAN-256K Includes 256K RAM and Manual. **\$199.95**

MTAN-512K Includes 512K RAM and Manual. **\$239.95**

Expansion Memory Half-Card and Clock/Calendar for the Tandy 1000 - DMA Controller Chip on board!

TAN-EM256K Includes 256K RAM and Manual. **\$ 99.95**

TAN-EM512K Includes 512K RAM and Manual. **\$139.95**

Options for TAN-EM256K/512K

TAN-C Includes Plug-in Clock Option Chip (only). **\$39.95**

TAN-D Includes RAM Disk Spooler Software (only). **\$39.95**



3.5" Micro Floppy Disk Drive for Tandy 100 & 200, NEC8201A, IBM PC, XT, AT and Compatible Computers

Now your IBM PC or compatible can read and write the same disks as your portable!

FD-103 Includes 3.5" Disk Drive, Cable, AC Adapter, Blank Diskette and Documentation. . . . **\$179.95**

Software for the FD-103 Disk Drive (Software needed for operation)

TS1 Tandy 100 TSDOS Disk Operating System Software. **\$49.95**

TS2 Tandy 200 TSDOS Disk Operating System Software. **\$49.95**

TSN NEC PC8201A Disk Operating System Software. **\$49.95**

LAPDOS IBM PC, XT, AT and Compatible LAPDOS Disk Operating System Software. **\$79.95**

COMMODORE CHIPS

For VIC-20, C-64 and C-128 Personal Computers

Part No.	Price	Part No.	Price	Part No.	Price
6502 MPU w/Clock	2.75	6529SPI	7.95	6581SID	19.95
6507 8-Bit CPU	6.95	6551ACIA	3.95	*82S100PLA	19.95
6508 w/RAM & I/O	14.95	6580VIC-I	14.95	8701 Clock Chip	9.95
6510CPUJ	9.95	6567VIC-II	19.95	*8721PLA	14.95
6525TPI	9.95	6569VIV	19.95		
6526CIA	14.95	6572	19.95		

NOTE: 82S100 = U17 (C-64)
*No Spec Available

NEC V20 & V30 CHIPS

Replace the 8086 or 8088 in Your IBM-PC and Increase Its Speed by up to 40%!

Part No.	Price
UPD70108D-5 (5MHz) V20 Chip (Replaces the 8088)	\$ 8.95
UPD70108D-8 (8MHz) V20 Chip (Replaces the 8088-2)	\$10.95
UPD70116D-8 (8MHz) V30 Chip (Replaces the 8086 or 8086-2)	\$11.95

IBM COMPATIBLE ACCESSORIES

83-KEY KEYBOARD

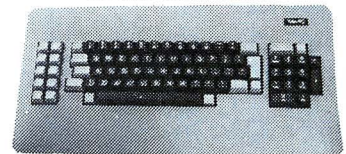

• Identical layout as original IBM PC Keyboard • Highly desirable case with palm rest • Complete with cable and data • **JUST PLUG IN!**

KB83. SALE \$29.95

Build an IBM PC/XT™ Compatible!

IBM-64K(2) 64K RAM Chips (18). **\$ 24.98**

KB-83 83-Key Keyboard. **\$ 29.95**

IBM-FCC Floppy Controller Card. **\$ 39.95**

IBM-Case Case. **\$ 39.95**

IBM-MCC Monochrome Card. **\$ 69.95**

IBM-PS Power Supply. **\$ 69.95**

FD55B Disk Drive. **\$109.95**

IBM-MON Monochrome Monitor. **\$ 99.95**

IBM-MB Motherboard. **\$129.95**

Regular List \$614.58

IBM™-Special (Incl. 9 items above) . . . \$549.95

Additional Add-Ons Available!

IBM-KB 83-Key Keyboard. **\$ 59.95**

IBM-ENH Enhanced Keyboard. **\$ 89.95**

IBM-ICB Integrated Color Board **\$ 99.95**

IBM-EGA Enhd. Graphics 256K RAM . . . **\$259.95**

IBM-20MBK 20MB Hard Disk Drive. . . . **\$479.95**

IBM is a registered trademark of IBM Computers

NEW! Universal 64K/256K NEW! Printer Buffer

JOHNATHON FREEMAN DESIGNS

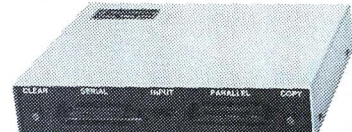

The UBUFFER Universal Printer Buffer is a hi-speed data buffer that accepts data at a high rate, and then outputs this data to your printer. You save valuable computer time. The UBUFFER can be connected to practically any computer or printer. There are four possible combinations: 1) Serial to Serial, 2) Serial to Parallel, 3) Parallel to Parallel, 4) Parallel to Serial. Manual included. Size: 9-1/3" L x 4-1/8" W x 1-1/2" H

UBUFFER-64K . . . \$199.95

UBUFFER-256K . . . \$229.95

IBM COMPATIBLE! DISK DRIVES

Documentation Included

FD55B Teac 5 1/4" DS 1/2-Height. **\$109.95**

SA455 Shugart 5 1/4" DS 1/2-Height. **\$109.95**

TM100-2 Tandon 5 1/4" DS Full-Height. **\$119.95**

JMR 5 1/4" DISK DRIVE ENCLOSURES

Complete with power supply, switch, power cord, fuseholder and connectors.

DDE-1FH Houses 1 Full-Height 5 1/4" Floppy Drive. **\$59.95**

DDE-2HH Houses 2 Half-Height 5 1/4" Floppy Drives - Vertical **\$69.95**

HDDE-1FH Houses 1 Hard Disk Drive **\$199.95**

\$20 Minimum Order - U.S. Funds Only
Shipping: Add 5% plus \$1.50 Insurance

California Residents: Add 6% or 6 1/2% Sales Tax

Spec. Sheets - 50¢ each
Prices Subject to Change

Send stamped, self-addressed envelope to receive a Quarterly Sales Flyer - FREE!

10/86

1355 SHOREWAY ROAD, BELMONT, CA 94002 • PHONE ORDERS WELCOME 415-592-8097 Telex: 176043



Mail Order Electronics - Worldwide
Jameco
ELECTRONICS



Send \$1.00 Postage for a FREE 1987 JAMECO CATALOG

©1986 Jameco Electronics

JADE XPC or XPC-AT

- 640K of RAM
- 4.77 MHz 8088
- 7 MHz turbo mode
- 135 watt power supply
- 360K disk drive
- Floppy disk controller
- 5151-style keyboard
- 8 expansion slots
- PC-style case
- 90 day warranty

\$588



\$1288

OPTION #1

Two disk drives
Mono graphics card
Parallel printer port
Amdak 310A monitor

XPC **\$898**
XPC-AT **\$1698**

OPTION #2

20 MB hard disk
Mono graphics card
Parallel printer port
PGS MAX-12E monitor

XPC **\$1288**
XPC-AT **\$1898**

OPTION #3

20 MB hard disk
Color graphics card
Parallel printer port
Hitachi hi-res color monitor

XPC **\$1388**
XPC-AT **\$1998**

HARD DISK DRIVE

\$349

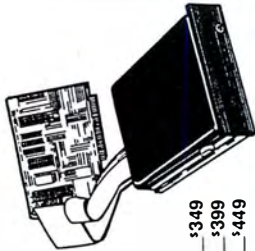

10 MB Kit **\$349**
20 MB Kit **\$399**
20 MB hard disk card **\$449**

20 MB HI-SPEED HARD DISK FOR YOUR AT **\$399**

Limited quantity.

30 MB Hi-speed **\$695**
40 MB Hi-speed **\$895**
70 MB Hi-speed **\$1695**
120 MB Hi-speed **\$3395**

QUME DISK DRIVE

- Double sided
- Double density
- 360K for PC

\$69

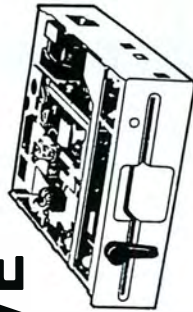

Teac FD55 BV **\$109**
Tandon TM100-2 **\$109**
1.2 MB for AT **\$149**

HIGH RESOLUTION COLOR MONITOR

\$269

List Price \$699

Free PC RGB cable included

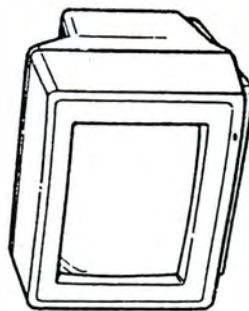

- IBM PC color graphics compatible
- High resolution 640 x 240
- Excellent dot pitch .38 mm
- 16 true colors, 2000 characters
- Accepts standard RGB input signals
- Non-glare picture tube
- New designer sculpted case

Manufactured by Hitachi



HITACHI

MICROSPEED FAST 88 7 MHz TURBO CARD FOR PC

\$99

- Uses no slots
- 6.14, 6.67, 7.37 MHz
- No wait states
- External switch
- Reset switch

DELUXE BACK CHAIR

\$49

List Price \$99

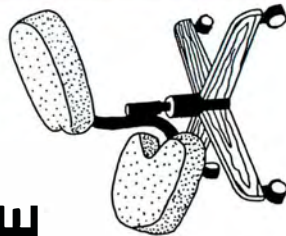

EPSON HOMEWRITER 100 CPS PRINTER

\$189

List Price \$309
Including free interface & cable

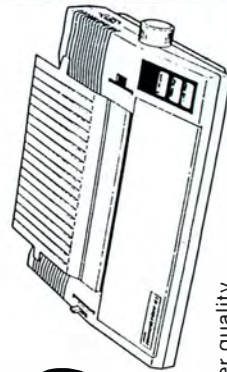

- 16 cps near letter quality
- Graphics
- Bidirectional printing
- SelectType
- Tractor feed
- Optional cut sheet feeder
- 32K buffer

EPSON

Monochrome Monitors

Jade green _____ \$99
 Jade amber _____ \$99
 Amdak 310A amber _____ \$149
 Quimac 14" green T/S _____ \$139
 Quimac 14" amber T/S _____ \$139
 Thompson green _____ \$99
 Thompson amber _____ \$99
 PGS MAX 12E amber _____ \$159

Kaypro Sale

Limited quantity, 10-day money-back guarantee—Call for details.
 Kaypro 2000 _____ \$995
 Kaypro 10 _____ \$795
 Kaypro 16 _____ \$1195
 Kaypro 2000 accessories _____ 30% off

PC Power Supply

135 watt power supply _____ \$69
 150 watt power supply _____ \$79

PC or AT Video Boards

Hercules Color Graphics _____ \$159
 Jade Color Graphics _____ \$89
 Hercules Mono Graphics Plus _____ \$199
 JADE Monochrome Graphics _____ \$99
 Quad EGA+ _____ \$359
 Tecmar Graphics Master _____ \$439
 JADE EGA+ _____ \$239

High Speed APU Chips

8087-3.5 MHz _____ \$119
 8087-2.8 MHz _____ \$159
 80287-3.5 MHz _____ \$179
 80287-8.8 MHz _____ \$269
 NEC V-20.5 MHz _____ \$11
 NEC V-20.8 MHz _____ \$14
 NEC V-30.8 MHz _____ \$16

RGB Color Monitors

Hitachi 640 x 262 _____ \$269
 Magnavox 640 x 240 _____ \$319
 Quimac EGA 640 x 350 _____ \$489
 NEC Multisync 800 x 560 _____ CALL
 PGS HX-12 640 x 240 _____ \$439
 PGS HX-12E 640 x 350 _____ \$529

NO-SLOT \$49 CLOCK

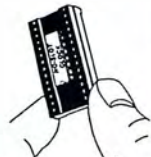

Real time clock/calendar for your PC-XT or clone

POWER/SURGE PROTECTION

6 socket, UL listed, U.S. made Power/surge strip



\$1295

List Price \$49

6 button, under-monitor, swivel Power/surge control center



\$7995

List Price \$129

ISO-Bar

These industrial quality ISO-BAR's contain surge suppression circuitry & built-in noise filters plus a 15 amp circuit breaker.

6 socket, 1 filter ISO-BAR _____ \$44
 4 socket, 2 filter ISO-BAR _____ \$59
 8 socket, 4 filter ISO-BAR _____ \$69
 200W standby power supply _____ \$269
 425W standby power supply _____ \$399
 675W standby power supply _____ \$599
 1000W standby power supply _____ \$899

Apple Accessories

11c 1/2 high disk drive _____ \$119
 11e 1/2 high disk drive _____ \$99
 11e, 11+ disk drive _____ \$129
 11e 64K, 80 column card _____ \$49
 11+ 80 column card _____ \$119
 Grappler printer card _____ \$89
 11+ 16K RAM card _____ \$39
 11+, 11e printer card & cable _____ \$49
 11+, 11e cooling fan _____ \$59

Plotters

Roland DXY-800 8 pen _____ \$399
 HP 7470 2 pen _____ \$899
 HP 7475 6 pen _____ \$1699
 HP 7550A 8 pen _____ \$3399
 HP Color Pro 8 pen _____ \$1699
 Houston Inst. PC 695 _____ \$599
 Houston Inst. DMP 40P _____ \$849
 Houston Inst. DMP 29 _____ \$1699
 Houston Inst. DMP 41/42 _____ \$2495
 Houston Inst. DMP 51/52 _____ \$3795
 Houston Inst. DMP 56 _____ \$4495

PC Multifunction Cards

384K Jade Seven Pak w/OK, p. s. c. g. software _____ \$89
 384K Jade Seven Pak with 384K installed _____ \$139
 AST Six Pak Plus 64K _____ \$159
 AST Six Pak Plus 384K _____ \$229
 AST Six Pak Premium 512K _____ \$389
 AST Rampage 256K _____ \$239
 AST Rampage 2 MB _____ \$699
 Tail Tree JRAM-3 0K _____ \$189
 Tail Tree JRAM-3 2 MB _____ \$599
 Intel Above Board 64K _____ \$279
 Intel Above Board 2 MB _____ \$599
 Quad Board w/OK _____ \$119
 Quad Board 384K _____ \$169

AT Multifunction Cards

1.5 MB Jade-AT Pak w/OK, p. s. optional g. s _____ \$199
 1.5 MB Jade-AT Pak w/1.5 MB RAM installed _____ \$399
 AST Advantage-AT 128K _____ \$349
 AST Advantage-AT 3 MB _____ \$989
 AST Rampage-AT 512K _____ \$489
 AST Rampage-AT 2 MB _____ \$749
 Tail Tree JRAM-AT OK _____ \$169
 Tail Tree JRAM-AT 2 MB _____ \$599
 Tail Tree JRAM 3-AT OK _____ \$299
 Tail Tree JRAM 3-AT 2 MB _____ \$699
 Intel Above Board 128K _____ \$399
 Intel Above Board 4 MB _____ \$1299

Printers On Sale!

Citizen 120D 120 cps _____ \$198
 Okidata 192 160 cps _____ \$339
 Epson LX-86 120 cps _____ \$100 off
 Epson FX-85 160 cps _____ \$150 off
 Epson FX-286 160 cps _____ \$300 off
 Epson LO-800 24 pin _____ \$230 off
 Epson LQ-1000 24 pin _____ \$300 off
 Epson EX-800 300 cps _____ \$200 off
 Epson EX-1000 300 cps _____ \$200 off
 Epson LQ-2500 324 cps _____ \$400 off
 14 cps daisywheel _____ \$179
 22 cps daisywheel _____ \$199
 40 cps daisywheel _____ \$429

64K BUFFER FOR YOUR EPSON

Serial or parallel input. Fits MX, RX, FX printers Limited Quantity **\$99**

Microfazer Buffers

Expands to 64K (Parallel to 512K)
 8K Parallel in/parallel out _____ \$139
 64K Parallel in/parallel out _____ \$164
 128K Parallel in/parallel out _____ \$269
 512K Parallel in/parallel out _____ \$499
 Your choice: serial in/serial out; parallel in/serial out; serial in/parallel out. 8K _____ \$169 64K _____ \$199



PLACE ORDERS TOLL FREE!
 Continental U.S.A.
(800)421-5500
 Inside California
(800)262-1710

Prices at our six store locations will be higher.
 We accept cash, checks, credit cards or purchase orders from qualified firms and institutions. Minimum prepaid order \$15.00. California residents add 6 1/2% tax. Prices & availability subject to change without notice. Shipping & handling charges via UPS Ground 50c/lb. UPS Air \$1.00/lb. Minimum charge \$3.00.

JADE COMPUTER



4901 W. Rosecrans Ave. Box 5046 Hawthorne, CA 90251-5046

THE LATEST IN PC ENHANCEMENT PRODUCTS

ENHANCED GRAPHICS ADAPTOR

100% IBM COMPATIBLE—PASSES IBM EGA DIAGNOSTICS

- * COMPATIBLE WITH IBM EGA, COLOR GRAPHICS ADAPTOR AND MONOCHROME ADAPTOR
- * DISPLAYS 16 COLORS OUT OF 64 COLORS
- * COMES WITH 256K OF VIDEO RAM
- * DUAL SCANNING FREQUENCIES WORKS WITH STANDARD OR EGA TYPE RGB MONITORS
- * LIGHT PEN INTERFACE

NOW ONLY
\$259.95

EGA MONITOR

FULL ONE YEAR WARRANTY

- * EGA AND CGA COMPATIBLE
- * SCANNING FREQUENCIES:
15.75 KHz / 21.85 KHz
- * 14" BLACK MATRIX,
NON-GLARE SCREEN
- * RESOLUTION:
640 x 200 / 640 x 350
- * .31 DOT, 25MHz
- * 16 COLORS OUT OF 64
- * TEXT SWITCH-GREEN/AMBER

\$499.95



20 MB HARD DISK SYSTEM

INCLUDES HARD DISK CONTROLLER, CABLES AND INSTRUCTIONS. ALL DRIVES ARE PRE-TESTED AND COME WITH A 1 YEAR WARRANTY.

\$389.95

AT MULTIFUNCTION CARD \$199.95

ADDS UP TO 3 MEGABYTES OF USER EXPANDABLE MEMORY

- * SHIPPED WITH ZERO K RAM, USER EXPANDABLE TO 1.5 MEGABYTES RAM ON BOARD, UP TO 3 MEGABYTES WITH OPTIONAL PIGGYBACK CARD
- * USES 64K OR 256K DYNAMIC RAMS
- * PARALLEL PORT & GAME PORT
- * SERIAL PORT
- * OPTIONAL SECOND SERIAL PORT

PIGGYBACK MEMORY CARD (NO MEMORY INSTALLED) \$49.95



EXPANDED MEMORY CARD \$199.95

UP TO 2 MEGABYTES OF LOTUS/INTEL COMPATIBLE MEMORY

- * CONFORMS TO LOTUS/INTEL EXPANDED MEMORY SPECIFICATIONS (EMS)
- * SHIPPED WITH ZERO K RAM, USER EXPANDABLE TO 2 MEGABYTES
- * USES 64K OR 256K DYNAMIC RAMS
- * USE AS EXPANDED (EMS) OR CONVENTIONAL MEMORY, RAMDISK OR SPOOLER
- * SOFTWARE INCLUDES EMS DEVICE DRIVERS, PRINT SPOOLER AND RAMDISK

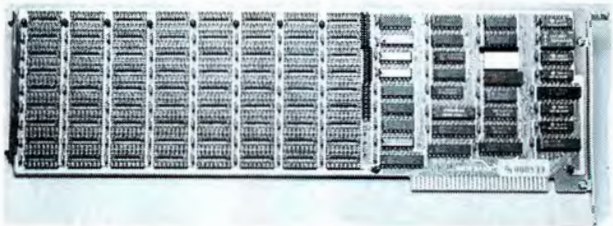

EPROM PROGRAMMER \$129.95

FOR IBM PC/XT/AT AND COMPATIBLES

- * PROGRAMS 27xxx SERIES EPROMS UP TO 27512
- * MENU DRIVEN SOFTWARE PROVIDED ON DISKETTE
- * AUTOMATICALLY SETS PROGRAMMING VOLTAGE
- * LOADS AND SAVES EPROM BUFFER TO DISK
- * READ, WRITE, COPY, VERIFY OR CHECK BLANK
- * DEBUG STYLE EDITOR FOR EASY MODIFICATION OF PROGRAM
- * SPLITS OR COMBINES EPROMS OF DIFFERING SIZES
- * INTERNAL CARD WITH EXTERNAL CABLE FOR A ZIF SOCKET

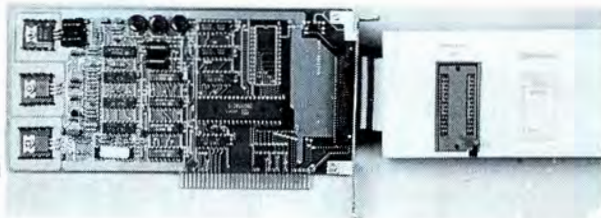

JDR Microdevices 110 Knowles Drive, Los Gatos, CA 95030
Toll Free 800-538-5000 • (408) 866-6200 • FAX (408) 378-8927 • Telex 171-110

© COPYRIGHT 1986 JDR MICRODEVICES

THE JDR MICRODEVICES LOGO IS A REGISTERED TRADEMARK OF JDR MICRODEVICES. JDR INSTRUMENTS AND JDR MICRODEVICES ARE TRADEMARKS OF JDR MICRODEVICES.
IBM IS A TRADEMARK OF INTERNATIONAL BUSINESS MACHINES.

20 MEGABYTE HARD DISK SYSTEM ONLY \$389.95!

SEAGATE ST-225 20 MB HARD DISK SYSTEM

INCLUDES HARD DISK CONTROLLER, CABLES AND INSTRUCTIONS. ALL DRIVES ARE PRE-TESTED AND COME WITH A ONE YEAR WARRANTY.

\$389.95

CRT MONITORS FOR ALL APPLICATIONS



LUXOR
HI-RES RGB MONITOR
MODEL 190-9528

- DIGITAL RGB-IBM COMPATIBLE
- 14" SCREEN
- 16 TRUE COLORS
- 25 MHz BANDWIDTH
- RESOLUTION > 640 x 262
- .31mm DOT PITCH
- CABLE FOR IBM PC INCLUDED

\$299.95



SAKATA
COMPOSITE COLOR
MODEL SC-100

- TOP RATED FOR APPLE
- 13" COMPOSITE VIDEO
- RESOLUTION: 280H x 300V
- INTERNAL AUDIO AMP
- ONE YEAR WARRANTY

\$169.95



CENTER SYSTEMS
MONOCHROME
MODEL KLM-1211

- IBM COMPATIBLE TTL INPUT
- 12" NON-GLARE SCREEN
- P39 GREEN PHOSPHORUS
- VERY HIGH RESOLUTION: 25 MHz BANDWIDTH 1100 LINES (CENTER)

AMBER VERSION \$109.95

\$99.95

XT COMPATIBLE MOTHERBOARD

\$129.95

- 4.77 MHz 8088 CPU, OPTIONAL 8087 CO-PROCESSOR
- 8 EXPANSION SLOTS
- 0K RAM INSTALLED, EXPANDABLE TO 640K ON-BOARD MEMORY
- ALL ICs SOCKETED-HIGHEST QUALITY PC BOARD
- ACCEPTS 2764 OR 27128 ROMS

PRO-BIOS \$19.95



BUILD YOUR OWN 256K XT COMPATIBLE SYSTEM

XT MOTHERBOARD	\$129.95
PRO-BIOS	\$19.95
256K RAM	\$26.55
130 WATT POWER SUPPLY	\$69.95
FLIP-TOP CASE	\$39.95
DKM-2000 KEYBOARD	\$59.95
1/2 HEIGHT QUME DRIVE	\$79.95
FLOPPY DISK CONTROLLER	\$34.95
MONOCHROME ADAPTOR	\$49.95
MONOCHROME MONITOR	\$89.95
TOTAL:	\$611.10

MONITOR STAND



TILTS AND SWIVELS

ONLY \$12.95

IBM COMPATIBLE INTERFACE CARDS

ALL WITH A ONE YEAR WARRANTY

MULTI I/O FLOPPY CARD \$89.95

PERFECT FOR THE 640K MOTHERBOARD



- 2 DRIVE FLOPPY DISK CONTROLLER
- 1 RS232 SERIAL PORT; OPTIONAL 2nd SERIAL PORT
- PARALLEL PRINTER PORT
- GAME PORT
- CLOCK/CALENDAR
- SOFTWARE: CLOCK UTILITIES, RAMDISK, SPOOLER
- OPTIONAL SERIAL PORT \$15.95

MULTIFUNCTION CARD \$84.95

ALL THE FEATURES OF AST'S 6 PACK PLUS AT HALF THE PRICE



- CLOCK/CALENDAR
- 0-384K RAM
- SERIAL PORT
- PARALLEL PORT
- GAME PORT
- SOFTWARE INCLUDED
- PRINTER CABLE \$9.95
- 64K RAM UPGRADE \$11.51

COLOR GRAPHICS ADAPTOR \$69.95

FULLY COMPATIBLE WITH IBM COLOR CARD



- 4 VIDEO INTERFACES: RGB, COMPOSITE COLOR, HI-RES COMPOSITE MONOCHROME, CONNECTOR FOR RF MODULATOR
- COLOR GRAPHICS MODE: 320 x 200
- MONO GRAPHICS MODE: 640 x 200
- LIGHT PEN INTERFACE

MONOCHROME GRAPHICS CARD \$89.95

FULLY COMPATIBLE WITH IBM MONOCHROME ADAPTOR & HERCULES GRAPHICS



- LOTUS COMPATIBLE
- TEXT MODE: 80 x 25
- GRAPHICS MODE: 720 x 348
- PARALLEL PRINTER INTERFACE

MONOCHROME ADAPTOR \$49.95

ANOTHER FANTASTIC VALUE FROM JDR!

- IBM COMPATIBLE TTL OUTPUT
 - 720 x 350 PIXEL DISPLAY
- PLEASE NOTE: THIS CARD WILL NOT RUN LOTUS GRAPHICS AND DOES NOT INCLUDE A PARALLEL PORT

FLOPPY DISK DRIVE ADAPTOR \$34.95



- INTERFACES UP TO 4 STANDARD FDDs TO IBM PC OR COMPATIBLES
- INCLUDES CABLE FOR TWO INTERNAL DRIVES
- STANDARD DB37 FOR EXTERNAL DRIVES
- RUNS QUAD DENSITY DRIVES WHEN USED WITH JFORMAT

IBM STYLE COMPUTER CASE

AN ATTRACTIVE STEEL CASE WITH A HINGED LID FITS THE POPULAR PC/XT COMPATIBLE MOTHERBOARDS

- SWITCH CUT-OUT ON SIDE FOR PC/XT STYLE POWER SUPPLY
- CUT-OUT FOR 8 EXPANSION SLOTS
- ALL HARDWARE INCLUDED

\$39.95



IBM COMPATIBLE KEYBOARDS

DKM-2000 \$59.95

IBM-5151 \$79.95



- "5150" STYLE KEYBOARD
- FULLY IBM COMPATIBLE
- LED STATUS INDICATORS FOR CAPS & NUMBER LOCK
- 83 KEY - SAME LAYOUT AS IBM PC/XT KEYBOARD



- REPLACEMENT FOR KEYTRONICS KB-5151™
- SEPARATE CURSOR & NUMERIC KEYPAD
- CAPS LOCK & NUMBER LOCK INDICATORS
- IMPROVED KEYBOARD LAYOUT

POWER SUPPLY



NOW ONLY \$69.95

- FOR IBM PC-XT COMPATIBLE
- 135 WATTS
- +5V @ 15A, +12V @ 4.2A
- -5V @ .5A, -12V @ .5A

150 WATT MODEL \$79.95

DISK DRIVES

TANDON TM50-2 \$79.95

- 1/2 HT DS/DD
- IBM COMPATIBLE
- EXTREMELY QUIET!

TEAC FD-55B	DS/DD	\$109.95
TEAC FD-55F	DS/QUAD	\$124.95
TEAC FD-55H	DS/HD	\$154.95
QUME QT-142	DS/DD	\$79.95
MOUNTING HARDWARE		\$2.95
AT/RAILS		\$4.95

1200 BAUD MODEMS

HAYES COMPATIBLE, AUTO-DIAL, AUTO-ANSWER, AUTO RE-DIAL ON BUSY, POWER-UP SELF TEST, FULL ONE YEAR WARRANTY

MODEL 1200B*

- INTERNAL DESIGN
- 10 INCH CARD
- SERIAL PORT INCLUDED

\$169.95

MODEL 1200H*

- INTERNAL DESIGN
- HALF LENGTH (5") CARD
- INCLUDES SPEAKER

\$149.95

SMARTTEAM

- EXTERNAL DESIGN
- WITH POWER SUPPLY
- LED STATUS INDICATORS

\$169.95

*FOR IBM, INCLUDES PC TALK III COMMUNICATIONS SOFTWARE

JDR Microdevices

110 Knowles Drive, Los Gatos, CA 95030
Toll Free 800-538-5000 • (408) 866-6200 • FAX (408) 378-8927 • Telex 171-110

BYTE'S ONGOING MONITOR BOX

ARTICLE#	PAGE	ARTICLE	AUTHOR(S)	ARTICLE#	PAGE	ARTICLE	AUTHOR(S)
1	11	What's New	staff	10	181	Performance Programming . . .	Rosenblum, Jacobs
2	23	Book Reviews	Unger, Crabb	11	197	RAM-Loaded Character Sets for the IBM PC	Wilton
3	43	THE IBM RT Personal Computer	Simpson	12	209	Speeding Up the PC AT	Roemmele
4	83	The IBM PC Convertible	Vose	13	217	Using Assembly Routines in MS-FORTRAN Programs	Dahmke
5	89	Intel's 80386 Architecture	Wells	14	232	Memory Manipulations	Miller
6	110	Virtual Memory, Virtual Machines	Shiell	15	249	Writing Assembly Language Interrupt Routines	Claff
7	123	A Protected-Mode Program for the PC AT	Nelson	16	267	C Versus Assembly—C Plus Assembly	Hogan
8	140	IBM PC Accelerators	Fried	17	288	Best of BIX	BIXen
9	168	Lotus/Intel/Microsoft Expanded Memory	Duncan				

BOMB Card Explanation

MAKE YOUR VOTE COUNT

Just as with your regular issues of BYTE, the editors would like to survey how effectively each article in our 1986 BYTE IBM PC special issue serves our readers. Please fill out the card following the Reader Service index, mail it in, and look for the tabulation of your votes in a future issue of BYTE.

First-place winner based on the number of respondents who read it will receive a bonus of \$100, and the second-place author will receive \$50. The first-place winner for quality will receive an award of \$50. Articles written by anyone under the aegis of BYTE automatically forfeits the bonus to the article placing next.

BYTE CONNECTION INC. (714) 778-6496

BOTTOM LINE PRICE BUSTERS! - "Who you gonna call?"

PERSONAL COMPUTERS		SOFTWARE	
IBM ★ I, (IBM AT Comp.), 640 K, 2 Drives, Mono Card, Monitor, K.B.	\$ 825	Accounting Package	\$ 495
IBM ★ II, (IBM AT Comp.), all of the above with 20 MB H.D	\$1295	AUTOCAD 2.5	\$2050
IBM ★ IV, (IBM AT Comp.), with 8 MHZ, 640 K, 1.2 MB Floppy, 20 MB HD, Graphics Card, Monitor & Keyboard	\$2275	T & W VERSACAD	\$2099
IBM PC XT, w/640K, IBM 360 Floppy, IBM 20 MB HD, K.B., Graphics Card, Monitor	\$2499	CADVANCE	\$1950
IBM PC AT #339, 512K, 1.2 Floppy, IBM 30MB HD	\$4385	ARMOR SYSTEM'S Excalbur & Plus Series	CALL
IBM PC AT, with 512K, Keyboard, 20 MB HD	\$3150	COMPUTER ASSOCIATE (IUS) A/R, A/P, G/L	EACH \$ 330
IBM ProprinterXL	\$ 599	UNIVAIR'S Dental Management & Medical Management-9000	CALL
IBM EGA, with 256K Memory	\$ 699	CYMA Medical, Chiropractic, Orthodontic, Dental Package	\$1825
IBM EG Monitor	\$ 895	Physician Micro Systems Package	\$1850
COMPAQ PORTABLE II with 512K, 80286 Processor, Two 360 Floppies	\$2795	Hotel Information Systems Package	\$2450
COMPAQ DESK PRO, with 640K, Two 360 Floppies, Graphics Card & Monitor	\$1895	MICROCRAFT, BALCONE, UNIVAIR	CALL
COMPAQ DESK PRO & PORTABLE 286, with 640K, 1.2 Floppy, 20 MB HD, Monitor	\$3895 For 86 MB, instead of 20 MB, add	IBM Doctor Officer ManagerII	\$2950
AT & T 8300 PC, with 256K, K.B., Two 360 Floppies, AT & T Graphics Card & Monitor	\$1795		
AT & T 8300 Plus, with 512 K, 1.2 Floppy, K.B., Graphics Card & Monitor	\$3495	PRINTERS	
SPERRY PC-IT, with 640K, 1.2 MB Floppy, 40 MB HD, K.B.	\$2999	BLAZER LASER PRINTER	\$1995
PLOTTERS & DIGITIZERS		CITOH LQ24	\$ 899
CALCOMP 1043	\$7359	D10-40	\$ 750
IO LINE 3700	\$3895	CITOH 8510 SP	\$ 399
HI DMP 56	\$4596	C-10	\$ 475
DMP 51/52	\$1659	CITIZEN MSP 15	\$ 415
HP 7475	\$1859	MSP 25	\$ 525
HP 7580	\$8415	CITIZEN PREMIER 35	\$ 515
NICOLET ZETA 824	\$8995	CANON LASER PRINTER	\$2050
ZETA 838CS	\$13,295	DIABLO 835	\$1250
GTCO 3648L	\$3095	DIABLO LASER/COPIER 4045	\$4259
1117A	\$1195	EPSON FX85	\$ 389
KURTA 12 x 12	\$ 595	EPSON 286	\$ 550
12 x 17	\$ 695	HEWLETT-PACKARD LASER JET	\$2250
SUMMAGRAPHS 11 x 11	\$ 495	HP Plus	\$2995
18 x 12	\$ 750	HEWLETT-PACKARD 500 Plus	\$4150
HITACHI 36 x 48	\$4195	NEC P560	\$ 850
TIGER 11 x 11	\$ 875	P760	\$ 850
15 x 15	\$1295	FUJITSU MAX 24	\$1175
GRAPHIC CONTROLLERS & MONITORS		MAX 24 COLOR	\$1275
HITACHI HM 3719 & BNW 15	\$3290	FUJITSU DL 2400	\$ 959
HITACHI 1455 S & STB EGA	\$ 925	DM 2400	\$ 859
MICROVITEC 905CNQ & GRAPHPORT D	\$2795	2200	\$ 499
Taxan 840 & Color 400L	\$1030	OKIDATA 192	\$ 379
Persyst BOB 16 & NEC 1401	\$1099	293	\$ 599
Galaxy 800 & Mitsubishi 6469	\$2995	OKIDATA 293	\$ 639
Verticom CD-1 & M-16E	\$1950	TOSHIBA P321	\$ 550
BNW 121 Adapter	\$1950	TOSHIBA P351	\$1095
Artist+	\$2099		
Conographics 400 & Mitsubishi 3479 LP	\$2295	HARD DRIVES & BACK UP SYSTEMS	
Mitsubishi 1341 & Sigma 400	\$1050	SEAGATE 20 MB	\$ 450
		SEAGATE 4038	\$ 695
		SEAGATE 4051	\$ 850
		HARD CARD 20 MB	\$ 599
		MAXTOR/MICROPOLIS 85MB	\$1550
		MAXTOR 105/140	\$1850/\$2195
		TEAC 20 MB Tape B/U	\$ 595
		ARCHIVE 60 MB Tape B/U	\$ 850

CALL FOR WHAT IS NOT LISTED, WE GUARANTEE THAT YOUR CALL WILL NOT BE A WASTE. LEASING AVAILABLE.

No charges for testing and configuring equipment. Prices and availability subject to change without notice.

(714) 778-6496

167 West Cerritos Ave., Anaheim, CA 92805 Open 9 - 6 PST

R·E·A·D·E·R S·E·R·V·I·C·E

Inquiry No.	Page No.	Inquiry No.	Page No.	Inquiry No.	Page No.	Inquiry No.	Page No.
2 ACS IMPORTERS	332	46 BRIDGE SOFTWARE LTD	175	78 CTC SYSTEMS	77	122 HAYES MICROCOMP. PROD	27
3 ADTEK TELECOMM. CORP.	170	47 BROWN BAG SOFTWARE	314	79 CUESTA SYSTEMS	77	123 HERCULES COMP. TECH.	241 247
4 ADVANCED COMP. PROD.		48 BUSINESS TOOLS INC.	237	80 CUSTOM SOFTWARE S	EMS 302	124 HERSEY MICRO CONSULTING	162
5 ADVANCED TECHNOLOGY PROD	326	* BUYER'S MART SECTION	321-325	82 DATADESK INTERNATI	127	125 HEWLETT-PACKARD	77
7 AICON SYSTEMS	136	BYTE CONNECTION	49	83 DECISIONWARE INC.	142	126 HOOLEON COMPANY	105
9 ALDEBARAN LABS INC.	158	BYTE INFO EXCHANGE (BIX)	320	84 DECISIONWARE INC.	142	127 HOOLEON COMPANY	105
10 ALLOY COMPUTER PRODUCTS	199	* BYTE SUBSCRIBER MESSAGE	330	85 DICONIX	279	166 HUNTER SALES	333
11 ALLOY COMPUTER PRODUCTS	199	* BYTE SUBSCRIBER SERVICE	256	86 DIGITAL PRODUCTS	29	167 HUNTER SALES	333
		* C WARE/DESMET C	264	87 DISK WORLD! INC.	335	128 I-BUS SYSTEMS	117
				88 DISPLAY TELECOMMNCNTS	215	129 I-BUS SYSTEMS	117
				89 DISTRIBUTION PLUS	309	130 I-BUS SYSTEMS	119
				90 DIVERSIFIED COMPUTER SYS.	304	131 I-BUS SYSTEMS	119
				319 DMA	242	132 I-BUS SYSTEMS	121
16 AMERICAN DIGITAL DISC.ASC	180	53 CANETICS INC.	326	184 EECO/MAXI-SWITCH	277	133 I-BUS SYSTEMS	121
17 AMERICAN MICRO TECHNOLOGY71		54 CANON U.S.A.	107	185 EECO/MAXI-SWITCH	277	134 IBC	281
18 AMERICAN MICRO TECHNOLOGY71		55 CAPITAL EQUIPM	196	91 ELEXOR INC.	326	135 IBC	281
19 AMERICAN SEMICONDUCTOR	328	* CAPITAL MICRO	144	92 EVEREX SYSTEMS	138, 139	136 IBEX COMP	302
20 ANALYTX INTERNATIONAL INC	250	56 CCRI	295	93 EVEREX SYSTEMS	138, 139	137 IC EXPRESS	326
* ANTHRO CORP	102	57 CENTECH	46	94 FTG DATA SERVICES	48	139 INFORMATION BUILDERS	65
21 APPARAT INC	105	58 CENTRAL POINT SOFTWARE	194	95 FTG DATA SERVICES	48	140 INI COMPUTER PROD.	326
23 APROTEK		59 CHALLENGER COMPUTER INC	328	324 FACIT AB		141 INMAC	228
24 ARIEL CORPORATION		60 CLASSIC TECHNOLOGY	223	96 FIFTH GENERATION SYSTEMS	171	* INTECTRA INC.	330
25 ARRAY TECHNOLOGIES INC.	151	61 CLASSIC TECHNOLOGY	223	97 FIFTH GENERATION SYSTEMS	171	142 INTEL CORPORATION	20, 21
318 ARRAY TECHNOLOGIES INC.	251	62 CLASSIC TECHNOLOGY	225	98 FLAGSTAFF ENGINEERING	CIV	315 INTEL CORPORATION	264, 265
* AST RESEARCH INC.	66, 67	63 CLASSIC TECHNOLOGY	225	99 FLAGSTAFF ENGINEERING	CIV	143 ITT INFORMATION SYSTEMS	73
26 AT&T PHOTO & IMAGING CTR.	149	* COALITION FOR LITERACY	307	6 FORD SOFTWARE	116	144 ITT INFORMATION SYSTEMS	73
27 ATRONICS INT'L. INC.	283	64 COMMAND SOFTWARE SYSTEMS	159	320 FORESIGHT RESOURCES CORP.	95	146 JADE COMP. PROD.	338, 339
28 AVOCET SYSTEMS INC.	227	65 COMPUCLASSICS	193	321 FORESIGHT RESOURCES CORP.	95	147 JAMECO ELECTRONICS	336, 337
29 B&B ELECTRONICS	328	66 COMPUSERVE	10	104 FORTRON CORPORATION	277	148 IC INFORMATION SYSTEMS	275
30 BASF SYSTEMS	161	* COMPUTER CHRONICLES	317	105 FORTRON CORPORATION		149 IC INFORMATION SYSTEMS	275
31 BASF SYSTEMS	163	* COMPUTER CONTINUUM	328	107 FUNK SOFTWARE		150 IDR MICRODEVICES	340, 341
32 BAY COMPUTER CORP.	270	* COMPUTER CONVERSATIONS	52	108 GALACTICOMM INC.	148	151 KADAK PRODUCTS	298
33 BAY TECHNICAL ASSOC.	61	* COMPUTER FURNITURE CFTSMN	228	111 GIMPEL SOFTWARE	208	152 KAYPRO CORPORATION	79
34 BIBLE RESEARCH SYSTEMS	194	* COMPUTER INNOVATIONS	259	112 GLENCO ENGINEERING	76	153 KAYPRO CORPORATION	79
35 BITTNER ELECTRONICS	326	* COMPUTER INNOVATIONS	261	113 GOLDEN BOW SYSTEMS	310	311 KEA SYSTEMS LTD.	328
36 BITWISE DESIGNS INC.	272	* COMPUTER LIBRARY	213	114 GOLDEN BOW SYSTEMS	326	154 KIMTRON CORP.	19
37 BLAISE COMPUTING INC.	106	* COMPUTER MAIL ORDER	8A-D	115 GOLDEN BOW SYSTEMS	330	155 KIMTRON CORP.	19
38 BLAISE COMPUTING INC.	106	71 COMPUTER WAREHOUSE	188	116 GOLDEN BOW SYSTEMS	332	156 KUN YING ENTERPRISES	290
39 BOCA RESEARCH INC.	118	72 COMPUTER WAREHOUSE	188	117 GRAFPOINT	326	157 KYDOR COMPUTER SYSTEMS	295
316 BONDWELL HOLDING	153	73 CONTRIVER ENTERPRISE	134	118 GTEK INC.	57	158 LABORATORY MICROSYS.	36
42 BORLAND INT'L.	CII, 1	74 CONTROL SYSTEMS	31	119 HAMMERLAB CORPORATION	165	159 LAHEY COMPUTER SYSTEMS	306
43 BORLAND INT'L.	CII, 1	75 CONTROL SYSTEMS	31	120 HAUPPAUGE COMPUTER WORKS	143	160 LATTICE, INC.	201
44 BP MICROSYSTEMS	328	76 CORE INTERNATIONAL	5	121 HAWAIIAN VILLAGE COMP. SFT	310	161 LAWSON LABS INC.	310
45 BRIDGE SOFTWARE LTD.	175	77 CORECO	44				

BYTE ADVERTISING SALES STAFF:

Dennis J. Riley, Advertising Sales Manager, One Phoenix Mill Lane, Peterborough, NH 03458, tel. (603) 924-9281

NEW ENGLAND
 ME, NH, VT, MA, RI,
 ONTARIO, CANADA & EASTERN CANADA
 Paul McPherson Jr. (617) 262-1160
 McGraw-Hill Publications
 575 Boylston Street
 Boston, MA 02116

ATLANTIC
 NY, NYC, CT, NJ (NORTH)
 Leah G. Rabinowitz (212) 512-2096
 McGraw-Hill Publications
 1221 Avenue of the Americas—
 39th Floor
 New York, NY 10020

Dick McGurk (203) 968-7111
 McGraw-Hill Publications
 Building A—3rd Floor
 777 Long Ridge Road
 Stamford, CT 06902

EAST
 PA, KY, OH, NJ (SOUTH),
 MD, VA, W.VA, DE, D.C.
 Daniel Ferro (215) 496-3833
 McGraw-Hill Publications
 Three Parkway
 Philadelphia, PA 19102

SOUTHEAST
 NC, SC, GA, FL, AL, TN
 Maggie M. Dorvee (404) 252-0626
 McGraw-Hill Publications
 4170 Ashford-Dunwoody Road—
 Suite 420
 Atlanta, GA 30319

MIDWEST
 IL, MO, KS, IA, ND, SD, MN, WI, NB, IN, MI
 Bob Denmead (312) 751-3740
 McGraw-Hill Publications
 Blair Building
 645 North Michigan Ave.
 Chicago, IL 60611

SOUTHWEST, ROCKY MOUNTAIN
 UT, CO, WY, OK, TX, AR, MS, LA
 Kevin Harold (214) 458-2400
 McGraw-Hill Publications
 Prestonwood Tower—Suite 907
 51 51 Beltline
 Dallas, TX 75240

SOUTH PACIFIC
 SOUTHERN CA, AZ, NM, LAS VEGAS
 Jack Anderson (714) 557-6292
 McGraw-Hill Publications
 3001 Red Hill Ave.
 Building #1—Suite 222
 Costa Mesa, CA 92626

Karen Niles (213) 480-5243, 487-1160
 McGraw-Hill Publications
 3333 Wilshire Boulevard #407
 Los Angeles, CA 90010

NORTH PACIFIC
 HI, WA, OR, ID, MT, NORTHERN CA,
 NV (except LAS VEGAS), W. CANADA
 Mike Kisseberth (415) 362-4600
 McGraw-Hill Publications
 425 Battery Street
 San Francisco, CA 94111

Bill McAfee (415) 349-4100
 McGraw-Hill Publications
 951 Mariner's Island Blvd.—3rd Floor
 San Mateo, CA 94404

**WEST COAST SURPLUS
 AND RETAIL ACCOUNTS**
 Tom Harvey (805) 964-8577
 3463 State Street—Suite 256
 Santa Barbara, CA 93105

The Buyer's Mart
 Karen Burgess (603) 924-3754
 BYTE Publications
 One Phoenix Mill Lane
 Peterborough, NH 03458

BYTE BITS (2x3)
 Dan Harper (603) 924-6830
 BYTE Publications
 One Phoenix Mill Lane
 Peterborough, NH 03458

**Post Card Mailings
 National**
 Ed Ware (603) 924-9281
 Bradley Browne (603) 924-6166
 BYTE Publications
 One Phoenix Mill Lane
 Peterborough, NH 03458

International Advertising Sales Staff:

Mr. Hans Csokor
 Publimedia
 Reiserstrasse 61
 A-1037 Vienna, Austria
 222 75 76 84

Mrs. Gurit Gepner
 McGraw-Hill Publishing Co.
 PO Box 2156
 Bat Yam, 59121 Israel
 3 866 561 321 39

Mr. Fritz Krusebecker
 McGraw-Hill Publishing Co.
 Liebigstrasse 19
 D-6000 Frankfurt/Main 1
 West Germany
 69 72 01 81

Mrs. Maria Sarmiento
 Pedro Teixeira 8, Off. 320
 Iberia Mart I
 A-1037 Vienna, Austria
 1 45 52 891

Mr. Andrew Karnig
 Andrew Karnig & Associates
 Finnbodavagen
 S-131 31 Nacka, Sweden
 8-44 0005

Mr. Alain Faure
 McGraw-Hill Publishing Co.
 128 Faubourg Saint Honore
 75008 Paris
 France
 (1) 42-89-03-81

Mr. Arthur Scheffer
 McGraw-Hill Publishing Co.
 34 Dover St.
 London W1X 3RA
 England 01 493 1451

Manuela Capuano
 McGraw-Hill Publishing Co.
 Via Flavio Baracchini 1
 20123 Milan, Italy
 02 86 90 617

Seavex Ltd.
 400 Orchard Road, #10-01
 Singapore 0923
 Republic of Singapore
 Tel: 734-9790
 Telex: RS35539 SEAVEX

Seavex Ltd.
 503 Wilson House
 19-27 Wyndham St.
 Central, Hong Kong
 Tel: 5-260149
 Telex: 60904 SEVEX HX

Hiro Morita
 McGraw-Hill Publishing Co.
 Overseas Corp.
 Room 1528
 Kasumigaseki Bldg.
 3-2-5 Kasumigaseki
 Chiyoda-Ku
 Tokyo 100, Japan
 3 581 9811

Mr. Ernest McCrary
 Empresa Internacional de
 Comunicacoes Ltda.
 Rua da Consolacao, 222
 Conjunto 103
 01302 Sao Paulo, S.P., Brasil
 Tel: (11) 259-3811
 Telex: (100) 32122 EMBN

BYTE READER SERVICE



Name _____ IBM
 (Title) _____ (Company) 46SRXS
 Address _____ Telephone _____
 City _____ State _____ Zip _____
 Country _____

Fill out this coupon carefully. PLEASE PRINT. Requests cannot be honored unless the zip code is included. This card is valid for 6 months from cover date.

I am requesting information for: Business Personal Both
 I purchased this copy by Subscription

Newsstand, computer stor

1 23 45 67 89	111 133 155 177 199	221 243 265 287 309	333 355 377 399 421	441 463 485 507 529
2 24 46 68 90	112 134 156 178 200	222 244 266 288 310	334 356 378 400 422	442 464 486 508 530
3 25 47 69 91	113 135 157 179 201	223 245 267 289 311	335 357 379 401 423	443 465 487 509 531
4 26 48 70 92	114 136 158 180 202	224 246 268 290 312	336 358 380 402 424	444 466 488 510 532
5 27 49 71 93	115 137 159 181 203	225 247 269 291 313	337 359 381 403 425	445 467 489 511 533
6 28 50 72 94	116 138 160 182 204	226 248 270 292 314	338 360 382 404 426	446 468 490 512 534
7 29 51 73 95	117 139 161 183 205	227 249 271 293 315	339 361 383 405 427	447 469 491 513 535
8 30 52 74 96	118 140 162 184 206	228 250 272 294 316	340 362 384 406 428	448 470 492 514 536
9 31 53 75 97	119 141 163 185 207	229 251 273 295 317	341 363 385 407 429	449 471 493 515 537
10 32 54 76 98	120 142 164 186 208	230 252 274 296 318	342 364 386 408 430	450 472 494 516 538
11 33 55 77 99	121 143 165 187 209	231 253 275 297 319	343 365 387 409 431	451 473 495 517 539
12 34 56 78 100	122 144 166 188 210	232 254 276 298 330	344 366 388 410 432	452 474 496 518 540
13 35 57 79 101	123 145 167 189 211	233 255 277 299 321	345 367 389 411 433	453 475 497 519 541
14 36 58 80 102	124 146 168 190 212	234 256 278 300 322	346 368 390 412 434	454 476 498 520 542
15 37 59 81 103	125 147 169 191 213	235 257 279 301 323	347 369 391 413 435	455 477 499 521 543
16 38 60 82 104	126 148 170 192 214	236 258 280 302 324	348 370 392 414 436	456 478 500 522 544
17 39 61 83 105	127 149 171 193 215	237 259 281 303 325	349 371 393 415 437	457 479 501 523 545
18 40 62 84 106	128 150 172 194 216	238 260 282 304 326		458 480 502 524 546
19 41 63 85 107	129 151 173 195 217	239 261 283 305 327		459 481 503 525 547
20 42 64 86 108	130 152 174 196 218	240 262 284 306 328		460 482 504 526 548
21 43 65 87 109	131 153 175 197 219	241 263 285 307 329		461 483 505 527 549
22 44 66 88 110	132 154 176 198 220	242 264 286 308 330		462 484 506 528 550

BYTE's BOMB is your direct line to the editor's desk. Each month, the two top-rated authors receive bonuses based on your evaluation. First look at the list of this month's articles and corresponding article numbers (located on the page preceding the Reader Service list), then rate each article you've read as Excellent, Good Fair, or Poor, based on your overall impression of the article, by circling the appropriate number in each column below. Your feedback helps us produce the best possible magazine each month.

Article No.	1	2	3	4	5	6	7	8	9	10	11	12	13	14	15	16	17	18	19	20	21	22	23	24	25
Excellent	1	5	9	13	17	21	25	29	33	37	41	45	49	53	57	61	65	69	73	77	81	85	89	93	97
Good	2	6	10	14	18	22	26	30	34	38	42	46	50	54	58	62	66	70	74	78	82	86	90	94	98
Fair	3	7	11	15	19	23	27	31	35	39	43	47	51	55	59	63	67	71	75	79	83	87	91	95	99
Poor	4	8	12	16	20	24	28	32	36	40	44	48	52	56	60	64	68	72	76	80	84	88	92	96	100

Article No.	26	27	28	29	30	31	32	33	34	35	36	37	38	39	40	41	42	43	44	45	46	47	48	49	50
Excellent	101	105	109	113	117	121	125	129	133	137	141	145	149	153	157	161	165	169	173	177	181	185	189	193	197
Good	102	106	110	114	118	122	126	130	134	138	142	146	150	154	158	162	166	170	174	178	182	186	190	194	198
Fair	103	107	111	115	119	123	127	131	135	139	143	147	151	155	159	163	167	171	175	179	183	187	191	195	199
Poor	104	108	112	116	120	124	128	132	136	140	144	148	152	156	160	164	168	172	176	180	184	188	192	196	200

BYTE READER SERVICE



Name _____ IBM
 (Title) _____ (Company) 46SRXS
 Address _____ Telephone _____
 City _____ State _____ Zip _____
 Country _____

Fill out this coupon carefully. PLEASE PRINT. Requests cannot be honored unless the zip code is included. This card is valid for 6 months from cover date.

I am requesting information for: Business Personal Both
 I purchased this copy by Subscription

Newsstand, computer store, bookstore

1 23 45 67 89	111 133 155 177 199	221 243 265 287 309	331 353 375 397 419	441 463 485 507 529	551 573 595 617 639	661 683 705 727 749	771 793
2 24 46 68 90	112 134 156 178 200	222 244 266 288 310	332 354 376 398 420	442 464 486 508 530	552 574 596 618 640	662 684 706 728 750	772 794
3 25 47 69 91	113 135 157 179 201	223 245 267 289 311	333 355 377 399 421	443 465 487 509 531	553 575 597 619 641	663 685 707 729 751	773 795
4 26 48 70 92	114 136 158 180 202	224 246 268 290 312	334 356 378 400 422	444 466 488 510 532	554 576 598 620 642	664 686 708 730 752	774 796
5 27 49 71 93	115 137 159 181 203	225 247 269 291 313	335 357 379 401 423	445 467 489 511 533	555 577 599 621 643	665 687 709 731 753	775 797
6 28 50 72 94	116 138 160 182 204	226 248 270 292 314	336 358 380 402 424	446 468 490 512 534	556 578 600 622 644	666 688 710 732 754	776 798
7 29 51 73 95	117 139 161 183 205	227 249 271 293 315	337 359 381 403 425	447 469 491 513 535	557 579 601 623 645	667 689 711 733 755	777 799
8 30 52 74 96	118 140 162 184 206	228 250 272 294 316	338 360 382 404 426	448 470 492 514 536	558 580 602 624 646	668 690 712 734 756	778 800
9 31 53 75 97	119 141 163 185 207	229 251 273 295 317	339 361 383 405 427	449 471 493 515 537	559 581 603 625 647	669 691 713 735 757	779 801
10 32 54 76 98	120 142 164 186 208	230 252 274 296 318	340 362 384 406 428	450 472 494 516 538	560 582 604 626 648	670 692 714 736 758	780 802
11 33 55 77 99	121 143 165 187 209	231 253 275 297 319	341 363 385 407 429	451 473 495 517 539	561 583 605 627 649	671 693 715 737 759	781 803
12 34 56 78 100	122 144 166 188 210	232 254 276 298 330	342 364 386 408 430	452 474 496 518 540	562 584 606 628 650	672 694 716 738 760	782 804
13 35 57 79 101	123 145 167 189 211	233 255 277 299 321	343 365 387 409 431	453 475 497 519 541	563 585 607 629 651	673 695 717 739 761	783 805
14 36 58 80 102	124 146 168 190 212	234 256 278 300 322	344 366 388 410 432	454 476 498 520 542	564 586 608 630 652	674 696 718 740 762	784 806
15 37 59 81 103	125 147 169 191 213	235 257 279 301 323	345 367 389 411 433	455 477 499 521 543	565 587 609 631 653	675 697 719 741 763	785 807
16 38 60 82 104	126 148 170 192 214	236 258 280 302 324	346 368 390 412 434	456 478 500 522 544	566 588 610 632 654	676 698 720 742 764	786 808
17 39 61 83 105	127 149 171 193 215	237 259 281 303 325	347 369 391 413 435	457 479 501 523 545	567 589 611 633 655	677 699 721 743 765	787 809
18 40 62 84 106	128 150 172 194 216	238 260 282 304 326	348 370 392 414 436	458 480 502 524 546	568 590 612 634 656	678 700 722 744 766	788 810
19 41 63 85 107	129 151 173 195 217	239 261 283 305 327	349 371 393 415 437	459 481 503 525 547	569 591 613 635 657	679 701 723 745 767	789 811
20 42 64 86 108	130 152 174 196 218	240 262 284 306 328	350 372 394 416 438	460 482 504 526 548	570 592 614 636 658	680 702 724 746 768	790 812
21 43 65 87 109	131 153 175 197 219	241 263 285 307 329	351 373 395 417 439	461 483 505 527 549	571 593 615 637 659	681 703 725 747 769	791 813
22 44 66 88 110	132 154 176 198 220	242 264 286 308 330	352 374 396 418 440	462 484 506 528 550	572 594 616 638 660	682 704 726 748 770	792 814

To get further information on the products advertised in BYTE, fill out the reader service card with your name and address. Then circle the appropriate numbers for the advertisers you select from the list. Add a first-class stamp to the card, then drop it in the mail. Not only do you gain information, but our advertisers are encouraged to use the marketplace provided by BYTE. This helps us bring you a bigger BYTE. The index is provided as an additional service by the publisher, who assumes no liability for errors or omissions.

PLACE
POSTAGE
HERE

BYTE

READER SERVICE
PO BOX 298
DALTON, MA 01227-0298
USA

PLACE
POSTAGE
HERE

BYTE

READER SERVICE
PO BOX 298
DALTON, MA 01227-0298
USA

Make a career move!

Get your own copy of BYTE!

Sharing is nice but not practical when you have to stay on the leading edge of microcomputer technology. From each BYTE issue theme to "MICROBYTES" and "Best of BIX", no other magazine—or group of magazines—can deliver you the vital technical information packaged in one issue of BYTE.

Don't rely on others for BYTE information—waiting on-line can be hazardous to your job. Make a career move! Have BYTE delivered to your door in your name. Use one of the adjacent cards to ensure your position in microcomputer technology.



For direct ordering call toll free weekdays 8:30am–4:30pm E.S.T.: 800-258-5485 (603-924-9281 for New Hampshire residents).

Welcome to BYTE Country!

For your own subscription to complete this card and mail.

BYTE,



46SRSX

Name _____

Address _____

City _____

State _____ Zip _____ Country _____

- Bill me (U.S.A., Canada, Mexico only)
- Check enclosed (All checks must be payable in U.S. funds drawn on a U.S. bank.)

Charge to my MasterCard VISA

Card # _____ Expiration Date _____

Signature _____

Subscription Rates

	USA	Canada /Mexico
ONE YEAR:	<input type="checkbox"/> \$21	<input type="checkbox"/> \$23
TWO YEARS:	<input type="checkbox"/> \$38	<input type="checkbox"/> \$42
THREE YEARS:	<input type="checkbox"/> \$55	<input type="checkbox"/> \$61

- \$69 Europe (1 year–air delivery)
- \$37 Europe and worldwide (1 year–surface mail)

Air mail rates outside Europe available upon request.

Please allow 6–8 weeks for processing. Thank you.



BUSINESS REPLY MAIL

FIRST CLASS MAIL PERMIT NO. 39 MARTINSVILLE, NJ

POSTAGE WILL BE PAID BY ADDRESSEE

BYTE Subscriptions

PO Box 597
Martinsville, NJ 08836-9956
USA

NO POSTAGE
NECESSARY
IF MAILED
IN THE
UNITED STATES

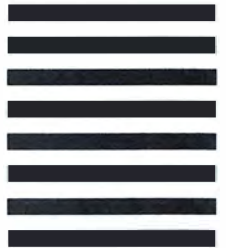

For your own subscription to complete this card and mail.

BYTE,



46SRSX

Name _____

Address _____

City _____

State _____ Zip _____ Country _____

- Bill me (U.S.A., Canada, Mexico only)
- Check enclosed (All checks must be payable in U.S. funds drawn on a U.S. bank.)

Charge to my MasterCard VISA

Card # _____ Expiration Date _____

Signature _____

Subscription Rates

	USA	Canada /Mexico
ONE YEAR:	<input type="checkbox"/> \$21	<input type="checkbox"/> \$23
TWO YEARS:	<input type="checkbox"/> \$38	<input type="checkbox"/> \$42
THREE YEARS:	<input type="checkbox"/> \$55	<input type="checkbox"/> \$61

- \$69 Europe (1 year–air delivery)
- \$37 Europe and worldwide (1 year–surface mail)

Air mail rates outside Europe available upon request.

Please allow 6–8 weeks for processing. Thank you.



NO POSTAGE
NECESSARY
IF MAILED
IN THE
UNITED STATES

BUSINESS REPLY MAIL
FIRST CLASS MAIL PERMIT NO. 39 MARTINSVILLE, NJ

POSTAGE WILL BE PAID BY ADDRESSEE

BYTE Subscriptions
PO Box 597
Martinsville, NJ 08836-9956
USA

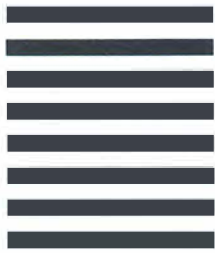

Make a career move!

Get your *own* copy of **BYTE**!

Sharing is nice but not practical when you have to stay on the leading edge of microcomputer technology. From each **BYTE** issue theme to "MICROBYTES" and "Best of BIX", no other magazine—or group of magazines—can deliver you the vital technical information packaged in one issue of **BYTE**.

Don't rely on others for **BYTE** information—waiting on-line can be hazardous to your job. Make a career move! Have **BYTE** delivered to *your* door in *your* name. Use one of the adjacent cards to ensure your position in microcomputer technology.



For direct ordering call toll free weekdays 8:30am–4:30pm E.S.T.: 800-258-5485 (603-924-9281 for New Hampshire residents).

Welcome to BYTE Country!

For your own subscription to **BYTE**, complete this card and mail.

46SRSX

Name _____
Address _____
City _____
State _____ Zip _____ Country _____
 Bill me (U.S.A., Canada, Mexico only)
 Check enclosed (All checks must be payable in U.S. funds drawn on a U.S. bank.)
Charge to my MasterCard VISA
Card # _____ Expiration Date _____
Signature _____

Subscription Rates

	USA	Canada /Mexico
ONE YEAR:	<input type="checkbox"/> \$21	<input type="checkbox"/> \$23
TWO YEARS:	<input type="checkbox"/> \$38	<input type="checkbox"/> \$42
THREE YEARS:	<input type="checkbox"/> \$55	<input type="checkbox"/> \$61

\$69 Europe (1 year—air delivery)
\$37 Europe and worldwide (1 year—surface mail)
Air mail rates outside Europe available upon request.

Please allow 6–8 weeks for processing. Thank you.



NO POSTAGE
NECESSARY
IF MAILED
IN THE
UNITED STATES

BUSINESS REPLY MAIL
FIRST CLASS MAIL PERMIT NO. 39 MARTINSVILLE, NJ

POSTAGE WILL BE PAID BY ADDRESSEE

BYTE Subscriptions
PO Box 597
Martinsville, NJ 08836-9956
USA



ARE YOUR DOCUMENTS

ALIEN?

If capturing text or images from paper documents is alien to you, our **SCANNING CONNECTION** is your best plan of attack.

In less than one minute, an image of your document can be read, stored, retrieved, processed, and output to a laser printer.

A version of Halo DPE® is provided for processing images. Photographs, books, articles, and drawings can be scanned and saved in compressed form.

The saved images can be combined with text in a wide variety of fonts and sizes. The completed document can be reproduced on a laser printer.

Images can be processed with our OCR software to produce text documents. Enhanced matrix matching is used for accurate character recognition. After the system is trained for each new typestyle, the matrix pattern is saved and reused.

A text editor is used to locate and correct scanning errors. The final document is stored in IBM DCA format with tabs, margins, indents, and line ends. The IBM DCA format can be read by most popular word processing programs.

We specialize in conversion systems and can transport your documents or images to most computer, typesetting, or word processing systems.



With our **DISKETTE CONNECTION** system you can read and write most 8", 5¼", and 3½" diskettes using a PC. We support systems from CPT, LANIER, NBI, WANG, XEROX, HONEYWELL, DG, DEC, and IBM.

Our **TAPE CONNECTION** system can read and write most 9-Track magnetic tapes using your PC. We can supply tape drives in several models at 800, 1600, or 6250 BPI. Tapes can be labeled and multivolume.

The price for a Canon IX-12 scanner, controller card, cable, and image software is **\$1195**. The optional OCR software is **\$595**. The price for an IBM 3117 flat bed scanner, controller card, and image software is **\$1395**. The price for an 8" diskette drive, controller card, cable, and utility software is **\$1195**. The optional software for word processing conversion is **\$695**. The price for a 9-Track 1600 BPI tape drive, controller card, cable, and software is **\$3495**.

Since 1982, we have installed thousands of diskette and tape conversion systems at customer locations around the world. We have written hundreds of software programs and designed dozens of hardware products to meet our customer's conversion requirements. We support our products because we developed them. Call us today for help in solving your conversion problems.

Flagstaff Engineering

1120 W. Kaibab • Flagstaff, AZ
86001 • 602-779-3341 • telex 705609

In Europe contact Compusul
12 Rue Rosenwald • 75015 Paris
tel 530.07.37 • telex 205431F